

Durham E-Theses

The electrical charges on mercury drops in sulphuric acid and other solutions

Colin Curry

How to cite:

Curry, Colin (1939) The electrical charges on mercury drops in sulphuric acid and other solutions. Doctoral thesis, Durham University.

Use policy

The full-text may be used and/or reproduced, and given to third parties in any format or medium, without prior permission or charge, for personal research or study, educational, or not-for-profit purposes provided that:

- a full bibliographic reference is made to the original source
- a <https://etheses.durham.ac.uk/id/eprint/8988/> is made to the metadata record in Durham E-Theses
- the full-text is not changed in any way

The full-text must not be sold in any format or medium without the formal permission of the copyright holders.

Please consult the [full Durham E-Theses policy](#) for further details.

" THE ELECTRICAL CHARGES ON MERCURY
DROPS IN SULPHURIC ACID AND
OTHER SOLUTIONS ".

: : : :

November 1939.



A THESIS

BEING AN ACCOUNT OF RESEARCH WORK
carried out under the direction of
Professor J. E. P. Wagstaff M.A., D.Sc.,
at Durham University Science Laboratories
during the period
October 1936 - October 1938,

and submitted by

Colin Curry, of University College,
in Candidature for the Degree of
Doctor of Philosophy.

- CONTENTS -

	Page.
<u>CHAPTER I. - INTRODUCTION and APPARATUS.</u>	1.
Introductory - Design of Apparatus Electrodes - Dropper - Method of Drop Illumination. - Timing Device Method of Experiment - Photograph Measurement.	
<u>CHAPTER II. - INTERPRETATION of PHOTOGRAPHS with TYPICAL SET OF DEDUCTIONS.</u>	28.
Theoretical Curves - Laminar or Turbulent Motion - Comparison of Theoretical and Experimental Curves Deduction of Horizontal Force - Charge/ a^3 from Force-Results in .001 N Sulphuric Acid - Example of Calculation.	
<u>CHAPTER III. - RESULTS using PURE MERCURY.</u>	48.
Variation with Radius - Variation with Acid Strength - Acid saturated with Mercurous Sulphate - Other Electrolytes.	
<u>CHAPTER IV. - CONFIRMATORY RESULTS by GALVANOMETER METHOD.</u>	69.
Galvanometer measurements - Coales- cence difficulties - Improved type of apparatus - Large and Small drops.	
<u>CHAPTER V. - AMALGAMS.</u>	79.
Zinc Amalgams - Effect of Potential Gradient - Charge / a^3 in various Gradients - Reversals - Cadmium and Silver Amalgams - Significance of Results.	
<u>CHAPTER VI. - ADDITIONAL EXPERIMENTS.</u>	108.
Air Bubble Results.	

CHAPTER I.

INTRODUCTION and APPARATUS.

: : :

INTRODUCTION.

The research described here was undertaken as a continuation of some previous work by Professor Wagstaff, In this previous work⁽¹⁾ the values of the charges on mercury drops were obtained from observations on the variation of their velocity of motion along a glass tube, which was slightly inclined to the horizontal, when potential gradients of varying magnitudes were applied in the solution. It was found that with a suitable potential gradient the drops moved in an upward direction, against the force of gravity, and their velocity of motion increased directly with the potential gradient. By extrapolation of the velocity-potential gradient lines the gradient which would just keep a drop in a stationary position, against the influence of gravity, was obtained. By equation of the forces on the drop Wagstaff was able to deduce the charge on the drop. He also made observations on drops of varying size, and found, rather surprisingly, that the charge on these droplets was proportional to their volume, and not to their surface area.

These observations were restricted to mercury drops in 0.1N Sulphuric Acid. The method used, while



novel, was not of great accuracy, especially as the drops did not move centrally in the glass tube, but rested on its lower wall, so that distortion from the spherical shape of the drop was inevitable, and rolling motion along the tube was also unavoidable. The usual $\frac{6\pi\mu av}{r}$ law of force due to viscosity could not hold at all accurately under this combination of circumstances.

Does the numerical factor matter?

It was therefore decided to attempt some further determinations of the charges on mercury drops, using an entirely different experimental arrangement, by which these difficulties would be obviated. The apparatus was only similar in that the motion under a potential gradient was still being observed. In this new method the drops were allowed to fall in an unrestricted fashion within the liquid, and were deflected from their vertical course by the application of a horizontal potential gradient of suitable magnitude. The shape of the resulting curve was studied, and was used as a means of deducing the horizontal force on the drop, from which the drop charge was readily obtained when the potential gradient applied was known.

It was also thought that a method such as this would be of greater versatility than the previous method, and so an additional aim of the research was

that of obtaining the charges in acid of varying concentration, and also in such other electrolytes as were considered to be of interest. Some experiments on amalgam drops were carried out at a later stage of the investigation.

The fact that a mercury surface is charged electrically when in contact with an electrolyte had been observed by several experimenters, ~~even~~ prior to the above mentioned experiments by Wagstaff. As early as 1897 Appleyard⁽²⁾ described some experiments showing changes of coherence of mercury drops when potentials were applied to them, and when electric fields existed in the media surrounding them. Christiansen⁽³⁾ (1903) carried out some experiments of a similar nature, noting the changes in shape of a mercury globule held on a watch glass which was immersed in .01N KNO₃ solution, when currents of increasing magnitudes were made to flow in the solution. He also observed the phenomenon of which this thesis is a detailed account, the deflection from the vertical when a stream of mercury falls between parallel vertical electrodes between which a potential gradient exists. Experiments on Cataphoresis, the majority of which have been performed by McTaggart⁽⁴⁾, and later by Alty⁽⁵⁾ and his collaborators, are of somewhat

similar ^{nature} type and make use of the velocity attained under an electric field as a means of measuring the charges on the small bubbles of gas used in these ^{or} experiments. The charges on these gas bubbles are much smaller than those attained by mercury droplets, so that the velocities attained by the gas bubbles are very small, even when a comparatively large potential gradient is used. A measurement by microscope was used in these experiments, and as the time involved for any appreciable motion was long, the velocity obtained was accurate. Such a method would not be extremely successful with mercury since a very small field would be required to give a reasonably slow motion of the drops, and measurement of velocity by microscope would still be out of the question. Also unless a rotating tube were used, the difficulty of the drop touching the tube would still be to solve. On the other hand, the relatively high velocities attained when the fields used were larger were found easy to measure when the timing device and method of illumination to be described later were employed. Actually the shape of the curve gave the horizontal velocity relative to the vertical velocity under gravity, from which the horizontal force was found as a fraction of the mass. Hence, except in the first few experiments in which it was

necessary to ^{investigate the fluid resistance} (prove the nature of the fluid motion involved), it was not found necessary to deduce the absolute velocity set up. Thus the motion in a vertical direction provided a useful standard to which the horizontal velocity could be related.

The charges on these drops of mercury, in various solutions and under various experimental conditions, are due to ions from the solutions and will be inter-related with electrode-potential phenomena, in fact the drops will attain the natural potential of mercury, and the sign of their charge given by the direction of deflection will be the same as that of the absolute potential, relative to the solution only. A brief review of work done on electrode-potential phenomena relevant to the present problem, will not therefore be out of place here.

The earliest theories of electrode potentials were those of Helmholtz, Warburg and Nernst. Palmaer gives a review of these theories in one of his papers.⁽⁶⁾ Nernst's theory gave the most satisfactory explanation of most observed phenomena at the time, and consisted of an application of the theory of solution pressure. When the osmotic pressure of mercury ions in solution is greater than the solution pressure of mercury the

mercury surface would attain a positive charge, and a negative one in the opposite case. Upon this theory a gradual diminution in the concentration of mercury ions should reduce the potential difference between the mercury and the solution, and it should be possible to obtain null solutions in which mercury has zero potential. Using a cell of the following type - $\text{Hg} | \text{null solution} | \text{KCl and Hg}_2\text{Cl}_2 | \text{Hg}$ - Billitzer⁽⁷⁾ and Palmaer⁽⁸⁾ made attempts to measure the absolute potential of the calomel electrode. Palmaer admits the possibility of condensation of salt on the mercury surface, but thinks the correction for this would be small. Smith and Moss⁽⁹⁾ later showed that the potential differences between different null solutions and mercury are not all the same. They also showed that the polarising E.M.F. for maximum surface tension in the capillary electrometer was in many cases equal to that of the corresponding dropping electrode circuit, a fact predicted much earlier by Nernst.⁽¹⁰⁾ In no case, however, was the potential difference for maximum surface tension necessarily equal to zero, so that it is doubtful whether the method of null solutions does really give absolute values.

More recently the drop weight method of

measuring surface tension has been employed. At first there appeared to be some discrepancy between the results taken by this method, and those obtained by polarisation. Bennewitz and Delijannis⁽¹¹⁾ were the first to attempt this method and obtained maxima of surface tension when the potential on the surface of the mercury was approximately +0.5 volt. Frumkin and Obrutschewka⁽¹²⁾ pointed out their error in assuming the drop potential to be equal to the potential of the lower mercury electrode, and measuring the latter, Rosenberg and Stegeman⁽¹³⁾ having shown that quite a large difference could exist between the two. Bennewitz and Kuchler⁽¹⁴⁾ repeated their previous experiments this time connecting the dropping and stationary electrodes, and in most cases the new curves agreed with those obtained by polarisation. Craxford⁽¹⁵⁾ performed further experiments of similar type, actually measuring the potential on the drops just prior to their breaking away. He found no trace of a maximum at +0.5 volt but obtained curves superposeable upon the polarisation curves. The drop potentials were varied by alteration of the mercurous ion concentration in the solution, but it should be noted that acid solutions were used throughout, it being impossible to make a

neutral solution of mercurous sulphate or nitrate. If the latter is attempted an insoluble basic salt is formed.

Modern theories bear surprising resemblance to the older theories, especially that of Nernst. A summary of these is given in a recent publication by Gurney⁽¹⁶⁾. Metals are now considered to be space lattices of positively charged ions with electrons free to move. Aqueous electrolytes consist of hydrated ions. When a metal is inserted in an electrolyte positive ions deposit on it from the solution and leave it for the solution. The metal acquires a negative or positive charge depending on whether the rate of deposition is less or more than that of leaving the metal for the solution. Assuming that in a particular case ions are deposited on the metal at a slower rate than that at which they leave it for the solution, the metal acquires a negative charge and the solution a positive one. This process continues until the double layer produced is of sufficient strength to raise the energy level of the hydrated ions and lower that of the positive ions in the metal until these become equal. The double layer is, in this case, an accumulation of electrons inside

the metal near its surface, and an accumulation of positive ions in the solution around. If originally the deposition of positive ions is greater than the rate at which they leave, the double layer is reversed.

If Y represents the difference in energy level between a free ion and one bound to the metal surface, and W the difference in energy level between a free ion and a hydrated one, then the difference in energy level between a hydrated ion and one in the metal is $W - Y$. The electrode potential will depend on this quantity. Y depends on the concentration of the ions in solution. Gurney gives the difference in potential between a metal α and ^a solution s as

$$V_{\alpha} - V_s = \frac{Y - W}{z\varepsilon} + \frac{kt}{z\varepsilon} \log_e(fc)$$

In the previous equation z is the valency of the ion which crosses the boundary, k is the gas constant per molecule, c the concentration, and f the activity coefficient of the ion. W_0 is the energy level in infinitely dilute solution. } Does not appear in equation

This equation is of the same form as the usual eqn.:-

$$V - V_s = V_0 + \frac{RT}{nF} \log_e(fc)$$

and throws some light on the meaning of V_0 . 'Solution

'Pressure' can now be replaced by the difference in energy levels between the positive ions in the metal and in the solution.

Only in high concentrations is the effect of concentration on the electrode potential at all appreciable. McAulay and Spooner⁽¹⁷⁾ have shown that an electrode potential is constant in all strengths of solution below a certain fixed value, which varies with the nature of the solution, and conclude that electrode potential has its origin fundamentally in an action between water and the metal only. They suggested that polar water molecules bombard the metal as a result of their heat motion, and as a result a stream of ions is abstracted to a certain mean distance. Equilibrium is reached when the removal of ions in this way is balanced by their migration back under the field produced by their abstraction. Heyrovsky⁽¹⁸⁾ also suggested that the fundamental reaction whereby any electrode becomes charged is



where Me represents the metal, and concluded that all metals should therefore be negative with respect to the solution. In support of this he cited some of the above evidence showing that absolute zero from capillary phenomena is probably illusory. He showed

that the two methods are in reality the same, and suggested a better position for absolute zero to be between Silver and Chlorine, making all metals negative in agreement with his theory. Both McAulay and Spooner and also Heyrovsky seem to have overlooked the fact that a drop of mercury measured relative to the solution alone, by an actual deflection of the drop in a potential gradient, is found to be positive.

All the arguments advanced would apply equally well to a theory that all metals are positive, and while it is agreed that electrode potential must be caused fundamentally by a reaction between the metal and water alone, a theory by which all metals (at least between silver and zinc) attain a positive charge by adsorption of hydrogen or other positive ions at their surfaces might possibly be in better agreement with the facts. It is believed that it is towards such a theory that the following experiments point.

DESCRIPTION OF APPARATUS.(1) The Glass Vessel.

The design of glass vessel described here was found to be the most suitable after several preliminary trial experiments, and the difficulties which were obviated by the use of this particular design will be explained in turn during the description. The same vessel was used throughout all the experiments, and it is shown in several of the diagrams (figs. 1, 3 & 5). It was made from a short length of glass tubing of wide bore (approximately 3" diameter), held in such a way that its axis was horizontal. Above and below were sealed in vertical tubes each of 1" diameter (A & B in fig. 1.), for the introduction and removal of the mercury drops respectively. While falling across the space between these two tubes, the drops were subjected to the influence of the electric field and observations upon their behaviour were made. The 3" diameter tube was also fitted with narrower horizontal tubes (C), which would accommodate the electrodes to be used in the production of the potential gradient.

The tube A was of length sufficient to ensure

that each of the following necessary conditions was observed:-

- (a) Drops forming within the liquid could fall a distance large enough for them to acquire their terminal velocity in the liquid before reaching the space between the electrodes.
- (b) Drops formed outside the liquid could have a sufficient period within the liquid before reaching the space in which the field was applied, so that the full drop charge would be attained.

The tube B narrowed at its lower end, and could be connected at will to a U-tube (D. in fig. 3,), which contained sufficient mercury to balance the vessel when full of liquid. Each drop of mercury, having traversed the field, coalesced with the lower mercury; the far limb of the U-tube was provided with a jet (see fig. 3.), and as drops entered from the vessel, an equivalent amount of mercury was displaced from the jet, and could be collected as desired. The mercury-acid surface, which would be charged, was at least 6" below the lowest part of the electrodes, a distance great enough to ensure that it could have no noticeable effect upon the paths of ensuing drops, by repulsion of them; trial experiments having shown that

a pool of mercury, if allowed to collect immediately below the electrodes, could have quite an appreciable effect upon the paths of following drops.

(2) The Electrodes.

Each electrode consisted of a piece of stiff platinum of size 2" x 1", having the longest dimension in the vertical direction. Electrical connections to the outside of the vessel were made in the following manner. To the exact centre back of each electrode was soldered a very small brass nut, and two stiff copper rods were tapped to fit the nuts. One of these rods was screwed into each nut until it made connection with the electrode back. Each rod and nut was enclosed in a glass tube of diameter just large enough to fit over the nut, and the glass tubes were sealed to the backs of the electrodes by means of vacuum wax. Each rod and its glass covering extended outwards through its corresponding side tube C on the vessel, and a stout rubber tube was bound down to fit tightly on both the side tube C and the narrower glass tube containing the electrode. Fig. 2 shows an electrode assembled. The advantages of such a joint were that it was watertight, and that it could easily be dis-

connected and the electrode would then slide in or out to any desired position. Also the copper connections and the brass nuts were completely protected from contact with the liquid within the vessel, so that no risk of contamination of the latter was entailed. Since there was a Copper-Platinum junction at each side, the potential between the platinum plates was the same as that applied across the copper terminals.

After these electrodes had been fitted within the vessel the assembly was completed by sealing plane glass ends over the open ends of the 3" tube, by means of vacuum wax. These glass ends were necessarily plane. In order that photographs of the drop movements within the field space might be obtained without distortion. An acid-resisting vacuum wax was used for sealing purposes.

The vessel could now be filled with acid or any other liquid as desired. Arrangements were made whereby the liquid in use could be continually replaced by a fresh supply, as it was found in some cases that results were considerably altered by using acid which had been in contact with the mercury surface for some time. Accordingly, a steady influx of fresh acid, through a narrow tube entering tube A, was

balanced by a slow draining away through a capillary tube (connected also to tube B, fig.3.). By raising or lowering the end of this capillary tube, the rate at which the acid flowed away was adjusted until it just balanced the rate of renewal, an adjustment comparatively easy to make under the slow rates involved, the acid level in the vessel finally remaining constant.

(3) The Dropper.

Pure mercury was supplied from a reservoir connected to a dropper, which consisted of a very fine glass capillary. This was made by drawing out some glass tubing already of capillary form, the drawn out portion being bent at right angles and the connection to the reservoir made in a horizontal direction, so that the head of mercury was as small as possible, the drops then forming slowly and evenly. Several droppers were used, according to the required size of drop. In some cases drops were formed within the liquid, and in others just above its surface - larger drops being obtained more easily by the latter method. The precaution mentioned previously, i.e. the ensuring that the full charge had grown before the drop entered the field, must be observed strictly in these cases since,

when formed outside, the drop had no charge on leaving the dropper. The results however did show that the curves were those expected to be traced out by a drop of constant charge, and some experiments in which drops entered the acid and the potential simultaneously (the acid was level with the tops of the electrodes) showed that a full charge could be obtained within the first inch of fall, so that the precaution taken by having tube A of length 4" and full of acid was quite sufficient for the purpose. A disadvantage of the method using drops formed outside was that drop oscillations were set up as the drop passed the surface, so that the curves were not so continuous and smooth. But in falling down tube A these oscillations were damped to some extent, and in most cases a smooth curve was still obtainable. In the experiments with amalgams which were performed later, a new dropper was used for each experiment as it was not found possible to remove all traces of the previous amalgam from the used dropper in readiness for a new experiment.

(4) Method of Drop Illumination.

The drops were illuminated by means of a very highly concentrated beam of light. This beam was

reflected by means of a mirror (at 45° to the vertical) so that it fell in a vertical direction. ^{through the slot} By using suitable lenses the beam, originally about 3" wide, was concentrated to a diameter rather less than that of the vertical tubes A and B, and when the mirror was suitably adjusted the space between the electrodes was evenly illuminated without any part of the apparatus being in the direct light (see Fig. 5). When a drop of mercury fell between the electrodes a streak of light reflected from its surface indicated its path. These streaks were found to be sufficiently bright to be photographed completely. In order to obtain sufficient density in the photographs it was necessary to use an aperture of $f/3.5$ in addition to high speed panchromatic (sensitive to half-watt light) negative material. A double extension camera was employed so that about actual size photographs were obtained. By keeping open the shutter while the drop photographed was traversing the field, the complete path between the electrodes was registered as a continuous line in the final negative. Apart from the use of a cinematograph camera, the above was the only practicable method of recording the drop paths and the photographs were certainly much more easy to interpret than a length of

cine film, showing the drop in various positions, would have been. Great care had to be exercised to see that as far as possible nothing in the camera field of view was illuminated, apart from the drop; any such object, directly illuminated, would be exposed for the full time of passage of the drop, and hence would be very dense when developed. Backed plates were employed in order to minimize this difficulty.

(5) The Timing of the Drops.

To obtain the variation of drop position with time, the introduction of the timing device described here was necessary. The method found to be most suitable was that of intermittent illumination of the drop at a constant known frequency. The direct drive of an A.C. synchronous motor was used to rotate a disc with vanes, in such a way that the vanes interrupted the light beam. The vanes were four in number, and the spaces between them were each the same shape and area as the vanes. The motor spindle revolved at a constant rate of 50 revs/sec. - so that the drop was alternately illuminated and in darkness for periods of $1/400$ th sec. each. The path of the drop, indicated by a streak under continuous illumination, was now

indicated by a succession of bright dashes, spaced apart by distances equal to the lengths of the dashes themselves. Thus the time taken by the drop to reach any position from the instant of entering the field could be determined easily from the number of dashes and spaces between the two positions. Four vanes was found to be the most suitable number to give short enough intervals of illumination. An average sized drop took about $1/10$ th sec. (indicated by the dashes) to traverse the region of the electric field between the plates.

The fact that drops had attained their terminal velocities could be verified in all cases from the equality, or otherwise, of all the dashes (measured in a vertical direction), and this terminal velocity could be deduced, if required, from a simple measurement of a known number of dashes. The timing device is shown in Fig. 4. In addition to the accuracy with which the drop was timed by this method, another advantage was evident - the fact that while the bright portions of the path were exposed as in the continuous illumination, all other parts of the apparatus which were unavoidably partially illuminated received only half the exposure

which they received under continuous illumination experiments, and were correspondingly less assertive in the developed negative.

EXPERIMENTAL METHOD.

The following is a description of the method of experiment to which strict adherence was made throughout the whole series of observations.

The vessel was filled to a known level with the liquid desired for the particular experiment undertaken, and a dropper furnishing drops of the required size was inserted into the top tube A, in such a position that the drops fell exactly centrally between the electrodes. The level of mercury in the reservoir was adjusted until the drops were formed at quite a slow rate - in most cases a time of more than 1 second separated successive drops. The illuminating beam was next adjusted to fall vertically in the space between the electrodes, this being done by alteration of the angle of the plane mirror above the vessel. The camera was fixed in position at the correct distance and was focussed carefully until the movements of the drop were visible on the focussing screen, the image of the streak being a sharply defined line. The apparatus was then drained and fresh solution was introduced, the tap from the reservoir of fresh acid was opened and the height of the end of the capillary tube, through which

the used liquid drained away, was adjusted until the liquid level remained constant, i.e. balance between the influx of liquid and the leakage was attained. The synchronous motor driving the timing device was now started, and after making certain that the vanes were intercepting the light beam in the correct manner, all was in readiness for the actual recording of the drop path. The voltage which was required was applied directly by tapping off from a storage battery. The key closing the circuit was depressed, and the shutter of the camera was opened just prior to the falling of the drop to be observed. As soon as the drop had traversed the field of view the shutter was released, so that unnecessary extra exposure of other parts of the apparatus, which were unavoidably partly in the light, was eliminated. After some practice it was found possible to have the shutter open only very little longer than the actual time taken by the drop in crossing the field.

As in most cases the drop was deflected in a horizontal direction, towards one or other of the electrodes and as the magnitudes of these drop deflections were to be measured, it was necessary also to have some zero line from which to measure them. For this there were two alternatives, the first to take a photo-

graph of a drop falling vertically on the same plate, and the second to reverse the potential gradient and obtain two curves, symmetrical about the vertical, on the same plate. The second alternative was employed in almost all cases, it having been found possible to obtain the photograph of the reversed deflection very shortly after the first, by the inclusion of a reversing key across the electrodes. The applied voltage was measured on an accurate voltmeter connected directly across the electrodes. This was necessary since a reading at the battery would have given the fall in potential across both battery and the electrodes, and especially in the more concentrated solutions the resistance of the latter becomes low enough to be comparable with that of the battery. Also in some of the experiments a rheostat was included in the circuit, the value of its resistance being varied as a means of altering the potential drop across the cell. In such a case the method of connecting the voltmeter directly across the cell was the only practicable one. The electrical connections are shown in Fig. 6.

In order to eliminate all unnecessary details in the photographs, a mask was placed over the plane end through which the photographs were taken. This mask

was of such size as to allow only the electrodes and the space between them to be visible. All other parts of the vessel were shielded from the light, and the photographs were taken in darkness except for the one illuminating beam. The distance between the plates was measured by travelling microscope after each experiment.

Drop sizes were obtained from the weighing of a known number of drops. When drops were formed within the solution this was done by collecting the mercury displaced over from a U-tube below the apparatus. By weighing the amount displaced during the fall of a known number of drops, the weight of one drop, and hence its radius, was obtained. This method was found to be accurate when a large number of drops were counted. Usually a number of drops were counted prior to the taking of a photograph, and a second lot done immediately following it. When a series of photographs was being taken, a number of drops were counted in the middle of the series as well as before and after. In order to minimize the change in the drop size during the time required for an experiment, a reservoir was used in which the surface area of the mercury was large. The removal of a number of small drops resulted in a very

small diminution of the height of this surface, and therefore in the pressure controlling the drop formation. Trial experiments showed that the difference in size of drops was negligible for even the longest series of experiments undertaken.

The exposed plates were developed, as soon as possible after exposure, in a developer giving strong contrast, and after fixing were washed thoroughly and dried, before any attempt at measurement was made. Photographs which were doubtful in character were always repeated. At times, observations were repeated in order to estimate the limits of accuracy to which a result could be obtained. The variation in the measurements on plates exposed under identical conditions was usually inappreciable.

As the measuring up of numbers of plates by travelling microscope was extremely tedious, the following method which proved to be equally as accurate, was preferred. The plates were in turn inserted in the slide carriage of a lantern, and were projected and focussed upon a large fixed screen. Measurements of the deflections were now made by means of set squares and rulers. The exact magnification from the actual size was obtained from the enlarged

Uniform magnification?

distance between the electrodes as compared with the actual distance between them. As the magnification was usually about 25 to 30 times, measurements to $1/4$ cm by this method corresponded to less than .01 cm on the photographs. Actually measurements to within 2 mms were easily obtainable.

Figures 10 - 15 are a selection of actual photographs, showing deflections of various magnitudes. The effect of the timing device will readily be seen by comparison of the broken and the unbroken traces.

CHAPTER II.

INTERPRETATION of PHOTOGRAPHS

with

ONE TYPICAL SET of

DEDUCTIONS.

DEDUCTION OF CHARGES FROM
PHOTOGRAPH MEASUREMENTS.

In order to deduce the curve expected to be taken up by the drops from theory, it was first necessary to know the type of fluid motion involved. For some time unsuccessful attempts were made to correlate the experimental curves with those obtained theoretically assuming laminar flow of the liquid around the drop. The equation of motion in the horizontal direction under a constant deflecting force F would be

$$m \frac{dv}{dt} = F - 6\pi\mu a v$$

where m = mass of drop

a = radius of drop

μ = viscosity of the liquid

v = horizontal velocity at time t

Integrating with respect to t , putting $v = 0$ when $t = 0$, i.e. no sideways velocity on entering the field of force,

$$v = \frac{F}{6\pi\mu a} \left[1 - \exp\left(-\frac{6\pi\mu a}{m} t\right) \right]$$

Now $v = \frac{dy}{dt}$, where y is the horizontal displacement, so that on integration again, now putting $y = 0$ when $t = 0$

$$y = \frac{F}{6\pi\mu a} \left[t - \frac{m}{6\pi\mu a} \left\{ 1 - \exp\left(-\frac{6\pi\mu a}{m} t\right) \right\} \right]$$

The x variation with t is given by :-

$$x = v_x t$$

where v_x is the vertical terminal velocity.

The experimental curves did not follow a form similar to that given by the two equations above. Also, if the drop was allowed to fall from a point of zero velocity in the x direction also, i.e. if it was formed at a point in the acid within the field, the x variation with t would be similar to the y variation, except that F would be replaced by the vertical force mg.

$$x = \frac{mg}{6\pi\mu a} \left[t - \frac{m}{6\pi\mu a} \left\{ 1 - \exp\left(-\frac{6\pi\mu a}{m} t\right) \right\} \right]$$

and under these circumstances the curve would be expected to degenerate into a straight line :-

$$y/x = F/mg$$

This experiment was attempted, the only change being that a dropper of such length that drops could form within the field itself, was employed. Fig. 18. was the photograph obtained, being different from the rest in the fact that the drop accelerates vertically as well as horizontally, shown by the increase in vertical length of the dashes until the maximum is reached. The curve was still pronounced although a straight line was expected, and it was this experiment which made it necessary to check

up on the actual terminal velocities, to determine whether the motion was really laminar...If the motion were not laminar this would make a vital difference to the shape of the curve, so that it was necessary to prove beyond doubt the actual character of the fluid motion involved. The terminal velocities were obtained from measurements of numbers of dashes upon the photographs, for several sizes of drop. These are given in Table I, on the following page. A calculation of μ using the equation:-

$$\frac{4}{3} \pi (\rho - \lambda) a^3 g = 6 \pi \mu a v_x$$

gives a value much different from the accepted value. For example, using the result stated for photograph 48 a value of about .25 - while the probably correct value is about .01

The table gives more information than the fact that the motion is not laminar. It gives the variation of terminal velocity with radius. Supposing now that the resistance to the motion is proportional to some power of the velocity. If the motion was extremely turbulent the effect of viscosity would be comparatively unimportant, and the density would become of chief importance. The theory of dimensions then gives the resistance to motion to be $\propto \lambda a^2 v^2$, so that at the terminal velocity

TABLE I.

Photograph Number	Drop Radius (cms)	Magnification. M	Length 1/25th sec.	$V_x = L/M \times 25$	v_x^2
48	.0812	52/1.915	75.5	69.6	4850
49	.0812	52/1.915	75.8	69.8	4870
50	.0812	52/1.915	75.4	68.8	4740
51	.0703	53.5/1.925	72.6	65.1	4240
52	.0703	53.5/1.925	72.1	64.9	4220
53	.0703	53.5/1.925	72.6	65.1	4240
54	.0946	54.5/1.925	84.7	73.5	5410
55	.0946	54.5/1.925	82.1	72.6	5280
56	.0946	54.5/1.925	86.1	74.0	5490
77	.0620	55/1.925	68.6	60.2	3630
78	.0620	55/1.925	71.1	62.3	3880
79	.0620	55/1.925	70.4	61.7	3800
80	.0620	55/1.925	71.4	62.6	3910
81	.0620	55/1.925	68.2	59.8	3580
132	.0570	54/2.00	64.2	59.4	3520
134	.0570	54/2.00	65.5	60.5	3650
135	.0570	54/2.00	65.4	60.4	3640

$$mg = \frac{4}{3} \pi (\rho - \lambda) a^3 g \propto \lambda a^2 v_x^2$$

i.e. $\underline{v_x^2 \propto a}$

whereas, in the case of laminar motion, at the terminal velocity

$$mg = \frac{4}{3} \pi (\rho - \lambda) a^3 g \propto 6\pi \mu a v_x$$

i.e. $\underline{v_x \propto a^2}$

Alternatively to either of the above possibilities, the rate of fall may be such that the motion was of some intermediate stage, but this could be decided directly from the relation between v_x and a . Fig. 8. shows the graph relating v_x^2 and a , which is a good straight line, and which amply proves that at the particular order of speed involved the law of resistance proportional to the square of the velocity holds. The fact that the drop is liquid and therefore subject to small oscillations about a mean spherical position, would seem to be conducive to a turbulent state of the liquid around the drop. It is difficult to imagine a smooth flow past the drop even when it is oscillating only very slightly. The straight line obtained also gave the constant of proportionality between force and (velocity)².

Also velocity is important

If the resistance at velocity v is $k a^2 v^2$,

then at the terminal velocity $\frac{4}{3} \pi (\rho - \lambda) a^3 g = k a^2 v_x^2$

If θ is the slope of the graph, $\tan \theta = v_x^2 / a = \frac{4}{3} \pi (\rho - \lambda) g / k$

Thus the graph gives k directly, the value obtained being

$$k = 1.007g \times 10^{-3}$$

The true equation for the horizontal motion under the force F now becomes -

$$m \frac{dv}{dt} = F - Kv^2$$

where K is substituted for ka^2 ,

Integrating, putting $v = 0$ when $t = 0$,

$$\frac{dy}{dt} = v = \sqrt{\frac{F}{K}} \cdot \tanh\left(\frac{\sqrt{FK}}{m} t\right)$$

This represents the horizontal velocity at time t after entering into the influence of the force. Integrating again and putting $y = 0$ when $t = 0$, the displacement y in time t is obtained,

$$y = \frac{m}{K} \cdot \log_e \left(\cosh \frac{\sqrt{KF}}{m} t \right)$$

Also, $x = v_x t$, x being the vertical co-ordinate. Hence the form of the curve, obtained by elimination of t , is :-

$$y = \frac{m}{K} \cdot \log_e \left(\cosh \frac{\sqrt{KF}}{m v_x} x \right)$$

This curve assumes the asymptotic form -

$$y = \sqrt{\frac{F}{K}} \cdot \frac{x}{v_x} - \frac{m}{K} \cdot \log_e 2 \dots \dots \text{(see Fig. 9)}$$

Thus the drop eventually follows a straight line when the terminal velocity is reached in the y direction as

well as in the x direction. The slope of the line y/x is equal to $\sqrt{\frac{F}{K}} \cdot \frac{1}{v_x}$, which becomes the expected value $\sqrt{\frac{F}{mg}}$ when substitution for v_x is made from the relationship

$$Kv_x^2 = mg.$$

The form of the curve is perhaps best written as two equations relating both y and x to a parameter z, as follows -

$$\begin{aligned} y &= \frac{m}{K} \cdot \log_e (\cosh z) \\ x &= \frac{m v_x}{\sqrt{KF}} \cdot z \quad \text{since} \quad z = \frac{\sqrt{KF}}{m v_x} \cdot x \end{aligned}$$

$$\text{Since } v_x = \sqrt{\frac{mg}{K}}$$

$$z \text{ may be written equal to } \frac{K \sqrt{F}}{m \sqrt{mg}} \cdot x$$

$$\text{i.e. } \frac{z}{x} = \frac{K}{m} \cdot \sqrt{\frac{F}{mg}}$$

$$\text{or, } \frac{F}{mg} = \left(\frac{m}{K} \cdot \frac{z}{x} \right)^2 \dots \dots \dots \text{Eqn (i).}$$

It was next necessary to make certain that the curves obtained experimentally agreed with this theoretically predicted form. This was done in the following manner. For a drop of radius a the value of $\frac{m}{K}$ could be found by calculation thus -

$$\frac{m}{K} = \frac{\frac{4}{3}\pi(\rho-\lambda)a^3}{ka^2} = \frac{4\pi(\rho-\lambda)a}{3k}$$

For any photograph let the magnification be denoted by M . By plotting the magnified measurements the graph of M_y against M_x was obtained. Now certain specific values of z were taken, and the value of $\log_e \cosh z$ computed for each. Values increasing regularly from 0.1 to 0.7 in stages of 0.05 were used, and $M \frac{m}{K} \log_e \cosh z$ was obtained for each. The values of M_x corresponding on the curve to these values of M_y should also increase in equal stages. This follows since x is proportional to z . In the majority of cases the values of M_x so obtained increased uniformly. This proves that the experimental curve follows the theoretically deduced one. The increase of M_x (denoted by L), corresponding to a z increase of .05, was found for every photograph, and used in the determination of the horizontal force in each case in the following manner -

$$\frac{z}{M_x} = \frac{.05}{L} ; \quad \text{i.e.} \quad \frac{z}{x} = \frac{.05M}{L}$$

From this value of $\frac{z}{x}$, $\frac{F}{mg}$ was determined using equation (1)

$$\frac{F}{mg} = \left(\frac{m}{K} \cdot \frac{z}{x} \right)^2$$

$$\text{or} \quad \underline{\underline{F}} = \underline{\underline{\left[\frac{m}{K} \cdot \frac{.05M}{L} \right]^2 \cdot mg}}$$

As the method can be followed more readily from an actual numerical calculation, one complete set of results - i.e. those with mercury in 0.001 N sulphuric acid, the drop size and potential gradient being varied - is included at the end of this chapter. The values of F were obtained from all other photographs in a similar fashion, so that to include the photographic details and the calculations from these would be useless repetition. The final results alone are stated.

Having obtained the value of the horizontal force on the drop (F) the value of the charge must be deduced therefrom. The force may be expected to increase with drop charge, and also with potential gradient. For a point charge or volume distribution of charge the force would be the product of charge and field, but the charges considered here are probably distributed upon the surface of the drops. Assuming that the drop collects positive charge on its surface, it will also attract an atmosphere of negative ions into its immediate vicinity in the solution, so that a double layer is formed. Assuming a potential V_0 (equal to the natural potential of mercury with respect to the solution) across this double layer, of thickness d , Wagstaff⁽¹⁾ showed by integration of the forces on an

elemental zone of the drop surface that the force on the drop under these circumstances would be given by:-

$$F = \frac{1}{3} \cdot \frac{a^2 V_0}{d} \cdot \frac{dV}{dy} \quad \frac{dV}{dy} \text{ being the potential gradient}$$

Now $\frac{a^2}{d}$ is the capacity of a spherical condenser of inside radius a , and of thickness d . The drop and its atmosphere amounts to a condenser of this type, the potential across which is V . That is, $\frac{a^2 V_0}{d}$ is the charge on either plate, which is the positive charge on the drop (E).

$$F = \frac{1}{3} E \cdot \frac{dV}{dy}$$

This equation was used in the charge deduction, but the fact was always borne in mind that if for any reason it should be suspected that the charges were not totally upon the surface, but existed as a volume distribution, then $F = E \cdot \frac{dV}{dy}$ would hold and the charges deduced from the first equation would be three times their true values.

Back-E.M.F. ^{Corrections.} Difficulties.

A difficulty which arose in experiments using the more concentrated solutions was that the actual potential gradient existing within the solution was not necessarily equal to the voltage applied divided by the

distance between the plates. In sulphuric acid a back-E.M.F. of the order of 1 volt is set up, and also the potential gradient across any bubbles of gas on the electrodes would be greater than that across the solution. When it is considered that with plates about 2 cm apart in .1N acid 1/4 volt per cm is sufficient potential gradient in the solution to deflect drops nearly to the plates, while about 2 volts must be applied to overcome this back - E.M.F. ^{together with} and the effect due to the bubbles, to obtain the 1/4 volt per cm in the solution, - it becomes obvious that if the potential gradient is simply taken as 2 volts/2cms instead of 1/4 volt per cm as it should be, in this extreme case the charge deduced will be incorrect by a factor of 4 times. In the weaker solutions the charges were less, and the potentials required to give reasonable deflections became greater compared with the back - E.M.F., but even so it was still desirable to allow for the back - E.M.F. if possible.

The difficulty was surmounted by actual measurement of the back-E.M.F., and also by taking a series of photographs with various voltages applied. For each one of these a current measurement was taken, and the current increased uniformly with voltage. By plotting

*In this
or
calculations?*

the current - voltage straight line and extrapolating it to cut the voltage axis, the back-E.M.F., i.e. the E.M.F. at which no current flowed, was obtained. Since no current flowed there could be no force on the drop at this voltage, so that when the force on the drop was plotted against the applied voltage, the point - back E.M.F. voltage, zero force - was used in addition to those points obtained from the photographs.

This latter graph was a straight line, showing that the force was proportional to the potential gradient. Usually $\frac{F}{mg}$ was plotted against voltage instead of F alone. The slope of this line gave a value to E , as follows -

$$F = \frac{1}{3} E \cdot \frac{dV}{dy} \quad \text{----- } V \text{ in es.u.}$$

$$\text{or } F = \frac{1}{3} E \cdot \frac{dV}{dy} \times \frac{1}{300} \quad \text{----- } V \text{ in volts.}$$

If F_1 is the force for a gradient of $\left(\frac{dV}{dy}\right)_1$
 & F_2 " " " " " " " $\left(\frac{dV}{dy}\right)_2$

Then

$$F_1 - F_2 = \frac{E}{900} \left[\left(\frac{dV}{dy}\right)_1 - \left(\frac{dV}{dy}\right)_2 \right]$$

$$= \frac{E}{900} \left[\frac{V_1 - A}{D} - \frac{V_2 - A}{D} \right]$$

where A = Back E.M.F.
 D = Plate distance

$$\text{Slope of graph, } \tan \psi = \frac{(F_1 - F_2)}{(V_1 - V_2) mg} = \frac{E}{900 \cdot D \cdot mg}$$

$$\underline{\underline{E = 900 \cdot D \cdot mg \cdot \tan \psi}}$$

TABLE II.

Voltage = 10.4 volts

Results in .001N H₂SO₄.

Photographs 64-69, a = .0629 cm.

Photograph 64. V = 10.4v, M = 53.5/1.925, l₁₆ = 68.0 cm.

My	.95	1.75	2.95	4.75	7.00	9.70	12.95	16.6	20.6
t	0	4	8	12	16	20	24	28	32

Photograph 65. V = 8.35v, M = 53.5/1.925, l₁₆ = 69.7 cm.

My	.55	1.10	1.90	3.25	5.05	7.35	9.70	12.5	15.6
t	0	4	8	12	16	20	24	28	32

Photograph 66. V = 6.25v, M = 53.5/1.925, l₁₆ = 71.0 cm.

My	.45	.75	1.45	2.5	3.95	5.70	7.80	10.2	12.65
t	0	4	8	12	16	20	24	28	32

Photograph 67. V = 4.20v, M = 53.5/1.925, l₁₆ = 71.5 cm.

My	.10	.50	1.20	2.00	3.05	4.55	6.00	7.55	
t	0	4	8	12	16	20	24	28	32

Photograph 68. V = 2.10v, M = 53.5/1.925, l₁₆ = 72.0 cm.

My	0	.25	.45	.80	1.25	1.75	2.20	2.70	3.15
t	0	4	8	12	16	20	24	28	32

Photograph 69. V = 7.20v, M = 53.5/1.925, l₁₆ = 70.0 cm.

My	.35	.90	1.70	3.00	4.50	6.35	8.50	10.95	13.65
t	0	4	8	12	16	20	24	28	32

TABLE II. (continued)

Photographs 70-75, $a = .0922\text{cm}$.

Photograph 70. $V = 10.7\text{v}$, $M = 55/1.925$, $l_{16} = 82.5\text{ cms}$.

My	.40	.65	1.95	3.70	6.05	8.80	11.95	15.45	-
t	0	4	8	12	16	20	24	28	32

Photograph 71. $V = 8.5\text{v}$, $M = 54.5/1.925$, $l_{16} = 81.4\text{ cms}$.

My	0	1.00	2.25	3.55	5.50	7.70	10.20	12.30	-
t	0	4	8	12	16	20	24	28	32

Photograph 72. $V = 6.30\text{v}$, $M = 54.5/1.925$, $l_{16} = 81.0\text{ cms}$.

My	.45	1.00	1.80	3.05	4.75	6.65	8.60	10.20	-
t	0	4	8	12	16	20	24	28	32

Photograph 73. $V = 4.20\text{v}$, $M = 54.5/1.925$, $l_{16} = 84.5\text{ cms}$.

My	0	0	0	.10	.25	.60	1.30	2.35	3.4
t	0	4	8	12	16	20	24	28	32

Photograph 74. $V = 4.20\text{v}$, $M = 54.5/1.925$, $l_{16} = 83.7\text{ cms}$.

My	0	.10	.15	.50	1.05	2.00	3.25	4.60	-
t	0	4	8	12	16	20	24	28	32

Photograph 75. $V = 2.10\text{v}$, $M = 55/1.925$, $l_{16} = 86.0\text{ cms}$.

My	0	.50	.90	1.45	1.75	2.20	2.50	3.00	-
t	0	4	8	12	16	20	24	28	32

Each of the photographs in Table II was re-plotted on squared paper (see the following pages). Table III gives the values of $M \frac{m}{K} \log_e \cosh.z$, plus the appropriate zeros, for values of z ranging between 0 and .7, for each of the photographs 64-69. Taking these values for M_y , the values of t corresponding to these on the photographs were found and hence F was deduced, for each photograph. Table IV gives values of $M \frac{m}{K} \log_e \cosh.z$ for the second set of photographs, and the values of F for these were deduced in a similar fashion, and are shown in the pages immediately following.

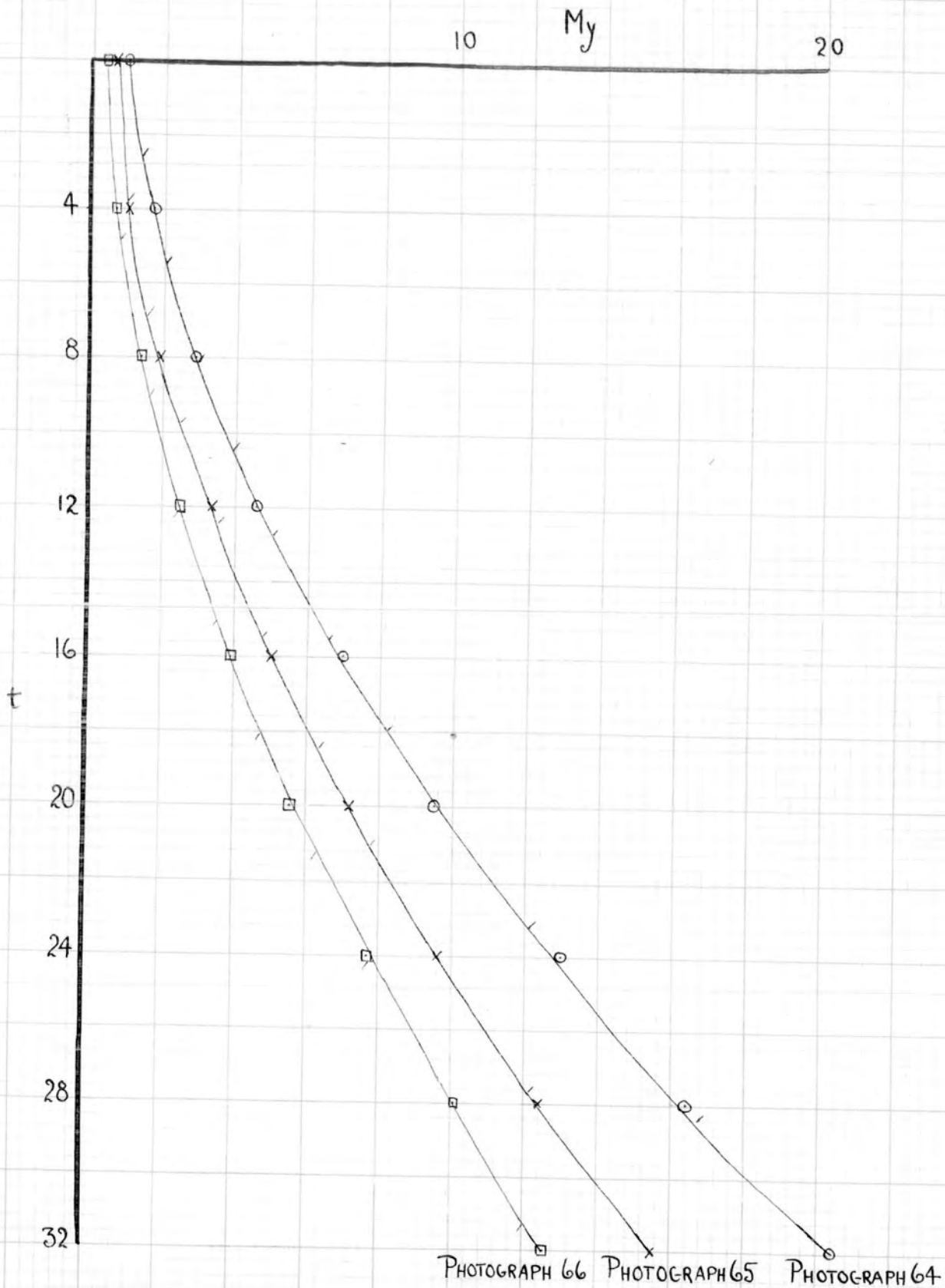

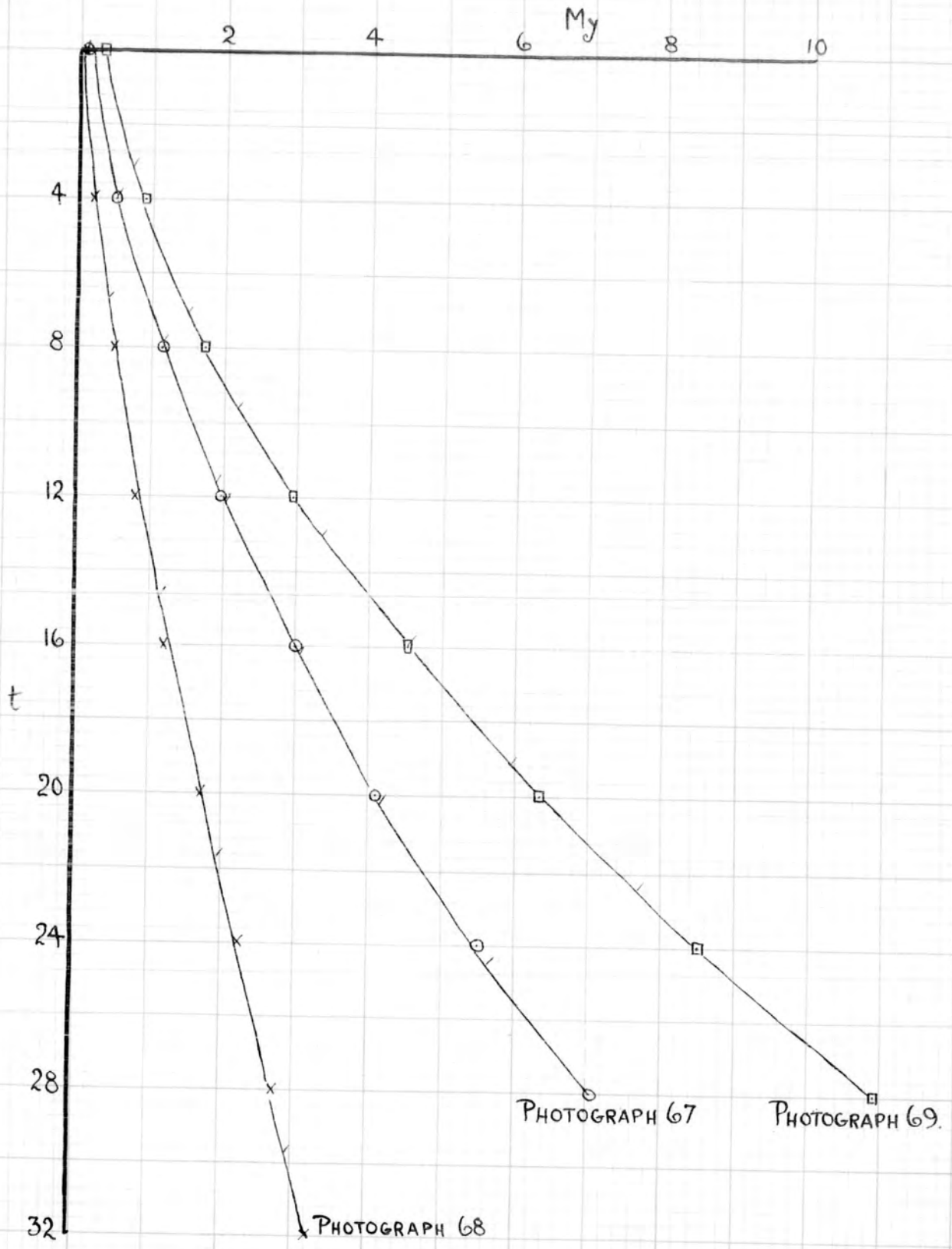

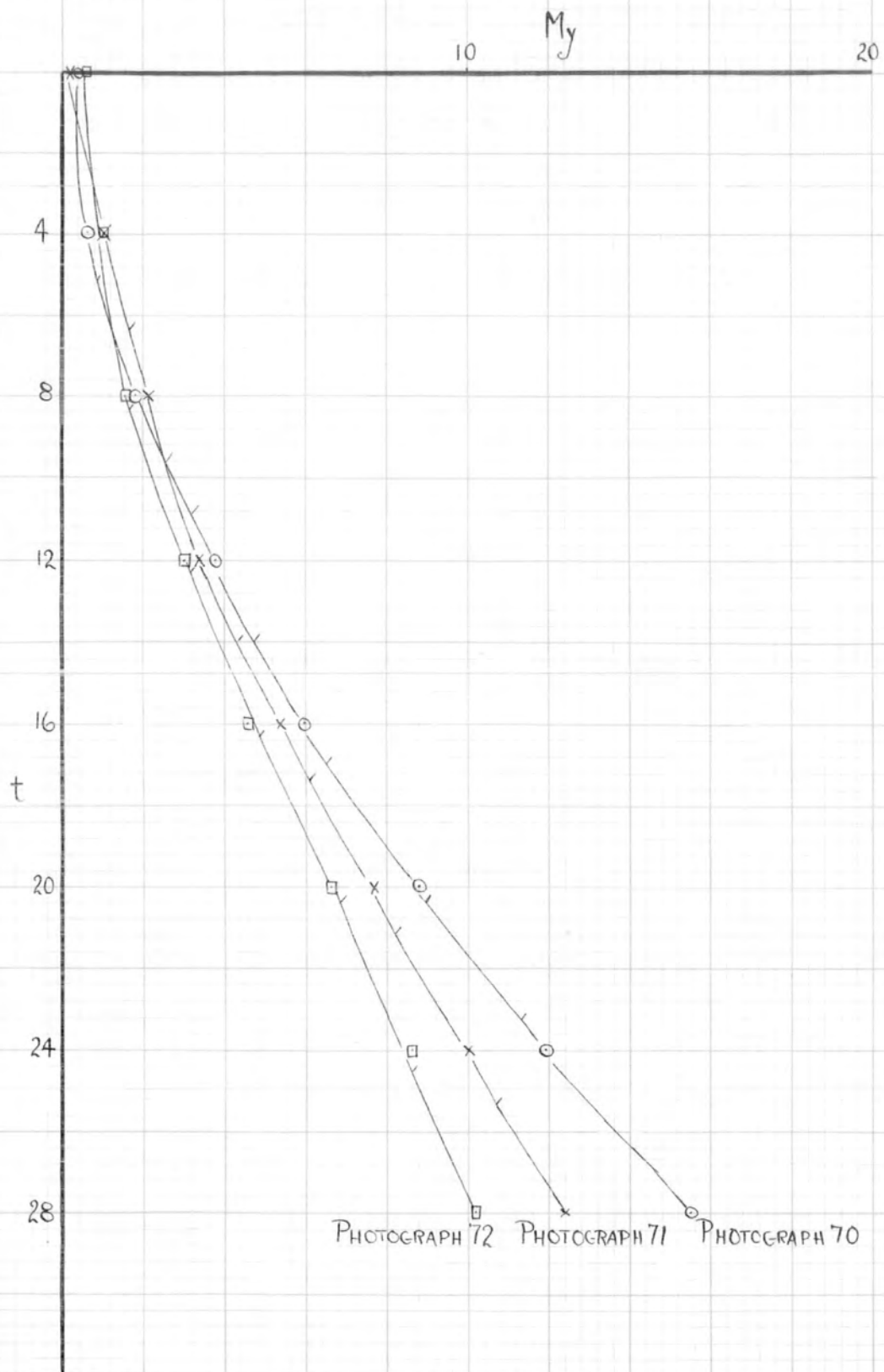

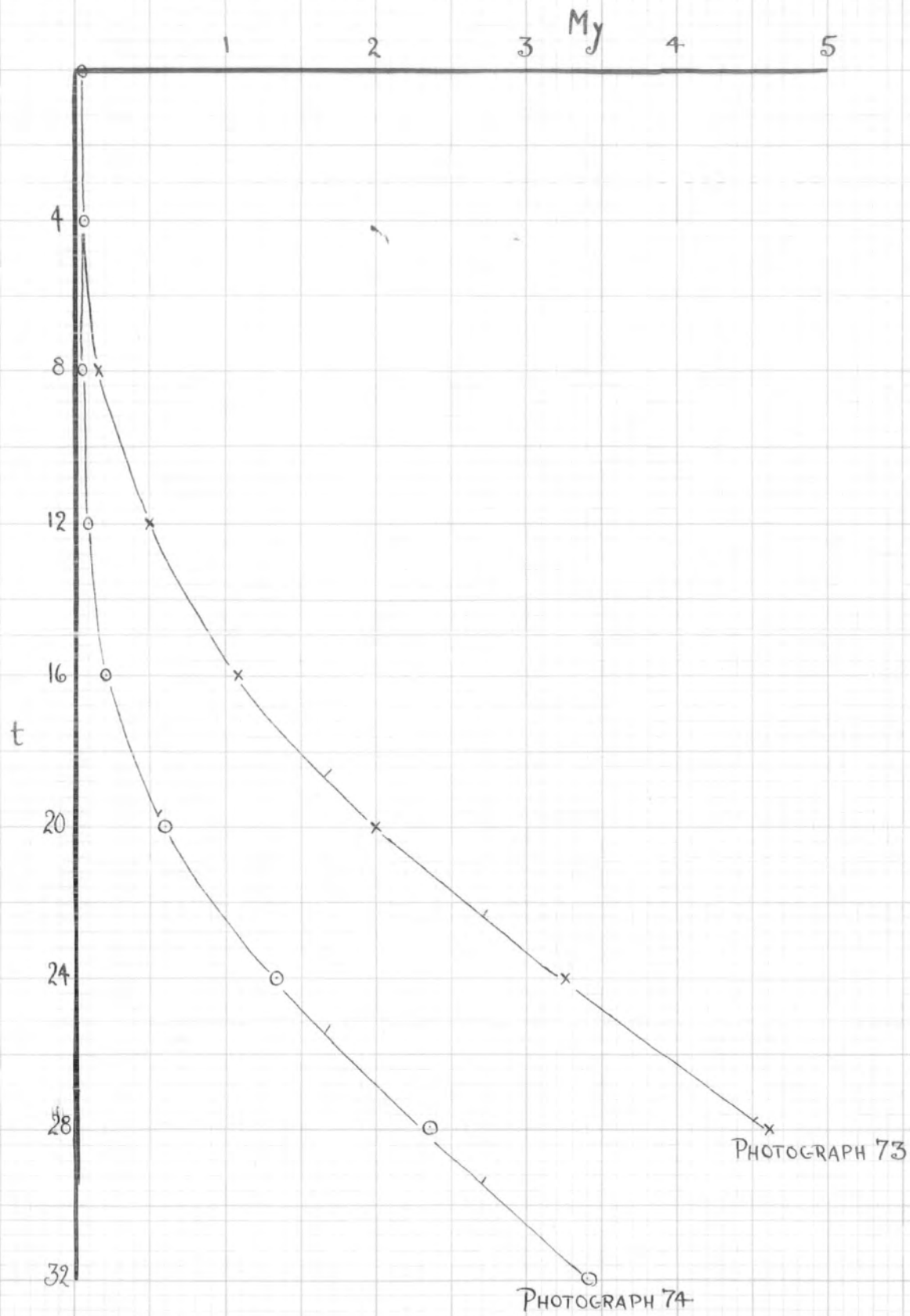

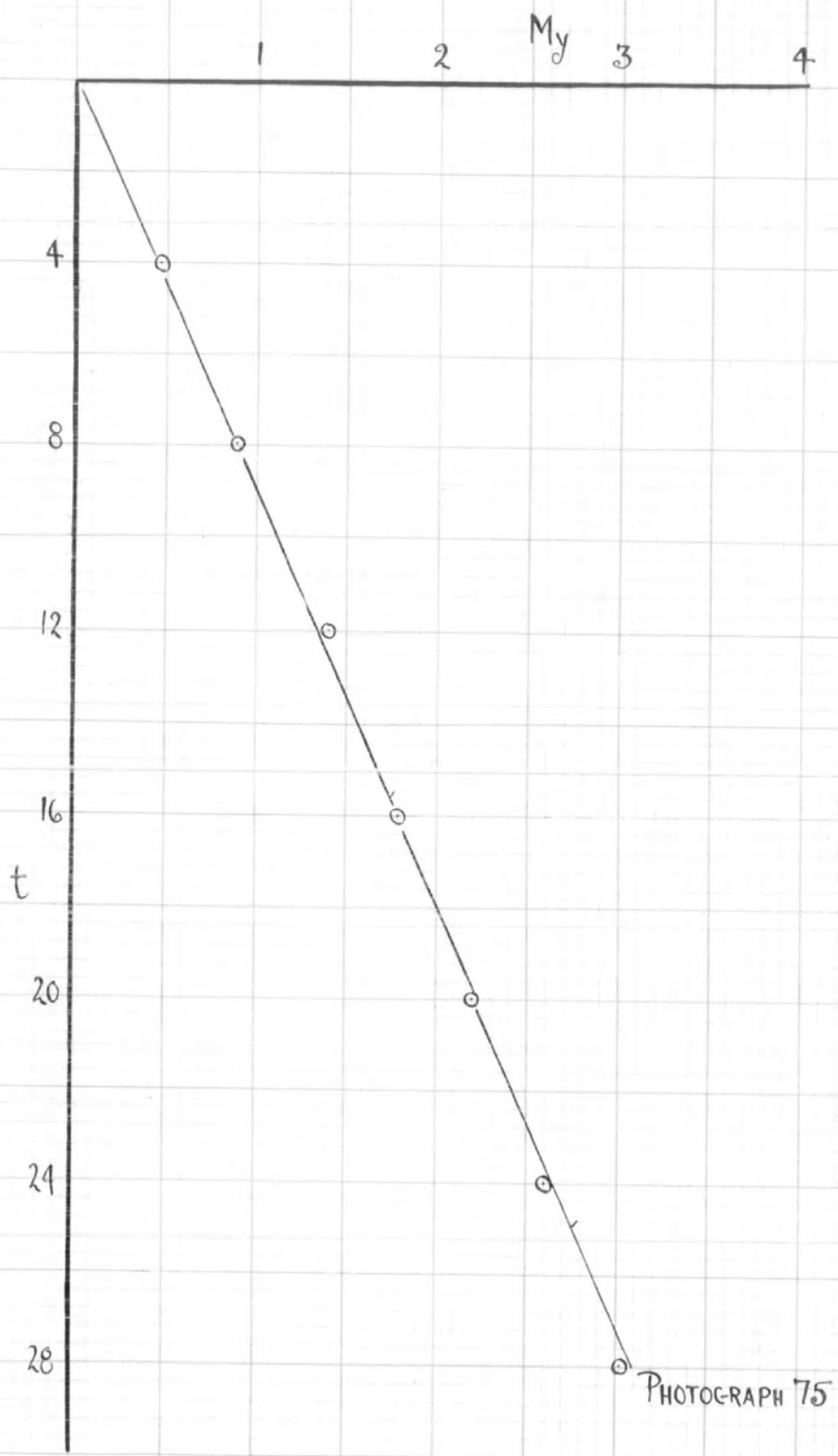

PHOTOGRAPH 75

TABLE III.

z	$\log_e \cosh z$	$\frac{m}{K} x$ $\log_e \cosh z$	64 zero 1.0	65 zero .6	66 zero .5	67 zero .1	68 zero 0	69 zero .35
.10	.0043	.40	1.40	1.00	.90	.50	.40	.75
.15	.0120	1.13	2.13	1.73	1.63	1.23	1.13	1.48
.20	.0191	1.80	2.80	2.40	2.30	1.90	1.80	2.15
.25	.0315	2.96	3.96	3.56	3.46	3.06	2.96	3.31
.30	.0440	4.13	5.13	4.73	4.63	4.23	4.13	4.48
.35	.0601	5.65	6.65	6.25	6.15	5.75	5.65	6.00
.40	.0777	7.29	8.29	7.89	7.79	7.39	7.29	7.64
.50	.1200	11.58	12.58	12.18	12.08	11.68	11.58	11.93
.60	.1706	16.05	17.05	16.65	16.55	16.15	16.05	16.40
.70	.2280	21.44	22.44	-	-	-	-	-

Photograph 64.

Values of t marked off from the graph corresponding to the above values of My :-

2.8, 5.7, 8.2, 10.5, 12.9, 15.4, 17.9, 23.2, 28.4

Differences:-2.9, 2.5, 2.3, 2.4, 2.5, 2.5, 5.3, 5.2

The last two correspond to a z difference of .1 and are thus double the rest. The equality of these shows that the experimental curve has a true log cosh form.

Mean change in t for a change in z of .05 = $\frac{28.4 - 2.8}{10}$

$$t \text{ of } 16 \equiv Mx \text{ of } 68.0 \equiv x \text{ of } 68.0 \times \frac{1.925}{53.5} = 2.56$$

$$t \text{ of } 2.56 \equiv z \text{ of } .05.$$

$$\frac{z}{x} = .127$$

$$m = \frac{4}{3} \pi (12.6) a^3$$

$$K = 1.007 \times 10^{-3} a^2 g$$

$$\frac{m}{K} = 53.6a = 3.38 \quad (\text{this applies to all the photographs 64 - 69})$$

$$F = \left(\frac{z}{x} \times \frac{m}{K} \right)^2 \text{ mg}$$

$$\text{i.e. } F = \underline{\underline{.180 \text{ mg.}}}$$

Photograph 65.

Values of t

3.9, 6.7, 9.6, 12.6, 15.6, 18.5, 21.2, 27.4

Mean difference corresponding to z increase of .05 = $\frac{20.7}{7}$

$$z \text{ of } .05 \equiv t \text{ of } \frac{20.7}{7} \equiv Mx \text{ of } \frac{69.5}{16} \times \frac{20.7}{7} \\ \equiv x \text{ of } .464$$

$$\frac{z}{x} = .1075$$

$$F = \underline{\underline{.132 \text{ mg.}}}$$

Photograph 66.

Values of t

5.1, 8.9, 12.0, 15.0, 18.0, 21.1, 24.1, 31.0.

Mean difference corresponding to z increase of .05 = $\frac{22.1}{7}$

$$\begin{aligned} z \text{ of } .05 &\equiv t \text{ of } 3.17 \equiv Mx \text{ of } 71.0 \times \frac{3.17}{16} \\ &\equiv x \text{ of } .503 \end{aligned}$$

$$\frac{z}{x} = .100$$

$$\underline{\underline{F = .112 \text{ mg}}}$$

Photograph 67.

Values of t

4.0, 8.1, 11.7, 16.0, 20.2, 24.4

Mean difference corresponding to z increase of .05 = $\frac{20.4}{5}$

$$\begin{aligned} z \text{ of } .05 &\equiv t \text{ of } 4.08 \equiv Mx \text{ of } 71.5 \times \frac{4.08}{16} \\ &\equiv x \text{ of } .658 \end{aligned}$$

$$\frac{z}{x} = .076$$

$$\underline{\underline{F = .066 \text{ mg}}}$$

Photograph 68.

Values of t

6.8, 14.6, 21.8, 29.8

Mean differences corresponding to z increase of .05 = $\frac{23.0}{3}$

$$\begin{aligned} z \text{ of } .05 &\equiv t \text{ of } 7.67 \equiv Mx \text{ of } 72.0 \times \frac{7.67}{16} \\ &\equiv x \text{ of } 1.24 \end{aligned}$$

$$\frac{z}{x} = .0403$$

$$\underline{\underline{F = .019 \text{ mg}}}$$

Photograph 69.

Values of t

3.2, 6.8, 9.8, 13.0, 16.0, 19.2, 22.3.

Mean difference corresponding to z increase of .05 = $\frac{15.5}{5}$

$$z \text{ of } .05 \equiv t \text{ of } 3.1 \equiv M_x \text{ of } 70.0 \times \frac{3.1}{16}$$

$$\equiv x \text{ of } .488$$

$$\frac{z}{x} = .1025$$

$$\underline{\underline{F = .120 \text{ mg}}}$$

TABLE IV.

Photograph	Applied Voltage	Force/mg
64	10.4v	.180
65	8.35	.132
66	6.25	.112
67	4.20	.066
68	2.10	.019
69	7.20	.120

TABLE V.

z	$\log_e \cosh z$	$\frac{Mm}{K} x$ $\log_e \cosh z$	70 .zero .40 M as in 75	71 zero .45	72 zero 0	73 zero 0	74 zero 0	75 zero 0 M = 55/1.925
.10	.0043	.60	1.00	1.05	.60	.60	.60	0.61
.15	.0120	1.68	2.08	2.13	1.68	1.68	1.68	1.70
.20	.0191	2.68	3.08	3.13	2.68	2.68	2.68	2.70
.25	.0315	4.43	4.83	4.88	4.43	4.43	4.43	4.47
.30	.0440	6.18	6.58	6.63	6.18	6.18	6.18	6.23
.35	.0601	8.44	8.84	8.89	8.44	8.44	8.44	8.52
.40	.0777	10.93	11.33	11.38	10.93	10.93	10.93	11.03
.50	.1200	16.85	17.25	17.30	16.85	16.85	16.85	17.02

Photograph 70.

Values of t

5.0, 8.1, 10.8, 14.0, 17.0, 20.2, 23.2.

Mean difference corresponding to z increase of .05 = $\frac{12.4}{4}$.
$$z \text{ of } .05 \equiv t \text{ of } 3.1 \equiv Mx \text{ of } 82.5 \times \frac{3.1}{16}$$

$$\equiv x \text{ of } .57$$

$$\frac{z}{x} = \frac{.05}{.57}; \quad \frac{m}{K} = 53.6 \text{ a} = 4.955$$

$$\underline{\underline{F = .188 \text{ mg}}}$$

Photograph 71.

Values of t

2.8 , 5.4 , 9.9 , 13.8 , 17.4 , 21.2 , 25.1 ,

Mean difference corresponding to z increase of .05 = 3.8

$$z \text{ of } .05 \equiv t \text{ of } 3.8 \equiv Mx \text{ of } 81.4 \times \frac{3.8}{16}$$

$$\equiv x \text{ of } .683$$

$$\frac{z}{x} = .0736; \quad \underline{\underline{F = .133 \text{ mg}}}$$

PHOTOGRAPH 72.

Values of t

4.0 , 8.4 , 12.2 , 16.2 , 20.4 , 24.8

Mean difference corresponding to z increase of .05 = 4.3

$$z \text{ of } .05 \equiv t \text{ of } 4.3 \equiv Mx \text{ of } 81.0 \times \frac{4.3}{16}$$

$$\equiv x \text{ of } .770$$

$$\underline{\underline{F = .103 \text{ mg}}}$$

Photograph 73.

Values of t

12.6 , 18.8 , 22.4 , 27.5

Mean difference corresponding to z increase of .05 = 14.9/3

$$z \text{ of } .05 \equiv t \text{ of } 4.97 \equiv Mx \text{ of } 83.7 \times \frac{4.97}{16}$$

$$\equiv x \text{ of } .930$$

$$\underline{\underline{F = .070 \text{ mg}}}$$

Photograph 74.

Values of t

20.0 25.0 29.5

Mean difference corresponding to z increase of .05 = $9.5/2$

$$z \text{ of } .05 \equiv t \text{ of } 4.75 \equiv M_x \text{ of } 84.5 \times \frac{4.75}{16}$$

$$\equiv x \text{ of } .887.$$

$$\underline{F} = \underline{.076 \text{ mg}}$$

Photograph 75.

Values of t

5.7 , 15.9 , 25.0

Very little curvature is visible on this curve; the deductions from such small deflections become only approximate.

Mean difference corresponding to z increase of .05 = $19.3/2$

$$z \text{ of } .05 \equiv t \text{ of } 9.65 \equiv M_x \text{ of } 86.0 \times \frac{9.65}{16}$$

$$\equiv x \text{ of } 1.82$$

$$\underline{F} = \underline{.0187 \text{ mg}}$$

TABLE VI.

Photograph	Applied Voltage	Force /mg
70	10.7	.188
71	8.5	.133
72	6.3	.103
73	4.2	.076
74	4.2	.070
75	2.1	.019

CHAPTER III.

RESULTS using PURE MERCURY.

: : : :

PURE MERCURY DROPS.

This Chapter deals exclusively with the results obtained using pure mercury in various solutions. Several strengths of Sulphuric Acid were used, and following this various concentrations of sulphuric acid saturated with mercurous sulphate were thought of sufficient interest to employ. Then other solutions, all of concentration 0.001N were used. The charges in these solutions are given in the tables in the following pages. For each solution the charge is deduced from a straight line graph relating horizontal force and applied voltage, the force being obtained in each case from the corresponding photograph in the manner described at the close of the previous chapter.

Prior to these results the cases in which drops of widely varying radii were used are stated, and the proportionality between charge and drop radius is deduced.

Variation of Charge
with Radius.

0.001N H₂SO₄ solution

See Tables IV and VI (previous chapter).

0.025N H₂SO₄ solution

TABLE VII.

Photograph Number.	Drop Radius.	Applied Voltage.	Force on Drop.
48	.081cms	2.78volts	.118 mg
49	.081cms	2.57volts	.094 mg
51	.070cms	2.19volts	.044 mg
52	.070cms	2.77volts	.131 mg
53	.070cms	2.53volts	.092 mg
55	.0945cms	2.23 volts	.045 mg
56	.0945cms	2.57 volts	.091 mg

These two sets of results show that the force on the drop increases uniformly with the potential which is applied between the plates. These results are most conveniently expressed as graphs relating Force/mg and Voltage.

Figure 16 shows this graph for 0.001N sulphuric acid solution.

The most interesting result indicated by these graphs is the fact that, not only is F/mg proportional to V for drops of any one size, but the points for different sized drops all come on the same straight line. Thus in a constant potential gradient F/mg is constant, whatever the size of the drop. Thus the force in the potential gradient is proportional to the mass of the drop. As the force is only dependent on the drop charge and the potential, this means that the drop charge is proportional to the mass of the drop, i.e. to the cube of the radius.

The straight lines of F/mg against V are good in both cases, and as the two sets of experiments were conducted in acid of widely different strengths, they provide ample confirmation of each other, and seem to establish beyond reasonable doubt the result previously

found by Wagstaff, viz:-

The Drop Charge is Proportional to the
Cube of the Radius.

In the following experiments, in which solutions of various other strengths were used, only one sized drop was used in one solution, and from the slopes of the graphs relating F/mg and V the values of E/mg , and hence E/a^3 , were deduced, and are included after their respective tables. The whole of the graphs are not included, Fig. 16 is a typical example.

Charge variation with
Acid Strength.

0.001N H₂SO₄ solution.

See Tables IV and VI. (previous chapter).

Mean Value of E/a^3 deduced = 0.16×10^7 e.s.u./cm³

0.003N H₂SO₄ solution.

TABLE VIII.

Photograph Number	Drop Radius	Applied Voltage.	Force on Drop.
100	.06235cms	10.2v	.416mg
101	.06235cms	8.1v	.356mg
102	.06235cms	6.15v	.230mg
103	.06235cms	4.1v	.154mg
104	.06235cms	2.1v	.052mg
105	.06235cms	5.3v	.169mg

Mean Value of E/a^3 deduced = 0.427×10^7 e.s.u./cm³

0.01 N H₂SO₄ solution.TABLE IX.

Photograph Number.	Drop Radius	Applied Voltage.	Force on Drop.
77	.0620 cms	2.53 v.	.100 mg
78	.0620 cms	2.18 v.	.051 mg
79	.0620 cms	2.07 v.	.055 mg
80	.0620 cms	1.53 v.	.027 mg
81	.0620 cms	4.20 v.	.291 mg

Mean Value of E/a^3 deduced = 0.98×10^7 e.s.u./cm³

0.033 N H₂SO₄ solution.TABLE X.

Photograph Number.	Drop Radius	Applied Voltage.	Force on Drop.
106	.0618 cms	4.00 v.	.40 mg
107	.0618 cms	2.79 v.	.167mg
108	.0618 cms	2.44 v.	.105mg
109	.0618 cms	2.00 v.	.050mg

Mean Value of E/a^3 deduced = 1.68×10^7 e.s.u./cm³

0.05 N H₂SO₄ solution.

TABLE XI.

Photograph Number	Drop Radius	Applied Voltage	Force on Drop
82	.0626 cms	4.1 v.	.536 mg
83	.0626 cms	2.60 v.	.161 mg
85	.0626 cms	2.21 v.	.065 mg
86	.0626 cms	2.01 v.	.036 mg
87	.0626 cms	2.27 v.	.081 mg

Mean Value of E/a^3 deduced = 2.23×10^7 e.s.u./cm³

0.067 N H₂SO₄ solution.

TABLE XII.

Photograph Number.	Drop Radius.	Applied Voltage.	Force on drop.
88	.0620 cms	4.0 v.	.547 mg
89	.0620 cms	2.78 v.	.202 mg
90	.0620 cms	2.47 v.	.151 mg
91	.0620 cms	2.29 v.	.105 mg
92	.0620 cms	1.98 v.	.033 mg
93	.0620 cms	2.09 v.	.053 mg

Mean Value of E/a^3 deduced = 2.32×10^7 e.s.u./cm³

0.10 N H₂SO₄ solution.

TABLE XIII.

Photograph Number.	Drop Radius.	Applied Voltage.	Force on Drop.
94	.0610 cms	3.95 v.	.736 mg
95	.0610 cms	2.02 v.	.036 mg
97	.0610 cms	2.62 v.	.216 mg
98	.0610 cms	2.34 v.	.149 mg
99	.0610 cms	2.21 v.	.104 mg

Mean Value of E/a^3 deduced = 3.03×10^7 e.s.u./cm³

Variation of E/a^3 and E/mg
with Concentration of H_2SO_4 solution.

TABLE XIV.

Acid Concentration.	E/a^3	E/mg
0.001 N	0.16×10^7	0.31×10^2
0.003 N	0.43×10^7	0.83×10^2
0.010 N	0.98×10^7	1.90×10^2
0.025 N	1.40×10^7	2.72×10^2
0.033 N	1.68×10^7	3.24×10^2
0.050 N	2.25×10^7	4.50×10^2
0.067 N	2.32×10^7	4.48×10^2
0.100 N	3.03×10^7	5.89×10^2

The above set of results is also given in graph form in Fig: 17.

The charge increases with concentration of acid but not in direct proportion. The potential, and hence the charge, on the drop is usually held to be due to the mercury ions which have already come into the solution from the drop. As the following experiments using acid saturated with mercurous sulphate, seem to throw some doubt on this, it would

seem desirable to defer discussion of the form of this curve until after the inclusion of these latter results.

The saturated solutions of mercurous sulphate in the various strengths of acid used were prepared by shaking the acid with a generous excess of powdered mercurous sulphate. The process of solution was extended over several weeks so that complete saturation was made certain. The excess of mercurous sulphate was then removed by filtration and the resulting clear solution was used in the apparatus.

The solubility of mercurous sulphate in acid is very small, and does not vary a great deal with acid strength.

ACID SATURATED WITH MERCUROUS SULPHATE..001 N H₂SO₄ solution (saturated with Hg₂SO₄).TABLE XV.

Photograph Number.	Drop Radius.	Applied Voltage.	Force on Drop.
131	.0571 cms	11.7 v.	.0930 mg
132	.0571 cms	11.7 v.	.0937 mg
133	.0571 cms	6.1 v.	.0560 mg
134	.0571 cms	4.0 v.	.045 mg
135	.0571 cms	2.1 v.	.014 mg

Mean Value of E/a^3 deduced = $.0762 \times 10^7$ e.s.u./cm³

.005 N H₂SO₄ solution (saturated with Hg₂SO₄).TABLE XVI.

Photograph Number.	Drop Radius.	Applied Voltage.	Force on Drop.
114	.056 cms	8.65 v.	.143 mg
115	.056 cms	8.00 v.	.133 mg
117	.056 cms	5.80 v.	.0945 mg
118	.056 cms	4.30 v.	.069 mg
119	.056 cms	2.20 v.	.019 mg

Mean Value of E/a^3 deduced = $.202 \times 10^7$ e.s.u./cm³

.030 N H₂SO₄ solution (saturated with Hg₂SO₄).

TABLE XVII.

Photograph Number.	Drop Radius.	Applied Voltage.	Force on Drop.
127	.0587 cms	4.10 v.	.19 mg
126	.0587 cms	6.05 v.	.41 mg
129	.0587 cms	2.90 v.	.075 mg
130	.0587 cms	2.10 v.	.03 mg

Mean Value of E/a^3 deduced = .966 x 10⁷ e.s.u./cm³

.10 N H₂SO₄ solution (saturated with Hg₂SO₄).

TABLE XVIII.

Photograph Number.	Drop Radius.	Applied Voltage.	Force on Drop.
120	.0576 cms	4.20 v.	.49 mg
121	.0576 cms	2.74 v.	.18 mg
122	.0576 cms	2.56 v.	.132 mg
123	.0576 cms	2.45 v.	.099 mg
124	.0576 cms	2.92 v.	.193 mg
125	.0576 cms	2.00 v.	.05 mg

Mean Value of E/a^3 deduced = 2.20 x 10⁷ e.s.u./cm³

Relation between Charges in
Pure Sulphuric Acid Solution
and Charges in Acid saturated
with Mercurous Sulphate.

TABLE XIX.

Acid Concentration.	E/a ³ in Fresh Acid.	E/a ³ in Saturated Acid.	Ratio.
.001 N	.16 x 10 ⁷	.076 x 10 ⁷	2.11
.005 N	.60 x 10 ⁷	.202 x 10 ⁷	2.98
.030 N	1.66 x 10 ⁷	.97 x 10 ⁷	1.71
.10 N	3.02 x 10 ⁷	2.20 x 10 ⁷	1.36

These results in acid saturated with mercurous sulphate show very clearly that the effect of the mercurous sulphate is, in every case, to reduce the value of the charge. Many of the theories of the mechanism of formation of charge on these drops (see introduction) attribute it to the return of dissolved mercurous ions into the drop. According to this theory the drops will attain higher charges the higher the concentration of mercurous ions in the solution surrounding them. Now a drop of mercury falling in acid attains its charge from those mercurous ions dissolving, or already present, in the solution. In solutions saturated with mercurous sulphate the maximum possible concentration of these ions is present, while in fresh acid only a small fraction of the saturation will dissolve, and go to form the charge on the drop. It follows that the drop charges should be greater in acid solutions saturated with mercurous sulphate than they are in the fresh acid solutions of the same strength. Experimentally it was found that exactly the reverse takes place. On the mercurous ion theory the charge could never be greater, in a certain acid strength, than its value when that acid is saturated with mercurous sulphate, whereas actually the charge

is observed to be greater in pure acid. It seems highly improbable, therefore, that the mercurous ions are responsible for the charge.

After mercurous ions, there can only be hydrogen ions responsible for positive charges in these solutions. Assuming that the hydrogen ions cause the charge on the drop, then a possible explanation of the reduction of this charge by saturation of the acid with mercurous sulphate becomes evident. The addition of more sulphate ions to the acid will suppress the ionisation of the latter, so that fewer hydrogen ions will be available, and the charge correspondingly less. The mercurous sulphate saturated acid is equivalent, in hydrogen ion concentration, to a less concentrated solution of pure acid, and gives a charge corresponding to this latter acid strength - this charge being less. In less concentrated acid solutions the amount of sulphate ion added is greater in relation to that already present (from the acid) and the suppression of the ionisation will be comparatively greater. The number of free hydrogen ions will thus be diminished by a greater proportion so that the ratio $\frac{\text{Charge in pure acid}}{\text{Charge in acid Hg}_2\text{SO}_4}$ will increase as the acid strength diminishes. This is precisely what was found in the preceding experiments.

At the higher concentrations the amount of additional sulphate ion, limited by the solubility of mercurous sulphate, is small compared with that present in the acid, so that very little effect on the charge is noticed. At the lower concentrations the sulphate ion concentration is altered considerably by saturation with mercurous sulphate, so that reductions in the charge of more than 50% were recorded.

SOLUTIONS OTHER THAN H₂SO₄..001 Zn SO₄ solutionTABLE XX.

Photograph Number.	Drop Radius.	Applied Voltage.	Force on Drop.
200	.0571 cms	4.2 v.	.034 mg
201	.0571 cms	8.4 v.	.074 mg
202	.0571 cms	12.4 v.	.102 mg
203	.0571 cms	16.9 v.	.122 mg
204	.0571 cms	21.4 v.	.175 mg
205	.0571 cms	8.4 v.	.062 mg

Mean Value of E deduced = .081 x 10⁷ a³ e.s.u. /cm³

.001 N Na₂SO₄ solution.TABLE XXI.

Photograph Number.	Drop Radius	Applied Voltage.	Force on Drop.
243	.0650 cms	17.2 v.	.178 mg.
244	.0650 cms	17.2 v.	.164 mg.

Mean Value of E deduced = .093 x 10⁷ a³ e.s.u. /cm³

.001 N $Al_2(SO_4)_3$ solution.

TABLE XXII.

Photograph Number.	Drop Radius.	Applied Voltage	Force on Drop.
206	.0585 cms	4.2 v.	.051 mg
207	.0585 cms	8.4 v.	.111 mg
208	.0585 cms	12.2 v.	.141 mg
209	.0585 cms	16.7 v.	.210 mg
210	.0585 cms	21.2 v.	.236 mg

Mean Value of E deduced = $.116 \times 10^7$ a³ e.s.u./cm³

.001 N $HgNO_3$ in .003 N HNO_3 solution.

TABLE XXIII.

Photograph Number.	Drop Radius	Applied Voltage.	Force on Drop.
222	.061 cms	8.2 v.	.212 mg
223	.061 cms	6.2 v.	.146 mg
224	.061 cms	4.2 v.	.087 mg

Mean Value of E deduced = $.298 \times 10^7$ a³ e.s.u./cm³

.001 N NaOH solution.TABLE XXIV.

Photograph Number.	Drop Radius.	Applied Voltage.	Force on Drop.
225	.0674 cms	17.4 v.	.182 mg
226	.0674 cms	11.2 v.	.123 mg
227	.0674 cms	6.2 v.	.071 mg

Mean Value of E deduced = .106 x 10⁷ a³ e.s.u./cm³

.001 N Pb(NO₃)₂ solution.TABLE XXV.

Photograph Number.	Drop Radius	Applied Voltage.	Force on Drop.
228	.0661 cms	17.6 v.	.163 mg
229	.0661 cms	11.7 v.	.116 mg
230	.0661 cms	6.5 v.	.070 mg

Mean Value of E deduced = .095 x 10⁷ a³ e.s.u./cm³

.001 N Ba(NO₃)₂ solution.TABLE XXVI.

Photograph Number.	Drop Radius.	Applied Voltage.	Force on Drop.
231	.0659 cms	17.3 v.	.156 mg
232	.0658 cms	11.3 v.	.095 mg
233	.0658 cms	6.3 v.	.038 mg

Mean Value of E deduced = .093 x 10⁷ a³ e.s.u./cm³

.001 Zn(NO₃)₂ solution.TABLE XXVII.

Photograph Number.	Drop Radius.	Applied Voltage.	Force on Drop.
234	.0650 cms	17.2 v.	.142 mg
235	.0650 cms	11.2 v.	.090 mg
236	.0650 cms	6.2 v.	.041 mg

Mean Value of E deduced = $.081 \times 10^7 \text{ a}^3 \text{ e.s.u.}$

.001 HNO₃ solution.TABLE XXVIII.

Photograph Number.	Drop Radius.	Applied Voltage.	Force on Drop.
237	.0642 cms	17.2 v.	.271 mg
238	.0642 cms	11.2 v.	.183 mg
239	.0642 cms	6.2 v.	.072 mg

Mean Value of E deduced = $.163 \times 10^7 \text{ a}^3 \text{ e.s.u.}$

.001 NaCl solution.TABLE XXIX.

Photograph Number.	Drop Radius.	Applied Voltage.	Force on Drop.
240	.0662 cms	6.2 v.	.066 mg
241	.0662 cms	11.2 v.	.106 mg
242	.0662 cms	17.2 v.	.145 mg

Mean Value of E deduced = $.094 \times 10^7 \text{ a}^3 \text{ e.s.u.}$

Charges in Various Solutions.
of the same Concentration.

TABLE XXX.

<u>Solution.</u>	<u>Charge (e.s.u.).</u>
.001 N HNO ₃	.163 x 10 ⁷ a ³
.001 N H ₂ SO ₄	.160 x 10 ⁷ a ³
.001 N NaCl	.094 x 10 ⁷ a ³
.001 N Na ₂ SO ₄	.093 x 10 ⁷ a ³
.001 N NaOH	.106 x 10 ⁷ a ³
.001 N ZnSO ₄	.081 x 10 ⁷ a ³
.001 N Zn(NO ₃) ₂	.081 x 10 ⁷ a ³
.001 N Ba(NO ₃) ₂	.093 x 10 ⁷ a ³
.001 N Pb(NO ₃) ₂	.095 x 10 ⁷ a ³
.001 N Al ₂ (SO ₄) ₃	.116 x 10 ⁷ a ³

CHAPTER IV.

CONFIRMATORY RESULTS.

: : : :

Charge Measurements by
Galvanometer Deflections.

The charges obtained by the previous method were of sufficient magnitude to give measureable deflections on a sensitive ballistic galvanometer. Some time was spent examining the possibilities of this method of measurement of the drop charges, with a view to obtaining useful confirmation of the results furnished by the original method.

The main difficulty in a method such as this is to ensure that no additional effect, other than the charge on the drop, influences the galvanometer deflection. Also, the whole of the drop charge must pass instantaneously, so that the correct ballistic deflection is registered.

In the first experiments of this type, a simple glass cell was used. This consisted of a vertical tube down which the drops of mercury fell, the drops forming beneath the surface of the acid. Connections were made to the mercury in the dropper, and also to the lower mercury which collected at the base of the cell, by means of copper wires dipping into fine capillary tubes containing mercury, and having platinum wires sealed through their closed ends. In this way

only the mercury within the capillary tubes was in contact with the copper, and risk of contamination of the mercury in use was avoided. It was found later that the current set up between the dropping and stationary mercury electrodes was made up of two parts. Each time a drop falls a new mercury surface is exposed to the liquid, and the natural potential of mercury in the ^{solution} grows rapidly on it. The lower mercury was continually at this potential. Bernstein⁽¹⁹⁾ found that the rate of growth of potential on the new surface was such that it reached 84 % of its final value in .015 secs. Thus each time a drop fell there was a potential difference, diminishing at this rate, between the two electrodes, and a corresponding current flowed through the outside circuit. In addition to this current, the charged drop fell down into the lower mercury and gave up its charge, which flowed round the circuit also. The existence of these two components of the resultant current, was shown best when the drops ran at a slow rate and a dead-beat galvanometer was included across the electrodes. The deflections of the latter were registered by means of a moving-plate camera. As the drop grew the spot moved suddenly at first and then approached a limiting position. As the drop fell off the dropper the spot fell back suddenly, and as the new

drop began to grow the deflection mounted up again, but was interrupted in its growth when the previous drop entered the lower mercury, and its charge passed round the circuit. It thus became obvious that, if the charge were to be obtained from deflections due to single drops, the two effects must be separated, preferably by elimination of the new surface effect altogether. Experiments in which it was sought to obtain the charges from a constant deflection, obtained when the drops followed each other in quick succession, were found to be neither consistent nor repeatable, probably because the maximum speed of dropping which could be used (i.e. the maximum speed at which the individual drops could be counted) was not sufficient to prevent the tendency to return to zero between impulses.

Accordingly, a new apparatus was designed, in which the current due to the exposure of the new surface at the dropper was eliminated, and that due to the drop charge studied alone. This necessitated the introduction of a third mercury electrode in contact with the solution, but free from the effect of drops entering it. The design of the apparatus finally used is shown in Fig. 7. The drops fell from

the tip of the dropper down the wide tube in to the stationary mercury below. The column of acid in the tube was balanced by the mercury in a U-tube, and as drops entered the mercury they displaced an equal amount of mercury from a jet at the end of the U-tube, in a manner similar to that described under weighing of drops in Chapter I. The wide tube had a U-tube sealed in at a level higher than the mercury surface and this tube contained the new mercury electrode. Tubes for allowing the acid to circulate were also supplied. The acid entered at a level just above the mercury surface into which the drops fell, and left the vessel by a tube just above the mercury surface in the side U-tube. The flow of acid prevented the formation of mercurous sulphate at these surfaces, or rather carried away any sulphate that was formed. Thus the charge was not too low by reason of its being measured in acid containing mercurous sulphate rather than in pure acid. That acid containing mercurous sulphate dissolved in it gives a lower charge than pure acid is shown and explained in the previous chapter.

In one of the trial pieces of apparatus, in which there was no flow of acid, the deflections were observed when the dropper and the lower mercury were

connected, and were found to diminish with length of time of dropping. If the drops were left falling overnight the deflections were found to be reduced to a fraction of their original values. As the charge is flowing from the drops it is replaced by ions from the solution, so that we may expect a weakening of these ions in the solution around the dropper, and the charge in the weaker solution will be less. There will also be a supply of ions from the stationary mercury surface since the current is continuous. The decrease of the charge is probably due to this effect and also the production of mercurous sulphate in the solution. If the charges are to be measured in a particular strength of pure acid continual supply of fresh acid is a necessity, and it is also preferable that it should be supplied as near as possible to the surface of the mercury. In the case where the charges were to be measured as they combined with the lower mercury, the other electrode being the stationary undisturbed mercury, it seemed advisable to have the acid entering just above the former mercury surface, hence the design of the new apparatus. It was found that the deflections, although not always constant, now maintained a fixed average value.

The galvanometer was calibrated by means of an additional circuit, in which a condenser of suitable capacity was charged by application of 2 volts, and then discharged through the galvanometer. To make this discharge take place in conditions similar to those of discharge of the drop, the condenser was discharged through the galvanometer via the vessel, which was included in the circuit. The drops were cut off when calibration deflections were being observed. For the drop deflections Key K was kept closed. The galvanometer was short-circuited until immediately before the drop to be measured entered the lower mercury, so that the charges due to previous drops had all flowed away, so that the deflection corresponded to the effect of the one drop only. In spite of these precautions, the method suffered from the disadvantage that the galvanometer wandered slightly from its zero position during the short interval between the removal of the short and the recording of the deflection. Also, when coalescence was not quite instantaneous, a slight deflection (usually in the opposite direction to the true deflection) was given on impact and the galvanometer had no time to return to rest before the actual deflection on coalescence. The wandering from

zero and deflection on impact were, in most cases, small compared with the deflection on coalescence, so that the latter was still of the same order of magnitude as it would have been under ideal conditions.

Several deflections were taken in each case, and the limits were observed. The largest deflection took place when the coalescence was the nearest to instantaneous, i.e. the slight kick in the opposite direction was the smallest, and hence the largest deflections are likely to give the best values to the drop charges.

Seth. Anand and Mahajan⁽²⁰⁾ performed some experiments in which the delay of coalescence when drops of various liquids were allowed to fall upon a surface of the same liquid, and found that the time of delay depended on the height from which the drop fell, there being a certain range of heights giving no delay, i.e. immediate coalescence. Presumably, a change in height of the dropper meant a change in velocity of impact in these experiments. It was unfortunately impossible to alter the velocity of impact in the present experiments, as the drops, already falling in acid, had reached their terminal velocity in every case. Some experiments were performed, however, in

which other factors were altered. Several pieces of apparatus were made, all similar to that already described except that glass tubes of different diameters were employed for the construction of the main vertical tube. When mercury was introduced into these the shape of the meniscii into which the drops fell varied from almost an inverted hemisphere in the narrowest tube, to a broad flat surface in the widest. Coalescence was found to be increasingly good with the use of a narrower tube, i.e. a non-flat meniscus. Coalescence also improved in the weaker concentrations of acid. The readings of deflections mentioned previously were all taken in the vessel having the narrowest vertical tube.

In all except the strongest acid concentrations used it was found possible to obtain perfect coalescence by having the drops striking the exact centre of the narrow meniscus. Small drops could be made to coalesce almost instantaneously even in the most concentrated acid used. With large drops, however, a considerable delay took place except in weak acid. If an examination is made of the results shown in the Table on the following page it will be seen that the charges deduced by this method agree with the previously

Results for E/a^3 by Galvanometer
Deflection Method.

TABLE XXXI.

Acid Concentration.	Large or Small Drops L or S	Limits of E/a^3 by Galvanometer Method ($\times 10^{-7}$)	E/a^3 by the Original Method. ($\times 10^{-7}$)
.001 N	L	.145 to .175	.16
.003 N	S	.40 to .46	.42
	L	.44 to .47	.42
.010 N	L	.67 to .78	.98
	S	.89 to .96	.98
	S	.86 to .94	.98
.033 N	S	1.58 to 1.80	1.68
	S	1.20 to 1.60	1.68
	L	less than .8	1.68
.10 N	S	2.52 to 3.04	3.02
	S	2.69 to 2.89	3.02

determined values in all cases where coalescence was good. The letters L and S in column two indicate large and small drops respectively. Serious difference between charges obtained by the two methods only occurs in cases where large drops were used in the higher concentrations of acid, the very cases in which coalescence was not satisfactory. In these cases the charge deduced by the galvanometer method is too small, the effect of delay in coalescence being to reduce the deflections.

The agreement between the two methods is in most cases quite good. The lack of agreement in one or two cases is easily explained. Hence while this method is not sufficiently accurate as a method of determination of drop charge in itself, owing to the coalescence difficulty, it seems to afford ample confirmation of the results obtained by the former, more accurate, method.

CHAPTER V.

AMALGAMS.

: : : :

Zinc Amalgams.

Pure Zinc was added to pure mercury in such a quantity that provided both were totally mixed the resulting amalgam would contain about 2% by weight of Zinc. The two metals were placed in a lightly stoppered flask and heated together in a water-bath. The flask was periodically removed and well shaken. This process was continued for ten or twelve days when the whole mass seemed to be of even constitution, except for the scum which had formed on the surface. As it was uncertain what amount of the Zinc was contained in the scum it was not sufficiently accurate to take the original weights of Zinc and Mercury in order to calculate the percentage composition of the amalgam. Instead, a known quantity of the amalgam was drawn off from below, and analysed for Zinc. The sample drawn off was boiled with normal sulphuric acid solution for several days. Passage of H_2S gas through the acid liquid gave no precipitate showing that none of the Mercury had been affected by the acid, which had therefore dissolved the Zinc alone. The Mercury remaining was that which had been present in the original amalgam. This mercury was carefully washed and after pipetting off the excess water the last traces were removed by

thorough drying in a dessicator. Weighing of this mercury gave a determination of the exact composition of the amalgam which was called Amalgam A. This amalgam was used as the basic amalgam, others being made when required, by dilution with mercury.

Experiments were performed in which drops of amalgam were substituted for pure mercury drops, and photographs of the deflections suffered by these drops, when horizontal fields were applied, in precisely the same manner as the pure mercury photographs were obtained. These experiments were restricted to .001 N H_2SO_4 and .001 N Na_2SO_4 solutions only. In most cases two photographs were taken with the applied voltage about the same in each case, one photograph being used as a check on the other. From each photograph the force on the drop was determined in the usual way, and from it a value for the charge on the drop under those particular circumstances.

It was found that for the more concentrated amalgams (A, B & C) about 40 v gave a considerable deflection towards the positive electrode, indicating that the drop was negatively charged. Charges deduced from these photographs were about $-0.1 \times 10^7 \text{ a}^3 \text{ e.s.u.}$, but decreased a little with weakening of the amalgam.

In sodium sulphate solution the negative charge appeared to be much less, and 90 - 130 volts were needed to give a reasonable deflection. Charges deduced from these deflections were about $-0.1 \times 10^6 a^3$ e.s.u., i.e. roughly one tenth of those in acid.

With the change from Amalgam C to D it was found that quite a small voltage applied now gave a deflection towards the negative electrode, showing that the charge was now positive, and the magnitude deduced from the deflection was, in acid, about $.17 \times 10^7 a^3$ e.s.u., and in sodium sulphate about $.07 \times 10^7 a^3$ e s.u., The charges had thus become positive and of an order approaching those obtained on pure mercury drops. Further dilution of the amalgam with pure mercury (to amalgam E and further) gave but little change in these results.

As no reason could be imagined for the sudden change at this amalgam strength, return was made to Amalgam B, and a point which had been overlooked at first was noticed. In the experiments described above about 40v had been applied in each case as it gave a suitable deflection for photographing in the first cases. Arrangements were now made by which it was possible to gradually increase the applied voltage from zero up to

100 volts, this being done simply by inclusion of a rheostat in series with the cell containing the solution. As the voltage was made to increase from zero the drop seemed to be affected very little, but at 25-30 volts slight deflections towards the negative electrode were observed. As this deflection was very slight it may possibly have increased uniformly from zero, only reaching an amount observable visually at the above-mentioned voltage. Further increase in voltage caused the deflection toward the negative to disappear, the drop being again undeflected at 34 volts. Above this voltage increasing deflections toward the positive were observed, these being the deflections which had been noticed in the first experiments with a fixed potential of 40v. The above results were taken with drops of radius .065 cms, the plate distance being 2.035 cms.

Effect of Potential Gradient
on Amalgam Drop Charge.

The observations described on the last few pages seem to indicate that the existence of the potential gradient in the solution around the drop must have some effect on the potential or charge acquired by the drop. The only changes between successive experiments were those made in the applied voltage, and hence the alteration in the charge can only be due to this. The charges measured are therefore not the true charges acquired by the drops in the solution, but in applying the potential gradient to determine the drop charge, the latter was altered as a result. A high potential gradient would seem to cause the drops to become negatively charged, whereas they would seem to be positive when the gradient is small. This indicates that the true charge in solution in which no potential gradient exists would be positive, the negative charge being caused by the potential gradient only.

If we imagine hydrogen ions (in acid, or sodium ions in sodium sulphate solution) being attracted to the negative electrode, this attraction will be greater in larger fields and hence fewer ions will be attracted to the drop, causing less addition of positive charge

to the drop. Also this removal of positive ions from the surroundings of the drop will make it more easy for zinc to come out of the drop into the solution, and as some of these zinc ions will themselves be removed under the influence of the field their place can be taken by more zinc from the drop. Under the higher potentials therefore, we might expect a less proportion of hydrogen ions going to form positive charge on the drop, and a greater proportion of zinc coming into solution, leaving the drop more negatively charged. The higher the applied potential the greater this effect, which may become of such magnitude as to reverse the drop charge, as noted in practice.

If any comparative results with various amalgams were to be obtained, it seemed obvious that they must be done under the same conditions, i.e. deflections and deduced values of charge must be compared only when the potential gradient was the same. The value most near the true value (in the absence of potential) was probably that obtained from the lower gradients, i.e. from the deflections obtained towards the negative at potentials less than that required for reversal.

A new set of observations were made on the series

of amalgams B, B₂, B₃, B₄... etc., each of which was made by dilution of amalgam B with mercury. Photographs were taken with each strength of amalgam, under an applied voltage of 24v, the distance between the plates being the same throughout. Drops of about the same size were used, a new dropper being employed for each amalgam as it was found impossible to thoroughly clean a dropper once it had contained amalgam. The amalgam, unlike mercury, clings to the glass walls of the fine capillary and cannot be removed.

24v was found to be a suitable voltage giving the positive deflection prior to reversal in most cases. By having a photograph of the path traced by each amalgam under the same applied potential, a basis of comparison was obtained. Where necessary, photographs with other applied voltages were taken, and when reversals occurred, the approximate voltage at which the change over took place was noted.

In the following pages are given most of the zinc amalgam results, which are followed by a summary.

ZINC AMALGAM RESULTS.Amalgam A. - Table XXXII.

Photograph Number.	Drop Radius	Applied Voltage.	Force on Drop
346	0.0651 cms	16 v	0.144 mg
347	0.0651 cms	24 v	0.041 mg

.001 N H₂SO₄
solution.

E/a³ under Potential Gradient of 7.85 v/cm. = 0.085 x 10⁷ e.s.u.

E/a³ under Potential Gradient of 11.75 v/cm. = 0.016 x 10⁷ cm³

Photograph Number.	Drop Radius	Applied Voltage.	Force on Drop
312	0.0544 cms	36 v	-0.363 mg

.001 N H₂SO₄
solution.

E/a³ under Potential Gradient of 17.6 v/cm. = -0.097 x 10⁷ $\frac{\text{e.s.u.}}{\text{cm}^3}$

Photograph Number.	Drop Radius.	Applied Voltage.	Force on Drop.
305	0.0505 cms	36 v	-0.393 mg
307	0.0505 cms	28 v	-0.31 mg
311	0.0544 cms	87 v	-0.775 mg

0.001 N HNO₃
solution.

E/a³ under Potential Gradient of 17.8 v/cm = -.0103 x 10⁷

E/a³ under Potential Gradient of 13.9 v/cm = -0.105 x 10⁷

E/a³ under Potential Gradient of 43.1 v/cm = -0.090 x 110⁷

Amalgam A. - Table XXXII (Contd).

Photograph Number.	Drop Radius.	Applied Voltage.	Force on Drop.
309	0.0544 cm	204 v.	-0.222mg
310	0.0544 cm	97 v.	-0.112mg

.001 N Na₂SO₄ solution.

E/ under Potential Gradient of 97.5v/cm = $-.102 \times 10^6 a^3 \text{esu}$

E under Potential Gradient of 46.3v/cm = $-.112 \times 10^6 a^3 \text{esu}$

Amalgam B₁ - Table XXXIII.

Photograph Number.	Drop Radius.	Applied Voltage.	Force on Drop.
313	0.0585 cm	41 v.	-0.38 mg
314	0.0585 cm	32 v	-0.235mg
334	0.0639 cm	18 v.	
335	0.0639 cm	24 v.	0.096mg
315	0.0542 cm	85 v.	-0.12 mg
316	0.0542 cm	109 v.	-0.16 mg

.001 N H₂SO₄ solution.

.001 N Na₂SO₄ solution.

.001 N H₂SO₄ solution.

E under Potential Gradient of 19.6v/cm = $-0.0905 \times 10^7 a^3 \text{esu}$.

E under Potential Gradient of 15.3v/cm = $-0.071 \times 10^7 a^3 \text{esu}$.

E under Potential Gradient of 11.7v/cm = $+0.037 \times 10^7 a^3 \text{esu}$.

.001 N Na₂SO₄ solution.

E under Potential Gradient of 40.2v/cm = $-0.139 \times 10^6 a^3 \text{esu}$.

E under Potential Gradient of 51.6v/cm = $-0.144 \times 10^6 a^3 \text{esu}$.

Amalgam C. - Table XXXIV.

Photograph Number	Drop Radius	Applied Voltage.	Force on Drop.	
317	0.0621cm	40 v.	-0.37 mg	<u>.001 N H₂SO₄ solution.</u>
318	0.0621cm	40 v.	-0.369mg	
319	0.0621cm	135 v.	-0.137mg	<u>.001 N Na₂SO₄ solution.</u>
320	0.0621cm	135 v.	-0.155mg	

.001 N H₂SO₄ solution.E under Potential Gradient of 19.4 v/cm = $-0.087 \times 10^7 a^3$ esu..001 N Na₂SO₄ solution.E under Potential Gradient of 65.5 v/cm = $-0.105 \times 10^6 a^3$ esu.Amalgam D. - Table XXV.

Photograph Number.	Drop Radius	Applied Voltage.	Force on Drop.	
321	0.0684cm	10.2 v.	0.268mg	<u>.001 N H₂SO₄ solution.</u>
322	0.0684cm	10.4 v.	0.268mg	
323	0.0684 cm	13.6 v.	0.155mg	<u>.001 N Na₂SO₄ solution.</u>
324	0.0684 cm	13.6 v.	0.158mg	

.001 N H₂SO₄ solution.E under Potential Gradient of 6.9 v/cm = $+0.175 \times 10^7 a^3$ esu.E under Potential Gradient of 9.1 v/cm = $+0.080 \times 10^7 a^3$ esu.
in .001 N Na₂SO₄ solution.

Amalgam E. - Table XXXVI.

Photograph Number.	Drop Radius.	Applied Voltage.	Force on Drop.
325	0.0642 cm.	10.2 v.	+0.239 mg
326	0.0642 cm.	9.9 v.	+0.264 mg
327	0.0642 cm	13.3 v.	+0.137 mg
328	0.0642 cm	13.2 v.	+0.108 mg
329	0.0642 cm	13.2 v.	+0.119 mg

.001 N H₂SO₄ solution.

.001 N Na₂SO₄ Solution.

.001 N H₂SO₄ solution.

E under Potential Gradient of 6.7 v/cm = +0.175 x 10⁷a³ esu.

.001 N Na₂SO₄ solution.

E under Potential Gradient of 8.8 v/cm = +0.63 x 10⁶a³ e.s.u

Amalgam F. - Table XXXVII.

Photograph Number.	Drop Radius	Applied Voltage.	Force on Drop.
330	0.0700 cm	10.4 v.	+0.232mg
331	0.0700 cm	10.8 v.	+0.219mg

.001 N H₂SO₄ solution.

.001 N H₂SO₄ solution.

E under Potential Gradient of 5.1 v/cm = +0.198 x 10⁷a³esu.

Amalgam B₂ - Table XXXVIII.

Photograph Number.	Drop Radius.	Applied Voltage.	Force on Drop.
336	0.0639cm	23.5 v.	+0.085mg
337	0.0639cm	23.0 v.	+0.085mg

.001 N H₂SO₄ solution.

Reversal Gradient 15.3-16.3 v/cm.

.001 N H₂SO₄ solution.

E under Potential Gradient of 11.3 v/cm = +0.035 x 10⁷a³esu.

Amalgam B₃ - Table XXXIX.

Photograph Number.	Drop Radius	Applied Voltage.	Force on Drop.
338	0.0645cm	24.0 v.	+0.41mg
339	0.0645cm	24.0 v.	+0.41mg

.001 N H₂SO₄ solution.

No Reversal

.001 N H₂SO₄ solution.

E under Potential Gradient of 11.7 v/cm = +0.163 x 10⁷a³esu.

Amalgam B₄ = Table XL.

Photograph Number.	Drop Radius.	Applied Voltage.	Force on Drop.
342	0.0658 cm	19.0 v	+0.15 mg
343	0.0658 cm	19.0 v	+0.138mg

.001 N H₂SO₄ solution.

.001 N H₂SO₄ solution.

E under Potential Gradient of 9.3 v/cm = +0.057 x 10⁷a³esu.

Amalgam B₅ - Table XLI.

Photograph Number.	Drop Radius.	Applied Voltage.	Force on Drop.
344	0.0609 cm.	24.0 v.	+0.49 mg.
345	0.0609 cm.	18.0 v.	+0.285mg.

.001 N H₂SO₄
solution.

No Reversal.

.001 N H₂SO₄ solution.

E under Potential Gradient of 11.4 v/cm = +0.197 x 10⁷a³esu.

E under Potential Gradient of 8.55 v/cm = +0.155 x 10⁷a³esu.

Percentage Composition of Zinc Amalgams.

Amalgam A	-	1.595%	Zinc	(by analysis)
Amalgam B ₁	-	0.190%	Zinc	(by dilution of Amalgam A)
Amalgam B ₂	-	0.062%	Zinc	do.
Amalgam B ₃	-	0.012%	Zinc	do.
Amalgam B ₄	-	0.040%	Zinc	do.
Amalgam B ₅	-	0.021%	Zinc	do.
Amalgam C	-	0.030%	Zinc	do.
Amalgam D	-	0.002%	Zinc	do.
Amalgam E	-	0.003%	Zinc	do.
Amalgam F	-	00.011%	Zinc	do.

COLLECTED ZINC AMALGAM RESULTS.TABLE XLIII.

Amalgam.	% Zinc.	Charge/a ³ $\frac{esu^3}{cm}$	Gradient	Reversal Gradient.
A	1.595	-0.097 x 10 ⁷ +0.085 x 10 ⁷ +0.016 x 10 ⁷	17.6 v/cm 7.8 v/cm 11.8 v/cm	12.7-14.7v/cm.
B ₁	0.1902	-.091 x 10 ⁷ -0.071 x 10 ⁷ +0.037 x 10 ⁷	19.6 v/cm 15.3 v/cm 11.7 v/cm.	13.7 - 15.3v/cm
B ₂	0.0619	+0.035 x 10 ⁷	11.3 v/cm	15.3-16.3 v/cm
B ₄	0.0397	about zero + 0.057 x 10 ⁷	11.8 v/cm 9.3 v/cm	11.8-14.7 v/cm
C	0.0288	-0.0865 x 10 ⁷	19.4 v/cm	Reversal.
B ₅	0.0211	+0.197 x 10 ⁷ +0.155 x 10 ⁷	11.5 v/cm 8.6 v/cm	No Reversal
B ₃	0.0118	+0.163 x 10 ⁷	11.7 v/cm	No Reversal.
F	0.0107	+0.197 x 10 ⁷	5.15v/cm	No Reversal.
E	0.0030	+0.174 x 10 ⁷	6.7 v/cm	No Reversal.

Cadmium Amalgams.

Cadmium Amalgams were employed after silver amalgams, but as they resemble zinc amalgams in behaviour they will be described first. Pure Cadmium, in the form of thin discs of the metal, was added to sufficient mercury to make an amalgam containing approximately 2%, in a lightly stoppered vessel which was kept at a temperature just below 70° C by a thermostat arrangement. As cadmium is more soluble than zinc, the whole of it dissolved in a comparatively short period. More dilute amalgams were made as required by addition of mercury to portions of this amalgam.

Experiments on drops of these amalgams were performed as before. As in the case of zinc amalgams, slight positive deflections (i.e. deflections corresponding to positive charge) were obtained at low voltages, and increasing negative deflections were obtained above a certain applied voltage, at which no deflection was obtained. Again, a minimum concentration, below which no reversal was obtainable, was observed. Below this concentration the effect of voltage increase was merely to increase the original positive deflection.

The Cadmium amalgam results are detailed in the pages following.

Cadmium Amalgam Results.

Each Amalgam in .001 N H₂SO₄ solution only.

Amalgam A. - Table XLIII.

Photograph Number.	Drop Radius.	Applied Voltage.	Force on Drop.
360	0.0685cm	31.0 v.	-0.237 mg
361	0.0685cm	24.0 v.	-0.144 mg
362	0.0685cm	18.0 v.	+0.12-0.16mg
363	0.0685cm	12.0 v.	+0.10-0.15mg
364	0.0685cm	12.0 v.	+0.09-0.14mg

Charge in Potential Gradient of 15.1v/cm = -0.063 x 10⁷a³esu

Charge in Potential Gradient of 11.7v/cm = -0.047 x 10⁷a³esu

Maximum Charge.

in Potential Gradient of 8.75v/cm = +0.96 x 10⁷a³esu

in Potential Gradient of 5.85v/cm = +0.112 x 10⁷a³esu.

Amalgam J. - Table XLIV.

Photograph Number.	Drop Radius.	Applied Voltage.	Force on Drop.
365	0.0649cm	23.0 v.	+0.058 mg
366	0.0649cm	23.0 v.	+0.061 mg
367	0.0649cm	34.0 v.	-0.234 mg
368	0.0649cm	36.0 v.	-0.360 mg

Charge in Potential Gradient of 11.2v/cm = +0.025 x 10⁷a³esu.

Amalgam J. - (contd).Charge in Potential Gradient of 16.5v/cm = $-0.066 \times 10^7 a^3 \text{esu}$ Charge in Potential Gradient of 17.5v/cm = $-0.095 \times 10^7 a^3 \text{esu}$ Amalgam K. - Table XLV.

Photograph Number.	Drop Radius.	Applied Voltage.	Force on Drop.
369	0.0650cm	19.0 v.	+0.092 mg
370	0.0650cm	36.0 v.	-0.082 mg
371	0.0650cm	43.0 v.	-0.195 mg

Charge in Potential Gradient of 9.25v/cm = $+0.046 \times 10^7 a^3 \text{esu}$ Charge in Potential Gradient of 17.6v/cm = $-0.022 \times 10^7 a^3 \text{esu}$ Charge in Potential Gradient of 21.0v/cm = $-0.043 \times 10^7 a^3 \text{esu}$ Amalgam M. - Table XLVI.

Photograph Number.	Drop Radius.	Applied Voltage.	Force on Drop.
375	0.0626cm	16.5 v.	+0.30 mg
376	0.0626cm	11.0 v.	+0.21 mg

No Reversal.

Charge in Potential Gradient of 8.2v/cm = $+0.174 \times 10^7 a^3 \text{esu}$ Charge in Potential Gradient of 5.3v/cm = $+0.178 \times 10^7 a^3 \text{esu}$

COLLECTED CADMIUM AMALGAM RESULTS.Table XLVII.

Amalgam.	Cadmium.	Charge (esu) $\frac{a^3}{cm^3}$	Potential Gradient.	Reversal Gradient.
H	1.633	+0.096 x 10 ⁷	5.85v/cm	10.7-11.7v/cm
		+0.112 x 10 ⁷	8.75v/cm	
		-0.047 x 10 ⁷	11.7 v/cm	
		-0.063 x 10 ⁷	15.1 v/cm	
J	0.199	+0.025 x 10 ⁷	11.2 v/cm	12.7-15.6v/cm
		-0.066 x 10 ⁷	16.5 v/cm	
		-0.095 x 10 ⁷	17.5 v/cm	
K	0.015	+0.046 x 10 ⁷	9.25v/cm	9.76-14.6 v/cm
		-0.022 x 10 ⁷	17.6 v/cm	
		-0.043 x 10 ⁷	21.0 v/cm	
M	0.004	+0.174 x 10 ⁷	16.5 v/cm	No Reversal.
		+0.178 x 10 ⁷	11.0 v/cm	

Amalgam L, containing 0.010% Cadmium, gave slight deflections in the positive direction and the reversal effect at higher voltages. The negative deflections were also comparatively small. No photographs were taken as an insufficient supply of amalgam was made.

Silver Amalgams.

Although silver amalgamates very rapidly with small quantities of mercury, the making of an amalgam which contains only a small percentage of silver evenly dispersed throughout the mercury is a slow process. In order to make a liquid amalgam containing a reasonable quantity of silver was used. After about three weeks of continual heating at 70° and periodical shaking, the undissolved silver was removed, and the remaining amalgam retained for experiment. The charges were all positive, and the values of the charge deduced were so similar to that on pure mercury that repetition with weaker amalgams was not warranted.

Silver Amalgam G .001 N H₂SO₄ solution.

Table XLVIII.

Photograph Number.	Drop Radius.	Applied Voltage.	Force on Drop.
350	0.0644cm	11.0 v.	0.205 mg
351	0.0644cm	10.6 v.	0.198 mg
352	0.0644cm	10.5 v.	0.198 mg
353	0.0644cm	23.0 v.	0.405 mg
354	0.0630cm	13.9 v.	0.241 mg
355	0.0630cm	13.7 v.	0.288 mg

Mean Value of Charge/a³ for Amalgam G
in .001 N H₂SO₄ solution. = 0.179 x 10⁷a³ esu.

These silver amalgam drops appear to attain positive charges slightly larger than those on pure mercury drops under similar conditions, - +0.18³ x 10⁷ as compared with +0.16 x 10⁷a³. Silver is usually considered slightly more positive than mercury in the electro-potential series, and this would be confirmed by the above result. Silver resembles mercury in several respects, so that it is not surprising that in this instance its amalgam behaved like mercury. The amalgam was probably sufficiently concentrated to give the natural p.d. of silver, as there is reason to believe that even fairly weak amalgams give the silver potential. The following table of results by Lindeck (see 21) gives the potential between silver amalgams and amalgamated zinc, and shows that a .05% amalgam gives almost the same potential as one which is saturated.

Per cent Silver.	Potential Difference.
saturated	1.32 v.
2.0	1.30 v.
0.57	1.33 v.

The amalgam used must have contained at least 0.5% silver. Several experimenters have dissolved 2 - 6% silver by heating in an open vessel, so that it is within reason to assume that a good percentage dissolved in the present case.

Cadmium and Zinc Amalgams behave in a manner totally different from Mercury or Silver Amalgam. Cadmium and zinc are both negative with respect to hydrogen while mercury and silver are positive. The charges acquired would therefore be expected to be less than those obtained with mercury, - either less positive or even negative, depending on the magnitudes of the various factors involved. Actually, while both positive and negative charges could be obtained, depending on the value of the applied potential gradient, it seems that in the absence of potential gradients the drops would naturally attain a positive charge. The artificial change due to voltage application causes the increasingly negative charges.

The charges cannot be assumed fully grown in these experiments. Those obtained from the lower parts of the curves were found to be slightly larger, and therefore nearer the maximum value. In low potential gradients the charges are positive but much less than

those for pure mercury. Even if they were completely grown it seems highly improbable that they would be as high as the pure mercury drop charges. If we assume that the charge on mercury is due to hydrogen ions, zinc and cadmium must therefore be less positive than hydrogen, but still positive. The effect of potential gradient must be to increase the rate of transference of zinc or cadmium ions into the solution, this eventually making the charge negative, although it would naturally be positive. This is proved in some photographs in which the voltage was just above the reversal voltage. Before entering the field the drop was slightly positive, not being under the influence of the field. Hence at the beginning of its passage across the field of view it was attracted towards the negative electrode. The drop, now being affected by the potential gradient, rapidly lost its positive charge and attained a negative one, finally being attracted to the positive electrode. The path of the drop, although originally directed toward the negative electrode, was concave toward the positive, showing that the drop was continually losing positive charge while crossing the field. Two tracks are shown in the diagram overleaf. ^{(Also in} _{FIG 19)} This effect could only be noticed with gradients slightly in excess of the reversal gradient.

If gradients which were too high were used, the positive charge was lost too quickly for the slight motion at first towards the negative electrode to be visible.

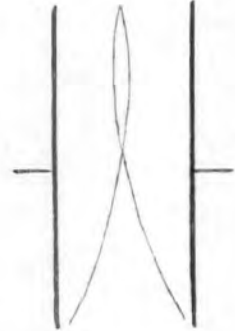

The drop charge can be influenced by two factors:-

- (1) the tendency of the drop to attain a potential such as it would attain in acid in which no potential gradient existed.
- (2) the tendency of zinc (or cadmium) ions to leave the drop under the influence of potential gradient.

The zinc coming into the solution as a result of the second effect will appear as positive ions, and the second effect therefore causes a diminution of the positive drop charge, which will increase with increase of the gradient. When the gradient is still less than that required for reversal, there will be an addition of charge due to the first effect and a removal due to the second, the former being the greater. Whatever charge is removed by the latter is more than replaced by the former. The total effect is therefore a slowing of the rate of growth of the natural charge, and if this slowing is sufficient the drop will not acquire the full charge before reaching the lower plate

level. The charge deduced will therefore be a fraction of the full charge, the fraction being small in the case of a positive deflection in a gradient just short of the reversal gradient, when the rate of growth would be extremely slow.

At gradients above the reversal gradient, the effect due to voltage outweighs the natural effect, and the charge now grows negatively against the natural effect. The higher the gradient the greater the difference in magnitude between the two effects. The negative charge will increase until a quantity of positive charge, sufficient to prevent any further loss of positive charge by the drop, is retained by attraction in the drop surroundings. This positive charge will be retained in spite of the draining influence of the field.

Let E_0 be the final negative charge attained.

Retaining force on a positive ion,
proportional to E_0 = $k'E_0$

Draining force on a positive ion,
proportional to field X = KX

Final negative charge is reached when these balance.

$$k' \text{ i.e. } k' E_0 = K X$$

or, the negative charge attained is proportional to the field. At any other instant, before the final charge is

reached, the resultant force on a positive ion is:-

$$K X - k' E \quad \text{or} \quad k'(E_0 - E)$$

This force causes the ion to drift away to the negative electrode. Its velocity of drift will be proportional to the resultant force on it, and hence the rate of removal of charge from the drop vicinity is proportional to this force. The rate of removal of positive charge is equivalent to the rate at which it can be replaced from the drop, i.e. the rate of growth of the negative charge on the drop.

$$\frac{dE}{dt} = k(E_0 - E) \quad E_0 \text{ and } E \text{ are negative.}$$

Taking $t = 0$ as the point at which the drop enters the field, the charge at this instant will be a certain fraction of the natural positive charge E , this amount having grown while the drop was falling in the liquid above the electrodes. This will remain constant if the drops all fall from the same level.

$$\int \frac{dE}{(E_0 - E)} = \int k dt$$

$$-\log_e(E_0 - E) = kt - \log_e(E_0 + \xi)$$

$$\frac{E_0 - E}{E_0 + \xi} = e^{-kt}$$

$$E = \underline{E_0(1 - e^{-kt}) - \xi e^{-kt}}$$

The charge therefore changes in the manner indicated by the lower graph, which is obtained by combination of the two upper ones. When the reversal voltage was just exceeded, E_0 , depending on the magnitude of the gradient, was small, and the slight attraction to the negative was visible, corresponding to AB where the charge was positive but rapidly diminishing. With increase of potential gradient E_0 may be expected to increase rapidly so that the curve, while still retaining the same value of k , crosses the time axis earlier, i.e. the drops are positive for shorter periods, and the effect of their commencing the passage across the field with positive charges becomes negligible, or at most registers itself as a delay in the commencement of

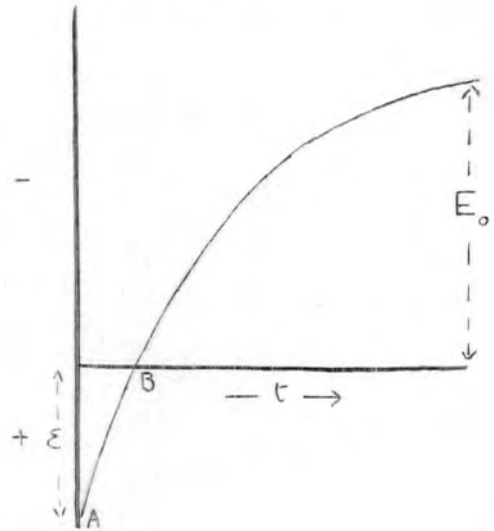
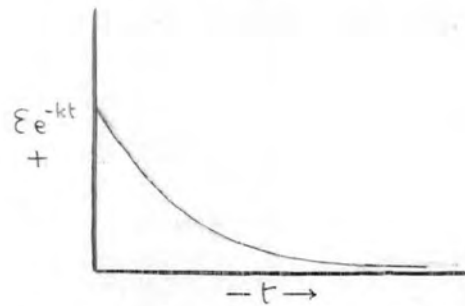
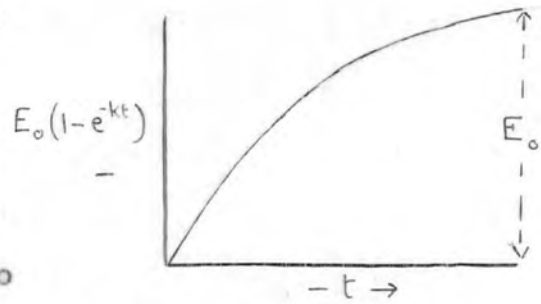

the negative charge to deflect. The diagram shows how the period during which the drop is positive becomes rapidly shorter as the gradient above reversal, and hence E_0 , is increased.

It thus seems to be highly probable that the rates of interchange of ions between the drops and the solution can be altered by application of potential gradients in the solution, i.e. that the drop charges and potentials can be varied artificially in

this way. By assuming an attraction of ions toward the electrodes, the attraction being proportional to the gradient, a satisfactory explanation of the observed phenomena can be obtained.

At the lower gradients the former of the two factors mentioned previously is of most importance in the determination of the drop charge, and it seems that the drop shows a natural tendency to acquire a positive charge. Since this charge is measured relative to the

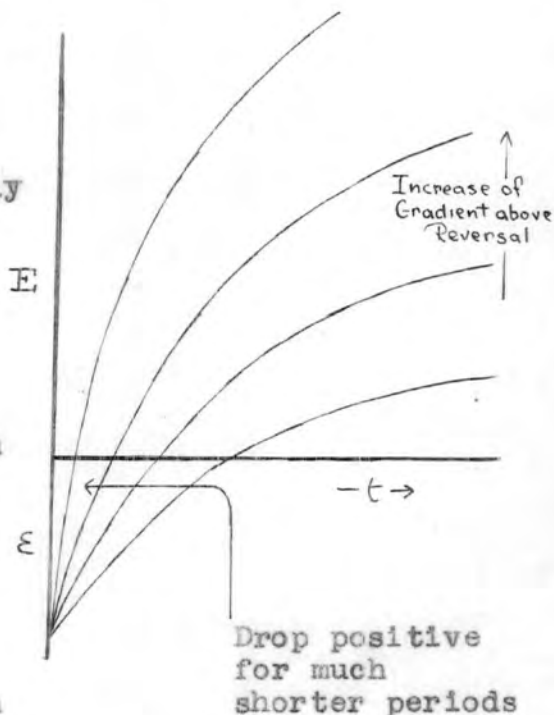

solution only, it would appear that drops of this composition attain a potential which is positive relative to the solution, yet not so highly positive as mercury alone. Zinc amalgams containing 1% zinc approach the potential of zinc itself, a fact which has been established by several workers. The most accurate work on relative potentials of amalgams of various concentrations has been done by Richards and his co-workers⁽²¹⁾.

Thus the amalgam of highest zinc content (1.5%) may be assumed to be very nearly at the true zinc potential, which has been shown to be positive relative to the solution. In a similar fashion the cadmium amalgam results indicate that cadmium is also positive in this acid of low concentration. That they should be less positive than mercury is to be expected, but the fact that they are still positive seems to indicate that absolute zero is at least beyond cadmium and zinc toward the sodium end of the series. Any result taken from the magnitudes of the charges would be untrustworthy, as it would be necessary to assume the absolute potential proportional to the charge ($E = a^2v_0/d$) for drops of both pure mercury and its amalgam, in order to deduce a value for the position in the series at which the charge would be zero. This assumption may not be

true since the ions involved in each case are not the same, so that d , the thickness of the double layer, may be different in the two cases. The experiments do show that even zinc and cadmium may be positive.

CHAPTER VI.

ADDITIONAL EXPERIMENTS.

CHARGES ON AIR BUBBLES.

Bubbles of air in water can be made to move under the influence of a potential gradient. The experiments of Alty⁽⁵⁾ and his colleagues, in which bubbles were made to move along the axis of a rotating tubular cell, have shown that the bubbles move very slowly even in fields of considerable magnitude. It was thought that this effect might be obtainable by a method similar to that described for mercury drops, except that in this case the bubbles would rise between the plates. As only a short time was available before completion of the research period, the original apparatus, employed for mercury drops, was utilised. Although it became evident that an improved design of apparatus would be preferable, these experiments at least seemed to indicate the possibilities of the method. In his earliest papers on the subject Alty used water twice distilled in glass and employed a soft glass cell. Later he took more elaborate precautions in obtaining very pure water, and found that the charges on the bubbles were small but still finite. As the vessel used in the experiments described here was made of glass it seemed that we

must be content with experiments using water of the same order of purity as that which Alty used in his first experiments. To obtain this purity it was necessary to completely dismantle the vessel, removing the ends and the electrodes, and to steam it out for several days after a good preliminary washing in distilled water. This was the only really effectual method of removing all traces of acid and other solutions previously used. In an apparatus of this type the water must come into contact with the vacuum wax used for sealing purposes. It is questionable whether this will affect the purity of the water, but it seems improbable since the conductivities obtained were of similar order to those obtained by Alty.

The water used was made in a condensing apparatus consisting of hard glass flasks and a copper condenser. Each of the components of this apparatus had been steamed out for several days before use. The water was twice distilled through this apparatus and then filled into the vessel, which had been reassembled. A convenient plate distance for these experiments was approximately $1/2$ cm. This allowed higher gradients to be obtained, and in addition had the advantage of steadying the motion of the bubbles. The rise of

the bubbles in unrestricted liquid was found to be rather erratic, but this effect of the plates on the motion of the bubbles helped to overcome this difficulty.

The bubbles were formed at a fine jet connected by a tube passing up the vessel (outside the electrodes) and out at the neck, to an aspirator. The applied pressure was adjusted until bubbles escaped from the jet at a reasonably slow rate. The jet position was adjusted until the bubbles rose centrally between the plates when no field was applied.

Potentials up to 700 volts were available for application between the electrodes. High tension batteries were used as the source of potential. Contact was only made instantaneously, because at the higher voltages rather more current was taken from the batteries than was desirable. The timing device was employed, the dashes corresponding to $1/400$ sec now being much shorter, the bubbles travelling at velocities which were slow in comparison to those of mercury drops.

It was found that potential gradients of 200 volts per cm. and higher caused visible deflections from the normal vertical path. At 200 volt/cm the deflection was small but it increased regularly with potential gradient as was expected. Although the

undeflected paths were quite straight the deflected ones showed some irregularities. This was probably due to the liquid motion. As drop follows drop in the undeflected path, the liquid between the plates must settle into a steady form of circulation. When a drop is suddenly caused to follow a path deviating from that of former drops, the effect of the liquid on the path will vary at different points, so that this probably explains the slightly wavy line obtained. The drop being light, it is affected by the liquid motion much more than in the case of the heavy mercury drops. This erratic path eliminated the possibility of obtaining a curved path when the velocity in the horizontal direction was still growing. The dashes indicated that the terminal velocities were quickly set up in both directions, as might be expected since the velocities attained (especially in the horizontal direction) were small. Results for the horizontal velocity were obtained by using the mean straight line of the curve, ignoring the short portion during which the horizontal velocity was still growing, at the commencement of passage through the field. A correction was applied for the fact that in their deflected paths the drops did not move so fast in the

vertical direction as they had done in their undeflected paths. If l_{40} is the length of 40 time divisions in the vertical path.

$$\text{Slope of straight line portion} = \tan\theta$$

Distance moved in time corresponding

to a vertical distance of $x = y$

$$y = x \tan\theta$$

$x \tan\theta$ moved in $\frac{x}{l_{40}} \cdot 40$ time divns.

in $\frac{x}{l_{40}} \cdot \frac{1}{10}$ secs.

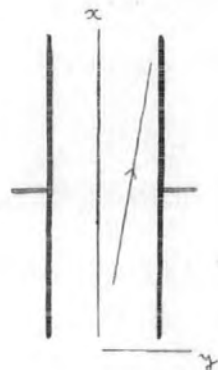

$$\frac{\text{Horizontal Velocity (uncorrected)}}{\text{Velocity (uncorrected)}} = 10 \cdot l_{40} \cdot \tan\theta \text{ cms/sec.}$$

If in the same vertical distance there are n time divns in the undeflected line, and n' divisions in the deflected line. $n' > n$.

$$\text{Corrected Horizontal Velocity} = \frac{n}{n'} \cdot 10 \cdot l_{40} \cdot \tan\theta \text{ cms/sec.}$$

Horizontal Velocity per Unit Potential Gradient.

$$= \frac{10 \cdot \frac{n}{n'} \cdot l_{40} \cdot \tan\theta \cdot d}{V} \text{ cms/sec.}$$

V = Applied Voltage, and d = Plate Distance.

The following table gives the velocities deduced from the series of photographs taken, the corresponding potentials also being shown.

TABLE XLIX.

Photograph Number.	Velocity (corrected).	Plate Distance.	Potential Applied.
504	0.28 cms/sec	0.550 cms	122 v.
502	0.59 cms/sec	0.550 cms	243 v.
500	0.86 cms/sec	0.550 cms	366 v.
501	0.74 cms/sec	0.550 cms	366 v.
506	0.87 cms/sec	0.550 cms	486 v.
505	1.05 cms/sec	0.550 cms	609 v.

The mean slope of this line is:-

$$\text{Velocity/Potential} = 0.20 \times 10^{-2}$$

Velocity/Unit Potential Gradient.

$$= 0.20 \times 10^{-2} \times 0.55$$

$$= \underline{11.0 \times 10^{-4} \text{ cms/sec.}}$$

The velocities involved are small and the motion is probably laminar. In this method it is difficult to estimate the bubble size in order to make certain of the type of fluid motion. The following table gives the velocity in the vertical direction, taken from the undeflected path, for each of the above photographs.

l_{40} is the length equivalent to 40 time divisions, i.e. equivalent to 1/10th second.

TABLE L.

l_{40}	Actual Distance Moved. $l_{40} \times l/M$	Velocity (cms/sec).
38.5	1.26	12.6
38.0	1.24	12.4
39.0	1.23	12.3
39.7	1.25	12.5
39.0	1.24	12.4
39.0	1.24	12.4

For laminar motion, the uplift on the bubble must be equated to the viscous resistance

$$(4/3)\pi a^3 g = 6\pi\mu av_x$$

If the above motion were laminar:-

$$a^2 = \frac{9\mu v}{2g} x$$

$$a = 0.024 \text{ cms taking } \mu = .01$$

Under the conditions of the experiment the bubbles cannot be assumed to be moving in unrestricted liquid.

The effect of the plates would be to cramp the liquid motion and this may be assumed to be equivalent

to an increase in viscosity. This introduces a multiplying factor slightly greater than unity into the right hand side of the above equation. Hence, the value of a may possibly be expected to be slightly greater than 0,024 cms.

This value of the radius was tested approximately as follows. The camera was fitted with a supplementary lens so that as large a magnification as possible was obtained with full extension. It was necessary to stop down the lens to retain sharpness in the image, the depth of focus being very small under these conditions. High speed plates were used and silhouettes of the drops were obtained when they were illuminated from behind by an intense beam of light, and the shortest possible exposure was given. A slight motion in the vertical direction was still apparent on the developed negatives, but the widths of the elongated streaks were fairly definite and gave the magnified drop diameters.

The limiting values of the radius obtained by this method were 0.024 to 0.030 cms. this radius being almost exactly that expected from the velocity, when laminar motion is assumed.

The velocity per unit potential gradient is of

the same order as that obtained by the rotating cell method, although it is somewhat higher than any of the results obtained by Alty. It may perhaps be expected that the charges at these purities of water may largely depend on the nature of the residual impurities that remain, so that it is not surprising that identical results are not obtained.

SUMMARY.

(1). The greater part of the thesis is an account of the ionic charges acquired by droplets of mercury in an electrolyte. In the experiments described first sulphuric acid was used as the electrolyte. Results for the variation of charge with drop size in a solution of fixed concentration show that the charge is proportional to the volume. Results for the variation of the charge with concentration of electrolyte are also given, the charge increasing with concentration, but not in direct proportion. A graph showing the charge at any concentration between .1N and .001N is included.

Experiments using sulphuric acid solutions saturated with mercurous sulphate show that this causes all values of the charges to be reduced (the decrease being most evident in the weaker acid solutions) and seem to afford evidence that, in acid the charges on the drops are due to hydrogen ions, and not mercurous ions as has been assumed by several investigators. Results obtained in several electrolytes other than sulphuric acid are also given. Some results obtained by an entirely different method are included for comparison. In this method the charges were measured by a ballistic galvanometer. The results, though

less accurate, afford good confirmation of those obtained by the original method.

(2) A description is given of some experiments in which amalgam drops were employed in the place of pure mercury. Silver amalgam behaved in a manner very similar to pure mercury, but zinc and cadmium amalgams both showed a curious phenomenon. The drop charges were found to be naturally positive, but their charge could be reversed in sign by application of a sufficiently strong field in the electrolyte. The probable explanation of this effect is discussed. Several results showing charges in various potential gradients, and for amalgams of various compositions are included. Some attention is devoted to the significance of the fact that zinc and cadmium appear to be naturally positive.

(3). A few results with air bubbles in water, the charges on which were deduced in a similar manner, are described. These experiments show the possibilities of the method for cataphoresis experiments.

(4). I wish, in conclusion, to express my sincere thanks to Professor J.E.P. Wagstaff M.A. D.Sc., for his continual help, advice, and encouragement throughout the period of research, and to all others who showed interest in the work.

b. b.

BIBLIOGRAPHY.

- (1). Wagstaff: Phil. Mag. 47. p. 802 (1924)
- (2). Appleyard: Phil. Mag. 43. p. 374 (1897)
- (3). Christiansen: Ann. Phys. 12. p.1072 (1903)
- (4). McTaggart: Phil. Mag. 27. p. 297 (1914)
Phil. Mag. 28. p. 367 (1914)
- (5). Alty: Proc. Roy.Soc.106 p.315 (1924)
Alty & Currie. do. 122 p.622 (1929)
- (6) Palmaer: Zeit.Phys.Chem.36 p.664 (1901)
- (7) Billitzer: Akad.Wiss.Wien.112 pp. 1553,1734 (1903)
- (8) Palmaer: Zeit.Phys.Chem.25 p. 265 (1898)
Zeit.Phys.Chem.28 p. 259 (1899)
Zeit.Elektrochem.7 p. 287 (1900)
Zeit.Elektrochem.9 p. 754 (1903)
Zeit.Phys.Chem. 59 p. 129 (1907)
- (9). Smith and Moss: Phil.Mag. 15 p. 478 (1908)
- (10). Nernst: Zeit.Elektrochem.4.p. 29 (1897)
- (11). Bennewitz and
Delijannis: Zeit Phys.Chem.125 p. 144 (1927)
- (12). Frankin and
Obrutschewka: Zeit.Phys.Chem.138 p.246 (1928)
- (13). Rosenberg and
Stegeman: J. Amer.Chem.Soc.30 p.1306 (1926)
- (14). Bennewitz and
Kuchler: Zeit.Phys.Chem.153 p. 443 (1931)
- (15). Craxford: Phil. Mag. 16. p. 66 (1933)

- (16). Gurney: Ions in Solution. Cambridge. (1936)
- (17). McAulay and Spooner: Proc.Roy.Soc. 138. p. 494 (1932)
- (18). Heyrovsky: Proc.Roy.Soc. 102. p. 628 (1923)
- (19) Bernstein: Zeit.Phys.Chem. 38 p.200 (1901)
- (20). Seth, Anand and Mahajan: Phil. Mag. 7. p. 247 (1929)
- (21). Richards: Amalgams. Carnegie Institution of Washington. (1926)

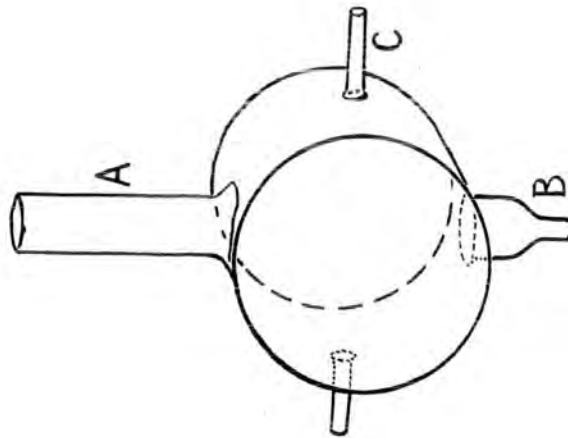

FIG. 1.

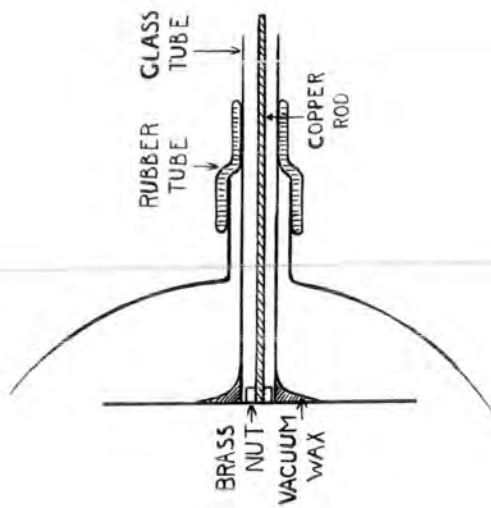

FIG. 2.

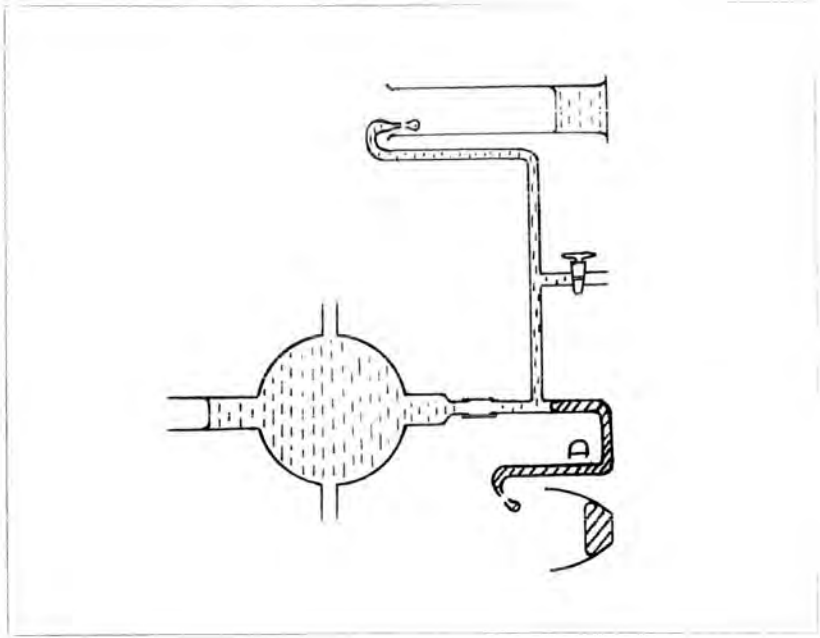

FIG. 3.

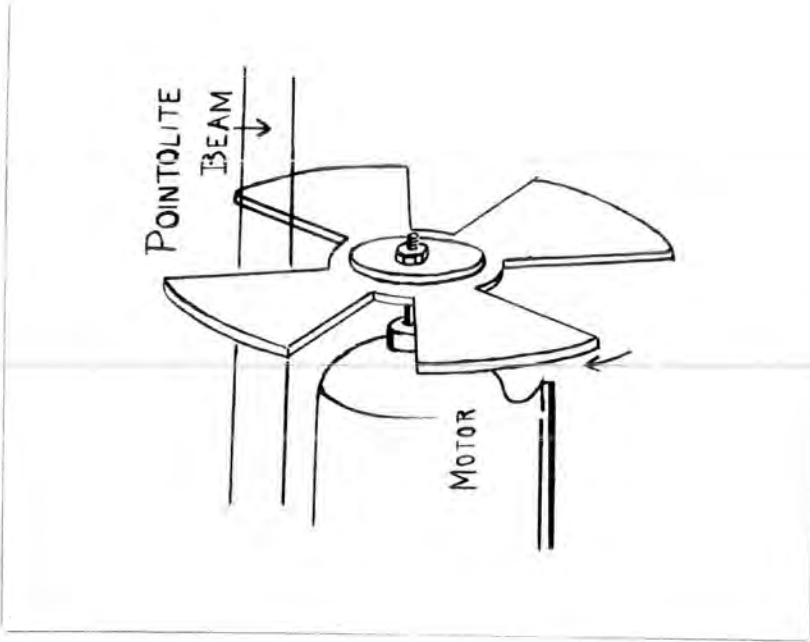

FIG. 4.

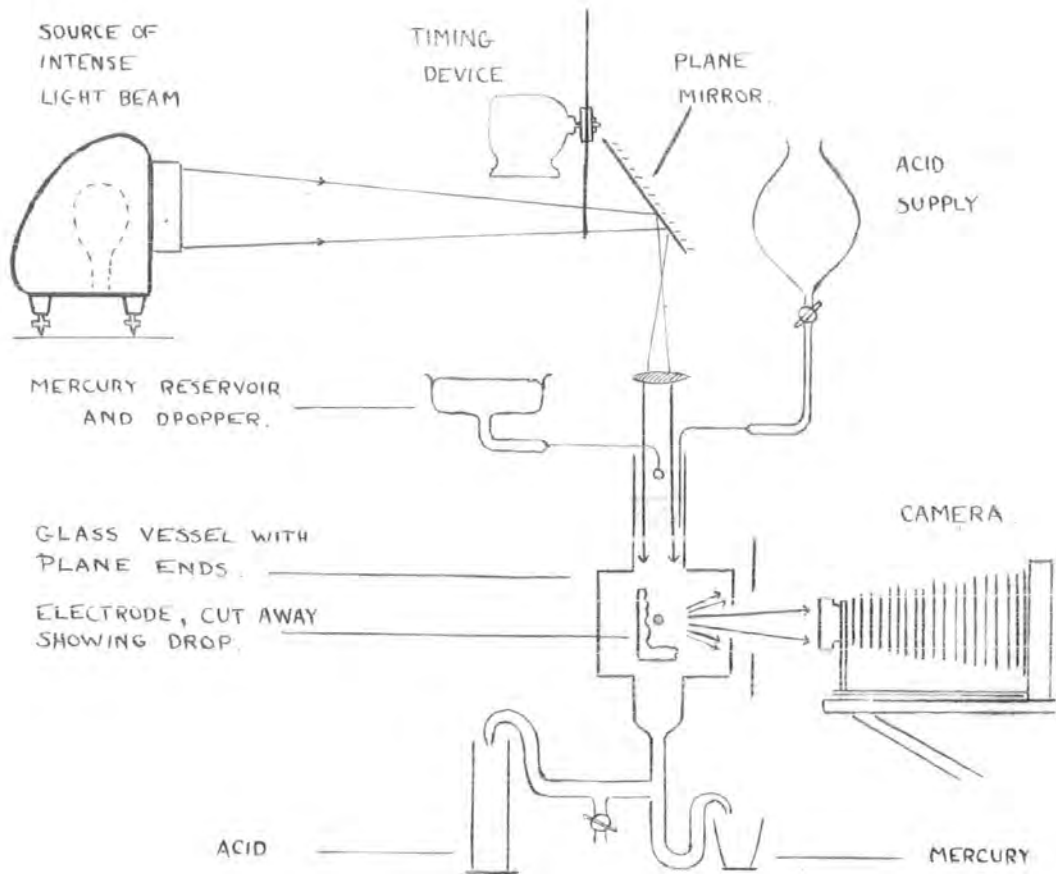

FIG.5

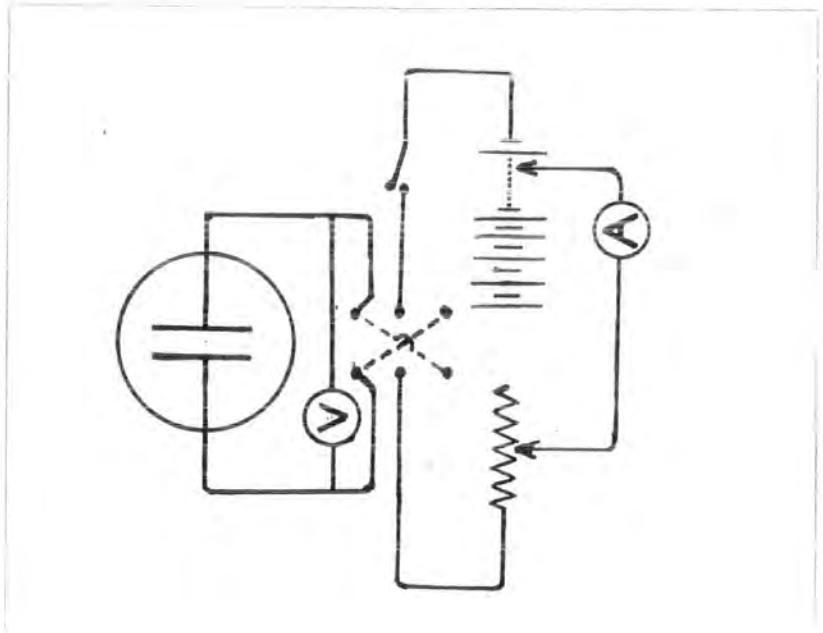

FIG. 6.

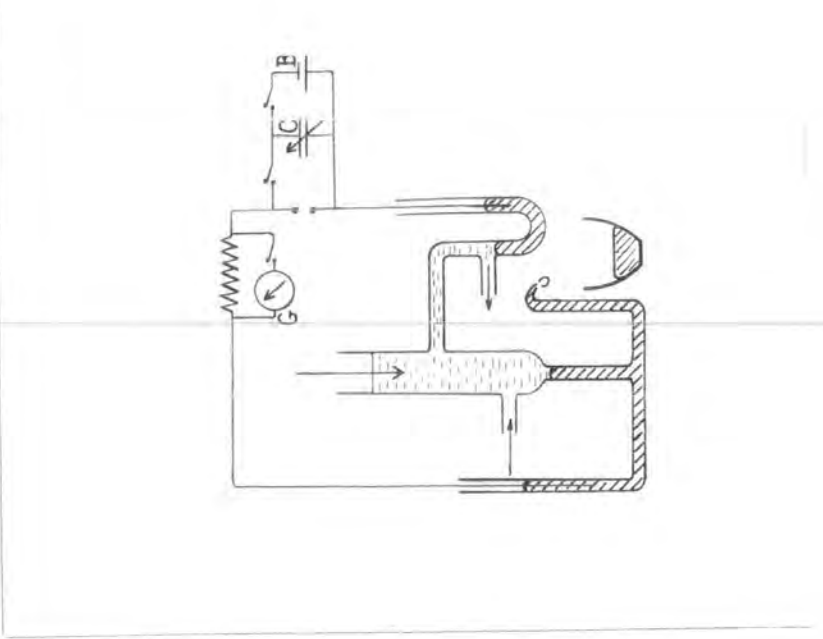

FIG. 7.

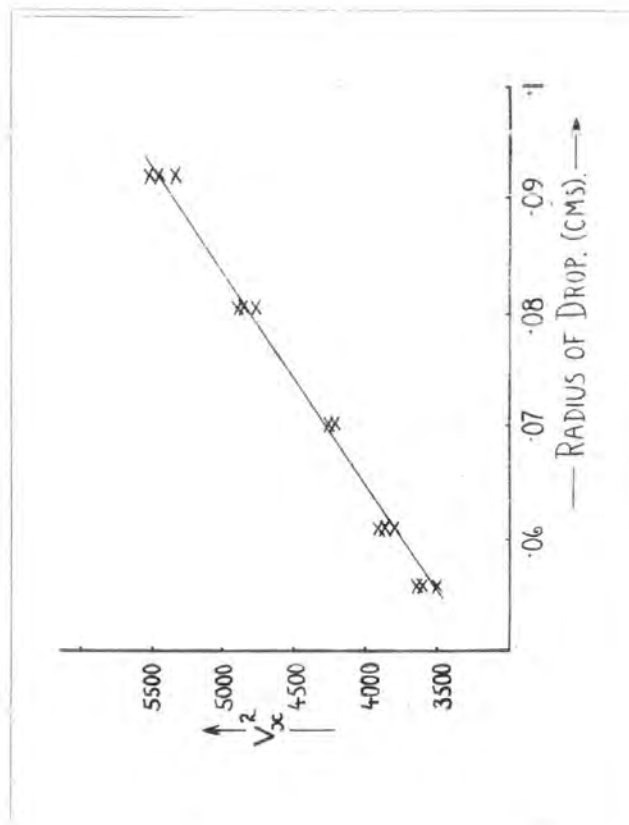

FIG. 8.

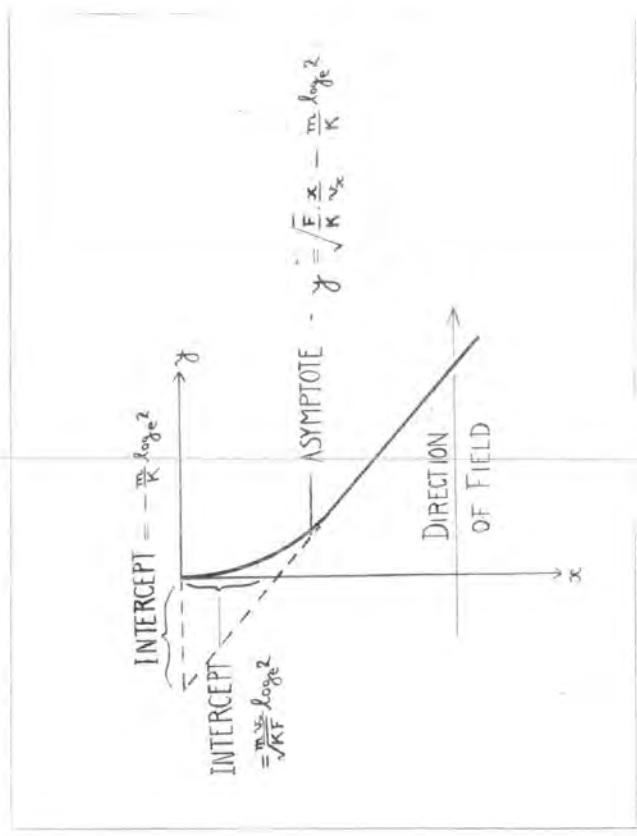

FIG. 9.

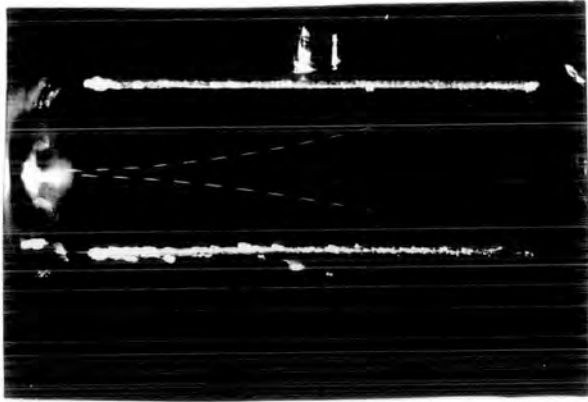

FIG. 12.

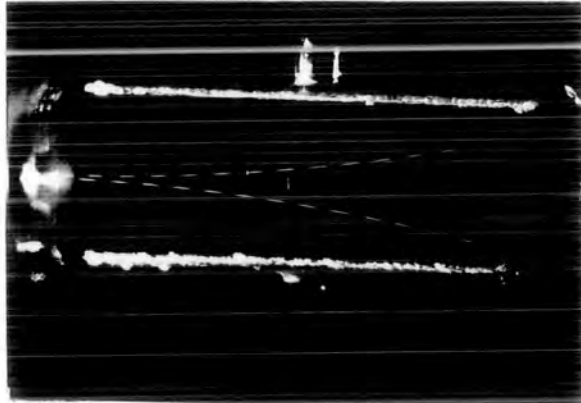

FIG. 11.

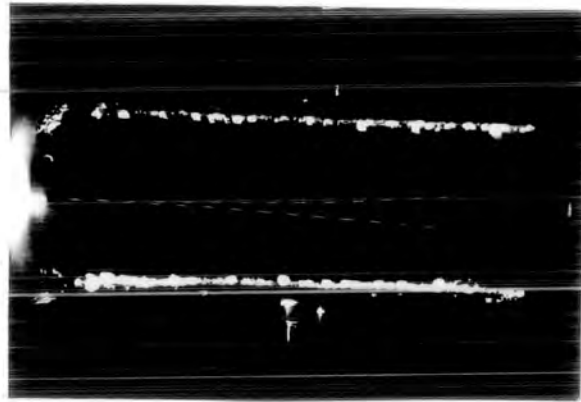

FIG. 10.

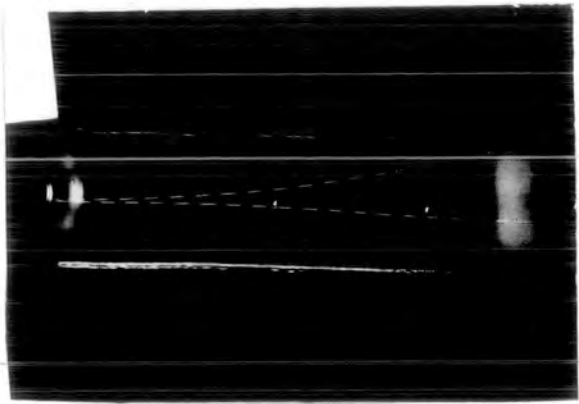

FIG. 15.

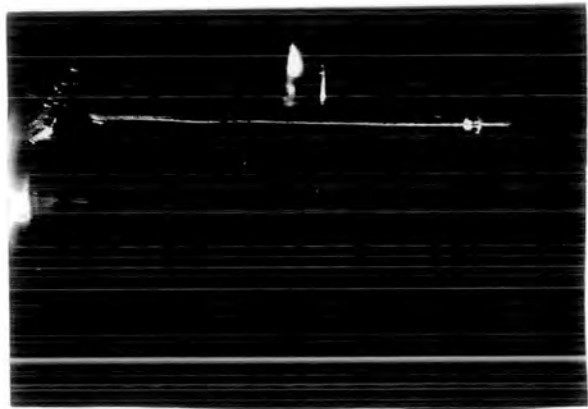

FIG. 14.

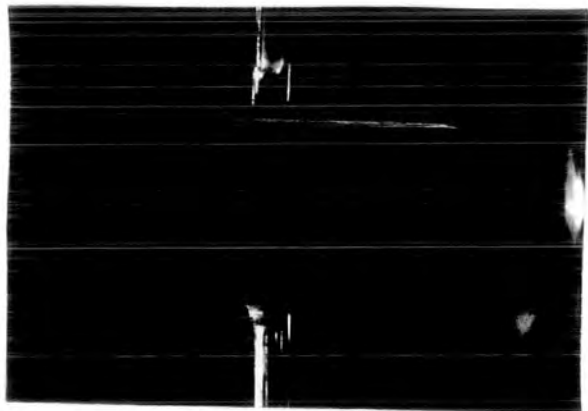

FIG. 13.

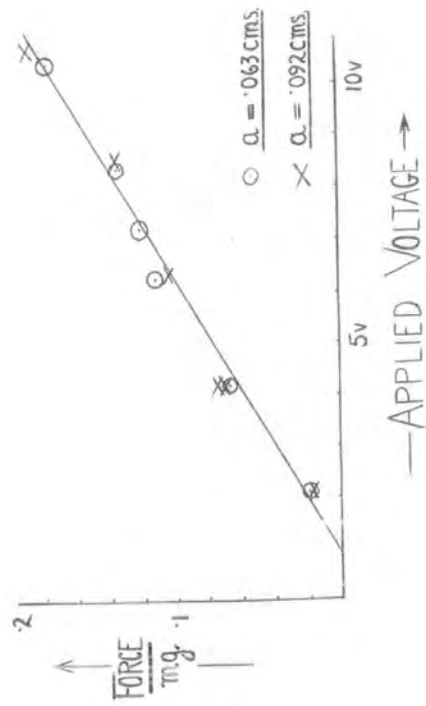

FIG. 16.

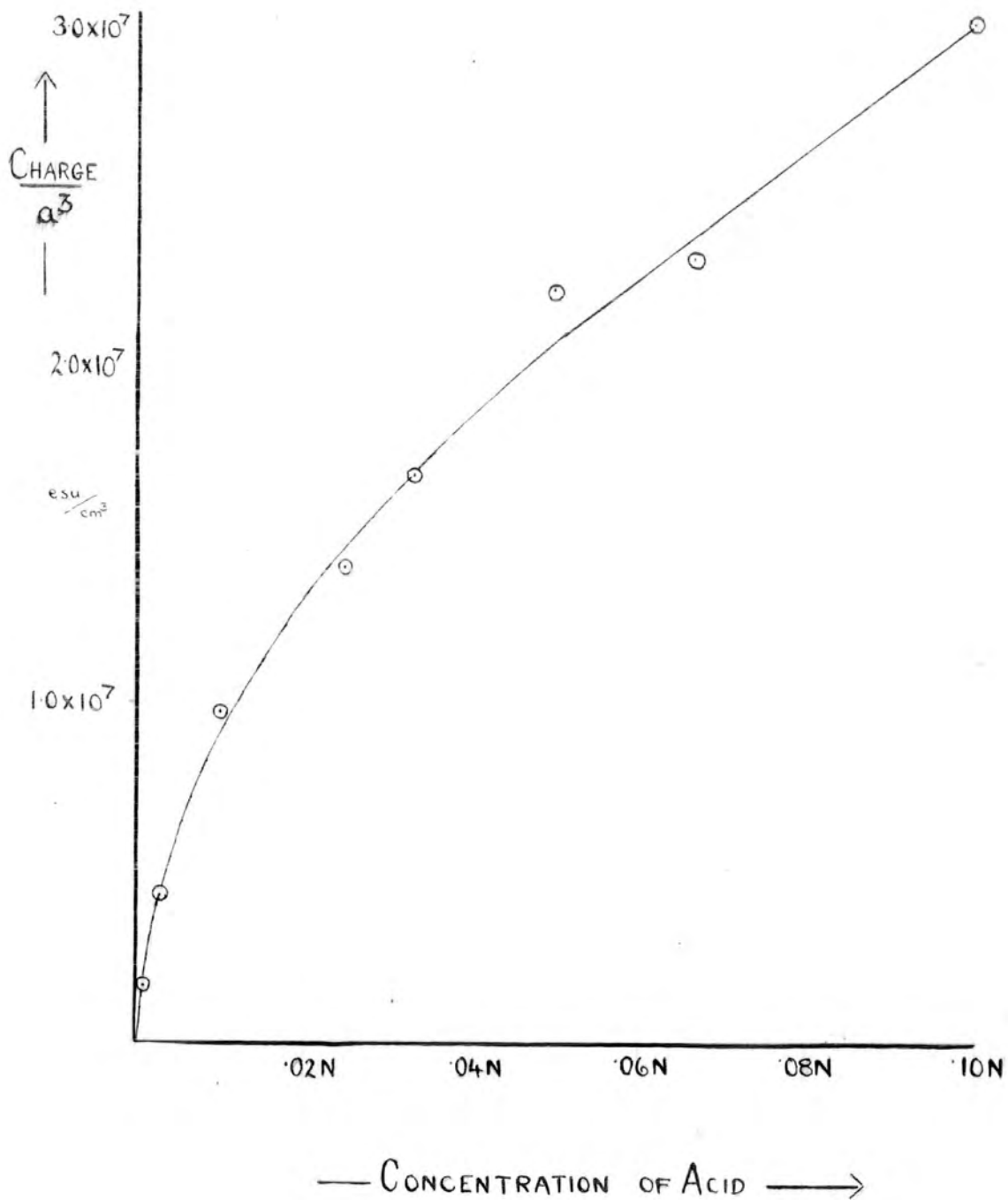

FIG 17.

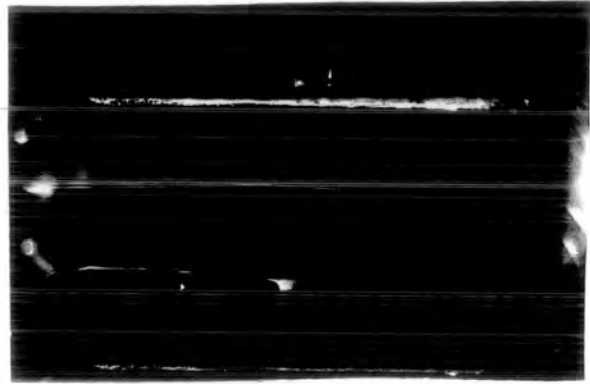

FIG 19

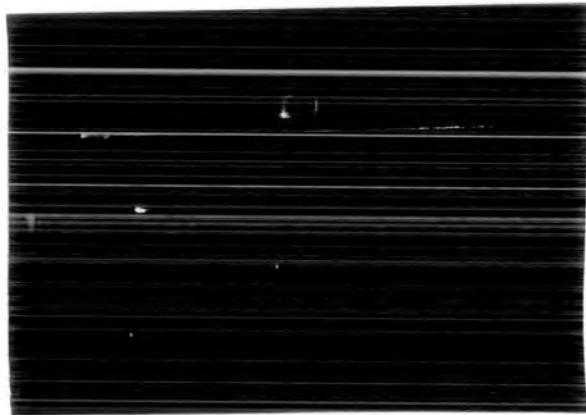

FIG 18.

