

Durham E-Theses

Studies on the Acarina of moorland areas

William C. Block

How to cite:

Block, William C. (1963) Studies on the Acarina of moorland areas. Doctoral thesis, Durham University.

Use policy

The full-text may be used and/or reproduced, and given to third parties in any format or medium, without prior permission or charge, for personal research or study, educational, or not-for-profit purposes provided that:

- a full bibliographic reference is made to the original source
- a <https://etheses.durham.ac.uk/id/eprint/8897/> is made to the metadata record in Durham E-Theses
- the full-text is not changed in any way

The full-text must not be sold in any format or medium without the formal permission of the copyright holders.

Please consult the [full Durham E-Theses policy](#) for further details.

Studies on the Acarina of moorland areas

by

William C. Block, B.Sc.

(St. Cuthbert's Society)

**Being a thesis presented in
candidature for the degree
of Doctor of Philosophy of
the University of Durham,
September, 1963.**



ACKNOWLEDGEMENTS

The writer wishes to thank Professor J. B. Cragg and Dr. J. C. Coulson under whose direction, advice and encouragement this work was carried out. Thanks are due also to Professor D. Barker for continued facilities in the Department of Zoology at Durham.

The taxonomic part of the study could not have been done without the training and help received from Dr. G. Owen Evans (British Museum, Natural History), Dr. D. Macfarlane (Commonwealth Institute of Entomology), Dr. J. Balogh (Institutum Systematico-Zoologicum Universitatis, Budapest) and Mr. T. E. Hughes (Birkbeck College, University of London).

Thanks are also due to Mr. A. Eddy for botanical information of the Moor House Nature Reserve, members of the Department of Zoology at Durham for helpful discussion, and Mr. D. Hutchinson for photographic assistance.

The writer is further indebted to his wife for help in the correction of the manuscript, and to Miss J. Wheatley for typing the final draft.

The Nature Conservancy allowed access to the Moor House National Nature Reserve, and this is gratefully acknowledged. The work was carried out whilst the writer was in receipt of a grant from the East Suffolk County Education Committee for which the writer expresses his sincere thanks.

CONTENTS

	Page
I INTRODUCTION	1.
II THE STUDY AREA	4.
a) Location and physiography	4.
b) Pedology	5.
c) Vegetation	7.
d) Climate	8.
(i) General	8.
(ii) Precipitation and evaporation	9.
(iii) Relative humidity	12.
(iv) Temperature	12.
III THE SAMPLE SITES	14.
a) Habitat factors	14.
1. Soil profile	14.
2. Chemical characteristics	14.
3. Water content of soils	15.
b) Limestone grassland sample site	16.
c) Mixed <u>Calluna</u> moor sample site	22.
d) <u>Juncus squarrosus</u> sample site	23.
e) <u>Nardus stricta</u> grassland sample site	24.
f) The erosion area of Moss Flats	25.
g) Other sample sites	27.

	Page
IV TAXONOMY AND SYSTEMATICS	30.
a) Introduction	30.
b) Classification of the Acarina	31.
c) Identification of the Moor House fauna	32.
(i) Techniques	32.
(ii) Literature	34.
d) Check list and habitats of the Moor House Acarina	35.
V SAMPLING AND EXTRACTION TECHNIQUES	48.
a) Introduction	48.
b) Sampling	50.
1) The size of the sample unit	50.
2) The number of sample units	51.
3) The soil sampler	52.
4) Taking the sample	52.
5) Treatment of the sample	53.
c) Extraction apparatus	54.
d) Sorting process	56.
e) The high gradient extraction process	58.
1. Temperature gradient	58.
2. Humidity	60.
3. Emergence of fauna during extraction	61.
4. Efficiency of high gradient extractor	63.
f) The flotation extractor	65.
g) Comparison of high gradient and flotation extractors	68.

	Page
VI HORIZONTAL DISTRIBUTION	74.
a) Introduction	74.
b) Methods of study and results	76.
(i) The detection of aggregation by the coefficient of dispersion	76.
(ii) The frequency distribution	85.
(iii) The relation between the mean per sample, the variance, and the standard deviation	88.
c) The biological significance of aggregation	89.
VII VERTICAL DISTRIBUTION	91.
a) Introduction	91.
b) Distribution of Acarina in 0-3 cm. and 3-6 cm. soil layers at Moor House	92.
c) Seasonal variation in vertical distribution of Acarina	98.
d) Discussion	100.
VIII SEASONAL VARIATION IN DENSITY OF ACARINA	103.
a) Introduction	103.
b) Sampling and analysis of data	103.
c) Results of monthly samples and comparison with other authors	107.
d) Overwintering mortality	128.

	Page
IX THE FAUNA OF THE ERODING MOOR	132.
a) Introduction	132.
b) The sampling programme	133.
c) Distribution of Acarina	135.
d) Discussion	140.
X THE FAUNA OF DIFFERENT SAMPLING AREAS	144.
a) Introduction	144.
b) Qualitative differences	145.
c) Quantitative differences	150.
(i) Annual differences on the same sampling area	150.
(ii) Differences between sampling areas	157.
d) Comparison of the Moor House fauna with other areas	159.
(i) Qualitative comparison	159.
(ii) Quantitative comparison	163.
XI BIOMASS OF ACARINA	167.
a) Introduction	167.
b) The weights of Acarina obtained in the present study	170.
c) Biomass of Acarina at Moor House	174.
d) Seasonal variation in biomass	176.
e) Comparison with previous studies	177.

	Page
XII LIFE HISTORY STUDIES	180.
a) Introduction	180.
b) <u>Platynothrus peltifer</u> (Koch 1839)	180.
c) <u>Damaeus clavipes</u> (Herm. 1804)	184.
XIII DISCUSSION	190.
The population dynamics of soil Acarina	190.
The role of Acarina in moorland soils	196.
SUMMARY	202.
BIBLIOGRAPHY	206.
APPENDIX I	228.
APPENDIX II	233.

I INTRODUCTION

The micro-arthropod fauna of British uplands has received scant attention from zoologists. This thesis contributes towards filling this gap in our knowledge by providing information on the Acarina or mites of a restricted area in the northern Pennines, namely the Moor House Nature Reserve in Westmorland.

It was decided to investigate the role of Acarina on this area for three main reasons. Firstly; apart from casual collections, very little is known of the mite fauna of upland soils. Secondly; it was hoped that the relative paucity of species associated with such an area would simplify the relationships studied. Thirdly; because such a study would fill a gap, and derive much information from, the more comprehensive study of the fauna of the Nature Reserve (see Cragg, 1961).

The work was executed almost entirely as a field survey, and sampling was carried out between January 1961, and December 1962 inclusive.

The class Arachnida of the phylum Arthropoda is divided into sixteen subclasses, one of which is the Acarina. This is undoubtedly the most heterogeneous subclass of the Arachnida. Members of the Acarina have a false head or capitulum set apart from the rest of the body, which carries



the mouth parts. External segmentation is reduced or absent. The larval stage is normally hexapod, whilst the nymphal and adult stages are octopod. The Acarina are terrestrial or aquatic, and are unique amongst the Arachnida in including plant-eating forms. They are cosmopolitan in distribution, and have a long fossil history commencing in the Devonian.

A detailed classification of the Acarina is given in Section IV. Free-living mites are found in all groups of the Acarina, with the exception of the Metastigmata or Ticks, which are ectoparasitic. Free-living terrestrial mites occur in a great variety of habitats, but they are especially numerous in situations where organic detritus is abundant. The present study is a survey of the free-living Acarina in moorland soils of the Moor House Nature Reserve, with special emphasis on the Cryptostigmata (Oribatei) group.

Extremely high densities of Arthropoda are found in the surface strata of soils, and in the overlying layers of moist decaying organic debris. Almost without exception, the Acarina are the most abundant animals in these communities, both in respect of number of species and numbers of individuals. Saprophagous and mycetophagous mites may well prove to be of great value in the maintenance of soil fertility, by the release of plant nutrients and assisting in the processes of organic decay.

Early work on terrestrial Acarina includes studies by Bornebusch (1930), Baweja (1939), and Ford (1935, 1937 and 1938). More recent publications include those of Forsslund (1945), Weis-Fogh (1948), van der Drift (1950), Delaney (1956), Evans (1951, 1955, 1961), Macfadyen (1952), Murphy (1953, 1955), Sheals (1956, 1957), Haarløv (1960), Dhillon and Gibson (1962), and Davis (1963). This literature on soil faunas deals almost exclusively with mineral soils, and is of interest from the point of view of comparison with the fauna of peat soils.

Information on the Acarina of peat soils, with the single exception of the paper by Macfadyen (1952), occurs only in the continental literature of Dalenius (1950, 1960), Karppinen (1958), and Tarras-Wahlberg (1961). Data is included here on the Acarina of the mull soil of the Limestone Grassland and the peat soil of the Calluna moor on the Moor House Reserve.

Records of the Acarina fauna of northern England exist in the publications of Michael (1883, 1887), Hull (1914, 1916, 1918, 1925), and Seyd (1962). These deal with both the taxonomy and the ecology of the species recorded.

In this thesis botanical nomenclature follows Clapham, Tutin and Warburg (1952) for higher plants; Watson (1953) for lichens; and Watson (1955) for mosses. Pedological terms are those used by Johnson and Dunham (1963).

II THE STUDY AREA

a) Location and Physiography :

The Moor House National Nature Reserve, N.R.80, in the northern Pennines is situated 11 miles (17.6 km.) south of Alston, and 12 miles (14.2 km.) east of Penrith, Cumberland. The Reserve lies in Westmorland, with the National Grid Reference: 35/758329.

The greater part of the Reserve's 10,000 acres (4,000 hectares) is over 1,800 ft.O.D. (549 m.). It includes the western scarp and eastern dip slopes of fells which are typical of the northern Pennines. The fells reach their highest point on Cross Fell (2,930 ft.; 893 m.), which lies just north of the Reserve boundary. Great Dun Fell (2,780 ft.; 845 m.), Little Dun Fell (2,761 ft.; 842 m.) and Knock Fell (2,604 ft.; 794 m.) lie within the Reserve.

The entire area is heavily dissected by streams, which feed the River Eden to the west, and the River Tees and its main tributaries, Troutbeck, Moss Burn and Force Burn to the east. Fig. 1. is a map of the Nature Reserve with the sample sites indicated, which are referred to below.

The whole area is covered by blanket bog, and is part of a typical Grousemoor which is grazed by sheep throughout the summer. The Reserve supports about one sheep per acre at the present time. General descriptions of the Reserve

Fig. 1.

Map of the Moor House National Nature Reserve, Westmorland.
The sample sites are indicated by numbers on the map, and a
key is provided. Scale 1:25000.

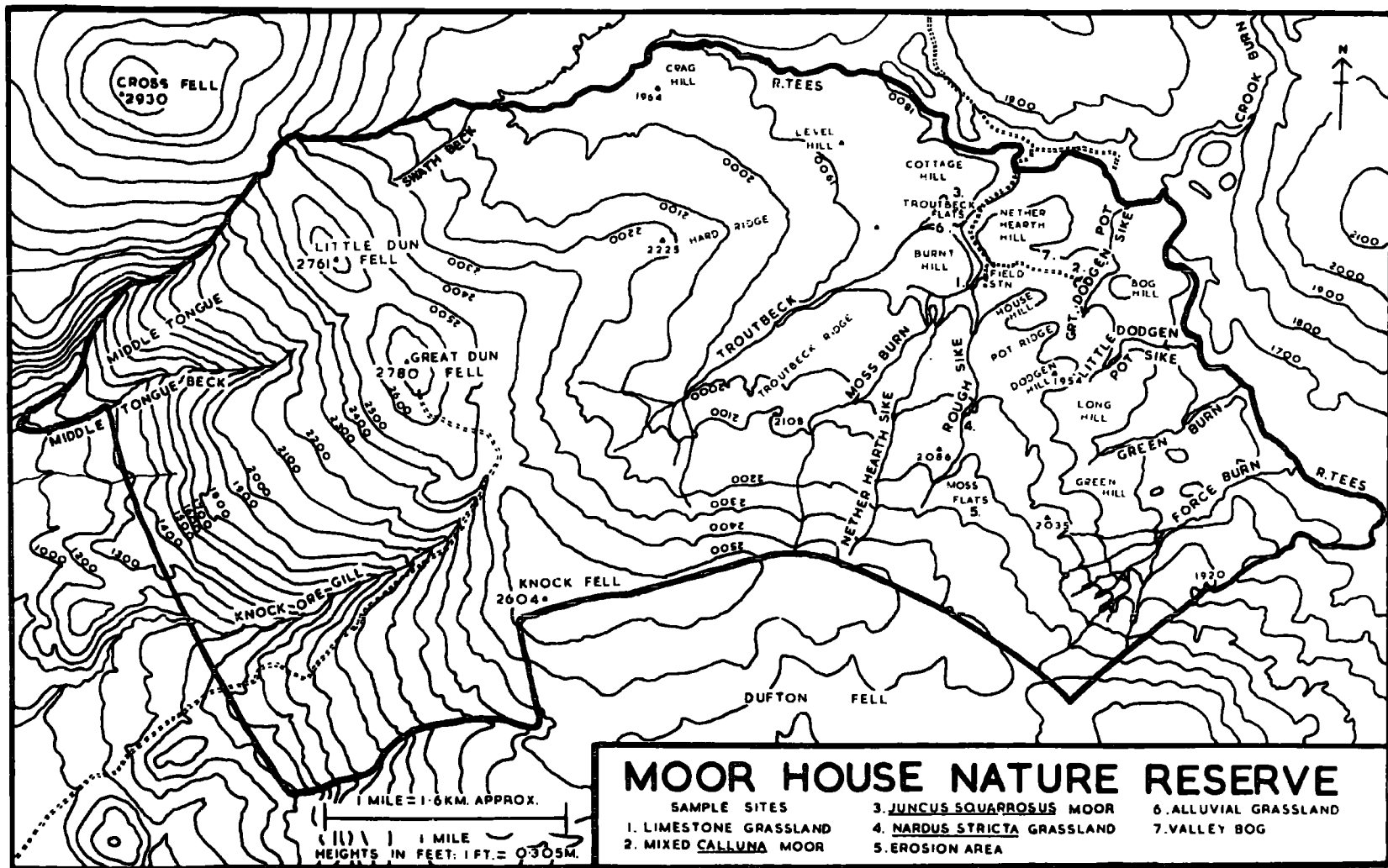

FIG. 1.

are given by Conway (1955), Nicholson (1957), and Cragg (1961).

b) Pedology :

The Carboniferous Yoredale Series consisting of successive strata of sandstones, shales and limestones form the bed rocks underlying the Reserve (see Dunham, 1948; Johnson and Dunham, 1963). These rocks are covered by glacial drift, boulder clays and solifluxion products over the greater part of the study area. Mineral soils are confined to the fell tops, limestone and sandstone outcrops, and stream sides.

The soils of the Reserve belong to several major soil divisions including gleys, podzols, brown earths and organic soils together with skeletal soils of different types. The high rainfall (average 76 in.; 194 mm. per annum) and the low average temperature (55°F; 12.8°C in summer; and 29°F; -1.7°C in winter) favours the formation of peat. Weathering of parent rock and the production of a soil parent material is relatively fast under these extreme climatic conditions, but the formation of a soil profile requiring both chemical and biotic factors is slow, because of the low average temperature. Immature and skeletal soils are thus formed at Moor House.

Johnson and Dunham (1963) classify the Moor House soils broadly into six groups :

1. Gley soils : - Developed under waterlogged conditions, grey or greenish in colour and often with secondary ochreous

mottling in the mineral horizons; e. g. Middle Tongue on the western escarpment.

2. Podzol group : - Well drained soils with strongly differentiated mineral horizons. The B horizon in these soils is uniformly coloured; e.g. The Fell top podzol on Great Dun Fell summit.

3. Brown Earth group : - Well drained soils in which the horizons merge into one another, and with a uniformly coloured B horizon; e.g. Rough Sike enclosure, and House Field.

4. Organic soils : - These are formed under waterlogged conditions on strongly gleyed mineral soils. Peat deposits over 1 ft. (30.5 cm.) were mapped as organic soils by Johnson and Dunham. Two types of organic soils occur on the Reserve :

(i) Blanket peat is developed on convex slopes and level ground dependent upon acidity, low summer temperature and waterlogging of the ground surface. This is the major soil type of the Reserve, averaging 6-7 ft. (1.8-2.1 m.) in thickness with a maximum of 13 ft. (4.0 m.) on level ground; e.g. Dodgen Pot, and Bog Hill.

(ii) Concave relief gives rise to basin peat deposits with the aid of ground water; e.g. Upper Valley Bog contains up to 29.5 ft. (9 m.) of fen and bog peat.

5. Skeletal soils : - Thin soils derived from physically

weathered material whose character depends upon the parent rock. In some localities, e.g. the area east of Knock Fell summit, the parent rock is a scree of sandstone, limestone or mixed rocks on a steep slope.

6. Soil Complexes : - Areas where changes of soil type take place rapidly and repeatedly due to relief and erosion. The constituents include skeletal, colluvial and alluvial soils, e.g. the eroded blanket peat soil complex of Moss Flats, and the stream side soils along Rough Sike.

c) Vegetation :

A general account of moorland and bog vegetation is given by Pearsall (1950). The Reserve was included by Lewis (1904) in a botanical survey of the northern Pennines. The area can be divided into four main vegetation types, which tend to merge into one another.

1. High fell slopes from which the peat deposits have been completely eroded. These areas are covered by an arctic or sub-arctic vegetation of mosses, lichens, grasses and Vaccinium, e.g. Great Dun Fell.

2. The bulk of the Reserve is covered by blanket peat up to 9 ft. (3 m.) in depth. This can be divided into two main types:-

a) Areas of peat erosion, characterised by extensive peat hags with Calluna, Cladonia, Eriophorum angustifolium

and E. vaginatum, e.g. Moss Flats.

b) Areas of actively growing bog, characterised by Sphagnum and Eriophorum vaginatum, and a reduction in the amount of Calluna; e.g. Upper Valley Bog.

3. Areas of shallow peat at the edge of the moor where Juncus squarrosus is dominant, and Festuca ovina and Agrostis tenuis occur; e.g. Dodgen Pot Juncus site.

4. Areas with a mineral soil on rock outcrops (e.g. Limestone grassland site) and alluvial terraces (e.g. Nardus site). Grasses and mosses form the dominant vegetation, except on the limestone outcrops where a rich calcicole flora develops.

A detailed description of the vegetation of the sample sites is given below in Section III.

d) Climate :

(i) General :- Manley (1952) has described the climate of Moor House as being sub-arctic, corresponding to that at sea-level in southern Iceland. The climate is characteristically cold and wet. Pearsall (1950) has shown that it is typical of the montane zone of Great Britain. Regular meteorological data has been collected since 1952, when a weather station was established on the Reserve at an altitude of 1,840 ft. O.D. (561 m.).

Further information on the climate of Moor House exists

in the literature (Manley, 1936, 1943; Green 1958, 1959). Records of the meteorological observations for Great Dun Fell (2,780 ft. O.D.; 845 m.) are available in Manley (1942). Table 1 summarises the general climatic data for 1961 and 1962 for comparison with the mean values for 1953-62 and the estimated mean for 1906-35 given by Manley (1943).

(ii) Precipitation and Evaporation :- In Britain an annual rainfall of 50-55 inches (127-140 cm.), about three times the evaporation figure, provides favourable conditions for bog formation and growth (Pearsall, 1950). Moor House has an annual rainfall of over 70 inches (178 cm.), see Table 1, and good conditions for bog growth. The potential evaporation at Moor House has been measured by an evapotranspirometer or percolation gauge from 1957 onwards. Table 2 shows the precipitation, potential evaporation and P/E ratios during the period 1961 and 1962, which can be compared to the last 10 years' (1953-62) data in Table 1.

The rainfall in both the study years (78.4 inches in 1961 and 77.0 inches in 1962) was in excess of the mean for the last 10 years (74.8 inches). The potential evaporation (15.6 inches in 1961, and 15.3 inches in 1962) is low compared with the 7 year mean of 17.2 inches shown in Table 1. The wettest month was January with rainfall of 10.1 inches in 1961 and 15.8 inches in 1962, and the driest month was June with rainfall of 3.3 inches in 1961 and

Table 1. Summary of the meteorological data for Moor House, 1906-35, 1953-62, 1961-62.

	<u>1961</u>	<u>1962</u>	<u>Ten year mean 1953-62</u>	<u>Manley's estimated mean 1906-35</u>
Annual rainfall (inches)	78.4	77.0	74.8	70.0
Number of days on which rain fell	241	251	245	-
Potential evaporation (inches)	15.6	15.3	17.2 (1957-62)	-
Mean maximum daily temperature (°F)	47.5	45.5	47.5	46.9
Mean minimum daily temperature (°F)	36.4	33.9	35.5	31.1
Mean daily temperature (°F)	41.9	39.7	40.9	41.5
Lowest grass minimum temperature (°F)	5.0	1.0	1.0	-
Snow cover (days)	55	79	58	80
Ground frost (days)	153	205	162	-
Average daily sunshine (hours)	2.8	2.9	3.2	-
Average relative humidity at 0900 hr. G.M.T. (%)	89.8	89.9	88.9	-
Average earth temperature at 1ft. at 0900 hr. G.M.T. (°F)	43.4	41.9	44.0	-

Data for 1961, 1962 and the period 1953-62 from the Meteorological Summaries for Moor House.

Estimated mean for 1906-35 given by Manley (1943) was based on 10 year's records and comparisons with lowland stations at Newton Rigg and Durham.

Table 2. Monthly precipitation, potential evaporation and P/E ratios (inches) for Moor House, 1961 and 1962

<u>Month</u>	<u>1961</u>			<u>1962</u>		
	Precipitation	Potential evaporation	P/E Ratio	Precipitation	Potential evaporation	P/E Ratio
Jan.	10.1	(1.0)	10.1	15.8	(0.2)	78.0
Feb.	6.7	(0.5)	13.4	5.6	(0.6)	9.3
Mar.	4.9	(2.1)	2.3	2.3	(1.0)	2.3
April	4.6	1.5	3.1	7.3	(1.5)	4.9
May	3.5	2.5	1.4	5.4	2.5	2.2
June	3.3	2.2	1.5	3.1	(2.9)	1.1
July	7.6	2.2	3.4	4.5	(2.0)	2.2
Aug.	8.7	1.5	5.8	10.9	1.8	6.0
Sept.	5.1	1.5	3.4	6.9	1.0	6.9
Oct.	11.4	(0.5)	22.8	3.6	0.9	4.0
Nov.	6.2	(-0.2)	31.0	4.0	0.6	6.7
Dec.	6.1	(0.3)	20.3	7.5	0.3	25.0
Year	78.4	15.6	5.0	77.0	15.3	5.0

() : Brackets indicate that the records are incomplete for the whole month.

Data from the Meteorological Summaries for Moor House, 1961 and 1962.

3.1 inches in 1962 during the study period. The potential evaporation was greatest in June 1961 and 1962 with values of 2.2 and 2.9 inches respectively. The monthly evaporation figures did not exceed the monthly precipitation figures at any time during the two-year study.

(iii) Relative Humidity :- High values of relative humidity were recorded at Moor House as expected from the precipitation figures in Table 2. The annual average relative humidity at Moor House was 89 per cent for both the years of study, and for the last ten years (see Table 2); compared with the annual average at sea-level of 80 per cent according to Manley (1952). Since these values were measured at 0900 hr. G.M.T. at Moor House, they are of little biological significance.

(iv) Temperature:- The monthly mean maximum and minimum air temperatures for Moor House during 1961 and 1962 are shown in Fig. 2, with the growing period for plants indicated (temperature above a mean daily value of 42°F : 5.6°C).

It has been observed (Manley, 1952) that the growth of plants begins and continues whenever the mean temperature exceeds approximately 42°F . (: 5.6°C) in western Europe as a whole. A mean daily temperature of 42°F (: 5.6°C) ensures that the night minimum remains above freezing point (32°F ; 0°C), and growth of plants is promoted. At Moor House the average growing season (see Fig. 2) extended from the

Fig. 2.

Monthly mean maximum and minimum air temperatures (screen) at Moor House for 1961 and 1962. The data are taken from the Moor House Meteorological Summaries for 1961 and 1962. The length of the plant growing season is indicated (air temperature above a mean daily value of 42°F : 5.6°C .).

MONTHLY MEAN MAXIMUM AND MINIMUM TEMPERATURES AT MOORHOUSE

Fig.2.

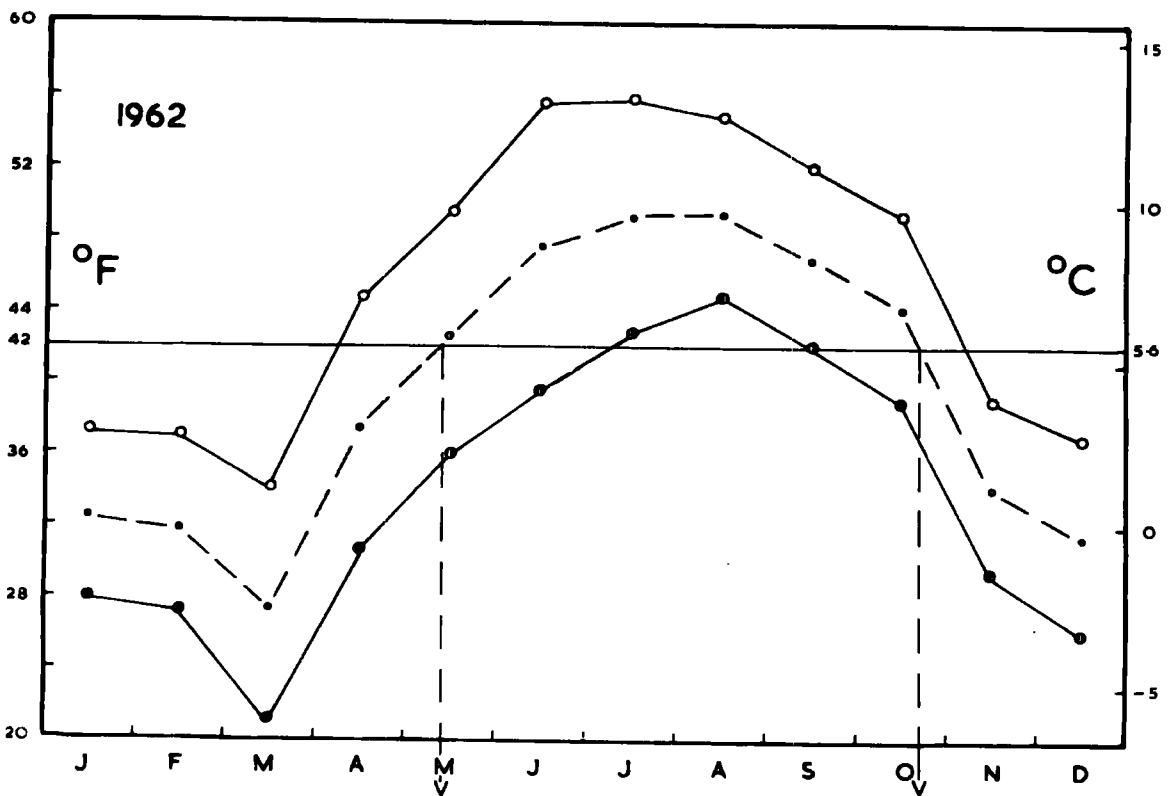
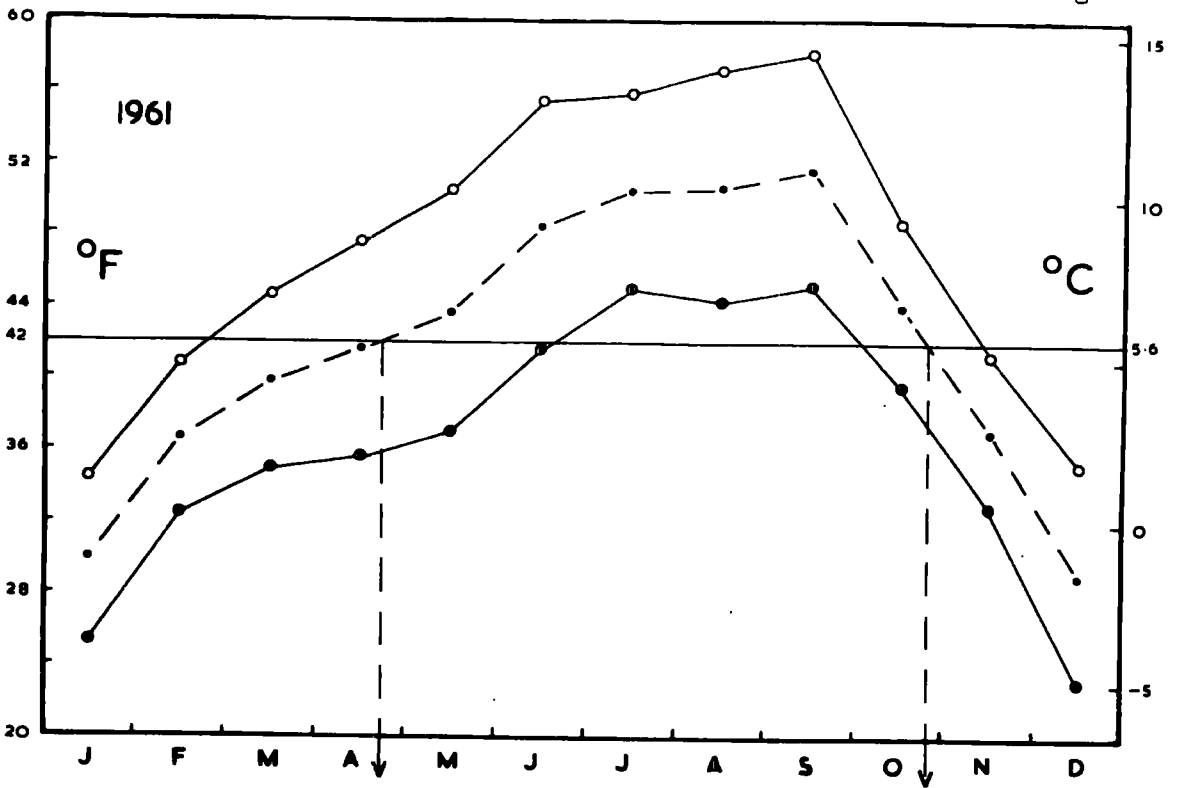

beginning of April to the end of October in 1961, and from the end of April to the end of October in 1962.

The coldest months in 1961 were January and December with mean air temperatures of 29.9°F ($: -1.2^{\circ}\text{C}$), and 29.1°F ($: -1.6^{\circ}\text{C}$) respectively. In 1962, March was the coldest month with a mean air temperature of 27.5°F ($: -2.5^{\circ}\text{C}$). The highest mean air temperatures were recorded in September and August in 1961 and 1962 respectively : 51.7°F ($: 10.9^{\circ}\text{C}$) and 49.5°F ($: 9.7^{\circ}\text{C}$). The annual range of monthly means of air temperature is therefore 22°F .

III THE SAMPLE SITES

Sample sites characteristic of distinctive vegetative and soil types were selected for study. Six sites were chosen at Moor House, ranging from mineral soil to the organic soil of the blanket peat.

a) Habitat Factors:

1. Soil Profile:- Profiles for each of the five sample sites are given in Appendix I.

2. Chemical Characteristics:- The main chemical features of the sample sites are shown in Table 4.

Table 4. Chemical characteristics of the Moor House sample sites. (From Banage, 1960; following Pearsall, 1950).

Index	Limestone Grassland	<u>Nardus</u> Grassland	<u>Juncus</u> <u>squarrosus</u> moor	Mixed <u>Calluna</u> moor	Erosion Area (Bare peat)
pH	5.8-5.0	5.0-4.8	4.7-4.4	5.0-4.4	4.6-4.3
Percentage Organic Carbon	3.2-7.4	7.5-16.3	27.0-30.0	30.9-35.1	35.9-38.3
Percentage Nitrogen	0.44-0.98	0.45-0.98	2.05-2.31	2.02-2.38	1.12-1.33
C/N Ratio	6-8	14-18	12-15	14-17	28-34
Soil Mois- ture (Index of Humidity)	<1.6	<1.8	<7.0	<10.0	<7.0

The Carbon/Nitrogen ratio of the Nardus grassland and the Juncus moor are not markedly different. Taking into consideration the very much lower organic content of Nardus grassland, Cragg (1961) has placed the sites in the following

order of biological activity:

Limestone Grassland > Nardus Grassland > Juncus squarrosus moor > Mixed Calluna moor > Bare Peat of Erosion Area

3. Water Content of Soils:- Crump (1913) stated that the 'Relative Humidity' of peat soils depends upon the humus content, and used the ratio water/humus as a measure of this factor. This ratio was used also by Pearsall (1950) for peat soils. Banage (1960) proposed the use of the term 'Index of Humidity' for the ratio water/dry weight of soil. The dry weight of peat soil is not equivalent to the humus content and these ratios are not strictly comparable. In the present study the soil water content of the peat and mineral soils is expressed as 'Index of Humidity' of Banage (1960). The Index of Humidity gave a good picture of the water status of the Moor House soils, when used in conjunction with pH to fit the sample sites into the classification of upland soils proposed by Pearsall (1950).

N.B. An Index of Humidity of 1 is equivalent to 50 per cent soil water content, of 2 to 67 per cent water content, and 3 to 75 per cent water content, etc.

Measurements of soil water content were made on all sample units collected during the study period 1961-62. The 15 sample units from each sample site were weighed in bulk before the extraction of the Acarina to obtain the wet weight. After extraction, the 15 sample units were air-dried

at a temperature of 105°C., and reweighed to a constant weight. The soil water content data for the five sample sites at Moor House are given in Tables 5, 6, 7, 8 and 9. The mineral soils are relatively well drained, but the organic peats are subject to waterlogging, and because of this few micro-arthropods are found below 3 cm. depth in the latter soils. The organic soils are better drained on the erosion area studied, as is shown in Table 9. Uneroded moor has a greater water storage capacity per unit surface area than an eroded catchment area. Data on this subject from Moor House has been given in Conway and Miller (1960).

b) Limestone Grassland Sample Site:

Situated close to the Moor House Field Station at 1850 ft. (564 m.) between Rough Sike and Moss Burn (see Fig. 1.), the site has a Brown Earth soil type. The soil depth rarely exceeds 50 cm. and has a bedrock of the Tyne Bottom Limestone, and has a high pH of 5.0-5.8 by moorland standards (see Table 4.). The site is on a north-west facing slope with good drainage. As a result, the soil is well aerated, both earthworms and moles being present, and arthropods may be found throughout the soil profile. The site is a typical Festuca-Agrostis upland grassland (Pearsall, 1950), and is subjected to heavy grazing by sheep during the summer months. Plate 1 is a general view of the area. The vegetation-humus mat is approximately 3 cm. thick, and during sampling

Plate 1.

The Limestone grassland site. The view is looking west with Moss Burn situated to the right. Scale x 1/30.



Table 5. Soil water content of samples from Limestone Grassland. The figures are indices of humidity and are the means of 15 sample units per sample date.

<u>Date</u>	<u>0-3 cm.</u>	<u>3-6 cm.</u>
16.1.61.	1.8	1.0
13.2.61.	1.3	0.9
13.3.61.	1.7	0.6
10.4.61.	1.6	1.0
8.5.61.	1.7	1.1
5.6.61.	0.6	0.5
16.7.61.	1.4	0.9
28.8.61.	1.4	1.0
25.9.61.	1.4	1.0
23.10.61.	1.9	1.2
22.11.61.	1.7	1.1
11.12.61.	1.9	1.1
15.1.62.	2.1	*
13.2.62.	1.3	1.1
20.3.62.	2.1	*
3.4.62.	1.7	1.1
3.5.62.	1.1	0.8
4.6.62.	1.0	0.8
3.7.62.	1.4	1.1
7.8.62.	1.8	1.1
1.9.62.	1.5	1.0
3.10.62.	2.0	1.1
12.11.62.	1.9	1.1
6.12.62.	1.1	1.1

* indicates ground frozen below 3 cm. depth.

Table 6. Soil water content of samples from Mixed moor.
The figures are indices of humidity and are the means of 15 sample units per sample date.

<u>Date</u>	<u>0-3 cm.</u>	<u>3-6 cm.</u>
23.1.61.	7.4	-
20.2.61.	9.2	-
18.3.61.	6.5	-
18.4.61.	8.3	-
15.5.61.	7.7	-
5.6.61.	5.7	-
16.7.61.	8.9	-
28.8.61.	7.5	-
25.9.61.	9.4	-
23.10.61.	9.3	-
22.11.61.	7.1	-
11.12.61.	8.9	-
15.1.62.	9.4	-
13.2.62.	6.8	8.9
20.3.62.	6.2	-
3.4.62.	9.8	8.8
3.5.62.	6.1	-
4.6.62.	8.6	10.0
3.7.62.	9.7	-
7.8.62.	11.3	8.4
1.9.62.	9.5	-
3.10.62.	9.4	9.1
12.11.62.	9.2	-
6.12.62.	11.8	9.1

- indicates that no samples were taken.

Table 7. Soil water content of samples from Juncus squarrosus moor. The figures are indices of humidity and are the means of 15 sample units per sample date.

<u>Date</u>	<u>0-3 cm.</u>	<u>3-6 cm.</u>
20.2.61.	5.8	5.1
15.5.61.	5.5	-
28.8.61.	6.6	-
11.12.61.	7.5	-

- indicates that no samples were taken.

Table 8. Soil water content of samples from Nardus stricta grassland. The figures are indices of humidity and are the means of 15 sample units per sample date.

<u>Date</u>	<u>0-3 cm.</u>	<u>3-6 cm.</u>
30.1.62.	4.0	1.5
3.5.62.	2.4	2.1
3.7.62.	1.8	1.3
3.10.62.	2.7	1.4

Table 9. Soil water content of samples from habitats on the erosion area of Moss Flats.

The figures are indices of humidity and are the means of 15 sample units each 3 cm. in depth, except for Eriophorum vaginatum where the figures are the means of 8 sample units.

<u>Date</u>	<u>Hummock top</u>	<u>Hag lip</u>	<u>Eriophorum angustifolium</u>	<u>Eriophorum vaginatum</u>
27.2.61.	3.6	2.5	4.4	3.9
29.5.61.	1.0	1.1	3.6	3.7
5.9.61.	3.3	1.7	4.3	3.3
4.12.61.	3.4	2.9	5.7	8.2

this is separated from the soil proper. The vegetation of the Limestone Grassland site is as follows (Eddy, 1962; pers. comm.) :

Dominant.	<u>Festuca ovina</u>
	<u>Agrostis tenuis</u>
Abundant.	<u>Agrostis canina</u>
	<u>Thymus drucei</u>
	<u>Polytrichum commune</u>
	<u>Potentilla repens</u>
Others.	<u>Selaginella selaginoides</u>
	<u>Anthoxanthum odoratum</u>
	<u>Galium hercynicum</u>
	<u>Euphrasia confusa</u>
	<u>Rumex acetosella</u>
	<u>Luzula campestris</u>
	<u>Achillea millefolium</u>
	<u>Carex caryophylla</u>
	<u>Veronica officinalis</u>
	<u>Cirsium arvense</u>
	<u>Cerastium vulgatum</u>
	<u>Cardamine pratense</u>
	<u>Prunella vulgaris</u>
	<u>Viola riviniana</u>
	<u>Viola lutea</u>
	<u>Alchemilla vestita</u>

Mosses

Racomitrium lanuginosumMnium undulatumMnium punctatum

A rich bryophyte flora is present around the protruding limestone boulders on the site, but these species are not included in the above list. (see Plate 2).

As might be expected there was greater fluctuation in the soil water content in the upper 3 cm. layer of soil during the two year study period (I.H.:0.64-2.15), than in the lower 4-6 cm. layer (I.H.:0.51-1.17). The driest soil samples were taken on 5 June 1961 and 4 June 1962; and the wettest on 11 December 1961 and 15 January 1962 (see Table 5).

c) Mixed Calluna moor sample site :

The area of mixed Calluna moor selected for study was situated to the north-west of Great Dodgen Pot Sike, and called Dodgen Pot, (see Fig. 1). The site has an elevation of 1840 ft. (561 m.). The blanket peat which covers the area has a pH of 4.4-5.0 and overlies a gleyed mineral soil. The site has typical blanket bog vegetation (Plate 3) except that the Sphagnum cover is reduced, compared with other areas of mixed moor, e.g. Nether Hearth. This is due to the lower level of the water table on the sample site.

In the upper 3 cm. layer in 1961 the soil water content varied from an Index of Humidity of 5.7 on 5 June 1961 to

Plate 2.

a) The vegetation of the Limestone grassland; a typical Festuca ovina/Agrostis tenuis upland grassland with Thymus drucei in flower. Scale x 1/2.

b) A boulder of Tyne bottom limestone outcropping on the Limestone grassland site; with Cladonia sylvatica and Rhacomitrium lanuginosum in the foreground. Scale x 1/3.

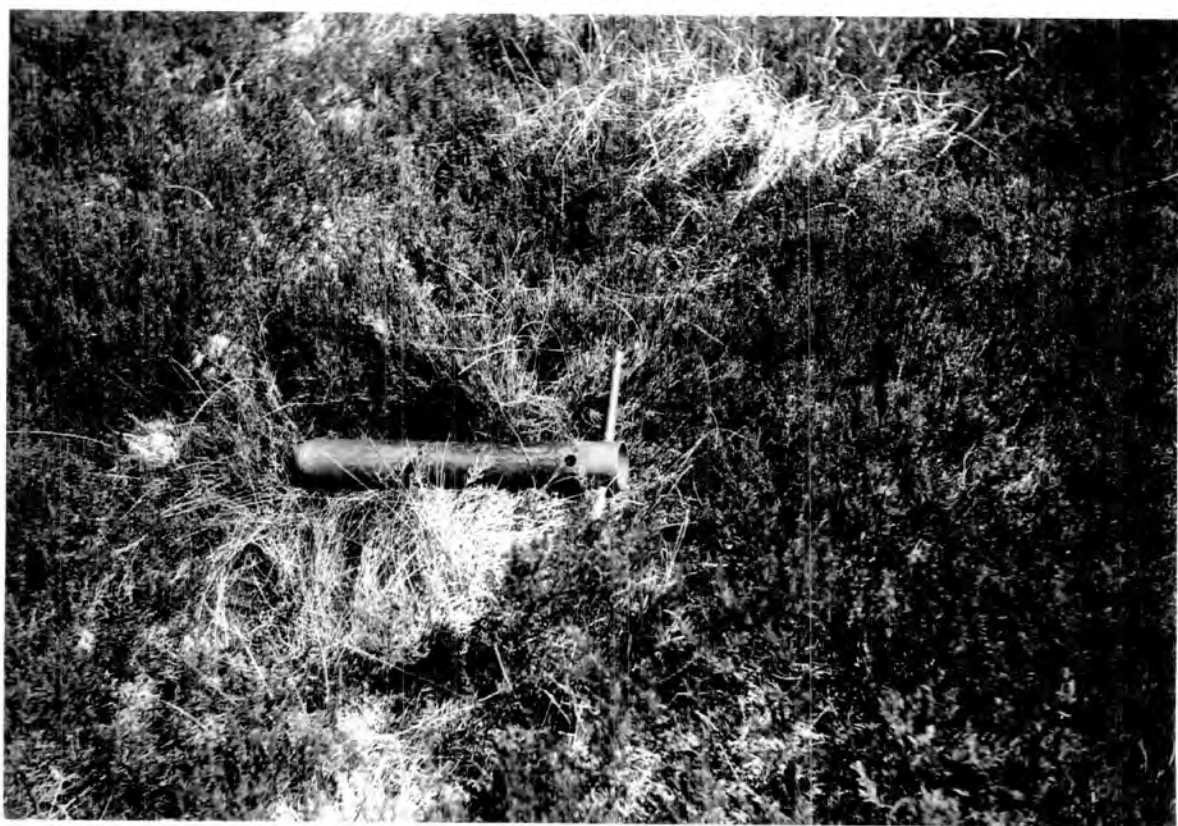
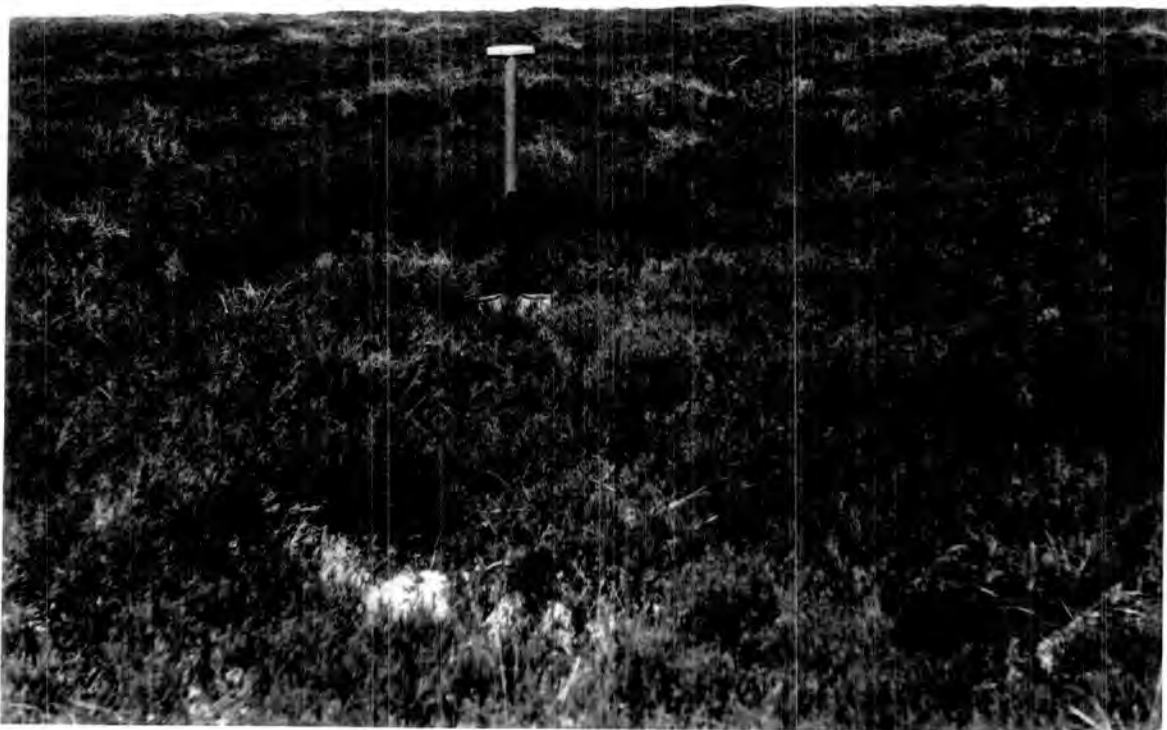

Plate 3.

The mixed Calluna moor site on Dodgen Pot.

a) A general view of the sample site, looking north. Note the dark Calluna vulgaris, and lighter areas of Eriophorum vaginatum and Sphagnum spp. producing a typical 'mixed moor' plant cover. Scale x 1/30.

b) A close up of the vegetation cover with Calluna vulgaris and Eriophorum vaginatum. The soil sampler is 40 cm. in length. Scale x 1/10.



9.4 on 25 September 1961; and in 1962 from 6.1 on 3 May 1962 to 11.8 on 6 December 1962. (see Table 6). The Index of Humidity of the lower 3 cm. layer on this site varied slightly in 1962 from 8.4 on 7 August 1962, to 10.0 on 4 June 1962.

Calluna vulgaris is the dominant plant species, with Eriophorum vaginatum, E. angustifolium, Vaccinium myrtillus, Empetrum nigrum and Rubus chamaemorus occurring abundantly. The dominant Sphagnum is S. rubellum, with Cladonia sylvatica, C. impeza and C. uncialis also present.

d) Juncus squarrosus sample site:

The sample site is located on a peat slip to the North of the alluvial flats of Troutbeck (see Fig. 1). The area has an elevation of 1840 ft. (561 m.) with a regular gentle slope with a south-facing sheltered aspect. The peat is thin here and the site has poor drainage, (see plate 4). Indices of Humidity from 5.5 to 7.5 have been measured from this site (see Table 7).

Juncus squarrosus and Festuca ovina are dominant, with Agrostis tenuis, A. canina and Deschampsia flexuosa occurring abundantly. Associate plants are :

Galium saxatile

Nardus stricta

Potentilla erecta

Sphagnum spp. mainly S. recurvum

Polytrichum commune

and the liverwort Lophocolea bidentata

Plate 4.

A Juncus squarrosus site at Dodger Pot. The view faces north, and the J. squarrosus area lies between the dark Calluna moor in the background and the Juncus effusus in the foreground. The area is a typical moor edge zone on thin peat with poor drainage. Scale x 1/40.



e) Nardus stricta grassland sample site :

The sample site is located 1,000 yards upstream from the Moor House Field Station on the west bank of Rough Sike. The area is at an elevation of 1975 ft. (602 m.) and has a convex, east-facing exposed slope (see Plate 5). The site is occasionally flooded by the nearby stream and the soil is an imperfectly drained peaty alluvium described by Johnson and Dunham (1963) as a moor edge soil complex. Indices of Humidity for the samples from this site range from 1.8-4.0 in the upper 3 cm layer, and from 1.3-2.1 in the lower 3 cm. layer; and are recorded in Table 8. There is a 3 cm. deep litter layer, and Nardus stricta is the dominant plant species, whilst Galium saxatile occurs abundantly.

Other species present are :

Deschampsia flexuosa

Juncus squarrosus

Juncus effusus

Agrostis canina

Potentilla erecta

Anthoxanthum odoratum

Luzula campestris

Rumex acetosa

Polytrichum commune

Viola riviniana

Plate 5.

The Nardus stricta grassland site. The view is facing southwest up Rough Sike, which is liable to flood the site in winter, and which can be seen in the foreground in a summer drought. The width of the stream is one metre. Note the thick vegetation cover with a deep litter layer composed mainly of the remains of N. stricta and Galium saxatile.

Scale x 1/45.



f) The Erosion Area of Moss Flats :

The sample site is Moss Flats (see Fig. 1) at the head of Rough Sike at an elevation of 2075 ft. (633 m.). The site is on a plane with a very exposed surface (Plate 6). The blanket peat has been and still is being extensively eroded from this area by the combined action of frost, wind, rain and sun.

Dissection channels are first formed in the blanket peat (see Plate 7), which deepen and widen by erosion, and finally leave heather covered hummocks on the bare peat surface (Plate 8). The steep side of the erosion channel with the overhanging vegetation from the moor surface is termed a hag. Mosses are not found within 3 ft. (1 m.) of the hag lip due to the drying out of the peat. The overhanging hag lip becomes covered with the lichen Cladonia coccifera agg. and forms a suitable habitat for a large micro-arthropod fauna composed mainly of Collembola. A typical hag lip is shown in Plate 8.

As erosion of the anti-hag (Bower, 1959) or residual peat hummock proceeds, there is developed a steep slope of bare peat facing the prevailing winds (see Plate 8). The dip slope or sheltered side of the hummock is covered by the remains of the vegetation of the original blanket bog; e.g. Calluna vulgaris, Empetrum nigrum, and Erica spp.

Plate 6.

The bare peat surface of Moss Flats. Roots of Calluna can be seen projecting from the peat, and evidence of peat movement in a semi-liquid state can be seen in the foreground. In the middle distance residual Calluna covered peat hummocks can be seen. The view is to the east, which is the direction of the prevailing wind at Moss Flats. Scale x 1/40.



Plate 7.

Typical peat erosion down to the sandstone bedrock, on the north side of Moss Flats. The stream bed is one metre wide in the foreground. Scale x 1/30.

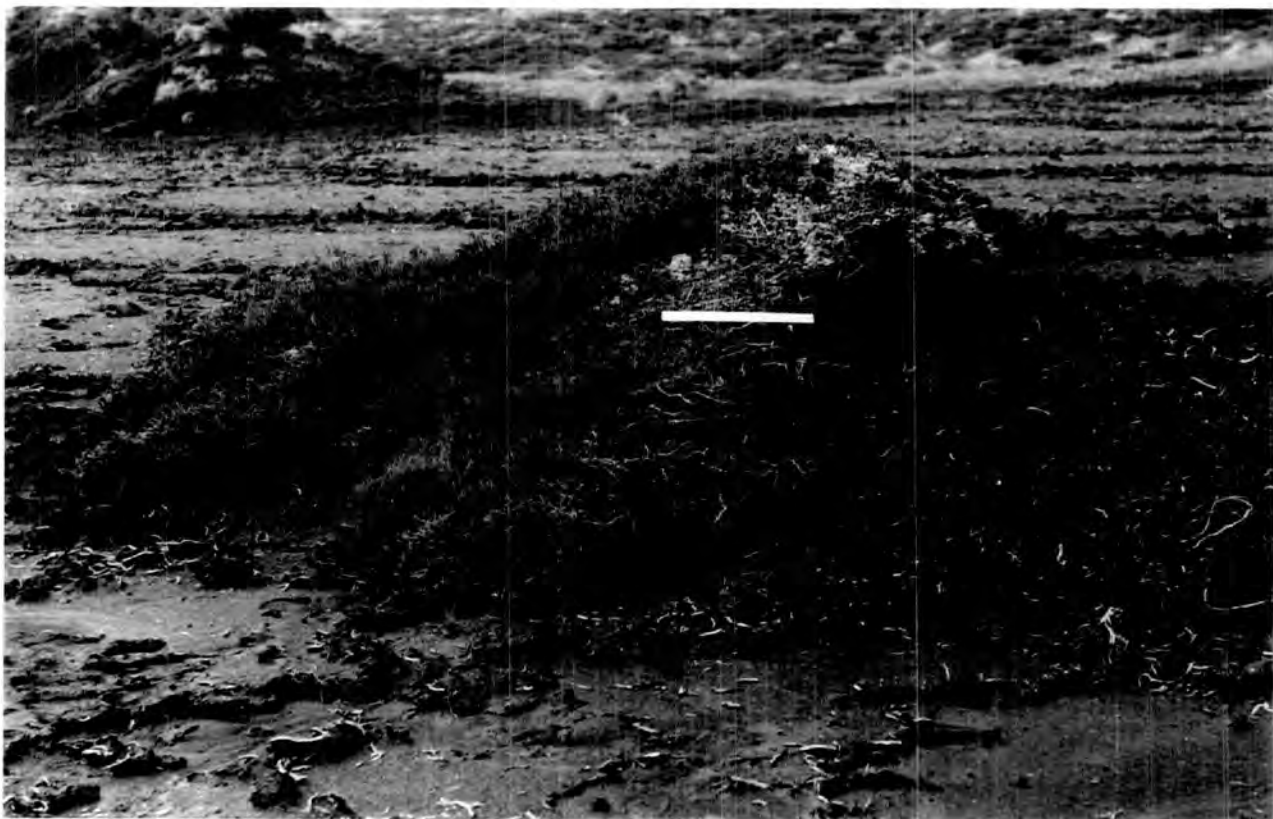

Plate 8.

a) A residual peat hummock on Moss Flats, looking south.

The direction of the prevailing wind is from the right of the photograph, and the scale rule is 30 cm. in length. Note the plant cover of Calluna vulgaris and Empetrum nigrum on the sheltered leeward side of the hummock, and the hag lip developed on the exposed windward side of the hummock. In the background the lighter patches on the moor are tussocks of Eriophorum vaginatum. Scale x 1/15.

b) The hag lip or overhang developed on the edges of eroding moor and peat hummocks. Note the old roots of Calluna vulgaris, and the lichens, including Cladonia coccifera agg., on the hag lip. Scale x 1/5.



On the more waterlogged areas of bare peat on Moss Flats, Eriophorum angustifolium has become established by rhizome growth (Tansley, 1939) rather than by seed. Plate 9 shows a representative area of this habitat. Eriophorum vaginatum is also present as tussocks (see Plate 9). It is not clear whether the latter species is a recolonizing plant of the eroded peat areas, or whether it is a residual species which is left after the lowering of the original moorland surface by erosion.

The major part of the surface of Moss Flats is bare peat, from the base of which the exposed roots and trunks of former Pine and Birch trees project (Plate 6). Acarina are often found in the peat around such roots, but are absent from the surrounding bare peat. Many of the drainage channels have cut the peat down to the Sandstone bedrock as in Plate 7, and fragments of Sandstone occur plentifully, under which Acarina are found (see Plate 10). An algal mat develops in early summer upon the semi-liquid peat in the erosion channels. As it dries out, cracks appear, and large flakes are formed, under which Acarina and Collembola become established. (See plate 10). Further details of this area are given in Section IX (page 132); and the soil water contents recorded from habitats on this area are given in Table 9 (page 20).

Plate 9.

a) Eriophorum angustifolium growing on the bare peat at Moss Flats. Note the extensive spread of this plant by rhizome growth. Scale x 1/6.

b) Tussocks of Eriophorum vaginatum growing on bare peat at Moss Flats. The fruiting heads of E. vaginatum can be seen in the foreground. The rule is 30 cm. in length. Scale x 1/10.

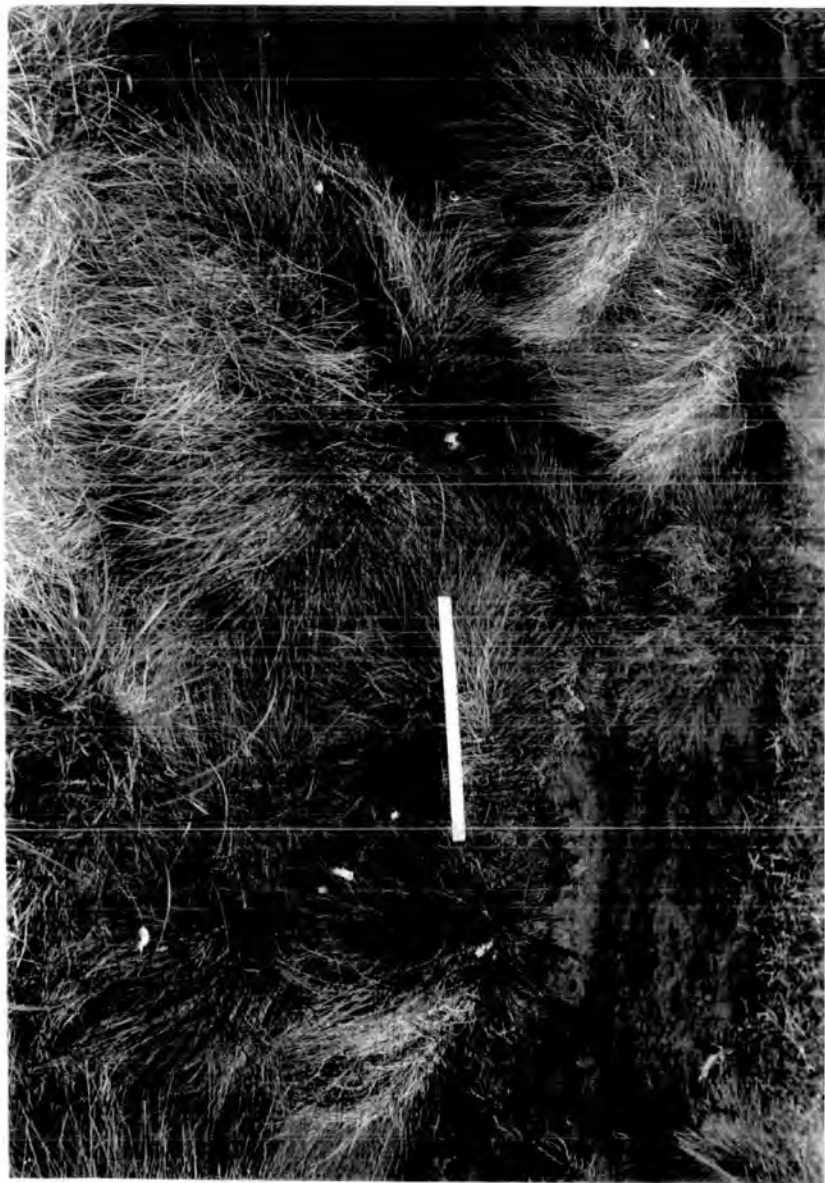
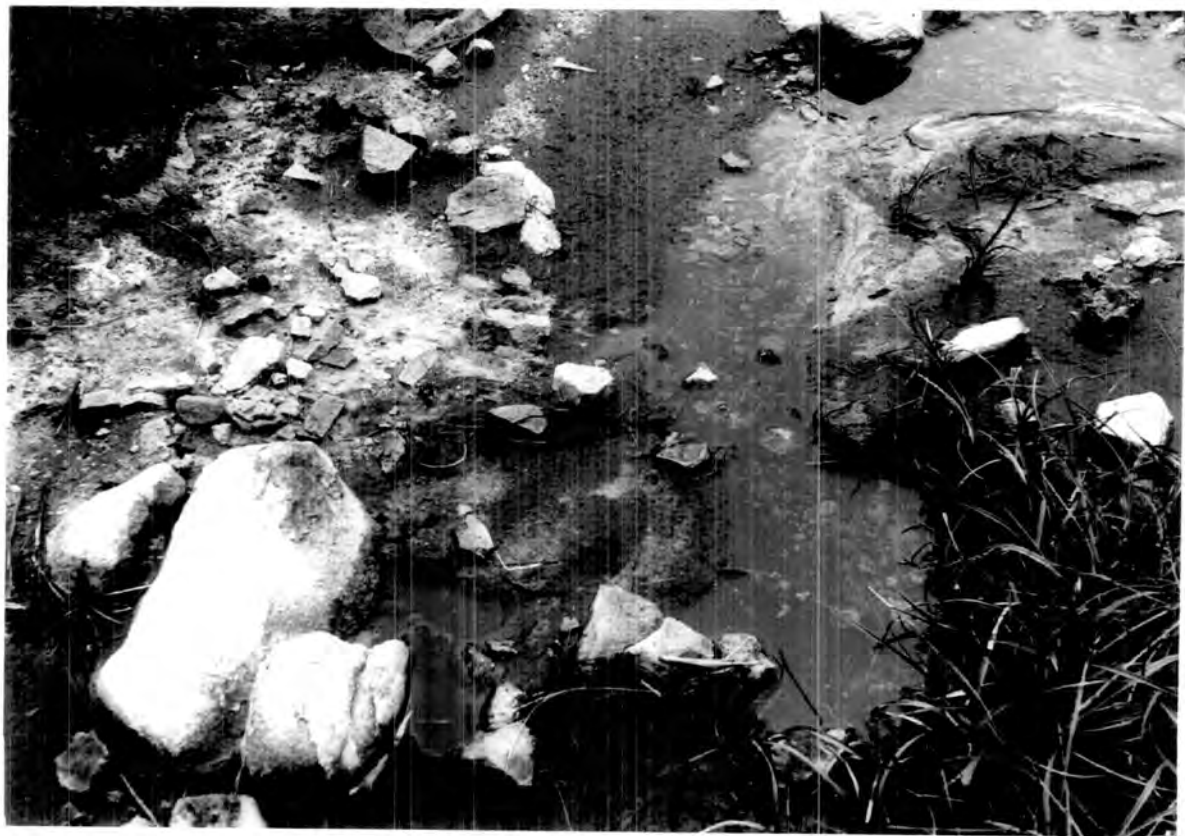

Plate 10.

a) Bare peat surface which is cracking and flaking on the Moss Flats erosion area. At the top right of the photograph the algal mat is flaking away from the underlying peat. A birch root can be seen projecting from the peat. Scale x 1/5.

b) Fragments of the sandstone bedrock on the bare peat of Moss Flats. A typical habitat of Platynothrus peltifer. Scale x 1/5.



g) Other Sample Sites :

Qualitative samples were collected from the following habitats:-

1. Alluvial Grassland - The site is located at the junction of Troutbeck and Nether Hearth Sike (see Fig. 1). The soil is a peaty alluvium with mineral particles. The plant cover is similar to that of the Limestone Grassland site, except that lichens are absent.

2. Juncus effusus - Regular samples were taken from the litter layer at the base of the rush, which provided material for life history studies. The site selected was on the alluvial flats of Troutbeck.

3. Polytrichum commune - Patches of P. commune occurring on the Limestone Grassland site, the Calluna moor site, the Juncus squarrosus site, and elsewhere on the Reserve were sampled, (See Plate 11).

4. Valley Bog - This area of actively growing bog was sampled twice during fieldwork, (See Fig. 1).

5. A list of sites which were sampled qualitatively during the course of the fieldwork and covering the whole of the Reserve is given below.

(i) Sphagnum flush on North side of House Hill above Upper Valley bog. Mainly Sphagnum recurvum, (See Plate 11).

(ii) Juncus squarrosus and J. effusus, on bank of Great Dodgen Pot Sike.

Plate 11.

a) Sphagnum flush north of the Moss Flats erosion area, consisting mainly of S. recurvum. Juncus effusus can be seen growing in the moss of the flush in the middle distance.

Scale x 1/12.

b) Bed of Polytrichum commune in a Sphagnum flush. Scale x1/4.

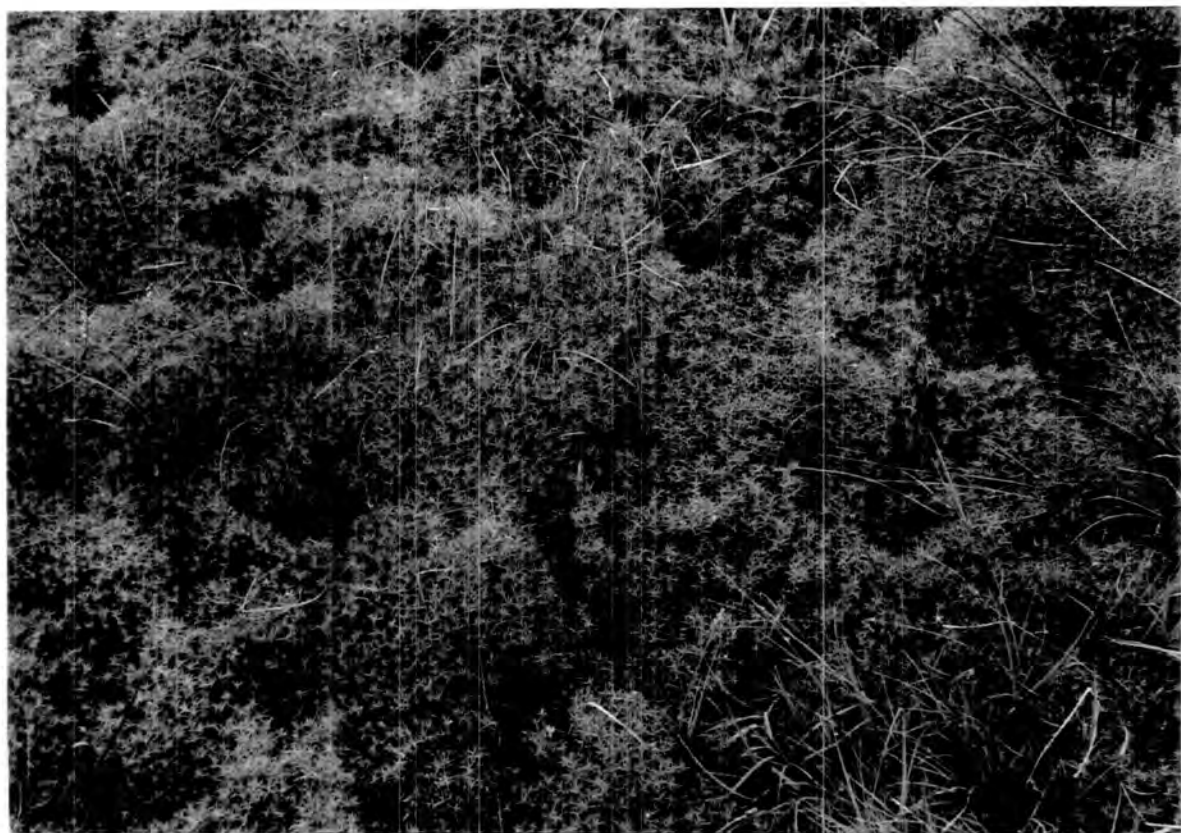
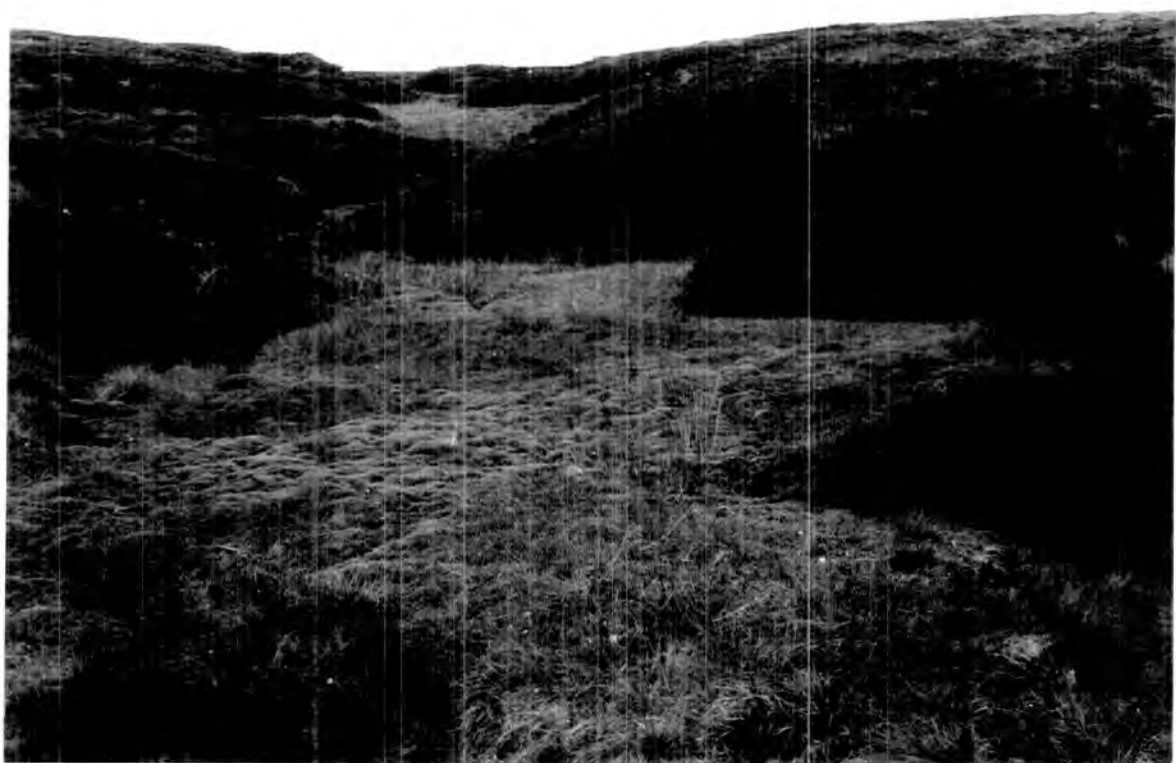

- (iii) Grassland on bank of Great Dodgen Pot Sike consisting mainly of Festuca ovina and Agrostis tenuis.
- (iv) Alluvial Grassland consisting of Festuca ovina and Agrostis tenuis, on River Tees flats.
- (v) Flush on South bank of River Tees consisting of Carex nigra and Eriophorum angustifolium.
- (vi) Hummock of Minuartia verna on heavily eroded grassland beside Moss Burn.
- (vii) Mosses on boulder in Middle Tongue Beck at 1400 ft. (427 m.). Moss species included: Hypnum cupressiforme, Dicranum fuscescens.
- (viii) Lichens on boulder in Middle Tongue Beck. Main species were Hypogymnia physoides, Sphaerophorus globosus, Parmelia spp.
- (ix) Litter from Bracken : Pteridium aquilinum; Middle Tongue Beck.
- (x) Grassland by side of Middle Tongue Beck including Agrostis tenuis, Festuca rubra, F. ovina, Carex caryophylla, Plantago lanceolata, and Briza media.
- (xi) Vegetation from summit of Great Dun Fell, 2780 ft. (845 m.). Plant species included Dicranum fuscescens, Polytrichum alpestre, Festuca ovina, and Carex bigelowii.
- (xii) Vaccinium myrtilus, Festuca ovina, Rhacimitricum lanuginosum, Cladonia spp., Cetraria spp. from the summit of Cross Fell at 2930 ft. (893 m.).

- (xiii) Sphagnum palustre, S. papillosum from Calluna moor, Rough Sike.
- (xiv) Cladonia sylvatica - Lichen on Calluna moor, Rough Sike.
- (xv) Mosses and Liverworts from Calluna moor including Sphagnum rubellum, Rhytidiadelphus loreus, Plagiothecium undulatum, and Aulacomnium palustre, collected on Rough Sike.
- (xvi) Hypogymnia physoides - Lichen on stems of Calluna vulgaris, from Calluna moor, Dodgen Pot.
- (xvii) Bryum pseudotriquetrum - Moss on grassland on House Hill.
- (xviii) Grassland in Paddock of the Moor House Field Station.
- (xix) Horse dung in Paddock of Field Station.
- (xx) Sheep dung on Dodgen Pot.

IV TAXONOMY AND SYSTEMATICS

a) Introduction:

In this section the present state of Acarina systematics is outlined; and a preliminary list of the terrestrial Acarina of the Moor House Reserve is given, together with notes on their taxonomy and autecology. Localities are quoted for each species, extensively for rarer ones, whilst for the commoner species a few typical records are given. A list of the sites which were sampled for Acarina during the fieldwork has been given in Section III.

During the present study 78 species of terrestrial Acarina have been identified from the Moor House Reserve. In no way should this total be regarded as final for the Reserve, as the present work was only a preliminary survey. This provisional total includes:

- 46 species of Cryptostigmata (:Oribatei).
- 30 ^(genera) species of Mesostigmata (Parasitiformes).
- 1 species of Prostigmata (Trombidiformes).
- 1 species of Astigmata (Acaridae).

There are no new records for the British Isles.

In all cases the identification of type specimens were confirmed by taxonomists at the British Museum (Natural History). The writer is responsible for the routine identification of the bulk of the material in the study.

b) Classification of the Acarina:

The Acarina have no known fossil connections with other arachnids, but the cheliceral morphology indicates that the group had an arachnid origin in opilionid-like ancestors. According to Woolley (1961), the group is at least diphyletic, probably polyphyletic in origin with two main divisions; the older Anactinochaeta (having true setae lacking actinochitin and being optically isotropic), and the younger Actinochaeta (having true setae with a core of actinochitin and being optically birefringent).

Evans et al. (1961) have summarised the development of the classification of the Acarina to date, and proposed the following classification, which incorporates the views of Grandjean (1935, 1954). This outline of classification was used in the present study.

Subclass Acari

Superorder Acari-Anactinochaeta

✕ Order Notostigmata : e.g. Opilioacarus.

✕ Order Tetrastigmata : e.g. Holothyrus.

✕ Order Mesostigmata : Parasitiformes.

Order Metastigmata : Ticks

Superorder Acari-Actinochaeta

✕ Order Cryptostigmata : Oribatei.

✕ Order Astigmata : Acaridiae.

✕ Order Prostigmata : Trombidiformes.

✕ : Indicates group with free-living representatives found in soils.

c) Identification of the Moor House fauna:

(i) Techniques :-

Mites were killed and preserved in 70-80 per cent alcohol (Industrial spirit) to which up to 5 per cent glycerine had been added to prevent the specimens drying out through the evaporation of the alcohol during storage (Evans, 1957). Dried out specimens were recovered by warming gently in 60 per cent lactic acid.

The preparation of mites for taxonomic study under the compound microscope involved the removal of their internal organs in order that structures of taxonomic importance could be examined. Grandjean (1949) first used lactic acid as a clearing and temporary mounting medium for mites. The following techniques were based on those described by Evans and Browning (1955).

All developmental stages of terrestrial mites were cleared by immersion in cold or warm 50-100 per cent lactic acid on a cavity slide under a cover-slip. The strength of the lactic acid used is dependent on the degree of sclerotisation of the specimen. The lower concentrations (50-70 per cent) for immature stages and other weakly sclerotised forms, e.g. Order Astigmata and some Cryptostigmata, and the higher concentrations (80-100 per cent) for heavily sclerotised specimens, e.g. Order Mesostigmata and many Cryptostigmata. Clearing in cold lactic acid took from 4-6

days for heavily sclerotised mites. Lactophenol has been used in the present study for rapid clearing of very heavily sclerotised specimens with good results.

The preparations were warmed gently on a warming plate, which was constructed by enclosing a 60 watt electric bulb in a metal box. Rapid heating was avoided as it tended to rupture the specimens.

Temporary preparations were made of cleared specimens in lactic acid on cavity slides with cover-slips. The technique for the orientation of mites in cavity slides has been described by Grandjean (1949). Critical studies were carried out in this work by using a perspex cavity slide for containing the specimen during orientation (see Evans and Browning, 1955). This technique is illustrated in Fig. 3. The orientation and manipulation of the mite in the medium was done by means of a piece of fine fuse wire flattened into a minute spatula by hammering and mounted in a glass rod.

Permanent preparations were made earlier in this work to form a reference collection to the Moor House species. The specimens were orientated and mounted in de Faure's medium, which was prepared as follows:

Distilled water	50 ml.
Chloral hydrate	50 g.
Glycerol	20 ml.
Gum arabic or acacia	30 g.

Fig. 3.

Illustration of the technique using a perspex cavity slide for orientation of mite specimen in a fluid medium (after Grandjean, 1949; and Evans and Browning, 1955).

CAVITY SLIDE TECHNIQUE

Fig.3.

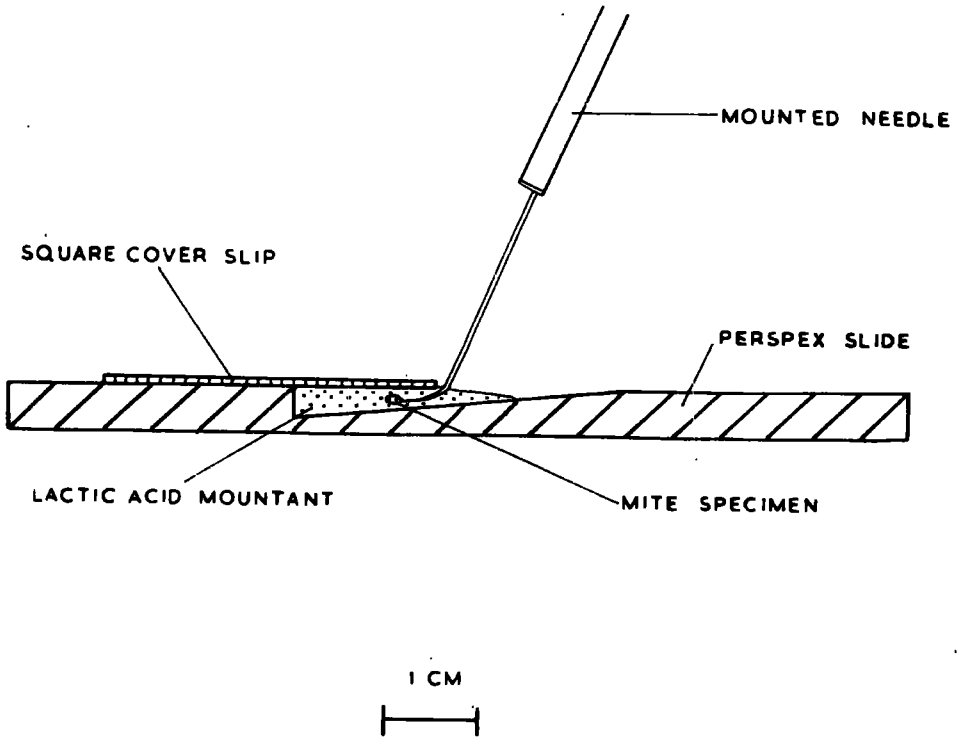
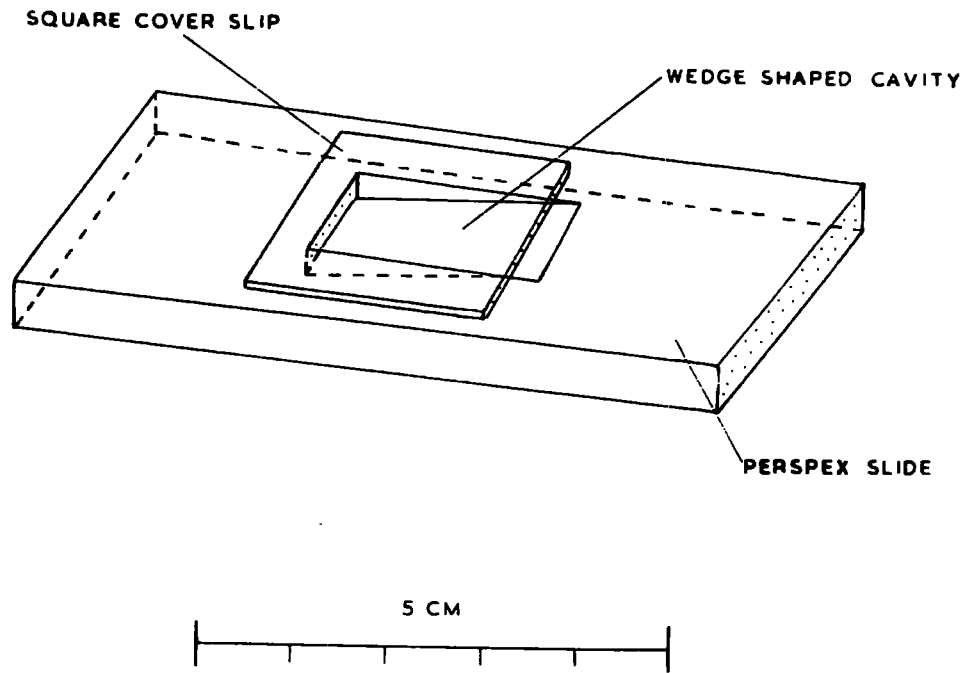

The ingredients were mixed at room temperature, and the resulting mountant filtered through silk before use. The specimens were transferred directly from the preserving or clearing fluids into the mountant. The cover-slip was sealed with "Glyceel" within one week of preparation. Little distortion of the permanently mounted specimens has occurred in these slides. Evans et al. (1961) have found polyvinyl alcohol (P.V.A.) unsuitable for permanent preparations due to the shrinkage which occurs during drying.

(ii) Literature :-

A general introduction to the Acarina was obtained through the publications of Baker and Wharton (1952), Hughes, (1959), Hughes, (1961), and Evans et al. (1961). The figures in the keys by Baker et al. (1958) were useful during the early stages of the taxonomic work. The works by Russell (1957), Kevan (1962) and Kuhnelt (1961) formed an introduction to the study of soil faunas.

In the present work all the Cryptostigmata (Oribatei) were identified to the species where possible; and the Mesostigmata to family or generic level. The major key works used in the identifications are cited below, whilst other taxonomic literature consulted is listed in Appendix II.

The identification of the Cryptostigmata was by the keys of Willman (1931), and Balogh (1961, 1963); and aided by descriptions from Michael (1883, 1887), Hammen (1952),

Sellnick and Forsslund (1955), and Haarløv (1957). Determination of the juvenile stages of the Cryptostigmata was by keys from Tuxen (1952) and descriptions from the above literature.

The Mesostigmata were determined as far as possible by the excellent introduction to the group by Evans (1957). Further papers from the numerous literature are given in Appendix II, which give keys and descriptions to species.

Keys contained in Baker and Wharton (1952) were helpful in identification of the Prostigmata and Astigmata from the Reserve.

Check lists to species of British mites were consulted in Hull (1918, 1925), and Turk (1945, 1953).

d) Check-list and habitats of the Moor House Acarina :

In the following list the species and genera are arranged in the order of the check list to the British species by Turk (1953). Reference has also been made to the publications of Baker and Wharton (1952), and Balogh (1963).

CRYPTOSTIGMATA

1. Nanhermannia nana sensu Willman 1931

A common species found on all areas where samples were collected, both on mineral and peat soils. Typical records :-

Dodgen Pot (Juncus squarrosus) 28.11.60

Limestone grassland 3.5.62.

2. Hypothonius rufulus C. L. Koch 1836

Recorded from the Juncus squarrosus site at Nether

Hearth and the mixed moor only. Typical records :-

Dodgen Pot (Calluna vulgaris) 25.9.61.

Nether Hearth (Juncus squarrosus) 28.8.61.

3. Trimalaconothrus foveolatus Willman 1931

A species which has only been found on the Limestone grassland, mixed moor and the Nardus stricta grassland.

Typical records :-

House Hill (Calluna vulgaris) 10.4.61.

Limestone grassland 5.6.61.

4. Trimalaconothrus novus Sellnick 1921

Recorded once only from the Juncus squarrosus site at Nether Hearth on 11.12.61.

5. Nothrus palustris C. L. Koch 1836

A common species in wet habitats of the Reserve, including Valley Bog and mixed moor. Typical records :-

Valley Bog (Sphagnum spp.) 10.4.61.

Limestone grassland 23.10.61.

6. Nothrus silvestris Nicolet 1855

Recorded extensively from peat areas only. According to van der Hammen (1952) this species occurs in forest soils. Typical records :-

Moss Flats (Eriophorum angustifolium) 5.9.61.

Dodgen Pot (mixed moor) 11.12.62.

8. Camisia bistriatus (C. L. Koch 1839)

Recorded once only in Polytrichum commune collected from flush on House Hill, 4.6.62.

7. Camisia segnis (Hermann 1804).

This species is common on blanket bog. Typical records:

Moss Flats (hummock top) 4.12.61. Dodgen Pot (mixed moor) 15.1.62.

9. Camisia spinifer (C. L. Koch 1836)

Not a common species and recorded only from Limestone grassland, mixed moor and the Juncus squarrosus site.

Typical records :-

Cross Fell summit (moss) 24.5.62.

Nether Hearth (Juncus squarrosus) 28.8.61.

10. Platynothrus peltifer (C. L. Koch 1839)

A common species recorded from all the habitats sampled.

Typical records:-

Troutbeck Flats (alluvial grassland) 4.7.60.

Rough Sike (Calluna vulgaris) 20.3.62.

11. Damaeus clavipes (Hermann 1804)

Recorded from the litter of Juncus effusus and the Nardus stricta grassland. Typical records :-

Nether Hearth (Juncus effusus) 5.9.61.

Rough Sike (Nardus stricta) 3.10.62.

12. Damaeus gracilipes (Kulczynski 1902)

Recorded only from Cladonia sylvatica on mixed moor, Rough Sike on 25.5.62.

13. Eremaeus oblongus C. L. Koch 1836

Recorded commonly on the hag lip areas at Moss Flats erosion site. Typical records :-

Moss Flats (Hag lip) 27.2.61.

Troutbeck Flats (Hag lip) 24.5.62.

14. Suctobelba trigona (Michael 1888)

A single record exists for this species on the Reserve :-

House Hill (Moss: Bryum pseudotriquetrum) 25.5.62.

15. Suctobelba subtrigona (Oudemans 1900)

Common on mixed moor and the Limestone grassland.

Typical records :-

Limestone grassland 3.10.62.

Valley Bog (Polytrichum commune) 23.5.62.

16. Oppia splendens C. L. Koch 1841

Typical records :-

Limestone grassland 25.9.61.

Dodgen Pot (mixed moor) 3.4.62.

17. Oppia subpectinata Oudemans 1901

Typical records :-

Limestone grassland 28.11.60.

Nether Hearth (Juncus squarrosus) 20.2.61.

18. Oppia obsoleta (Paoli) sensu Willman 1931

A common species of the peat and mineral soils.

Typical records :-

Limestone grassland 16.1.61.

Dodgen Pot (mixed moor) 5.6.61.

19. Oppia ornata (Oudemans 1900)

Recorded from the mixed moor and erosion area.

Typical records :-

Moss Flats (bare peat) 27.3.61.

Dodgen Pot (mixed moor) 6.12.62.

20. Oppia quadricarinata (Michael 1885)

A single record from Troutbeck Flats (Juncus effusus litter) on 23.5.62.

21. Oppia neerlandica Oudemans 1900

Recorded only from blanket peat. Typical records :-

Dodgen Pot (mixed moor) 14.5.61.

Rough Sike (mixed moor) 23.5.62.

22. Thyrisoma lanceolata (Michael 1888)

Recorded from peat, mineral, and alluvial soil types.

Typical records :-

Nether Hearth (Juncus squarrosus) 28.11.60.

Limestone grassland 15.1.62.

23. Ceratoppia bipilis (Hermann 1804)

A commonly occurring species on all sites but in low densities. Typical records :-

Troutbeck Flats (alluvial grassland) 4.7.60.

Dodgen Pot (mixed moor) 3.10.62.

24. Tectocephus velatus (Michael 1880)

Abundant and widely distributed on all the main peat and mineral soil types sampled. Typical records :-

Troutbeck Flats (alluvial grassland) 25.7.60.

Dodgen Pot (mixed moor) 18.4.61.

25. Tectocephus velatus var sarekensis Trägårdh 1910

Haarløv (1952) has suggested that the characters of T. velatus vary considerably, and that all previously des-

cribed species, with the exception of T. alatus Berlese 1913, belong to T. velatus (Michael 1880). The variety T. velatus var sarekensis probably belongs to T. velatus (Michael 1880).

26. Cepheus dentatus (Michael 1888)

Recorded from mixed moor and Nardus stricta grassland on :-

Dodgen Pot (mixed moor) 23.1.63.

Rough Sike (Nardus stricta) 3.10.62.

27. Carabodes marginatus (Michael 1884)

Recorded from peat and mineral soil areas, but not so common as Carabodes minusculus. Typical records :-

Dodgen Pot (mixed moor) 20.2.61.

Limestone grassland 4.6.62.

28. Carabodes minusculus Berlese 1923

Recorded commonly from all the areas sampled. Typical records :-

Limestone grassland 22.11.61.

Dodgen Pot (mixed moor) 3.7.62.

29. Oribatula tibialis (Nicolet 1855)

Recorded from both peat and mineral soil types. Typical records :-

Dodgen Pot (mixed moor) 23.1.61.

Limestone grassland 13.2.62.

30. Liebstadia similis (Michael 1888)

Widespread on all sites in moderate densities. Typical records :-

Troutbeck Flats (alluvial grassland) 4.7.60.

Rough Sike (mixed moor) 4.6.62.

31. Minunthozetes semirufus (C. L. Koch 1840)

Recorded only from the mineral soil of the Limestone grassland. Typical record :-

Limestone grassland 10.4.61.

32. Melanozetes mollicomus (C. L. Koch 1840)

Recorded on mixed moor and the limestone grassland as follows :-

Limestone grassland 22.11.61.

Dodgen Pot (mixed moor) 1.9.62.

33. Edwardzetes edwardsii (Nicolet 1855)

Hull (1916) described this species as one of the commonest in the north of England, but it is not widely distributed on the Reserve. Typical records :-

Limestone grassland 28.11.60

Troutbeck Flats (alluvial grassland) 20.5.62.

34. Chamobates incisus van der Hammen 1952

A single record from the Limestone grassland :- 3.10.62.

35. Chamobates schutzi (Oudemans 1902)

Extremely common on all the areas studied. Typical records :-

Dodgen Pot (mixed moor) 18.4.61.

Limestone grassland 3.10.62.

36. Ceratozetes gracilis (Michael 1884)

Recorded from the four main sampling areas. Typical records :-

Nether Hearth (Juncus squarrosus) 20.2.61.

Rough Sike (Nardus stricta) 3.7.62.

37. Limnozetes sphagni (Michael 1884)

Collected from Sphagnum and wet areas in erosion channels. Typical records :-

Valley bog (Sphagnum) 3.5.62.

Moss Flats (Eriophorum angustifolium) 4.12.61.

38. Pelops planicornis (Schrank 1803)

Recorded extensively from both peat and mineral soil types. Typical records :-

Troutbeck Flats (alluvial grassland) 4.7.60.

Moss Flats (hummock top) 4.12.61.

39. Pelops plicatus (C. L. Koch 1836)

Recorded from peat and mineral soils. Typical records :-

Nether Hearth (Juncus squarrosus) 28.11.60.

Limestone grassland 3.7.62.

40. Peloptulus phaenotus (C. L. Koch 1844)

A single specimen collected from the Limestone grassland, 1.9.62.

41. Achipteria coleoptrata (Linnaeus 1758)

Typical records :-

Limestone grassland 20.3.62.

Dodgen Pot (mixed moor) 28.8.61.

42. Notaspis punctatus Nicolet 1855

Recorded only from the mixed moor on Dodgen Pot, 5.6.61.

43. Galumna von Heyden 1826

The single specimen of this genus has not been determined as yet. Recorded from Dodgen Pot (mixed moor) on 4.6.62.

44. Phthiracarus piger (Scopoli 1763)

Recorded only from the peat sites. Typical records :-

Dodgen Pot (mixed moor) 8.5.61.

Dodgen Pot (Juncus squarrosus) 20.2.61.

45. Phthiracarus ligneus Willman 1931

Recorded most extensively from the peat sites, but also from the mineral and alluvial soils. Typical records :-

Moss Flats (hummock top) 27.2.61.

Rough Sike (Nardus stricta) 3.10.62.

46. Pseudotritia minima (Berlese 1904)

Specimens were collected only from mixed moor and areas of Juncus squarrosus. Typical records :-

Dodgen Pot (mixed moor) 8.5.61.

Nether Hearth (Juncus squarrosus) 11.12.61.

The following records for the Mesostigmata are of those species and genera so far determined; a fuller list will be available when the material has been completely determined at the British Museum.

47. Zercon C. L. Koch 1836

This genus was recorded from all the sample sites, but it occurred more commonly in the mineral soils. Typical records :-

Limestone grassland 13.2.62.

Dodgen Pot (mixed moor) 13.3.61.

48. Veigala nemorensis (C. L. Koch 1839)

A single record for this species to date in mosses on the surface of a rock, Middle Tongue beck :- 24.5.62.

49. Veigala cervus (Kramer 1876)

Recorded from Sphagnum moss in Valley Bog :- 29.10.60.

50. Veigala transisalae (Oudemans 1902)

Recorded on Dodgen Pot (mixed moor) :- 15.1.62.

51. Veigala kochi (Trägårdh 1901)

Recorded from the Limestone grassland :- 11.12.61.

52. Parasitus Latreille 1795

Recorded from the Limestone grassland, mixed moor and

Juncus squarrosus moor. Typical records :-

Limestone grassland 15.1.61.

Dodgen Pot (sheep dung) 4.7.62.

53. Eugamasus Berlese 1892

Recorded from mixed moor on Dodgen Pot :- 4.7.62.

54. Amblygamasus septentrionalis (Oudemans 1902)

Valley Bog (Sphagnum) 29.8.58.

55. Pergamasus crassipes (Linnaeus 1758)

Widely distributed on both peat and mineral soil areas.

Typical records: Limestone grassland 8.5.61.

Dodgen Pot (Juncus squarrosus) 11.12.62.

56. Pergamasus crassipes var. longicornis Berlese 1906.

Typical records :-

Dodgen Pot (mixed moor) 6.12.62.

Limestone grassland 23.10.61.

57. Pergamasus robustus (Oudemane 1902)

Nether Hearth (Juncus squarrosus) 28.11.60.

58. Pergamasus decipiens (Berlese 1903)

Rough Sike (Nardus stricta) 28.11.62.

59. Digamasellus Berlese 1905

Recorded from the four main sample sites. Typical records :-

Limestone grassland 13.3.61.

Dodgen Pot (mixed moor) 11.12.61.

60. Hypoaspis G. Canestrini 1885

Rough Sike (Nardus stricta) 30.1.62.

61. Lasioseius Berlese 1916

Moss Flats (Eriophorum angustifolium) 4.12.61.

Limestone grassland 15.1.62.

62. Platyseius Berlese 1916

Moss Flats (Eriophorum angustifolium) 5.9.61.

63. Eviphis ostrinus (C. L. Koch 1836)

Troutbeck Flats (alluvial grassland) 25.7.60.

64. Pachylaelaps Berlese 1888

Recorded from peat and mineral soils. Typical records :-

Rough Sike (Nardus stricta) 30.1.62.

Limestone grassland 5.6.61.

65. Sphaerolaelaps (?) holothyroides (Leonardi 1896)
Limestone grassland edge (Sphagnum rubellum) 14.10.60.
66. Macrocheles submotus Falconer 1923
Nether Heath (Juncus squarrosus) 28.11.60.
67. Macrocheles glaber (Müller 1860)
Limestone grassland 3.10.62.
68. Geholaspis longispinosus (Kramer 1878)
Troutbeck Flats (Juncus effusus litter) 11.10.60.
69. Rhodacarus roseus Oudemans 1902
Recorded from the Limestone grassland, mixed moor and
Nardus stricta grassland, but commonest on the former site
below 3 cm. in depth. Typical records :-
Limestone grassland 10.4.61.
Rough Sike (Nardus stricta) 3.10.62.
70. Trachytes pyriformis (Kramer 1876)
Distributed on all the areas sampled. Typical records :-
Dodgen Pot (mixed moor) 23.10.61.
Limestone grassland 7.8.62.
71. Trachytes minima Trägårdh 1910
An uncommon species found only in mineral soils.
Typical records :-
Limestone grassland 17.7.61.
72. Dinychus Kramer 1882
Recorded from the Limestone grassland only. Typical
record :-
Limestone grassland 30.1.62.

73. Polyaspinus cylindricus Berlese 1916

Two records only of this species as follows :-

Troutbeck Flats (Juncus effusus litter) 22.11.61.

Rough Sike (Nardus stricta) 30.1.62.

74. Phaulocylliba Berlese 1904

Limestone grassland 28.8.61.

75. Cilliba cassidea (Hermann 1804)

Recorded only from the Juncus squarrosus site on 20.2.61. and from Bracken litter on Middle Tongue on 24.5.62.

76. Olodiscus minima (Kramer 1882)

Recorded from all the sites sampled at Moor House, but common on the Limestone grassland. Typical records :-

Limestone grassland 14.10.60.

Dodgen Pot (mixed moor) 7.8.62.

PROSTIGMATA

77. Trombidiidae Leach 1814

This family was recorded from all the sites studied.

ASTIGMATA

78. Rhizoglyphus echinopus (Fumouze and Robin 1868)

Recorded from both peat and mineral soil types, but commonest on the Limestone grassland. Typical records :-

Limestone grassland 4.6.62.

Rough Sike (Nardus stricta) 3.7.62.

V SAMPLING AND EXTRACTION TECHNIQUES

a) Introduction :

Methods for the extraction of micro-arthropods from soils have been reviewed in Kevan (1955, 1962); Balogh (1958); Kuhnelt (1961); and Murphy (1962). A comprehensive publication on all aspects of soil arthropod sampling is included in Macfadyen (1962).

The methods can be divided into two main types. Firstly, there are methods which operate by the movement of the animals out of the soil in response to attractant or repellent stimuli, e.g. light, temperature, desiccation, humidity. This type of method has been termed 'behaviour' (Macfadyen, 1957), 'dynamic' (Murphy, 1962), and 'automatic' by Continental workers. Secondly, there are 'mechanical' methods involving sieving, flotation, or sedimentation, where the arthropods are removed independent of their activity.

The extraction of soil arthropods presents great problems and no accurate measure of extraction efficiency has been obtained. Macfadyen (1953, 1955, 1961) has described and compared several methods for extracting soil arthropods from soil samples. In all cases assumptions have to be made concerning the reliability of the extraction technique as follows:

- i) That the extraction processes for different dates on the same soil site are comparable. Involved in this aspect is the age structure of the population being sampled, and its ability to react to stimuli in behaviour-type apparatus; the water content of the soil samples; the varying field temperatures, i.e. animals are less active at low temperatures; and variations in the depth of litter layer and plant cover.
- ii) Comparison of numbers from different soil types assumes a similar extraction efficiency, although variations in pore size and vegetation cover may make escape from one soil type easier than from another in a behaviour-type apparatus.
- iii) In mechanical extraction devices such as the flotation apparatus, some groups float more readily than others. For comparative purposes it must be assumed that all groups of Arthropoda float with equal ease.

The flotation extraction process developed by Raw (1955) was considered unsuitable for the present study due to the large quantity of organic matter present in moorland soils. It was decided that the most efficient behaviour-type extraction apparatus would be employed. This was considered to be the High Gradient apparatus designed by Macfadyen (1961), and a model was used which had been built by Hale (1962) for his studies on the Collembola of Moor House, (See Plate 12). This apparatus was ten times as

efficient as a Tullgren funnel under the conditions and soils used by Macfadyen (1961).

The advantages of such a method may be summarised as follows: the method is a relatively simple one and requires little labour compared with the mechanical processes available. The animals are recovered in good condition, and is certainly the only known successful means of extracting micro-arthropods from soils having a high organic matter content. It is also a suitable method for obtaining live specimens of the Arthropoda.

The disadvantages of the method include: contamination of the catch with sample debris during extraction; and its unsuitability for soils with a high clay content, due to shrinkage of the sample. The efficiency of the behaviour-type extractor for individual animal groups may vary to a greater extent than a mechanical device. It will not extract inert stages, and the effect of predators or other causes of change in the number of individuals may be important because of the length of time which the extraction process takes.

b) Sampling:

1) The size of the sample unit.

It was required during the study to estimate the variations in density and numbers of common species, in addition to evaluating the total density of Acarina.

Therefore, a sample unit size which would yield numbers of the order of 20-100 mites was sought, and $1/1000\text{cm}^2$ (10cm^2) of surface area was decided upon. The cores were taken to a depth of 6 cm., cut horizontally into half, and extracted separately.

In the construction of the extraction apparatus, (Fig. 5) 'Tuffnol' tubing of the correct diameter could not be obtained and the surface area of the sample units was 11.5 cm.^2 ($1/881\text{m}^2$).

2) The number of sample units.

It was considered to be of more value to take a large number of small sample units than a small number of larger units of the same total surface area for the following reasons :

- i) A large number of sample units is more representative of the habitat than a few samples.
- ii) The statistical error is reduced since this varies as $\frac{1}{n}$, where n is the number of the sample units.
- iii) The efficiency of extraction is greater for small sized sample units in a behaviour-type extractor.

Macfadyen (1957) recommends 30 sample units of 10cm^2 size where the distribution of the organisms is patchy. The labour involved in the processing of this number of sample units for the sampling programme envisaged was considered to be too great, particularly as the cores were to be subdivided

and 15 sample units were taken throughout the study. The sampling dates were at monthly intervals as no more than 2-3 generations per year were expected for the Acarina at Moor House.

Regular sampling was begun in January 1961 and continued until December 1962.

3) The soil sampler.

Construction of the soil sampler was similar to that described by Macfadyen (1961) and is illustrated in Fig. 4. It was designed to take 2 'Tuffnol' (heat resistant laminated phenolic plastic) sample holders, each taking a 3 cm. deep soil core of 11.35cm² in circular cross section. The 'Tuffnol' sample holders were held in position in the soil sampler by means of a retaining cylinder clamped in place by a lid. The steel cutting edge of the sampling tool was sharpened regularly. Handles were fixed to the sampler to aid in cutting the sampler into the substrate. It is suggested that a sampling tool similar to that designed by Törne (1962) for sampling compost may give better results in sampling peat.

4) Taking the sample:

Bias was avoided in sampling by taking the soil cores at random in the habitat. The containers of sample holders were thrown randomly over the area, and the sample taken one metre from the top of the container along its axis. In sampling, the sampler was held vertical to the ground surface,

Fig. 4.

The soil sampler showing the position of the 'Tuffnol' sample holders, and the retaining cylinder.

Fig.4.

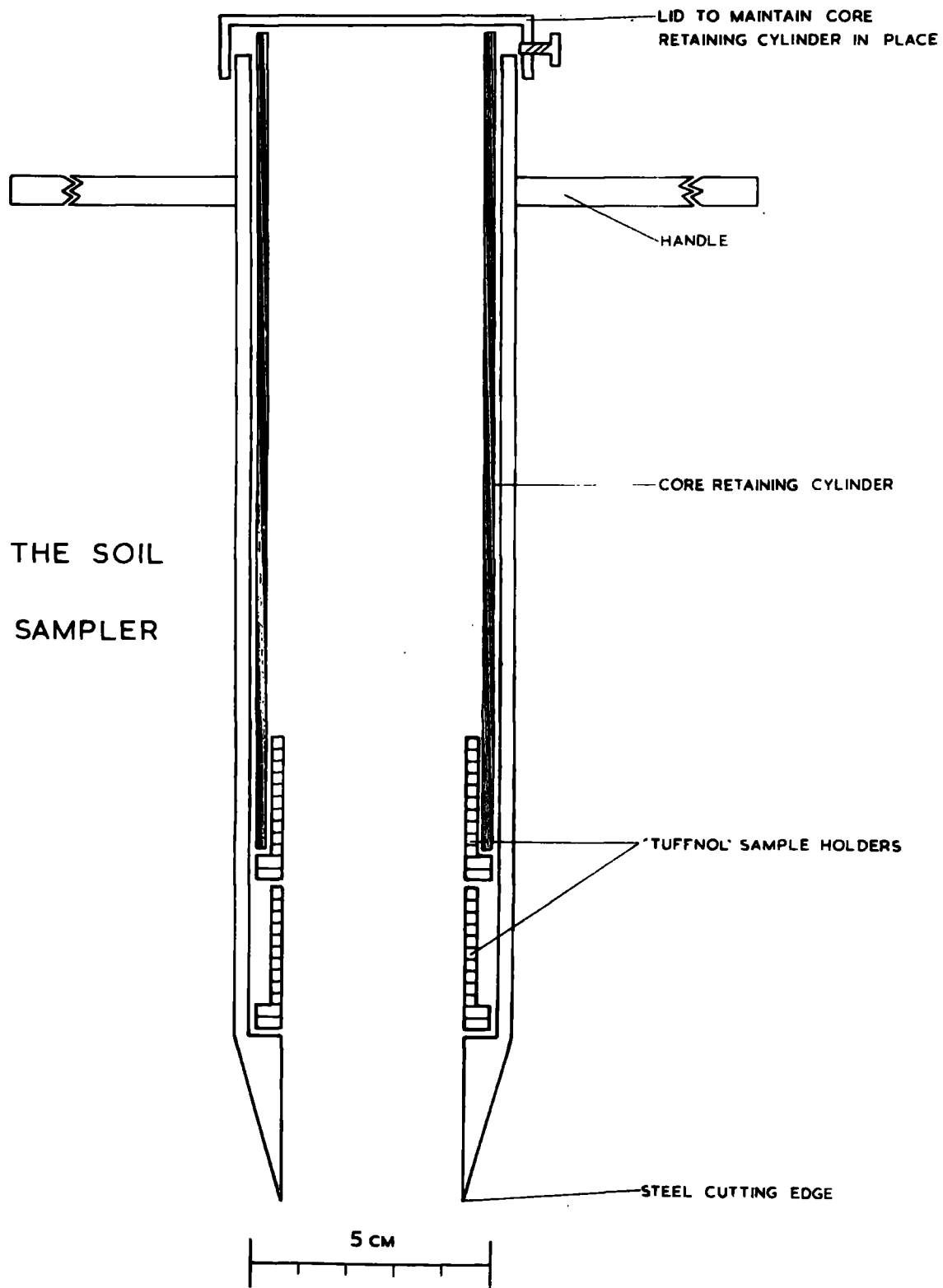

and with many half revolutions of the tool and light pressure the vegetation was first cut. Then greater pressure was applied to the handles of the tool, and the sampler forced into the soil to the required depth by means of an alternate twisting action. The sampler was withdrawn after the soil core had been broken from the underlying soil by a complete revolution of the sampling tool.

5) Treatment of the sample:

Care was taken to prevent damage to the samples when removing them from the soil sampler in the field. Murphy (1962) has shown that the efficiency of a split funnel extractor is reduced when disturbed samples were used.

The two vertically adjacent samples were separated from each other and from the unwanted lowest plug of soil by a sharp knife in the field. Each separate soil sample contained within its 'Tuffnol' holder was wrapped in a small polythene bag to prevent desiccation and loss of animals, and placed in an aluminium canister for transport to the laboratory. The first extraction was normally begun within 6 hours of collection of the samples. The sample units to be extracted later were stored at a temperature of 5°C. until the second extraction 3 days after collection.

All soil cores in the sample holders were weighed in bulk before extraction, and again after drying to constant weight (see page 15.), to obtain data on soil water content.

When loading the soil samples into the extractor the vegetation surface of the sample was placed downwards in each extraction unit, i.e. away from the heat source. As the majority of soil micro-arthropods inhabit the litter layer this provides the shortest possible distance for them when leaving the sample during the extraction process.

c) Extraction apparatus

Macfadyen (1955) has summarised the stages in the development of the Berlese funnel for quantitative studies on soil micro-arthropods. The High Gradient apparatus designed by Macfadyen (1961) takes cores of $1/200\text{m}^2$ (50cm^2) in surface area and 3 cm. deep. As stated above the apparatus used in this study takes samples of $1/881\text{m}^2$ (11.35cm^2) in surface area and 3 cm deep.

Fig. 5 shows a single extractor unit of the High Gradient apparatus. The sample unit is inverted over a metal gauze fitted to the top of an aluminium canister which contains water to the depth of 1 cm., and is sealed by means of a rubber sleeve. A steep temperature gradient can be maintained through the depth of the soil sample by heating from above by a 60 watt pearl electric bulb, and cooling the collecting canister from below, by a water bath through which a constant flow of cold water is maintained. That condensation does not occur at the level of the sample due to the maintenance of a steep temperature gradient throughout

Fig. 5.

A single unit of the high-gradient extraction apparatus showing the orientation of the soil sample.

Fig. 5.

HIGH GRADIENT EXTRACTION APPARATUS SINGLE EXTRACTION UNIT

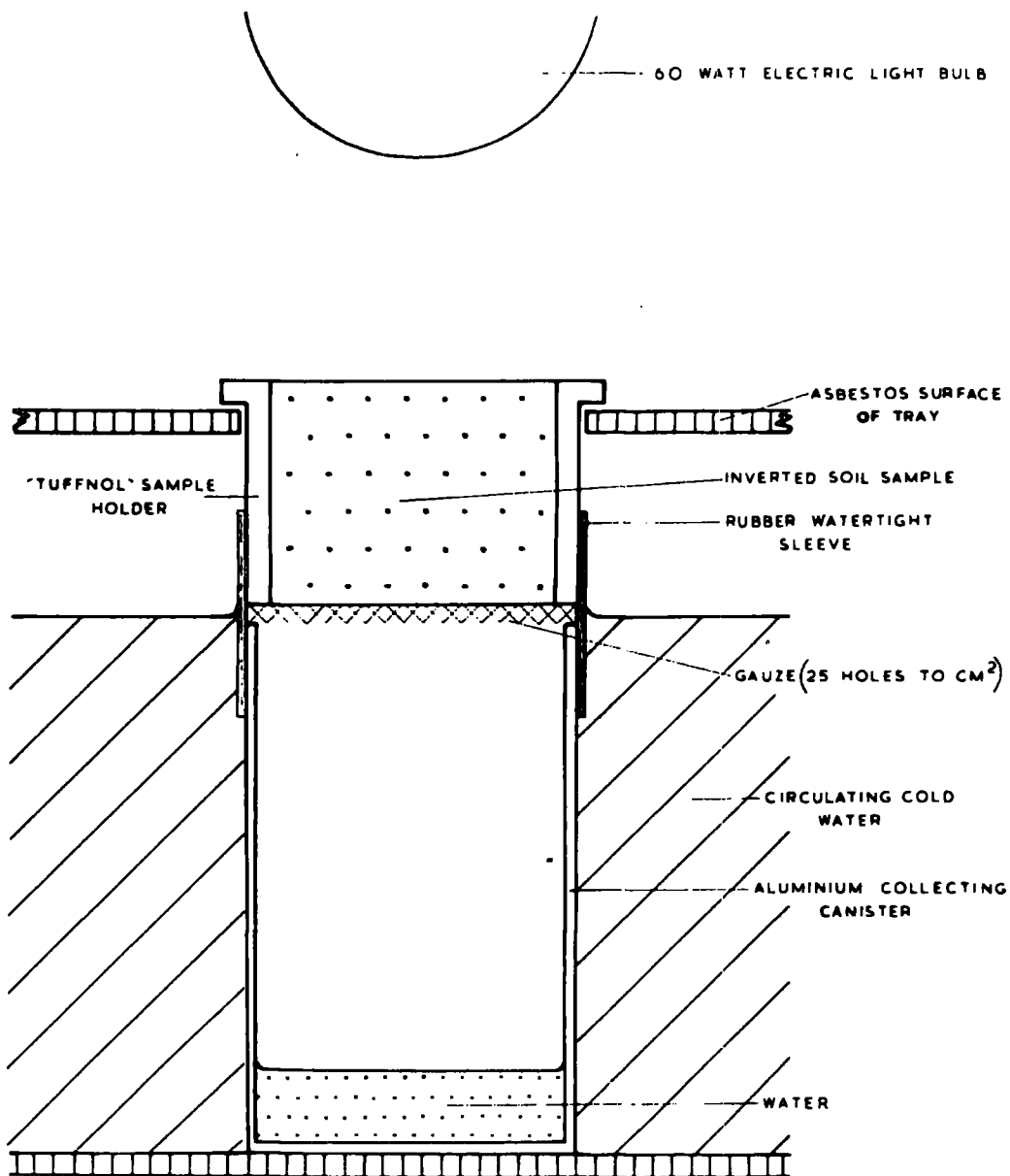

5 CM

the process has been demonstrated by Macfadyen (1961). The relative humidity within the collecting canister is about 100 per cent. In this apparatus a combination of repellent stimuli (heat, desiccation and light), and attractant stimuli (high relative humidity in the collecting canister) are the main factors in inducing the arthropods to leave the soil samples. Desiccation has been suggested by Nef (1962) as the main factor responsible for the movement of Acarina from litter samples in the Tullgren funnel extractor.

The apparatus is shown in plate 12. It consists of two trays holding a total of 32 extractor units (16 per tray). The trays form the water baths for the collecting canisters, and cold water is circulated through them during the extraction. A Zenith variac transformer (type 100M) controls the voltage passing through the electric light bulbs, and in this way the temperature is controlled. A pilot bulb on the outside of the apparatus indicates when a heating bulb has ceased to function. There is no controlled draught system in this apparatus.

It was found that a three day extraction period was the most suitable for Acarina with the heating controlled at the following voltages:-

0-24 hr.	60 volts
24-48 hr.	100 volts
48-72 hr.	140 volts

Plate 12.

The high-gradient extraction apparatus, showing the method of fitting the extraction units into the trays containing the cooling water. The extractor takes 32 sample units at one time. The Variac transformer which controls the voltage applied to the heating bulbs is fitted between the two extractor trays. The pilot lights indicate whether or not the heating bulbs are functioning.

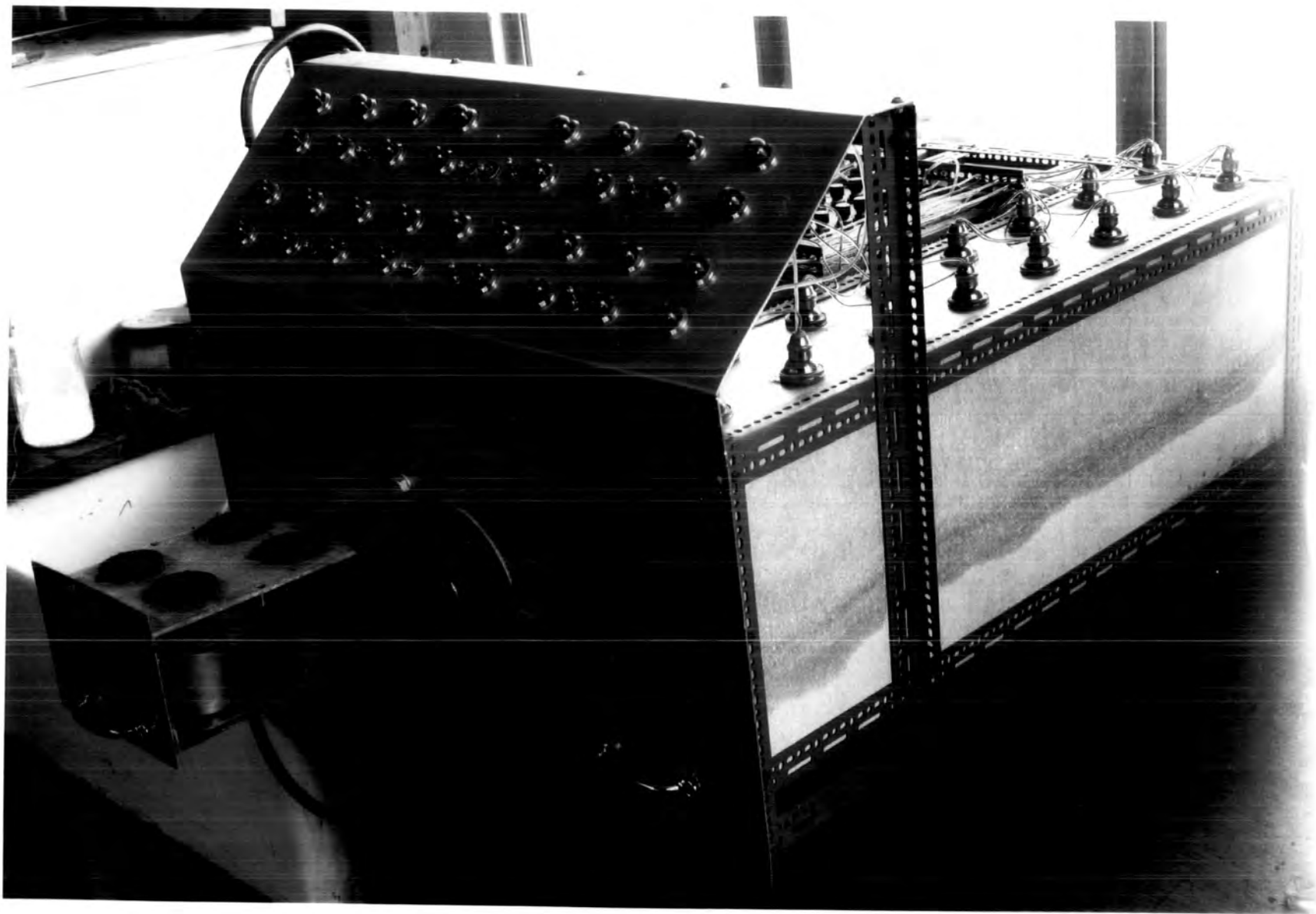

The soil sample was completely dried out at the end of the 72 hours. Due to the short extraction régime it was not found necessary to use fixatives or fungicides in the collecting canisters. The micro-arthropods were not killed until the extraction was completed, when 95 per cent alcohol was sprayed into the canisters. Care was taken to wash down the walls of the canisters with alcohol to prevent loss of specimens.

Hale (1962) using the same apparatus and a similar extraction régime recorded a temperature gradient of 60°C. in the soil samples after 60 hours of extraction, using mercury thermometers. Fig. 6 shows the temperature gradients in peat and mineral soil samples which were measured in the present study with thermistors. Final temperature gradients of 60-70°C. were measured, and further data on this aspect are given below.

d) Sorting process:

Each canister removed from the High Gradient apparatus contained the Acarina and other micro-arthropods from one sample core 3 cm. in depth. The Acarina were preserved for counting and analysis by the addition of 95 per cent alcohol to the water in the canister as described above.

The sample extracts were examined as soon as possible after extraction to reduce the loss of material through the growth of microfungi. For counting purposes the contents

of each canister was washed with alcohol into a vertical sided petri dish of 10 cm. diameter, the bottom of which had been squared in centimetres by a diamond pencil. The fields thus formed in the counting dish were scanned under a binocular microscope with a magnification x30. Direct illumination was used in conjunction with both light and dark backgrounds.

The Acarina were systematically removed from the dish by means of a minute wire spatula (see Harding and Washtell, 1950), first from the liquid surface, then from the bottom and finally from around the edge of the dish. The whole area of the counting dish was thus covered twice, and individuals caught in the meniscus were recovered by the final search of the edge of the dish. The Acarina were transferred to a glazed porcelain plate containing separate compartments into which the various groups of mites were sorted.

Each species from the sample was identified and counted and recorded on a data sheet. As a check on the total number of Acarina the group totals from the separate compartments of the counting dish were summed for each sample.

Doubtful specimens were cleared and mounted in lactic acid and identified as described in Section IV.

e) The High Gradient Extraction Process :

1. Temperature Gradient :-

Haarlov (1947 and 1955) has correlated the migration of fauna out of soil samples in a Tullgren apparatus with measurements of temperature and relative humidity inside and outside the samples. Temperatures of 38-43°C and a relative humidity of 25-30 per cent after 30 hours of extraction were recorded. It has been shown by Macfadyen (1955) that the control of temperature and humidity above, within, and beneath the soil sample can increase the yield from funnel extractors. Macfadyen (1961) claims that the temperature gradient in the soil sample is steep in the high gradient extractor, being entirely dependent upon the temperature of the cold water bath and the heating element.

The temperature was measured throughout a normal three day extraction régime in the high gradient apparatus used in the present study. Observations were made at intervals during the extraction at three points in the soil sample as follows -

- i. At the surface and in the centre of the soil sample nearest the heating bulb.
- ii. At a depth of 1.5 cm. from the surface and in the centre of the sample.
- iii. At the bottom (3cm.) and in the centre of the sample, i.e. in the vegetation layer and furthest away from the heating bulb.

The temperature was measured by Stantel 'Type F' thermistors, by measuring their change of resistance with temperature on a Wheatstone bridge circuit. The thermistor probes were sited as described above in the sample in previously drilled holes in the Tuffnol sample holder, and were sealed in position with 'Bostick 5' sealing agent.

Thus a picture of the temperatures and the temperature gradient throughout the extraction was obtained. The temperature gradient is the difference in temperature between the top and bottom of the soil sample at any one time. Temperatures were recorded from four samples 3 cm. deep each of peat and mineral soil. Temperature curves typical of these two soil types are shown in Fig. 6. The development of the temperature gradient with extraction time in a sample of mineral soil from the Limestone Grassland site at Moor House is shown in Fig. 7. The final temperature gradient at the end of the extraction was 70 centigrade degrees in 3 cm. in this case. Further temperature gradients measured are given in Table 10.

From Table 10 it can be seen that the temperature gradients in the peat samples are steeper at the three recorded times in the extraction than in the mineral soil samples. Reference to Fig. 6 shows that this is the case throughout the whole of the extraction. This fact may be accounted for by the different physical properties of organic peat and

Fig. 6(a).

Graph of the temperatures recorded in a peat soil sample during the extraction process in the high-gradient apparatus. The positions of the three thermistor recording points, (A, B, and C) within the soil sample are indicated in the inset. The temperatures recorded in the water bath outflow, and in the extraction room were the same as those shown in Fig. 6(b). The heating voltages are shown.

TEMPERATURES IN SOIL SAMPLES DURING EXTRACTION

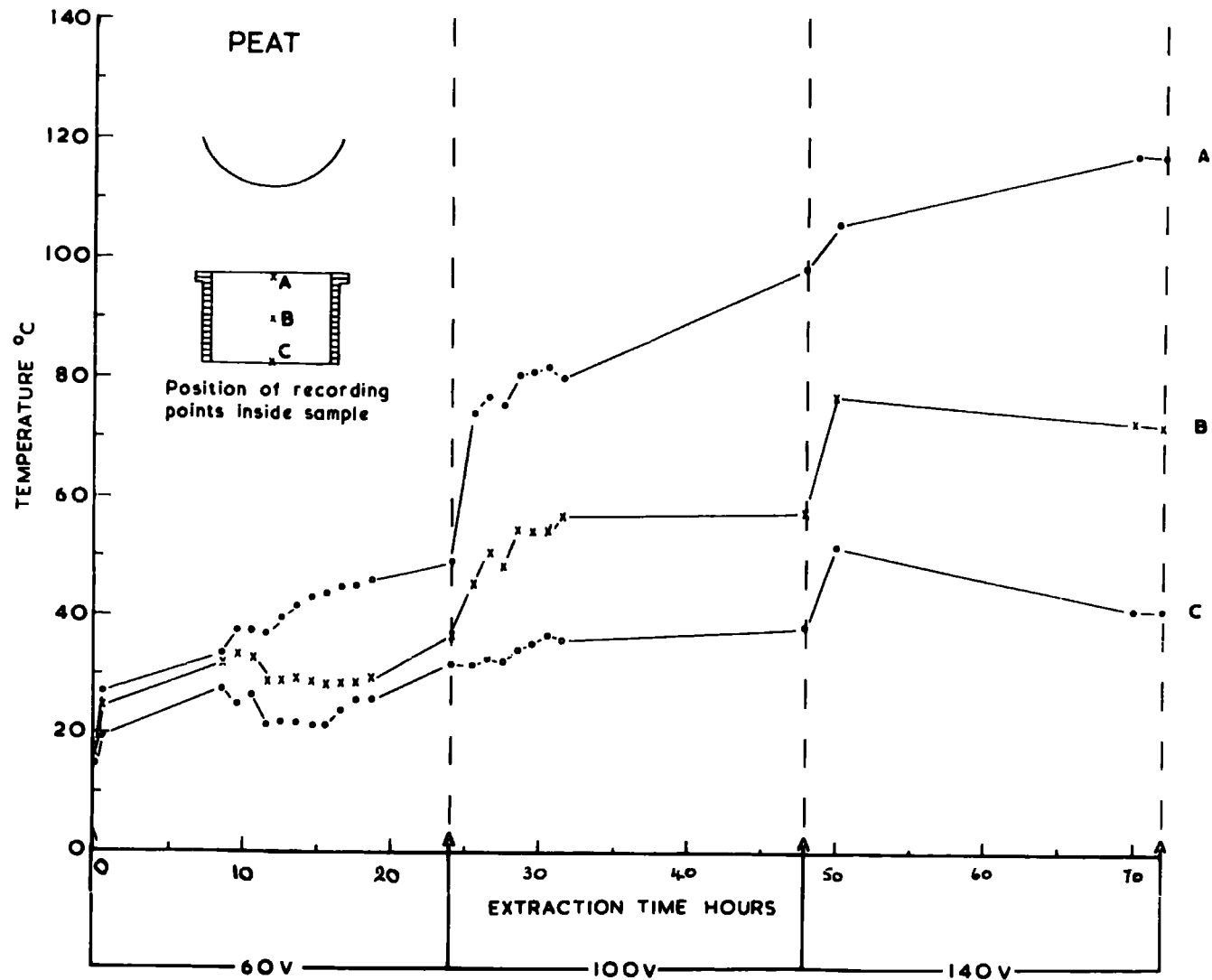

FIG. 6.(a)

Fig. 6(b).

Graph of the temperatures recorded in a mineral soil sample during the extraction process in the high-gradient apparatus. The position of the three thermistor recording points, (A, B, and C), are as indicated in Fig. 6(a). The mean weights of 15 mineral soil samples, (each 11.35cm^2 in surface area and 3cm. deep) are shown throughout the extraction, indicating the rate of water loss from the samples.

TEMPERATURES IN SOIL SAMPLES DURING EXTRACTION

MINERAL SOIL

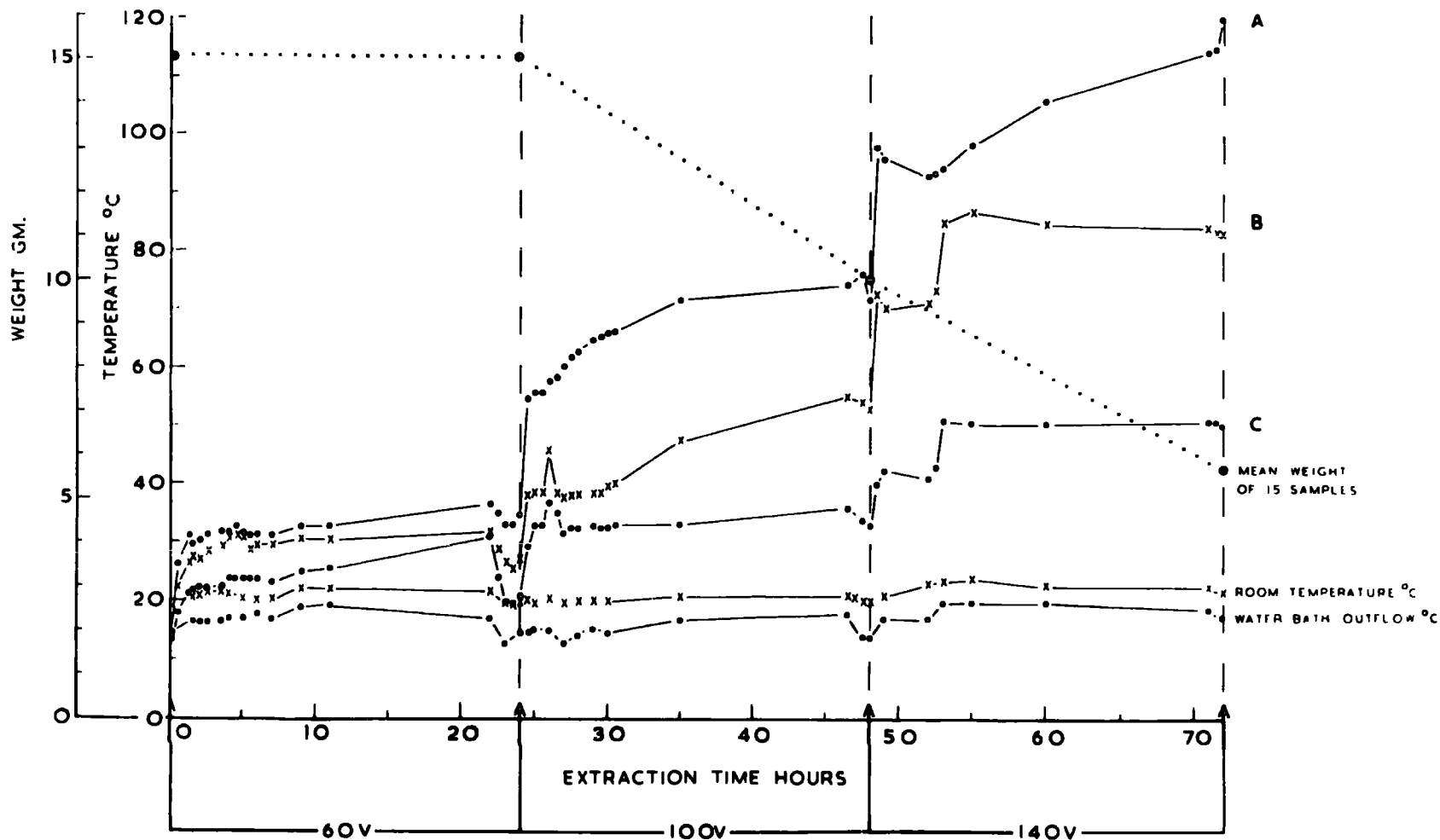

Fig. 7.

The temperature gradient (in Centigrade degrees) in a mineral soil sample throughout the extraction in the high-gradient apparatus. The positions of the recording points (A, B, and C), in the soil sample are indicated in the inset; and the heating voltages are shown.

TEMPERATURE GRADIENT IN MINERAL SOIL SAMPLE

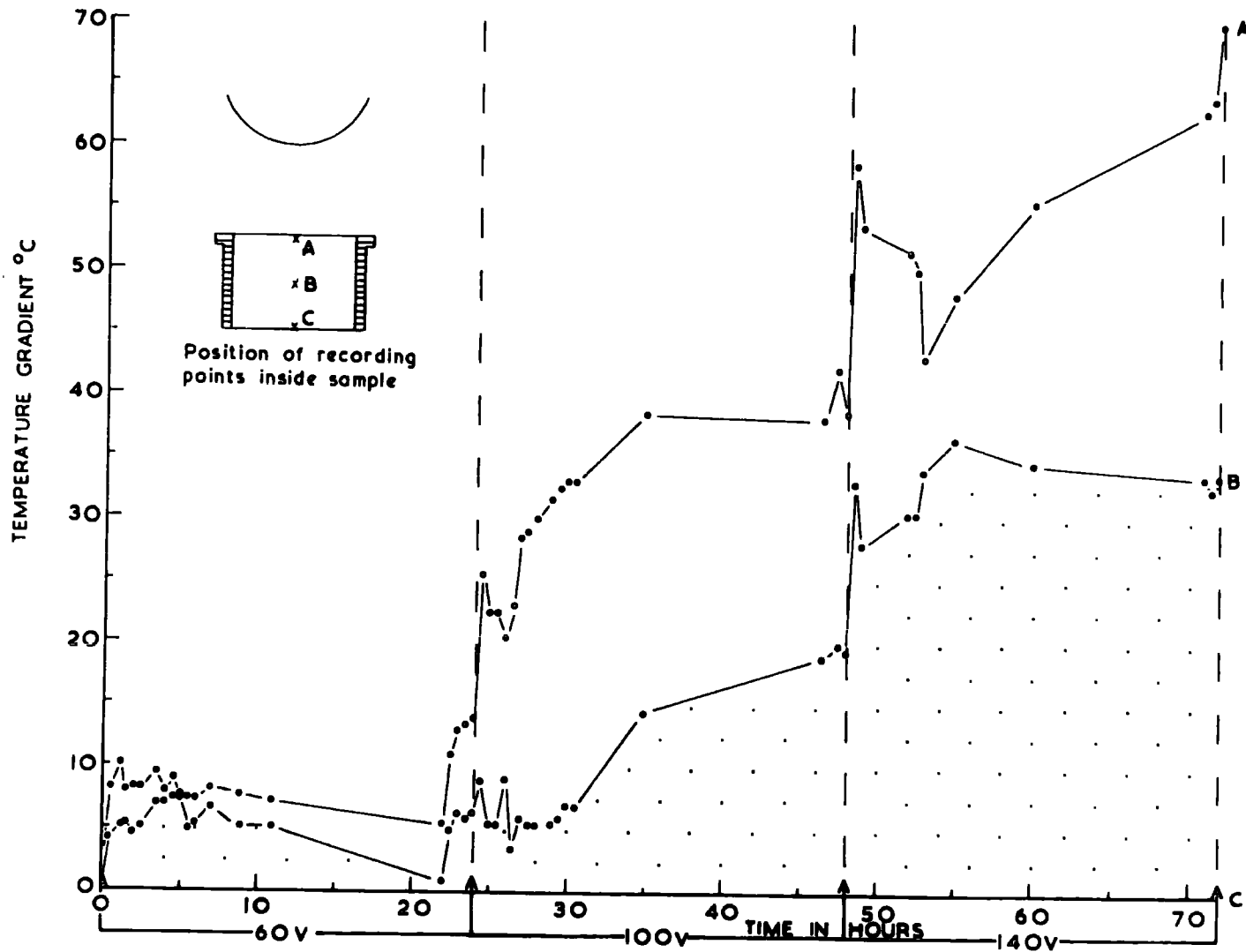

FIG. 7.

mineral soil, and in particular the dark colour of peat when wet and its porous nature.

Table 10. Temperature gradients recorded in soil samples in the high gradient extractor. Each figure is the mean of four readings.

Extraction stage	Temperature gradient (centigrade degrees) in 3 cm. in mineral soil.	Temperature gradient (centigrade degrees) in 3 cm. in peat soil.
At 24 hr.	13.2	19.0
At 48 hr.	43.9	53.0
At 72 hr.	67.4	77.7

2. Humidity :-

Macfadyen (1962) has shown that in the high gradient cylinder extractor there is a steep humidity gradient throughout the extraction, which results in condensation occurring below the level of the sample in the collecting canister. A relative humidity of approximately 90-95 per cent exists just below the sample (Macfadyen, 1961).

The humidity gradient in the extractor used in this study was not measured, but notes on the condition of 15 soil samples each 3 cm. deep during a normal extraction are given below:

1. After 24 hours extraction the samples were drying out at the upper surface nearest the heating bulb. The lower vegetation surface was extremely moist,

more so than when the samples were first placed in the extractor. Heavy condensation had appeared on the walls of the collecting canister, well below the level of the sample.

- ii. After 48 hours extraction the soil samples had thoroughly dried out at the surface, and the lower vegetation surface was drier than at 24 hours, although still remaining damp. Condensation was present on the walls of the collecting canister.
- iii. After 72 hours of extraction the samples were completely dried out. A small amount of condensation remained on the walls of the collecting canisters.

The mean rate of water loss from 15 samples of mineral soil during a three day extraction is plotted on Figure 6. Little water is lost from the samples during the first extraction period (0-24 hours), but thereafter there is a steady loss of water up to the end of the extraction process at 72 hours.

3. Emergence of fauna :-

The emergence of the fauna from the soil samples in the high gradient extractor is shown in Fig. 8. The values are the percentages of the total number of animals extracted from 15 sample units. The samples were of mineral soil from the Limestone Grassland site, each sample was 11.35 cm.² in surface area and 3 cm. deep. The extraction pattern of the Acarina was different from that of the Collembola. There was

Fig. 8.

The emergence of the fauna from mineral soil samples during the extraction process in the high-gradient apparatus. The total number of each animal group extracted from 15 sample units (each 11.35 cm² in surface area and 3 cm. deep) is shown below the group name. The histograms indicate the percentages of the total of each animal group extracted, per 12 hour period. The heating voltages were increased every 24 hours as in the normal extraction régime.

Fig.8.

EMERGENCE OF FAUNA DURING EXTRACTION

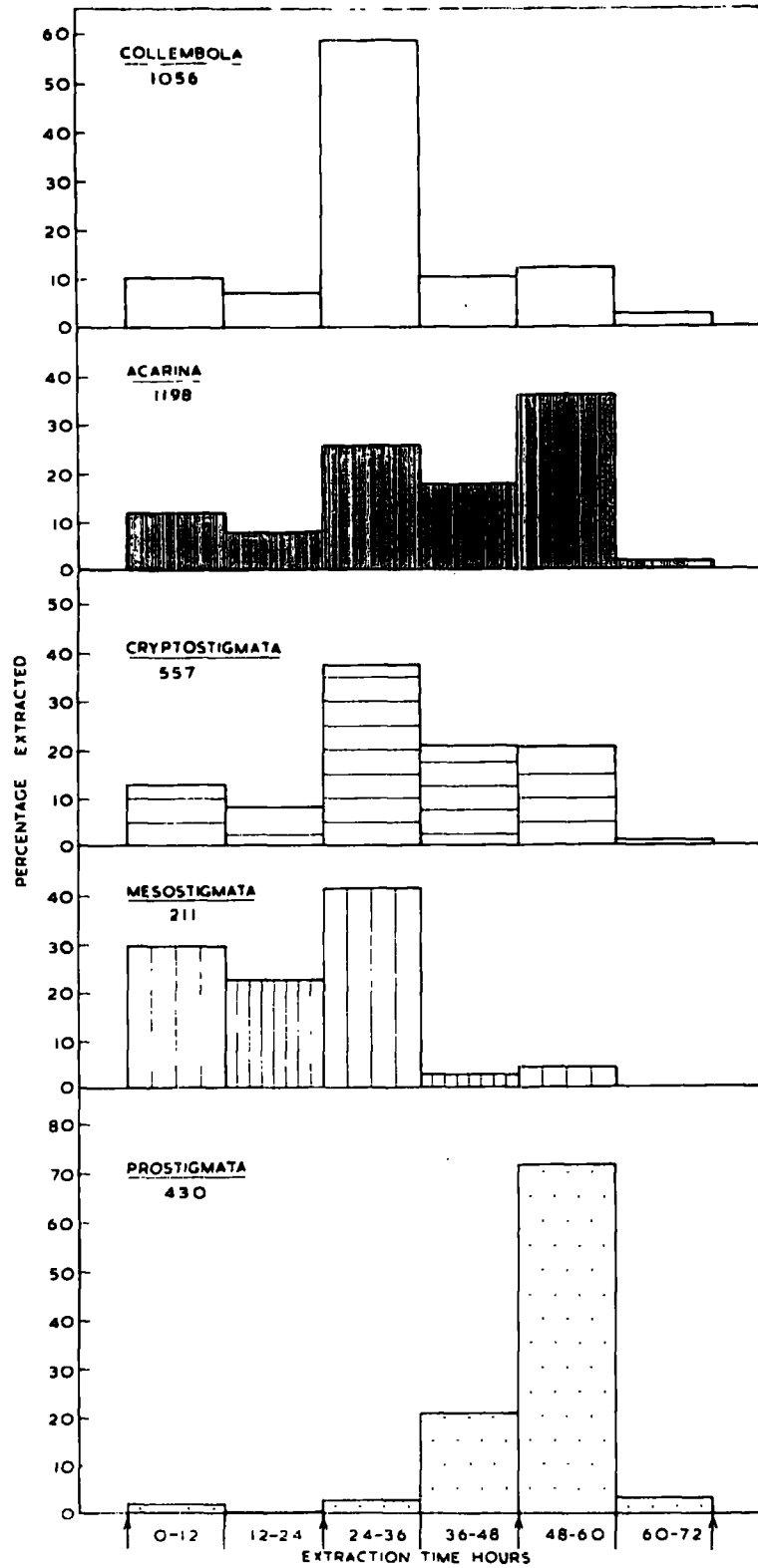

a main peak of emergence (58 per cent) of Collembola during the period 24-36 hours of the extraction, whereas only 25 per cent of the mites emerged over the same period. The majority of the Acarina were extracted over a longer time (24-60 hours) in the extraction process. For both groups there was an initial emergence of 10 per cent of the total fauna in the first period (0-12 hours).

The Cryptostigmata emerged in their highest numbers during the 24-60 hour period of the extraction. The emergence of the Mesostigmata was confined to the early stages of extraction from 0-36 hours. The Prostigmata emergence peak was between 48-60 hours, when 70 per cent of the total numbers were extracted. Thus there was a different pattern of emergence for the separate groups of the Acarina.

The majority of juvenile forms of the Cryptostigmata emerged during the 24-36 hours of the extraction in greatest numbers (39 per cent of total), along with the following species: Achipteria coleoptrata, Pelops plicatus and representatives of the Oppia-Suctobelba group. Platynothrus peltifer, a moisture loving species, emerged early in the extraction (39 per cent of total numbers in the 0-12 hour period). Specimens of Nanhermannia nana emerged in greatest numbers during 0-12 hours and 24-60 hours of the experiment. Tectocephus velatus had two emergence peaks: 24-36 hour and 48-60 hour period.

The majority of Trachytes pyriformis, Olodiscus minima,

Parasitidae, and Zerconidae left the samples during the 24-36 hour extraction period.

It is impossible to separate the effects of heat and desiccation in the extraction process. It has been suggested by Nef (1962) that with most species of Acarina the peak of movement out of litter in a Tullgren-funnel appeared to be related to the degree of desiccation. Species such as Tectocephus velatus and Oppia were definitely influenced by temperature in the latter study. The bulk of the Acarina left the samples in the present study in two main groups during the 24-36 hour and 48-60 hour extraction periods, when the rate of water loss from the samples was increasing (Fig. 6) resulting in a lowering of the relative humidity within the soil samples, and when there was a sharp development in the temperature gradient within the samples (Fig. 7).

4. Efficiency of high gradient extractor :-

The efficiency of the apparatus used in the study was tested by placing live mites into sterile soil samples and extracting over a normal régime. Fifteen samples of mineral soil were used, each 11.35 cm^2 in surface area and 3 cm. deep. The soil samples were first sterilised in an air oven for three days at a temperature of 105°C to kill the fauna, and then allowed to recover by soaking in tap water for three days. The water content was made as near as possible to that in the field. Into the vegetation layer of each

sterile soil sample were placed 10 live mites. After the lapse of one hour, the samples were placed in the extractor as normal and extracted. The numbers and percentage recovery of the fauna are shown in Table 11. Adult specimens only were used in this experiment.

Table 11. Recovery of Acarina inserted into sterile soil samples by the high gradient extractor. The figures are the total number of specimens for 15 samples each 11.25 cm² in surface area and 3 cm. deep.

Group	Number introduced.	Number recovered.	Percentage recovery.
Cryptostigmata	90	69	77
Mesostigmata	40	34	85
Prostigmata	20	11	55
Total Acarina	150	114	76

The high percentage recovery of the Mesostigmata may be due to their greater mobility. It should be stressed that these figures are only estimates of the efficiency of the high gradient extractor and should not be regarded as actual efficiencies for the groups tested. Extraction efficiency is influenced by several factors as Murphy (1962) has shown with the split-funnel extractor using samples from heathland soils.

f) The Flotation Extractor :

Morris (1922), Ladell (1936), Salt and Hollick (1944) and Raw (1955) have designed and developed flotation methods for separating arthropods from mineral soils. Murphy (1962), Raw (1962) and Macfadyen (1962) have reviewed flotation extraction methods for soil animals.

Flotation methods are based on the principle that organic material floats in a solution of specific gravity of 1.2 such as magnesium sulphate, whereas mineral matter sinks. These methods are clearly of little value when it is required to extract micro-arthropods from soils of high organic content such as peat or forest litter. Hale (1962) has developed a flotation extractor for use on peaty soils, and full details of the design of the apparatus is given in Hale (1962). This extractor employs the principle that plant material sinks in water when boiled at room temperature under reduced pressure. The micro-arthropods are brought to the surface of the water by the hydrophobic nature of their cuticles, and by subsequently bubbling air through the liquid.

It was decided to test the flotation apparatus, which was developed primarily for the extraction of Collembola from peat soils, and to determine its efficiency for the extraction of Acarina from the same soil type.

The design of a single unit of the flotation extractor is shown in Fig. 9, and in Plate 14. Plate 13 gives a

Fig. 9.

A single unit of the flotation extractor showing the parts described in the text.

Fig.9.

SINGLE UNIT OF FLOTATION EXTRACTOR

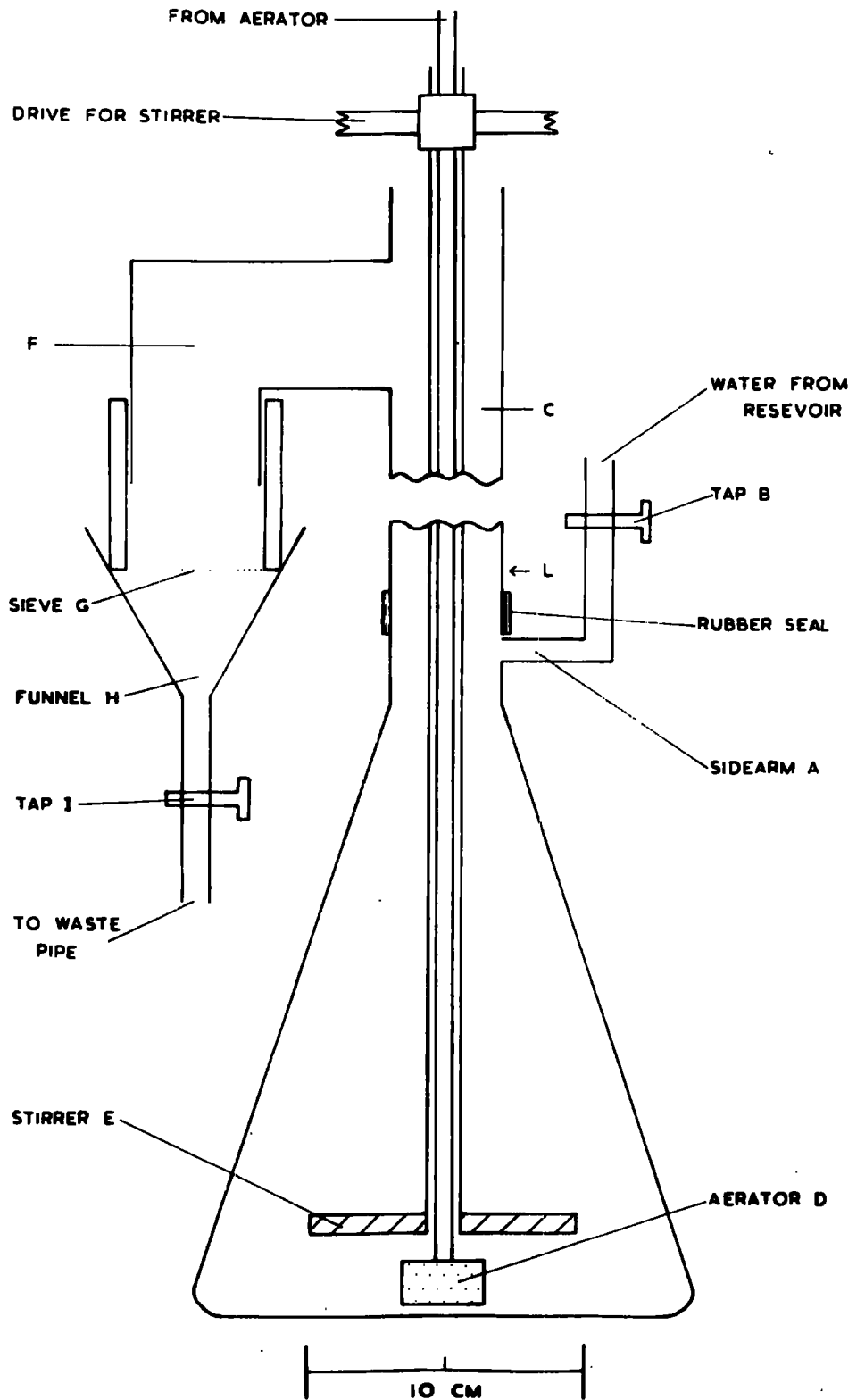

Plate 13.

A general view of the flotation extraction apparatus, showing the 20 extractor units. The motor for driving the stirrers can be seen at bottom right, and in front of it is the aeration pump. A time switch which controls the stirring and aeration is also situated at the bottom right. At top right can be seen the reservoir which supplies water to the extractor units.

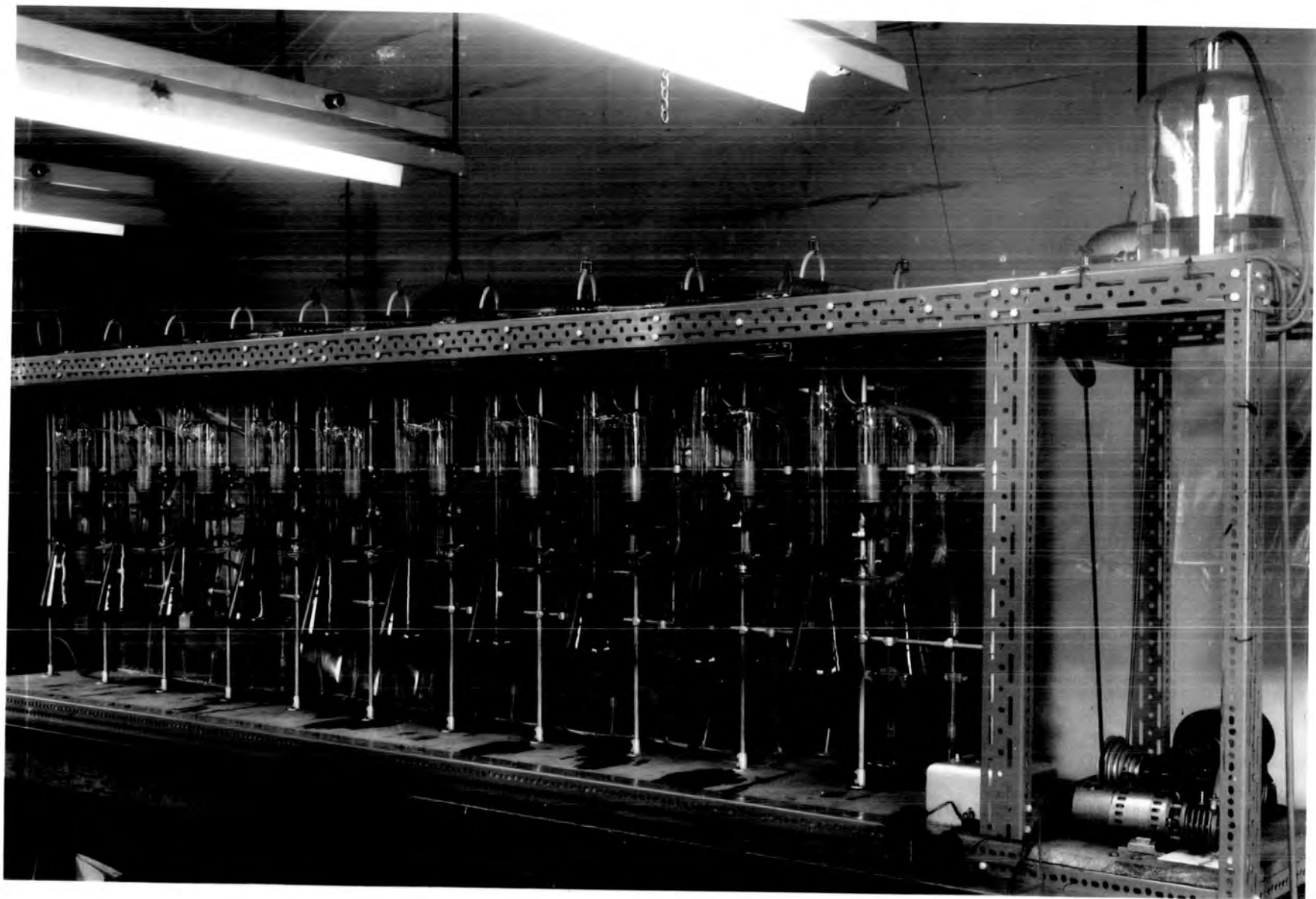
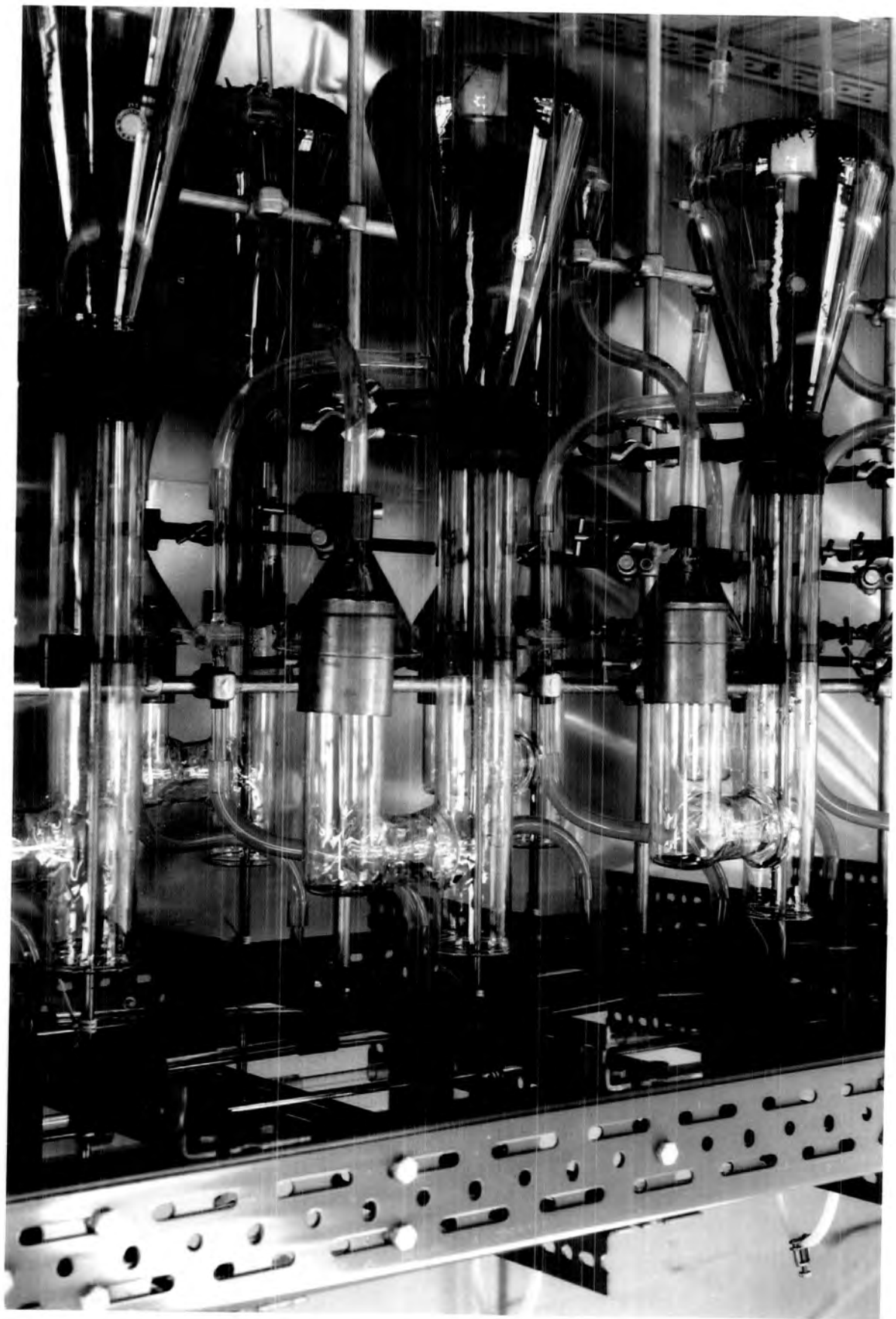

Plate 14.

A close up view of a single extractor unit of the flotation apparatus. The Mhor's clip which is used to regulate the flow of air into the apparatus can be seen at the top left. The silver steel driving rod, carrying spiral gears, can be seen running in 'Tuffnol' bearings along the top of the apparatus. The sieve for trapping the extracted animals is contained in the brass cylinder situated in the filter funnel to the waste pipe.



general view of the apparatus which consists of 20 units. The stirrers were driven by an electric motor (bottom right of Plate 13) by means of spiral gears fitted at regular intervals along each of two silver steel driving shafts with 'Tuffnol' bearings. A vacuum pump (bottom right of Plate 13) supplied air to the extractor units.

The procedure for extraction was as follows:

A. The soil sample is first washed through two sieves (each of 10 apertures to the square inch) with tap water jets to break it down, and the washings are then introduced into a two-litre flask fitted with a sidearm (Fig. 9).

B. The flask is corked securely, connected to a vacuum pump, and the contents boiled under reduced pressure at room temperature for 30 seconds.

C. The flask is then connected to the rest of the apparatus as shown in Fig. 9 and Plate 14.

D. Water is run in through A by means of tap B from a reservoir (top right of Plate 13) until it reaches level L. It is recommended to maintain a low level of liquid in the column C to prevent loss of micro-arthropods from the top of the apparatus.

E. Air is blown in through aerator D in a stream of very fine bubbles. The stirrer E stirs for a period of one minute in every period of five minutes; this is achieved by means of a time switch (bottom right of Plate 13).

F. At hourly intervals the level of the water in tube C is raised so that the floating material passes over into tube F and thence into a fine mesh sieve G of 360 mesh phosphor-bronze (aperture: 0.042 mm.). The water passes through the funnel H and into a waste pipe which runs the length of the apparatus.

G. Alcohol (75 per cent) is sprayed into G to kill the micro-arthropods collected there. The fauna is removed from the sieve at hourly intervals by washing with alcohol into a collecting vessel.

H. The level of the water in tube C is then returned to the level L by increasing the rate of bubbling through the aerator D. This is carried out by releasing the Mhor's clip on the air inlet at the top of the extractor unit, (top of apparatus in Plate 14). On retightening the clip the water level returns to level L.

It was determined by Hale (1962) that the optimum extraction time for Collembola was five hours, raising the water level hourly. The same procedure was used in the present experiment.

The flotation extractor was initially tested by placing a known quantity of arthropods in water in one unit of the apparatus and extracting for five hours, raising the water level hourly. The results given in Table 12 show that there was a high percentage recovery for the Acarina, and the

Cryptostigmata were recovered with a greater efficiency than the Mesostigmata. A recovery efficiency of 98 per cent for Collembola has been shown by Hale (1962), and the low recovery of this group in the present study may be due to the author's unfamiliarity with the Collembola.

Table 12. Recovery of arthropods from water after pressure reduction and aeration for five hours in the flotation extractor.

Group	Number introduced	Number recovered	Percentage recovery
Cryptostigmata	100	98	98
Mesostigmata	36	32	89
Total Acarina	136	130	96
Collembola	60	49	82
Araneida	4	2	50
Pseudoscorpionida	5	4	80
Diptera - Adults	3	2	67
" - Larvae	8	7	87
Coleoptera - Adults	9	6	67
" - Larvae	21	15	71

g) Comparison of high gradient and flotation extractors :

A comparison of the Tullgren-funnel and a modified Salt and Hollick flotation technique for extracting Acarina from mull and moder woodland sites has been made by Satchell and Nelson (1962). There was no significant difference

between methods for numbers of Acarina recovered from the mull site, but on moder, the number extracted by flotation was 44 per cent greater. The flotation method used was more efficient in extracting Scutacaridae, Steganacarus magnus and hypopi of the Astigmata from the moder site. The numbers of Nothrus silvestris and Tectocephus velatus were significantly greater in the funnel extractions from the moder site.

A comparison of the flotation and high gradient extraction methods was made simultaneously on peat samples from the mixed Calluna moor and mineral soil samples from the Limestone grassland. Fifteen sample units each 11.35 cm² in surface area and 3 cm. deep were used for each extraction method from each site. The samples were collected on 12 November 1962 and the extractions were begun on the same day. The data are compared in Tables 13 and 14, and the significance of differences between the means resulting from the two extraction methods is tested using the standard error of the difference.

There was a significantly greater mean number of Acarina extracted by the high gradient apparatus than by the flotation method for both the peat and mineral soil. This was almost entirely caused by the Cryptostigmata, which were extracted in significantly higher numbers by the high gradient extractor than by flotation. The juvenile forms of the Oribatei showed a similar difference. The Mesostigmata

Table 13. Comparison of the efficiency of extraction of Acarina by the high gradient and flotation extractors. Peat samples from mixed Calluna moor, 12 November₂, 1962. The figures are the means of 15 sample units each 10 cm. in surface area and 3 cm. deep.

Group or Species	Mean of 15 sample units from high gradient extractor (A)	Mean of 15 sample units from flotation extractor (B)	Difference between means (A-B) and S.E. of difference	Probability
Acarina	108.54	53.49	55.05 ± 21.12	<0.01
Mesostigmata	4.05	6.45	-2.40 ± 1.50	N.S.
Cryptostigmata	103.19	47.04	56.15 ± 20.49	<0.01
Prostigmata	1.29	0.0	1.29	N.S.
Astigmata	0.0	0.0		
<u>Carabodes marginatus</u>	3.64	0.74	2.90 ± 1.92	N.S.
<u>Carabodes minusculus</u>	7.34	4.21	3.13 ± 7.56	N.S.
<u>Platynothrus peltifer</u>	0.82	0.80	0.02 ± 0.55	N.S.
<u>Nanhermannia nana</u>	2.70	2.54	0.16 ± 1.03	N.S.
<u>Oppia-Suctobelba</u>	1.82	0.0	1.82 ± 0.75	<0.02
<u>Tectocephus velatus</u>	9.22	3.21	6.01 ± 3.81	N.S.
<u>Chamobates schutzi</u>	5.35	1.60	3.75 ± 1.48	<0.02
<u>Melanozetes mollicomis</u>	1.70	0.0	1.70 ± 1.02	N.S.
<u>Phthiracarus ligneus</u>	0.64	0.70	-0.06 ± 0.74	N.S.
Juvenile Cryptostigmata	68.13	33.24	34.89 ± 14.26	<0.02
<u>Parasitidae</u>	3.41	4.82	-1.41 ± 1.22	N.S.

Note: N.S. = Not significant.

Table 14. Comparison of the efficiency of extraction of Acarina by the high gradient and flotation extractors. Mineral soil samples from the Limestone grassland, 12 November 1962. The figures are the means of 15 sample units each 10 cm² in surface area and 3 cm. deep.

Group or Species	Mean of 15 sample units from high gradient extractor (A)	Mean of 15 sample units from flotation extractor (B)	Difference between means (A-B) and S.E. of difference	Probability
Acarina	74.65	25.53	49.15 ± 8.71	<0.001
Mesostigmata	14.62	9.87	5.15 ± 1.92	<0.01
Cryptostigmata	34.53	11.15	23.38 ± 5.96	<0.001
Prostigmata	25.49	4.51	20.98 ± 4.53	<0.001
Astigmata	0.0	0.0		
<u>Carabodes marginatus</u>	0.53	0.0	0.53 ± 0.60	N.S.
<u>Platynothrus peltifer</u>	1.06	0.50	0.56 ± 0.49	N.S.
<u>Nanhermannia nana</u>	1.47	0.51	0.96 ± 0.59	N.S.
<u>Achipteria coleoptrata</u>	1.52	0.54	0.98 ± 0.54	N.S.
<u>Oppia-Suctobelba</u>	2.18	1.12	1.06 ± 0.84	N.S.
<u>Pelops plicatus</u>	2.93	1.46	1.47 ± 0.93	N.S.
<u>Tectocephus velatus</u>	2.82	1.40	1.42 ± 0.94	N.S.
Juvenile Cryptostigmata	20.20	5.62	14.58 ± 3.69	<0.001
<u>Parasitidae</u>	3.11	2.81	0.30 ± 0.77	N.S.
<u>Trachytes pyriformis</u>	3.58	2.00	1.58 ± 1.16	N.S.
<u>Olodiscus minima</u>	2.40	1.19	1.21 ± 0.57	<0.05
<u>Rhodocarus roseus</u>	1.58	0.70	0.88 ± 0.66	N.S.
<u>Zerconidae</u>	3.76	0.0	3.76	<0.001

Note: N.S. = Not significant.

were extracted in significantly higher numbers by the high gradient apparatus than by flotation from the mineral soil samples, but not from the peat. The mean number of Mesostigmata extracted from peat was higher by flotation than by the high gradient method, but the means were not statistically significant. For the Prostigmata, there was no significant difference between the means obtained by the two methods on the mixed moor samples; but the high gradient apparatus was significantly more efficient in extracting this group from the mineral soil.

~~The high gradient apparatus used was significantly more efficient in extracting this group from the mineral soil.~~

The high gradient apparatus used was significantly more efficient than the flotation method for extracting Zerconidae from the mineral soil, and Chamobates schutzi and species of the Oppia-Suctobelba group from peat soil.

In this experiment there was not a single instance of the flotation method being more efficient than the high gradient apparatus for extracting Acarina from peat and mineral soils. This was to be expected from mineral soil as the flotation method was developed primarily for peat substrates. It may be concluded that the mean number of Acarina extracted by the high gradient apparatus is 34 per cent greater for the peat soil and 50 per cent greater for

the mineral soil than the mean number extracted by the flotation method.

VI HORIZONTAL DISTRIBUTION

a) Introduction :

It is known that many soil animals show a patchy spatial distribution. The animals which are grouped together in a relatively high density are termed an aggregation. As Elton (1949) has pointed out, this type of distribution is to be expected of animals living in a heterogeneous environment such as the soil. Aggregated distributions have been observed in various soil animal groups :- Nematoda: Overgaard (1948), Banage (1960); Enchytraeidae: Nielson (1954), Peachey (1963); Lumbricidae: Satchell (1955); Symphyla: Edwards (1955); Protura: Raw (1956); Collembola: Glasgow (1939), Wallace (1957), Poole (1961), and Hughes (1962); Acarina: Macfadyen (1952), Haarløv (1960), Hartenstein (1961), and Nef (1962). No examples of random distributions in soil animals have been recorded.

Macfadyen (1952) has shown a large scale uniform distribution of mites and Collembola within plant types of a Molinia fen, and a small scale patchy distribution by paired samples in the same habitat. The degree of aggregation of Protura in grassland soil has been shown by Raw (1956) to be independent of the population density. Hartenstein (1961) concluded that the negative binomial distribution afforded the best fit to the distribution of micro-arthropods in forest soils while Nef (1962) and

Debauche (1962) have similar results for the distribution of species of Cryptostigmata in woodland litter. For calculation of the frequency values of the negative binomial distribution, a value \underline{x} is replaced by $(x+k)$, \underline{k} being estimated by the method of Bliss and Owen (1958) or from the estimated mean (\underline{m}) and variance (\underline{s}^2) as

$$k = m^2 / (s^2 - m)$$

Thus the negative binomial approaches the Poisson distribution as \underline{k} becomes large.

There are three methods available for the study of aggregation in soil animals:

1. The complete enumeration followed by mapping of all animals to a known depth of soil, as used by Salt and Hollick (1946) for the study of wireworm populations.
2. The use of the paired sampling technique (Hughes, 1962) to estimate the mean radius and the number of animal aggregates.
3. The analysis of the results of random sampling.

In the present study the data from random sampling at Moor House have been analysed and the results are given below. The purpose of this attempt has been to detect the presence rather than to analyse the degree of aggregation with precision. Such an analysis, although incomplete, is valuable and may help to clarify the ecological processes operating on the organisms, when related to other factors

such as environment and their biology.

b) Methods of study and results :

- (i) The detection of aggregation by the coefficient of dispersion.

Fisher's coefficient of dispersion or the relative variance, which was used to determine whether the animals were aggregated or not, is the ratio of the variance and the mean and may be expressed :-

$$\text{C.D.} = \frac{\sum (x - \bar{x})^2}{\bar{x}(n-1)} \quad \text{or} \quad \frac{s^2}{\bar{x}}$$

Where x is the number of individuals from each sample unit, \bar{x} is the mean value of the sample units, n is the number of sample units, and s^2 is the variance.

When the coefficient of dispersion is < 1 there is an even distribution (or over-dispersion); when it is equal to unity there is a random (or Poisson) distribution; and when it is > 1 there is aggregation (or under dispersion). The divergence from unity is regarded as significant if it exceeds

$$1 \pm 2 \sqrt{\frac{2n}{(n-1)^2}}$$

where n is the number of sample units. In the present study, where samples of 15 units were used, this value is 1 ± 0.783 .

Greig-Smith (1952) has emphasised the importance of quadrat (or sample unit) size in any study of aggregation.

A sample unit which is either too large or too small may give a false impression of a random population. Thus there is for any population an optimum sample unit size for detecting aggregation, which can be determined by taking sample units of varying size.

The coefficients of dispersion were calculated for Acarina from two sample sites: Limestone grassland and mixed Calluna moor, and these are given in Tables 15 and 16. For the total Acarina the coefficient of dispersion was significantly greater than unity in all cases. On a single occasion (17 July 1961; Limestone grassland site) the coefficient of dispersion for juvenile Cryptostigmata was not significant; Haarløv (1960), using a similar sample size (:10 cm²) as in the present study, calculated the mean coefficient of dispersion for the Oppia spp. group in pasture over one year to be 14.0. The mean annual value of the coefficient of dispersion for the group at Moor House is low compared to this value and ranges from 2.0-3.5 on the study areas (Tables 15 and 16).

The coefficients of dispersion for total Acarina show a marked aggregated distribution within the size of sample used, which suggests that two or more species have aggregations in the same places. If this were not so, the different species' aggregations would tend to balance each other and result in a near random distribution. It is

Table 15. Coefficients of dispersion for Acarina from the Limestone grassland site. 15 sample units each of 10.35 cm² in surface area were collected on all dates. Coefficients of dispersion which do not show significant aggregation are indicated *.

Date	Species	Total Acarina	Total Cryptostigmata	Juvenile Cryptostigmata	<u>Oppia-Suctobelba</u>	<u>Platynothrus peltifer</u>	<u>Nanhermannia nana</u>	<u>Tectocephus velatus</u>	<u>Parasitidae</u>	<u>Pelops planicornis</u>	<u>Pelops plicatus</u>
16. 1.61.		13.7	6.4	5.2	1.5*	2.1	0.9*	5.3	4.3	4.1	5.2
13. 2.61.		8.6	7.6	10.0	1.5*	2.2	0.8*	4.9	1.7*	3.0	1.6*
13. 3.61.		6.5	7.7	5.2	2.2	5.2	1.0*	1.6*	0.9*	2.4	0.0
10. 4.61.		5.7	5.6	4.2	1.3*	1.7*	1.7*	7.0	1.3*	1.7*	2.9
8. 5.61.		5.1	4.1	2.5	4.4	1.4*	0.7*	4.2	2.1	1.6*	1.0*
5. 6.61.		3.9	3.8	3.0	3.4	1.0*	3.5	2.9	1.8	3.0	2.5
17. 7.61.		6.6	4.9	1.6*	1.6*	1.5*	2.2	2.8	1.1*	2.6	2.7
28. 8.61.		9.4	9.5	6.9	2.4	1.3*	1.0*	3.4	2.0	1.9	4.1
25. 9.61.		5.5	6.9	5.2	0.6*	7.6	2.5	7.1	1.3*	0.8*	2.1
23.10.61.		13.9	11.0	7.0	3.5	1.1*	4.2	6.4	1.4*	1.9	7.5
22.11.61.		15.8	15.9	12.2	1.3*	2.0	1.5*	4.6	1.0*	1.2*	3.4
11.12.61.		8.1	4.7	2.0	4.4	2.1	3.3	3.2	1.2*	3.4	1.4*
Mean		8.6	7.4	5.4	2.3	2.4	1.9	4.5	1.7	2.3	2.9

Table 15 (contd.)

Date	Species	Total Acarina	Total Cryptostigmata	Juvenile Cryptostigmata	<u>Oppia-</u> <u>Suctobelba</u>	<u>Platynothrus</u> <u>peltifer</u>	<u>Nanhermannia</u> <u>nana</u>	<u>Tectocephus</u> <u>velatus</u>	<u>Parasitidae</u>	<u>Pelops</u> <u>plenicornis</u>	<u>Pelops</u> <u>plicatus</u>
15. 1.62.		19.4	22.1	32.0	3.4	3.4	1.0 [Ⓜ]	4.2	1.3 [Ⓜ]	6.3	3.9
13. 2.62.		11.9	9.6	5.0	1.8	1.5 [Ⓜ]	3.7	3.2	3.3	3.1	4.7
20. 3.62.		9.9	6.8	2.1	0.8 [Ⓜ]	1.7 [Ⓜ]	5.8	2.8	2.3	11.5	2.1
3. 4.62.		11.1	9.4	3.5	2.2	4.2	3.1	5.4	1.4 [Ⓜ]	5.8	4.5
3. 5.62.		11.1	4.5	2.8	4.0	1.8	1.9	6.9	1.6 [Ⓜ]	2.9	1.0 [Ⓜ]
4. 6.62.		3.8	5.6	3.5	1.9	5.0	2.5	4.2	2.1	1.0 [Ⓜ]	1.4 [Ⓜ]
3. 7.62.		8.7	6.1	2.9	0.8 [Ⓜ]	9.0	8.1	3.5	2.1	1.5	1.8
7. 8.62.		15.7	7.6	5.3	4.3	2.3	1.4 [Ⓜ]	3.5	3.0	0.8 [Ⓜ]	2.6
1. 9.62.		9.7	8.4	4.9	3.9	2.3	6.6	7.7	1.9	0.9 [Ⓜ]	1.9
3.10.62.		3.8	5.9	4.8	1.1 [Ⓜ]	3.6	2.1	2.3	1.2 [Ⓜ]	0.9 [Ⓜ]	5.7
12.11.62.		8.2	10.2	6.9	2.7	1.9	1.5 [Ⓜ]	3.3	0.5 [Ⓜ]	1.0 [Ⓜ]	5.0
6.12.62.		1.9	22.0	14.7	4.3	3.2	6.0	4.2	3.4	1.3 [Ⓜ]	2.7
Mean		9.6	9.9	7.4	2.6	3.3	3.6	4.3	2.0	3.1	3.1

Table 16. Coefficients of dispersion for Acarina from the mixed Calluna moor site. 15 sample units each of 11.35 cm² in surface area were collected on each date. Coefficients of dispersion which do not show significant aggregation are indicated *.

Species	Total Acarina	Total Cryptostigmata	Juvenile Cryptostigmata	<u>Oppia-Suctobelba</u>	<u>Platynothrus peltifer</u>	<u>Nanhermannia nana</u>	<u>Tectocephus velatus</u>	<u>Parasitidae</u>	<u>Carabodes minusculus</u>	<u>Chamobates schutzi</u>	<u>Carabodes marginatus</u>
Date											
23. 1.61.	4.3	4.2	13.6	2.2	1.7*	1.1*	6.0	0.6*	2.0	1.4*	3.0
20. 2.61.	25.2	25.3	5.3	2.0	1.2*	3.3	5.9	1.0*	5.3	2.1	2.0
13. 3.61.	37.9	38.6	5.5	3.1	2.1	4.6	7.4	0.8*	5.5	6.9	2.2
18. 4.61.	7.4	7.4	5.5	1.5*	2.2	4.3	13.7	0.8*	5.5	4.1	5.9
14. 5.61.	30.9	31.5	7.8	0.6	0.7*	3.8	8.2	0.9*	3.8	13.5	9.1
5. 6.61.	31.1	33.8	7.5	2.0	2.9	4.5	5.6	2.6	5.3	8.4	4.0
17. 7.61.	17.9	18.8	8.9	3.2	2.0	4.0	2.1	0.9*	3.5	3.2	14.4
28. 8.61.	16.2	16.8	21.3	1.0*	7.0	6.7	5.4	1.0*	9.0	2.9	3.5
25. 9.61.	30.8	34.3	6.1	2.7	1.6*	8.0	11.0	0.8*	8.0	1.5*	5.1
23.10.61.	14.1	14.3	8.0	0.9*	1.6*	3.1	7.9	0.9*	2.1	9.5	4.2
22.11.61.	11.5	11.8	12.5	2.5	1.5*	3.0	12.5	1.4*	1.1	6.8	1.0*
11.12.61.	24.1	24.9	25.6	2.5	2.0	1.7	7.9	0.05	2.9	2.3	7.5
Mean	20.9	21.8	9.8	2.0	2.2	4.0	7.8	1.0	4.5	5.2	5.1

Table 16 (contd.)

Species	Total Acarina	Total Cryptostigmata	Juvenile Cryptostigmata	<u>Oppia-</u> <u>Suctobelba</u>	<u>Platynothrus</u> <u>peltifer</u>	<u>Nanhermannia</u> <u>nana</u>	<u>Tectocephus</u> <u>velatus</u>	<u>Parasitidae</u>	<u>Carabodes</u> <u>minusculus</u>	<u>Chamobates</u> <u>schutzi</u>	<u>Carabodes</u> <u>marginatus</u>
Date											
15. 1.62.	14.5	14.6	16.6	1.8	1.7 [#]	2.5	9.9	1.9	2.8	5.9	3.1
13. 2.62.	33.3	35.7	66.7	2.9	1.6 [#]	3.4	7.4	1.5 [#]	10.0	2.0	2.9
20. 3.62.	5.2	4.8	5.2	6.0	0.8 [#]	1.3 [#]	4.9	1.2 [#]	8.3	2.5	6.5
3. 4.62.	16.9	16.5	13.2	1.0 [#]	1.3 [#]	5.1	5.2	0.4 [#]	5.4	7.1	1.3 [#]
3. 5.62.	21.3	20.7	14.0	4.3	0.7 [#]	2.1	12.7	0.0	9.4	2.6	4.6
4. 6.62.	31.8	33.4	3.7	5.8	1.5 [#]	2.0	6.2	1.0 [#]	5.0	3.5	2.4
3. 7.62.	36.1	37.9	8.1	3.5	1.2 [#]	4.3	7.3	1.3 [#]	5.5	4.0	12.6
7. 8.62.	87.0	93.8	73.4	2.7	3.5	3.7	4.3	1.2 [#]	12.4	1.6 [#]	5.3
1. 9.62.	76.9	77.5	14.7	3.7	3.8	3.0	11.2	1.4 [#]	6.6	7.3	15.0
3.10.62.	32.5	32.2	13.0	4.5	3.0	6.1	5.6	2.6	7.1	4.8	4.8
2.11.62.	36.1	36.8	26.3	4.0	2.8	2.8	15.8	2.3	6.0	4.5	11.7
6.12.62.	30.1	31.3	37.5	2.3	1.8	5.2	10.4	2.4	0.9	6.5	11.0
Mean	35.1	36.3	24.4	3.5	2.0	3.4	8.4	1.4	6.6	4.4	6.8

interesting to note that the total Acarina showed a much higher coefficient of dispersion on the mixed moor than on the Limestone grassland. This can be attributed to the more uniform nature of the plant cover on the latter site, compared with the mixed moor which had a relatively varied plant cover.

At times during the two study years (Tables 15 and 16), the Oppia-Suctobelba was not aggregated with respect to the size of sample used. Platynothrus peltifer and Nanhermannia nana are species which show similar results. It appears to be a consistent feature of the Parasitidae to show a non-aggregated distribution with regard to the sample size used on both the sites investigated. It should be pointed out that a non-significant result can never establish randomness with any degree of certainty. It may be that an actual departure from randomness has occurred which is too small to be shown up by the amount of sampling undertaken; or even that some different type of non-randomness is present for which the coefficient of dispersion is inappropriate.

The contention of Haaløv (1960) that the better the locomotory organs are developed, the less aggregated is the distribution of the species in question, is not confirmed by the data from the present study. The slower moving Oribatei species such as Platynothrus peltifer, Nanhermannia nana, and Pelops planicornis have similar coefficients of dispersion to the Parasitidae in 1961 on the Limestone grass-

land site. The Parasitidae are a very active group with well-developed powers of locomotion.

It can be seen from Tables 15 and 16 that there is a seasonal variation in the coefficient of dispersion for individual species and total Acarina. A comparison of the coefficients of dispersion from Tables 15 and 16 with the population density on the same Moor House sites in Figs. 15 to 19 (facing pages 107 to 108), shows that high values of the coefficient of dispersion were obtained when the population density also was high. This is so for both the total Acarina and individual species. The peaks of high values of the coefficient of dispersion coincide with the spring and autumn peaks of abundance of juvenile forms. This may be due to two factors: firstly, there is an actual increase in the degree of aggregation by the grouping of large numbers of newly-hatched juveniles; or secondly, the coefficient of dispersion has increased because the mean density has increased. The coefficient of dispersion has been shown to increase with the mean density of plant species in Prairie vegetation by Clapham (1936). From Fig. 10 the relationship of the mean density (in thousands per square metre) to the coefficient of dispersion values for total Acarina on the two Moor House sites can be seen. It is clear that the coefficient of dispersion increases slowly with the mean, until densities of between 50 and 60 are reached, when

Fig. 10.

Graph showing the relationship of the values of the coefficient of dispersion to the mean density per sample for total Acarina. The mean density is expressed in thousands per square metre. The samples were from two Moor House sites: the Limestone grassland (●) and mixed Calluna moor (X), collected in 1961 and 1962. The trend line was drawn in by eye, and the Poisson line (variance equal to the mean) is also indicated.

RELATION OF COEFFICIENT OF DISPERSION TO MEAN DENSITY

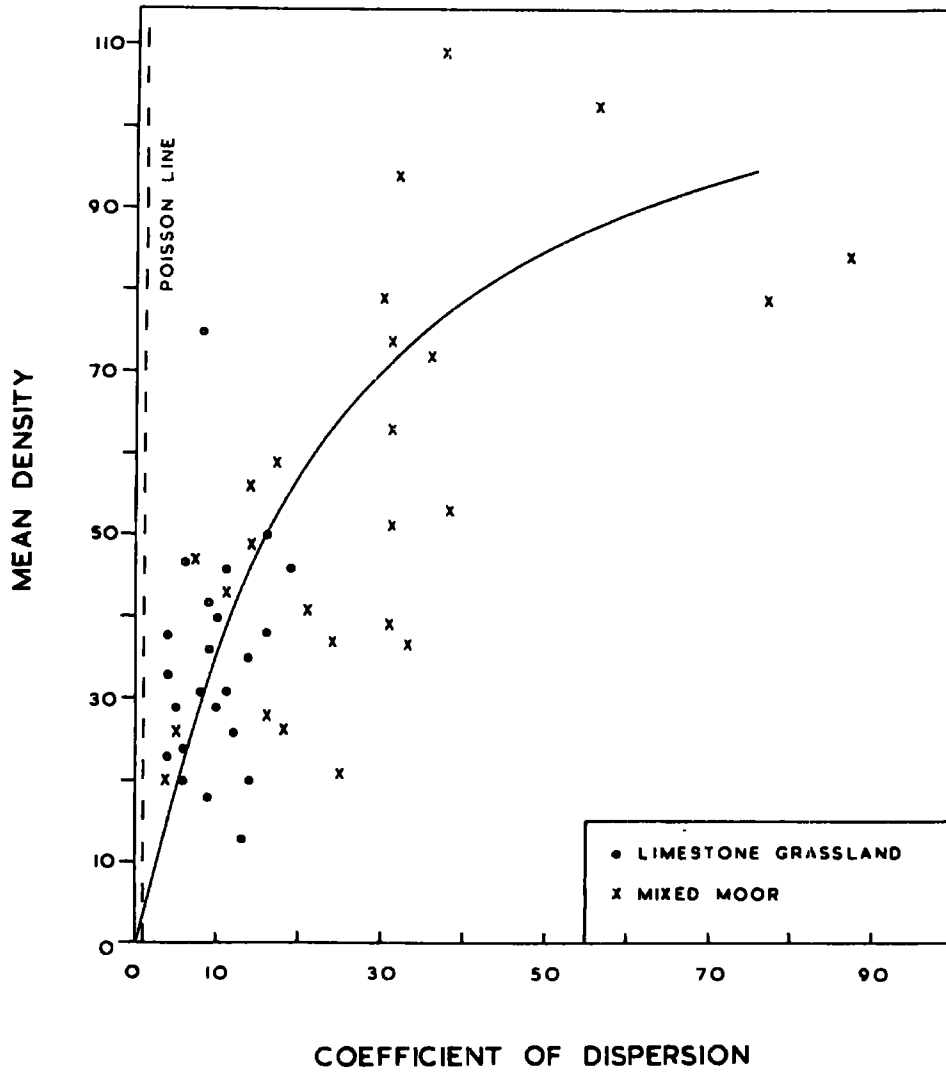

the coefficient of dispersion values increase steeply with the mean values. The distinction, therefore, between a real increase in aggregation of the individuals of the population, and the suggestion of an increase produced by a higher mean density, cannot be determined by the methods used in this study. However, the coincidence of high values of the coefficient of dispersion with the presence of juvenile forms in the population, suggests that there is a real increase in the degree of aggregation during the spring and autumn breeding periods.

At high mean densities (Fig. 10) of 80 mites per square metre and above, the mean and the coefficient of dispersion become independent of one another. This also was true of the plant species studied by Clapham (1936). Using a logarithmic transformation of the data resulting from counts of Protura extracted from grassland soil, Raw (1956) has shown the degree of aggregation to be independent of the population density, and has suggested that slow dispersal from centres of reproduction may be the cause of such aggregations.

The coefficients of dispersion have been calculated for total Acarina and also the common species on the Juncus squarrosus, Nardus stricta, and the erosion area sample sites at Moor House, and they show a similar pattern to the results from mixed moor and the Limestone grassland.

(ii) The frequency distribution.

Comparison was made of the sample unit values of total Acarina from the two soil types with the normal distribution curve. The sample unit values were grouped into frequency distributions round their individual means, with multiples of the standard deviations as the class boundaries. The mean value was taken as 0, negative standard deviation classes contained frequency values for sample units smaller than the mean value; and positive standard deviation classes contained frequency values for sample units greater than the mean value. The data for the two sample sites are shown in Tables 17 and 18. In both cases there is a significant difference ($P < 0.001$) from the expected normal distribution, and two features are noticeable. Firstly, an excess of values below the mean in the -1 standard deviation class, and a lack of balancing values above the mean in the $+1$ standard deviation class. Secondly, a tail of a small percentage of relatively large positive values (greater than $+2$ standard deviation class), and a much steeper fall off on the negative side.

The data presented here show that the total Acarina were from a non-normal distribution. The frequency distribution shows that there is a random distribution with a few discrete aggregations of individual species superimposed upon the basic pattern.

Skewed distributions of this type have been recorded

Table 18. Frequency distribution of the sample unit values about the mean (0) of total Acarina. Mixed Calluna moor 1961-62.

Standard deviation classes	-4	-3	-2	-1	0	+1	+2	+3	+4
Date									
23. 1.61.	0	0	2	3	5	2	0	0	
20. 2.61.	0	0	0	9	4	1	0	1	
13. 3.61.	0	0	0	10	4	0	0	1	
18. 4.61.	0	0	2	7	4	2	0	0	
14. 5.61.	0	0	1	8	4	1	1	0	
5. 6.61.	0	0	0	10	3	1	1	0	
17. 7.61.	0	0	0	11	3	0	0	1	
28. 8.61.	0	0	2	8	2	2	1	0	
25. 9.61.	0	0	0	9	5	0	0	1	
23.10.61.	0	0	3	5	5	1	1	0	
22.11.61.	0	0	3	6	2	4	0	0	
11.12.61.	0	0	1	8	4	1	1	0	
15. 1.62.	0	0	2	6	4	2	1	0	
13. 2.62.	0	0	0	10	4	0	0	1	
20. 3.62.	0	0	3	6	3	3	0	0	
3. 4.62.	0	0	2	6	4	3	0	0	
3. 5.62.	0	0	1	8	3	3	0	0	
4. 6.62.	0	0	1	9	4	0	0	1	
3. 7.62.	0	0	1	7	4	2	1	0	
7. 8.62.	0	0	0	10	4	0	0	1	
1. 9.62.	0	0	0	10	2	2	1	0	
3.10.62.	0	0	2	7	4	2	0	0	
12.11.62.	0	0	0	10	3	0	2	0	
6.12.62	0	0	1	8	4	1	1	0	
Total (Observed)	0	0	27	191	88	33	11	7	
Total (Expected Normal)	0	8	49	122	122	49	8	0	
χ^2	0	8	9.9	39.0	9.5	5.2	12.5		
Total χ^2	= 84.1 d.f. = 6 P < 0.001								

for Enchytraeidae by Nielson (1954), O'Connor (1957), Peachey (1963); Nematoda by Banage (1960); Collembola by Poole (1961) and Hale (1962).

For sample unit values of individual species, where a number of sample units contained no individuals, comparison of the distribution was made with a Poisson frequency. In all cases examined the distribution of the species was found not to follow a Poisson distribution, with an excess of high and slightly low values. This indicates aggregation of the species, as in the case of the total Acarina.

(iii) The relation between the mean per sample, the variance, and the standard deviation.

Nielson (1954), O'Connor (1957) and Peachey (1963) studying Enchytraeidae distributions, have used the comparison of the standard deviation and the mean per sample to determine the type of distribution of the sample data, and the transformation required. A more valuable approach is to determine the relation of the variance to the mean per sample to show the type of distribution; e.g. the variance is equal to the mean for a Poisson distribution. The relationship of the variance and the mean per sample obtained from 15 sample units from total Acarina on Limestone grassland and mixed moor is shown in Fig. 11. The best representation of trend lines have been drawn in by eye, and the Poisson line (variance equal to the mean) is indicated. The slope

Fig. 11.

Graph showing the relationship between the mean and the variance of samples from the Limestone grassland (●) and mixed Calluna moor (X). The mean density of total Acarina is expressed in thousands per square metre. The samples were collected during 1961 and 1962. The trend lines were drawn in by eye, and the Poisson line (variance equal to the mean) is also shown.

RELATION OF MEAN TO VARIANCE OF SAMPLES

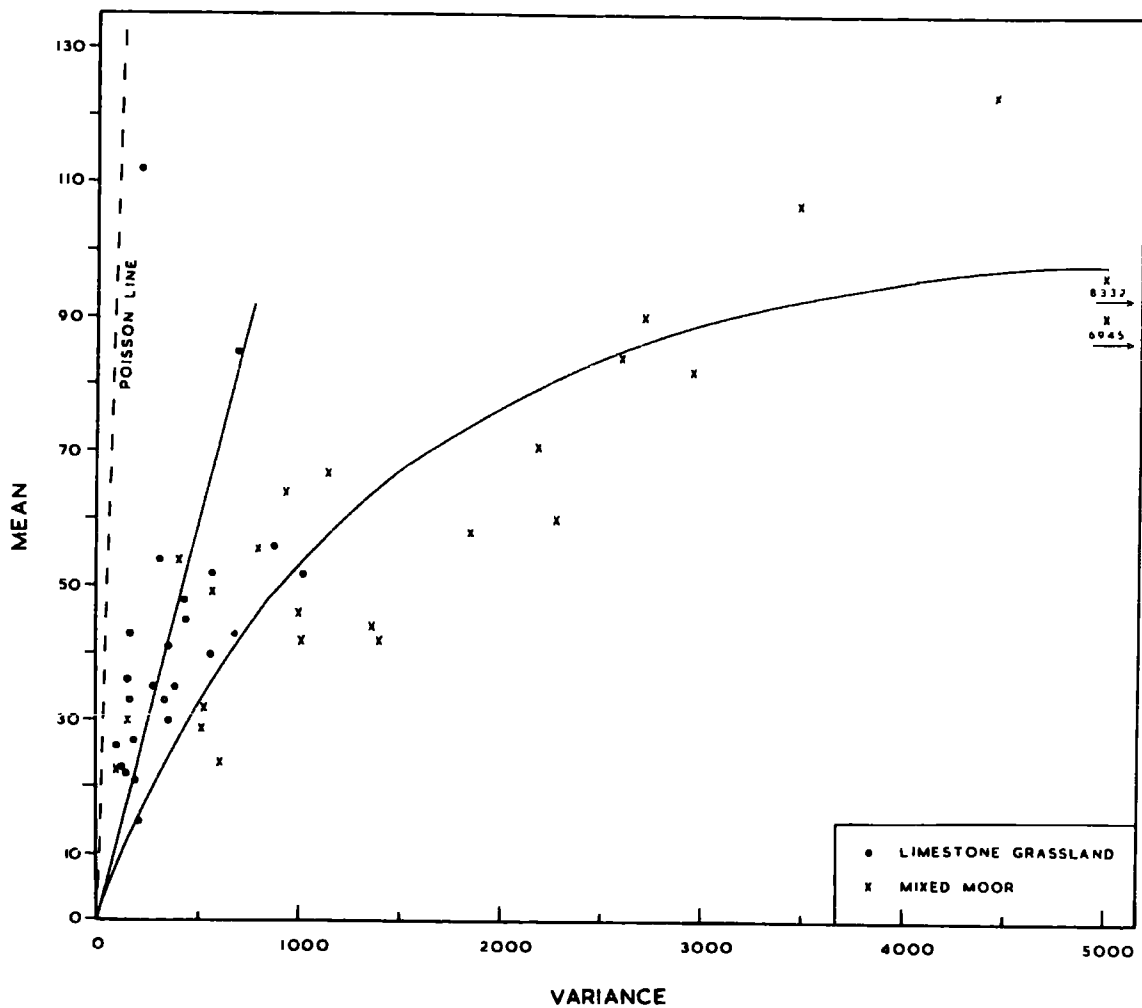

FIG. 11.

of the trend lines show that the variance increases with the mean on both areas, but the increase is not a proportional one. The distribution is not Poisson. There is a rapid increase of the variance with the mean density in the mixed moor samples, and not such a rapid increase in the Limestone grassland samples.

The relationship of the standard deviation and the mean per sample of the same sets of data are shown in Fig. 12. The trend lines have, again, been drawn in by eye. In both cases, the standard deviation increases with the mean per sample, rapidly in the mixed moor samples and not so rapidly in the samples from the Limestone grassland. In order to stabilise the variance and make it independent of the mean, a logarithmic transformation is required as indicated by Quenouille (1950). This would have the effect of producing a near-normal distribution of the sampling data.

c) The biological significance of aggregation :

Some degree of aggregation is typical of soil arthropods, as the soil is a heterogeneous medium. The factors which may produce aggregations in soil Acarina are as follows:-

1. A localisation of favourable conditions, such as food supply, microclimate, etc.
2. The grouping of eggs laid by one adult, or by several adults assembled during the laying period. Dispersal from the centres of reproduction may also be slow.

Fig. 12.

Graph showing the relationship between the mean and standard deviation of samples from the Limestone grassland (●) and mixed Calluna moor (X). The means are densities of total Acarina in thousands per square metre. The samples were collected during 1961 and 1962. The trend lines have been drawn in by eye.

RELATION OF MEAN TO STANDARD DEVIATION OF SAMPLES

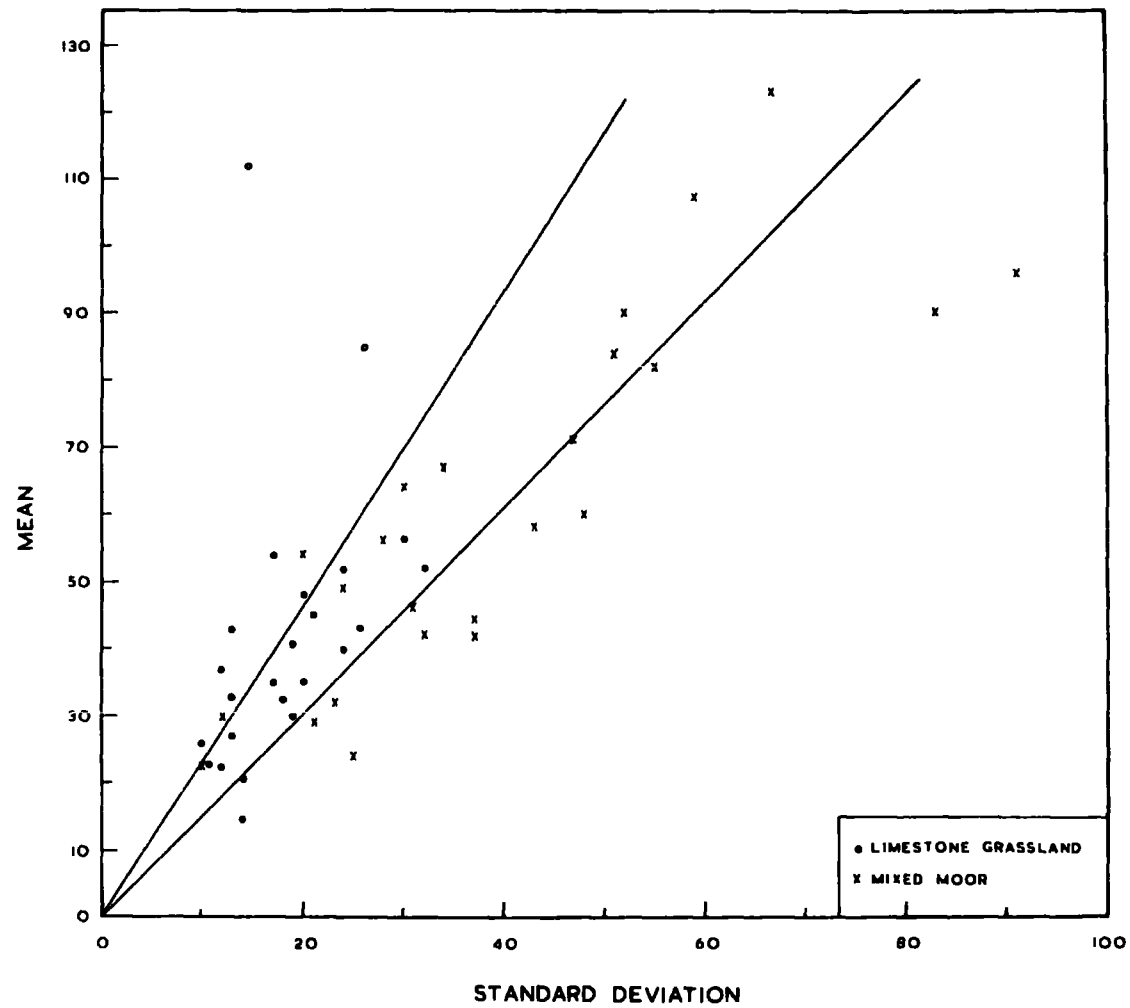

Fig. 12.

3. Direct attraction between individuals.

It is probable that any or all of these factors could act together to influence the distribution of Acarina and other soil animals.

VII VERTICAL DISTRIBUTION

a) Introduction :

In undisturbed soils in temperate regions the majority of the micro-arthropods are concentrated in the upper soil layers and overlying litter. Macfadyen (1957) has commented on the fact that life tends to be concentrated at the junction between two phases, i.e. air and soil, because of the photosynthetic demands of the plants, which form the primary food source. This has been demonstrated for soil micro-arthropods by van der Drift (1950), Macfadyen (1952), Murphy (1953), Kuhnelt (1955), Wallwork (1959), and Dhillon and Gibson (1962) who have shown that the highest densities of these animals occur in the upper layers of the soil profile. Other studies by Weis-Fogh (1948), Elton and Miller (1954), Haarløv (1955, 1960), Murphy (1955), and Klima (1956) have shown that the highest densities of micro-arthropods occur where the pore spaces are largest in the soil profile.

The vertical distribution of mites and Collembola is often subject to seasonal changes. Thus in Macfadyen's (1952) observations, 50 per cent of the total mite and Collembola fauna occurred below 5 cm. depth in February in fen soil. Similarly, very pronounced downward shifts in the micro-arthropod population have been recorded in tropical soils coinciding with the dry season (Strickland, 1947;

Belfield, 1956). On the other hand, Volz (1934, 1951) found little seasonal change in the vertical distribution of mites in a forest soil. Similar observations were made by Frenzel (1936) for the Acarina of grassland.

b) Distribution of Acarina in 0-3 cm. and 3-6 cm. soil layers at Moor House :

During the course of fieldwork samples were taken to a depth of 6 cm. on the Limestone grassland in both study years, but only in 1962 was the mixed Calluna moor sampled to the same depth. Six bimonthly samples each of 15 sample units and 6 cm. deep were collected from the mixed moor site in 1962. The 6 cm. cores were divided in the field into two layers each 3 cm. deep. In both the soil types, separation at this level divided the core into an upper part containing the vegetation and decomposition layers, and a lower part consisting entirely of mineral matter or peat permeated by plant roots. It was possible to determine the extent to which different species penetrated into the soil by counting the numbers of mites which were extracted from each layer. The data resulting from such counts are given in Tables 19 and 20. The figures shown are the total numbers of Acarina extracted from each layer over one year, and only the more abundant species are shown.

As other workers have shown, the highest total density of Acarina occurs in the 0-3 cm. layer. Only one species,

Table 19. Depth distribution of Acarina on Limestone grassland, 1961 and 1962. The figures are the total numbers of Acarina extracted from 180 sample units per year.

Species or Group.	1961		1962	
	Numbers in <u>0-3 cm.</u> <u>3-6 cm.</u>	Percentage of total in 3-6 cm. layer	Numbers in <u>0-3 cm.</u> <u>3-6 cm.</u>	Percentage of total in 3-6 cm. layer
<u>Oppia-Suctobelba</u>	$\frac{213}{77}$	26.5	$\frac{212}{55}$	20.6
<u>Rhodacarus roseus</u>	$\frac{11}{42}$	79.2	$\frac{13}{44}$	77.2
<u>Olodiscus minima</u>	$\frac{446}{76}$	14.6	$\frac{228}{76}$	25.0
<u>Parasitidae</u>	$\frac{524}{132}$	20.1	$\frac{443}{63}$	12.4
<u>Zerconidae</u>	$\frac{225}{70}$	23.7	$\frac{210}{99}$	32.0
<u>Cryptostigmata Juveniles</u>	$\frac{1793}{135}$	7.0	$\frac{1802}{104}$	5.5
<u>Cryptostigmata Adults</u>	$\frac{1473}{132}$	8.2	$\frac{1585}{97}$	5.8
<u>Total Acarina</u>	$\frac{5143}{569}$	10.0	$\frac{5795}{506}$	8.0

Table 20. Depth distribution of Acarina on Mixed Moor, 1962.
 (No samples of 3-6 cm. layer were taken during
 1961). The figures are total numbers extracted
 from 90 sample units for the year.

Species or Group	Numbers in 1962		Percentage of total in 3-6 cm. layer
	0-3 cm.	3-6 cm.	
<u>Chamobates</u> <u>schutzi</u>	202	19	8.6
<u>Nanhermannia</u> <u>nana</u>	260	59	18.5
<u>Thyrisoma</u> <u>lanceolata</u>	53	20	27.4
<u>Carabodes</u> <u>minisculus</u>	1035	38	3.5
<u>Oppia-</u> <u>Suctobelba</u>	139	40	22.3
<u>Parasitidae</u>	164	35	17.6
<u>Cryptostigmata</u> Juveniles	3553	83	2.3
<u>Cryptostigmata</u> Adults	2634	231	8.1
Total Acarina	6522	386	5.6

Rhodacarus roseus, which only occurs on the Limestone grassland, has its higher density in the 3-6 cm. layer (see Table 19). This species, according to Evans et. al. (1961), is a true soil form belonging to the euedaphon, which has only been recorded from mull formations. Sheals (1957) found the Rhodacaridae constituted 49 per cent of the Mesostigmata in upland grassland, and was particularly abundant in the lower soil layer. Species of the Oppia-Suctobelba group, Zerconidae, and Parasitidae penetrated the mineral soil to the 3-6 cm. level. Olcdiscus minima also penetrated to this depth, but to a different extent for each of the two study years (see Table 21). The Oppia-Suctobelba group was recorded from the 3-6 cm. zone on both sites (21-26 per cent of its total numbers occurred in the lower layer).

In the mor soil of the peat site, small forms such as Thyrisoma lanceolata, and species of Oppia-Suctobelba occurred in high densities in the lower layer sampled. Approximately 18 per cent of the total numbers of Nanhermannia nana and species of Parasitidae also occurred in the 3-6 cm. layer of the mixed moor. Forsslund (1945) recorded Nanhermannia nana as being more abundant in the H layer (: humus or decomposed layer) than in the F layer (:förna or fermentation layer). Considering the high densities of juvenile forms of Cryptostigmata recorded from both sites, only a small proportion (5.5-7.0 per cent on the Limestone grassland, and 2.3 per cent on the mixed moor) penetrated to

the 3-6 cm. depth in the soil. Adult Cryptostigmata had similar percentages in the lower layer (3-6 cm.) as the juveniles on the Limestone grassland. On mixed moor 2.3 per cent of the juvenile Cryptostigmata population and 8.1 per cent of adults occurred in the 3-6 cm. layer. Certain of the adult forms were better adapted to living in habitats with much free water.

Approximately 6 per cent of the total mite fauna penetrated to a depth of 3-6 cm. in the peat soil, whereas in the mineral soil of the Limestone grassland 8-10 per cent of the total fauna occurred below 3 cm. depth. This probably reflects the relative number and size of pore spaces available on the two areas. The lower layer (3-6 cm.) of the peat on the mixed moor site was waterlogged on all of the sample dates in 1962 (see Table 6, page 18).

In Table 21, a comparison is made between the depth distribution of Acarina in two different years on the Limestone grassland site. The comparison between the samples in different years was made by using 2 x 2 contingency tables χ^2 , and applying Yates' correction. With the exception of Rhodacarus roseus and the juvenile and adult forms of the Cryptostigmata; there were significant differences in the depth distribution between the two years considered for all other species or groups. However, the changes were not all in the same direction; some species having moved up to

Table 21. Comparison of the depth distribution of Acarina in different years: Limestone grassland, 1961 and 1962.

Species or group	1961		1962		Probability of the difference
	Numbers in 0-3 cm.	Numbers in 3-6 cm.	Numbers in 0-3 cm.	Numbers in 3-6 cm.	
<u>Oppia-Suctobelba</u>	$\frac{213}{77}$		$\frac{212}{55}$		240.4 < 0.001
Cryptostigmata Juveniles	$\frac{1793}{135}$		$\frac{1802}{104}$		3.65 < 0.10 N.S.
Cryptostigmata Adults	$\frac{1473}{132}$		$\frac{1585}{97}$		7.29 < 1.0 N.S.
<u>Olodiscus miniae</u>	$\frac{446}{76}$		$\frac{228}{76}$		13.26 < 0.001
<u>Rhodacarus roseus</u>	$\frac{11}{42}$		$\frac{13}{44}$		0.001 > 0.95 S.S.
<u>Parasitidae</u>	$\frac{524}{132}$		$\frac{443}{63}$		11.49 < 0.001
<u>Zerconidae</u>	$\frac{225}{70}$		$\frac{210}{99}$		4.77 < 0.05
Total Acarina	$\frac{5143}{569}$		$\frac{5795}{506}$		13.43 < 0.001

Note: N.S. = Not significant.

S.S. = Significantly similar.

3-6 cm. zone (e.g. Oppia-Suctobelba, and Parasitidae), and some species having moved down to 3-6 cm. zone (e.g. Zerconidae). Rhodacarus roseus had a significantly ($P > 0.95$) similar depth distribution in both study years. The depth distribution of the total Acarina also differed significantly ($P < 0.001$) between 1961 (10 per cent of total fauna in 3-6 cm. layer) and 1962 (8 per cent of total fauna in 3-6 cm. layer) on the Limestone grassland site.

c) Seasonal variation in vertical distribution of Acarina :

During the course of the present study, the fact that monthly samples were taken at two levels made possible an analysis of the data from the point of view of seasonal variation in the vertical distribution of Acarina. Species or groups which occurred commonly with more than 10 per cent of their total numbers in the lower sample layer (3-6 cm.) are considered; namely : Oppia-Suctobelba, Olodiscus minima, Rhodacarus roseus, Zerconidae on Limestone Grassland; and Thyrisoma lanceolata, Oppia-Suctobelba, and Parasitidae on mixed moor. In Figs. 13 and 14 the numbers of each species occurring in the 3-6 cm. layer are plotted as a percentage (with standard error) of the total of that species on each sampling date. Data of the Limestone grassland site are shown in Fig. 13, and for mixed moor in Fig. 14.

There was little seasonal variation in the vertical distribution of total Acarina on both the sites studies.

Fig. 13.

Vertical distribution of Acarina in the mineral soil of the Limestone grassland during 1961 and 1962. The percentage of the total numbers of each species or group occurring in the two layers on each monthly sampling date is shown. The 3-6 cm. soil layer was not sampled on 13 February 1961 and 3 April 1962, due to frozen conditions.

Fig. 14.

Vertical distribution of Acarina in the peat soil of mixed Calluna moor during 1962. The percentage of the total number of each species or group occurring in the two layers on each sampling date is shown. The 3-6 cm. layer was sampled bimonthly, and the time scale is different from that of Fig. 13.

Fig. 14.

VERTICAL DISTRIBUTION OF ACARINA: MIXED MOOR

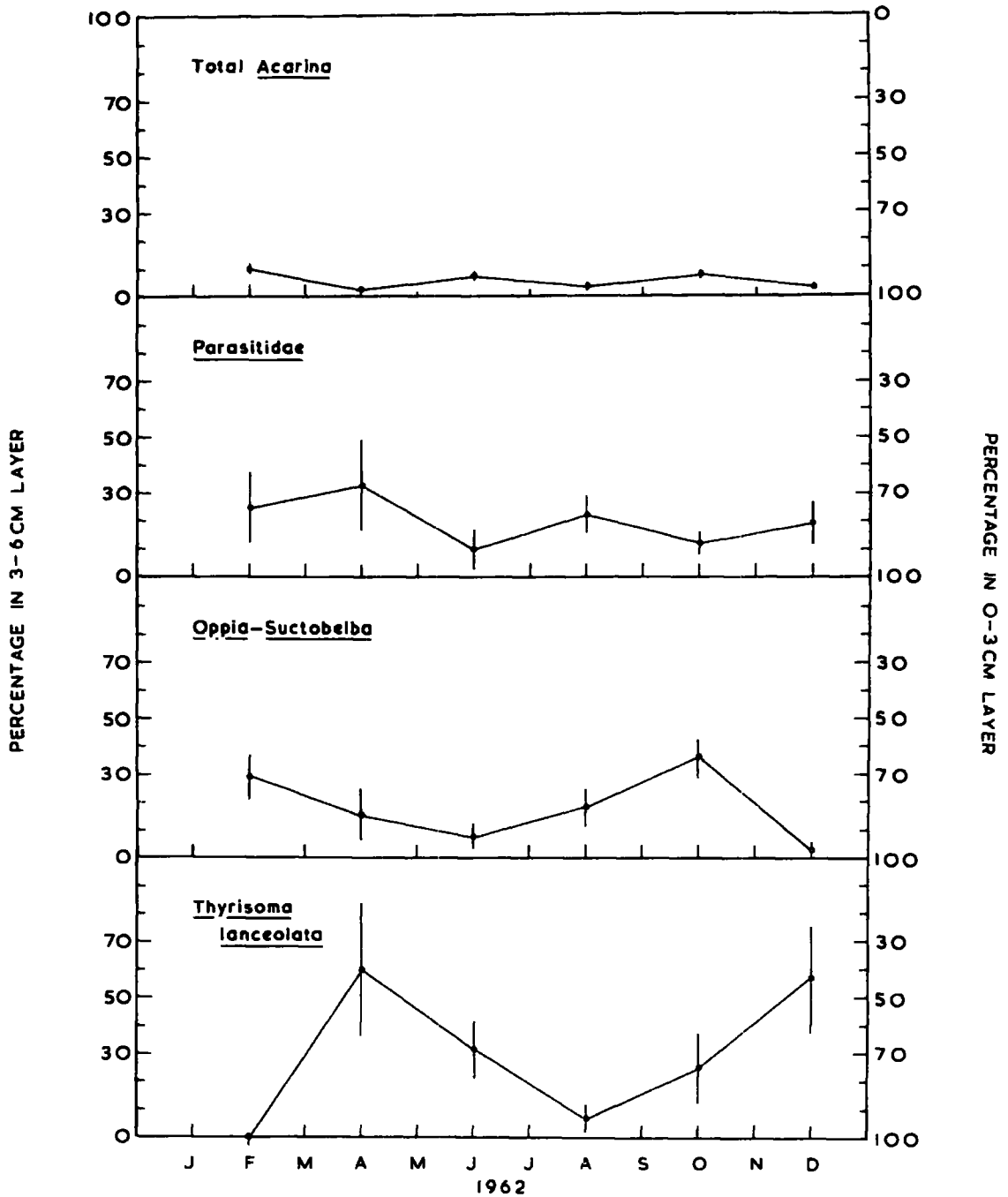

There were winter maxima in the lower (3-6 cm.) layer for Oppia-Suctobelba, and Olodiscus minima in the Limestone grassland soil. An autumn maximum in 3-6 cm. layer in 1962 was recorded for Zerconidae in the mineral soil. Rhodacarus roseus has relative peaks of abundance in the 3-6 cm. layer in the mull soil in August and September of both study years. Relative minima for this species occur in June, October/November.

Only slight seasonal variation can be detected in the vertical distribution of the species on the mixed moor. Thyrisoma lanceolata had maxima in the 3-6 cm. layer in April and December of 1962. Little further interpretation can be placed on the sampling data available from the mixed moor.

Although changes in the density and vertical distribution of Acarina have been detected for the soil types studied in the present analysis there is no clear evidence of a seasonal vertical migration of mites in order to avoid adverse climatic conditions in the upper soil layers. The single possible exception to this is Rhodacarus roseus in the mineral soil. The study has shown that the vertical distribution of soil mites on the areas examined, is a dynamic one, which may be influenced by such factors as water content, food, pore size of soil, temperature, and light as suggested by Haarløv (1960). This dynamic aspect of the vertical distribution of micro-arthropods as a whole

also indicates that "characteristic species" which have been linked to certain strata of the soil (e.g. humus, fermentation layer) must be regarded with reservation. This is particularly so in the case of the Acarina, which have been difficult to fit into the type of life-form classification devised by Gisin (1943) for Collembola.

d) Discussion :

The concentration of the micro-arthropod population in the upper soil layers is largely due to the abundance of plant remains near the surface. With increasing soil depth, there is a reduction in the quantity of food and also in the nature of the food available, as it will be more fully decomposed. Species of fungi predominating in the A₁ horizon of a podzol, have been shown to decrease in frequency with depth by Williams (1963), whilst other types had maxima in the lower B₂ and C horizons. There was thus a qualitative as well as a quantitative change in the microflora with increasing soil depth. The ability, therefore, of saprophagous forms to live in the deeper soil layers depends on their ability to utilise food in a more advanced stage of breakdown and of a different nature. There is also a reduction in pore size with increasing depth of soil as shown by Haarløv (1955, 1960). On mixed moor, the pore size in the 3-6 cm. layer of compacted peat was found to be smaller than in loose litter of the 0-3 cm. layer.

This could be seen from the arrangement of the plant remains in the peat. A further reduction in available pore space was caused by the waterlogging of the peat below 3 cm. in depth for most of the year. The result of this was especially evident on the water saturated blanket peat at Moor House (recorded Indices of Humidity ranged from 5.8 to 11.3), where only six per cent of the total mite fauna occurred regularly below 3 cm. in depth. Not only is there a reduction in living space for micro-arthropods with increasing depth, but gaseous exchange is hindered. Lower oxygen and higher carbon dioxide tensions must be tolerated by edaphic forms than species inhabiting the surface layers of soil.

Although the fundamental vertical zonation of species in the soil can be tentatively accounted for by size of organism, food preferences and carbon dioxide toleration, it is more difficult to propose a probable explanation for seasonal or temporary changes in vertical distribution, which are imposed upon the basic pattern. A single example of a seasonal change in the vertical distribution of a species in the present study is that of Rhodacarus roseus on the Limestone grassland. Movements of the fauna to lower depths in the soil are commonly attributed to such causes as the drying out or flooding of the upper layers or to unfavourable surface temperatures (e.g. Strenzke, 1949, 1951; and Peachey, 1963). Rhodacarus roseus shows a change in vertical distri-

bution in mineral soil at Moor House in June (see Fig. 11), when the water content in both the soil layers sampled is low (see Table 5, p. 17).

The change in the vertical distribution of R. roseus can be interpreted as an annual upward movement of the species from the deeper soil layer in spring (June) and autumn (October, November). It is unfortunate that data are not available of the distribution of this species at depths greater than 6 cm. on the site studied. No information can be given on the life cycle of this mite from the literature. It is possible that reproduction of this species takes place in the surface layers of the soil, when suitable conditions prevail, and that a downward migration of the juveniles takes place after hatching.

An alternative suggestion is that a differential mortality occurs, affecting most severely the population of R. roseus in one of the sample layers. A higher density would be recorded, at this point, in the unaffected layer. With the onset of suitable conditions once again, a vertical migration (either upward or downward) would once more colonise the depleted zone. It is evident, therefore, that until more information is available on the life cycles of the edaphic forms of mites, and the factors and soil conditions which affect their distribution, vertical migrations must be regarded with a degree of reservation.

VIII SEASONAL VARIATION IN DENSITY OF ACARINA

a) Introduction :

Soil arthropod populations undergo marked seasonal fluctuations, which for the acarine community as a whole, usually involve minima during the summer months and maxima during autumn, winter and early spring. Table 22 summarises the previous studies where the time of peak densities of micro-arthropods have been recorded. Most of the previous studies were for periods of one year or less. There are departures from the general picture shown in the work of Hammer (1944) on the fauna of arctic soils, and Stockli (1957) on the mites and Collembola of alpine habitats; both of which show a maximum population density in the summer months (July-August). This fact could be due to the very limiting climatic and soil conditions of these areas.

Since all the above studies on seasonal variations in density of Acarina have been limited to two consecutive years or less, it has been difficult to demonstrate a regular annual cycle. However, the coincidence of a number of independent studies (see Table 22) by different authors at different times and places suggest that the population changes represent a regular cycle.

b) Sampling and analysis of data :

As previously described (page 50), 15 sample units

Table 22. Summary of previous studies on seasonal abundance of soil micro-arthropods.

<u>Author</u>	<u>Group</u>	<u>Soil type</u>	<u>Month of peak density</u>													
			J	F	M	A	M	J	J	A	S	O	N	D		
Thompson (1924)	Acarina and Collembola	Pasture	+	+	.
Edwards (1929)	Total arthropods	Permanent pasture	+	.
Ionescu (1932)	Acarina and Collembola	Woodland litter	+	+	.
Ford (1935, 1937)	Acarina and Collembola	Meadow pasture	.	+	+
Frenzel (1936)	Acarina and Collembola	Grassland, Silesia	+	.	+	+	+	+	+	.
Baweja (1939)	Acarina and Collembola	Recolonisation of sterile soils	+	+
Riha (1951)	Acarina	Forest soils Austria	+	+	+
Weis-Fogh (1948)	Acarina and Collembola	Sandy pasture	+	+
Strenzke (1951)	Oribatei	N. Germany	+	+	+
Macfadyen (1952)	Acarina and Collembola	Fen peat	.	+	.	.	.	+	+

Table 22. (continued)

<u>Author</u>	<u>Group</u>	<u>Soil type</u>	<u>Month of peak density</u>													
			J	F	M	A	M	J	J	A	S	O	N	D		
Evans (1955)	Acarina and Collembola	Forest soils	.	+	+	.	.
Sheals (1957)	Acarina and Collembola	Uncultivated mineral soil	.	+	+	.	.
Wallwork (1959)	Acarina and Collembola	Hemlock/birch mor	+	.
Haarlov (1960)	Acarina and Collembola	Pasture, Denmark	+	+
Dhillon and Gibson (1962)	Acarina	Undisturbed grassland	+	+	.
Davis (1963)	Acarina and Collembola	Reclaimed mineral soils	+	+
Hammer (1944)	Acarina and Collembola	Arctic soils	+	+	+
Stockli (1957)	Acarina and Collembola	Alpine pasture	+	+	+

were collected at random on each monthly sampling date from two sites at Moor House; namely : Limestone grassland (360 sample units), and mixed Calluna moor (360 sample units). The sampling was continued over two years: 1961 and 1962. The random sampling yielded data on the population density of total Acarina and the common species of Acarina on the two areas sampled. The taxonomic separation of the juvenile forms of the Cryptostigmata was not carried out in the early stages of this study, but later, the immature forms of certain common species were identified. The population density of the total juvenile Cryptostigmata is therefore given, along with the adult population densities of individual species. The population curves for the density of species and groups of Mesostigmata include both adult and juvenile forms. The routine identification of the Prostigmata and Astigmata was made to the family.

The data on population density on the two sites has been plotted on a logarithmic scale to give an indication of the rate of change in the density, and the results are shown in Figs. 15, 16, 17, 18 and 19, for species or groups which had a mean annual population density in excess of 1,000 individuals per square metre (i.e. more than 1 individual per 10 cm^2). On the Limestone grassland, 11 species were selected for study, and 7 species were studied from mixed moor. The standard errors of the mean densities have

also been indicated. In order to smooth the curves and, to show trends and seasonal changes in the population density of individual species more clearly, three-point running means were calculated for the data and were superimposed upon the population density curves. These are shown as a trend line in Figs. 15 to 19.

c) Results of monthly samples and comparison with other authors :

Each species or group of Acarina on the two sample sites will be considered separately; the data for limestone grassland are given in Figs. 15, 16, and 17; and for mixed moor in Figs. 18 and 19.

1. Total Acarina :- (Figs. 15 and 18)

Figs. 15 and 18 include all stages of all groups of mites. In 1961, there were spring maxima of population density in May, with August minima and December maxima on both the Limestone grassland and mixed moor. In 1962, the density was highest in May and October on mixed moor, and in July and November on Limestone grassland. September and March minima in density were observed also for Limestone grassland. The later maximum in density on Limestone grassland in 1962 could be attributed to the more exposed nature of the site, delaying development longer in the late spring of that year.

The peaks of population of the total Acarina between

Fig. 15.

Seasonal variations in the density of Acarina in mineral soil of the Limestone grassland. The data are for the four main groups of soil mites which occur at Moor House. The horizontal axis shows the sampling months, and data for two complete years are given. The mean densities (in thousands per square metre), are plotted on a logarithmic scale on the vertical axis. The density scales are the same for all groups, but in some cases the scales do not begin at zero. The standard errors of the mean densities are shown, and three-point running mean values are indicated by trend lines.

SEASONAL VARIATIONS IN DENSITY: LIMESTONE GRASSLAND

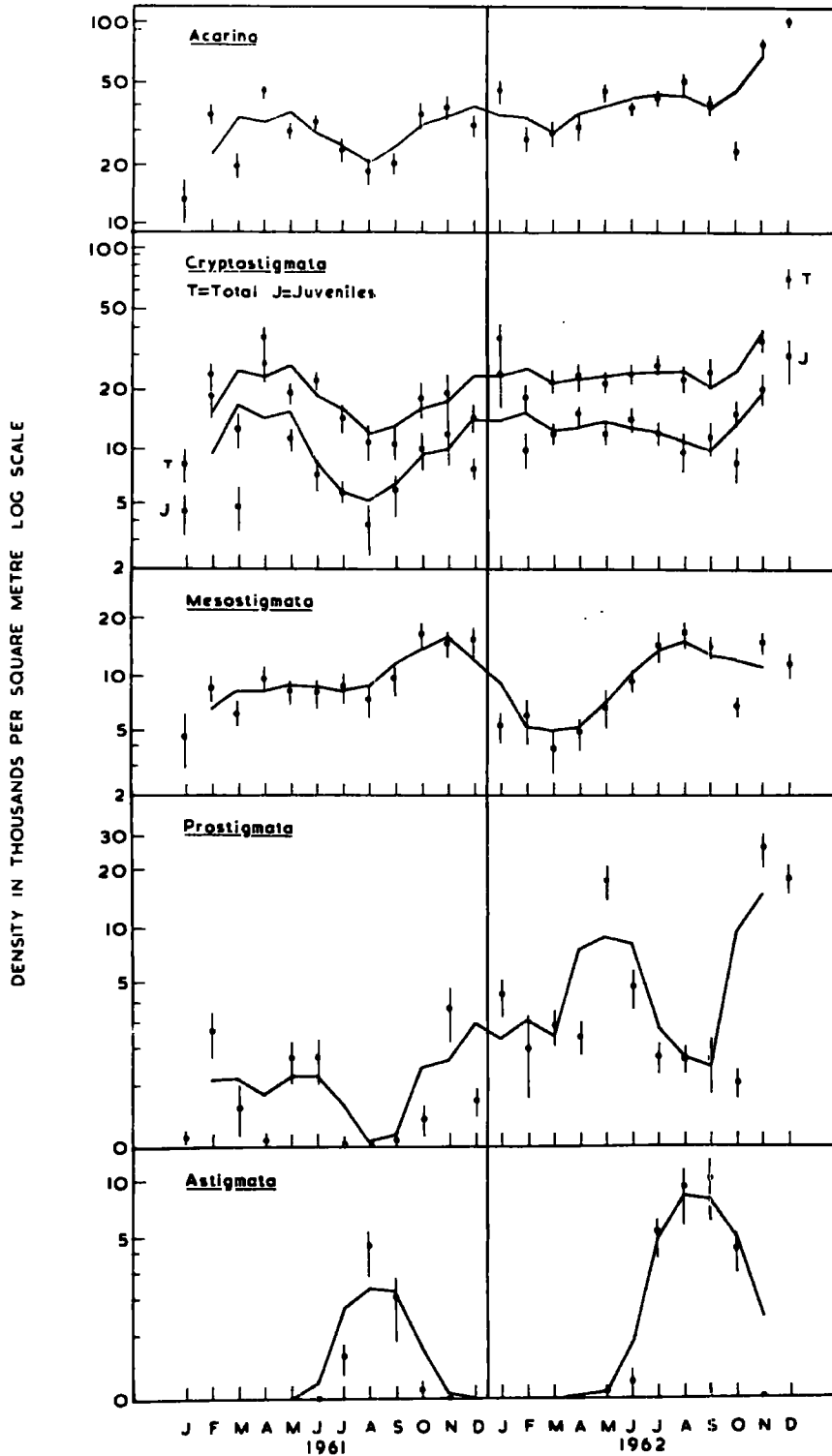

Fig. 16.

Seasonal variations in the density of Acarina in the mineral soil of the Limestone grassland. The data are for the common species and groups. The horizontal axis shows the sampling months, and data for the two complete years, 1961 and 1962, are given. The mean densities (in thousands per square metre) are plotted on a logarithmic scale on the vertical axis. The density scales are the same for all species and groups, and all begin at zero. The standard errors of the mean densities are shown, and three-point running mean values are indicated by trend lines.

Fig.16.

SEASONAL VARIATIONS IN DENSITY: LIMESTONE GRASSLAND

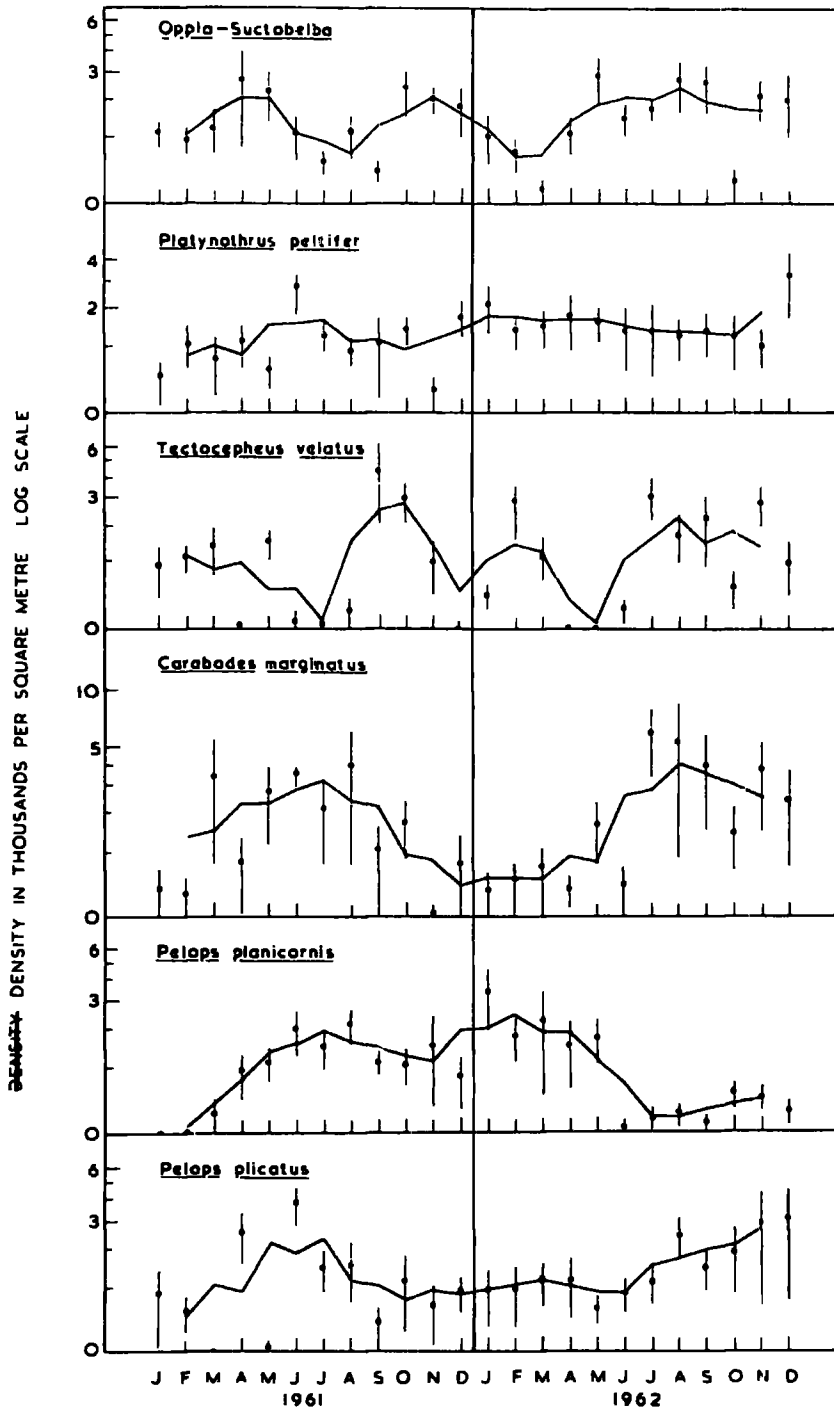

Fig. 17.

Seasonal variations in the density of Acarina in the mineral soil of the Limestone grassland. The data are for common species and groups. The horizontal axis shows the sampling months, and data for two complete years, 1961 and 1962 are given. The mean densities (in thousands per square metre) are plotted on a logarithmic scale on the vertical axis. The density scales are the same for all species and groups and all begin at zero. The standard errors of the mean densities are shown, and three-point running mean values are indicated by trend lines.

Fig.17.

SEASONAL VARIATIONS IN DENSITY: LIMESTONE GRASSLAND

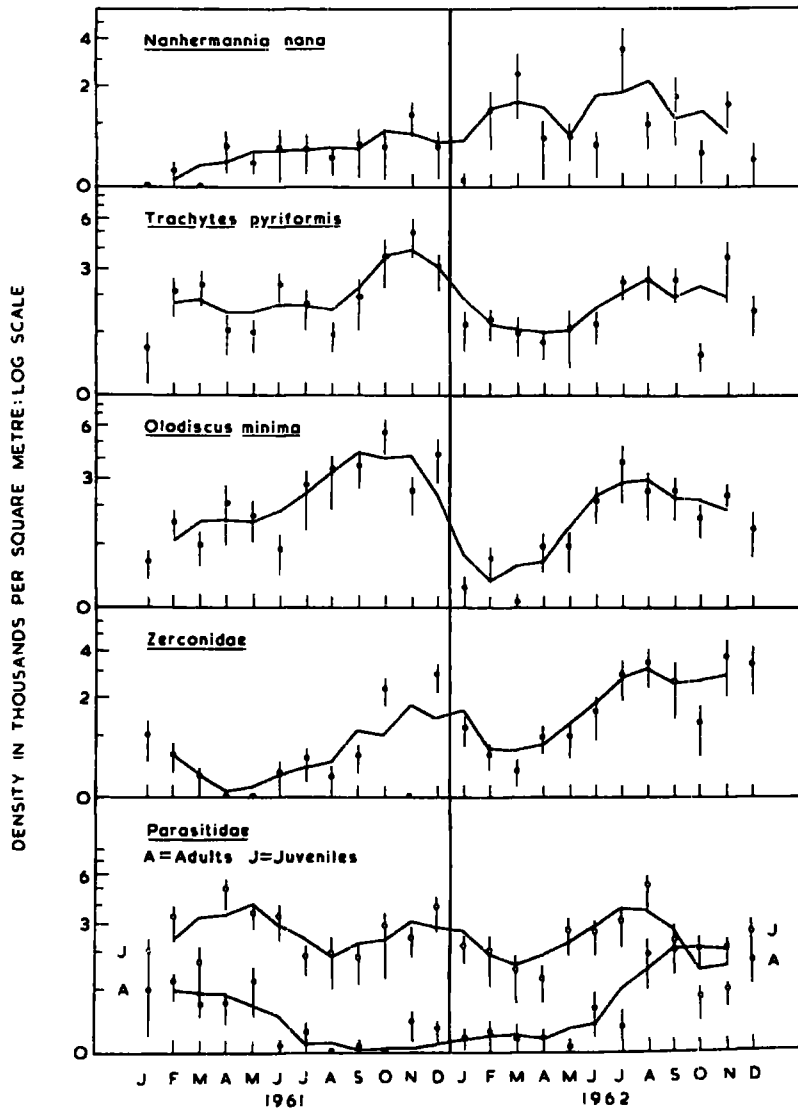

Fig. 18.

Seasonal variations in the density of Acarina in the peat soil of mixed Calluna moor. The data are for three of the four main groups of soil mites which occur at Moor House, and for the Parasitidae. The horizontal axis shows the sampling months, and data for two complete years, 1961 and 1962, are given. The mean densities (in thousands per square metre) are plotted on a logarithmic scale on the vertical axis. The density scales are the same for all groups, but in some cases the scales do not begin at zero. The standard errors of the mean densities are shown; except where they have been omitted for clarity in the graph of the Parasitidae; and three-point running mean values are indicated by trend lines.

SEASONAL VARIATIONS IN DENSITY: MIXED MOOR

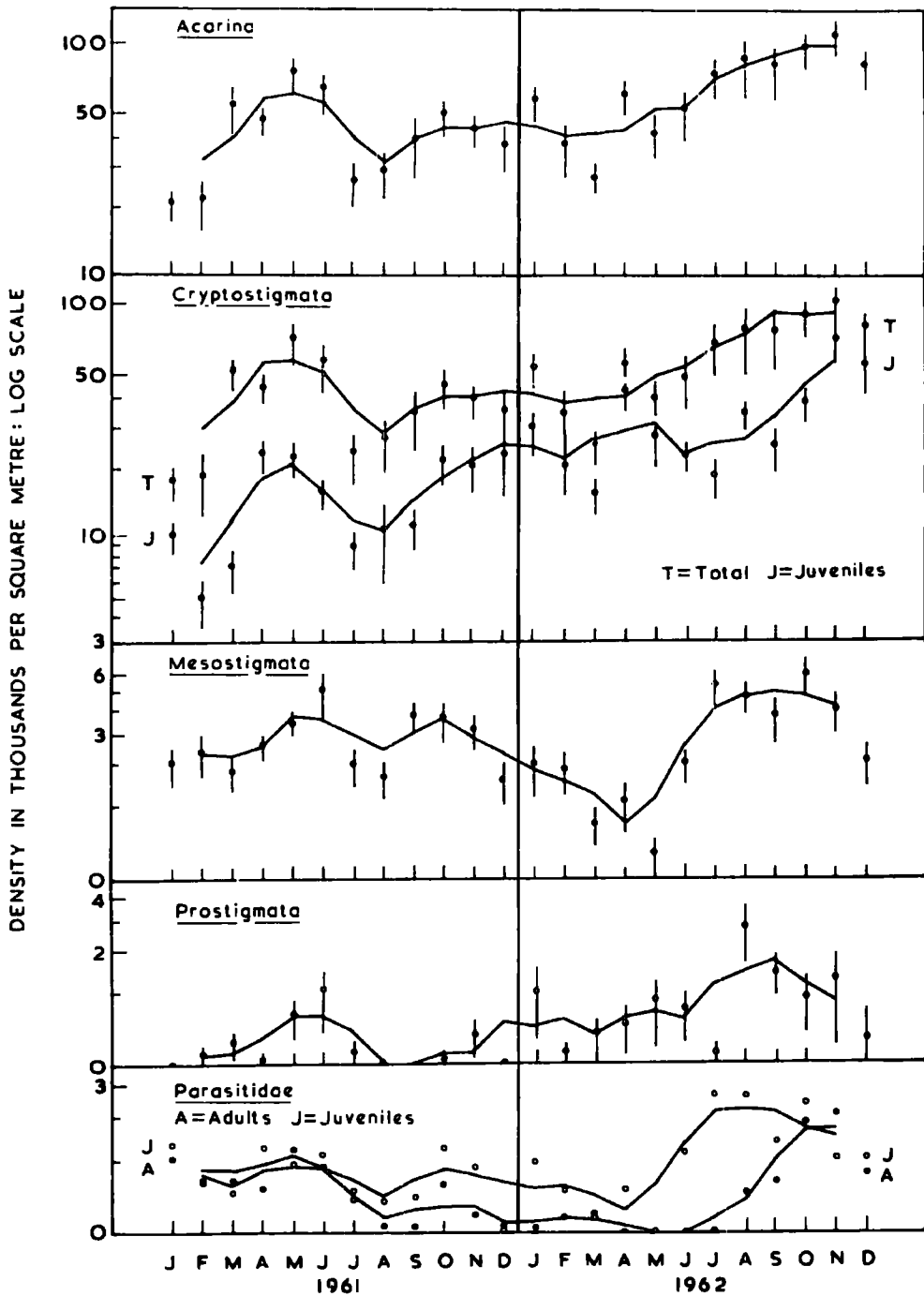
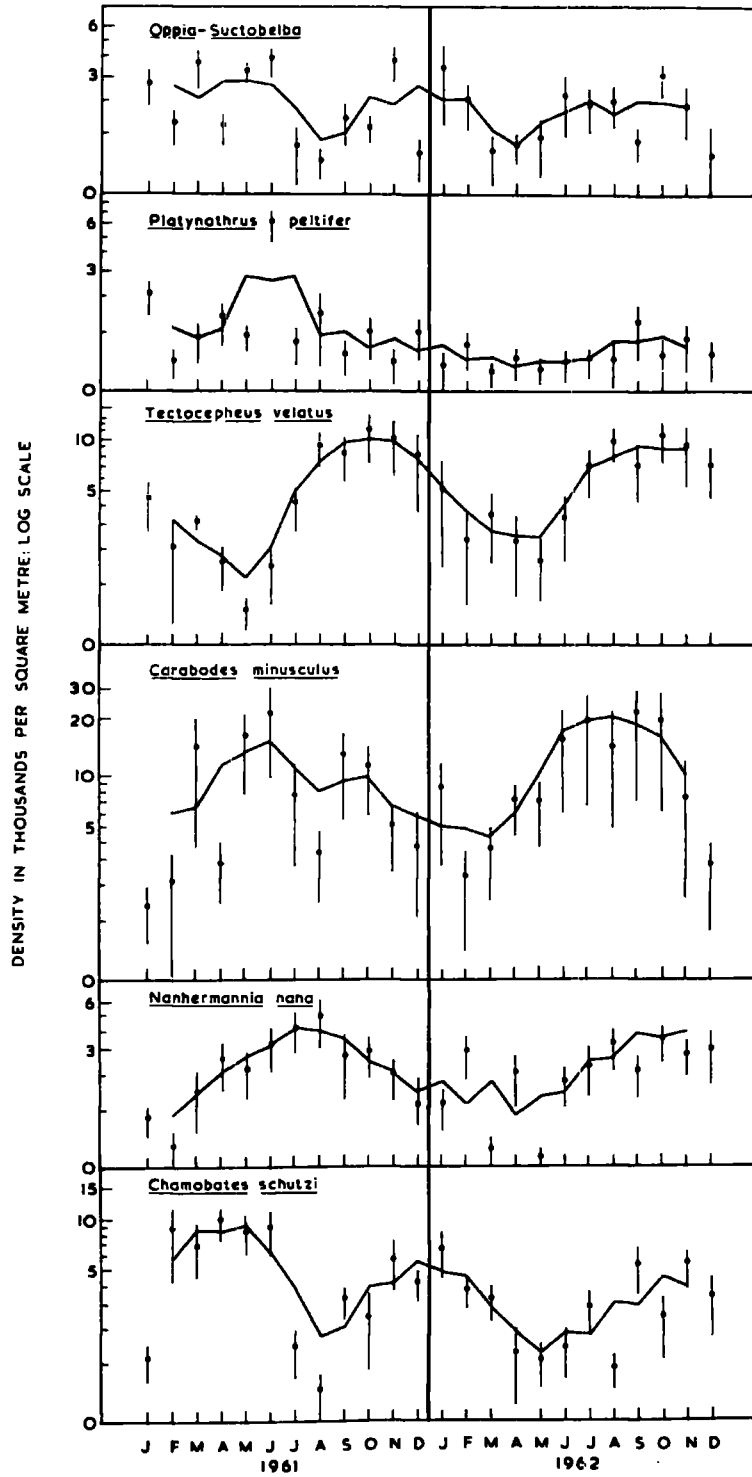

Fig. 19.

Seasonal variations in the density of Acarina in the peat soil of mixed Calluna moor. The data are for common species and groups. The horizontal axis shows the sampling months, and data for two complete years, 1961 and 1962, are given. The mean densities (in thousands per square metre) are plotted on a logarithmic scale on the vertical axis. The density scales are the same for all species and groups, and all begin at zero. The standard errors of the mean densities are shown, and three-point running mean values are indicated by trend lines.

SEASONAL VARIATIONS IN DENSITY: MIXED MOOR



May and July on the Moor House sites correspond with results obtained by Frenzel (1936) on Acarina of grasslands in Silesia, Hammer (1944) for the micro-arthropod fauna of arctic soils, Riha (1951) on forest soils of Austria, Stockli (1957) on mites and Collembola of alpine pasture, and Davis (1963) for Acarina of reclaimed mineral soils in Northamptonshire. The correspondence of the peaks of maximum density in the Acarina populations at Moor House, which experiences a sub-arctic climate, with the results from areas having similar or more rigorous climatic conditions (e.g. Greenland, and alpine pasture) is clear. The earlier spring in the northern Pennines than in most of the areas cited accounts for the earlier occurrence of the spring population peak density at Moor House. It is obvious that the spring peak in numbers was caused by a rapid hatch of eggs at this period. Fig. 2 shows that the air temperature rose rapidly over this period, while it can be seen from Figs. 15 and 18 that juvenile stages of Cryptostigmata were most abundant at that time. There is evidence, therefore, that the climatic factors of the areas studied influence the occurrence of the peaks in population density of soil mites. It is suggested that these factors act upon the reproductive cycle of the species, resulting in the hatching of eggs at well defined periods of the year. This theme will be developed and discussed below.

Late autumn and early winter population peaks were recorded from all the studies listed in Table 22 (page 104), with the exception of the work of Hammer (1944), and Stockli (1957), where the population peaks were limited to the short summer season. Other studies where the population density curve lacked a winter peak were those of Wallwork (1959), and Dhillon and Gibson (1962); both of whom recorded September maxima. The results of van der Drift (1950) differ from all other authors in finding little seasonal variation in the population density of the total microarthropod community of beech forest litter.

2. Cryptostigmata :- (Figs. 15 and 17).

The population curve for juvenile forms is shown separate from the curve for total Cryptostigmata in Figs. 15 and 17. In 1961, there were population maxima in May and December, and minima in August for both the sample sites. For 1962, late autumn maxima in September-December were recorded on both areas.

As the Cryptostigmata constitute the majority of the fauna in the soils studied, the seasonal trends in these populations follow closely the curves for total Acarina. The total density of juvenile forms of the Cryptostigmata on both sites have similar seasonal changes to the total Cryptostigmata. The spring peak of juvenile forms can be attributed to a hatch of over-wintering eggs, and the autumn peak of density by the hatch of eggs laid in the summer,

giving rise to a marked increase in the larval and nymphal population.

There was a seasonal trend in the ratio of the juveniles to adults in the populations of Cryptostigmata, as is shown in Table 23. The ratio is expressed as the number of juveniles per 100 adults in the population on each sampling date for mixed moor and the Limestone grassland. It can be seen from Table 23 that high juvenile:adult ratios occurred in the same month or within one month of each other, on both the sample sites. The highest juvenile:adult ratios were recorded in spring (January, February and April in 1961; and in January, April and June in 1962), and in autumn/early winter (November and December in both 1961 and 1962). These relatively high values coincided with the peaks of density of the Cryptostigmata (see Figs. 15 and 18), and were caused by the abundance of newly-hatched juvenile forms.

The most marked seasonal changes in groups occurred in the Cryptostigmata on both the study areas; and a more detailed phenological analysis indicates that the fluctuations are connected to the life cycle and reproduction of the mites. Similar seasonal fluctuations of the Cryptostigmata element of the mite fauna have been recorded by Evans (1955) for a Sitka spruce forest soil, and by Macfadyen (1952) for a Molinia fen soil. It was suggested by Sheals (1957) that the seasonal fluctuations in the Oribatei populations of un-

Table 23. Seasonal variation in the ratio of juvenile to adult Cryptostigmata. The ratio is expressed as the number of juveniles to 100 adults in the population on each sampling date.

Sampling date	Ratio of the number of juveniles to 100 adults of the Cryptostigmata population	
	Limestone grassland	Mixed <u>Calluna</u> moor
16. 1.61.	100	125
13. 2.61.	300	36
13. 3.61.	62	16
10. 4.61.	270	104
8. 5.61.	137	49
5. 6.61.	44	40
17. 7.61.	67	64
28. 8.61.	57	69
25. 9.61.	120	46
23.10.61.	125	92
22.11.61.	150	110
11.12.61.	114	191
15. 1.62.	200	130
13. 2.62.	125	133
20. 3.62.	120	177
3. 4.62.	167	287
3. 5.62.	120	208
4. 6.62.	140	85
3. 7.62.	80	37
7. 8.62.	77	83
1. 9.62.	85	51
3.10.62.	114	77
12.11.62.	143	194
6.12.62.	67	250

cultivated grassland soil were due, in part, to the movements of the Acarina to other habitats for reproduction. The same writer has also recorded a low density of immature Oribatei; a similar deficiency was noted by Riha (1951) in a study of calcareous woodland soils near Vienna. Here, further observations indicated that the juvenile forms of several species lived in other habitats, e.g. under bark and in leaf litter. Attempts were made at Moor House, in the present study, in spring and summer to determine whether there was a movement of Acarina up into the vegetation at a particular stage in the life history. There was no evidence from an analysis of the catches of sticky and pitfall traps, which were situated at regular heights above the surface of the blanket bog in the Calluna of the mixed moor, to support this suggestion.

Writing of Oribatei, Strenzke (1951) states that February and August minima in population density were usual in north Germany. August minima were observed for the Oribatei in the present study. The Moor House results confirm those by Strenzke (1951), and Macfadyen (1952) that the species composition of the Cryptostigmata populations remains constant throughout the year. This implies that all species were present throughout the year, and since adults were found in all months, it is likely that they are

relatively long lived, living at least several months under natural conditions.

3. Mesostigmata :- (Figs. 15 and 18)

The population graphs are the totals of all stages. In 1961, maximum population density occurred in May, and a minimum in August on the mixed moor site. Autumn maxima for both sites were recorded in October and November. For 1962, maxima of population density were observed for both sites in August and September, and minima in March and April.

Evans (1951), and Sheals (1957) have detected little seasonal variation in the density of Mesostigmata in forest and upland pasture soils respectively. These observations are in contrast to the Moor House results, which show significant annual changes in the population density of Mesostigmata under upland conditions. The autumn maximum populations in August-November of Mesostigmata from Limestone grassland and mixed moor agree with the results of van der Drift (1950), who found a peak of relative high density for Parasitiformes in September.

4. Prostigmata :- (Figs. 15 and 18)

The population curves are of adults and juveniles. In 1961, spring peaks in the density of this group occurred in May and June, autumn peaks in December, with August and September minima on both sites studied. In 1962, May maxima in population density were recorded on both peat and mineral

soil areas at Moor House. A September maximum was recorded on the mixed moor site, and a November maximum on Limestone grassland.

A significant decrease in the density of Prostigmata occurred in September on Limestone grassland. The Prostigmata are amongst the least known of the soil-inhabiting Acarina, appearing to favour heath and forest habitats. From the studies of Evans (1951) on forest soils in the south of England, the seasonal fluctuations of this group were seen to follow those of the Cryptostigmata, although the changes were less well marked in the Prostigmata. A similar situation occurs with these two groups on the sites studied at Moor House. The exception to this occurred in May 1962, when a significant maximum in the density of the Prostigmata was recorded on Limestone grassland, without a corresponding maximum in the Cryptostigmata on the same site.

For Prostigmata, van der Drift (1950) records spring minima of population density in May in beech litter, which is also the period of highest density of this group on the two Moor House sites. However, van der Drift (1950) considered that his estimates of the population density of this group were low due to the inefficiency of the heat extraction technique used, bimonthly sampling and the short duration of the developmental stages from egg to adult of species of this group. The estimates of the population density of the Prostigmata in moorland soils may also be low for the same

reasons.

5. Astigmata :- (Fig. 15)

All stages are included in the population curve in Fig. 15. Representatives of this group were recorded only from the mineral soil of Limestone grassland. A significant peak of high density was observed in August of both study years. The main species of Astigmata recorded in the present study was Rhizoglyphus echinopus, which has been collected from a wide range of soil types (Evans, et al., 1961). The Astigmata have not been regarded as a soil-dwelling group, but the investigations of Murphy (1953) on heathland, Sheals (1956) on upland pasture and arable soil, have shown that species of this group are consistent members of the fauna of those soils studied.

Compared with an August maximum in population density for the Astigmata at Moor House, van der Drift (1950) recorded a July peak of density of Glycyphagus domesticus in the beech litter of the National Park 'De Hooze Veluwe' in the Netherlands.

6. Oppia-Suctobelba :- (Figs. 16 and 19)

In routine identifications of samples, the species of these groups were not separated. Mean estimates of the population density of adults are given for this group as few juvenile forms occurred in the samples. For 1961, maximum densities of between 2-3,000 adults per metre²

(: 2-3 adults per 10 cm² .) were recorded in April and May on both sample areas. A minimum in density was observed in August, and autumn maxima in November and December occurred in both soil types. In 1962, there was a minimum population density on mixed moor in April, with corresponding minima in February and March on Limestone grassland. Maxima were recorded on both areas in the period: July to September.

The population data suggest an autumn hatch of eggs laid during the summer, and a spring hatch of overwintering eggs for the species of this group. There were very few juvenile forms extracted from peat and mineral soil samples during the winter months of the study years. The species overwinters in the egg and adult stage, or the extraction efficiency for juveniles of this group may be relatively low during this period. In observations on Oppia neerlandica, Forsslund (1943) and van der Drift (1950) recorded only adults from their samples in relatively high densities: 9 individuals per 10 cm² ., in beech litter, compared to 2-3 adults per 10 cm² in the present study.

December peaks of population density for representatives of the Oppia-Suctobelba group have also been found by Wallwork (1959) in the humus layer of soil under hemlock forest in the United States of America. At the same time of the year, Oppia spp. composed 30 per cent of the total oribatid fauna

in the same habitat. A short development time from egg to adult of 23 days at 25°C and 95 per cent relative humidity was observed by Woodring and Cook (1962) for Oppia neerlandica in culture. The short life cycle would suggest that there would be more than one generation per year under suitable field conditions. From the peaks of maximum abundance for this group at Moor House, there appears to be a possible two generations annually in the soils studied.

7. Platynothrus peltifer :- (Figs. 16 and 19)

Adult population densities are given for this species; figures for juvenile density are given in Fig. 23. Maximum adult density in 1961 was recorded in May, June and July on both areas, but the peak was more pronounced on the mixed moor. In 1962, there was no significant differences between the mean monthly population densities on the peat or mineral soil types.

The life cycle of this Oribatid mite has been determined for moorland conditions from field data obtained from monthly samples, and the results are given on page 180.

Platynothrus peltifer was found to have a single generation per year at Moor House, which supports the findings of Haarløv (1960), and Hartenstein (1962). The juveniles matured to the adult over a period of 7-8 months (February to September, 1961) on the mixed moor, and then passed the winter in the adult stage, although some tritonymphae were

found in December samples. Thus the single annual peak in adult density in May-July, 1961 confirms that the species is univoltine at Moor House. Estimates of the length of the development period from egg to adult under field conditions in this species vary from two months (Haarløv, 1960), five months (Grandjean, 1950; Hartenstein, 1962), to 7-8 months of the present study. The relatively longer development at Moor House may be due to lower temperatures.

8. Tectocepheus velatus :- (Figs. 16 and 19).

This species was recorded from Limestone grassland and mixed moor, and adult population densities are given for both areas. For 1961, minimum density occurred in May on mixed moor, and in July on Limestone grassland. Maximum density was attained on both sites in October. There appeared to be an additional minimum for this species in December on Limestone grassland. In 1962 there were minima in May, and maxima in August and September on both areas. There was a peak of adult numbers in February on Limestone grassland in the same year, produced from overwintering tritonymphae.

However, van der Drift (1950) recorded that the juveniles of this species had the highest density in the spring in beech mor soil. In August-October, when the Moor House population has its highest density, Wallwork (1959) has recorded a decrease in numbers in forest litter with a

December peak of adults produced from nymphae. In contrast to the single generation per year for this species, which is indicated in the present study, Haarlov (1960) suggested that two generations per year were possible, based on a comparison of the body size and postembryonic development time of T. velatus and Ceratozetes gracilis. Tarras-Wahlberg (1961) has observed a vertical migration of T. velatus to lower layers of a Swedish Sphagnum bog in response to a temperature of 0°C. There was no evidence of a vertical migration of this species in the winter months at Moor House. Similar high densities as recorded in the present study were found for this species in July and September in soils of the Törnetrask territory of Swedish Lapland by Dalenius (1963).

9. Carabodes minusculus :- (Fig. 19)

Adult densities of this species are given in Fig. 19. Peak numbers of adults were estimated for July and October on mixed moor in 1961, whilst in 1962 minimum numbers were found in March, and maximum density in August on mixed moor.

The data, which were only from mixed moor, suggest a spring hatch giving rise to juveniles, which matured in June 1961, and an additional summer generation producing a peak in adult density in October. This was supported by an examination of the immature forms, as nymphae were present in the February to May samples in 1961. In 1962,

the spring samples contained no juveniles of C. minusculus, but there was a rise in adult density in August of the same year. It appears that the first generation in 1962 was limited by the severe climatic conditions of that period (April to September) at Moor House.

10. Carabodes marginatus :- (Fig. 16)

This species occurred only on the peat moor in large numbers, and data of the adult population are given.

For 1961, there was a summer maximum in July with a winter minimum in December. In 1962, low densities were found on the peat site in January-March of 1962, and a summer peak of density occurred again in August.

Insufficient juvenile material had been extracted from monthly samples from the peat moor to support the suggestion of a single generation a year under sub-arctic climatic conditions.

11. Nanhermannia nana :- (Figs. 17 and 19)

In 1961, the adult numbers show a peak in July, and a minimum in December on mixed moor. The mean density of N. nana on Limestone grassland does not show any significant change throughout the year. In 1962, minima were observed in April and May on both sites, with the curves showing a build up to a maximum of adults in August and September.

In studies on Nanhermannia elegantula, van der Drift (1950) observed larva, nympha and imago instars present in

beech litter for the whole of the year, and noted that the population density of this species decreased after a period of drought. No such correlation was found for the minima of density of N. nana with soil moisture on the areas studied at Moor House. Juvenile forms were present in small numbers throughout the study period on both sites.

Both Grandjean (1957) and Sengbusch (1958) have commented upon the occurrence of parthenogenesis in N. nana, and the latter author has recorded that it requires a postembryonic development of 111 days in culture at 25°C and a relative humidity of 82 per cent. Taking this into consideration with the low mean air temperatures experienced at Moor House, it is likely that only a single generation occurs annually.

12. Chamobates schutzi :- (Fig. 19)

Adults were recorded in high densities from mixed moor. For 1961, there was a well-defined maximum of population density in the spring (March to May) with a minimum in August, followed by peak densities over the winter. In 1962, a minimum in May with an October peak in numbers was recorded.

The population curve suggests less than one generation per year under moorland conditions. This was supported by large numbers of deuto- and trito-nymphae found in the samples during the winter months of 1961-62. According to

van der Drift (1950), high densities occurred during the winter in his studies, which he considered to be a consequence of an increase in adults. The same author did not record juveniles of this species.

13. Pelops planicornis :- (Fig. 16)

Recorded from Limestone grassland site, and the adult population curve is given in Fig. 15. In 1961, there was a peak of adult density in July with a falling off in November. From 1962, there was an early spring maximum with a drop to a summer minimum in July and August.

The data from an examination of the juvenile material of this species were not sufficient to allow conclusions to be drawn.

14. Pelops plicatus :- (Fig. 16)

In 1961, adult numbers recorded from Limestone grassland showed the occurrence of maxima of density in May and July. Thereafter, the population density remained steady until it began to rise again in November 1962.

Few immature forms were found in the samples, and the evidence from the population curves for the two study years is contradictory in that 1961 indicated a summer peak of numbers, whilst 1962 had a late autumn maximum.

15. Parasitidae :- (Figs. 17 and 18)

The standard error of the mean population density of Parasitidae has been omitted from Fig. 18 for clarity, and

the values indicated little significant change throughout the year. The density of juvenile forms of this group was in excess of the adult density on both sites studied. There appeared to be little variation in the density of Parasitidae on both areas throughout 1961-62; but there was a maximum of adult numbers on both areas in October 1962. Moderately high densities of Parasitiformes in September have been observed in woodland litter by van der Drift (1950). There was a corresponding high peak of population density in July-August of 1962 in both the peat and mineral soil types. Hartenstein (1962) concluded that 4-5 generations occurred per year in members of this group; but there is no evidence to confirm this from the present study.

As many species of Parasitidae are predatory in nature, it appears that this group has its highest population density at a time of year when large quantities of potential food material are available. The peak of density of Parasitidae is in the autumn at Moor House, when there are high populations of juvenile oribatids, and other mites available as prey. Hale (1962) has observed high densities of Collembola on the same areas at Moor House in the same period; and Karg (1961) has recently shown that Gamasid mites feed upon Collembola, Tyroglyphidae, juvenile Cryptostigmata, as well as small insect larvae and nematodes.

16. Zerconidae :- (Fig. 17)

Species of this family were recorded only from Limestone

grassland in sufficient numbers to merit study. The mean population densities given include adults and juveniles.

There was a minimum in April, and a maximum in November in 1961. In 1962, a minimum occurred in March with an August maximum.

17. Olodiscus minima :- (Fig. 17)

Recorded from Limestone grassland mineral soil with a density higher than 1,000 individuals per metre². O. minima has been termed a true edaphic species by Evans (1961), and it has been found in a wide range of soil types. The densities shown in the present study consist of adults and juveniles.

For 1961, the population maximum occurred in September, and in 1962 there was a maximum in August, with a minimum in February.

For Cilliba sp., also a member of the Uropodina to which group O. minima belongs, van der Drift (1950) has recorded a summer population density 3-4 times greater than in spring. This result agrees with the observations on O. minima at Moor House.

18. Trachytes pyriformis :- (Fig. 17)

This species was observed in greatest numbers on Limestone grassland site, and the mean densities shown include adult and juvenile forms. In 1961, the maximum density was recorded in November; and in 1962 a minimum occurred in April, and maximum density was recorded in August.

The results obtained in the present study differ from those of van der Drift (1950), in that he considered the fluctuations in the population density of Trachytes sp., to be of small extent, with the winter population being clearly smaller.

The results from the study of the common species of Cryptostigmata and Mesostigmata on the two sites at Moor House, are summarised in Table 24 for 1961, and Table 25 for 1962. In these tables, maximum and minimum densities of each species are shown, and it is clear that in 1961 the majority of the species had maximum density in May, whilst in 1962 maximum densities occurred three months later in August. Again, minimum densities of the majority of the species were recorded in August of 1961, and in March of 1962. Two patterns are seen in the seasonal variation of population density of Acarina species at Moor House :-

(i) Species recorded as having two possible generations per year at Moor House, e.g.:

Species of Oppia-Suctobelba group (1961 only).

Carabodes minusculus (1961 only).

(ii) Species recorded as having one generation per year at Moor House, e.g. :

Platynothrus peltifer (especially evident from the 1961 data)

Tectocephus velatus (1961 and 1962).

Carabodes marginatus (1961 and 1962).

Table 24. The occurrence of maxima in population density of Acarina in the mineral soil of the Limestone grassland (LG) and peat soil of mixed moor (MM) at Moor House in 1961. The data are taken from the Figs. 15, 16, 17, 18 and 19.

Note: + indicates maximum population density; - indicates minimum population density.

<u>Species/Group</u>	<u>Site</u>	<u>Month</u>											
		J	F	M	A	M	J	J	A	S	O	N	D
<u>Platynothrus</u>	MM	.	.	-	.	+	+	+
<u>peltifer</u>	LG	.	.	.	-	+	+	+	.	.	-	.	.
<u>Tectocephus</u>	MM	-	+	.	.
<u>velatus</u>	LG	-	.	.	+	.	.
<u>Carabodes</u>	MM	+	-
<u>marginatus</u>													
<u>Nanhermannia</u>	MM	-	+	-
<u>nana</u>	LG
<u>Pelops</u>	LG	+	.	+	.	.	-	.	.
<u>plicatus</u>													
<u>Pelops</u>	LG	+	.	.	.	-	.
<u>planicornis</u>													
<u>Chamobates</u>	MM	.	.	+	.	+	.	.	-	.	.	.	+
<u>schutzi</u>													
<u>Trachytes</u>	LG	+
<u>pyriformis</u>													
<u>Olodiscus</u>	LG	+	.	.	.
<u>minima</u>													
<u>Zerconidae</u>	LG	.	.	.	-	+
<u>Parasitidae</u>	MM
	LG
<u>Carabodes</u>	MM	.	-	.	.	.	+	.	.	.	+	.	.
<u>minusculus</u>													
<u>Oppia-</u>	MM	.	.	.	+	+	.	.	-	.	.	.	+
<u>Suctobelba</u>	LG	.	.	.	+	+	.	.	-	.	.	+	.
<u>Total Acarina</u>	MM	+	.	.	-	.	.	.	+
	LG	+	.	.	-	.	.	.	+

Number of occurrences of:

maximum density (+)	0	0	1	2	8	3	6	0	1	3	3	4
minimum density (-)	1	1	1	2	1	0	1	5	0	2	1	2

Table 25. The occurrence of maxima and minima in population density of Acarina in the mineral soil of Lime-stone grassland (LG), and peat soil of mixed moor (MM) at Moor House in 1962. The data are taken from Figs. 15, 16, 17, 18 and 19.

Note: + indicates maximum population density; - indicates minimum population density.

<u>Species/Group</u>	<u>Site</u>	<u>Month</u>													
		J	F	M	A	M	J	J	A	S	O	N	D		
<u>Platynothrus</u>	MM	+	.	.	.
<u>peltifer</u>	LG
<u>Tectocephus</u>	MM	-	+	.	.
<u>velatus</u>	LG	.	+	-	.	.	.	+	.	.	.
<u>Carabodes</u>	MM	-	-	-	+	.	.	.
<u>marginatus</u>															
<u>Nanhermannia</u>	MM	-	+	.	.
<u>nana</u>	LG	.	.	+	.	.	-	+	.	.	.
<u>Pelops</u>	LG	-	.	.	.	+
<u>plicatus</u>															
<u>Pelops</u>	LG	.	+	-	-	.	.	.
<u>planicornis</u>															
<u>Chamobates</u>	MM	-	+	.
<u>schutzii</u>															
<u>Trachytes</u>	LG	-	+	.	.
<u>pyriformis</u>															
<u>Olodiscus</u>	LG	.	-	+	.	.
<u>minima</u>															
<u>Zerconidae</u>	LG	.	.	-	+	.	.
<u>Parasitidae</u>	MM	+	+	.
	LG	+	.	.
<u>Carabodes</u>	MM	.	.	.	-	+	.	.
<u>minusculus</u>															
<u>Oppia-</u>	MM	-	+	.	.
<u>Suctobelba</u>	LG	+	.	.
<u>Total Acarina</u>	MM	+	.
	LG	.	.	.	-	+	.	+

Number of occurrences of:

maximum density (+)	0	2	1	0	1	0	4	9	4	2	2	0
minimum density (-)	1	2	5	3	4	1	1	1	1	0	0	0

Nanhermannia nana (1961 and 1962).

Pelops plicatus (1961 and 1962).

Pelops planicornis (1961 and 1962).

Chamobates schutzi (1962).

Olodiscus minima (1961 and 1962).

Zerconidae (1961 and 1962).

Parisitidae (1962 only).

It should be pointed out that the two peaks of abundance for the Oppia-Suctobelba group above may, in fact, be the maxima of density of two species within the group, which have their highest population density at different times of the year.

From a consideration of peaks occurring in the data, as shown by a study of three-point running means, there is an annual cycle in the populations of soil Acarina under moorland conditions. From the study of the life histories of individual species which occur on Pennine moorland, the annual cycle has been found to result from the reproductive cycle of the mites (see page 180).

d) Overwintering mortality :

There are two factors which affect the size of the Acarina population : the birth rate and the death rate of the individuals in the population. The birth rate (effectively the hatching of eggs) is affected by the condition and age of the adults, and a suitable temperature for the hatching of eggs. The death rate is probably relatively

constant except for catastrophes, e.g. drought or floods.

During the cold winter period (December-March), no eggs hatch at Moor House, and so the decrease in density is a measure of the mortality over that period of time. The decrease in density in a three month period has been used to give an estimate of the overwintering mortality, and this has been expressed as a percentage of the density at the beginning of the winter period in Table 26. Two independent estimates have been obtained using the results of samples taken in November-February, and December-March. There was an estimated overwintering mortality for total Acarina on both sites studied ranging from 20 to 23 per cent. For the same period, the Cryptostigmata had an estimated mortality rate of 22 per cent on mixed moor, but an increase of 18 per cent on the Limestone grassland. The Cryptostigmata had lower estimated mortality rates than those of the total Acarina on both sites. The Mesostigmata had high estimated mortality rates (67 and 49 per cent) for both the sites, which were in excess of those estimated for the Cryptostigmata. The highest estimated mortality rates of the study were recorded for Olodiscus minima and the Oppia-Suctobelba group on the Limestone grassland of 85 and 80 per cent respectively.

The ability of soil mites to withstand frozen conditions has been observed in the present study. Dalenius (1962) has recorded that in autumn in Sweden certain species

Table 26. Estimated mean overwintering mortality (as a percentage) of Acarina for a three month period, on the Limestone grassland and mixed moor.

Note: + indicates that the population apparently increased during the three month period.

- indicates mean estimated mortality.

0 indicates that no apparent change was observed in the population.

Group or species	Estimated mean percentage overwintering mortality over the three month period	
	Limestone grassland	Mixed <u>Calluna</u> moor
Total Acarina	-20	-23
Cryptostigmata	+18	-22
Mesostigmata	-67	-49
<u>Oppia-Suctobelba</u>	-80	-24
<u>Tectocephus velatus</u>	+86	-66
<u>Carabodes minusculus</u>	0	-30
<u>Chamobates schutzi</u>	0	-30
<u>Trachytes pyriformis</u>	-70	0
<u>Olodiscus minima</u>	-85	0
<u>Zerconidae</u>	-43	0
<u>Parasitidae</u>	-40	+64

of soil mites were rich in fat globules, which has been suggested by Edney (1957) as a means of lowering the water content of the tissues, and thereby producing a greater resistance to low temperatures and drought. Sengbusch (1951) considers that a high mortality of juvenile Oribatei occurs through predation by Mesostigmata under winter conditions; thereby reducing the populations of species which overwinter in the immature stages. From the present study it is clear that there was an overwintering mortality of Cryptostigmata from unknown causes, but there was also a higher mortality rate for Mesostigmata, which suggests that the suggestion of Sengbusch (1951) does not appear to be justified by the results given above.

IX THE FAUNA OF THE ERODING MOOR

a) Introduction:

The erosion area of Moss Flats has been described in the section on sample sites (page 25). When an erosion channel or hag is first formed, loose peat falls into the channel and is washed away; the vegetation binds the surface peat and a lip or overhang is formed at the edge of the hag (Fig.20). The hag lip is devoid of Calluna and supports a lichen cover of Cladonia coccifera agg.; the peat here is no longer waterlogged and high densities of Collembola are maintained in this habitat (Hale, 1963). The edge of the eroding blanket bog dries out due to the improved drainage and exposure to the wind, and mosses are absent from the hag lip zone (Plate 8). In some parts of Moss Flats erosion is so extensive that only a few small Calluna-covered hummocks remain on the bare peat surface, upon the top of which Empetrum nigrum becomes more common (Plate 8). A similar type of erosion has been described by Oswald (1949) on Irish bogs.

In places at Moor House, the erosion channels have cut down to the sandstone bed-rocks (Plate 7). Elsewhere the bare, redistributed peat forms a plane below the level of the original moor (see Plate 6), and in some areas stabilisation of this loose peat has occurred. Tussocks of Eriophorum vaginatum, thought to be from the original mixed moor, develop; and Eriophorum angustifolium invades the

Fig. 20.

Idealised section across eroding blanket bog at Moss Flats, showing the stages of erosion and recolonisation. The habitats which were sampled during fieldwork and described in the text, are shown, and a key is provided.

SECTION ACROSS ERODING BLANKET BOG

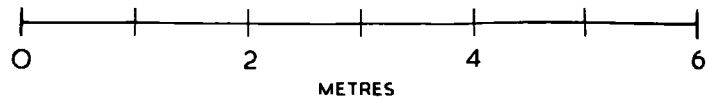
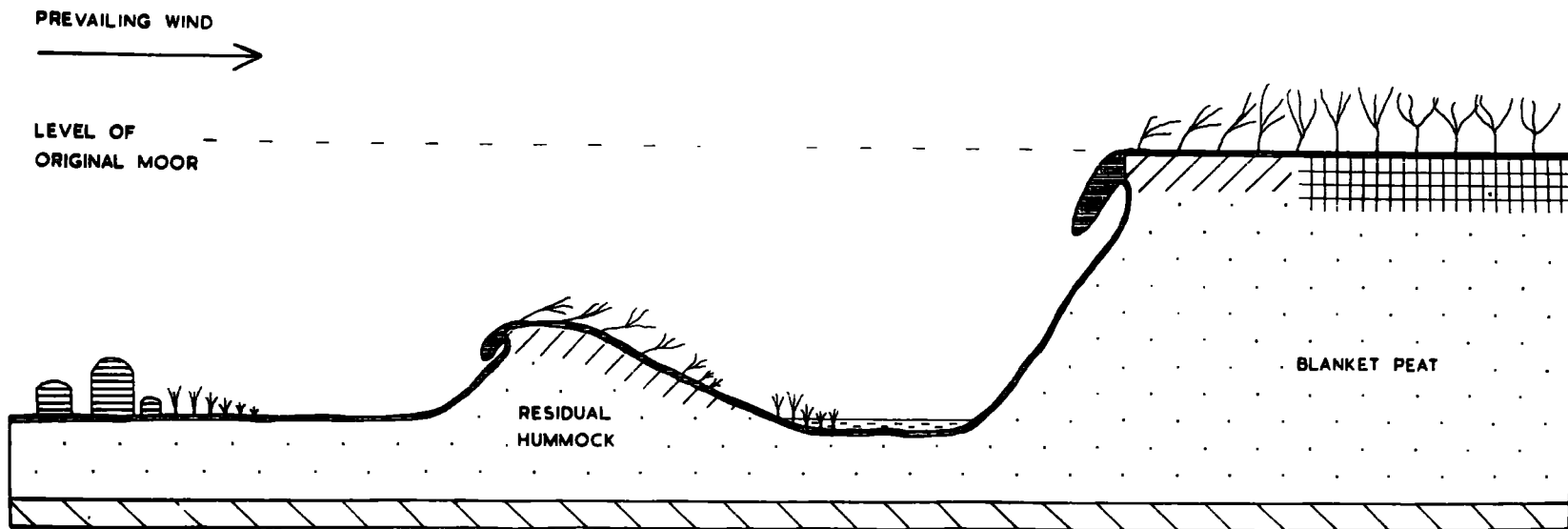









- | | | | | | |
|---|------------------|---|-----------------|---|---------------------------------|
|  | MIXED MOOR |  | PEAT AT SURFACE |  | <i>CALLUNA VULGARIS</i> |
|  | HUMMOCK TOP ZONE |  | WATER |  | <i>ERIOPHORUM VAGINATUM</i> |
|  | HAG LIP ZONE |  | BED ROCK |  | <i>ERIOPHORUM ANGUSTIFOLIUM</i> |

FIG. 20.

bare peat as a recoloniser in the wet areas (Plate 9). It has been reported that once such a plant cover becomes extensive, Calluna becomes established again, but this has not been observed at Moor House by the present writer.

The formation of channels or hags in the blanket peat by erosion, therefore, influences the local drainage and consequently changes in soil water content and vegetation cover occur over short horizontal distances. It is thus possible to determine the habitat preferences of Acarina under these variable natural conditions, and to deduce their succession which occurs as the Calluna moor is eroded away and then partially recolonised by other vegetation. Two similar studies, both on the Collembola of Moor House, have been made by Murphy (1955) who considered the pool and hummock growth system of Valley Bog; and by Hale (1963) on the eroding blanket bog of Moss Flats. The present study is comparable to the latter work.

b) The sampling programme :

Regular samples were taken simultaneously on the erosion area and the mixed Calluna moor from January-December, 1961, so that a direct comparison of the fauna of the two areas was possible. Four habitats were sampled on the erosion area:

1. The top of a residual Calluna hummock remaining after the surrounding moor has been eroded away.

2. An area of Eriophorum vaginatum.
3. Bare peat.
4. An area of Eriophorum angustifolium.
- (5. The lip or overhanging edge of a hag).

It is suggested that these areas 1-4 represent successive stages in the erosion cycle and partial recolonisation of blanket bog. The hag lip zone, area 5, is regarded as a special habitat in that it is an area of much modified mixed moor, and will not be regarded as a true stage in the erosion cycle. Fig. 20 shows an idealised transect across the eroding blanket bog with the sample sites indicated.

The sites were sampled on the following dates during 1961: 27 February, 29 May, 5 September, and 4 December. Fifteen sample units each 3 cm. in depth and 11.35 cm^2 in surface area were taken as described in Section V (page 52) from the dry hummock top, the lichen covered hag lip, the mixed moor and an area of E. angustifolium. Eight sample units each 6 cm. in depth and of 11.35 cm^2 in surface area were collected at the same time from the E. vaginatum tussocks, as only in this habitat did micro-arthropods occur below 3 cm. in depth.

In order to compare differences between vegetation types, and species differences in Acarina, the data for the year were grouped. This reduced variations caused by the annual cycle of the mites, and differences arising from separate sampling dates. This gave data of 60 sample units

each from the hummock top, the hag lip, mixed moor and the E. angustifolium; and of 32 sample units from the E. vaginatum.

Table 27. Soil water content of samples from the erosion area of Moss Flats compared with mixed moor. The figures are indices of humidity and are the means of 60 sample units each from all sites except the E. vaginatum which is the mean of 32 sample units.

Mixed moor	Hummock top	<u>Eriophorum vaginatum</u>	Bare peat	<u>Eriophorum angustifolium</u>	(Hag lip)
8.8	2.8	4.8	4.5	4.5	(2.0)

Table 27 shows a comparison of the mean values for 1961 of the soil water content of the four sample areas of Moss Flats compared with mixed moor, taken from Tables 6 and 9, and Springett (1963) pers. comm. The high value for mixed moor is due, in part, to the water retention properties of the Sphagnum mosses.

c) Distribution of Acarina :

Table 28 shows the mean density and the percentage composition of the groups of Acarina on the five sample sites of the erosion area compared with that on mixed moor. The greatest density was found on the hummock top, which was significantly higher than that of the mixed moor (difference between the means = 48.8 ± 9.5 , $P < 0.001$). The mean density of Acarina on mixed moor was also significantly greater than on the area of E. vaginatum (difference between the means = 14.7 ± 6.4 , $P < 0.05$).

Table 28. Mean density and the percentage composition of the major groups of Acarina on the five sites of the erosion area compared with the mixed moor. The figures are the mean density per 10 cm² and the standard error.

Group Site	Total Acarina	Cryptostigmata	Mesostigmata	Prostigmata	Astigmata
Mixed moor	48.7±4.2	45.3±4.2 93.0%	3.2±0.2 6.6%	0.2±0.1 0.4%	0.0
Hummock top	97.5±7.2	92.8±6.8 95.2%	2.5±0.2 2.6%	1.4±0.5 1.5%	0.8±0.3 0.7%
<u>Eriophorum</u> <u>vaginatum</u>	34.0±3.7	26.8±3.5 78.8%	4.1±0.6 12.1%	3.1±1.1 9.0%	0.0
Bare peat	0.0	0.0	0.0	0.0	0.0
<u>Eriophorum</u> <u>angustifolium</u>	26.0±3.1	25.3±3.1 97.4%	0.6±0.2 2.3%	0.1±0.03 0.4%	0.0
(Hag lip)	21.2±3.1	18.9±2.8 89.0%	1.6±0.2 7.6%	0.2±0.1 0.9%	0.5±0.3 2.5%

The Cryptostigmata composed 93-97 per cent of the total mite fauna on all sites with the exception of the E. vaginatum area where the group was 79 per cent of the total. The densities of the Cryptostigmata differ significantly in the same manner as the total Acarina density. The Mesostigmata were 2-8 per cent of the total fauna on all sites except, again, the area of E. vaginatum where they were 12 per cent. The Prostigmata constituted approximately one per cent of the total fauna on all sites except the E. vaginatum where it was nine per cent. The Astigmata were recorded only from the hummock top and the hag lip zone.

The mean densities of Acarina per 10 cm² (30 c.c.) on the sample sites of the eroding blanket bog are compared with the mixed moor in Table 29. The standard error of the mean is also given. Fig. 21 shows the distribution of the common species of Acarina on Moss Flats in diagrammatic form. The sample sites are arranged in what is considered to be the succession of erosion or degradation of mixed moor through to bare peat, and its initial re-colonisation by E. angustifolium. The common species on the mixed moor and hummock top were Chanobates schutzi, Carabodes minusculus and Tectocephus velatus. T. velatus and C. minusculus were in significantly greater numbers on the hummock top and mixed moor than on any other site ($P < 0.02$ for C. minusculus, and $P < 0.001$ for T. velatus).

Table 29. Mean densities of Acarina per 10 cm². (30 cc.) on the sample sites of the erosion area of Moss Flats compared with the mixed moor. The standard error of the mean is given.

Species or Family	Mixed moor	Hummock top	<u>Eriophorum vaginatum</u>	Bare peat	<u>Eriophorum angustifolium</u>	Hag lip
<u>Chamobates schutzi</u>	9.78 ±1.28	8.45 ±0.76	6.11 ±1.86	0.0	0.36 ±0.09	0.91 ±0.20
<u>Oppia-Suctobelba</u>	1.85 ±0.19	2.60 ±0.49	0.13 ±0.09	0.0	0.0	0.34 ±0.10
<u>Carabodes minusculus</u>	8.91 ±1.21	15.96 ±3.27	0.27 ±0.20	0.0	0.05 ±0.01	2.70 ±0.88
<u>Tectocepheus velatus</u>	4.80 ±0.25	16.38 ±3.59	0.27 ±0.17	0.0	0.0	7.03 ±2.09
<u>Platynothrus peltifer</u>	0.80 ±0.12	0.63 ±0.19	3.36 ±1.49	0.0	6.69 ±1.55	0.04 ±0.01
<u>Pelops planicornis</u>	0.23 ±0.05	0.63 ±0.16	1.65 ±0.46	0.0	0.0	0.44 ±0.25
<u>Liebstadia similis</u>	0.03 ±0.01	1.64 ±0.38	0.0	0.0	0.0	0.03 ±0.01
<u>Ceratoppia bipilis</u>	0.27 ±0.07	0.81 ±0.13	3.36 ±0.85	0.0	0.03 ±0.01	0.0
<u>Phthiracarus ligneus</u>	0.76 ±0.14	0.31 ±0.09	0.0	0.0	0.0	0.04 ±0.01
<u>Parasitidae</u>	1.12 ±0.25	1.07 ±0.20	1.23 ±0.13	0.0	0.04 ±0.01	0.74 ±0.09
<u>Olodiscus minima</u>	0.25 ±0.05	0.10 ±0.02	1.54 ±0.51	0.0	0.0	0.0
<u>Trachytes pyriformis</u>	0.15 ±0.05	0.10 ±0.03	0.33 ±0.10	0.0	0.0	0.06 ±0.02
<u>Merconidae</u>	0.04 ±0.02	0.06 ±0.01	0.0	0.0	0.0	0.45 ±0.12
<u>Meigalaidae</u>	0.82 ±0.12	0.54 ±0.07	0.22 ±0.08	0.0	0.06 ±0.01	0.23 ±0.09
<u>Trachylaelaptidae</u>	0.38 ±0.07	0.18 ±0.05	0.66 ±0.16	0.0	0.0	0.12 ±0.05

Fig. 21.

Diagram of the distribution of the common species of Acarina on eroding blanket bog at Moss Flats. The sample sites are arranged in the succession of erosion or degradation of mixed Calluna moor through to bare peat, and its initial recolonisation by Eriophorum angustifolium. The scale is of density in thousands per square metre.

DISTRIBUTION OF ACARINA ON EROSION AREA

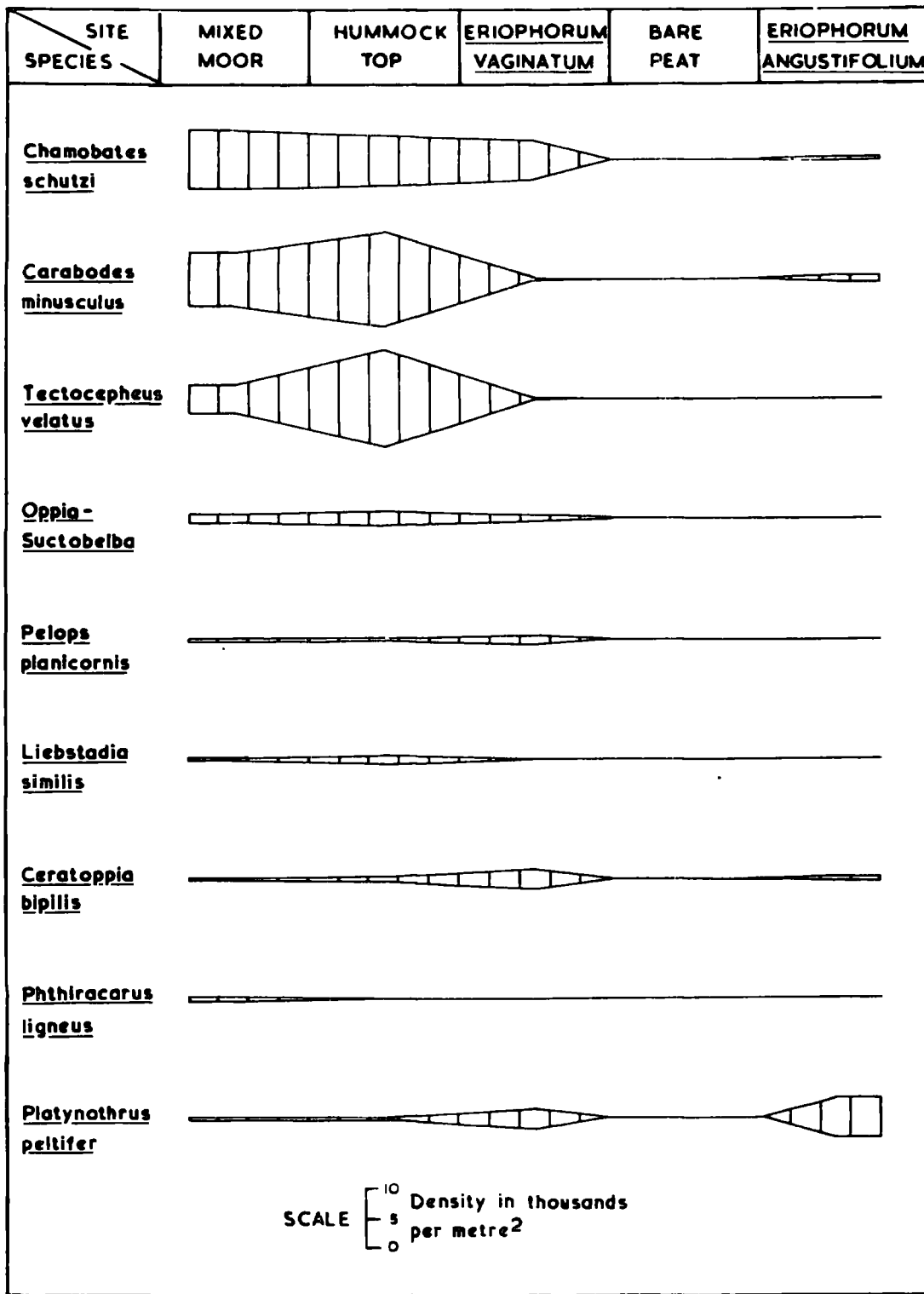

C. schutzi had a significantly ($P < 0.02$) higher density on three sites: Mixed moor, hummock top, and E. vaginatum tussocks than on any other area. Representatives of the Oppia-Suctobelba group were distributed similarly to C. schutzi, but in much lower densities. The species confined mainly to both the Eriophorum areas was Platynothrus peltifer, which had a significantly ($P < 0.001$) higher density on the E. angustifolium area than on the hummock top (difference between means = 6.06 ± 1.77). The difference between the mean densities of this species on the two Eriophorum areas was not significant. The mean density of Ceratoppia bipilis differed significantly at $P < 0.02$ between all the sample sites, and had the highest density on E. vaginatum.

The bare peat did not support a permanent population of Acarina, but occasionally individuals could be found which had presumably been carried there by the wind. In some areas of Moss Flats an algal mat is formed on the bare peat (see Plate 10). As conditions became drier in early summer, the peat cracks and the algal mat flakes away from the peat surface. Beneath these flakes high humidities were maintained and P. peltifer occurred in greater numbers than C. schutzi and C. minusculus. A similar habitat to this occurred beneath flat pieces of sandstone rock exposed by erosion on the peat (Plate 10), and here again P. peltifer outnumbered all other species. (P. peltifer has been recorded from moist habitats by Haerlöv (1942), Hammer (1946 and

Weis-Fogh (1948)). C. bipilis was also recorded from both these habitats. It would appear, therefore, that the bare peat areas of Moss Flats lacked a permanent mite population only because it did not afford sufficient protection from the adverse climatic conditions.

d) Discussion:

The processes of erosion of blanket bog are associated with the general drying out of the area as is shown in Table 27, and the prevailing wind. The distribution of Collembola on eroding blanket bog has been shown to be correlated with the soil water content of the habitats (Hale, 1963). Such a simple picture does not exist for the distribution of Acarina on Moss Flats.

The density of Acarina and the species abundance were not determined solely by the soil water contents of the habitats sampled. The number of species or groups present in each habitat was not related to the soil moisture. There were 15 species or groups recorded on the mixed moor and hummock top; two habitats which had very different soil water contents (see Table 27). Only six species or groups were represented on the E. angustifolium and twelve were present on the E. vaginatum; two habitats with a similar soil moisture content.

In order to examine further these differences between the sites, the samples from the special zone of the hag lip were studied (Tables 28 and 29). The hag lip was immediately

adjacent to the mixed moor, which supports a population of 48.7 ± 4.2 Acarina per 10 cm^2 . The hag lip was the driest of the sample areas (a mean Index of Humidity of 2.0 as compared with 8.8 of the mixed moor), and supported less than half the mite population of the mixed moor, although 13 out of the 15 species found on the mixed moor were also recorded from the hag lip. The hag lip zone had a similar soil water content to the top of the residual Calluna hummock, but supported less than a quarter of the hummock top mite population of 97.5 ± 7.2 per 10 cm^2 . There was thus a paucity of mites on the hag lip, which cannot be accounted for solely by the physical factors measured in the present study. It should be noted that the highest density of Collembola (125.20 ± 8.83 per 10 cm^2) has been recorded from the hag lip by Hale (1963).

It is suggested that biotic factors such as the changes in plant cover which take place as the moor is eroded may determine the distribution of Acarina. Associated with the changes in the vegetation are the changes in the soil microflora, which may well be important as many species of Cryptostigmata are fungivorous. The difference between the hag lip and the hummock top mite density was determined, therefore, by the different vegetation cover. It would appear that C. minusculus and T. velatus only could resist desiccation and inhabit the micro-cavities of the lichens on the hag lip.

Further evidence in support of this hypothesis is given by the distribution on the study area of the three common species of Oribatei: C. schutzi, C. minusculus, and T. velatus shown in Fig. 21. These species were all recorded with high densities in both wet and dry habitats; from the waterlogged mixed moor and the relatively dry hummock top. About the latter species some confusion exists in the literature as to its habitat preference. It has been found in high densities in a Swedish bog by Tarras-Wahlberg (1961), who placed it in the Mesophilous Hemiedaphon of the Gisin-Strenzke life form (:Lebensformen) classification, indicating that the species requires a relative humidity of 100 per cent. Klima (1959) has also recorded T. velatus from dry habitats. Previously, Strenzke (1952) had termed T. velatus a 'plastic' species in relation to the following five environmental factors: water content, humus content, pH, litter cover, and NaCl content of soil. The distribution of T. velatus on the eroding moor suggests that the species can withstand great extremes of environmental conditions.

The erosion of the moorland with the concomitant changes of vegetation cover cause different densities and species of Acarina to occur. As the mixed moor is slowly degraded by the loss of its plant cover to a bare peat surface, the abundance of soil mites falls, both in respect of number of species and total numbers. The distribution

of the characteristic species of Acarina with the stages of the erosion and recolonisation cycle of Pennine moorland may be summarised in the following manner:

		<u>Erosion</u>		<u>Recolonisation</u>		
Mixed moor	→	Hummock top	→	Bare peat	→	<u>Eriophorum</u> <u>angustifolium</u>
<u>Chamobates</u> <u>schutzi</u>			<u>Eriophorum</u> <u>vaginatum</u>	-		-
<u>Carabodes</u> <u>minusculus</u>				-		-
<u>Tectocephus</u> <u>velatus</u>				-		-
-	-		<u>Ceratoppia</u> <u>bipilis</u>	-		-
-	-		<u>Platynothrus</u> <u>peltifer</u>	<u>Platynothrus</u> <u>peltifer</u> (rare)	<u>Platynothrus</u> <u>peltifer</u>	

X THE FAUNA OF DIFFERENT SAMPLING AREAS

a) Introduction :

In this section the differences between Acarina of the sampling areas are discussed. These differences have been studied by examination of the species 'spectrum', the densities of the common species and groups of mites, and the density of total Acarina. This approach is used in preference to the sociological or biocoenological methods used by Haarløv (1960), Franz (1963) and Davis (1963) for soil organisms, as it is not the associations of different species of Acarina, but differences in the faunas of various habitats that are desired to establish.

The data resulting from monthly sampling have been used for comparative purposes. In order to allow for seasonal variations in density, the data for one year have been grouped. Mean annual values of the density of each group and species have thus been obtained. For each of the two years sampling on the Limestone grassland and mixed Calluna moor, the data are from 180 sample units. For the Juncus squarrosus moor and the Nardus stricta grassland, the data are of 60 sample units each. In the case of the Limestone grassland, and mixed moor, the two years data which are compared are for the same months in 1961 and for the same dates in 1962. Data from the Juncus squarrosus moor are for 1961, and data from the Nardus stricta grassland were collected in 1962.

In this section, the density is expressed as thousands per 10 cm², and not to the actual sample unit size of 11.35 cm². It is thus easier to calculate the density per square metre from this corrected data for comparison with other studies.

b) Qualitative differences :

From the data given in Table 30, it can be seen that there were few differences in the species composition of the fauna of the main sampling areas at Moor House. Both the peat soil of the mixed moor and the mineral soil of the Limestone grassland had 35 species or groups each. The mixed Calluna moor supported the largest number of Cryptostigmata species (27), whilst the Nardus stricta grassland site had the lowest number of species (18) of the same group. For the Mesostigmata, the largest number of species or groups (12) were recorded from the Limestone grassland, whilst the rest of the sites investigated had 8 to 9 species or groups each. Thus, the Cryptostigmata dominated the fauna of the sites which had a peat soil, and the Mesostigmata were recorded in greatest variety from the mineral soil of the Limestone grassland.

Two species occurred only in the mineral soil of the Limestone grassland, namely Minunthozetes semirufus and Cilliba cassidea; whilst three species: Hypochothonius rufulus, Camisia segnis and Camisia bistriatus were recorded only from the peat soil of the mixed moor, and the Juncus

Table 30. Species and groups of Acarina recorded from the four main sampling sites at Moor House. The records for the Limestone grassland and mixed moor are for 1961 and 1962, and the Juncus squarrosus site for 1961 only, and the Nardus stricta grassland site for 1962 only.

Note: + indicates species present, - indicates species not recorded.

	Limestone grassland	Mixed Calluna moor	<u>Juncus</u> <u>squarrosus</u> moor	<u>Nardus</u> <u>stricta</u> grassland
Cryptostigmata:				
<u>Hypochothonius rufulus</u>	-	+	+	-
<u>Pelops plicatus</u>	+	+	+	-
<u>Pelops planicornis</u>	+	+	+	+
<u>Ceratoppia bipilis</u>	+	+	+	+
<u>Chamobates schutzi</u>	+	+	+	+
<u>Platynothrus peltifer</u>	+	+	+	+
<u>Nothrus palustris</u>	+	+	-	+
<u>Nothrus silvestris</u>	-	+	+	+
<u>Oppia-Suctobelba</u>	+	+	+	+
<u>Cepheus dentatus</u>	-	+	-	+
<u>Phthiracarus ligneus</u>	+	+	+	-
<u>Nanhermannia nana</u>	+	+	+	+
<u>Thyrisoma lanceolata</u>	+	+	-	+
<u>Carabodes minusculus</u>	+	+	+	+
<u>Carabodés marginatus</u>	+	+	+	-
<u>Liebstadia similis</u>	+	+	+	+
<u>Oribatula tibialis</u>	+	+	-	+

Table 30 (continued)

	Limestone grassland	Mixed Calluna moor	Juncus squarrosus moor	Nardus stricta grassland
<u>Minunthozetes semirufus</u>	+	-	-	-
<u>Notaspis punctatus</u>	+	+	-	-
<u>Ceratozetes gracilis</u>	+	+	+	+
<u>Galumna sp.</u>	+	+	-	+
<u>Achipteria coleoptrata</u>	+	+	-	-
<u>Melanozetes mollicomus</u>	+	+	-	-
<u>Tectocephus velatus</u>	+	+	+	+
<u>Tectocephus velatus var sarekensis</u>	-	+	+	+
<u>Camisia spinifer</u>	+	+	+	-
<u>Camisia segnis</u>	-	+	+	-
<u>Camisia bistriatus</u>	-	+	+	-
<u>Trimalaconothrus foveolatus</u>	+	-	+	+
<u>Damaeus clavipes</u>	-	-	-	+
Total species of Cryptostigmata:	23	27	20	18

Mesostigmata:

<u>Trachytes pyriformis</u>	+	+	+	+
<u>Trachytes minima</u>	+	+	+	+
<u>Olodiscus minima</u>	+	+	+	+
<u>Rhodacarus roseus</u>	+	-	-	+
<u>Cilliba cassidea</u>	+	-	-	-

Table 30 (continued)

	Limestone grassland	Mixed Calluna moor	Juncus squarrosus moor	Nardus stricta grassland
<u>Parasitidae</u>	+	+	+	+
<u>Macrochelidae</u>	+	+	+	+
<u>Pachylaelaptidae</u>	+	-	-	+
<u>Veigaiidae</u>	+	+	+	-
<u>Aceosejidae</u>	+	-	-	+
<u>Digamasellidae</u>	+	+	+	-
<u>Zerconidae</u>	+	+	+	+
Total number of species and groups of Mesostigmata	12	8	8	9

squarrosus sites. The mixed moor and the Limestone grassland had a similar species spectrum of Acarina, unlike that of the Collembola and Tipulidae. Little difference was also recorded in the species spectrum of Nematoda (Banage, 1960) on the two sites. A single species, Damaeus clavipes, was found only in the alluvial soil of the Nardus stricta grassland. It has been observed in this study that D. clavipes was restricted to those areas having a deep litter layer on the soil surface, and it was recorded only from the litter surrounding the base of the rush, Juncus effusus in addition to the Nardus site. Rhodacarus roseus was found only on the Limestone grassland and the Nardus sites, showing a preference for mineral and alluvial soils. Fourteen of the thirty species of Cryptostigmata, and six of the twelve species or groups of the Mesostigmata were recorded from all four sample sites.

It should be noted here that the Nardus stricta grassland had the smallest number of species or groups (27) recorded from it, but it supported the highest mean density of total Acarina (77.83 ± 4.24 thousands per metre²). It follows that the high mean density of total Acarina on this site was caused by a higher mean density of individual species, and not by an increased number or variety of species. The species composition of the four main sample sites listed in Table 30 were very similar; and the species composition did not vary throughout the year.

c) Quantitative differences :

Species or groups which have mean annual densities in excess of 1,000 individuals per metre² are considered here. Consideration will first be given to quantitative differences between years on a single sampling area, and then to quantitative differences between sites for the same year.

(1) Annual differences on the same sampling area.

The mean annual density and the percentage composition of the major groups of Acarina on the four main sampling areas at Moor House are compared in Table 31. The figures are the mean density and standard error for 10 cm². On the Limestone grassland, the total Acarina density increased from 1961 to 1962, and this was caused by a highly significant ($P < 0.001$) increase in density of Cryptostigmata, Prostigmata and Astigmata. The percentage of the Prostigmata and Astigmata groups of the total Acarina density increased at the expense of the density of the Mesostigmata, which was reduced from 34 per cent (1961) to 21 per cent (1962) of the total density. The Cryptostigmata comprised 62 per cent of the total density for both years.

On the mixed moor there was a similar increase in total Acarina density recorded in the two study years, which was caused by a highly significant ($P < 0.001$) increase in the density of the Cryptostigmata, and Prostigmata. Again, the percentage of Prostigmata in the total density increased slightly from 1961 to 1962, and the percentage of

Table 51. Mean annual density and the percentage composition of the major groups of Acarina on the four main sample sites at Moor House. The figures are the mean density per 10 cm². and the standard error.

Group Site and year	Total Acarina	Cryptostigmata	Mesostigmata	Prostigmata	Astigmata
Limestone grassland, 1961	28.74±1.09	17.91± 0.79 62%	9.88±0.43 34%	0.94±0.14 3%	0.61±0.03 2%
Limestone grassland, 1962	45.29±1.41	28.24±1.29 62%	9.41±0.38 20%	6.87±0.49 15%	2.41±0.21 4%
Mixed <u>Calluna</u> moor, 1961	41.86±2.16	38.78±2.12 93%	2.85±0.16 7%	0.22±0.08 0.5%	0.14±0.03 0.3%
Mixed <u>Calluna</u> moor, 1962	65.79±3.19	62.01±3.50 94%	2.86±0.18 4%	0.87±0.12 1%	0.28±0.07 0.4%
<u>Juncus squarrosus</u> moor, 1961	43.01±3.09	40.34±3.04 93%	2.55±0.30 5%	0.10±0.04 0.2%	0.50±0.10 1.2%
<u>Nardus stricta</u> grassland, 1962	77.83±4.24	65.96±3.82 85%	9.91±0.69 13%	1.46±0.16 1%	0.51±0.12 0.6%

the Mesostigmata in the total Acarina decreased from seven to four per cent. The Cryptostigmata composed 93-94 per cent of the total density in both years.

The data for the density of individual species and groups on the four sample sites are given in Table 32. The mean densities of species which were in excess of 1,000 individuals per metre² are given. The results of a comparison of the mean densities of species and groups between the two study years on the same sample site are given in Table 33, for the Limestone grassland and the mixed moor. The only group which showed a similar change in mean density from 1961 to 1962 on both the study areas was the total juvenile Cryptostigmata. All the species considered were either recorded with no significant difference in mean density between years, or with significant increases or decreases in mean density, which differed on each of the two sites. The changes in density between years which were recorded on the two sites investigated were not similar.

The changes on the Limestone grassland between 1961 and 1962 were significant increases in the mean densities of many species of Cryptostigmata, and the only species which showed significant decreases in mean densities were Olodiscus minima and Trachytes pyriformis. On the mixed moor highly significant decreases in mean densities were recorded between years for Platynothrus peltifer and Chamobates schutzi. The Parasitidae showed a significant

Table 32. Mean annual densities of Acarina per 10 cm². on the four main sample sites at Moor House. The standard error of the mean density is given. Note: + indicates that species present, but less than 1,000 individuals per metre².

Species or group	Limestone grassland		Mixed <u>Calluna</u> moor		<u>Juncus squarrosus</u> moor	<u>Nardus stricta</u> grassland
	1961	1962	1961	1962	1961	1962
<u>Platynothrus peltifer</u>	1.14 ±0.11	1.64 ±0.18	1.41 ±0.13	0.54 ±0.08	2.18 ±0.31	8.37 ±1.87
<u>Pelops planicornis</u>	1.04 ±0.13	1.06 ±0.17	0.44 ±0.05	0.24 ±0.04	+	+
<u>Pelops plicatus</u>	1.16 ±0.12	1.57 ±0.24	0.30 ±0.06	0.12 ±0.07	+	0.0
<u>Chamobates schutzi</u>	0.51 ±0.09	0.01 ±0.001	6.80 ±0.55	3.09 ±0.26	+	+
<u>Nanhermannia nana</u>	0.43 ±0.07	1.20 ±0.17	2.36 ±0.23	2.24 ±0.21	7.64 ±1.76	6.08 ±1.74
<u>Carabodes minusculus</u>	0.67 ±0.08	0.63 ±0.08	8.66 ±1.35	11.79 ±1.88	+	+
<u>Carabodes marginatus</u>	0.62 ±0.01	2.26 ±0.03	1.75 ±0.41	2.20 ±0.45	+	0.0
<u>Liebstadia similis</u>	7.72 ±0.09	9.57 ±0.12	0.05 ±0.01	0.16 ±0.03	+	2.94 ±0.33
<u>Thyrisoma lanceolata</u>	5.51 ±0.68	6.09 ±0.69	0.41 ±0.07	0.61 ±0.05	0.0	+
<u>Oppia-Suctobelba</u>	1.49 ±0.14	1.62 ±0.16	2.00 ±0.14	1.66 ±0.21	+	2.77 ±0.64

Table 32 (continued)

Species or group	Limestone grassland		Mixed <u>Calluna</u> moor		<u>Juncus</u> <u>squarrosus</u> moor	<u>Nardus</u> <u>stricta</u> grassland
	1961	1962	1961	1962	1961	1962
<u>Melanozetes</u> <u>mollicomus</u>	0.07 ±0.02	1.94 ±0.13	0.75 ±0.12	1.03 ±0.15	0.0	0.0
<u>Tectocephus</u> <u>velatus</u>	1.18 ±0.13	1.37 ±0.14	5.46 ±0.40	5.80 ±0.40	2.97 ±0.25	+
<u>Cryptostigmata</u> juveniles	9.88 ±0.53	14.71 ±0.91	15.15 ±0.85	33.15 ±1.81	26.93 ±2.44	42.18 ±2.70
<u>Olodiscus</u> <u>minima</u>	2.55 ±0.18	1.62 ±0.14	0.19 ±0.03	0.22 ±0.03	0.16 ±0.04	2.20 ±0.26
<u>Trachytes</u> <u>pyriformis</u>	2.16 ±0.17	1.63 ±0.14	0.11 ±0.03	0.14 ±0.04	0.05 ±0.01	0.65 ±0.09
<u>Parasitidae</u>	3.25 ±0.18	3.26 ±0.19	1.28 ±0.08	1.77 ±0.13	2.50 ±0.24	3.07 ±0.28
<u>Zerconidae</u>	0.72 ±0.10	1.92 ±0.15	0.13 ±0.02	0.19 ±0.05	0.05 ±0.01	2.90 ±0.26

Table 33. A comparison of the mean densities of Acarina on the same sample site in different years of study (1961 and 1962). Data are shown of the Limestone grassland and mixed moor species.

Note: 0 indicates that there was no significant ($P > 0.05$) change in mean density between 1961 and 1962 on the same site.
 + indicates a significant ($P < 0.05$) increase in mean density between 1961 and 1962.
 ++ indicates a highly significant ($P < 0.001$) increase in mean density between 1961 and 1962.
 - indicates a significant ($P < 0.05$) decrease in mean density between 1961 and 1962.
 -- indicates a highly significant ($P < 0.001$) decrease in mean density between 1961 and 1962.

Species or group	Limestone grassland	Mixed <u>Calluna</u> moor
	1961 / 1962	1961 / 1962
<u>Platynothrus peltifer</u>	+	--
<u>Pelops planicornis</u>	0	0
<u>Pelops plicatus</u>	0	0
<u>Chamobates schutzi</u>	0	--
<u>Nanhermannia nana</u>	++	0
<u>Carabodes minusculus</u>	0	0
<u>Carabodes marginatus</u>	++	0
<u>Liebstadia similis</u>	++	0
<u>Thyrisoma lanceolata</u>	++	0
<u>Oppia-Suctobelba</u>	0	0
<u>Melanozetes mollicomus</u>	++	0
<u>Tectocepheus velatus</u>	0	0
Cryptostigmata juveniles	++	++
<u>Trachytes pyriformis</u>	-	0
<u>Olodiscus minima</u>	--	0
<u>Zerconidae</u>	++	0
<u>Parasitidae</u>	0	++

increase in mean density between years on mixed moor.

There was not, therefore, a general pattern of change in abundance of the common species of Acarina for both sample sites between 1961 and 1962. It might be expected that a climatic factor, such as rainfall or temperature, would affect the density of a species in a similar way on both areas, and thereby produce a similar pattern of change on the two areas between years for individual species.

This was not clearly so, although one species: Platynothrus peltifer showed a significant increase in density on the Limestone grassland between the two study years, and a significant decrease in density on mixed moor between study years.

From a consideration of the mean density of Acarina for 1961 and 1962 given in Table 31, and the data for changes in the mean densities of species in Table 33, it is concluded that there was a real increase in the mean population density of Acarina between years on the two sites studied. This increase was not due to a general factor acting on the total populations of both areas, but it is suggested that the changes in mean density were caused by biotic factors causing a change in the reproductive rate of species or factors affecting the mortality of the species. The changes in mean density could not be entirely caused by variable efficiency of extraction by the high-gradient apparatus, as

changes of this nature would not favour the extraction of one species and not another, or the same species in different habitats. Fluctuations in extraction efficiency might be expected to occur seasonally, and they would be dependent upon the physical condition of the soil samples, e.g. water content, and field temperatures. In an examination of the annual mean densities of species, differences caused by extraction efficiency would be minimised.

(ii) Differences between sampling areas.

It can be seen from Table 31, that the Nardus stricta site had the highest mean density of total Acarina of 77.82 ± 4.24 thousands per square metre, and the Limestone grassland in 1961 had the lowest mean density of 28.74 ± 1.09 thousands per square metre. The mixed moor (41.86 ± 2.16 thousands per metre² in 1961, and 65.79 ± 3.19 thousands per metre² in 1962), and the Juncus squarrosus site (43.01 ± 3.09 thousands per metre² in 1961) had intermediate mean densities.

It is interesting to note the percentages of Cryptostigmata in the total density of Acarina on the four sample sites. In the mineral soil of the Limestone grassland, the Cryptostigmata were 62 per cent of the total Acarina which agrees with the figure of 57 per cent given for the same group by Sheals (1957) in pasture soil. In the alluvial soil of the Nardus site, the Cryptostigmata were 85 per

cent, and in the peat soil of the mixed moor and the Juncus site were 93 to 94 per cent of the total Acarina. The Mesostigmata show a complimentary trend with the highest percentage (6 per cent) of the total fauna on the Juncus site. Thus the Cryptostigmata favoured the wet organic soils of the peat areas, as suggested by Strenzke (1952). The Prostigmata reached their highest mean density on the Limestone grassland (6.87 ± 0.49 thousands per square metre) in 1962, comprising only 15 per cent of the total fauna; and the lowest mean density on the Juncus site in 1961 (0.10 ± 0.04 thousands per square metre) which was 0.2 per cent of the total. The Astigmata occurred in highest density on the Limestone grassland in 1962 (2.41 ± 0.21 thousands per square metre), i.e. 5 per cent of the total fauna, but elsewhere the group did not contribute significantly to the total.

From Table 32 the following conclusions can be drawn on the density distribution of the common species of Acarina on the sample areas at Moor House. There were seven species which had their highest mean densities on the Limestone grassland, namely : Pelops planicornis, Pelops plicatus, Liebstadia similis, and Thyrisoma lanceolata of the Cryptostigmata; and the Mesostigmata were Olodiscus minima, Trachytes pyriformis and the Parasitidae. Platynothrus peltifer, the Oppia-Suctobelba group and the Zerconidae dominated the fauna of the Nardus stricta grassland. A

single species, Nanhermannia nana, reached its highest recorded density of 7.64 ± 1.76 thousands per square metre on the Juncus squarrosus moor. The highest mean densities of Chamobates schutzi, Carabodes minusculus, Carabodes marginatus, and Tectocephus velatus were recorded from the peat soil of the mixed Calluna moor. In general, there was no tendency for the density of individual species to vary in a constant proportion in the main environments studied at Moor House.

d) Comparison of the Moor House fauna with other areas :

(i) Qualitative comparison.

Considering only the 46 species of Cryptostigmata in the present study, which were given on pages 35 to 43 , a comparison can be made with other studies in Britain, Europe and Scandinavia; and the results are given in Table 34.

The closest similarity of the Oribatei species from Moor House and other British studies exists with the species lists of Macfadyen (1952) of a Molinia fen in Berkshire, and with the species recorded by Seyd (1962) from Kinder Scout in Derbyshire. From the former study there were 14 oribatid species (: 30 per cent of the Moor House fauna) in common with the present study; and in the list of Seyd (1962) there were 18 species in common with the Moor House fauna (: 39 per cent of the Moor House fauna). It is to be expected that a similarity exists in the composition of the oribatid fauna of two areas of Pennine moorland, and the present study

and Europe. The species of Cryptostigmata only are considered.

Authority	Soil type or area	Number of species present	Number of species in common with the Moor House fauna	Percentage of common species in fauna of area under comparison	Percentage of common species in Moor House fauna (46 species)
<u>Great Britain:</u>					
Macfadyen, (1952)	Molinia fen	36	14	39	30
Delaney, (1956)	Heathland	25	10	40	22
Sheals, (1957)	Uncultivated old grassland	12	6	50	13
Evans, (1961)	Seven forest soil types	22-35	3-8	14-23	6-17
Seyd, (1962)	Moorland on Kinder Scout, Derbyshire	23	18	78	39
Davis, (1963)	Mineral soils, Northampton- shire	21	6	28	13

Table 34 (continued)

Authority	Soil type or area	Number of species present	Number of species in common with the Moor House fauna	Percentage of common species in fauna of area under comparison	Percentage of common species in Moor House fauna (46 species)
<u>Europe and Scandinavia:</u>					
Tuxen, (1943)	Iceland	54	20	37	43
Hammer, (1944)	East Greenland	60	14	23	30
van der Drift (1950)	Netherlands	35	7	20	15
Kunst, (1960)	Bohemia	93	18	19	39
Haarløv, (1960)	Denmark	22	5	23	11
Tarras- Wahlberg, (1961)	Sweden	46	13	28	28
Karppinen, (1962)	North Finland	103	23	22	50
Dalenius, (1963)	Swedish Lapland	65	16	25	35

confirms this. The similarity of the Moor House mite fauna with that of the lowland Molinia fen (Macfadyen, 1952) is due to the peat soils of both areas. Notable absences from the species list of Cryptostigmata from the Reserve were Platynothrus punctatus, which is mainly distributed throughout the arctic, and was first recorded in Britain by Seyd in 1958; and Calyptozetes sarekensis, also added to the British list by Seyd (1962). Both these species have been recorded extensively from Scandinavia and the arctic (Hammer, 1944, 1946).

Ten oribatid species from Moor House (: 22 per cent of the fauna of the Reserve) were in common with the records of Delaney (1956) for heathland soils in south-west England, and six species (13 per cent of the Moor House species) were in common with the list of Sheals (1957) for grassland habitats. Similar low numbers of species were found to be in common with Evan's (1961) survey of seven forest soil types in the south of England (range from three to eight species in common), and with the study of Davis (1963) on the mineral soils of Northamptonshire (6).

A comparison of the Moor House Cryptostigmata fauna with recent Continental studies revealed that 50 per cent (23 species) of the moorland species were also recorded by Karppinen (1962) in north Finland; and 43 per cent of the Moor House fauna (20 species) were in common with the Iceland

studies of Tuxen (1943). Relatively high percentages of species in common with the Moor House list were found also in a bog in Bohemia by Kunst (1960), by Dalenius (1963) in Swedish Lapland, and Hammer (1944) in east Greenland. The six species of Camisiidae recorded on the Moor House Reserve were also included in a survey of Swedish camisiids by Sellnick and Forsslund (1955).

The species composition of the Moor House habitats studied had the closest similarity with the Kinder Scout records of Seyd (1962), and sub-arctic areas such as Finland and Iceland.

(ii) Quantitative comparison.

A comparison has been made in Table 35 of the results of the present work with the relative abundance of groups of the Acarina recorded from various British soils by other workers. Estimations of the density of Acarina prior to 1940 were considered to be inaccurate for the purposes of comparison due to the relative increase in extraction efficiency since that date.

The densities of total Acarina obtained in the present study for the mineral soil of the Limestone grassland were higher than those of Dhillon and Gibson (1962) of 22.0 thousands per metre², and Davis (1963) of 20.7 thousands per metre², for areas of similar soil type at lower altitudes. The closest similarity of the Limestone grassland results were with those obtained by Sheals (1956 and 1957)

Table 35. The relative abundance of groups of Acarina in various British soils. Populations are given in thousands per square metre. The seven forest soil types investigated by Evans (1961) were: Oak, Oak and Beech, Scots Pine, Larch, Douglas Fir, Corsican Pine, and Sitka Spruce.

Authority	Soil type	Total Acarina	Crypto-stigmata	Meso-stigmata	Pro-stigmata	Astigmata
Salt, et al. (1948)	Pasture (November)	164.4	-	-	-	-
Macfadyen, (1952)	<u>Molinia</u> fen (12 month mean)	77.6	69.0 89%	6.0 8%	2.0 3%	0.6 1%
Murphy, (1953)	Heathland	228.1	-	-	-	-
Sheals, (1956,1957)	Grassland (Oct., Dec., Apl., Oct.)	12.2-33.3	5.0-19.0 41-57%	4.0-9.0 33-27%	0.2-0.3 2-1%	3.0-5.0 25-15%
Nef, (1957)	Forest soil	400.0	-	-	-	-
Evans, (1961)	Forest soils (Spring)	98.0-452.0	57.0-312.0 58-69%	5.0-29.0 5-6%	35.0-100.0 36-22%	1.0-11.0 1-2%
Dhillon and Gibson, (1962)	Undisturbed grassland (15 month mean)	22.0	-	-	-	-

Table 35 (continued)

Authority	Soil type	Total Acarina	Crypto- stigmata	Meso- stigmata	Pro- stigmata	Astig- mata
Davis, (1963)	Mineral soils (6 month mean :Nov-June)	20.7	3.7 18%	10.8 52%	1.7 8%	4.5 22%
Present study	Limestone grassland (24 month means)	28.7-45.3	17.9-28.2 62%	9.4-9.9 21-24%	0.9-6.9 3.15%	0.6-2.4 2.5%
"	Mixed moor (24 month means)	41.9-65.8	38.8-62.0 94%	2.9 4%	0.2-0.9 0.5-1.0%	0.1-0.3 0.2-0.4%

for old and newly-sown grasslands (12-33 thousands per metre², but does not exceed it. The records of the total density of mites in lowland pasture by Salt et. al. (1948), heathland by Murphy (1953) and the forest habitats investigated by Nef (1957) and Evans (1961) were all in excess of those found on Pennine moorland.

The predominance of species of the Cryptostigmata in the fauna of mixed moor and the Molinia fen (Macfadyen, 1952) ranged from 89 to 94 per cent of the total. The percentage of this group in the total fauna of the Limestone grassland (62 per cent) is comparable to that recorded by Evans (1961) for forest soils. For the Mesostigmata, a similar proportion (5-6 per cent) of this group was estimated by Evans (1961) to be in forest soils as was recorded from the peat soil at Moor House (4 per cent). Similar densities of the Mesostigmata which were recorded in the present study, were found by Sheals (1957). Low proportions of both the Prostigmata and the Astigmata groups were found in the Moor House soils investigated, as compared with the other habitats listed in Table 35.

XI BIOMASS OF ACARINA

a) Introduction :

An index of the amount of matter entering or leaving a population is the best measure of the contribution of that population to the functioning of the community. This index can be expressed as biomass, or weight of living material, as proposed by Macfadyen (1957), if the length of life of the organisms is known. It is evident that the activity of a species is not only dependent on the number of individuals representing the species within the community, but also on the size and weight of these individuals, that is, the biomass. The total quantity of biomass of a population at any one time is the 'stock' (: Bestand) or 'standing crop', and the amount of material produced in excess of the initial stock in unit time is the 'production' (: Produktion) or productivity (: Produktivität).

There are two main limitations of the use of biomass as an estimate of biological activity. Firstly, the live weights of organisms which contain a large proportion of water, give an inflated idea of their biological significance. The dry weight of an organism can be used to overcome this, or the method of Zeuthen (1947), who measured total body nitrogen as an index of the content of active protoplasm. Secondly, the biological activity of equal weights of all animals is not uniform. For example, the

respiratory activity of animals is related to their surface area rather than to their weight. However, mere numbers of animals in the soil may indicate little in respect of their activity, and a means whereby both size and density may be integrated will give a clearer conception of the role of the living material present. This can be achieved by calculating the biomass of the individuals comprising the population.

With soil fauna, particularly the mites, the small size of many species and their immature stages is a great difficulty, and on this account most of the weights must be estimated. Biomass is expressed as live weight per unit area or volume. For a given species, it is expressed as the sum of the mean weights per individual per age class, multiplied by the mean density obtained from sampling data. A complete turnover or renewal of the acarina biomass every one or two years, is to be expected on high moorlands; due to there being one generation annually under those conditions.

Van der Drift (1950) calculated the volume of individuals by measurement and, in some cases, by constructing an enlarged model of the species and determining its volume. The biomass of species of Acarina and Collembola have been estimated by Macfadyen (1952), by direct weighing of some of the larger species, and calculating the volumes of a number of representative adult animals in the populations being studied. A conversion factor was obtained for each

species, and applied to other animals as they most nearly resembled the shape of the weighed species. The volumes were then converted into weights by multiplication by the conversion factors. However, it was stressed that the figures obtained in this way only indicated the order of magnitude of the biomass.

Dufey (1959) obtained better estimates of the biomass of oribatid mites, by considering their shape to be ellipsoids or hemi-ellipsoids surmounted by a cone. The volume, v , was then calculated by

$$v = \frac{4}{3} \pi \frac{L \times b \times d}{8}$$

- which simplifies to:

$$v = 0.524 \times L \times b \times d$$

for ellipsoids, and by

$$v = \pi \frac{L \times b \times d}{8}$$

- which simplifies to:

$$v = 0.393 \times L \times b \times d$$

for half-ellipsoids surmounted by a cone; where L is the length, b the breadth, and d the depth of the mite in both cases. To estimate the weight, the volume obtained in this way is then multiplied by the density (1.1). Direct weighing of individual animals with an electro-magnetic balance (Berthet, 1958) has shown that the above method is not sufficiently accurate for the estimation of biomass, due to

the high densities attained by some species. Berthet (1958) has also observed that individual variation between specimens is extensive in some species, while in others the weights are relatively uniform.

b) The weights of Acarina obtained in the present study:

A series of live weights of common species of Acarina have been obtained in the present study, in order to estimate biomass in moorland soils. Adult specimens only of each species were weighed. A general mean weight for the immature forms of the Cryptostigmata was obtained by weighing representative groups of different instars and sizes. Mean live weights of representatives of the common families of the Mesostigmata were obtained similarly. No measurements of the Astigmata and Prostigmata were made, as these groups contributed little to the total biomass of Acarina due to their low densities on the sites studied.

The mites were extracted in a Tullgren funnel from litter and moss from Moor House; collected on water; and sorted into species and groups. The specimens were killed by placing them in an atmosphere of ethyl acetate, allowed to dry on filter paper for a few seconds, and weighed immediately. From 10 to 60 specimens were weighed at one time in a micro silver foil boat on an Oertling analytical beam balance (model 147) at room temperature.

Dry weights were obtained by drying the specimens at

105°C in an air oven for 24 hours, and reweighing to constant weight. The means of live and dry weights for the species and groups examined are given in Table 36, with their standard deviations. The dry weight, in most cases was approximately one quarter to one third of the live weight. The water content of the total live weight of adult specimens ranged from 50 to 71 per cent by weight.

A comparison has been made, as far as the data will allow, between the live weights (in μ g.) recorded in the present study, and the weights determined by van der Drift (1950), Macfadyen (1952), Dufey (1959) and Berthet (1963) using the methods outlined above. Live weights of those species of similar size or in the same genus recorded by these other workers, are included in Table 37 for comparison with the present results. There appears to be no records of live weights of the Mesostigmata, and so a comparison is not possible.

From Table 37, which consists only of the Cryptostigmata, it can be seen that there is a good agreement between the live weights of Oribatei mites recorded by Berthet (1963), and those of the present work. There is a considerable difference between the respective weights of Carabodes femoralis (Berthet, 1963), and Carabodes minusculus (present study); two species which would be expected to have similar live weights from their similar size and shape. Macfadyen (1952)

Table 36. Mean weights of adult specimens of Acarina (except where otherwise stated) in μ g. (1 μ g. is equal to 1/1000 mg). The standard deviation of the mean weight is given.

Note: - indicates no figures available.

Species or group	Mean weight		Percentage water content	Number of specimens weighed	Number of weighings
	Live	Dry			
<u>Nanhermannia</u> <u>nana</u>	17.2 \pm 1.4	7.4 \pm 0.5	57.0	30	2
<u>Platynothrus</u> <u>peltifer</u>	56.0 \pm 4.8	25.6 \pm 1.8	53.6	60	6
<u>Oppia-</u> <u>Suctobelba</u>	2.0	1.0	50.0	30	1
<u>Tectocephus</u> <u>velatus</u>	4.8	1.7	64.6	30	1
<u>Phthiracarus</u> <u>ligneus</u>	76.5 \pm 4.6	22.5 \pm 1.8	70.6	30	3
<u>Ceratoppia</u> <u>bipilis</u>	63.8 \pm 2.8	20.5 \pm 1.5	67.9	60	6
<u>Chamobates</u> <u>schutzi</u>	8.3 \pm 0.4	2.5 \pm 0.6	69.9	60	3
<u>Carabodes</u> <u>minusculus</u>	28.4	10.4	63.4	30	1
Immature Cryptostigmata	3.3 \pm 0.9	-	-	100	2
<u>Olodiscus</u> <u>minima</u>	15.6	5.2	66.7	20	1
<u>Parasitidae</u>	258.4 \pm 39.9	103.2 \pm 25.7	60.0	10	2
<u>Macrochelidae</u>	408.4 \pm 96.6	150.9 \pm 45.5	63.1	10	2
<u>Veigaliaidae</u>	139.6 \pm 24.7	65.7 \pm 18.2	52.9	10	2

Table 37. Mean live adult weights (in μ g.) of species of Cryptostigmata. The results of the present study are compared to those of previous workers.

Note: - indicates that no records are available.

1 μ g. is equal to 1/1000 mg.

Species	van der Drift (1950)	Macfadyen (1952)	Dufey (1959)	Berthet (1963)	Present work
<u>Nanhermannia elegantula</u>	8.8	9.5	15.2	18.1	-
<u>Nanhermannia nana</u>	-	-	-	-	17.2
<u>Hypoehthonius rufulus</u>	16.5	-	18.0	22.1	-
<u>Nothrus palustris</u>	-	-	-	182.5	-
<u>Nothrus silvestris</u>	44.0	-	-	47.1	-
<u>Platynocheilus peltifer</u>	55.0	-	56.8	62.8	56.0
<u>Suctobelba subtrigona</u>	-	-	1.0	1.3	} 2.0
<u>Oppia spp.</u>	2.2	0.5 - 2.7	0.5 - 3.5	1.3 - 3.1	
<u>Ceratoppia bipilis</u>	-	-	53.3	64.8	63.8
<u>Tectocephus velatus</u>	4.4	2.5	3.2	4.2	4.8
<u>Carabodes femoralis</u>	-	-	-	42.6	-
<u>Carabodes minusculus</u>	-	-	-	-	28.4
<u>Chamobates incisus</u>	9.9	-	-	6.5	-
<u>Chamobates schutzi</u>	-	-	-	-	8.3
<u>Phthiracarus ligneus</u>	-	5.9	-	-	76.5
<u>Phthiracarus piger</u>	-	-	-	162.1	-
<u>Phthiracarus borealis</u>	-	-	89.2	75.7	-

has estimated a low weight of 5.9 μ g. for Phthiracarus ligneus, which seems unacceptable. All the weight estimations by this author appear to be low, and should be treated with caution. There is also a marked difference between the weight of Phthiracarus ligneus (present study) and the weight of Phthiracarus piger (Berthet, 1963), but this latter species is larger.

c) Biomass of Acarina at Moor House :

An estimate of the biomass of mites on the Moor House sample areas has been obtained by multiplication of the mean live weight and the mean density of each species from sampling data. The biomass has been expressed as grammes per square metre. For species which have not been weighed in the present study, the mean live adult weights determined by Berthet (1963) have been used in the calculation of biomass. From the average annual density of Acarina on the sample sites at Moor House, biomass estimates have been made for the different areas, ranging from mineral soil to peat moor. The biomass estimates of Acarina are compared to the mean density on the sample areas in Table 38.

Generally, it can be seen that the greater biomass occurs on the areas which have the highest density of Acarina. The largest biomass was recorded from the Nardus stricta grass-land site, which also had the highest density of mites. The lowest biomass of Acarina occurred on the hag lip zone

Table 38. Estimated average annual biomass of mites for the Moor House sample sites, compared with the mean annual density. The weights are grammes per square metre, and the standard error of the mean density (in thousands per square metre) is given.

<u>Site and year</u>	<u>Live-weight biomass</u>		Total Acarina	Acarina density $\times 10^5$ per square metre	Live-weight biomass of 1000 individuals in g
	Cryptostigmata	Mesostigmata			
Limestone grassland (1961)	0.25	0.64	0.89	28.74 \pm 1.09	0.0307
Limestone grassland (1962)	0.36	0.72	1.08	45.29 \pm 1.41	0.0240
Mixed <u>Calluna</u> moor (1962)	0.69	0.42	1.11	41.86 \pm 2.16	0.0264
Mixed <u>Calluna</u> moor (1962)	0.72	0.40	1.12	65.79 \pm 3.19	0.0169
<u>Juncus squarrosus</u> moor (1961)	0.39	0.52	0.91	43.01 \pm 3.09	0.0210
<u>Nardus stricta</u> grassland (1962)	0.86	0.99	1.85	77.83 \pm 4.24	0.0237
Erosion area (1961)					
Hag lip	0.17	0.15	0.31	21.22 \pm 3.11	0.0148
Hummock top	0.93	0.28	1.21	97.52 \pm 7.17	0.0125
<u>Eriophorum</u> <u>angustifolium</u>	0.44	0.10	0.54	26.01 \pm 3.14	0.0208
<u>Eriophorum</u> <u>vaginatum</u>	0.59	0.31	0.90	34.02 \pm 3.70	0.0265

of the eroding blanket bog, where low populations of Acarina have been found.

There was little change in the total biomass between years on mixed moor (see Table 38), although the population increased; but there was an estimated increase of 0.29 g. per metre² in total biomass on the Limestone grassland from 1961 to 1962. This increase was due to a marked increase from 29 to 45 thousand individuals per square metre. Both the component Cryptostigmata and Mesostigmata showed an increase in biomass.

The final column in Table 38 shows that, on average, the individual mites tend to be larger on the Limestone grassland. This is due to a higher proportion of large species rather than the individuals of the same species differing in size.

d) Seasonal variation in biomass :

The total biomass of Acarina has been calculated monthly for the Limestone grassland and mixed moor for both the study years (1961 and 1962). The seasonal variation in total biomass is shown in Fig. 22 for both sites. The biomass of the Cryptostigmata and the Mesostigmata is also shown. There was a difference between years in the seasonal variation of biomass on both the sites studied. The main peaks of biomass of Acarina in 1961 occurred in April on the Limestone grassland with estimated biomass of 1.25 g. per

Fig. 22.

Seasonal variations in the estimated biomass of Acarina on the Limestone grassland and mixed Calluna moor. The data are of two complete years, 1961 and 1962. The biomass is expressed as grammes per square metre, and data for the Cryptostigmata and Mesostigmata groups are given.

SEASONAL VARIATION IN BIOMASS OF ACARINA

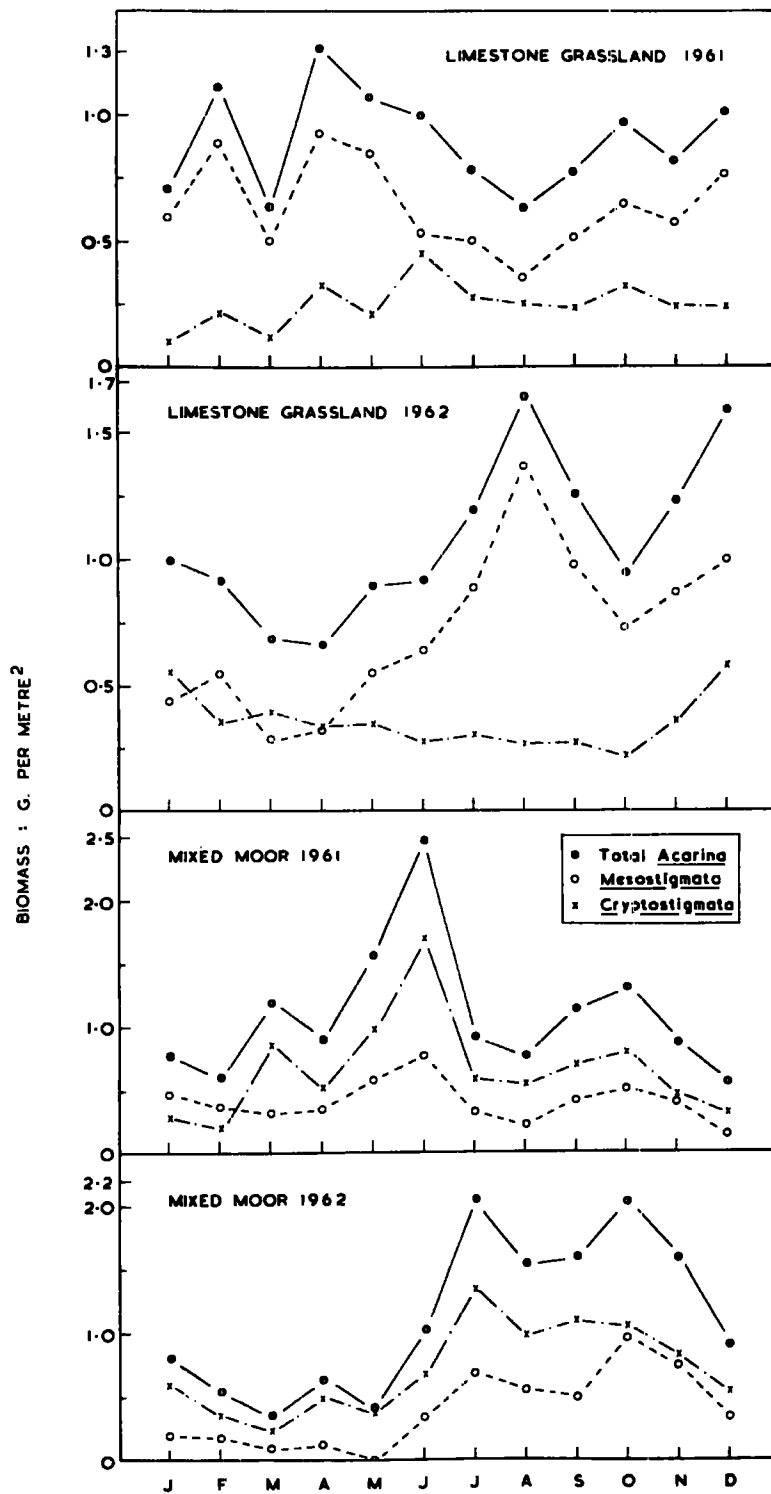

metre², and in June on mixed moor (2.5 g. per metre²). In 1962, the highest biomass was estimated for August on the Limestone grassland of 1.65 g. per metre². Thus, the late spring of 1962 apparently affected the population density of mites, and was reflected in the occurrence of late peaks of biomass in both areas. The peaks of high biomass on both the sites coincided with the period in the year when young forms were maturing to the adult stage, and when the Mesostigmata occurred in greatest density.

On the Limestone grassland area, the majority of the biomass (69.4 per cent) was composed of the Mesostigmata, and the periods of high biomass were caused by an increase in the density of the Parasitidae. The Cryptostigmata constituted approximately 31 per cent of the total biomass on this site, and the biomass fluctuated only slightly throughout the year. On the mixed moor, there was a difference in that the Cryptostigmata were 63.1 per cent of the total biomass. The contribution of the Mesostigmata to the total biomass was reduced to 36.9 per cent. Again, the biomass of this group fluctuated little during the year on mixed moor.

The predominance of members of the Mesostigmata in the fauna of the Limestone grassland, showed itself in the increased total biomass on that site compared to mixed moor.

e) Comparison with previous studies :

A comparison of the estimated biomass of Acarina on the

Moor House sites with previous studies is made in Table 39. The estimates for the moorland areas range from 0.31 to 1.85 g. per metre² for populations of 21 to 77 thousand Acarina per metre²; and compare most favourably with the estimates of 0.23 to 1.40 g. per metre² by Macfadyen (1952) for the biomass of oribatids of a Molinia fen. The maximum estimated biomass for total Acarina of the Moor House sites also shows similarities to the estimates of van der Drift (1950) of 1.9 g. per metre² for total Acarina of beech litter, and to the estimates of Stockli and Koffman (quoted in Kuhnelt, 1961) of 1.5 g. per metre² for mites and Collembola of a Swiss meadow.

It is suggested from the biomass data presented, that the Acarina may make a much smaller contribution by weight to the soil turnover on moorlands than their numerical abundance suggests.

Table 39. Comparison of the estimated live-weight biomass of Acarina (in g. per metre²) at Moor House with previous studies.

Note:- indicates that no figures are available.

Authority and year	Animal group	Soil type	Density in thousands per metre ²	Biomass g.per m ²	Biomass g.per 1000 individuals
Bornebusch (1930)	Acarina	Oak mull	-	0.6	-
Bornebusch (1930)	Acarina	Beech mull and beech raw humus	-	0.3	-
Bornebusch (1930)	Acarina	Spruce mull and spruce raw humus	-	0.5	-
van der Drift (1950)	Acarina	Beech raw humus	32	1.9	0.059
Volz (1951)	Small arthropods	West German forest soils	-	1.82	-
Macfadyen (1952)	Oribatei	<u>Molinia</u> fen	33-220	0.23-1.40	0.0067-0.0070
Nef (1957) (a compilation)	Acarina	Spruce plantation, and deciduous forest with mull soil	400	4.0	0.01
Stockli and Koffman (in Kuhnelt, 1961)	Mites and Collembola	Swiss meadow	300-450	1.5	0.004
Macfadyen (1961)	Acarina	Grazed meadow	-	3.0	-
Present work	Acarina	Upland peat and mineral soils	21-77	0.31-1.85	0.0148-0.0240

XII LIFE HISTORY STUDIES

a) Introduction :

Since the pioneer studies of Michael (1883-1887) on the life histories of the Oribatei, many laboratory culture studies have been made by Jacot (1936), Grandjean (1950a), Riha (1951), Sengbusch (1954, 1958), Pauly (1956) and Woodring and Cook (1962). The attention of workers has recently turned to the study of the life cycles of oribatid mites in the field, and the lack of identification keys for the immature stages of many of the common soil species has been the main reason for such studies. Haarløv (1960) worked out the life cycles of soil-dwelling species of Acarina from field data collected by regular sampling. More recently, Hartenstein (1962 a-f) has given life history data for several species of Cryptostigmata. Life history studies of the Mesostigmata have been made by Karg (1961) and Hartenstein (1962 h and i). The present studies were undertaken to obtain information on the biology and life histories of oribatid mites under sub-arctic conditions from material collected in the field.

b) Platynothrus peltifer (Koch 1839) :

Platynothrus peltifer occurs in soils throughout the Palearctic region (Karppinen 1958), Dalenius 1960, and Haarløv 1960), and in Greenland (Hammer 1946). The life cycle of this species has been studied by Grandjean (1950), Haarløv (1960) and Hartenstein (1962 d).

The adult of P. peltifer was first described and figured by Sellnick (1928), and as Hermannia bistriata (Michael, 1887). The adult deposits eggs singly or in batches of three or four (Grandjean, 1950), and feeds on decaying leaf or wood tissues and fungi (Hartenstein, 1962 d). Haarløv (1960) concluded that P. peltifer had a single generation each year in the field, the larvae appearing in August and September, and the rest of the life cycle was completed during the following 11-12 months. Hartenstein (1962 d) also considered that this species had one generation annually in leaf litter of the Tully forest, New York.

An analysis was made of the immature material of P. peltifer, obtained from regular monthly samples in 1961 from the Limestone grassland at Moor House. The juvenile forms were identified with the help of descriptions and figures by Grandjean (1950), Tuxen (1952) and Hartenstein (1962 d). The four immature stages were separated, initially, by measurements of the width of the propodosoma, the length of the propodosoma (excluding the gnathosoma), and length of the first leg (from the distal part of the coxal segment to the tarsus). It was found that the length of the first leg was the best measurement to use, but the frequency distributions of these values overlapped for the instars. The measurements were separated using probability paper by the method used by Harding (1949) for the analysis of polymodal

frequency distributions. The frequency distribution of the measurements for each stage approximated to a normal distribution, and plotting the values obtained on probability paper produced a straight line for each normal distribution. The mean value of the measurement, and standard deviation for each instar was then obtained from the graph. This part of the study was carried out before it was realised that the immature stages could be separated on the number of genital discs and the setation of the genital and anal plates. This method has obvious use for species which lack obvious structural differences to assist in the separation of the instars. The mean length of the first leg obtained for each stage and the standard deviation is given in Table 40, with Dyar's increase factor for each moult.

Table 40. Mean length of first leg of instars of Platynothrus peltifer obtained by probability analysis. The mean measurements are given in millimetres.

Instar	Mean length of first leg in millimetres. (distal part of coxa to tarsus)	Dyar's increase factor
Larva	0.131 ± 0.007	-
		1.37
Protonympha	0.180 ± 0.018	1.31
Deutonympha	0.236 ± 0.024	1.28
Tritonympha	0.303 ± 0.023	1.25
Adult	0.380 ± 0.017	

The life cycle of P. peltifer under upland conditions is given in Fig. 23, with the percentage composition of each stage of the total number of specimens collected on each monthly sample date. Larvae were found in the samples in the period January to April, and in August, September and December, 1961. The species overwintered mainly as eggs, larvae, protonymphae and adults at Moor House. This disagrees with the results of Noordam and de Vlieger (1943), who recorded that P. peltifer overwintered only in the adult stage, and that nymphs occurred in the oak litter studied from February to June in the Netherlands. Peaks of relative abundance of protonymphae occurred in February and November, and of deutonymphae in May, and of tritonymphae in July. A relative increase in adult density was recorded in August and January of the study year.

It is clear from Fig. 23 that P. peltifer has a single generation per year under moorland conditions, the eggs hatching in autumn and the rest of the life cycle being completed in the following 11-12 months. From Fig. 23 the duration of each instar has been estimated. The larval stage is one month in length, the protonymphal stage lasts at least three months, the deutonymphal stage is two months and the tritonymphal stage is about one month at Moor House. This agrees with the results of Haarløv (1960) for this species in litter of a hawthorn thicket in the Jaegersborg Park, Denmark.

Fig. 23.

Life cycle of Platynothrus peltifer at Moor House in 1961.

The material was collected from the Limestone grassland site.

The histograms indicate the percentage of each instar, in the total number of all stages, on each monthly sampling date.

LIFE CYCLE OF PLATYNOTHRUS PELTIFER

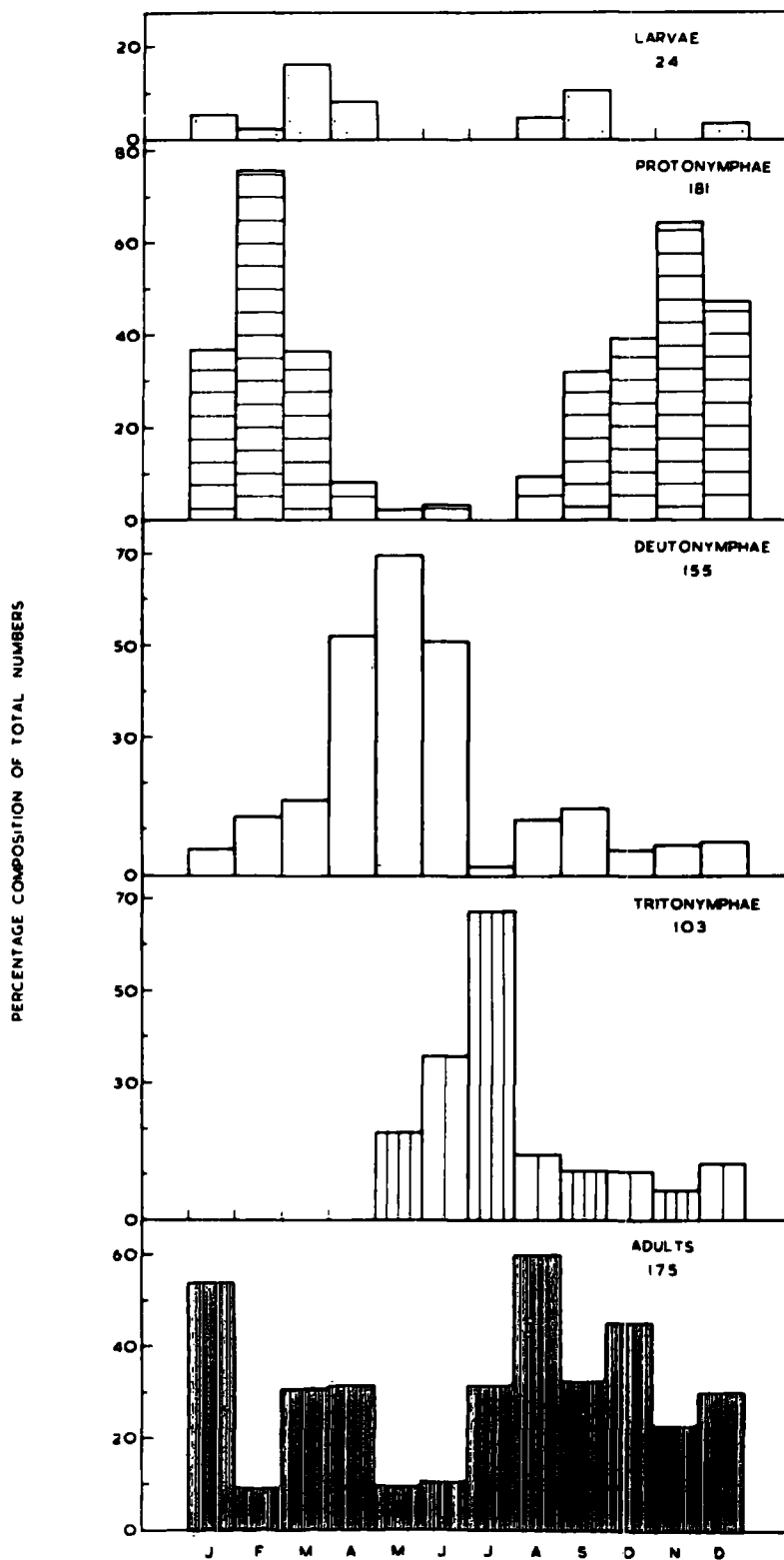

b) Damaeus clavipes (Herm. 1804) :

This species was recorded from the Nardus stricta grassland and the litter around the base of the rush Juncus effusus at Moor House. The adult has been described as Belba clavipes by Michael (1883-7), and by Kulczynski (1902). Pauly (1956) studied the biology of this species in culture, but no data are available on the life cycle in the field.

The juvenile material of D. clavipes from monthly samples of litter from Moor House during 1961, was separated into instars by the number of genital discs and setae on the genital plate. The diagnostic characters used in the identification of the stages were as follows :-

1. Larva: Three pairs of legs present, and the genital plate absent. Anal plate has a single pair of short setae.
2. Protonympha: Four pairs of legs present. The genital plate bears one pair of setae, and has a single pair of genital discs. The anal plate has two pairs of setae flanked by three outer pairs of setae.
3. Deutonympha: The genital plate has three pairs of setae, and two pairs of genital discs. The anal plate has three pairs of setae flanked by three outer pairs of setae.
4. Tritonympha: Five pairs of setae present on the genital plate and three pairs of genital discs. The anal plate has five pairs of setae.

To confirm the separation of the immature stages, measurements were made on each instar of D. clavipes, and

the means of the measurements with the standard deviations are given in Table 41. The Dyar's increase factors have been calculated for each moult, and it is interesting to note that the greatest increase was recorded between the proto- and deuto-nymphal stages in all the measurements, with the exception of the length of the first tarsus. The protonymphal stage was also estimated to be the longest in duration from field data as shown below. It can be seen that for all the adult measurements, the female is significantly larger than the male, which was observed by Jacot (1934, 1936)

The life cycle of D. clavipes at Moor House is shown in Fig. 24. The percentage composition of each stage in the total number of specimens collected on each sampling date is shown, and the data are grouped on a bimonthly basis. Larvae were present from July to October, 1961, indicating that D. clavipes is a species in which egg laying is confined to the summer months under sub-arctic conditions. Protonymphae were found in the period September to February. Deutonymphae were absent from the samples in July and August, but this stage had a spring and autumn peak of relative abundance. Tritonymphae were present throughout the year, but were a high percentage of the total numbers of this species in November, December, May, and June. Adults were recorded from all the monthly samples, and had a maximum density in July and August which was caused by

Fig. 24.

Life cycle of Damaeus clavipes at Moor House in 1961. The material was collected from the litter of Juncus effusus on Troutbeck Flats, (see Fig. 1). The histograms indicate the percentage of each instar in the total number of all stages on each sampling date. The data are presented in bimonthly groups.

Fig.24.

LIFE CYCLE OF DAMAEUS CLAVIPES

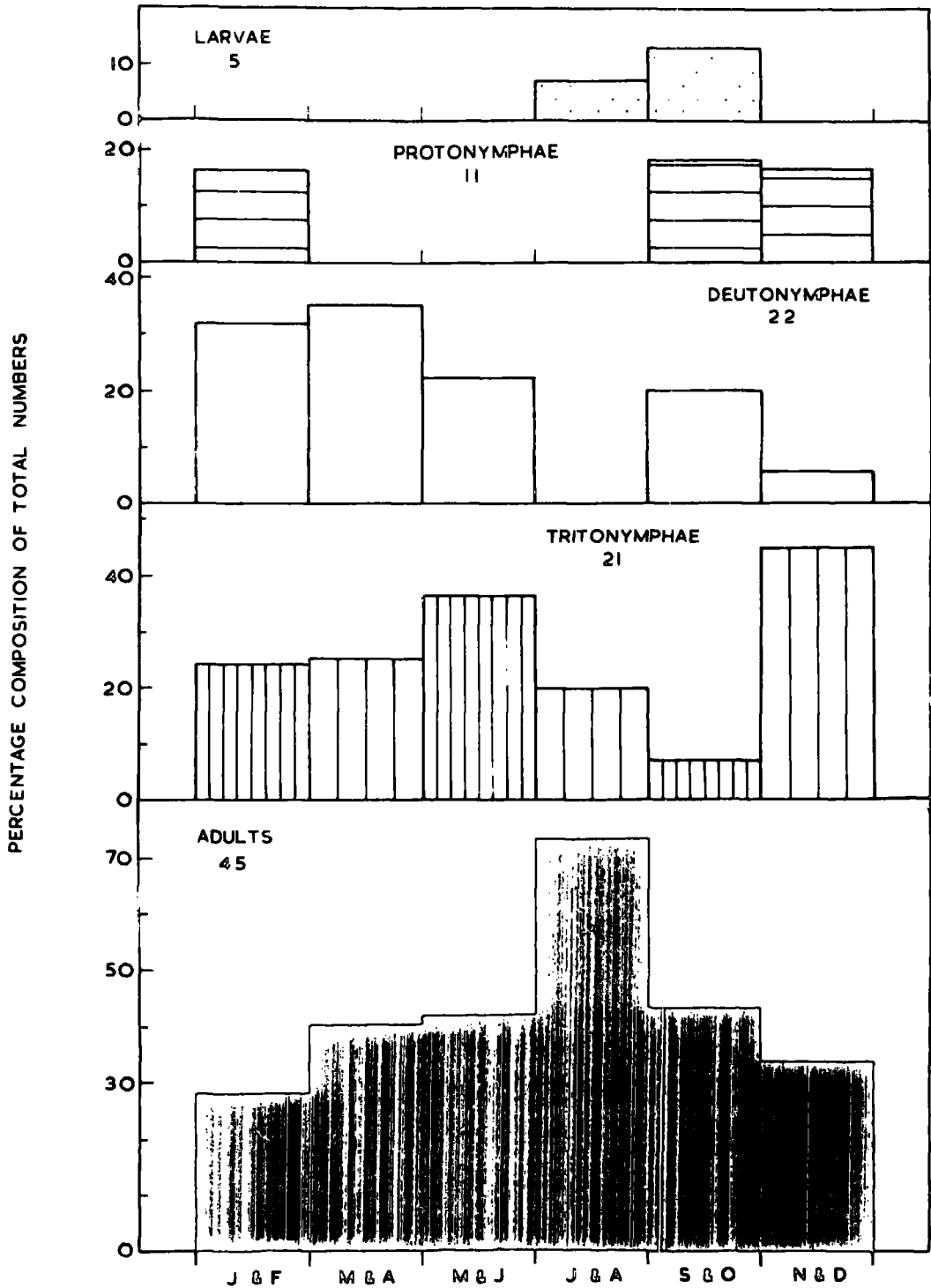

Table 41. Mean measurements in millimetres of all stages of Damaeus clavipes. The number of specimens measured of each stage is given in brackets below the name of the stage.

Character measured	Larva	Protonympha	Deutonympha	Tritonympha	Adult	
	(5)	(11)	(22)	(21)	Female (24)	Male (21)
Width of propodosoma	0.115 ±0.019	0.149 ±0.004	0.195 ±0.016	0.250 ±0.024	0.285 ±0.027	0.268 ±0.023
Dyar's factor		1.29	1.31	1.28	1.10	
Length of body	0.360 ±0.057	0.465 ±0.031	0.676 ±0.039	0.839 ±0.092	1.067 ±0.033	0.958 ±0.044
Dyar's factor		1.29	1.45	1.24	1.20	
Length of first tarsus	0.163 ±0.031	0.240 ±0.017	0.271 ±0.029	0.323 ±0.040	0.345 ±0.028	0.330 ±0.009
Dyar's factor		1.47	1.13	1.19	1.04	
Length of anal plate	0.637 ±0.059	0.808 ±0.088	1.254 ±0.076	1.609 ±0.133	1.851 ±0.106	1.663 ±0.177
Dyar's factor		1.27	1.55	1.28	1.09	
Length of genital plate	Genital plate absent	0.576 ±0.045	0.871 ±0.066	1.166 ±0.101	1.929 ±0.113	1.653 ±0.106
Dyar's factor			1.51	1.34	1.53	

tritonymphae maturing to the adult stage at this time.

D. clavipes overwintered in all stages except the larva and commonly in the tritonymphal stage, and had a single generation per year at Moor House.

From Fig. 24, the larval stage of D. clavipes was estimated to be one month in duration, the protonymphal stage to be five months, the deutonymphal stage to be two months, and the tritonymphal stage to be two months in length. The postembryonic development from the hatching of the egg to the emergence of the adult was 11-12 months for this species under field conditions. Pauly (1956) has observed the development period for the same species in culture at 25°C and 95 per cent relative humidity to be 75 days. Sengbusch (1958) has observed that the postembryonic development period is extended by lowering the temperature in Galumna nervosus. This worker recorded that this period was extended from 43 days at 25°C and 95 per cent relative humidity, to 63 days at 20°C and a relative humidity of 95 per cent (a drop of 1°C in temperature lengthened the development by four days). Similarly, Woodring and Cook (1962) have recorded a lengthening of the developmental period in Ceratozetes cisalpinus from 32 days at 25°C and 95 per cent relative humidity to 70 days at 5°C and 95 per cent relative humidity (: a drop of 1°C lengthened the development by 2 days).

In both the species studied in detail in the present work, the protonymphal stage had the longest duration, and the highest Dyar's increment factor was calculated for the moult from proto- to deuto-nymphal stage.

Eggs were observed in adult females of D. clavipes using normal clearing methods, and the data are given in Table 42. It can be seen that the percentage of females recorded carrying newly fully developed eggs was highest during July, September, October and December, thereby confirming that egg laying took place in autumn in this species. The mean number of eggs recorded in each adult female during the year of study was eight. Pauly (1956) has calculated that a single female of this species laid 70 eggs.

These life cycles show that the duration of the post-embryonic development of Acarina is much longer in species which are subject to a severe subarctic climate, than in species which experience a milder climate in lowland habitats. A single generation annually is common amongst species of the Cryptostigmata at Moor House. Since adults of nearly all species were found in every month of the year, it seems likely that the duration of adult life must be about a year or more, rather than a few weeks.

Table 42. Percentage of adult females of Damaeus clavipes with eggs during 1961. The data are grouped on a bimonthly basis. The number of eggs per female is also given.

Date	Number of adult females recorded	Percentage of females with eggs	Mean number of eggs per female
16. 1.61)	4	50	4
13. 2.61)			
13. 3.61)	6	67	7
26. 4.61)			
29. 5.61)	7	71	9
5. 6.61)			
18. 7.61)	5	60	9
28. 8.61)			
25. 9.61)	4	100	8
23.10.61)			
24.11.61)	4	100	9
11.12.61)			

XIII DISCUSSION

In discussing the present study in relation to a wider field of knowledge, the review will be in terms of the population dynamics of soil Acarina and the role of Acarina in moorland soils.

The population dynamics of soil Acarina

Much has been written of the significance of seasonal fluctuations in the abundance of soil micro-arthropods. Most workers assume that climatic factors are mainly responsible for changes in population density by affecting the birth rate or mortality. The importance of soil moisture has been demonstrated by Ford (1938) for Acarina, Glasgow (1939) for Collembola, and Weis-Fogh (1948) for both mites and Collembola. The fauna is said to owe its summer minimum to drought, and the winter minimum, when it occurs, to low temperatures or excessive moisture. The autumn or winter maxima of density are attributed to ideal moisture conditions.

The peak populations of Acarina on the Moor House sites in 1961 occurred one month previous to the driest soil conditions, which were in June. The minimum, therefore, did not occur at the time of driest soil conditions, but in August and September, when the soil water content of the sites was similar to the rest of the year. It is unlikely that the August -September minimum was the delayed result

of the relative drought in June. From the study of the distribution of the Acarina on an area of eroding moor at Moss Flats, it has been found that soil moisture alone does not markedly affect the abundance and distribution of the fauna studied.

It has been shown that there is very little evidence of seasonal vertical movement of mites in the soil types studied. Only on extremely rare occasions does the peat dry out (the last occasion was in the summer of 1955), and desiccation is obviously a less important risk under these conditions than at a lower altitude and in places with lower rainfall and higher temperatures. The data collected suggest that the relatively small changes in water content, and presumably even smaller changes in the relative humidity of the soil spaces, are insufficient to cause the mites to move from their preferred vertical range. Other workers (Strenzke, 1951 and Macfadyen, 1952) studying mites in dryer soils have reported seasonal vertical migrations but in the present study, only one species, Rhodacarus roseus, showed marked movements. This species tended to be distributed deep in the soil, and it is unlikely that this vertical migration was caused by the climatic conditions since it moved towards the surface at the time of year when these are driest and warmest. Under these conditions it would be expected to find a downward

movement. The study of the biology of this species would repay further study.

Both Riha (1951) and Sheals (1957) have suggested that certain species of Acarina migrate from the soil and litter onto the herbage at certain times of the year. This could give the erroneous impression from soil samples that the population was at a minimum at this time. No evidence of this type of movement was found at Moor House, although the vegetation was sampled on several occasions for evidence of this. Thus it can be confidently assumed that the August population minima which occurred on mixed moor (with rank cover of Calluna vulgaris) and on the Limestone grassland (with closely cropped grass, which gave the mites little chance of vertical movement) were real.

On the other hand, temperature would appear to be of considerable importance in influencing the seasonal abundance of Acarina, and this becomes more important in colder climates. It would appear likely that temperature restricts the breeding season of adult mites. It certainly limits the development period of the eggs and therefore the recruitment to the populations studied. The hatching of eggs which have overwintered is certainly an important factor in producing the spring peak of density, and this is confirmed by the increase in the juvenile : adult ratio of Cryptostigmata at this period. The rapid increase in

temperature in the late spring must result in an almost simultaneous hatching of eggs which were layed in the previous autumn.

The second peak of hatching (and of overall abundance) in the autumn is less easily explained. Clearly it cannot be the result of the water conditions in the soil as has been suggested by other authors, but it could be the result of mites which have matured in the spring laying eggs which hatch in the autumn. For such an explanation, it is necessary to have two main periods of egg hatching; in the late spring and the autumn. This could result from there being two main types of life cycle in the Acarina of the soil, namely those which lay eggs in the autumn and hatch in the spring, and those which lay eggs in the spring and hatch in the autumn. These probably represent different species, although at lower altitudes, where more species may have two generations a year, they would represent a bivoltine annual cycle. From the life histories of the species studied, it is clear that this is somewhat an oversimplification, but nevertheless it is clear that Platynothus peltifer contributes to a spring hatch while the eggs of Damaeus clavipes hatch in the autumn.

Under more extreme climatic conditions than at Moor House, such as in the arctic, the season of activity for the Acarina is so reduced that there is not time during the year

for more than one short period of reproduction. Under these conditions, hatching must occur in the summer and so this is the main, if not the only time of the year when recruitment can occur. Consequently, only a single peak of abundance can occur under these conditions and this has been demonstrated by Hammer (1944) for the mites of Greenland and by Stockli (1957) for alpine populations.

Obviously other factors influence the abundance of Acarina. Predation by other organisms such as small spiders, staphylinid beetles, Pseudoscorpionidae and species of the Mesostigmata will affect the density of cryptostigmatid soil mites according to Kuhnelt (1961). As these groups occur in low densities on the areas studied, mortality of the Cryptostigmata due to predation by these organisms is probably not high. It is suggested that the overwintering mortality during the three month period for Acarina was due mainly to the combined effects of excessive soil moisture and low temperatures, since predators cannot be very active under these conditions.

An alternative factor, namely the abundance of available food to the soil fauna, has been suggested by Waksman (1931) and Weis-Fogh (1948). Macfadyen (1952) has suggested that a rise in the micro-arthropod population at a time when macroscopic plant material becomes available to it would be expected. Several points arise from these suggestions.

Firstly, on the upland soils studied, the decaying plant material does not become available for incorporation into the soil in definite seasonal amounts. Secondly, few species of Acarina feed directly on the tissues of higher plants (Wallwork, 1958; and Hartenstein, 1962 g). The majority of the Cryptostigmata appear to eat fungi, which attack the decaying plant tissues (Forsslund, 1939, 1945; Evans, 1951). The fungal attack itself appears to be partly dependent on a preliminary mechanical mixing of the plant matter with soil by animals such as earthworms. Thirdly, the length of a generation in species of Cryptostigmata under moorland conditions is at least 9-12 months, and violent fluctuations in density owing to food supply alone are not to be expected.

A comparable situation to the fauna of blanket bog is shown by the fauna of beech forest litter (van der Drift, 1950). In both cases, there is an abundance of litter throughout the year, but the food supply to the animals may be limited by the low rate of fungal and bacterial activity. Food would appear to be a limiting factor for predatory species of the Parasitidae. It has been shown that high densities of this group occur in autumn at Moor House, when large populations of potential prey in the form of juvenile Oribatei and Collembola are present.

There remain the factors of the soil environment to

discuss. In Dhillon and Gibson's (1962) work on the Acarina of agricultural soils, apart from a positive correlation between the monthly density of the Parasitidae and the mean soil temperature at a depth of two inches for the preceding month, the variations in several factors, e.g. pH, organic content, and soil moisture, did not provide an explanation of the observed population changes. This agrees with Stockli (1957), who found that although high summer temperatures were favourable to micro-arthropods, neither moisture, humus level, nor pH appeared to influence the density of the populations.

From the foregoing, it can be seen that a complex of factors can influence the seasonal abundance of soil Acarina, but in moorland habitats temperature exerts the greatest affect by acting on the populations through the reproductive cycle of the mites. It would appear possible to explain both the bimodal and unimodal distribution of mite numbers in the soil fauna on the basis of their life cycles. This explanation has not been previously advanced.

The role of Acarina in moorland soils

If density in conjunction with live-weight biomass can be taken as one of the major indications of the biological activity of a group of organisms, then the following scheme of activity of the Acarina can be advanced for the areas investigated at Moor House :-

	<u>Nardus stricta</u> grassland	Mixed <u>Calluna</u> moor	Limestone grassland	<u>Juncus squarrosus</u> moor	Erosion area	Bare peat
BIOMASS:	1.85	1.11	0.98	0.91	0.74	Negligible
DENSITY:	77.83	53.82	42.01	43.01	44.69	Negligible

This scheme contrasts with that proposed by Cragg (1961) for the overall biological activity of the series of moorland types represented at Moor House, and given as :-

Limestone grassland > Nardus stricta grassland > Juncus squarrosus moor > Mixed Calluna moor > Bare peat

The higher density of Acarina on the Nardus grassland, due to the deep litter layer available for colonisation by the organisms, and a suitable microclimate in which to live, causes a greater live-weight biomass to occur on this site. On a biomass and density basis, there is little difference between mixed moor, Limestone grassland, and the Juncus squarrosus moor for the Acarina. The figures for biomass and density of mites on the eroding moor are mean values for a complex series of habitats, and as such should be viewed with caution in comparisons of this kind. In terms of biological activity, therefore, the Acarina differ from the general picture of the total fauna in the soils investigated.

Table 43 shows the densities and live-weight biomasses of the common groups of soil organisms, which have been studied on the Moor House Reserve (from Cragg, 1961).

Table 43. Densities and live-weight biomasses (g. per metre²) of soil organisms at Moor House (after Cragg, 1961). Where the biomass is known it is given in brackets below the density. In the calculation of the total biomass for the mixed Calluna moor, an allowance has been made for the biomass of Enchytraeidae.

Note: - indicates that no data are available.

Animal group	<u>Nardus stricta</u> grassland	Mixed <u>Calluna</u> moor	Limestone grassland	<u>Juncus squarrosus</u> moor	Bare peat
Acarina x10 ³	78 (1.85)	54 (1.11)	37 (0.98)	43 (0.91)	Negligible
Collembola x10 ³	-	32	56 (0.4)	13 (0.1)	Negligible
Enchytraeidae x10 ³	118 (35)	-	17 (15)	210 (53)	31 (10)
Nematoda x10 ⁶	3.3	1.4	2.3	3.9 (1.0)	0.02
Lumbricidae	Negligible	0.2	389 (135)	-	Nil
Tipulidae larvae	-	371 (8)	49 (36)	1389 (22)	Negligible
Total animal density x10 ³	3476	1466	2410	4167	53
Total biomass	36.8	9.1	187.4	77.0	10.0
Percentage contribution of Acarina to total biomass	5.0	2.1	0.5	1.2	0.0

Although the biomass data are not complete for all groups, the provisional figures show that the Acarina comprise five per cent of the known live-weight total biomass of the soil fauna of the Nardus stricta grassland site. This is the highest estimated proportion of the total biomass achieved by soil mites on the sites investigated. Two per cent of the total biomass on mixed moor is composed of mites. Thus the contribution of the Acarina to the total biomass of the soil fauna of the Moor House sites is small, not exceeding five per cent. This estimated value is similar to that given by Bornebusch (1930) for the combined biomass of mites and Collembola in beech and spruce mor (six per cent each site), and greater than that estimated by Macfadyen (1963) for a lowland grassland (1.6 per cent). The biomass of mites on moorlands was always greater than that estimated for Collembola on the same area (Hale, 1962).

Apart from their metabolic activities during life, the Acarina contribute to the general soil turnover on dying, and the breakdown of the body by micro-organisms. The annual contribution of Acarina to upland soils in this way is much smaller than that to lowland soils, due to the fewer generations per year and the lower metabolic rate on moorland areas.

The validity and importance of metabolic measurements in the field of ecology has been stressed by Macfadyen

(1961 and 1962). It has been found that the Oribatei take second place to the Collembola in most soils investigated due to their low metabolic rates (Macfadyen, 1963), and in a series of lowland soil habitats, the Oribatei contributed 2-18 per cent of the total metabolism of the small decomposers group. The Collembola were estimated to contribute between 34-75 per cent of the same total metabolism. For the upland sites at Moor House, it has been estimated that the Oribatei contribute 4-8 per cent and the Collembola 14 per cent of the total metabolism of the small decomposers.

It is suggested from the contribution of the Acarina to the total biomass of soil fauna, and from a comparison of the estimated contribution of the group to the total metabolism of the moorland sites studied, that the mites make a much smaller contribution to the soil turnover than their numerical abundance suggest. The role of Acarina in moorland soils should not be examined only within the framework of their density and biomass, but on the activity of the group in the soil and litter.

Murphy (1955) has suggested that the role played by mites in the comminution of decaying leaf tissue is an important one; and Jacot (1939) recorded the juveniles of the Phthiracaridae burrowing in conifer needles, and Riha (1951) has shown that some Oribatei feed on decaying wood. The excrement of mites provide a further substrate for decomposition by fungi and coprogenous organisms, and

Schuster (1956) has drawn attention to this aspect of soil formation by mites. On peat soils, the relative importance of the Acarina is increased by the absence of earthworms and millipedes, and so their role may be greater. It has been observed in this study that Acarina remain active at low temperatures, and the group may, in this way, contribute more to the soil turnover by being active at temperatures below which much other biological activity has ceased in the soil.

It is possible that certain species of mites, which may be numerically sparse in the soil populations, are vital links in the complex chain of energy transfer within the soil community. The absence of such species may cause a bottleneck in the pattern of energy flow by preventing food from becoming available for other organisms to act upon, or by not catalysing important biochemical changes. The elucidation of the exact roles of specific mites in the soil turnover is one of the important future problems.

SUMMARY

1. A study of the soil inhabiting Acarina or mites of the Moor House National Nature Reserve, Westmorland is described, with special reference to the mineral soil of the Limestone grassland, and the peat soil of the mixed moor areas. The Reserve has a sub-arctic climate.
2. A provisional list of 78 species of Acarina is given.
3. A modified Macfadyen high gradient apparatus was used to extract the animals from soil cores, and densities of 13,150 to 141,020 thousands per square metre were found.
4. The temperature gradients developed during extraction have been measured: the final gradient after 3 days being 67-78 Centigrade degrees in a 3 cm. core.
5. The efficiency of the extractor for soil mites is 76 per cent and the extraction pattern of Acarina has been compared with that of Collembola.
6. A comparison of the high gradient apparatus with a flotation extractor shows the former to be 34 per cent more efficient for peat soils, and 50 per cent more efficient for mineral soils.
7. Aggregation of Acarina in the soil have been demonstrated using the coefficient of dispersion, and the non-normal distribution of the sample unit values. The biological significance of aggregation is discussed.

8. The vertical distribution of Acarina has been considered with respect to 0-3 cm. and 3-6 cm. soil layers in mineral and peat soils. The majority of the Acarina were recorded in the 0-3 cm. layer. The data suggest a vertical migration of Rhodacarus roseus, from the lower layer to the surface of the soil in summer.
9. Spring and autumn peaks of abundance of total Acarina are shown, and the pattern is modified by the late spring of 1962.
10. Individual common species show a single peak of density annually, corresponding to a single generation. Exceptions to this are Carabodes minusculus and species of the Oppia-Suctobelba group, which show two annual peaks corresponding to two generations.
11. Overwintering mortality during a three month period is estimated to be 20-23 per cent for total Acarina. The highest overwintering mortality (85 per cent) is estimated for Olodiscus minima in the mineral soil.
12. In considering the Acarina of eroding moor, it is suggested that the distribution is not governed directly by the soil water content of the habitats, but by changes in plant cover in the cycle of erosion and recolonisation.
13. Qualitative and quantitative differences between the fauna of Limestone grassland, mixed Calluna moor, Juncus squarrosus moor and Nardus stricta grassland, are considered. The species composition of the sites is similar. The density of total

Acarina was shown to increase significantly from 1961 to 1962 on Limestone grassland and mixed moor. A significant difference in the density of total Acarina occurs between the four sites; the Nardus stricta grassland has the highest mean annual density (77.83 thousands per square metre), and Limestone grassland the lowest (28.74 thousands per square metre).

14. Greatest similarity of the Moor House mite fauna exists with that of north Finland and Iceland. The density of the fauna at Moor House is lower than that of similar British lowland areas.
15. The biomass of Acarina is estimated for the moorland sites, and ranged from 0.89 (Limestone grassland) to 1.85 (Nardus stricta grassland) grammes per square metre. The seasonal changes in biomass are shown.
16. Detailed investigations of the juvenile stages of Platynothrus peltifer show it to have a single generation per year, breeding in the spring and autumn, whilst Damaeus clavipes breeds only in the autumn.
17. The population dynamics of soil Acarina, and their role in moorland soils is discussed. Temperature has the greatest affect on the seasonal abundance of soil Acarina, by influencing the reproductive cycle. From an examination of the contribution of the Acarina to the total biomass and metabolism of moorland soils, it is concluded that the mites

make a smaller contribution to the soil turnover than their numerical abundance suggest.

BIBLIOGRAPHY

- Baker, E. W. & Wharton, G. W. 1952. An introduction to Acarology.
Macmillan : New York.
- Baker, E. W. et al. 1958. Guide to the families of mites.
Institute of Acarology, Maryland.
- Balogh, J. 1958. Lebensgemeinschaften der Landtiere. Ihre
Erforschung unter besonderer Berücksichtigung der zoozoologischen
Arbeitsmethoden. Budapest : Verlag der Ungarischen
Akademie der Wissenschaften.
- Balogh, J. 1961. Identification keys of world Oribatid families
and genera. Acta Zool. Hung., VII (3-4) : 243-344.
- Balogh, J. 1963. Identification keys of Holarctic Oribatid mites
(Acari) families and genera. Acta Zool. Hung., IX (1-2) : 1-60.
- Banage, W. 1960. Studies on the Nematode Fauna of Moorland Soils.
Ph.D. Thesis, University of Durham.
- Bameja, K. D. 1959. Studies of the soil fauna with special
reference to the recolonisation of sterilised soil. J. Anim.
Ecol. 8 (1) : 120-161.
- Belfield, W. 1956. The Arthropoda of the soil in a west African
pasture. J. Anim. Ecol., 24 : 275-287.
- Berlese, A. 1906. Monographia del genere Gamasus Latreille.
Redia, 3 : 66-304.
- Berthet, P. 1958. The evaluation of the true weight of Oribatid
mites (Acarina). Proc. Coll. Rothamsted. Butterworths (in
press).

- Berthet, P. 1963. Mesure de la consommation d'oxygene des Oribatides (Acarieus) de la litiere des forets. In Soil Organisms (ed. by J. Doeksen and J. van der Drift) : 18-31. North-Holland, Amsterdam.
- Bliss, C. I. & Owen, A. R. G. 1958. Negative binomial distributions with a common k. Biometrika, 45 : 37-58.
- Bornebusch, C. H. 1930. The Fauna of Forest Soil. Copenhagen.
- Bower, M. M. 1959. A summary of Available Evidence and a further Investigation of the Causes, Methods and Results of Erosion in Blanket Peat. Ph.D. Thesis, University of London.
- Clapham, A. R. 1936. Over dispersion in grassland communities and the use of statistical methods in plant ecology. J. Ecol., 24 : 232-251.
- Clapham, A. R., Tutin, T. G. & Warburg, E. F. 1952. Flora of the British Isles. Cambridge.
- Conway, V. M. 1955. The Moor House National Nature Reserve, Westmorland. Handb. Soc. Prom. Nat. Res. 111 : 1-7.
- Conway, V. M. & Millar, A. 1960. The hydrology of some peat-covered catchments in the northern Pennines. J. Instn. Wat. Engrs., 14 : 415-424.
- Cragg, J. B. 1961. Some aspects of the ecology of moorland animals. J. Ecol., 49 : 477-506.
- Crump, F. B. 1913. The coefficient of humidity. New Phytol. 12 : 125-147.
- Dalenius, P. 1950. The Oribatid fauna of south Sweden with remarks concerning its ecology and zoogeography. K. Fysiogr. Sällsk. Lund. Förh. 20, (3) : 1-19.

- Dalenius, P. 1960. Studies on the Oribatei (Acari) of the Torneträsk Territory in Swedish Lapland. I. A List of the Habitats, and the Composition of Their Oribatid Fauna. *Oikos*, 11, (1) : 80-124.
- Dalenius, P. 1962. Studies on the Oribatei (Acari) of the Torneträsk territory in Swedish Lapland. III. The vertical distribution of the moss mites. *K. Fysiogr. Sällsk. Lund. Förh.* 32, (10) : 105-129.
- Dalenius, P. 1963. Studies on the Oribatei (Acari) of the Torneträsk territory in Swedish Lapland. IV. Aspects on the distribution of the moss-mites and the seasonal fluctuations of their populations. *K. Fysiogr. Sällsk. Lund. Förh.* 59 (2) : 3-33.
- Davis, B. N. K. 1963. A study of micro-arthropod communities in mineral soils near Corby, Northants. *J. Anim. Ecol.* 32, (1) : 49-71.
- Debauche, H. R. 1962. The structural analysis of animal communities of the soil. In, *Progress in Soil Zoology* (ed. by P. W. Murphy): 10-25. Butterworths, London.
- Deaney, M. J. 1956. The animal communities of three areas of pioneer heath in south-west England. *J. Anim. Ecol.* 25 (1) : 112-126.
- Dhillon, B. S. & Gibson, N. H. E. 1962. A study of the Acarina and Collembola of agricultural soils. *Pedobiologia* 1 : 189-209.

- Drift, van der J. 1950. Analysis of the animal community in a beech forest floor. Tijdschr. Ent. 94 : 1-168.
- Dufey, F. 1959. Recherches de Synécologie sur Trois Milieux Phytosociologiquement Définis. Mémoire présenté pour l'obtenir du grade de Licencié en Sciences Zoologiques, Université de Louvain. Belgique : 135.
- Dunham, K. C. 1948. Geology of northern Pennine orefields. Vol. I Tyne to Stainmore. Geol. Survey of Gt. Britain. H.M.S.O. London.
- Eddy, A. 1962. pers. comm.
- Edney, E. B. 1957. The water relations of terrestrial Arthropods. Cambridge Monogr. in Exp. Biol. No. 5. Cambridge.
- Edwards, C. A. T. 1955. Soil sampling for Symphylids and a note on populations. In, Soil Zoology (ed. by D. K. Mc. Kevan) : 152-156. Butterworths, London.
- Edwards, E. E. 1929. Survey of the insect and other invertebrate fauna of permanent pasture and arable land of certain soil types at Aberystwyth. Ann. app. Biol., 16 : 299-322.
- Elton, C. 1949. Population interspersions: an essay on animal community patterns. J. Ecol., 37 : 1-23.
- Elton, C. & Millar, R. 1954. The ecological survey of animal communities : with a practical system of classifying habitats by structural characters. J. Ecol., 42 : 460-496.
- Evans, G. O. 1950. Study of the soil fauna of a Sitka spruce (Picea sitchensis Trautu & Meyer) plantation at Amptill in Bedfordshire.

- Unpub. quoted in Terrestrial Acari of the British Isles. Brit. Mus. nat. Hist. London.
- Evans, G. O. 1951. Investigations on the fauna of forest humus layers. Forestry Commission on Forest Research for the year ending March 1950. London : 110-113.
- Evans, G. O. 1955. Identification of terrestrial mites. In, Soil Zoology. (ed. by D. K. Mc. Kevan) : 55-61. London.
- Evans, G. O. 1955. A revision of the family Epicriidae. (Acarina Mesostigmata.) Bull. Brit. Mus. (nat. Hist.) 3 (4) : 1-30.
- Evans, G. O. 1955. A revision of British mites of the genus Veigalia. Proc. zool. Soc. Lond., 125 : 569-586.
- Evans, G. O. 1957. An introduction to the Mesostigmata. J. Linn. Soc. (Zool.) 43 : 203-259.
- Evans, G. O. & Browning, E. 1955. Techniques for the preparation of mites for study. Ann. Mag. nat. Hist. (12), 8 : 631-635.
- Evans, G. O. & Browning, E. 1956. British mites of the subfamily Macrochelinae. Bull. Brit. Mus. (nat. Hist.) 4 (1) : 1-55.
- Evans, G. O. & Hyatt, K. H. 1960. A revision of the Platyseolinae (Mesostigmata-Aceosejidae). Bull. Brit. Mus. (nat. Hist.) 6 (2) : 27-101.
- Evans, G. O., Sheals, J. G. & Macfarlane, D. 1961. The terrestrial Acari of the British Isles. An introduction to their Morphology, Biology and Classification. Vol. I. Introduction and Biology. Brit. Mus. nat. Hist. London.
- Ford, J. 1955. The animal population of a meadow near Oxford. J. Anim. Ecol., 4 : 195-207.

- Ford, J. 1937. Fluctuations in natural populations of Collembola and Acarina. Part 1. J. Anim. Ecol. 6 : 98-111.
- Ford, J. 1938. Fluctuations in natural populations of Collembola and Acarina. Part 2. J. Anim. Ecol. 7 : 350-369.
- Forsslund, K. H. 1939. Bidrag till kännedomen om djurlivets i marken inverkan på markomvandlingen. 1. Om några hornvalsters (Oribatiders) näring. Medd. Skogsforsökanst. Stockh., 31 : 99-107.
- Forsslund, K. H. 1941. Schwedische Arten der Gattung Suctobelba Paoli (Acari, Oribatei.). Zool. Bidr. Uppsala, 20 : 381-396.
- Forsslund, K. H. 1943. Studier över det lägre djurlivet i nordsvensk skogsmark. (Studien über die Tierwelt des nordschwedischen Waldbodens.) Medd. Skogsforsökanst, Stockh., 34 (1) : 1-283.
- Forsslund, K. H. 1945. Sammanfattande översikt över vid markfaunaundersökningar i Västerbotten påträffade djurformer. Medd. Skogsforsökanst. Stockh., 34 (5) : 341-364.
- Franz, H. 1963. Biozonotische und synökologische Untersuchungen über die Bodenfauna und ihre Beziehungen zur Mikro und Makroflora. In, Soil Organisms (ed. by J. Doeksen and J. van der Drift) : 345-367. North-Holland, Amsterdam.
- Frenzel G. 1936. Untersuchungen über die Tierwelt des Wiesenbodens. Jena. Original not consulted. Reviewed by Ford, J. 1937, J. Anim. Ecol., 6 : 197-198.

- Gisin, H. 1943. Ökologie und Lebensgemeinschaften der Collembolen im Schweizerischen Exkursionsgebiet Basels. Rev. suisse Zool., 50 : 131-224.
- Glasgow, J. P. 1939. A population study of subterranean soil Collembola. J. Anim. Ecol., 8 : 323-353.
- Grandjean, F. 1935. Observations sur les Acariens (1^{ère} série) Bull. Mus. Hist. nat. Paris. (2) 7 : 119-126.
- Grandjean, F. 1947. Observations sur les Oribates, 18th series. Bull. Mus. Hist. nat. Paris. (2) : 19 : 395-402.
- Grandjean, F. 1949. Observations et conservation des très petit arthropodes. Bull. Mus. Hist. nat. Paris, (2) 21 : 563-570.
- Grandjean, F. 1950. Observations éthologiques sur Canisia segnis (Herm.) et Platynothrus peltifer (Koch). Bull. Mus. Hist. nat. Paris, 2 series 22 (2) : 224-231.
- Grandjean, F. 1950a. Observations sur les Oribates, 21 series. Bull. Mus. Hist. nat. Paris, 2 series, 22 : 344-351.
- Grandjean, F. 1950b. Formules anales, gastronomiques, genitales et aggenitales du développement numérique des poils chez les Oribates. Bull. Soc. zool. Fr. 74 (4-5) : 210-225.
- Grandjean, F. 1954. Etude sur les Palasacaroides (Acariens, Oribates). Mem. Mus. Hist. nat. Paris, 7A (3) : 179-274.
- Green, F. H. W. 1958. Climatological work in 'A report of the scientific work at Moor House National Nature Reserve'. The Nature Conservancy, London.
- Green, F. H. W. 1959. Some observations on potential evaporation, 1955-57. Quart. J. R. met. Soc. 85 : 152-158.

- Greig-Smith, P. 1952. The use of random and contiguous quadrats in the study of the structure of plant communities. *Ann. Bot., Lond.* 16 : 295-316.
- Haarlov, N. 1942. A morphologic-systematic-ecological investigation of Acarina, and other microfauna around Hørkefjord, N.E. Greenland. Dansk N. E. Greenland expedition 1938-39. *Medd. Grønland, BD.* 128, NR.1. Copenhagen.
- Haarlov, N. 1947. A new modification of the Tullgren apparatus. *J. Anim. Ecol.* 16. 2 : 115-121.
- Haarlov, N. 1952. Systematics and ecology of the genus: Tectocepheus Berlese 1896. (Acarina). *Ent. Medd.,* 26 : 424-437.
- Haarlov, N. 1955. Vertical distribution of Mites and Collembola in relation to soil structure. In, *Soil Zoology* (ed. by D. K. Mc. Kevan) : 167-178. London.
- Haarlov, N. 1955. A modified Tullgren apparatus. In, *Soil Zoology* (ed. by D. K. Mc. Kevan) : 333-337. Butterworths, London.
- Haarlov, N. 1957. Microarthropods from Danish soils. Systematics. *Spolia zool. Mus. Hauniensis.* 17 : 1-60.
- Haarlov, N. 1960. Micro-arthropods from Danish soils. Ecology, Phenology. *Oikos, supplementum* 3 : 1-176.
- Hale, W. G. 1962. Studies on the biology of moorland Collembola. Ph. D. Thesis. University of Durham.
- Hale, W. G. 1963. The Collembola of eroding blanket bog. In, *Soil Organisms* (ed. by J. Doeksen and J. van der Brift) : 406-413. North-Holland, Amsterdam.

- Hammen, van der L. 1952. The Oribatei (Acari) of the Netherlands. Zool. Verh., Leiden. 17 : 1-139.
- Hammen, van der L., & Strenzke, K. 1953. A partial revision of the genus Metabelba Grandjean (Oribatei, Acari). Zool. Meded., 32 : 141-154.
- Hammer, M. 1944. Studies on the Oribatids and Collemboles of Greenland. Medd. Grønland BD.141, Nr. 3 : 1-210.
- Hammer, M. 1946. Oribatids in : The zoology of east Greenland. Medd. Grønland, BD.122 NR. 1 : 1-39.
- Harding, J. P. 1949. The use of probability paper for the graphical analysis of polymodal frequency distributions. J. Mar. biol. Ass. U.K. 28 : 141-153.
- Harding, J. & Washtell, C. C. H. 1950. The Labgear-Harding micro-dissector. J. Quekett micr. Cl. (4) 3 : 89-92.
- Hartenstein, R. 1961. On the distribution of forest soil micro-arthropods and their fit to 'Contagious' distributions functions. Ecology, 42 (1) : 190-194.
- Hartenstein, R. 1962a. Soil Oribatei. II. Belba kingi, (Acarina: Belbidae), and a Study of its Life History. Ann. ent. Soc. Amer., 55 (4) : 357-361.
- Hartenstein, R. 1962b. Soil Oribatei. III. Studies on the development, Biology and Ecology of Metabelba montana (Kulcz.) (Acarina: Belbidae) and Eremobelba nervosa n.sp. (Acarina: Eremaeidae). Ann. ent. Soc. Amer., 55 (4) : 361-367.

- Hartenstein, R. 1962c. Soil Oribatei IV. Observations on Ceratozetes gracilis (Acarina: Ceratozetidae). Ann. ent. Soc. Amer., 55 (5) : 583-586.
- Hartenstein, R. 1962d. Soil Oribatei. V. Investigations on Platynothrus peltifer (Acarina: Camisiidae). Ann. ent. Soc. Amer., 55 (6) : 709-713.
- Hartenstein, R. 1962e. Soil Oribatei VI. Protoribates lophotrichus (Acarina: Haplozetidae) and its Associations with Microorganisms. Ann. ent. Soc. Amer., 55 (5) : 587-591.
- Hartenstein, R. 1962f. Soil Oribatei VII. Decomposition of Conifer Needles and Deciduous Leaf Petioles by Steganacarus diaphanum (Acarina: Phthiracaridae). Ann. ent. Soc. Amer., 55 (6) : 713-716.
- Hartenstein, R. 1962g. Soil Oribatei. 1. Feeding specificity among forest soil Oribatei. Ann. ent. Soc. Amer., 55, (2) : 202-206.
- Hartenstein, R. 1962h. Life History Studies of Pergamasus crassipes and Amblygamasus septentrionalis (Acarina: Parasitidae) Ann. ent. Soc. Amer., 55 (2) : 196-202.
- Hughes, A. M. 1961. The mites of stored food. London.
- Hughes, R. D. 1962. The study of aggregated populations. In, Progress in Soil Zoology (ed. by P. W. Murphy) : 51-53. Butterworths, London.
- Hughes, T. E. 1959. Mites of the Acari. University of London. Athlone Press.

- Hull, J. E. 1914. Oribatidae (Beetle Mites) of the County of Durham, with special reference to the Derwent Valley. Trans. Vale Derwent Nat. F. Cl., 1 : 59-65.
- Hull, J. E. 1909. Terrestrial Acari of the Tyne province. Trans. nat. Hist. Soc. Northumb., 4 : 381-409.
- Hull, J. E. 1918. Terrestrial Acari of the Tyne province. Trans. nat. Hist. Soc. Northumb., 5 : 13-88.
- Hull, J. E. 1925. Acari of the family Gamasidae: new and rare British species. Ann. Mag. nat. Hist. (9) 15 : 201-219.
- Ionescu, M. A. 1932. Contributiuni la studiul faunei frunzarului (patura de frunze moarte) de fag. Cercetari statistice, ecologice si sistematice in padurile de fag de la Sinaia si de pa valea. Prahovei. Bucharest.
- Jacot, A. P. 1934. Some Hawaiian Oribatoidea (Acarina). Bull. Bishop Mus., Honolulu, 121 : 1-99.
- Jacot, A. P. 1936. Soil structure and soil biology. Ecology, 17 : 359-379.
- Jacot, A. P. 1939. Reduction of spruce and fir litter by minute animals. J. For., 37 : 858-860.
- Johnson, G. A. L. & Durham, K. C. 1963. The geology of Moor House. Monograph of the Nature Conservancy, No. 2. H.M.S.O. London.
- Karg, von Wolfgang. 1961. Okologische untersuchungen von edaphischen Gamasiden (Acarina, Parasitiformes) Part I. Pedobiologia, 1 : 53-74.

- Karg, von Wolfgang. 1961. Ökologische untersuchungen von edaphischen Gamasiden (Acarina, Parasitiformes) Part 2. *Pedobiologia*, 1 : 77-98.
- Karppinen, E. 1958. Untersuchungen über die Oribatiden (Acar.) der Waldböden von *Hylocomium-Myrtillus*-Typ in Nordfinnland. *Ann. ent. fenn.* 24 (4) : 149-168.
- Karppinen, E. 1958. Über die Oribatiden (Acar.) der Finnischen waldböden. *Ann. Zool. Soc. 'Vanamo'*, 19 (1) : 1-43.
- Karppinen, E. 1962. Zur Kenntnis der Oribatidenfauna Nordfinnlands. *Arch. Soc. 'Vanamo'*, 16 (1) : 36-48.
- Kevan D. K. Mc. 1955. Identification of Soil and Litter inhabiting Animals. In, *Soil Zoology* (ed. by D. K. Mc. Kevan) : 23-28. Butterworths, London.
- Kevan, D. K. Mc. 1962. *Soil Animals*. Witherby, London.
- Klima, J. 1956. Struktunklassen und lebensformen der Oribatiden (Acari). *Oikos* 7 : 227-242.
- Klima, J. 1959. Die Zönosen in der Umgebung von Innsbruck. *De Natura Tirolense*, 197-208.
- Kuhnelt, W. 1955. An introduction to the study of soil animals. In, *Soil Zoology* (ed. by D. K. Mc. Kevan) : 3-22. Butterworths, London.
- Kuhnelt, W. 1961. *Soil Biology: with special reference to the animal kingdom*. Faber & Faber, London.
- Kulczynski, V. 1902. Species Oribatinarum (Oudms.) (Damaeinarum Michael) in Galicia collectae. *Bull. Acad. Sci. Cracovie, Classes Math. et Nat.* 2 : 89-96.

- Kunst, V. H. M. 1960. Über einige bodenmilbengruppen aus dem moorgebiet 'soos' in Böhmen (Acari: Gamasina, zerconina, oribatei.). Acta Univ. Carolinae-Biologica-Supplementum 1960 : 11-58.
- Laddell, W. R. S. 1936. A new apparatus for separating insects and other arthropods from the soil. Ann. appl. Biol., 23 : 862-879.
- Leitner, E. 1949. Zur Kenntnis der Gattung Digamasellus Berl. 1905. Zbl. Gesamt. Geb. Ent. (Lienz) 3 : 51-62.
- Lewis, F. J. 1904. Geographical distribution of the vegetation of the basins of the Rivers Eden, Tees, Wear, and Tyne. Geogr. J. 25 : 313-331, & 24 : 267-284.
- Macfadyen, A. 1952. The small arthropods of a Molinia fen at Cothill. J. Anim. Ecol., 21 : 87-117.
- Macfadyen, A. 1953. Notes on methods for the extraction of small soil arthropods. J. Anim. Ecol., 22 : 65-77.
- Macfadyen, A. 1955. A comparison of methods for extracting soil arthropods. In, Soil Zoology (ed. by D. K. M. Kevan) : 315 - 332. London.
- Macfadyen, A. 1957. Animal Ecology: Aims and Methods. London.
- Macfadyen, A. 1961. Metabolism of soil invertebrates in relation to soil fertility. Ann. appl. Biol., 49 : 215-218.
- Macfadyen, A. 1961. Improved funnel-type extractor for soil arthropods. J. Anim. Ecol., 30 : 171-184.
- Macfadyen, A. 1961. Energy flow in ecosystems and its exploitation by grazing. In, Crisp D. J. British Ecological Society Symposium on Grazing. Oxford.

- Macfadyen, A. 1962. Control of humidity in three funnel-type extractors for soil arthropods. In, *Progress in Soil Zoology* (ed. by P. W. Murphy) : 158-168. Butterworths, London.
- Macfadyen, A. 1962. Soil Arthropod Sampling. In, *Advances in Ecological Research*, (ed. by J. B. Cragg) : 1-31. Academic Press, London.
- Macfadyen, A. 1963. The contribution of the microfauna to total soil metabolism. In, *Soil Zoology* (ed. by J. Doeksen and J. van der Drift) : 3-17. North-Holland, Amsterdam.
- Manley, G. 1936. The climate of the N. Pennines: the coldest part of England. *Quart. J. R. met. Soc.*, 62 : 103-115.
- Manley, G. 1942. Meteorological observations on Dun Fell, a mountain station in northern England. *Quart. J. R. met. Soc.*, 68 : 151-162.
- Manley, G. 1943. Further climatological averages for the northern Pennines, with a note on topographical effects. *Quart. J. R. met. Soc.*, 69 : 251-261.
- Manley, G. 1952. *Climate and the British scene*. Collins, London.
- Michael, A. D. 1883. *British Oribatidae, I*. 1887. *British Oribatidae, II*. Ray Society, London.
- Morris, H. M. 1922. On a method of separating insects and other arthropods from the soil. *Bull. ent. Res.*, 13 : 197-200.
- Murphy, D. H. 1955. Long-term changes in Collembolan populations with special reference to moorland soils. In, *Soil Zoology* (ed. by D. K. Mc. Kevan) : 157-166. Butterworths, London.

- Murphy, P. W. 1953. The biology of forest soils with special reference to the mesofauna or meiofauna. *J. Soil Sci.*, 4 : 155-193.
- Murphy, P. W. 1955. Ecology of the fauna of forest soils. In *Soil Zoology* (ed. by D. K. Mc. Kevan) : 99-124. Butterworths, London.
- Murphy, P. W. 1962. Extraction methods for soil animals. I.. Dynamic methods with particular reference to funnel processes. In *Progress in Soil Zoology* (ed. by P. W. Murphy) : 75-114. Butterworths, London.
- Murphy, P. W. 1962. Extraction methods for soil animals. II. Mechanical methods. In, *Progress in Soil Zoology* (ed. by P. W. Murphy) : 115-155. Butterworths, London.
- Murphy, P. W. 1962. Effect of sample treatment on extraction efficiency with the split-funnel extractor. In, *Progress in Soil Zoology* (ed. by P. W. Murphy) : 182-188. Butterworths, London.
- Nef, L. 1957. Etat actuel des connaissances sur le role des animaux dans la decomposition des litières de forets. *Agricultura* (2) 5 : 245-316.
- Nef, L. 1962. The distribution of Acarina in the soil. In, *Progress in Soil Zoology* (ed. by P. W. Murphy) : 56-58. Butterworths, London.
- Nef, L. 1962. The roles of desiccation and temperature in the Tullgren-funnel method of extraction. In, *Progress in Soil Zoology* (ed. by P. W. Murphy) : 169-173. Butterworths, London.

- Nicholson, E. M. 1957. Britain's Nature Reserves. H.M.S.O. London.
- Nielsen, C. O. 1954. Studies on Enchytraeidae. 3. The micro-distribution of Enchytraeidae. *Oikos*, 5 : 167-178.
- Noordam, D. ,&Vlieger, S. H.,% Vaart van der de. 1945. Een onderzoek naar samenstelling en beteekenis van de fauna van eikenstooisel. *Ned. Boschbtijdschr.*, 16 : 470.
- O'Connor, F. B. 1957. An ecological study of the enchytraeid worm populations of a coniferous forest soil. *Oikos*, 8 : 162-199.
- Oswald, H. 1949. Notes on the vegetation of British and Irish mosses. *Acta phytogeogr. suec.*, 26 : 1-62.
- Oudemans, A. C. 1902. New list of Dutch Acari. Second part. With remarks on known and descriptions of a new sub-family, new genera and species. *Tijdschr. Ent.*, 45 : 1-52.
- Overgaard, C. 1948. Studies on the soil microfauna. I. The moss inhabiting nematodes and rotifers. *Naturvidensk. Skr.* 1 : 1-98.
- Pauly, F. 1956. Zur Biologie einiger Belbiden und zur Funktion ihrer Pseudostigmatischen Organe. *Zool. Jb. Abt. Syst.*, 84 : 275-328.
- Peachey, J. E. 1963. Studies on the Enchytraeidae (Oligochaeta) of moorland soils. *Pedobiologia* 2 : 81-95.
- Pearsall, W. H. 1950. Mountains and Moorlands. *New Naturalist Monograph*. Collins, London.
- Poole, T. B. 1961. An ecological study of the Collembola in a coniferous forest soil. *Pedobiologia*, 1 : 113-137.

- Quenouille, M. H. 1950. Introductory statistics. Butterworth-Springer Ltd., London.
- Raw, F. 1955. A flotation extraction process for soil microarthropods. In, Soil Zoology (ed. by D. K. Mc Kevan) : 341-346. Butterworths, London.
- Raw, F. 1956. The abundance and distribution of Protura in grassland. J. Anim. Ecol., 25 (1) : 15-21.
- Raw, F. 1962. Flotation Methods for Extracting Soil Arthropods. In, Progress in Soil Zoology (ed. by P. W. Murphy) : 199-201. Butterworths, London.
- Riha, G. 1951. Zur ["]Ökologie der Oribatiden in Kalksteinböden. Zool. Jb. (Abt. Syst.) 80 : 407-450.
- Russell, E. J. 1957. The World of the Soil. New Naturalist Monograph. Collins, London.
- Salt, G. & Hollick, F. S. J. 1944. Studies of wireworm populations. I. A census of wireworms in pasture. Ann. appl. Biol., 31 : 52-64.
- Salt, G. & Hollick, F. S. J. 1946. Studies of wireworm populations. II. Spatial distribution. J. exp. Biol., 23 : 1-46.
- Salt, G., Hollick, F. S. J., Raw, F. & Brian, M. V. 1948. The arthropod population of pasture soil. J. Anim. Ecol., 17 : 139-150.
- Satchell, J. E. 1955. Some aspects of earthworm ecology. In, Soil Zoology (ed. by D. K. Mc Kevan) : 180-201. Butterworths, London.
- Satchell, J. E. & Nelson, J. M. 1962. A comparison of the Tullgren-funnel and flotation methods of extracting Acarina from woodland

- soil. In, Progress in Soil Zoology (ed. by P. W. Murphy) :
212-216. Butterworths, London.
- Schuster, R. 1955. Untersuchungen über die bodenbiologische
Bedeutung der Oribatiden (Acari). Naturwiss. 42 : 108-109.
- Schuster, R. 1956. Der Anteil der Oribatiden an den
Zersetzungs Vorgängen im Boden. Z. Morph. Okol. Tiere, 45 : 1-33.
- Sellnick, M. 1928. Formenkreis: Hornmilben, Oribatei in Die
Tierwelt Mitteleuropas, 3 (4) : 1-42.
- Sellnick, M. 1958. Die Familie Zerconidae Berlese. Acta. Zool.
Hung., III (3-4) : 313-368.
- Sellnick, M. & Forsslund, K. H. 1953. Die Gattung Carabodes C. L.
Koch 1836 in der schwedischen Bodenfauna (Acar., Oribatei).
Ark. Zool., (2) 4 : 367-390.
- Sellnick, M. & Forsslund, K. H. 1955. Die Camisiidae Schwedens
(Acar. Oribat.) Ark. Zool., (2) 8 : 473-530.
- Sengbusch, H. G. 1951. Notes on some New York oribatid mites.
Zoologica, 36 (3) : 155-162.
- Sengbusch, H. G. 1954. Studies on the life history of three oribatid
mites with observations on other species. Ann. ent. Soc. Amer.,
47 : 646-667.
- Sengbusch, H. G. 1958. The development of Nanhermannia nana
(Nicolet) (Acarina, Oribatei); life history studies of Oribatei II.
Anat. Rec., 132 (3) : 504.
- Seyd, E. L. 1958. An Oribatid mite new to the British fauna.
Naturalist, Lond. : 3-4.

- Seyd, E. L. 1962. The moss mites of Kinder Scout, Derbyshire (Acari:Oribatei). J. Linn. Soc. (Zool.) 44, (300) : 585-591.
- Sheals, J. 1956. Notes on a collection of Acari. Entom. Monthly Mag., 92 : 99-103.
- Sheals, J. 1957. The Collembola and Acarina of uncultivated soil. J. Anim. Ecol., 26 : 125-134.
- Springett, J. A. 1963. pers. comm.
- Stockli, A. 1957. Die Metazoenfauna von Wiesen - und Ackerboden aus der Umgebung von Zurich. Landw. Jb. Schweiz. 6 (n.s.) : 571-595.
- Stockli, A. & Koffmann, M. Quoted in Soil Biology, 1961, by W. Kuhnel : 233. Faber and Faber, London.
- Strenzke, K. 1949. Okologische studien uber die Collembolengesellschaften feuchter Boden Ost-Holsteins. Arch. Hydrbiol. (plankt.) 42 : 201-303.
- Strenzke, K. 1950. Bestimmungstabelle der holsteinischen Suctobelba-Arten (Acarina:Oribatei). Arch. Hydrbiol. (Plankt.), 44 : 340-343.
- Strenzke, K. 1951. Die norddeutschen Arten der Oribatiden: Gattung Suctobelba. Zool. Anz., 147 (7-8) : 147-166.
- Strenzke, K. 1951. Die Biozön^otik der Oribatiden norddeutscher Böden. Naturwiss., 38. Jahrg., 12 : 284-285.
- Strenzke, K. 1952. Untersuchungen ⁿ über die Tiergemeinschaften des Bodens: Die Oribatiden und ihre Synusien in den Böden Norddeutschlands. Zoologica, 104 : 1-172.

- Strenzke, K. 1953. Zwei neue Arten der Oribatiden: Gattung Nanhermannia. Zool. Anz., 150 (3-4) : 69-75.
- Strickland, A. H. 1947. The soil fauna in two contrasted plots of land in Trinidad, British West Indies. J. Anim. Ecol., 16 : 1-10.
- Tansley, A. G. 1939. The British Islands and their Vegetation. Cambridge.
- Tarras-Wahlberg, N. 1954. Oribatids from the Akhult mire. Oikos, 4 : 166-171.
- Tarras-Wahlberg, N. 1961. The Oribatei of a central Swedish bog and their environment. Oikos, Suppl. 4 : 1-56.
- Thompson, M. 1924. The soil population. An investigation of the biology of soil in Aberystwyth. Ann. appl. Biol., 11 : 349-394.
- Törne, E. von. 1962. A cylindrical tool for sampling manure and compost. In, Progress in Soil Zoology (ed. by P. W. Murphy) : 240-242. Butterworths, London.
- Turk, F. A. 1945. Studies of Acari. V. Notes on and descriptions of new and little known British Acari. Ann. Mag. nat. Hist. (11) 12 : 785-820.
- Turk, F. A. 1953. A synonymic catalogue of British Acari. Ann. Mag. nat. Hist., 61 : 1-26.
- Tuxen, S. L. 1943. Die zeitliche und räumliche Verteilung der Oribatiden-Fauna (Acar.) bei Maelifell, Nord-Island. Ent. Medd. 23 : 321-336.

- Tuxen, S. L. 1952. Die Jugendstadien der nordischen Camisiiden (Acar. Orib.) Und etwas über die Systematic der Erwachsenen. I. Die Gattungen Nothrus, Platynothrus und Heminothrus. Ent. Medd., 26 : 392-403.
- van der Drift, J. 1950. See Drift.
- Vitzthum, H. G. 1931. Ordnung der Arachnida: Acari-Milben. In, Handbuch der Zoologie, by Kükenthal, W., & Krumbach, 3 (2) : 1-160. Berlin & Leipzig.
- Vitzthum, H. G. 1940-1943. Acarina. In, Bronn's Klassen und Ordnungen des Tierreiches, 5 (4) 5 : 1-1011. Leipzig.
- Volz, P. 1934. Untersuchungen über Mikroschichtung der Fauna von Waldboden. Zool. Jb., (Abt. Syst.) 66 : 153-210.
- Volz, P. 1951. Untersuchungen über die Mikrofauna des Waldbodens. Zool. Jb. (Abt. Syst.) 79 : 514-566.
- Waksman, S. A. 1931. Influence of temperature and moisture upon the nature and extent of decomposition of plant residues by micro-organisms. Ecology, 12 : 33-60.
- Wallwork, J. A. 1958. Notes on feeding behaviour of forest soil mites. Oikos,, 9 (2) : 260-271.
- Wallwork, J. A. 1959. The distribution and dynamics of some forest soil mites. Ecology, 40 (4) : 557-563.
- Watson, E. V. 1955. British mosses and liverworts. Cambridge.
- Watson, W. 1953. Census catalogue of British lichens. Cambridge.
- Weis-Fogh, T. 1948. Ecological investigations on mites and collemboles in the soil. App.: Description of some new mites (Acari). Nat. Jutland. 1 : 139-277.

- Williams, S. T. 1963. The distribution of fungi in the horizons of a podsolised soil. In, Soil Organisms, (ed. by J. Doeksen and J. van der Drift). : 158-166. North-Holland, Amsterdam.
- Willmann, C. 1931. Moosmilben oder Oribatiden (Cryptostigmata). In, Dahl. Die Tierwelt Deutschlands, 22 : 79-200.
- Woodring, J. P. & Cook, E. F. 1962. The biology of Ceratozetes cisalpinus Berlese Scheloribates laevigatus Koch, and Oppia neerlandica Oudemans (Oribatei), with a description of all stages. Acarologia, 4 (1) : 101-137.
- Woolley, T. A. 1961. A review of the phylogeny of mites. Ann. rev. Ent. 6 : 263-284.
- Zeuthen, E. 1947. Body size and metabolic rate in the animal kingdom. Compt-rend. Lab. Carlsb., Sér. chim., 26 : 17-165.

APPENDIX I

Soil profiles of the sample sites at Moor House.

Limestone grassland soil profile (Johnson and Dunham, 1963).

Horizon	Depth, etc. (cm.)	Description
L-F	2.5	Black coloured litter with many roots.
A	0.0- 7.5	Dark purple-brown coloured clay loam with irregularly distributed areas of lighter grey coloured soil. Crumb structure, many roots, fairly high organic content towards the top. Sharp junction with-
B ₁	at 7.5	Bright orange coloured iron pan. Very thin horizon and irregular in the solum.
B ₂	7.5-17.5	Dull yellow-brown coloured clay with crumb structure. Very irregular base.
	17.5-22.5	Dark brown coloured soft clay with crumb structure containing limestone blocks and fragments. Considerable organic content.
D	22.5 +	Bedrock limestone with joints filled with dark-brown coloured soft wet clay.

Soil profile of Calluna site (Banage, 1960; Johnson and Dunham, 1963)

Horizon	Depth, etc. (cm.)	Description
L	0.0- 4.0	Thick litter composed of dead <u>Calluna</u> leaves, lichens, mosses, liverworts, etc. with many procumbent stems of <u>Calluna vulgaris</u> .
F	4.0- 5.0	Fermentation layer merging into-
H	5.0-15.0	Dark humified peat, slightly crumbly, with fibrous plant roots.
H	15.0-60.0	Yellow-brown unoxidised peat with <u>Calluna</u> roots in upper parts; <u>Eriophorum</u> and <u>Calluna</u> remains distinguishable; lower layers more decomposed and compacted and merging into plastic peat with few recognisable plant remains. Blanket peat up to 4.0 m. thick.
A ₁ G	0.0- 5.0	Dark-brown coloured, sandy mixed organic and mineral layer with some sandstone boulders and pebbles. Rotten sandstone pebbles and boulders are frequently present.
A ₂ G	5.0-12.5	Pale buff-grey coloured clay with few sandstone boulders. Sharp change into-
B ₂ G C	12.5-25.0	Light grey coloured stony clay with sandstone pebbles and boulders. Clay

Horizon	Depth, etc. (cm.)	Description
C	25.0 +	is firm when moist and dries with a blocky structure. Low organic content. Merges with- Light grey and blue grey coloured stony clay with sandstone pebbles and boulders. Unaltered solifluxion deposit parent material.

Soil profile of *Juncus squarrosus* site (Banage, 1960; Johnson and Dunham, 1963).

Horizon	Depth, etc. (cm.)	Description
L	0.0- 3.0	Litter composed of leaves, leaf bases and root-stocks of <u><i>Juncus squarrosus</i></u> and <u><i>Deschampsia flexuosa</i></u> , little humified.
F	3.0-10.0	Fermentation layer, as above but slightly humified, merging into-
H	4.0-42.0	Very dark brown peat.
A	0.0-10.0	Dull light grey-buff coloured sandy clay loam with rotten sandstone pebbles and boulders. Horizon becomes paler downwards. Many roots concentrated into a mat at the sharp lower boundary.
B ₁ h	10.0-11.25	Bright orange-brown coloured indurated iron pan. Hard and cemented with dark upper surface, which is not penetrated by roots. Very conspicuous in the profile where it forms a persistent but undulating horizon.
B ₂ -C	11.25-22.5	Yellow and buff mottled stiff stony and sandy clay with sandstone pebbles and boulders. Merges into-
C	22.5 +	Grey and blue-grey stony clay with solifluxion deposits.

Soil profile of the *Nardus stricta* grassland site. (Banage, 1960).

Horizon	Depth, etc. (cm.)	Description
L	0.0- 5.0	Litter mainly composed of loosely packed living and dead basal portions of <u><i>Nardus stricta</i></u> , merging into-
F + H	5.0- 6.0	Fermentation layer turning into humus, divided by a sharp and wavy boundary from the underlying layer.
A ₁	6.0-40.0	Dark-brown, moist, sandy loam; soil with crumb structure, with mixed humus of alluvial peat origin. Abundant fine, fibrous roots, particularly in upper layers, merging into-
B ₂	40.0-53.0	As in A, though somewhat leached; deeper layers with common, prominent fine to medium iron mottling, and passing into a layer of sub-angular stones and boulders of sandstone.
	53.0 +	Bedrock sandstone above Single Post Limestone.

APPENDIX II

Other taxonomic works consulted.

Mesostigmata :

- Berlese, A. 1906. Monographia del genere Gamasus Latreille. Redia., 3:66-304.
- Evans, G. O. 1955. A revision of the British mites of the genus Veigaia. Proc. zool. Soc. Lond., 125:569-586.
- Evans, G. O. 1955. A revision of the Family Epicriidae (Acarina-Mesostigmata). Bull. Brit. Mus. (nat. Hist.), 3(4):169-200.
- Evans, G. O. and Browning, E. 1956. British mites of the Subfamily Macrochelinae Trägårdh (Gamasina-Macrochelidae), Bull. Brit. Mus. (nat. Hist.), 4(1):1-55.
- Evans, G. O. and Hyatt, K. H. 1960. A revision of the Platyseiinae (Mesostigmata-Aceosejidae). Bull. Brit. Mus. (nat. Hist.), 6(2): 25-101.
- Leitner, E. 1949. Zur Kenntnis der Gattung Digamasellus Berlese 1905. Zbl. Gesamt. Geb. Ent. (Lienz)., 3:51-62.
- Sellnick, M. 1958. Die Familie Zerconidae Berlese. Acta Zool. Hung., III, 3-4:313-368.
- Vitzthum, H. G. 1931. Ordnung der Arachnida-Acari-Milben. In, Handbuch der Zoologie by Kükenthal and Krumbach, 3(2):1-160.
- Vitzthum, H. G. 1940-43. Acarina. In, Bronn's Klassen und Ordnungen des Tierreiches, 5(4)5:1-1011.

Cryptostigmata :

- Forsslund, K. H. 1941. Schwedische Arten der Gattung Suctobelba Paoli (Acari, Oribatei). Zool. Bidr. Uppsala, 20:381-396.
- Hammen, L. van der and Strenzke, K. 1953. A partial revision of the genus Metabelba Grandjean (Oribatei, Acari). Zool. Meded., 32:141-154.
- Sellnick, M. and Forsslund, K. H. 1953. Die Gattung Carabodes C. L. Koch 1836 in der schwedischen Bodenfauna (Acari, Oribatei). Ark. Zool., (2)4:367-390.
- Strenzke, K. 1950. Bestimmungstabelle der holsteinischen Suctobelba Arten (Acarina:Oribatei). Arch. Hydriobiol. (Plankt.), 44:340-343.
- Strenzke, K. 1951. Die norddeutschen Arten der Oribatiden: Gattung Suctobelba. Zool. Anz., 147(7-8):147-166.
- Strenzke, K. 1953. Zwei neue Arten der Oribatiden: Gattung Nanhermannia. Zool. Anz., 150(3-4):69-75.

Keys of the British species of Acarina were also consulted from the British Museum (Nat. Hist.) for the following groups :

Family Phthiracaridae" Pseudotritiidae." Galumnidae." Cephidae." Belbidae.Genus Pelops." Damaeus." Steganacarus.