

## Durham E-Theses

---

### *A study of the reactions of fluorocarbon iodides*

John Hutchinson

#### How to cite:

---

Hutchinson, John (1968) A study of the reactions of fluorocarbon iodides. Doctoral thesis, Durham University.

#### Use policy

---

The full-text may be used and/or reproduced, and given to third parties in any format or medium, without prior permission or charge, for personal research or study, educational, or not-for-profit purposes provided that:

- a full bibliographic reference is made to the original source
- a <https://etheses.durham.ac.uk/id/eprint/8883/> is made to the metadata record in Durham E-Theses
- the full-text is not changed in any way

The full-text must not be sold in any format or medium without the formal permission of the copyright holders.

Please consult the [full Durham E-Theses policy](#) for further details.

DURHAM UNIVERSITY

A THESIS

entitled

A STUDY OF THE REACTIONS OF FLUOROCARBON  
IODIDES

Submitted by

JOHN HUTCHINSON, B.Sc.

(Hatfield College)

A candidate for the degree of Doctor of Philosophy.

1963.



## CONTENTS

	Page No.
Acknowledgements	i
Summary	ii
<u>Chapter 1. Introduction.</u>	
Preparation of Fluorocarbon Iodides	1
Telomerisation reactions of polyfluoroalkyl iodides.	15
Factors influencing telomerisation reactions.	16
Isomer formation by free-radical attack on unsymmetrical fluoro-olefins.	22
Telomerisation reactions initiated by free-radical initiators.	27
Thermal telomerisation of hexafluoropropene and other olefins which are difficult to homopolymerise.	28
Reactions of Polyfluoroiodoalkanes.	33
Fluorine containing Polymers.	43
<u>Chapter 2. Discussion of Experimental Work.</u>	
Introduction.	51
Preparation of Model Compounds of Viton A	
A) involving the coupling of two radicals.	52
B) involving telomer iodides as intermediates.	55
Telomerisation reactions of 1,1-difluoroethylene.	56
Reactions of Telomer Iodides of 1,1-difluoroethylene.	65

Preliminary investigation into the reactions of Model compounds of Viton A.	76
 <u>Chapter 3. Experimental.</u>	
Physical Measurements.	84
Pressure Reactions.	85
Gas-Liquid Chromatography.	86
Analysis.	90
Preparation of simple iodides.	95
The attempted preparation of 2H,2H-decafluoro- (3-methylbutane) from 1,1,1-trifluoro-2- iodoethane and heptafluoro-2-iodopropane, and related reactions.	103
Preparation of Telomer Iodides.	108
Reactions of Telomer Iodides.	119
The Dehydrofluorination of model compounds related to Viton A.	142
Infra-red Spectra	155
 <u>Chapter 4. The Carbon-Iodine bond strength in Polyfluoroiodoalkanes.</u>	
Introduction	170
Results	173
Discussion	175
Experimental	178
References	183

## Acknowledgements

I should like to express my thanks and appreciation to Professor W.K.R. Musgrave and Dr. R.D. Chambers for their continual help and encouragement during their supervision of the work recorded in this thesis. My thanks also go to Dr. R.H. Mobbs for his many helpful suggestions, to Drs. J. Emsley and L.H. Sutcliffe for the nuclear magnetic resonance measurements, and to the many laboratory technicians of the University Science Laboratories for their considerable help and co-operation.

I should like to thank also Yarsley Laboratories for a maintenance grant.

SUMMARY

Polyfluoroiodoalkanes have been used to synthesise model compounds related to Viton A, a co-polymer of 1,1-difluoroethylene and hexafluoropropene, in which the predominating arrangement is  $-\text{CF}_2\text{CF}(\text{CF}_3)\text{CH}_2\text{CF}_2\text{CH}_2\text{CF}_2-$ . Efforts to prepare such compounds by the coupling of two polyfluoroalkyl radicals failed but success was achieved by a route involving the preparation of telomer iodides of 1,1-difluoroethylene. Heptafluoro-2-iodopropane was used as the source of tertiary fluorine and was added thermally to 1,1-difluoroethylene. The iodine of the 1:1 adduct was replaced by hydrogen and fluorine, and the adduct itself was coupled. The product from the coupling reaction was found to be the most conveniently prepared model. For comparison, similar models without tertiary fluorine were synthesised using heptafluoro-1-iodopropane and pentafluoroiodoethane as starting materials in the same reaction sequence. The dehydroiodination of all the low molecular weight telomers prepared afforded a series of olefins, suitable for co-polymerisation studies, in good yield.

A preliminary investigation into the processes occurring during the cross-linking of Viton A was undertaken using

the model compounds described above, but while it was confirmed that tertiary fluorine is eliminated preferentially during treatment with amines, it was also discovered that this was not the only process taking place.

A measure of the relative C-I bond strengths in polyfluoroiodoalkanes has been obtained by measuring the relative rates of exchange of radioactive iodine with the iodine in the iodides. The order of decreasing C-I bond strength is  $\text{CF}_3\text{I} > \text{C}_2\text{F}_5\text{I} \approx \text{CF}_3\text{CH}_2\text{I} > n\text{-C}_3\text{F}_7\text{I} > (\text{CF}_3)_2\text{CFI}$ . The C-I bond strength in pentafluoroiodobenzene is of the same order as that in  $\text{CF}_3\text{I}$  and  $\text{C}_2\text{F}_5\text{I}$  rather than that in the heptafluoroiodopropanes.

## Chapter 1

### INTRODUCTION

The preparation of fluorocarbon iodides other than telomers  
(See Table 1, p.10 )

Fluorocarbon iodides are among the most useful compounds in fluorine chemistry and therefore much effort has been devoted to their preparation.

One of the most useful general methods of preparation is by decarboxylation of the silver salt of the corresponding fatty acid in the presence of iodine.

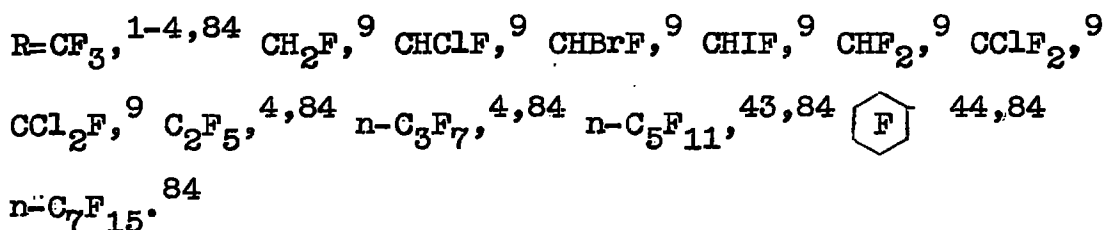
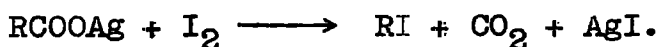

If the reactants are dry, high yields of the iodide are obtained. The temperature necessary for the reaction to proceed at a convenient rate is dictated by the nature of the individual salt. Diiodides<sup>4,39</sup> too can be prepared by this method but yields are sometimes reduced owing to lactone formation.<sup>4</sup> A study of this type of reaction has been made by Crawford and Simons<sup>82</sup> who treated several silver perfluorocarboxylates with iodine at room temperature in fluorocarbon solvents and were able to isolate complexes of formula  $(\text{Rf.COO})_2\text{AgI}$ , in which  $\text{Rf} = \text{CF}_3, \text{C}_2\text{F}_5, \text{n-C}_3\text{F}_7,$



$n\text{-C}_4\text{F}_9$  or  $n\text{-C}_5\text{F}_{11}$ .

A general method for the preparation of iodides having the formula  $\text{Rf.CH}_2\text{I}$  involves the decomposition of tosylates<sup>35</sup> or other esters<sup>19</sup> of fluoroalcohols in the presence of sodium or potassium iodide. Tiers in 1953<sup>35</sup> reported this reaction when he prepared the tosyl esters of several fluoroalcohols and then carried out the nucleophilic replacement of the tosyl group by iodine using sodium iodide in ethylene glycol at 150-220°C.

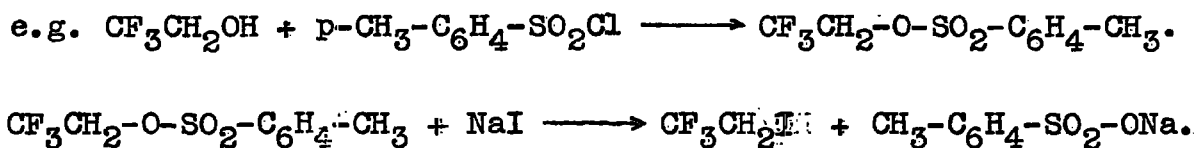

Fluoroalcohols can be converted into iodides by treatment with iodine and red phosphorus,<sup>17,36</sup> or potassium iodide and phosphoric acid.<sup>40</sup>

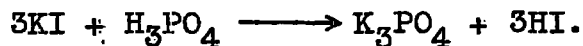



The treatment of diazo compounds of the formula  $\text{Rf.CHN}_2$  with hydrogen iodide<sup>17,19</sup>, or with iodine<sup>22</sup> affords the iodide  $\text{Rf.CH}_2\text{I}$ , and the diiodide  $\text{Rf.CHI}_2$  respectively.

Nucleophilic replacement in saturated bromides by iodine has been carried out by McBee and co-workers<sup>36</sup>



acetylenes.<sup>75</sup> These reactions have been carried out both under conditions favouring an ionic mechanism and those favouring a radical mechanism. Although success was achieved in adding hydrogen iodide to  $\text{CF}_2:\text{CH}_2$ ,<sup>27</sup>  $\text{CF}_2:\text{CHCl}$ ,<sup>27</sup> and  $\text{CF}_3\text{C}:\text{CH}$ ,<sup>75</sup>  $\text{cy-C}_6\text{F}_{10}$ ,<sup>27</sup>  $\text{C}_3\text{F}_6$ <sup>38</sup> and  $\text{CF}_3\text{CF}:\text{CFCF}_3$ <sup>27,38</sup> failed to react under all conditions used, and  $\text{cy-C}_4\text{F}_8$  yielded  $\text{CF}_2\text{HCFHCFHCF}_2\text{H}$ .<sup>41</sup>

Many iodides have been prepared by the addition of "I-X" (X = F, Cl, Br) to an olefinic double bond. Early reports of such reactions claim that in a reaction involving an asymmetric olefin only one isomer is produced, but with the development of gas-liquid chromatography, it has been revealed that in most cases both isomers are formed, the ratio of each depending upon the conditions used. Iodine chloride has been added to  $\text{CF}_2:\text{CFCl}$ ,<sup>12,24-29,33</sup>  $\text{CF}_2:\text{CHF}$ ,<sup>30,31</sup>  $\text{CF}_2:\text{CHCl}$ ,<sup>132</sup>  $\text{CF}_2:\text{CHBr}$ ,<sup>132</sup>  $\text{CF}_2:\text{CHI}$ ,<sup>132</sup>  $\text{CF}_2:\text{CH}_2$ ,<sup>27,132</sup>  $\text{CFCl}:\text{CFCl}$ ,<sup>132</sup>  $\text{CF}_2:\text{CCl}_2$ ,<sup>28</sup>  $\text{C}_2\text{F}_4$ ,<sup>32</sup>  $\text{C}_3\text{F}_6$ ,<sup>28</sup>  $\text{cy-C}_4\text{F}_8$ <sup>27</sup> (  was the main product of this reaction) and  $\text{cy-C}_6\text{F}_{10}$ <sup>27</sup> (  was the main product of this reaction); and iodine bromide to  $\text{CF}_2:\text{CFCl}$ ,<sup>12,25</sup>  $\text{CF}_2:\text{CH}_2$ ,<sup>18</sup> and  $\text{C}_2\text{F}_4$ .<sup>32</sup> Iodine pentafluoride has been used to add the elements of iodine and fluorine to  $\text{C}_2\text{F}_4$ ,  $\text{C}_3\text{F}_6$ ,  $\text{cy-C}_4\text{F}_6$ , and  $\text{cy-C}_6\text{F}_{10}$  in the vapour phase at  $170^\circ\text{C}$ .<sup>10</sup> A stoichiometric mixture of iodine pentafluoride and iodine has been shown to react as if it were iodine monofluoride,<sup>11-13</sup> an interhalogen compound only prepared by a low temperature

reaction between iodine and fluorine.<sup>85</sup> Using this reagent, "iodine fluoride" has been added to  $C_2F_4$ ,<sup>11-13</sup>  $CF_2:CH_2$ ,<sup>11-13</sup>  $CF_2:CFH$ ,<sup>13</sup>  $CF_2:CFCl$ ,<sup>12,13</sup>  $CF_2:CCl_2$ ,<sup>12,13</sup>  $CF_2:CHCl$ ,<sup>13</sup>  $CFCl:CFCl$ <sup>13</sup> and  $C_3F_6$ ,<sup>11-13</sup>. Krespan<sup>14</sup> has found that mixtures of potassium fluoride and iodine in acetonitrile behave in a like manner, and using this reagent has added "iodine fluoride" to  $C_2F_4$ ,  $CF_2:CCl_2$ ,  $C_3F_6$ ,  $cy-C_4F_8$ ,  $CF_3CF=CFCF_3$  and  $CHF_2(CF_2)_4CF=CF_2$ . (The addition of "iodine fluoride" to  $cy-C_4F_8$ ,  $(CF_3)_2C:CF_2$  and  $cy-C_6F_{10}$  using iodine pentafluoride and iodine failed under all conditions used<sup>42</sup>). Worthy of mention here is the work of Bowers et. al.<sup>86</sup> who used mixtures of N-iodosuccinimide and anhydrous hydrogen fluoride in the presence of an organic proton acceptor such as ether or T.H.F. to add the elements of iodine and fluorine to cyclohexene and a variety of unsaturated steroids.

The mechanism by which these addition reactions proceed is open to speculation. Reactions between olefins of the hydrocarbon series and interhalogens are undoubtedly electrophilic, so it might be thought the same is true of the attack of interhalogens on fluoro-olefins. However it is well known that fluoro-olefins are very susceptible to nucleophilic attack and in particular the work of Miller et. al.<sup>34,37,87</sup> has shown that  $F^-$  is a particularly strong nucleophile.

The high electronegativity of fluorine results in a reduction of electron density in the double bond of fluoro-olefins. As a result of this, such a system becomes more susceptible to nucleophilic attack and less susceptible to electrophilic attack. Another factor to be considered is that vinylic fluorine atoms are able to return electrons to the double bond by the mesomeric effect thus causing polarisation of the double bond in the direction shown and encouraging nucleophilic attack on the difluoromethylene group.

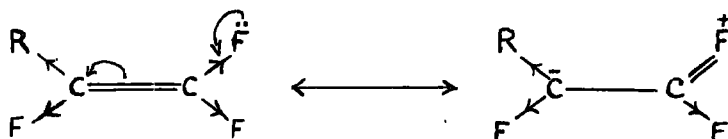

R = Cl, Br, I, H or a perfluoroalkyl group.

If R is a perfluoroalkyl group other than  $\text{Rf}_3\text{C}^-$ , e.g.  $\text{CF}_3^-$ , there is a further effect to be considered; a negative type of hyperconjugation which works in the same direction as the mesomeric effect and encourages, even more, nucleophilic attack on the difluoromethylene group.

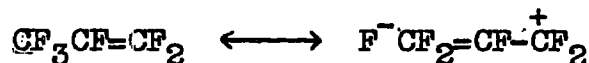

In certain cases, the electronic effects are opposed to one another as in  $\text{CH}_3\text{CH}=\text{CF}_2$  and the direction of attack must be settled by experiment.

Consideration of the aforementioned effects affords an explanation for the increase in reactivity towards nucleophiles in the series  $\text{CF}_2:\text{CF}_2 < \text{CF}_2:\text{CFCF}_3 < \text{CF}_2:\text{C}(\text{CF}_3)_2$ . Also explained is the fact that in most cases, nucleophilic attack occurs on the difluoromethylene group when available. Unfortunately, most of the reactions which are not explained are those which involve the addition of 'IF', ICl, IBr or HI to fluoro-olefins.

As already mentioned,  $\text{F}^-$  is a very reactive nucleophile but  $\text{Cl}^-$  and  $\text{Br}^-$  are much less so. It is almost certain therefore that 'IF' adds to fluoro-olefins via a nucleophilic mechanism. Although the products are usually those in which the fluoride ion has become attached to the difluoromethylene group, there are exceptions which are not easily explained. For example, the product from the reaction of 'IF' with  $\text{CF}_2:\text{CFCl}$  is a mixture of the two possible isomers; also, the addition of 'IF' to  $\text{CF}_2:\text{CCl}_2$  is bi-directional. In this latter reaction, high temperatures favour the formation of  $\text{CF}_2\text{ICCl}_2\text{F}$  whereas when the reaction is carried out at  $0^\circ\text{C}$ . and in the presence of aluminium trioxide,  $\text{CF}_3\text{CCl}_2\text{I}$  is produced almost exclusively. The presence of iron in this system seems to lower the overall conversion into iodides.<sup>13</sup>

The addition of iodine monochloride and -bromide to

fluoro-olefins has been investigated extensively, but the factors which influence the orientation of addition, and the mechanism by which the reactions proceed, are not clear. Early reports<sup>24-27,33</sup> indicate that the addition of iodine monochloride and -bromide to  $\text{CF}_2:\text{CFCl}$  yields exclusively  $\text{CF}_2\text{ClCFClI}$  and  $\text{CF}_2\text{BrCFClI}$ . Recently<sup>12,28,29</sup> however, the reaction has been reinvestigated and the use of gas-liquid chromatography has revealed that both isomers are formed in ratios depending upon the conditions used. High temperatures favour the formation of  $\text{CF}_2\text{ICFCl}_2$  while at  $0^\circ\text{C}$ . or lower  $\text{CF}_2\text{ClCFClI}$  is the major product. The presence of iron in the system favours the formation of  $\text{CF}_2\text{ICFCl}_2$  so that when the reaction is carried out even at  $0^\circ\text{C}$ ., 65% of the reaction product is  $\text{CF}_2\text{ICFCl}_2$ . There is no obvious explanation for this behaviour. The addition of iodine monochloride to  $\text{CF}_2:\text{CCl}_2$ <sup>28</sup> is also bi-directional and again the ratio of isomers produced is temperature dependent and influenced by the presence of iron. The addition of iodine monochloride to  $\text{CF}_2:\text{CFH}$ <sup>30,31</sup> and  $\text{CF}_2:\text{CH}_2$ <sup>27</sup>, and the addition of iodine monobromide to  $\text{CF}_2:\text{CH}_2$ <sup>18</sup> has been reported as giving  $\text{CF}_2\text{Cl.CFHI}$ ,  $\text{CF}_2\text{ClCH}_2\text{I}$  and  $\text{CF}_2\text{BrCH}_2\text{I}$  exclusively, but it now seems likely that were these reactions to be reinvestigated, both isomers would be observed.

Iodine pentafluoride reacts with polyhalogenoalkanes

under controlled conditions to yield fluoroalkyl iodides. Thus Banks<sup>5</sup> et. al. have prepared trifluoroiodo-methane in good yield by treatment of carbon tetraiodide with iodine pentafluoride. Pentafluoroiodoethane has been prepared by the interaction of tetrafluoro 1,2-diiodoethane and iodine pentafluoride.<sup>5,15,48</sup>

Vinyl iodides have been prepared<sup>30,132</sup> by adding iodine monochloride to an olefin containing a difluoromethylene group and a hydrogen atom, and then removing hydrogen chloride from the product.

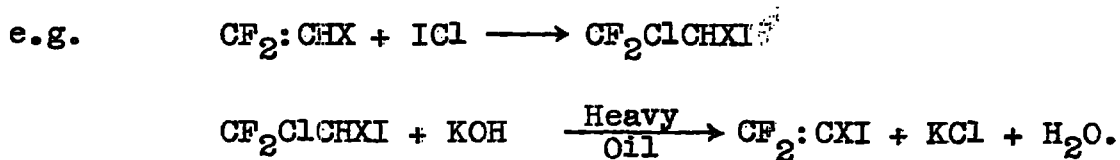

X = H, F, Cl, Br, I.

This reaction scheme gives a pure product only if the addition of iodine monochloride is unidirectional.

Table 1 summarises the preparation of all simple iodides other than telomers.

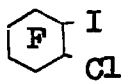





TABLE 1The preparation of fluorocarbon iodides other than telomers

<u>Iodide</u>	<u>Method of Preparation</u>	<u>References</u>
CF <sub>3</sub> I	CF <sub>3</sub> COOAg/I <sub>2</sub>	1,4,83,84.
	CF <sub>3</sub> COOAg,K,Hg,Pb,Ba/I <sub>2</sub>	2,3.
	Cl <sub>4</sub> /IF <sub>5</sub>	5,6.
	Cl <sub>4</sub> /F <sub>2</sub>	70.
	CF <sub>3</sub> COCl/KI	7.
	CF <sub>3</sub> COOI/I <sub>2</sub>	2,8.
CF <sub>2</sub> HI	CF <sub>2</sub> HCOOAg/I <sub>2</sub>	9
CFH <sub>2</sub> I	CFH <sub>2</sub> COOHg/I <sub>2</sub>	9
CFHClI	CFHClCOOAg/I <sub>2</sub>	9
CFHBrI	CFHBrCOOAg/I <sub>2</sub>	9
CFHI 2	CFHI.COOAg/I <sub>2</sub>	9
	CFCl <sub>2</sub> I	9
CFCl <sub>2</sub> I	CFCl <sub>2</sub> COOAg/I <sub>2</sub>	9
	CCl <sub>2</sub> FBr/NaI, Acetone	34.
CF <sub>2</sub> ClI	CF <sub>2</sub> ClCOOAg/I <sub>2</sub>	9
C <sub>2</sub> F <sub>5</sub> I	C <sub>2</sub> F <sub>5</sub> COONa/I <sub>2</sub>	9
	C <sub>2</sub> F <sub>5</sub> COOAg/I <sub>2</sub>	4,84.
	ICF <sub>2</sub> CF <sub>2</sub> I/IF <sub>5</sub>	5,15,48
	C <sub>2</sub> F <sub>4</sub> /IF <sub>5</sub>	10
	C <sub>2</sub> F <sub>4</sub> /IF <sub>5</sub> /I <sub>2</sub>	11,12,13.
	C <sub>2</sub> F <sub>4</sub> /KF/I <sub>2</sub>	14

$\text{CFH}_2\text{CH}_2\text{I}$	$\text{CH}_2\text{ICH}_2\text{I}/\text{HgF}_2$	16
$\text{CF}_2\text{HCH}_2\text{I}$	$\text{CF}_2\text{HCH}_2\text{Br}/\text{CaI}_2$	101
$\text{CF}_3\text{CH}_2\text{I}$	$\text{CF}_3\text{CHN}_2/\text{HI}$	17
	$\text{CF}_3\text{CH}_2\text{OH}/\text{P}/\text{I}_2$	17
	$\text{CF}_2\text{BrCH}_2\text{I}/\text{Hg}_2\text{F}_2$	18
	$(\text{CF}_3\text{CH}_2\text{O})_3\text{PO}/\text{NaI}$	19
	$\text{CF}_3\text{CH}_2\text{O-p-tosyl}/\text{NaI}$	35
	$\text{CF}_2:\text{CH}_2/\text{I}_2$	20, 21
	$\text{CF}_2:\text{CH}_2/\text{IF}_5/\text{I}_2$	11, 12, 13
$\text{CF}_3\text{CHI}_2$	$\text{CF}_3\text{CHN}_2/\text{I}_2$	22
$\text{CF}_2\text{ICF}_2\text{I}$	$\text{C}_2\text{F}_4/\text{I}_2$	15, 23
$\text{CF}_2\text{ClCFClI}/\text{CF}_2\text{ICFCl}_2$	$\text{CF}_2:\text{CFCl}/\text{ICl}$	12, 24-29, 33
$\text{CF}_2\text{BrCFClI}/\text{CF}_2\text{ICFClBr}$	$\text{CF}_2:\text{CFCl}/\text{IBr}$	12, 25
$\text{CF}_2\text{ICFClI}$	$\text{CF}_2:\text{CFCl}/\text{I}_2$	24
$\text{CF}_3\text{CFClI}/\text{CF}_2\text{ICF}_2\text{Cl}$	$\text{CF}_2:\text{CFCl}/\text{IF}_5/\text{I}_2$	12, 13
$\text{CF}_2\text{ClCCl}_2\text{I}/\text{CF}_2\text{ICCl}_3$	$\text{CF}_2:\text{CCl}_2/\text{ICl}$	28
$\text{CF}_3\text{CCl}_2\text{I}/\text{CF}_2\text{ICCl}_2\text{F}$	$\text{CF}_2:\text{CCl}_2/\text{IF}_5/\text{I}_2$	12, 13
$\text{CF}_3\text{CCl}_2\text{I}$	$\text{CF}_2:\text{CCl}_2/\text{KF}/\text{I}_2$	14
$\text{CF}_2\text{ClCFClI}$	$\text{CFCl}:\text{CFCl}/\text{IF}_5/\text{I}_2$	13
$\text{CFCl}_2\text{CFClI}$	$\text{CFCl}:\text{CFCl}/\text{ICl}$	132
$\text{CF}_2\text{BrCH}_2\text{I}$	$\text{CF}_2:\text{CH}_2/\text{IBr}$	18
$\text{CF}_2\text{ClCH}_2\text{I}$	$\text{CF}_2:\text{CH}_2/\text{ICl}$	27, 132
$\text{CF}_2\text{ICH}_3$	$\text{CF}_2:\text{CH}_2/\text{HI}$	27

$\text{CF}_2\text{ClCFHI}$	$\text{CF}_2:\text{CFH/ICl}$	30,31
$\text{CF}_3\text{CFHI}$	$\text{CF}_2:\text{CFH/IF}_5/\text{I}_2$	13
$\text{CF}_2\text{ICH}_2\text{Cl}$	$\text{CF}_2:\text{CHCl/HI}$	27
$\text{CF}_3\text{CHClI}$	$\text{CF}_2:\text{CHCl/IF}_5/\text{I}_2$	13
$\text{CF}_2\text{ClCHClI}$	$\text{CF}_2:\text{CHCl/ICl}$	132
$\text{CF}_2\text{ClCF}_2\text{I}$	$\text{C}_2\text{F}_4/\text{ICl}$	32
$\text{CF}_2\text{ClCHBrI}$	$\text{CF}_2\text{CHBr/ICl}$	132
$\text{CF}_2\text{ClCHI}_2$	$\text{CF}_2\text{CHI/ICl}$	132
$\text{CF}_2\text{BrCF}_2\text{I}$	$\text{C}_2\text{F}_4/\text{IBr}$	32
$\text{CF}_2:\text{CFI}$	$\text{CF}_2\text{ClCFHI/KOH}$	30
$\text{CF}_2:\text{CHI}$	$\text{CF}_2\text{ClCH}_2\text{I/KOH}$	132
$\text{CF}_2:\text{CClI}$	$\text{CF}_2\text{ClCHClI/KOH}$	132
$\text{CF}_2:\text{CBrI}$	$\text{CF}_2\text{ClCHBrI/KOH}$	132
$\text{CF}_2:\text{Cl}_2$	$\text{CF}_2\text{ClCHI}_2/\text{KOH}$	132
$\text{CH}_2:\text{CFI}$	$\text{CF}_2:\text{CH}_2/\text{I}_2$	20,21
$n\text{-C}_3\text{F}_7\text{I}$	$n\text{-C}_3\text{F}_7\text{COOAg/I}_2$	4
	$n\text{-C}_3\text{F}_7\text{COOI/I}_2$	2,83,84
$\text{CF}_3\text{CH}_2\text{CH}_2\text{I}$	$\text{CF}_3\text{CH}_2\text{CH}_2\text{Br/NaI,acetone}$	36
$\text{CF}_3\text{CH}_2\text{CHClI}$	$\text{CF}_3\text{CH}_2\text{CH}_2\text{I/Cl}_2$	69
$\text{CF}_3\text{CH}_2\text{CHBrI}$	$\text{CF}_3\text{CH}_2\text{CH}_2\text{I/Br}_2$	69
$\text{CF}_2\text{CFCF}_2\text{I}$	$\text{CF}_2\text{CFCF}_2\text{Cl/NaI,acetone}$	37
$\text{CF}_2\text{CClCF}_2\text{I}$	$\text{CF}_2\text{CClCF}_2\text{Cl/NaI,acetone}$	37
$\text{CFClCHCF}_2\text{I}$	$\text{CF}_2\text{CHCCl}_2\text{F/NaI,acetone}$	34
$\text{CF}_3\text{CFICF}_2\text{Cl}$ /		
$\text{CF}_3\text{CFClCF}_2\text{I}$	$\text{C}_3\text{F}_6/\text{ICl}$	28

$(CF_3)_2CFI$	$C_3F_6/IF_5/I_2$	11,12,13
	$C_3F_6/KF/I_2$	14
	$[(CF_3)_2CF]_2Hg/I_2$	105
	$C_3F_6/IF_5$	10
No prod. under conditions used.	$C_3F_6/HI$	38
$ICF_2CF_2CF_2I$	$(CF_2)_3(COOAg)_2/I_2$	4
$CF_3CH:CHI$	$CF_3C:CH/HI$	75
$ICF_2CF_2CF_2CF_2I$	$(CF_2)_4(COOAg)_2/I_2$	39
$n-C_3F_7CH_2I$	$n-C_3F_7CH_2O-p-tosyl/NaI$	35
	$n-C_3F_7CHN_2/HI$	19
$H(CF_2)_4I$	$H(CF_2)_4COCl/KI$	7
$CF_3CH_2CH_2I$	$CF_3CH_2CH_2CH_2I/H_3PO_4/KI$	40
$\boxed{F} \begin{array}{l} I \\ Cl \end{array}$	$\boxed{F} /ICl$	27
No iodide produced	$\boxed{F} /HI$	27,41
"	$CF_3CF:CF_3/ICl$	27
No reactn. under conditions used	$CF_3CF:CF_3/HI$	27,38
"	$(CF_3)_2C=CF_2/IF_5/I_2$	42
"	$\boxed{F} /IF_5/I_2$	42
$\boxed{F} I$	$\boxed{F} /KF/I_2$	14
	$\boxed{F} /IF_5$	10
$CF_3CFI \cdot CF_2CF_3$	$CF_3CF:CF_3/KF/I_2$	14
$CF_2ClCFClCF_2CH_2I$	$CF_2ClCFClCF_2CH_2O-p-tosyl/NaI$	80

$\text{CF}_2:\text{CFCF}_2\text{CF}_2\text{I}$	$\text{CF}_2:\text{CFCF}_2\text{CF}_2\text{COOAg/I}_2$	186
$n\text{-C}_5\text{F}_{11}\text{I}$	$n\text{-C}_5\text{F}_{11}\text{COOAg/I}_2$	43,84
$\text{CF}_3\text{CH}_2\text{CH}_2\text{CHI}\cdot\text{CH}_3$	$\text{CF}_3\text{CH}_2\text{CH}_2\text{CHOHCH}_3/\text{P/I}_2$	36
$\text{CF}_3\text{CH}(\text{CH}_3)\text{CH}_2\text{CH}_2\text{I}$	$\text{CF}_3\text{CH}(\text{CH}_3)\text{CH}_2\text{CH}_2\text{OH/H}_3\text{PO}_4/\text{KI}$	40
$n\text{-C}_5\text{F}_{11}\text{CH}_2\text{I}$	$n\text{-C}_5\text{F}_{11}\text{CH}_2\text{O-p-tosyl/NaI}$	35
		27
No reaction under conditions used		27
		44,84
		10

### Telomerisation reactions of Polyfluoroalkyl iodides

The term 'telomerisation' was first used in 1942 by Hanford and Joyce<sup>106</sup> and defined by them as:-

"The process of reacting together under polymerisable conditions, a molecule YZ, which is called a "telogen" (chain transfer agent), and more than one unit of a polymerisable compound A, having ethylenic unsaturation called a "taxogen" to form products called "telomers" having the formula  $Y(A)_nZ$ , where n is an integer greater than one, and Y and Z are fragments of the telogen attached to the terminal taxagens". The term telomerisation reaction has now come to include reactions with olefins which do not appear to homopolymerise and also some of the reactions in which only the 1:1 adducts are obtained.

Telomerisation reactions initiated by i) having present in the system organic free radical initiators, ii) irradiation (U.V., X-rays,  $\gamma$  -rays.), or iii) heat. The accepted mechanism for the process is as follows:-

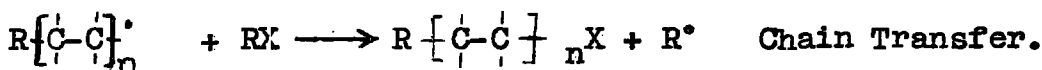
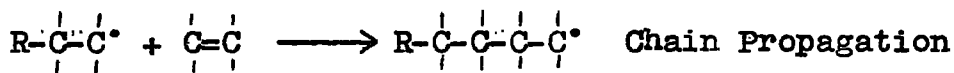
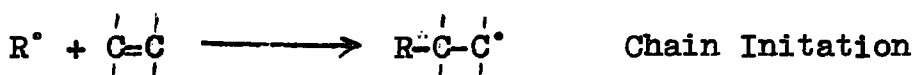

The propagation and chain transfer steps compete and it is the result of this competition which dictates the average chain length.

### Factors influencing telomerisation reactions.

In discussing these factors, a chain transfer agent of formula RCFXY (R = polyhalogenoalkyl group or F, X = halogen or hydrogen, Y = halogen of higher molecular weight than X) will be considered.

Basically, there are only two factors which influence the course of telomerisation reactions,

i) the ease of homolytic fission of the C-Y bond in RCFXY.

ii) the affinity of the olefin for RCFX<sup>•</sup> compared with its affinity for RCFX(olefin)<sup>•</sup>.

These points must be enlarged upon. While the four reactions, primary radical formation, chain initiation, chain propagation and chain transfer, proceeding in a telomerisation process are obviously interrelated, it is convenient to discuss each in turn.

### Primary Radical Formation.

This depends upon the strength of the C-Y bond and hence the stability of the radical produced by its fission;

the weaker the C-Y bond, the greater the ease of generation of the radical. The identity of both X and Y influence the strength of the C-Y bond which, for a given X, decreases in the series  $Y=F>Cl>Br>I$ , and which has been predicted to decrease in the series

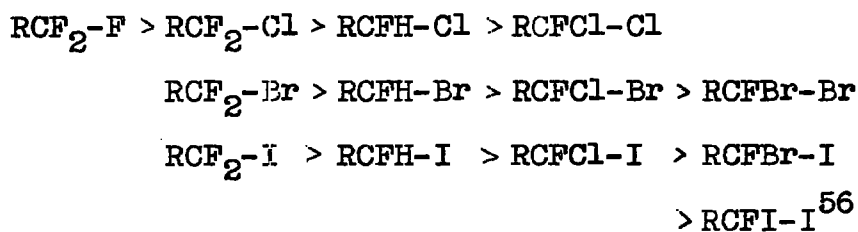

In general, the stability of radicals increases in the order primary<secondary<tertiary where these terms refer to the number of atoms or groups other than hydrogen on the carbon atom formally carrying the free electron.<sup>31,51</sup> This order may vary if for example a secondary radical bears groups with a powerful stabilising effect e.g. Cl, Br, I, which a tertiary radical has groups with a weak stabilising effect, e.g. F, alkyl. Haszeldine<sup>102</sup> correlates the position of the absorption maximum in the ultra-violet spectra of polyhalogenoalkyl iodides with the stability of the radicals produced by the fission of the C-I bond. He suggests that the stability of the R· radical is the most important factor in determining the position of the absorption maximum; the more stable the radical, the further into the red will be the absorption maximum of its iodide. If this

suggestion is accepted, and it seems reasonable to do so,\* his results show that for halogen substituted on the  $\alpha$ -carbon atom, the shifts to the red increase in the order  $H < F < Cl < Br < I$  and with the number of halogen atoms. Shifts to the red increase in this same order, though to a smaller extent, when halogens are substituted on the  $\beta$ -carbon atom. Since increased resonance stabilisation in alkyl iodides parallels bathochromic shifts, it is argued that increased bathochromic shifts parallel increased resonance energy in polyhalogenoalkyl radicals. This leads to the conclusion that resonance stabilisation in a radical,  $RCHX\cdot$ , increases in the series  $X=H < F < Cl < Br < I$ . This is the reverse of what is the accepted order for the mesomeric effect of halogens.<sup>130</sup> It might be argued that the order of stabilisation quoted by Haszeldine is attributable to steric effects but in fact he puts forward a strong case in favour of steric effects being of only minor importance in determining radical stabilities.

---

\* In the alkyl iodide series, RI, the bathochromic shifts run parallel to the ionisation potentials of the alkyl radical, the dissociation energy of the carbon-iodine bond, the resonance energy of the hydrocarbon radicals and the stabilisation energy of the radicals relative to the methyl radical. R-Br and R-H bond dissociation energies vary in the same way.

Although it is clear that the stability of a polyhalogenoalkyl radical,  $\text{RCFX}^\bullet$ , increases as  $\text{X}=\text{H} < \text{F} < \text{Cl} < \text{Br} < \text{I}$ , if this increased stability is attributed to increased resonance stabilisation, then the mesomeric effect in radicals must operate in a manner different to that in other systems.

### Initiation

Once the radical  $\text{RCFX}^\bullet$  has been generated, attack on the olefin depends upon the susceptibility of the olefin towards that radical rather than upon its reactivity (i.e. the ability of the lone electron to become delocalised).

Fluorocarbon radicals behave to some extent as electrophilic reagents and hydrocarbon radicals behave as weak nucleophilic reagents. Thus it has been shown that  $\text{C}_2\text{F}_4$ , an olefin susceptible to nucleophilic attack (see page 5), has ten times the methyl affinity of  $\text{C}_2\text{H}_4$ .<sup>108</sup> It was also shown that  $\text{C}_2\text{F}_4$  has a much lower trifluoromethyl affinity than  $\text{C}_2\text{H}_4$ <sup>107</sup> in spite of the fact that  $\text{C}_2\text{F}_4$  is intrinsically more reactive than  $\text{C}_2\text{H}_4$ . The reactivity of the trifluoromethyl radical towards olefins increased in the series  $\text{C}_2\text{H}_4 < \text{C}_3\text{H}_6 < \text{iso-C}_4\text{H}_8$  and also became more specific in its attack. This again demonstrates the electrophilicity of the radical for normally an

increase in reactivity is associated with a decrease in selectivity. Polar effects cannot be the only influences at work for if so, the methyl affinity of  $C_2Cl_4$  would be expected to be higher than that of  $C_2H_4$ . In fact this is not so and therefore it must be concluded that steric effects are also operative.<sup>108</sup> The fact that steric effects tend to make an olefin less reactive towards a free radical than would be expected from other considerations is quite general.

Haszeldine<sup>27</sup> as a result of many telomerisation reactions drew up the following order for the ease of radical attack on fluoroolefins:-

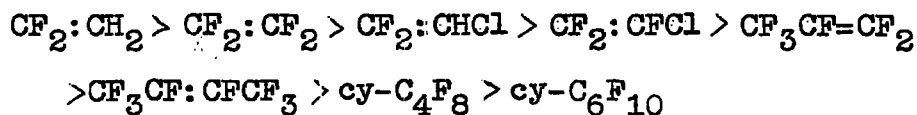

### Propagation

This step is in competition with the chain transfer step and its efficiency depends upon:-

- a) the ease of polymerisation of the olefin.
- b) the susceptibility of the olefin towards the intermediate free radical  $RCFX(\text{olefin})^\bullet$  compared with that of  $RCFXY$  towards this same radical.
- c) The stability of  $RCFX(\text{olefin})Y$ .

a) An olefin which reacts readily with fragments of a decomposing peroxide or other free radical initiator to give a polymer of high molecular weight will in general give a longer chain telomer with RCFXY than one which does not. However, as already mentioned, the ease with which a series of olefins homopolymerise is not necessarily in the same order as the susceptibility to radical attack e.g.  $C_2F_4$  is more easily homopolymerisable than  $CF_2:CH_2$  yet  $CF_2:CH_2$  is more susceptible to fluorocarbon radical attack.

b) Whether a radical  $RCFX(olefin)^\bullet$  attacks an olefin molecule or another molecule of chain transfer agent depends upon the susceptibility of that olefin towards radical attack and the C-Y bond strength in RCFXY. If the olefin is susceptible to radical attack and the C-Y bond is strong then long chains will be produced for the propagation step will be more efficient than the chain transfer step. If on the other hand, the C-Y bond is weak and the olefin is not particularly susceptible to radical attack, short chains will be produced for here the chain transfer step is the more efficient.

c) If the C-Y bond in the telomers  $RCFX(olefin)Y$  is weak, then it will be ruptured and assuming the olefin to be susceptible to attack by radicals, further attack upon

molecules of unreacted olefin will occur leading to the formation of high molecular weight telomers.

### Chain Transfer

As already mentioned, this step is in competition with the propagation step and its efficiency depends upon:-

- a) The C-Y bond strength in RCFXY (see 'b' above)
- b) The relative concentration of the olefin and chain transfer agent.

A reaction in which the propagation step is efficient can be moderated to yield low molecular weight telomers by having present in the system a large excess of chain transfer agent. Conversely, reduction of the amount of telogen in the system leads to high molecular weight telomers.

### Isomer formation by free radical attack on unsymmetrical fluoro-olefins

Until a few years ago free radical additions to unsymmetrical fluoro-olefins were thought to yield single products. For example, Lovelace, Rausch and Postelnek<sup>111</sup> proposed an empirical rule which predicts the structure of the products of addition of perhalogenoalkyl radicals to polyfluoro-olefins. Several cases compiled from the literature were cited. Haszeldine and Steele in 1957,<sup>31</sup>

however, demonstrated that the addition of either trifluoromethyl radicals or bromine atoms to trifluoroethylene gives isomeric products. These workers took issue with Tarrant, Lovelace and Lilyquist<sup>109</sup> who had reported  $\text{CF}_2\text{BrCHF}\text{CF}_2\text{Br}$  as the sole product of the reaction of dibromodifluoromethane with trifluoroethylene, contending that the product is not a pure compound but an isomeric mixture of  $\text{CF}_2\text{BrCHF}\text{CF}_2\text{Br}$  (ca. 80%) and  $\text{CF}_2\text{BrCF}_2\text{CHFBr}$  (ca. 20%). Miller in 1959<sup>34</sup> showed that radical addition to trifluoroethylene was bidirectional. Coscia<sup>110</sup> has recently repeated the reaction described by Tarrant<sup>109</sup> and his results confirm the findings of Haszeldine. Although it now seems likely that all radical additions to unsymmetrical fluoro-olefins are bidirectional to some extent,<sup>28</sup> it is only in the cases of trifluoroethylene<sup>31,110,112</sup> and hexafluoropropene<sup>112,113,114</sup> that both isomers can be produced in comparable amounts.

TABLE 2

Showing the direction of radical attack on trifluoroethylene

	$\overset{*}{\text{C}}\text{HF}=\overset{*}{\text{C}}\text{F}_2$		<u>Reference</u>
	Attack(%) on starred carbon atom		
$\text{CF}_3\text{S}\cdot$	98	2	112
$\text{CH}_3\text{S}\cdot$	75	25	112
$\text{SF}_5\cdot$	100	0	113
$\text{CF}_2\text{Br}\cdot$	80	20	31
$\text{Br}\cdot$	58	42	31

TABLE 3

Showing the direction of radical attack on  
hexafluoropropene

$$\text{CF}_3\overset{*}{\text{C}}\text{F} = \overset{*}{\text{C}}\text{F}_2$$

	Attack (%) on starred Carbon Atom		Reference
MeS·	9	91	112
CF <sub>3</sub> ·	20	80	114
	8	92	28
CF <sub>3</sub> CH <sub>2</sub> S·	30	70	112
PH <sub>2</sub> ·	34	66	114
SF <sub>5</sub> ·	50	50	113
CF <sub>3</sub> S·	55	45	112

Several factors have been considered as determining the direction of radical additions to olefins. Amongst these are steric factors, polar factors and the stability of the intermediate free radicals. Based on studies of the ultra-violet catalysed addition of hydrogen bromide and trifluoroiodomethane to a series of olefins (mostly fluoro-olefins) Haszeldine and co-workers<sup>73</sup> concluded that the steric and polar effects are of minor importance and that the direction of addition is determined primarily by the stabilities of the two possible free radicals. This concept of intermediate free radical stability explains all the reactions in which addition is unidirectional or largely so.

The lone exception to this is the case of 2-H pentafluoropropene to which trifluoroiodomethane and hydrogen bromide add in opposite directions.<sup>52</sup> In the cases where both isomers are formed, other effects must be considered.

The results reported in table 2 and table 3 will now be considered from two related aspects; i) the reactivity of the attacking free radical (i.e. the extent to which delocalisation of the free electron occurs) and the expected specificity of attack on the olefin; ii) the nucleophilic or electrophilic character of the attacking radical, taken in conjunction with the susceptability towards nucleophilic or electrophilic attack of the olefin being attacked.

Considering i), one would expect that the more reactive the radical, the less discriminating it would be in its position of attack on an olefin. Thus in the case of hexafluoropropene, the more reactive the attacking radical, the greater should be the extent of attack on the CF group compared with attack on the CF<sub>2</sub> group (sterically more favoured and leading to the formation of the more stable radical). Examining the results in table 4 shows that this is not observed. The more reactive the radical (cf. CF<sub>3</sub>S• and CH<sub>3</sub>S•; SiH<sub>3</sub>• and Me<sub>3</sub>Si•) the more discriminating it seems to become. Reactivity in this sense thus has its effect mainly upon the rate of reaction.

As regards ii), in the additions of thiols to hexafluoropropene, an olefin susceptible to nucleophilic attack, it is possible to make a correlation between the product distribution and relative electrophilicities of the thiyl radicals. Although no quantitative electrophilicity data seem to be available, consideration of the comparative inductive effects of  $\text{CF}_3^-$ ,  $\text{CF}_3\text{CH}_2^-$ , and  $\text{CH}_3^-$  groups leads to the conclusion that the relative electrophilicities of the three thiyl radicals involved is in the order  $\text{CF}_3\text{S}\cdot > \text{CF}_3\text{CH}_2\text{S}\cdot > \text{CH}_3\text{S}\cdot$ . This is in the same order as the occurrence of the isomer unexpected by consideration of the radical stabilities alone, the formation of which requires the attachment of the radical to the negatively charged carbon atom of the double bond.

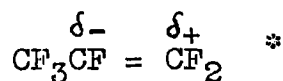

The isomer ratios obtained in the additions of trifluoromethanethiol and methanethiol to trifluoroethylene can also be correlated with the relative electrophilicities of the thiyl radicals. The more electrophilic  $\text{CF}_3\text{S}\cdot$  radical should be more inclined to attack the negative carbon atom in trifluoroethylene, thus further favouring the isomer

---

\* It is assumed that the polarisation of hexafluoropropene is the same in radical additions as ionic additions (see page 6).

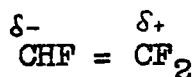

which in this case is favoured on the basis of intermediate radical stability.

It seems then that relative stabilities of the two possible intermediate free-radicals is the main factor which governs the direction of radical addition to unsymmetric fluoro-olefins but that when the possible intermediate radicals have similar energy and that steric requirements do not differ greatly, the product or mixture of products may be determined by the electronic character of the attacking radical.

### Telomerisation reactions initiated by free-radical initiators

So far, discussion has ignored telomerisation reactions initiated by organic free radical initiators. When these are employed, the reaction follows the course:-

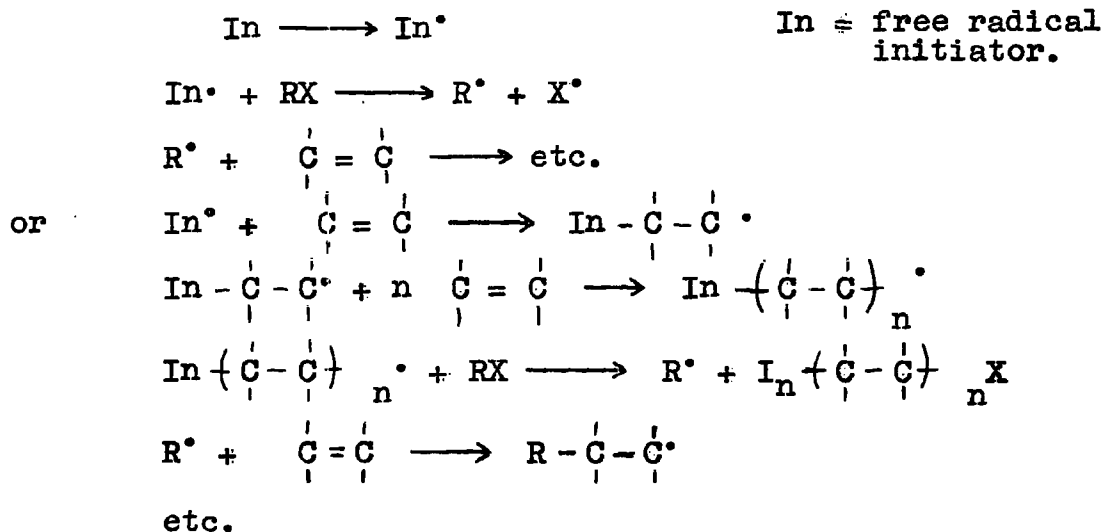

Only small amounts of initiator are added to the reactants and therefore only small amounts of compounds of the type  $\text{In} \left\{ \overset{\cdot}{\text{C}} - \overset{\cdot}{\text{C}} \right\}_n \text{X}$  are present in the reaction product.

Many reactions will not proceed without the use of free radical initiators. The reason why a radical  $\text{R}^\bullet$  generated in this way can initiate the telomerisation process whereas the same radical generated by other methods will not react is obscure.

Thermal telomerisation of hexafluoropropene and other olefins which are difficult to homopolymerise.

Hex<sub>a</sub>fluoropropene has been copolymerised with polyfluoro-olefins<sup>117,119,120,122,123</sup> and hydrocarbon olefins<sup>118,120</sup> as well as ethylene oxide,<sup>121</sup> but until 1960 when Eleuterio<sup>124</sup> using very drastic conditions was successful, efforts to homopolymerise hexafluoropropene by a radical mechanism lead only to the production of dimers,<sup>125,126</sup> trimers,<sup>50,127</sup> tetramers<sup>50,127</sup> and pentamers.<sup>50,127</sup> It was because of this difficulty in homopolymerising hexafluoropropene that Hauptschein in 1957<sup>57</sup> proposed a stepwise mechanism for the thermal 'telomerisation' of hexafluoropropene (and other non-homopolymerisable olefins) with polyfluoroalkyl iodides. He proposed that if radicals are formed, they add simultaneously to the double bond, but suggests that in fact the radicals may not be formed at all and that the adduct is produced by

way of a transition complex.

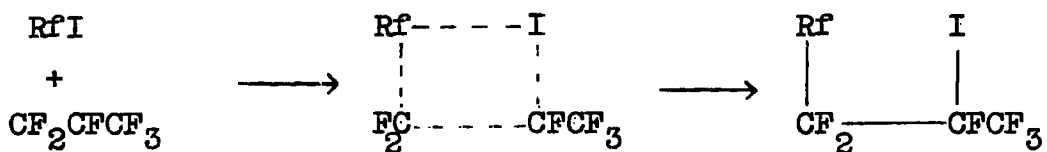

The 1:1 adduct adds to a second molecule of hexafluoropropene by a similar mechanism. Repetition of this process gives rise to higher telomers.

Table 4 summarises radical reactions between poly-fluoroalkyl iodides and fluoro-olefins.

TABLE 4Radical reactions of polyfluoroalkyl iodides  
with fluoro-olefins

<u>Olefin</u>	<u>Iodide</u>	<u>References</u>
CH <sub>2</sub> :CHF	CF <sub>3</sub> I	49
	CF <sub>2</sub> :CFI	30
CH <sub>2</sub> :CF <sub>2</sub>	CCl <sub>3</sub> I	59
	CFCl <sub>2</sub> I	34, 59
	CF <sub>3</sub> I	18, 58
	C <sub>2</sub> F <sub>5</sub> I	52
	n-C <sub>3</sub> F <sub>7</sub> I	58, 77
	CF <sub>2</sub> ClCFClI	28, 58
	C <sub>2</sub> F <sub>5</sub> CFICF <sub>3</sub>	58
	CF <sub>2</sub> :CHI	132
	CF <sub>2</sub> :CFI	30
	CF <sub>2</sub> :CClI	132
	C <sub>4</sub> F <sub>9</sub> CFI·CF <sub>3</sub>	58
	CF <sub>2</sub> ClCFI·CF <sub>3</sub>	58
	CHF:CF <sub>2</sub>	CFCl <sub>2</sub> I
CF <sub>3</sub> I		31
C <sub>2</sub> F <sub>5</sub> I		42
iso-C <sub>3</sub> F <sub>7</sub> I		42
CF <sub>2</sub> ClCFClI		33
CF <sub>2</sub> :CFI		30
CF <sub>2</sub> :CClI		132

$\text{CF}_2:\text{CHCl}$	$\text{CF}_3\text{I}$	73
	$\text{CF}_2:\text{CFI}$	30
	$\text{CF}_2\text{ClCFClI}$	132***
$\text{CF}_2:\text{CFCl}$	$\text{CF}_3\text{I}$	45****, 46, 74
	$\text{CF}_2\text{ClCFClI}$	28, 56, 57
	$\text{C}_2\text{F}_5\text{CFClI}$	46
	$\text{CF}_2\text{CHI}$	132
$\text{CF}_2:\text{CF}_2$	$\text{CF}_3\text{I}$	6, 47, 54, 55
	$\text{C}_2\text{F}_5\text{I}$	47, 78, 103
	$n\text{-C}_3\text{F}_7\text{I}$	103
	$\text{iso-C}_3\text{F}_7\text{I}$	42, 103, 104
	$\text{CF}_2\text{ClCFClI}$	57, 79
	$\text{CF}_2\text{ClCFI}\cdot\text{CF}_3$	104
$\text{CH}_2:\text{CFCl}$	$\text{CF}_2\text{ClCFClI}$	33
$\text{CF}_2:\text{CCl}_2$	$\text{CF}_2:\text{CFI}$	30
$\text{CF}_2:\text{CHCH}_3$	$\text{CF}_3\text{I}$	51
	$\text{CF}_2\text{ClCFClI}$	33
$\text{CH}_2:\text{CHCF}_3$	$\text{CCl}_3\text{I}$	65
	$\text{CF}_3\text{I}$	67, 72, 100
	$\text{CF}_2\text{ClCFClI}$	33
$\text{CF}_2:\text{CHCF}_3$	$\text{CF}_3\text{I}$	52
	$n\text{-C}_3\text{F}_7\text{I}$	52
	$\text{CF}_2\text{ClCFClI}$	33***
$\text{CF}_2:\text{CFCF}_3$	$\text{CF}_3\text{I}$	28, 50, 57
	$\text{C}_2\text{F}_5\text{I}$	42

$\text{CF}_2:\text{CFCF}_3$	$n\text{-C}_3\text{F}_7\text{I}$	28,57
	$\text{iso-C}_3\text{F}_7\text{I}$	42***
	$\text{CF}_2\text{ClCFClI}$	33***,57
	$\text{C}_2\text{F}_5\text{CFI}\text{CF}_3$	50
	$n\text{-C}_3\text{F}_7(\text{C}_3\text{F}_6)_{1,2}\text{I}$	57
$\text{CH}_2:\text{C}(\text{CF}_3)(\text{CH}_3)$	$\text{CF}_2\text{ClCFClI}$	33
$\text{CH}_2:\text{CF}\cdot\text{C}_2\text{F}_5$	$\text{CF}_3\text{I}$	97
$\text{CH}_2:\text{C}(\text{CF}_3)_2$	$\text{CF}_3\text{I}$	51
$\text{CH}_2:\text{C}(\text{CF}_2\text{Cl})(\text{CF}_3)$	$\text{CF}_3\text{I}$	51
$\text{CF}_3\text{CF}:\text{CFCF}_3$	$\text{CF}_3\text{I}$	27
$\text{cy-C}_4\text{F}_8$	$\text{CF}_3\text{I}$	27
	$\text{CF}_2\text{ClCFClI}$	81
$\text{cy-C}_6\text{F}_{10}$	$\text{CF}_3\text{I}$	53**
	$\text{iso-C}_3\text{F}_7\text{I}$	53***
	$\text{CF}_3\text{I}$	53*

Polyfluoroalkyl iodides have been used as chain transfer agents in the telomerisation of many hydrocarbon unsaturated systems. For reports on these reactions references 49, 60-64, 100, 115 and 132 should be consulted.

\* Only one  $\text{CF}_3\text{I}$  added.

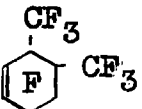
\*\*  was the main product in this reaction.

\*\*\* Reaction failed under conditions used.

\*\*\*\* Wrong direction of addition reported cf. 46 and 74.

## REACTIONS OF POLYFLUOROiodoALKANES

One of the main reactions of polyfluoroiodoalkanes, telomerisation, has already been discussed in some detail. Even so, the value of this reaction as a method of preparing iodides has not been discussed. There follows now a brief review of the other reactions of polyfluoroiodoalkanes. Every reaction involving these valuable compounds cannot be mentioned but it is hoped that the reader will obtain an idea of the sort of reactions which they will undergo and the range of polyfluoroaliphatic compounds which can be made from them. Some of the reactions mentioned here will be discussed in greater detail in the next chapter. For a fuller review of the preparation (and reactions) of polyfluoroalkyl derivatives of metals and non-metals involving the use of polyfluoroiodoalkanes, there exist excellent articles by Lagowski,<sup>139</sup> Emelius,<sup>138</sup> Banks and Haszeldine,<sup>158</sup> and Clark.<sup>159</sup>

Chemically, the polyfluoroiodoalkanes are very different from their hydrocarbon analogues. Whereas in iodoalkanes the C-I bond is polarised in such a way as to cause nucleophilic attack on the carbon, in polyfluoroiodoalkanes the polarisation causes nucleophilic attack to be on the iodine.

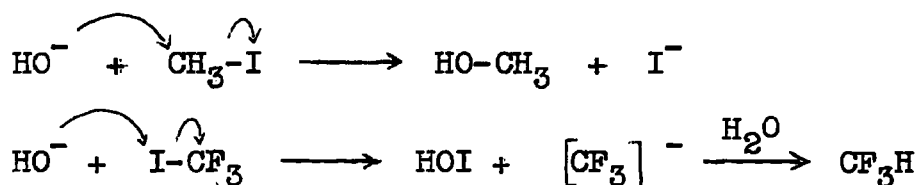

Thus on alkaline hydrolysis of perfluoroiodoalkanes, the iodine is replaced by hydrogen<sup>137</sup> rather than by a hydroxyl group as in the case of alkyl iodides. Should there be hydrogen on the carbon atom  $\beta$ - to the iodine-bearing carbon, hydrogen iodide is removed when the compound is treated with a wide variety of weak and strong bases<sup>55</sup> and nucleophiles<sup>77</sup> in general. If however, the nucleophile is a nitrite ion derived from silver nitrite, an acid is produced rather than the olefin.<sup>77</sup>

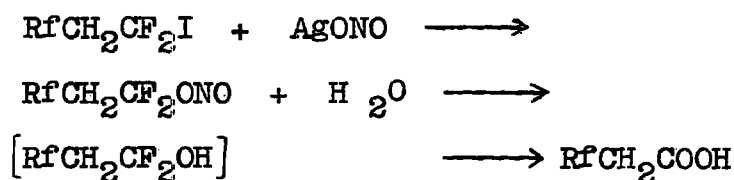

Polyfluoroiodoalkanes react with both chloro-<sup>140</sup> and fluorosulphonic<sup>141</sup> acids to yield the corresponding chloro- or fluorosulphonates. These compounds react with water, sodium hydroxide, ethanol and ammonia to form products that are accounted for by the scheme:-

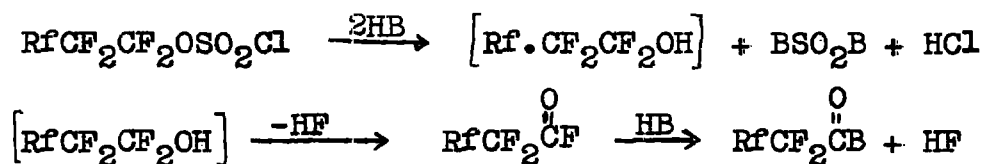

When B corresponds to OH, ONa,  $\text{OC}_2\text{H}_5$  and  $\text{NH}_2$ , the products are  $\text{RfCF}_2\text{COOH}$ ,  $\text{RfCF}_2\text{COONa}$ ,  $\text{RfCF}_2\text{COOC}_2\text{H}_5$  and  $\text{RfCF}_2\text{CONH}_2$  respectively.

Polyfluoroiodoalkanes having the end group  $-\text{CF}_2\text{CH}_2\text{I}$  can be converted into olefins by elimination of iodine and fluorine using zinc and glacial acetic acid.<sup>176</sup> Iodine and fluorine can be eliminated from iodides with end-group  $-\text{CF}_2\text{CF}_2\text{I}$  using butyl-lithium<sup>91</sup> (see p. 37) but the yield of olefin is very low if there are more than three carbon atoms in the chain.

The iodine in polyfluoroiodoalkanes can be replaced by fluorine using antimony trifluorodichloride,<sup>77</sup> hydrogen fluoride,<sup>97</sup> cobalt trifluoride<sup>57,184</sup> and mercurous fluoride,<sup>52</sup> and by chlorine by direct chlorination with chlorine gas under the influence of ultra-violet radiation<sup>77</sup> or heat.<sup>184,77</sup> This latter reaction can lead to the formation of an olefin by dehydroiodination if the iodide possesses the end-group  $-\text{CH}_2\text{CF}_2\text{I}$ .<sup>77,97</sup>

The replacement of iodine in polyfluoroiodoalkanes by hydrogen can be accomplished by treating the iodide with lithium aluminium hydride.<sup>174</sup> This reaction proceeds via the formation of the complex  $\text{LiAl}(\text{Rf})\text{H}_2\text{I}$  which on hydrolysis by water at  $0^\circ\text{C}$ . yields the hydro-compound.



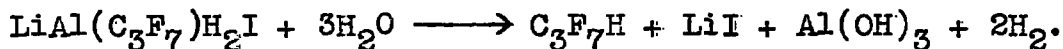

Zinc and sulphuric acid too has been successful in replacing iodine by hydrogen.<sup>52</sup> Hydrolysis of polyfluoroalkyl zinc iodides and Grignard reagents (see page 38) can also be used as methods of replacing iodine by hydrogen.

Polyfluoroiodoalkanes undergo Wurtz-type condensation reactions. These reactions are best carried out by subjecting the iodide to ultra-violet radiation in the presence of mercury.<sup>25,46,55,184</sup>

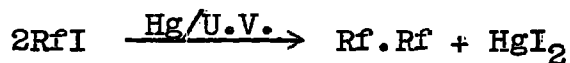

If however the iodide concerned is  $\text{CF}_3\text{I}$  or  $\text{C}_2\text{F}_5\text{I}$ , then the mercurial is formed<sup>15</sup> (see page 38). These same coupled compounds are produced when iodides are treated with zinc and acetic anhydride/methylene chloride mixture,<sup>26,182,184</sup> zinc and dioxane,<sup>46,170</sup> or yellow mercuric oxide and heat.<sup>184</sup>

The use of polyfluoroiodoalkanes in the preparation of polyfluoroalkyl derivatives of the elements.

Polyfluoroiodoalkanes will not react directly with lithium to yield polyfluoroalkyl lithium derivatives<sup>15</sup> but these compounds can be prepared by halogen-metal interchange.

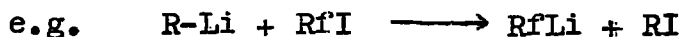

This exchange reaction takes place readily at low temperatures but in most cases, the lithium derivative decomposes at temperatures not much higher than the temperature of formation with the production of lithium fluoride (or chloride).<sup>91</sup>

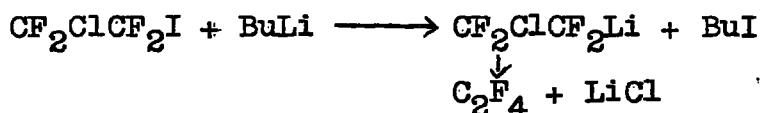
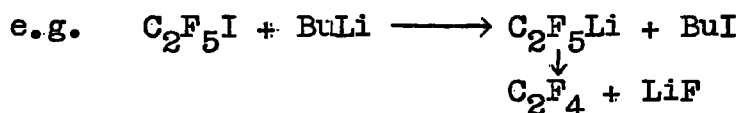

When the reaction is carried out with trifluoroiodomethane, tetrafluoroethylene is produced.<sup>142</sup> This is probably formed by way of a difluorocarbene.

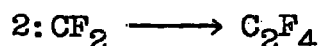
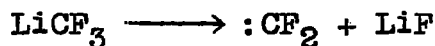

The lithium compounds derived from heptafluoro-1- and -2-iodopropanes are rather more stable and have been used in some reactions akin to those of Grignard reagents.<sup>91,142,167,172</sup>

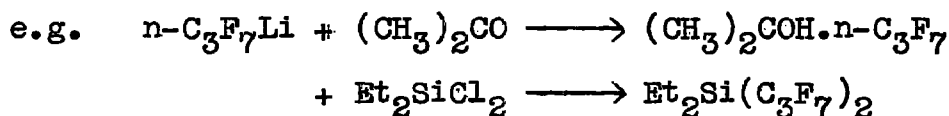

Grignard reagents are prepared by the direct action of the iodide on magnesium in a basic solvent but may also be prepared by an exchange reaction between the iodide and

phenyl magnesium bromide.



The reactions of these Grignard reagents are analogous with those of the corresponding hydrocarbon Grignard reagent.<sup>91,168,169,172.</sup>

Both heptafluoroiodopropanes form zinc compounds in dioxane and other solvents.<sup>91,170-172</sup> Solutions of these compounds are thermally stable and resistant to attack by carbon dioxide and oxygen, but they are readily hydrolysed, cleaved by halogens and converted to olefins by pyrolysis.

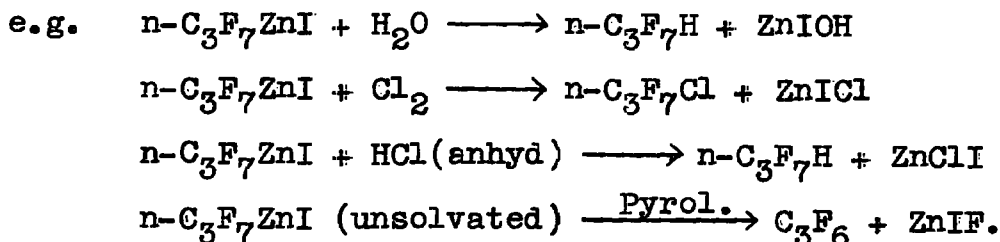

Some polyfluoroalkylmercuric iodides are prepared by direct action of the iodide on mercury under the influence of ultra-violet radiation.<sup>15</sup> But in fact

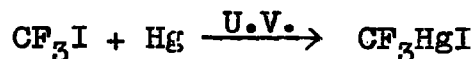

many of these compounds cannot be isolated because the coupled compound and mercuric iodide are formed.<sup>25,46,184</sup>

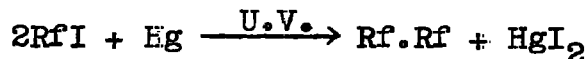

Bispolyfluoroalkyl mercury compounds are prepared by

treating the iodide with cadmium amalgam.<sup>173</sup>

Polyfluoroiodoalkanes do not react with group III elements to form polyfluoroalkyl derivatives.

Elemental Silicon reacts with polyfluoroiodoalkanes (and other halides) in the presence of copper to yield bispolyfluoroalkyldiiodides.<sup>143</sup>

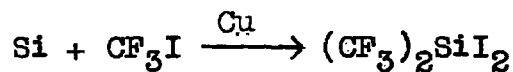

In the same way as they add to simple olefins, polyfluoroiodoalkanes react with alkenylsilicon compounds.



Perfluoroalkyl-germanium compounds have been prepared by the reaction between trifluoroiodomethane and germanium(II) iodide. The main reaction product was trifluoromethyltriodogermane,  $\text{CF}_3\text{GeI}_3$ .

The tin-tin bond in hexaalkylditin and lead-lead bond in hexaalkyldilead compounds are cleaved when these compounds are treated with perfluoroiodoalkanes under the influence of ultra-violet radiation or heat to yield perfluoroalkyltrialkyltin and lead compounds respectively.<sup>145, 146, 148, 149.</sup>

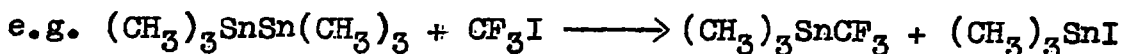

It is probable that these reactions proceed by a chain mechanism thus:-

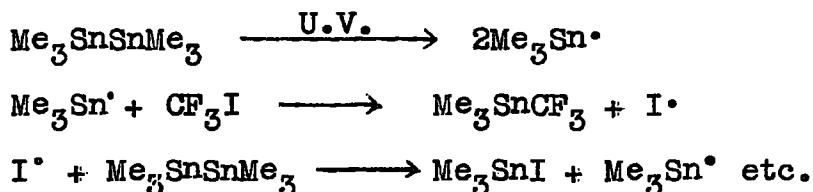

This view is supported by the observation<sup>151</sup> that hexamethyldigermane and hexamethyldisilane, where the Ge-Ge and Si-Si bonds become progressively stronger than the corresponding bonds in hexamethylditin and hexamethyldilead, do not react under similar conditions with trifluoroiodomethane.

Trialkyl-lead-polyfluoroalkyl lead compounds can also be prepared by the ultra-violet irradiation of tetra-alkyl lead compounds with perfluoroiodoalkanes but yields here are low. A similar reaction with tetra-alkyl tin compounds yields trifluoromethane and only a trace of the desired product.<sup>149</sup> Compounds of the type  $\text{R}_2\text{SnRf}_2$  are prepared by treating dialkyltin dihalides with magnesium turnings and a perfluoroiodoalkane in tetrahydrofuran.<sup>150</sup> This reaction presumably proceeds via the formation of a Grignard reagent and therefore is limited to the formation of derivatives of perfluoroalkyl groups whose iodides form such reagents.

Reaction of a group V (M=P.As.Sb) element with

trifluoroiodomethane under pressure produces a mixture containing  $(\text{CF}_3)_3\text{M}$ ,  $(\text{CF}_3)_2\text{MI}$ ,  $\text{CF}_3\text{MI}_2$  and iodides of the element. Reaction occurs in the same temperature range 200-220°C, for phosphorus and arsenic but antimony reacts at a low temperature, 165-175°C. The higher temperatures seem to favour the formation of the tris-compound. Mixed alkyl (or aryl)-perfluoroalkyl compounds of phosphorus, arsenic or antimony can be made by heating trifluoroiodomethane with the trimethyl compounds of the element..

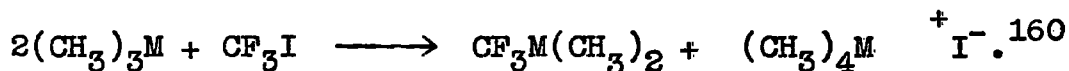

The corresponding reaction with trimethylamine however, results in the formation of large amounts of trifluoromethane together with tetramethylammonium iodide. Methyl-diiodoarsine and dimethyliodoarsine when treated with trifluoroiodomethane in the presence of mercury yields methyl-(bis-trifluoromethyl)-arsine and dimethyltrifluoromethylarsine respectively.<sup>161</sup> Cullen et. al.<sup>162,163</sup> have prepared many other compounds of this type by this same method.

Perfluoroalkyl derivatives of sulphur<sup>164,165,172</sup> and selenium<sup>166</sup> have been prepared by the direct action of a perfluoroiodoalkane with the elements at a high temperature. The reaction with sulphur yields mainly bis-perfluoroalkyl-disulphide with small amounts of tri- and tetra-sulphides, but no monosulphide. Selenium however yields only the

mono- and disulphides.

Metal carbonyls react with perfluoroiodoalkanes at 45°C. in benzene to give perfluoroalkyl metal carbonyl iodides. Such reactions have so far been successful with carbonyls of iron,<sup>175,178</sup> cobalt,<sup>177</sup> manganese,<sup>178</sup> and rhenium.<sup>178</sup>



Under similar conditions cyclopentadienylcobaltdicarbonyl reacts with perfluoroiodoalkanes to give  $\text{C}_5\text{H}_5\cdot\text{CO}\cdot\text{CoRfI}$ .<sup>177</sup>

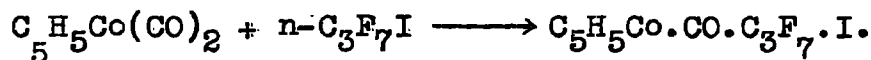

Polyfluorodiiodoalkanes have been used to prepare heterocyclic systems <sup>with</sup> sulphur,<sup>179</sup> selenium,<sup>181</sup> and arsenic<sup>180,181</sup> as the heteroatoms.

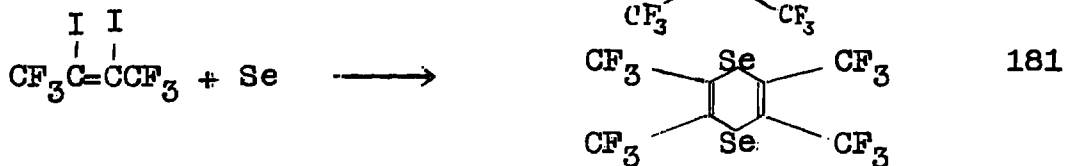
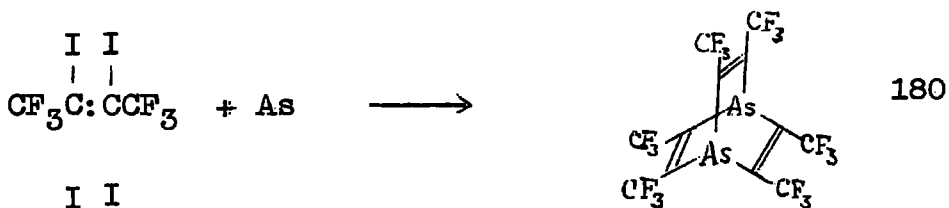
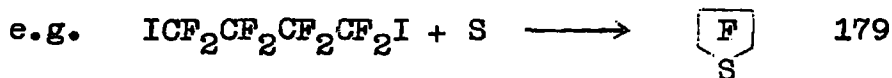

## FLUORINE CONTAINING POLYMERS

Polymers containing the elements of carbon, fluorine and only small amounts of hydrogen are extremely resistant to chemical attack and thermal degradation. This stability is attributable to the high carbon-fluorine bond dissociation energy, and to the shielding effect of the large fluorine atoms on the carbon skeleton.

Fluorine containing polymers can be divided into two main groups; homopolymers and co-polymers. The physical properties of a homopolymer are determined largely by the constitution of the monomer from which it is built, but can be varied to a small extent by varying the conditions under which the polymerisation is carried out e.g. the average molecular weight of polyhexafluoropropene increases as the pressure during the polymerisation increases.<sup>152</sup> The properties of a co-polymer can be varied over a wide range by altering the ratio of the two monomer units. It is a noteworthy fact that it is unnecessary for monomers employed in a co-polymerisation reaction to be homopolymerisable under the conditions of the reaction. A co-polymer of a non-homopolymerisable olefin and a homopolymerisable one can contain up to 50% of the non-homopolymerisable monomer.

Homopolymers of hydrofluoro-olefins have been studied and their thermal stability has been found to decrease in the order  $\text{poly-C}_2\text{F}_4 > \text{poly-CF}_2\text{:CH}_2 > \text{poly-CF}_2\text{:CHF} > \text{poly-C}_2\text{H}_4 > \text{poly-CH}_2\text{:CHF}$ .<sup>116</sup> Bro<sup>128</sup> has found that the order of resistance of these polymers to attack by amines is  $\text{poly-C}_2\text{F}_4 \approx \text{poly-C}_2\text{H}_4$  (unattacked)  $> \text{CH}_2\text{:CFH} > \text{CF}_2\text{:CH}_2 > \text{CF}_2\text{:CHF}$ . This order he explains is due to the increased withdrawal of electrons from the remaining C-H bonds as more and more hydrogen is replaced by fluorine i.e. the protonic character of the remaining hydrogen increases as successive fluorine atoms are introduced into the polymer. The stability of poly-tetrafluoroethylene (Teflon) is due to the absence of hydrogen in the polymer and the high shielding effect of the fluorine atoms.

The high thermal and chemical stability of poly-tetrafluoroethylene coupled with its self lubricating properties has resulted in its being, upto the present, the most used of fluorine containing polymers. The chief drawback to its greater use is that it is not a thermoplastic and therefore its fabrication is difficult and expensive.

The resinous nature of poly-tetrafluoroethylene can be reduced in two ways:-

- i) The tightly coiled polymer backbone can be

converted to a more mobile structure by the inclusion of methylene groups in the chain. The existence of methylene groups in such a chain also provides sites for cross-linking.

ii) Heterogeneity can be introduced into the polymer by the replacement of some of the fluorine atoms by bulky atoms or groups. Some polymers and co-polymers which have been prepared embodying these principles will now be briefly discussed.

Polyvinylidene fluoride is made up of alternating methylene and difluoromethylene groups.<sup>18</sup> The methylene groups reduce the rigidity of the carbon skeleton and establish sites for cross-linking but reduce the thermal and chemical stability of the polymer. Madorski and Straus<sup>129</sup> compared the thermal stability of poly-vinylidene fluoride with poly-tetrafluoroethylene and found the former to lose hydrogen fluoride and become stable above 520°C at 70% weight loss.

Trifluoroethylene undergoes radical attack at either end of the double bond and so the polymer must contain sequences such as:

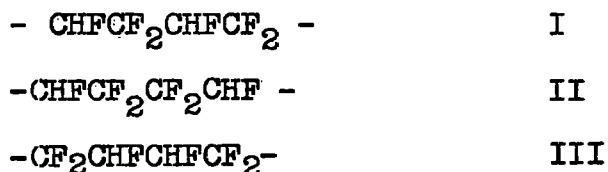

Haszeldine<sup>31</sup> has attributed the apparently anomalous position of poly-trifluoroethylene in the thermal stability series to structure III.

Poly-vinylfluoride consists of the repeating fundamental structure  $-\text{CFHCH}_2\text{CFHCH}_2-$ .

The only other simple fluorine containing homopolymers worthy of mention are poly-chlorotrifluoroethylene, (Kel-F), and poly-hexafluoropropene. Having a bulky chlorine atom in the polymer chain the structure is much less rigid than the highly crystalline poly-tetrafluoroethylene. The inclusion of chlorine in the chain reduces thermal and chemical stability but it does mean that Kel-F is a thermoplastic and therefore can be fabricated by all the usual techniques.

Despite considerable effort, hexafluoropropene has been homopolymerised only recently<sup>124</sup> (see page 28). At 300°C. and under 3,000-5,000 atmospheres in the presence of hydrogen-free initiators such as  $\text{CF}_3\text{SHgSCF}_3$ , hexafluoropropene homopolymerised to yield a highly stable thermoplastic. Polyhexafluoropropene retains the important electrical properties of polytetrafluoroethylene and the resistance to oxidising agent but its thermal stability is lower than that of polytetrafluoroethylene. Vacuum

pyrolysis of polyhexafluoropropene at 275°C. yields hexafluoropropene with only trace amounts of tetrafluoroethylene and perfluoro-iso-butene, showing the structure to be almost exclusively 'head-to-tail'. Also unlike polytetrafluoroethylene, polyhexafluoropropene is soluble in most common fluorocarbon solvents 'though insoluble in hydrocarbon solvents.<sup>153</sup>

The principle of introducing a bulky atom or group into the Teflon structure to make the resultant polymer thermoplastic was employed when tetrafluoroethylene and hexafluoropropene were co-polymerised to produce Teflon 100 -X.<sup>117</sup> This co-polymer retains most of the thermal and chemical stability of Teflon and is thermoplastic.

Chlorotrifluoroethylene has been copolymerised with vinylidene fluoride to yield Kel-F elastomer. This co-polymer has admirable physical properties as well as high temperature resistance to oils, fuels and nitric acid. Although it is exceptionally stable, the chlorine atoms are a source of some instability.<sup>131</sup> In 1957 this source of instability was removed when Dixon, Rexford and Rugg reported the co-polymerisation of hexafluoropropene with vinylidene fluoride<sup>122</sup> to produce "VitonA\*"<sup>134</sup>. Ferguson,

---

\* "Viton A" is the du Pont trade name for a co-polymer of hexafluoropropene and vinylidene fluoride".

using N-M-R has determined the structure of Viton and found it to be:-

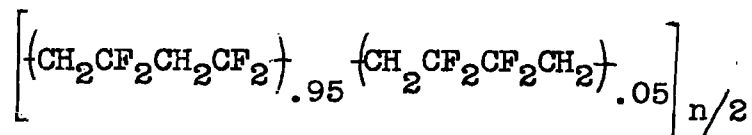
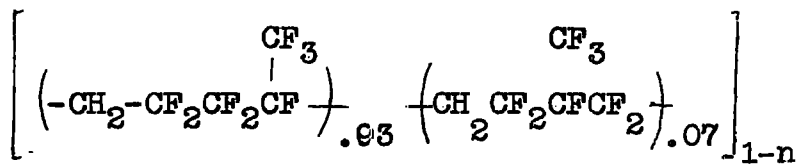

where n is the molar fraction of vinylidene fluoride. This structure was deduced on the assumption that Viton is a random linear co-polymer, except that there are no adjacent hexafluoropropene units.

#### Cross-linking of Viton A.

The high stability of Viton A renders cross-linking of the polymer a very difficult process. However, three main methods have been developed by which cross-links can be introduced into the elastomer. They are; the action of aliphatic amines, the action of high energy radiation and the action of peroxides. Of these, the most important is the action of amines.

Studies of the amine induced cross-linking mechanism have been carried out using the elastomer itself by Smith<sup>133</sup> and Paciorek et. al.<sup>135</sup> Both agree that the first step is dehydrofluorination but while Smith favours the explanation that double bonds thus formed in neighbouring chains interact to give the cross links, Paciorek supports the view that amine bridges bind the polymer chains together, except in the case of tertiary amines which cannot react with the double bonds produced by the dehydrofluorination reaction. In this case she agrees that interaction of the double bonds to produce cross links could be the process involved in the cross linking. Preliminary studies<sup>123</sup> carried out in these laboratories on the cross-linking of Viton using Viton/Methanol co-telomer suggest that amines are incorporated in the cross-linked polymer. Further work along these lines is being carried out.

In order to elucidate further the cross-linking mechanism, Paciorek<sup>97,136</sup> made some model compounds containing the elements of structure present in Viton, and investigated their reactions with amines. Further discussion of her work will be deferred until later. (page 81).

Chapter 2:

DISCUSSION OF EXPERIMENTAL WORK

## INTRODUCTION

Primarily the work has been to investigate the process involved in the cross-linking of Viton A, a co-polymer of hexafluoropropene and 1,1-difluoroethylene.<sup>133,135</sup> Previous work on this problem has involved experiments carried out on the co-polymer itself. The approach used in this work has been to prepare compounds which contain the elements of structure present in Viton, and then investigate their reactions with cross-linking agents. These cross-linking experiments were to be carried out by 'Yarsley Laboratories' but a preliminary investigation was carried out by the present author. This same approach was used by Paciorek et.al.<sup>97,136</sup> in work published during the course of the investigations reported in this thesis but 'model compounds' were prepared which, it is felt, do not represent the situation existing in Viton. This point will be discussed later.

Since hydrogen fluoride is eliminated during the cross-linking of Viton, it is to the  $-\text{CH}_2-$  groups that particular attention must be paid. Ferguson<sup>134</sup> has shown the predominating structure to be  $-\text{CF}_2\text{CF}(\text{CF}_3)\text{CH}_2\text{CF}_2\text{CH}_2\text{CF}_2-$ . It can be seen that there are two main types of methylene group; one which is adjacent to two difluoromethylene groups, and one which is adjacent to one difluoromethylene

group and a carbon atom bearing one fluorine atom and one trifluoromethyl group. The idea then was to prepare two model compounds, one containing a tertiary fluorine atom (i.e. a fluorine atom attached to a carbon atom bearing three perfluoroalkyl groups) and a corresponding one without and then to compare the ease of elimination of hydrogen fluoride. Alternatively, one compound which contained both systems was to be prepared and then its dehydrofluorination investigated.

#### Preparation of Model Compounds.

The first attempt to prepare compounds containing structures present in Viton was by coupling two different polyfluoroalkyl radicals. In particular attempts were made to couple  $\text{CF}_3\text{CH}_2\text{I}$  with  $n\text{-C}_3\text{F}_7\text{I}$  and  $(\text{CF}_3)_2\text{CFI}$  and so produce the alkanes

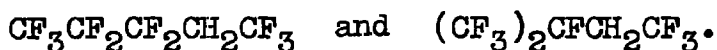

Polyfluoroiodoalkanes when subjected to ultra-violet radiation in the presence of mercury undergo a coupling reaction. In particular heptafluoro-1- and -2-iodopropanes undergo this reaction.<sup>11,12</sup>

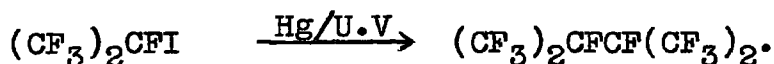

When trifluoroiodomethane and pentafluoroiodoethane are

treated in a like manner however, they yield mercurials.<sup>15</sup>

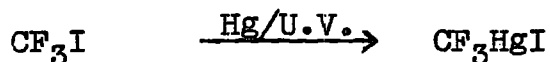

The ultra-violet irradiation of 1,1,1-trifluoroiodoethane in the presence of mercury had not been carried out, but since the C-I bond strength, as indicated by the iodine\*/iodide exchange experiments described elsewhere in this thesis (Chapter 4, p. 169), is of the same order as those of trifluoroiodomethane and pentafluoroiodoethane it was anticipated that the mercurial would be formed rather than the coupled compound. This is in fact the case, for 1,1,1-trifluoroethylmercuric iodide was found to be the main product with only a small amount of the coupled compound when this reaction was carried out. When a more powerful ultra-violet lamp was used, a greater amount of the coupled compound, 2H,2H,3H,3H-hexafluorobutane was produced. This demonstrates that in coupling reactions, the mercurial is the initial product but that this breaks down into radicals on further irradiation.

An attempt to couple 1,1,1-trifluoroiodoethane was made using yellow mercuric oxide but this proved unsuccessful. The iodide and yellow mercuric oxide were heated together as described by Hauptschein<sup>184</sup> but extensive decomposition occurred and much hydrogen fluoride was generated. It is

probable that this method of coupling is only satisfactory when there is no hydrogen present in the molecule.

When heptafluoro-2-iodopropane and 1,1,1-trifluoroiodoethane were irradiated together in the presence of mercury, perfluoro-(2,3-dimethylbutane) and 1,1,1-trifluoroethylmercuric iodide were obtained but none of the hoped for 2H,2H-decafluoro-(3-methylbutane).

In separate experiments, 1,1,1-trifluoroethylmercuric iodide and heptafluoro-2-iodopropane were heated and irradiated together in the hope that the reaction

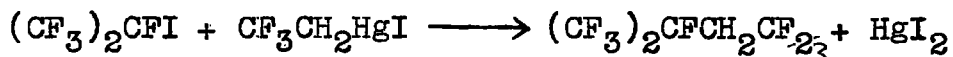

would occur. A trace of the desired compound was produced in the thermal reaction but the main reaction was one of decomposition as evidenced by the production of large amounts of hydrogen fluoride. Again it seems that the presence of hydrogen in the molecule leads to thermal instability. The ultra-violet irradiated reaction yielded only perfluoro-(2,3-dimethylbutane) and 1,1,1-trifluoroiodoethane.

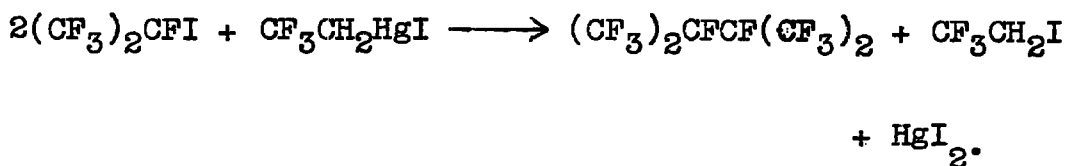



two tertiary fluorine atoms in the molecule. Corresponding compounds were made using  $C_2F_5I$  and  $n-C_3F_7I$  as starting materials so that their reactions with cross-linking agents could be compared with those of  $(CF_3)_2CFCH_2CF_2CF_2CH_2CF(CF_3)_2$ .

Some copolymerisation studies being carried out in these laboratories demanded the preparation of the olefins  $C_2F_5(CH_2CF_2)_nCH:CF_2$  and  $(CF_3)_2CF(CH_2CF_2)_nCH:CF_2$  ( $n = 0,1,2$ ). With this in mind, the dehydroiodination of the telomer iodides  $C_2F_5(CH_2CF_2)_{n+1}I$  and  $(CF_3)_2CF(CH_2CF_2)_{n+1}I$  was investigated.

#### Telomerisation reactions of 1,1-difluoroethylene

The first telomerisation reaction of vinylidene fluoride (1,1-difluoroethylene) was reported in 1954 when Haszeldine<sup>18</sup> irradiated it with trifluoroiodomethane. Chemical and ultra-violet spectroscopic data indicated that the  $CF_3$  radical had attacked the  $CH_2$ : end of the molecule exclusively. In 1955 the reaction between pentafluoroiodoethane and vinylidene fluoride was carried out, both thermal and ultra-violet initiation being used.<sup>52</sup> Only the 1:1 adducts were isolated and characterised. In 1958 Hauptschein et. al.<sup>58</sup> reacted several iodides, including trifluoroiodomethane and heptafluoro-1-iodopropane, with vinylidene fluoride using thermal initiation. The early

members of each series of telomers were isolated and characterised but in fact these materials were not pure isomers for later<sup>77</sup> the use of analytical G.L.C. showed that the composition of the simple heptafluoro-1-iodopropane-vinylidene fluoride adduct is 95 mole %  $C_3F_7CH_2CF_2I$ , and 5 mole %  $C_3F_7CF_2CH_2I$ . Surprisingly, it was found that the 1:2 adduct contains only one component.

Heptafluoro-2-iodopropane has not hitherto been used in reactions with vinylidene fluoride.

Reaction between vinylidene fluoride and pentafluoroiodoethane

The reaction was carried out using thermal initiation because the reaction can be performed on a larger scale than if ultra-violet initiation is used. The first three telomers were obtained reasonably pure by distillation. Analytical G.L.C. showed that in each of these fractions there was present a material with a retention time only slightly longer than that of the main component. The area of the small peak was  $1/20$  of that of the large peak, It is probable that this smaller peak was due to the isomers produced by the  $C_2F_5$  radical attacking the  $CF_2$  end of the olefin molecule. Although this small peak was not recorded on preparative scale chromatograms, pure samples of the isomers  $C_2F_5CH_2CF_2I$  and  $C_2F_5CH_2CF_2CH_2CF_2I$  were

obtained by recycling the materials through the apparatus several times using tricresyl phosphate as stationary phase and trapping out early cuts. This was only possible for the first two telomers because the 1:3 adduct has an impossibly long retention time at the highest temperature at which tricresyl phosphate can be used. Silicone elastomer was found to be of no value in resolving the two peaks. This is the first time that pure isomers of pentafluoroiodoethane-vinylidene fluoride have been isolated and characterised.

#### Reaction between vinylidene fluoride and heptafluoro-1-iodopropane

Again thermal initiation was used. A 1:1 molar ratio of reactants afforded a good yield of the 1:1 adduct and a sample of the pure isomer  $\text{CF}_3\text{CF}_2\text{CF}_2\text{CH}_2\text{CF}_2\text{I}$  was obtained by preparative G.L.C. Hauptschein<sup>58</sup> did not seem to be concerned with high yields of the 1:1 adduct for he used molar ratios of iodide:olefin of 1:2.3 and 1:3.7 and consequently obtained greater amounts of the higher telomers.

#### Reactions between vinylidene fluoride and heptafluoro-2-iodopropane

It has been found that these compounds react together under thermal conditions to produce telomer iodides in good yield. As in the case of pentafluoroiodoethane-vinylidene fluoride reactions, both isomers were observed,

being formed in the ratio 19:1. Pure samples of  $(CF_3)_2CFCH_2CF_2I$  and  $(CF_3)_2CFCH_2CF_2CH_2CF_2I$  were obtained but for the same technical reasons as already outlined, no pure isomers of higher telomers could be isolated.

Reaction between vinylidene fluoride and tetrafluoro-1,2-diiodoethane

In a thermal reaction between a 1:1 molar ratio of reactants a lower yield of telomers was obtained, only 39% of the diiodide being converted into telomers. This reaction was rather less 'clean' than those previously described for analytical G.L.C., showed there to be present in the reaction product small amounts of several compounds other than tetrafluoro-1,2-diiodoethane and the 1:1 adduct. A sample of the pure isomer  $ICF_2CF_2CH_2CF_2I$  was obtained pure by preparative G.L.C. The composition of the 1:1 adduct was estimated by analytical G.L.C. to be 95 mole %  $ICF_2CF_2CH_2CF_2I$  and 5 mole %  $ICF_2CF_2CF_2CH_2I$ . None of the 2:1 adduct was observed to be produced.

Some general considerations on the above mentioned telomerisation reactions

The results of the above experiments are summarised in table 5 below. The reaction between vinylidene fluoride and trifluoroiodomethane was carried out in these laboratories by Dr. R.H. Mobbs. The results of this experiment are

included for the sake of completeness.

TABLE 5

Molar Ratio	Temp.	Time (hrs)	Conv. of Iodide into Telomers	Mole % composition of telomers:					
				n=1	n=2	n=3	n=4	n=5	n=6
$\text{CF}_3\text{I}/\text{CH}_2\text{CF}_2$									
1 : 1	200	17	35%	46	33	14.5	5.5	1	
	+ 210	24							
$\text{C}_2\text{F}_5\text{I}/\text{CH}_2\text{CF}_2$									
1 1	190	45	55	92	6	2	-	-	
$n\text{-C}_3\text{F}_7\text{I}/\text{CH}_2\text{CF}_2$									
1 1	200	36	88	70	25	5	-	-	
$(\text{CF}_3)_2\text{CFI}/\text{CH}_2\text{CF}_2$									
1 1	185	36	88	90	10	trace	-	-	
1 1	820	36	90	87	13	"	-	-	
1 3	220	36	100	14	38	34	11	3	
1 4	220	36	100	2	21	29	26	18	4
$\text{ICF}_2\text{CF}_2\text{I}/\text{CH}_2\text{CF}_2$									
1 1	185	36	40	100					

Although the reaction between trifluoroiodomethane and vinylidene fluoride was not carried out under exactly the same conditions as the reactions between pentafluoroiodo-

ethane and the heptafluoroiodopropanes, table 5 illustrates that as the efficiency of the chain transfer agent decreases (i.e. as the C-I bond strength increases), the conversion of the iodide into telomers decreases, and, with the exception of  $C_2F_5I/CH_2CF_2$  (see page 176) the yields of higher telomers increases. Hauptschein<sup>58</sup> found that heating equimolecular amounts of trifluoroiodomethane and vinylidene fluoride in a Monel autoclave to 188°C. for 22 hours converted 80% of the iodide into telomers. The composition of the mixture of telomers that he obtained was n=1, 80; n =2, 10; n=3, 5; n=4, 5 mole %. The experiment in these laboratories was carried out under conditions which would be expected to favour greater conversion of the iodide into telomers than that achieved by Hauptschein. In fact, a smaller conversion was achieved, as was a greater yield of the higher telomers. In view of the fact that the conversion of pentafluoroiodoethane into telomers is less than that of the heptafluoroiodopropanes, it seems likely that Hauptschein's results are questionable. Also, Hauptschein's result is inconsistent with the view that as the efficiency of a chain transfer agent decreases, the conversion of that chain transfer agent into telomers decreases and the yield of higher telomers increases. This is a view to which Hauptschein himself subscribes.<sup>28</sup>

All the telomers isolated have ultra-violet spectra with  $\lambda_{\max}$  within the range 271-274  $m\mu$  which is in agreement with other compounds possessing the  $-\text{CH}_2\text{CF}_2\text{I}$  grouping. Had the addition gone in the reverse direction, the ultra-violet maximum would have been in the region 262  $m\mu$ .

TABLE 6

	$\lambda_{\text{Max}}$		$\lambda_{\text{Max}}$
$\text{CF}_3\text{CF}_2\text{CF}_2\text{I}$	271	$\text{CF}_3\text{CH}_2\text{I}$	262
$\text{CF}_3\text{CH}_2\text{CF}_2\text{I}$	271	$\text{CF}_2\text{ClCH}_2\text{I}$	263
$\text{CH}_2\text{Cl}\cdot\text{CF}_2\text{I}$	269	$\text{CF}_2\text{BrCH}_2\text{I}$	266

Chemical evidence for the attack of the perfluoroalkyl radical having been on the  $\text{CH}_2$  end of the olefin (i.e. dehydroiodination) will be discussed later.

The same copolymerisation studies which demanded the production of the olefins  $\text{C}_2\text{F}_5(\text{CH}_2\text{CF}_2)_n\text{CH}:\text{CF}_2$  and  $(\text{CF}_3)_2\text{CF}(\text{CH}_2\text{CF}_2)_n\text{CH}:\text{CF}_2$  ( $n = 0, 1, 2$ ) also demanded the preparation of the olefins  $(\text{CF}_3)_2\text{CFCF}:\text{CF}_2$  and

$[(\text{CF}_3)_2\text{CF}]_2\text{C}=\text{CF}_2$ . It was thought that a convenient route to these might be:-



the reaction was carried out between trifluoroiodomethane and the same olefin. Both thermal and ultra-violet initiated reactions were attempted but in both cases no reaction occurred.

It seems that these reactions might occur if the recently available azobisisobutyronitrile were used.

Reactions of Telomer iodides of 1,1-difluoroethylene.

Reactions of 2H,2H-1-iodononafluoro-(3-methylbutane),  
 $(CF_3)_2CFCH_2CF_2I$ .

1. Dehydroiodination.

As already mentioned, the olefin  $(CF_3)_2CFCH:CF_2$  was required for some copolymerisation studies being carried out in these laboratories and therefore the dehydroiodination of 2H,2H-1-iodononafluoro-(3-methylbutane) was undertaken.

a) Using potassium hydroxide in acetone.

This reaction was carried out in a sealed tube. It proceeded very readily and with vigour. Preparative G.L.C. had to be used to obtain the pure olefin and the overall yield was only 30%. The reaction resulted in the formation of much tarry material and so a more dilute solution of potassium hydroxide was used but no increase in the yield was achieved.

b) Using potassium fluoride in N,N-dimethylformamide

Hauptschein<sup>77</sup> found that the action of nucleophiles, in particular  $F^-$ , on iodides with the grouping  $-CH_2CF_2I$  caused dehydroiodination in high yield. The procedure outlined by Hauptschein was followed but although formed in a high yield, the olefin was contaminated with a small

amount of a material which had an almost identical retention time. This meant that preparative G.L.C. had to be used to isolate the olefin and overall yield was therefore much reduced. The impurity was not identified.

c) Using solid potassium hydroxide

Haszeldine<sup>18</sup> used solid potassium hydroxide to dehydroiodinate  $\text{CF}_3\text{CH}_2\text{CF}_2\text{I}$ . This same reagent was used to dehydroiodinate 2H,2H-1-iodononafluoro-(3-methylbutane) in high yield (85%). The product was pure and therefore losses were not incurred by having to use preparative G.L.C.

d) Using triethylamine.

Using triethylamine as the dehydroiodinating agent, a high yield (75%) of olefin was obtained. Traces of amine contaminating the olefin can be easily removed by chemical means.

The best methods of those investigated for dehydroiodinating 2H,2H-1-iodononafluoro-(3-methylbutane) are those using solid potassium hydroxide or a tertiary amine for they afford a pure olefin in high yield.

2. Replacement of Iodine by Hydrogen

a) Using Lithium Aluminium Hydride

The technique used was as that described by

Hauptschein et. al.<sup>174</sup> Although the desired alkane 1H,2H,2H-nonafluoro-(3-methylbutane),  $(CF_3)_2CFCH_2CF_2H$ , was obtained, there was also isolated a small amount of a second compound which was never identified. It is probable that this second compound is produced by one or more of the fluorine atoms having been replaced by hydrogen, for when trifluoroiodomethane is treated with lithium aluminium hydride, some methane is produced.<sup>174</sup>

This method of replacing iodine by hydrogen suffers from the fact that the alkane has to be separated from large amounts of ether, as well as from the other product, by preparative G.L.C. which reduces the overall yield.

b) By preparation of the Grignard reagent and its reaction with ethanol

In a single experiment to replace iodine by hydrogen by first of all preparing the Grignard reagent and then hydrolysing it with ethanol, none of the desired product was obtained. That the Grignard reagent had been formed was shown by the isolation of iodobenzene.q.v.



The amount of iodobenzene isolated corresponded to 30% of the iodide having been converted into its Grignard reagent.

This reaction was not further investigated because even if it had been successful, it, like the previous one would have necessitated the isolation of the product by Gas-Liquid chromatography.

c) Using zinc and sulphuric acid.

The procedure adopted by Haszeldine<sup>52</sup> was employed but the desired reduction did not take place to any appreciable extent. Instead, coupling was the main reaction, 3H,3H,6H,6H-octadecafluoro-(2,7-dimethyloctane),  $(CF_3)_2CFCH_2CF_2CF_2CH_2CF(CF_3)_2$ , being produced in 45% yield. The volatile product from the reaction was found to be a mixture of 2H-nonafluoro-(3-methylbut-1-ene) and 1H,2H,2H-nonafluoro-(3-methylbutane). Haszeldine<sup>52</sup> noticed that when he reduced 2H-1-iodooctafluoro-(2-methylpropane),  $(CF_3)_2CHCF_2I$ , using zinc and sulphuric acid, the product was 'contaminated by an olefin' but he does not mention the formation of any coupled material.

d) By ultra-violet irradiation in a solvent

It was noticed by Haszeldine et.al.<sup>71</sup> that perfluoro-alkyl radicals were able to abstract protons from hydrogen containing solvents and since 1H,2H,2H-nonafluoro-(3-methylbutane) was produced during the coupling of 2H,2H-1-iodononafluoro-(3-methylbutane) (see page 71), it

was thought the irradiation of the iodide in cyclohexane might yield the same alkane. In fact, equimolecular amounts of the alkane and 2H-nonafluoro-(3-methylbut-1-ene) were produced. It seems that protons were abstracted from the iodide but not from the solvent.

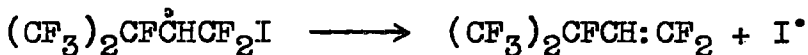
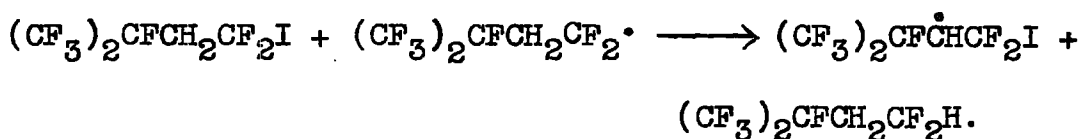

This type of reaction might be further investigated using other solvents.

e) Reaction with zinc; preparation and hydrolysis of  
 $(\text{CF}_3)_2\text{CFCH}_2\text{CF}_2\text{ZnI}$ .

Although the purpose of this reaction was to prepare 2H,2H-nonafluoro-(3-methylbutane) and while some of the desired compound was obtained, it was not the most important product. The method described by Miller et.al.<sup>171</sup> who prepared 1-heptafluoropropylzinc iodide from heptafluoro-1-iodopropane was adopted. The solvent was purified rigorously since the presence of peroxides has been found to inhibit the reaction.<sup>142</sup>

During the course of the reaction with 2H,2H-1-iodonona-

fluoro-(3-methylbutane) (30 gms), a mixture of compounds (7.5 gms.) was produced. These compounds were isolated by G.L.C. and found to be 1H,2H-octafluoro-(3-methylbut-trans-1-ene), 1H,2H,2H-nonafluoro-(3-methylbutane) and 1H,2H-octafluoro-(3-methylbut-cis-1-ene). Chromatography showed these compounds to be present in the ratio 1:2:7 by weight. It is proposed that the olefins are produced by the mechanism.

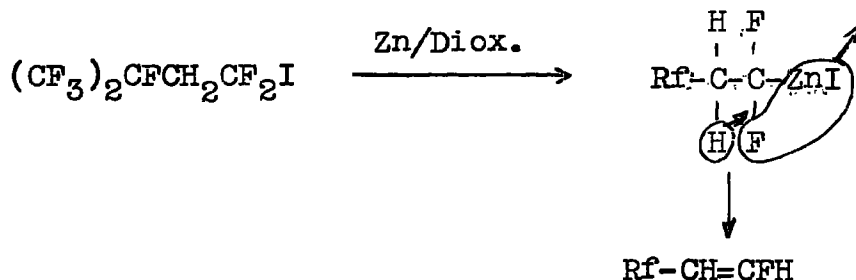

That the hydrogen on the  $\alpha$ -C of the olefin does not come from the solvent is suggested by the fact that the two geometric isomers are not produced in equimolecular amounts.

Hydrolysis of the zinc compound produced more of the butane and a little of the cis-butene (this was probably produced before the hydrolysis was carried out). Also obtained was some of the coupled compound, 3H,3H,6H,6H-octadecafluoro-(2,7-dimethyloctane).

The structures of the olefins were elucidated by N-M-R spectroscopy. (See 'Experimental', page 129).

### 3. Replacement of iodine by fluorine.

The iodine in polyfluoroiodoalkanes can be replaced by fluorine using antimony trifluorodichloride,<sup>77</sup> hydrogen fluoride,<sup>97</sup> cobalt trifluoride<sup>57,184</sup> and mercurous fluoride.<sup>52</sup> The first mentioned of these reagents was used and found to be satisfactory. Although the product was not a pure compound, the 2H,2H-decafluoro-(3-methylbutane) could be easily separated from the impurity by preparative G.L.C. No effort was made to identify the impurity but it seems likely that it was a compound in which one or both of the hydrogen atoms had been replaced by fluorine.

### 4. Coupling Reaction

Hauptschein<sup>55</sup> found that iodides with the grouping  $-\text{CH}_2\text{CF}_2\text{I}$  underwent coupling under the influence of ultra-violet radiation in the presence of mercury. He coupled  $\text{CF}_3(\text{CH}_2\text{CF}_2)_n\text{I}$  (where  $n = 1, 2$  and  $3$ ) and also mixtures of telomers of heptafluoro-1-iodopropane and 1,1-difluoroethylene.

2H,2H-1-iodononafluoro-(3-methylbutane) has now been coupled by the mercury/ultra-violet technique to give 3H,3H,6H,6H-octadecafluoro-(2,7-dimethyloctane) in good yield (75%). There was also formed during the reaction



The high yields of olefin show that the attack of the perfluoroalkyl radical is on the methylene group of 1,1-difluoroethylene to a very large extent.

## 2. Coupling

2H,2H-1-iodononafluoro-(3-methylbutane),  $(CF_3)_2CFCH_2CF_2I$ , underwent a coupling reaction to yield 3H,3H,6H,6H-octadecafluoro-(2,7-dimethyloctane),  $(CF_3)_2CFCH_2CF_2CH_2CF(CF_3)_2$ , a model compound containing tertiary fluorine atoms. In order to make a similar model compound without tertiary fluorine, the coupling of 2H,2H-1-iodoheptafluorobutane,  $C_2F_5CH_2CF_2I$ , and 2H,2H,-1-iodononafluoropentane,  $C_3F_7CH_2CF_2I$ , was carried out using the same ultra-violet/mercury technique as previously described. In a similar way to the production of small amounts of 2H-nonafluoro-(3-methylbut-1-ene),  $(CF_3)_2CFCH=CF_2$ , and 1H,2H,2H-nonafluoro-(3-methylbutane),  $(CF_3)_2CFCH_2CF_2H$ , during the coupling of 2H,2H-1-iodononafluoro-(3-methylbutane), 2H-heptafluorobut-1-ene,  $C_2F_5CH=CF_2$ , and 1H,2H,2H-heptafluorobutane,  $C_2F_5CH_2CF_2H$  were produced during the coupling of 2H,2H-1-iodoheptafluorobutane.

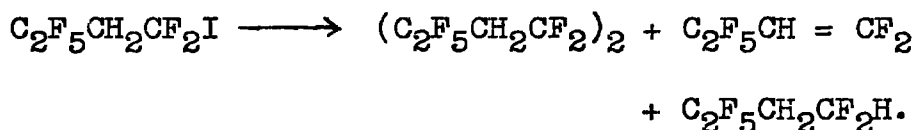

It is likely that a similar alkane and alkene are produced during the coupling of 2H,2H-1-iodononafluoropentane,  $C_3F_7CH_2CF_2I$ , but no effort was made to isolate them.

Reaction between 2H,2H-1,4-diiiodohexafluorobutane and mercury under the influence of ultra-violet radiation

It was though interesting to observe the behaviour of a 1,4-diiiodobutane under the influence of ultra-violet radiation in the presence of mercury, for if it cyclised then it would seem likely that a 1,6-diiiodohexane would cyclise and so provide a new route to fluoroaromatic compounds.

In fact, no volatile material was obtained. A polymer which lost hydrogen fluoride spontaneously was the only product.

When 1,2-diiidotetrafluoroethane was treated in a like manner, tetrafluoroethylene was the only product.

Reaction between 2H,2H-1,4-diiiodohexafluorobutane and sulphur

In 1961 Tiers heated 1,4-diiiodooctafluorobutane with sulphur to 250°C. for 20 hours and obtained perfluorothiophane.<sup>179</sup> A similar reaction was attempted using 2H,2H-1,4-diiiodohexafluorobutane. The reactants were heated to 200°C. for 4 hours but even under these conditions, excessive decomposition took place and none of

the desired product was obtained. It seems reasonable to attribute this instability to the presence of hydrogen in the system.

A preliminary investigation into the reactions of  
Model compounds of Viton A

Having made the model compounds 3H,3H,6H,6H-octadecafluoro-(2,7-dimethyloctane), 4H,4H,7H,7H-octadecafluorodecane and 3H,3H,6H,6H-tetradecafluorooctane, a preliminary investigation into the mechanism of cross-linking in Viton was undertaken. The first step in this process is regarded as being one of dehydrofluorination<sup>133,135</sup> but subsequent processes are rather more obscure (see p. 49). The dehydrofluorination of the model compounds was first of all undertaken. Since it is thought that a tertiary fluorine atom is removed from a molecule more easily than the fluorine of a difluoromethylene group<sup>135</sup> it was the dehydrofluorination of 3H,3H,6H,6H-octadecafluoro-(2,7-dimethyloctane) which was investigated first.

Dehydrofluorination of 3H,3H,6H,6H-octadecafluoro-(2,7-dimethyloctane).

Using Anion exchange resin

Anion exchange resin has been used successfully in the dehydrofluorination of hydrofluorocyclohexanes.<sup>147</sup> When this reagent was used in attempts to dehydrofluorinate 3H,3H,6H,6H-octadecafluoro-(2,7-dimethyloctane), both in the presence and absence of a solvent, no reaction occurred.

Using sodium and potassium hydroxides.

When sodium hydroxide in acetone was used as the

dehydrofluorinating agent, a vigorous exothermic reaction ensued, but extensive decomposition occurred and no 'product' was obtained. When a more dilute solution was used, a similar amount of decomposition occurred.

In experiments using sometimes aqueous and sometimes powdered potassium hydroxide, dehydrofluorination did occur as evidenced by infra-red spectroscopy, but only with difficulty. When conditions were made more vigorous, so as to encourage the reaction, decomposition took place. A mixture of olefins was produced by dehydrofluorination which could not be isolated due to their having retention times similar to that of the starting material.

#### Using amines.

Almost immediate reaction occurred when 3H,3H,6H,6H-octadecafluoro-(2,7-dimethyloctane) was treated with dry ethereal solutions of primary, and secondary amines at room temperature. In both cases precipitates were produced which were not amine hydrofluorides but which contained fluorine, as evidenced by infra-red spectroscopy, and nitrogen. Both decomposed when filtered from the ether and exposed to the atmosphere. It seems likely that dehydrofluorination had occurred followed by the addition of amine to the double bond.

e.g.

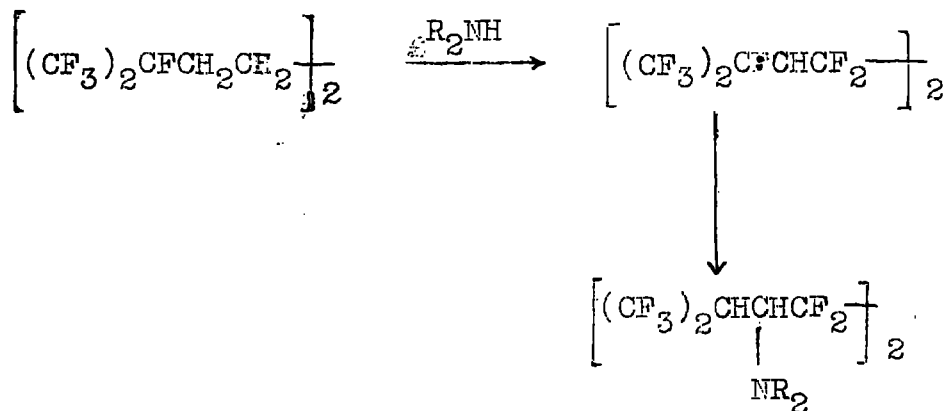

This material on exposure to moist air possibly yielded a substituted amide c.f.

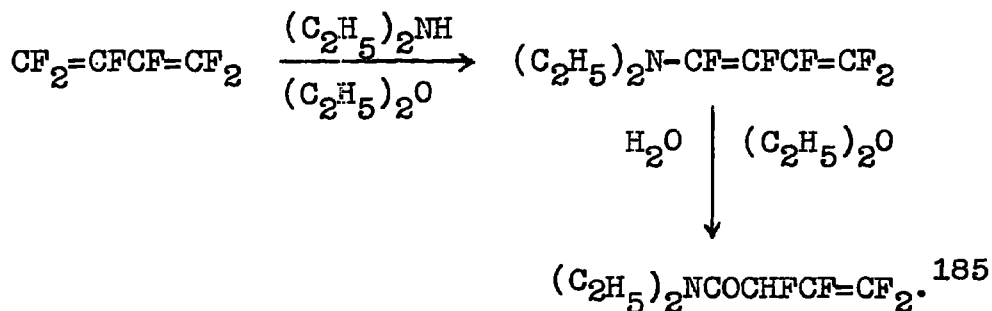

After filtration of the precipitates, G.L.C. showed there to be nothing in the ether solution other than starting materials. When treated with a tertiary amine under the same conditions no precipitate was produced and even after several days, analytical G.L.C. revealed only the presence of starting materials in the reaction vessel. In the absence of solvent, 3H,3H,6H,6H-octadecafluoro-(2,7-dimethyloctane) was treated with tri-n-butylamine and after five hours at 130°C. an organic material was isolated which contained a large amount (70% of total area of chromatogram)

of a compound which was not starting material. This compound could not be obtained absolutely pure due to another component of the mixture having a very similar retention time but a purity of 95% was achieved.

The infra-red spectrum of this material had a single peak at  $1709 \text{ cm}^{-1}$  showing it to be unsaturated. The N-M-R spectrum shows there to be four groups of fluorines in the intensity ratio 12:2:1:1. (Full data in 'Experimental', p. 149).

a) CF<sub>3</sub> groups. Three chemically shifted groups in intensity ratio 3:6:3. Hence two trifluoromethyl groups are equivalent and two are different. This could arise from a group  $(\text{CF}_3)_2 \overset{*}{\text{C}} \begin{array}{l} \swarrow \text{X} \\ \searrow \text{C}^* \end{array}$  with X not necessarily fluorine; the  $\overset{*}{\text{C}}-\overset{*}{\text{C}}$  bond is a single bond. The chemical shift, however, is not that of  $(\text{CF}_3)_2\text{CF}-$  in the starting material. The two non-equivalent trifluoromethyl groups probably arise from a group  $(\text{CF}_3)_2\text{C:CRR}'$  in which the trifluoromethyl groups are cis and trans to substituents R and R'. This is also consistent with chemical shift values which lie in the same region as in  $(\text{CF}_3)_2\text{C:CF}_2$

b) CF<sub>2</sub> groups. The CF<sub>2</sub> group gives rise to an AB spectrum and is therefore a CF<sub>2</sub> in a substituted ethane.

c) One fluorine. gives rise to a peak in the same region

of the spectrum as the above difluoromethylene group  
i.e. NOT a tertiary fluorine atom as in  $(\text{CF}_3)_2\text{CF}-$ .

d) One fluorine at high applied fields, but it has a different value of chemical shift to tertiary fluorine as in  $(\text{CF}_3)_2\text{CF}$  ( 130 p.p.m. as opposed to 108 p.p.m. found for tertiary fluorine in  $(\text{CF}_3)_2\text{CF}$  in many compounds). The hydrogen spectrum shows there to be present two types of hydrogen in the intensity ratio 1:1. The large H-F coupling constant observed in one of these peaks could indicate either trans-  $\begin{array}{c} \text{F} \\ \diagdown \\ \text{C}=\text{C} \\ \diagup \\ \text{H} \end{array}$  or CFH.

It seems then from the above infra-red and N-M-R evidence that dehydrofluorination has taken place giving  $(\text{CF}_3)_2\text{C}=\text{C}\begin{array}{l} \diagup \text{CF}_2 \\ \diagdown \text{H} \end{array}$  and the other perfluoroisopropyl group has been changed in some way. Had the observed chemical shifts of  $\text{CF}_3$  and F been the same as observed in  $(\text{CF}_3)_2\text{CFCHCF}_2$ , then the structure  $\begin{array}{c} \text{CF}_3 \\ \diagdown \\ \text{C}=\text{CHCF}_2\text{CF}=\text{CH}-\text{CF} \\ \diagup \text{CF}_3 \end{array}$  would have been the most probable but the shifts are in fact different and so it is unlikely that this is the structure of the compound.

The experiments with primary and secondary amines show that hydrogen fluoride can be removed from 3H,3H,6H,6H-octadecafluoro-(2,7-dimethyloctane) fairly readily but it is clear that reactions with tertiary amines are quite

different. This behaviour with tertiary amines is consistent with the fact that hydrogen fluoride (tertiary fluorine) is not eliminated during the dehydroiodination, by tertiary amines, of the telomer iodides  $(CF_3)_2CF(CH_2CF_2)_nI$  ( $n= 1,2,3.$ ). Study on this reaction is continuing.

Paciorek et.al.<sup>97</sup> have shown that potassium hydroxide and amines both cause elimination of hydrogen fluoride (tertiary fluorine) from  $CF_3CH_2CF(C_2F_5)CH=CFC_2F_5$  to give the conjugated diolefin  $CF_3CH=C(C_2F_5)CH=CFC_2F_5$  but it is felt that this dehydrofluorination reaction is not taking place in a situation analogous to that existing in Viton. The very fact that a conjugated diene can be produced is going to encourage the elimination of the fluorine atom which results in the formation of such a diene.

The dehydrofluorination of 3H,3H,6H,6H-tetradecafluoro-octane.

Dehydrofluorination experiments roughly parallel to those with 3H,3H,6H,6H-octadecafluoro-(2,7-dimethyloctane) were carried out.

With powdered potassium hydroxide it was again found that under conditions necessary to promote reaction, excessive decomposition took place. With aqueous potassium hydroxide, after prolonged refluxing, a certain amount of unsaturated material was obtained without undue decomposition

but the product was a complicated mixture (see fig. 6 p.152).

After treating 3H,3H,6H,6H-tetradecafluoro-octane with tri-n-butylamine for 20 hours at 110°C., very little reaction had occurred.

Comparing the reactions of 3H,3H,6H,6H-octadecafluoro- (2,7-dimethyloctane) and 3H,3H,6H,6H-tetradecafluorooctane with tertiary amines, it seems that tertiary fluorine is rather more easily removed than a fluorine atom from a difluoromethylene group as in fact was suspected. However it is clear that the processes taking place during the treatment of 3H,3H,6H,6H-octadecafluoro(2,7-dimethyloctane) with tertiary amines are more complicated than anticipated. It is probable that these same processes are taking place during the cross-linking of Viton.

## Chapter 3

### EXPERIMENTAL

### Infra-red Spectroscopy

Considerable use has been made of infra-red spectroscopy for determining the identity of products. A Grubb-Parsons Type G.S.2A double beam grating infra-red spectrometer was used to obtain all spectra.

Samples were in the form of a thin film between potassium bromide discs, a gas in a cylindrical cell (5" long x 1½" diam.) with potassium bromide end windows, or made into a disc with potassium bromide.

### Ultra-violet Spectroscopy

Ultra-violet spectroscopy was used in the determination of the structure of some telomer iodides. An Optica C.F.4. double beam spectrophotometer was used to obtain all spectra.

Samples were dissolved in cyclohexane and the solution placed in quartz cells,

### Nuclear-Magnetic-Resonance Spectroscopy

With the exception of measurement on 1H,2H-octafluoro-(3-methylbut-cis-1-ene), nuclear-magnetic-resonance spectroscopic data has been obtained by Dr. J. Emsley of Durham University using an A.E.I.R.S.2 spectrometer at

60 Mc/s. Dr. L.H. Sutcliffe of Liverpool University using a Varian V-4300B spectrometer at 56.4 Mc/s made measurements on 1H,2H-octafluoro-(3-methylbut-cis-1-ene). These same two workers interpreted the spectra.

### Molecular Weights

Molecular weights of gases and very volatile liquids were determined by Regnault's method. For this, a glass bulb (124.6 mls.) fitted with a high vacuum tap and B10 cone was used. The volume of the bulb was found by weighing it when evacuated and then when filled with distilled water at a known temperature. The bulb was fitted to a vacuum system, filled with vapour to an accurately measured pressure and then weighed. The weight, volume, pressure and temperature of the vapour occupying the bulb afforded the molecular weight.

Molecular weights of less volatile liquids and solids were determined cryoscopically using standard apparatus.

### Pressure Reactions

For the preparation of pentafluoroiodoethane, tetrafluoro-1,2-diiodoethane, heptafluoro-2-iodopropane and 1,1,1-trifluoro-2-iodoethane, a stainless steel autoclave (527 mls.) which could be rotated at an angle was

used. Mixing was further improved by having in the vessel several pieces of stainless steel rod.

Telomer iodides were prepared in a stainless steel autoclave which could be rocked. This autoclave was fitted with a pressure gauge which made it possible to follow the course of reactions being carried out therein.

The charging of these autoclaves with gas was accomplished by using a simple vacuum system (Fig. 1). The gas was condensed and weighed as a solid in a cold flask which was attached to the vacuum system. The autoclave, which was already charged with any liquid or solid reagents, was attached to the vacuum system and cooled in liquid air. After evacuating the system, the gas was transferred to the autoclave using standard vacuum techniques.

### Gas-Liquid Chromatography

#### Analytical Scale

A Griffin and George Mark IIB model with two U-shaped columns (90 x .64 cms.) was used for most analytical work. The packing was of kieselguhr on which had been deposited a stationary phase (40%) of tricresyl phosphate (T.C.P.) or Silicone Elastomer.

For the investigation of the products from the pyrolysis of 'Teflon' (page 96), the same apparatus was fitted with

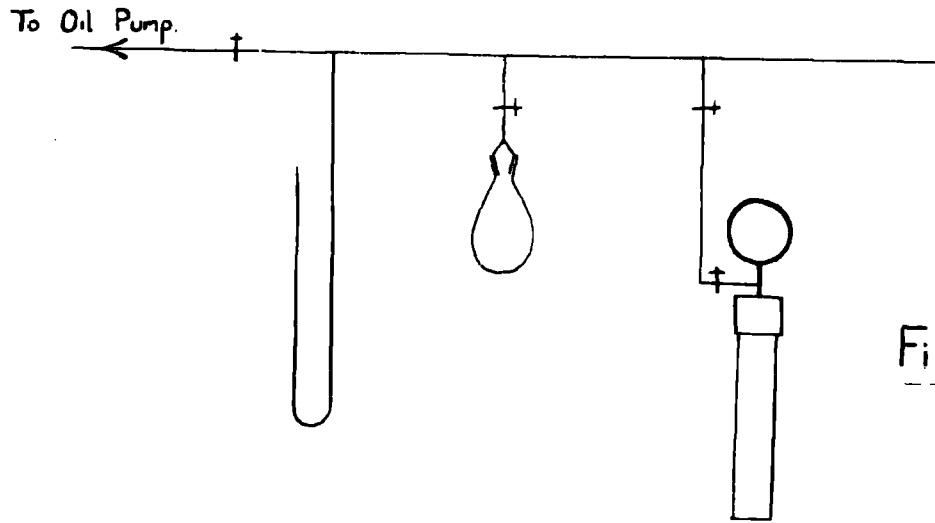

Fig 1

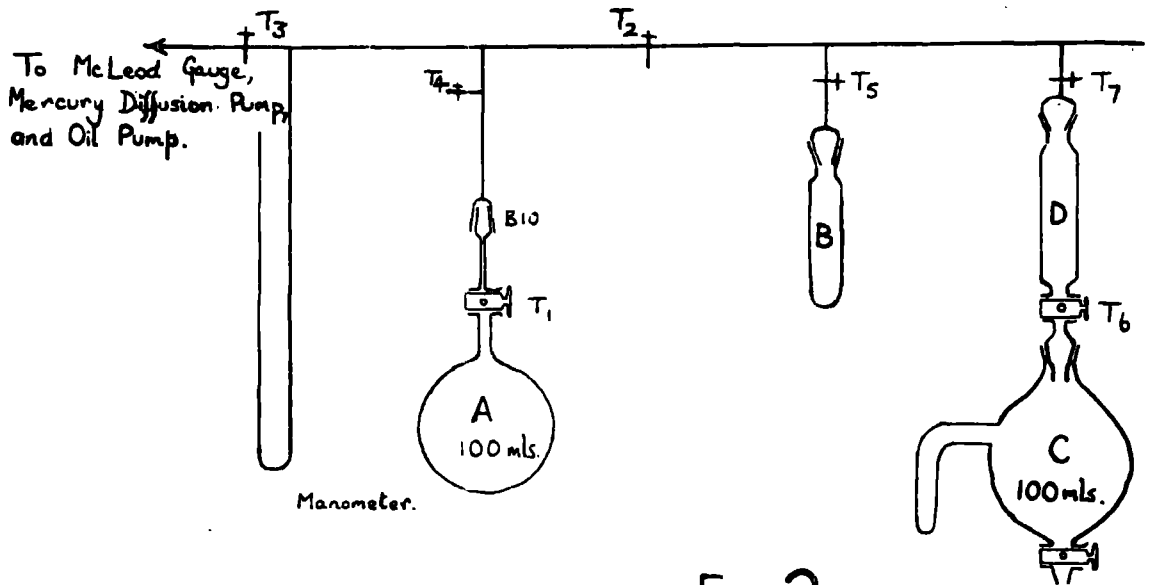

Fig 2

a copper spiral column (360 x .64 cms. diam.) which, after packing, was fitted into a Dewar flask packed with ice.

Preparative Scale. (Fig. 3. page 89)

This apparatus, of the 'suck through' type, consisted of a horizontal U-shaped tube (240 x 2.3 cms. diam. containing ca. 380 gms. packing) leading through narrow bore silicone rubber tubing to a separately heated detector<sup>88</sup> and then to a trapping system.

The columns lay in a glass wool lagged box heated by a strip heater positioned beneath a false bottom. The temperature inside the box was maintained uniform by means of a circulating fan fitted at one end. Nitrogen, the carrier gas, prior to coming into contact with the sample was pre-heated inside the box by passing it through a copper coil (7.62 metres). The sample was either injected into the nitrogen stream through a serum cap, or evaporated directly into the nitrogen stream by diverting the latter through a trap containing the sample. The injected sample was quickly vapourised by means of a glass tube (62 x 1.9 cms. diam.) packed with glass wool and heated, by means of a heating jacket, to about 50°C. above the temperature of the box.

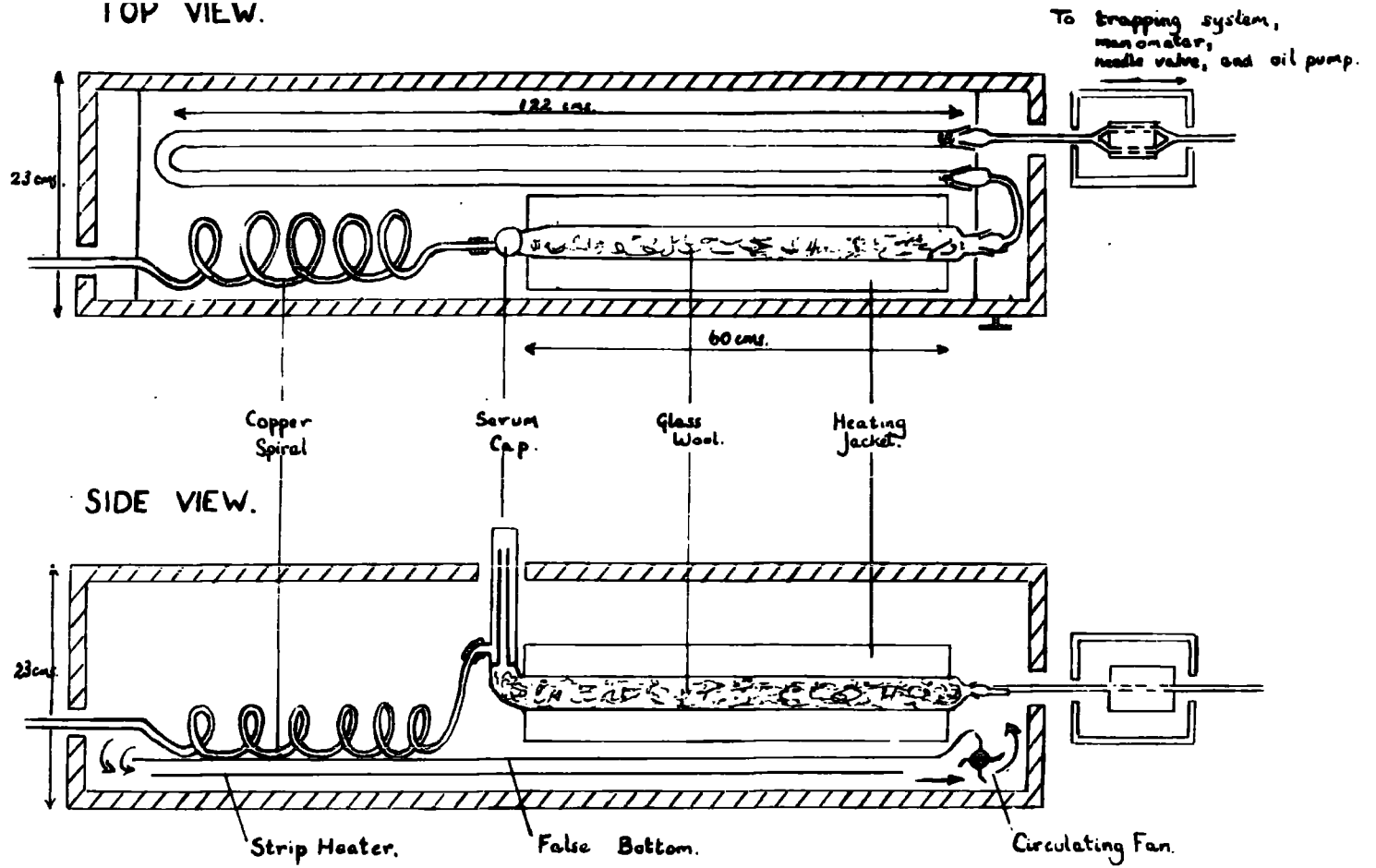

Fig. 3

The detector was of the thermistor type sealed into an aluminium block and incorporating a by-pass for 80% of the nitrogen stream. It was positioned inside a small aluminium box packed with asbestos wool and fitted with a small electric heater controlled by a Variac.

The trapping system was of the straight manifold variety with fittings for U-shaped traps. A heating tape wrapped around the manifold prevented premature condensation.

### Analysis

The fluorine content of volatile compounds has been determined essentially as described by Savory.<sup>89</sup> However there have been significant changes in the preparation and handling of the diphenyl-sodium-dimethoxyethane complex.

On occasions difficulty has been encountered in preparing a complex of the hitherto demanded strength of 1 to 1.5 M.<sup>90</sup> or 2M.<sup>91</sup> When reagent of this concentration has been prepared, it has been noticed that diphenyl-sodium was precipitated, particularly when the reagent was being stored at 0°C. Warming to room temperature, instead of causing the precipitate to dissolve, simply promoted decomposition. It may be that it is impossible to obtain a true solution of strength greater than 1M. and that the higher

concentrations previously thought to exist have really been combinations of a solution and a fine suspension. It has now been found that a greater volume of a more dilute solution (.5M) will decompose organic fluorine containing compounds completely provided care is taken to maintain an atmosphere of dry nitrogen above the reagent at all times.

### Preparation of diphenyl-sodium-dimethoxyethane complex

#### a) Purification of reagents

i) Diphenyl- was recrystallised once from meths. and dried under vacuum at room temperature for 4-5 hours.

ii) Toluene - Sulphur free toluene was distilled over sodium in an atmosphere of dry nitrogen.

iii) Ethylene glycol dimethyl ether (dimethoxyethane)- was distilled three times from potassium in an atmosphere of dry nitrogen, the last time in the presence of the ketyl of benzophenone which gives a deep blue colour only in the presence of water and peroxides.

iv) Sodium dispersion- A flask (2N. 250 mls.) with indented sides to prevent swirling, was fitted with nitrogen inlet and vertical air condenser down which was freely suspended the rod of a dispersator. After purging with dry nitrogen the flask was charged with sodium (23 gms.,

1 gm. atom) and dry toluene (50 mls.). The toluene was gently refluxed and the dispersator run at maximum speed for 15 minutes during which time the dispersion was produced. The heating and dispersator were stopped and the dispersion was allowed to cool to room temperature. An atmosphere of dry nitrogen was maintained throughout the preparation.

b) Preparation of the complex

This was carried out essentially as described by Ligett<sup>92</sup> and Sezerat.<sup>93</sup>

The sodium dispersion was transferred to a dry nitrogen purged flask (3N. 3lit.) fitted with dropping funnel, mechanical stirrer and reflux condenser. Dimethoxyethane was added until the volume of the liquid in the flask was 1750 mls. The flask was cooled in an ice bath until the temperature of the contents was 5°C. Diphenyl (160 gms., 1.04 moles) in dimethoxyethane (250 mls.) was added with stirring over two hours. The reaction started after a few minutes and the solution first turned green and finally black; the reaction was exothermic and the temperature was kept below 10°C. by cooling the flask in an ice/water bath. Stirring was continued for an hour after the biphenyl solution had been added. An atmosphere of dry nitrogen was maintained throughout the preparation.

The reagent was transferred to flasks (2N. 250 mls.) and stored under dry nitrogen at 0°C.

c) Analytical procedure.

The tap and cone of flask A were carefully greased, avoiding excess grease (Apiezon L), and the flask then evacuated to a 'sticking' vacuum on the apparatus shown in Figure 2. With taps T<sub>1</sub>, T<sub>2</sub>, and T<sub>3</sub> closed, T<sub>4</sub> was opened and the bulb removed from the vacuum line. The grease was carefully removed from the cone and the rest of the bulb polished with a chamois leather. After leaving in the balance case for fifteen minutes, the bulb was weighed to the nearest tenth of a milligramme. A was reattached to the vacuum line and with B, which contained the sample to be analysed, cooled in liquid air, and T<sub>1</sub>, T<sub>2</sub>, T<sub>3</sub> and T<sub>5</sub> open, the apparatus was again pumped down to a sticking vacuum. T<sub>3</sub> was closed and B was allowed to warm slowly until the pressure in the system was such as to introduce a 40-60 mgm. sample into A. T<sub>1</sub> was closed and the weight of the sample found by removing, cleaning, and reweighing A as before. A was returned to the vacuum line which was evacuated with T<sub>2</sub>, T<sub>3</sub>, T<sub>6</sub> and T<sub>7</sub> open, and the sample was transferred to C by closing T<sub>3</sub>, opening T<sub>1</sub> and cooling the side arm of C in liquid air. T<sub>6</sub> was closed and the unit comprising C and D removed after

releasing the vacuum at  $T_4$ . With the side arm still in liquid air, diphenyl-sodium-dimethoxyethane complex (30 mls.) was taken from a storage flask under nitrogen and introduced into D using a nitrogen filled pipette.  $T_6$  was opened and the complex allowed into C followed by di-isopropylether (25 mls.) Care was taken to leave the bore of  $T_6$  full of liquid to maintain a partial vacuum in C. The sample was allowed to warm to room temperature and the reagent gently swirled for five minutes. The sodium halides were extracted with demineralized water and the extract made up to 100 mls.

A 10 ml. aliquot was passed through a cation exchange resin column containing 5 gms. Amberlite I.R. -120(H) resin and eluted with 60 mls. of demineralized water added in 15 ml. quantities. The eluate was heated to boiling and immediately cooled.

The solution was titrated against standard .02N sodium hydroxide solution using methyl red - methylene blue (3 and 2 drops respectively) as indicator.

A blank determination was made by shaking di-isopropyl ether (25 mls.) with diphenyl-sodium-dimethoxyethane reagent (30 mls.) in a stoppered separating funnel. Any sodium halide was extracted with demineralized water followed by the procedure for the determination of fluorine.

## Preparation of simple iodides

### Preparation of trifluoroiodomethane from iodine and silver trifluoroacetate.1,4

#### Silver Trifluoroacetate

Trifluoroacetic acid was added to a slight excess of a suspension of silver hydroxide in water; most of the hydroxide dissolved. Filtration, evaporation to dryness, grinding into a powder, and completing the desiccation in vacuo on a steam bath afforded pure dry silver trifluoroacetate.

#### Trifluoroiodomethane

An intimate mixture of powdered silver trifluoroacetate (22.1 gms., .1 moles) and finely ground iodine (15 gms., .12 moles) was placed in a horizontally held tube. One end of the tube was sealed but the other lead to two traps, one at 0°C. and one at -78°C., and a bubbler.

The reactants were heated cautiously with a Bunsen burner, first at the end remote from the traps. As the reaction proceeded, the burner was moved towards the exit of the tube. The rate of the reaction<sup>was</sup> followed by observing the rate of evolution of carbon dioxide through the bubbler.

When the reaction was complete, a pink liquid (15 gms.)

had collected in the trap at  $-78^{\circ}\text{C}$ . This material was purified by preparative G.L.C. (D.N.P.,  $19^{\circ}\text{C}$ ., 150 mls./min.) and recognised by its infra-red spectrum as being trifluoroiodomethane. Yield 65%

Preparation of pentafluoroiodoethane from tetrafluoroethylene, iodine and iodine pentafluoride.<sup>11,12,91</sup>

Tetrafluoroethylene was prepared by the pyrolysis of Teflon\* but with our apparatus (Fig. 4) it was found impossible to obtain the high yield quoted in the literature.<sup>94,95</sup>

Pyrolysis of Teflon

Teflon (200 gms.) was placed in the copper boat and positioned in the tube as shown. The pyrolysis tube was sealed, slid into the furnace and connected through traps to the pump. The pressure inside the system was reduced to 5 mms. and kept at this value by suitable adjustment of the needle valve. Heating was commenced and after 5 hours the uniform temperature zone was at  $600^{\circ}\text{C}$ . This temperature was maintained for 4 hours during which time 195 gms. of pyrolysate collected in the liquid air trap.

Composition of product

The trap containing the crude pyrolysate was connected

---

\* Registered trade mark of E.I. du Pont de Nemours & Co. Ltd.

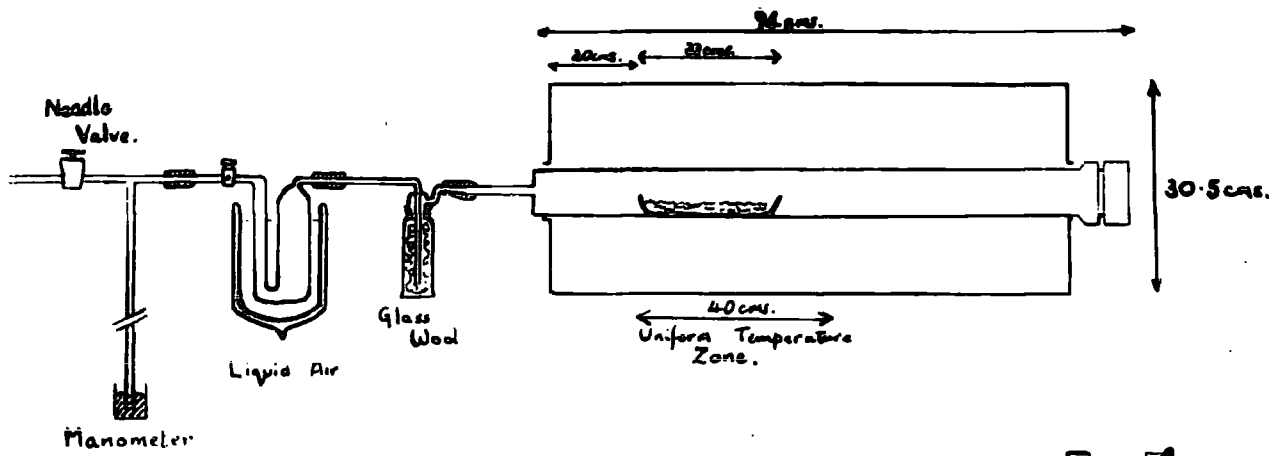
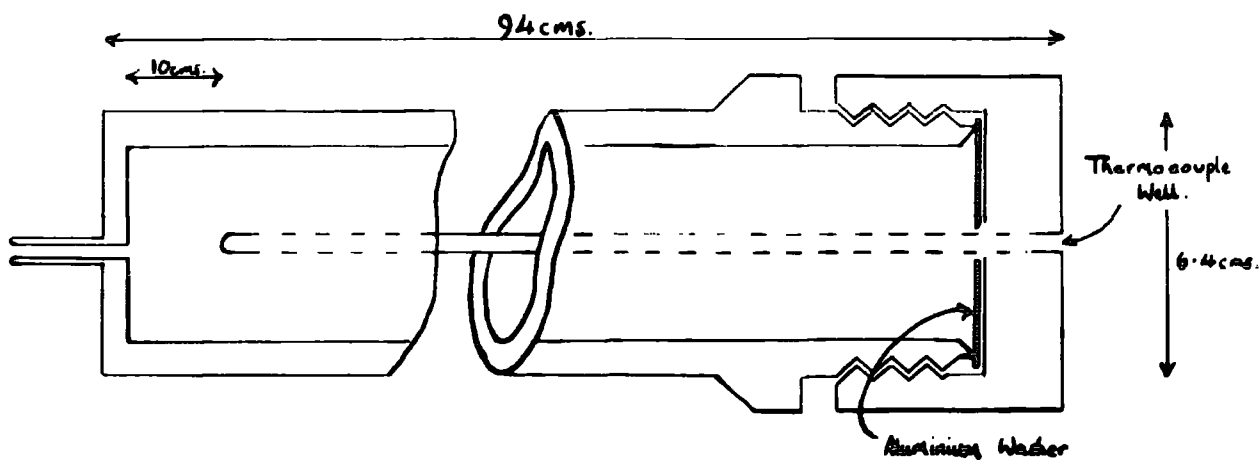

Fig. 4



to an evacuated reservoir in a vacuum system. Expansion of the gases allowed a sample to be taken with a syringe through a serum cap.

An analytical chromatogram (360 cms. perfluoro-tri-n-butylamine on kieselguhr at 0°C., .6 lits./hr.) revealed the gas to have the composition; tetrafluoroethylene, 55%; hexafluoropropene, 20%; perfluorocyclobutane, 24%; perfluorobutenes, 1% by weight.\*

#### Distillation of product

The product was condensed into a still pot which was fitted to a low temperature distillation column (Fig. 5). Tetrafluoroethylene was allowed to boil off past the cold finger containing acetone and drikold (-78°C.) and collected in a trap at liquid air temperature. As soon as the higher boiling materials began to reflux on the cold finger, the still pot was cooled and the distillation halted. In this manner, 70 gms. of tetrafluoroethylene (> 95%) was collected.

#### Preparation of pentafluoroiodoethane

The autoclave charged with iodine pentafluoride

---

\* The identity of these compounds has been established by Dr. R.H. Mobbs using low temperature preparative G.L.C. and infra-red techniques.

Fig. 5

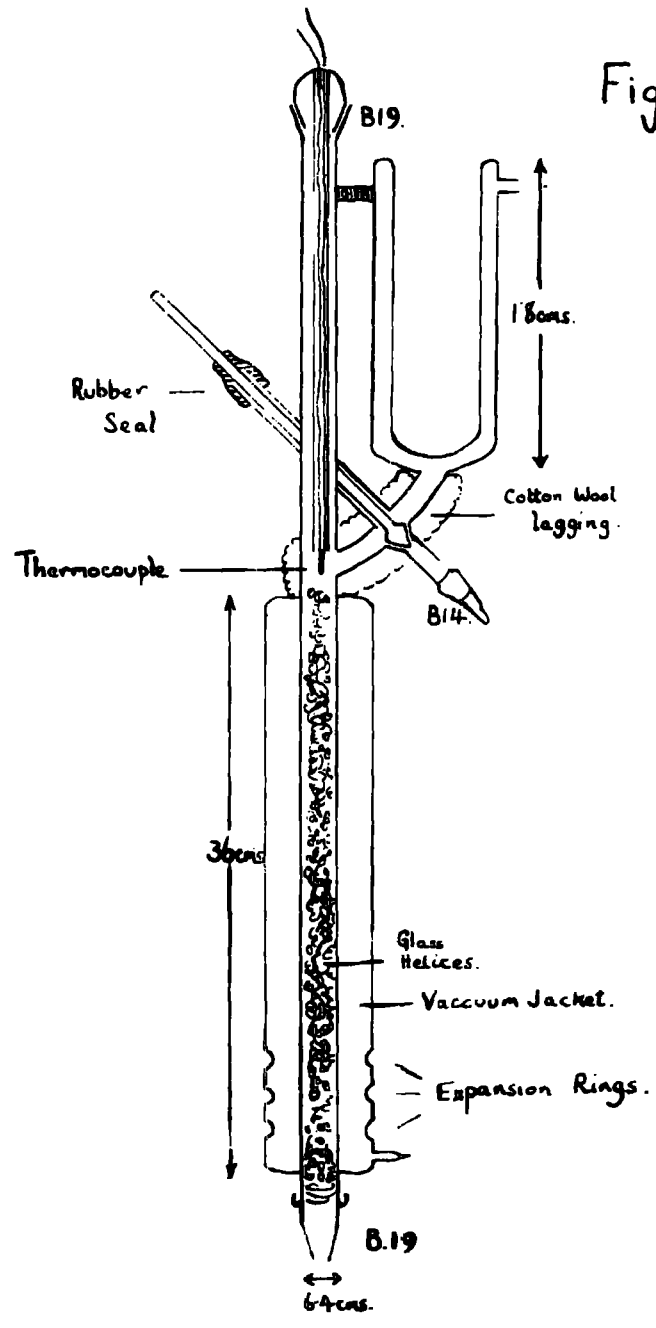

(31 gms., .14 moles.), iodine (84 gms., .28 moles.), and tetrafluoroethylene (70 gms., .7 moles) was rotated for 16 hours without heating. It was then vented through two cooled traps ( $-78^{\circ}\text{C}$ . and  $-183^{\circ}\text{C}$ .) to condense volatile materials, leaving unreacted iodine and residual liquid. The colder trap contained a material (2 gms.) identified by its infra-red spectrum as being tetrafluoroethylene. The contents (170 gms.) of the other trap ( $-78^{\circ}\text{C}$ .) were distilled through a short column of potassium hydroxide pellets to remove hydrogen fluoride and collected at  $-78^{\circ}\text{C}$ . in a still pot. This was fitted to the low temperature distillation column (Fig. 5) and the iodide distilled. In this way 155 gms. of pentafluoroiodoethane (>98%) was obtained.

For telomerisation reactions samples of iodide purified in this way were used, but for the exchange reactions with radioiodine chromatographic purification (T.C.P.,  $18^{\circ}\text{C}$ ., 150 mls./min.) of the distilled iodide was carried out.

Remaining in the autoclave were small amounts of iodine and tetrafluoro-1,2-diiodoethane; the latter being identified by its having a coincident retention time with that of an authentic sample.

Preparation of 1,1,1-trifluoro-2-iodoethane.<sup>11,12</sup>

The autoclave, charged with iodine pentafluoride (36 gms., .16 moles.), iodine (80 gms., .304 moles), and 1,1-difluoroethylene (50 gms., .78 moles) was rotated at 103°C. for 15 hours. No gaseous material was vented from the autoclave; the remaining liquid was washed with alkaline sodium thiosulphate to remove iodine, dried over anhydrous magnesium sulphate, and distilled giving 1,1,1-trifluoroiodoethane (145 gms.) (> 99%), identified by its having a retention time coincident with that of an authentic sample, and by its infra-red spectrum.

For the exchange reactions with radioiodine, a sample was further purified by preparative G.L.C. (T.C.P., 60°C., 180 mls./min.)

Preparation of heptafluoro-2-iodopropane.<sup>11,12</sup>

The autoclave charged with iodine pentafluoride (29.5 gms., .132 moles), iodine (67 gms., .264 moles), and hexafluoropropene (100 gms., .66 moles) was rotated at 150°C. for 20 hours. No gaseous material was vented from the autoclave; the residual liquid was washed with alkaline sodium thiosulphate to remove iodine, dried over anhydrous magnesium sulphate, and distilled yielding heptafluoro-2-iodopropane (190 gms.) (> 98%), identified by



its having a retention time coincident with that of an authentic sample and by its infra-red spectrum.

Again, for the exchange reactions with radioiodine, a sample was further purified by preparative G.L.C. (T.C.P., 50°C., 150 mls./min.).

Preparation of tetrafluoro-1,2-diiodoethane.<sup>15</sup>

The autoclave charged with iodine (127 gms., .5 mole), and tetrafluoroethylene (50 gms., .5 moles) was rotated at 160°C. for 24 hours. No unreacted tetrafluoroethylene was vented from the autoclave; the residual liquid was distilled, washed with alkaline sodium thiosulphate and dried over anhydrous magnesium sulphate. It was identified as being tetrafluoro-1,2-diiodoethane by its infra-red spectrum and b.pt. (113°C.).

The attempted preparation of 2H,2H-decafluoro-(3-methylbutane) from 1,1,1-trifluoro-2-iodoethane and heptafluoro-2-iodopropane, and related reactions.

The ultra-violet irradiation of 1,1,1-trifluoro-2-iodoethane in the presence of mercury

1,1,1-trifluoro-2-iodoethane (15 gms., .07 moles) was sealed under vacuum in a thin walled tube (50 mls. capacity), with just enough mercury to form a continuous pool when horizontal. The tube was shaken in a horizontal position 35 cms. from a Hanovia Model 11 ultra-violet lamp for 240 hours. The temperature in the region of the tube was 40°C.

The tube was opened to a vacuum system and there distilled out material (1 gm.) which was shown by analytical G.L.C. (T.C.P., 25°C., 1 lit./hr.) to consist of three components. The compound having the longest retention time accounted for 80% of the area under the chromatogram. This was purified by G.L.C. (Si. Elast., 35°C., 160 mls./min.) and found to be 2H,2H,3H,3H-hexafluoro-butane. (Found: F, 68.6%, M, 163. C<sub>4</sub>H<sub>4</sub>F<sub>6</sub> requires F, 68.7%. M, 166.) I.R.No. 1.

The solid remaining in the tube was extracted with meths. Filtering and evaporating the solution to dryness yielded 22 gms. of a pale yellow crystalline material. This was recrystallised twice from meths and the white

crystalline compound 1,1,1-trifluoroethylmercuric iodide obtained. (Found; C, 6.0, F, 13.7. I, 30.6%. M, 400.  $C_2H_2F_3HgI$  requires C, 5.8. F, 13.9. I, 30.9%. M, 410.6.) M.Pt.  $163^{\circ}C$ . I.R.No. 2.

Using the same amounts of starting materials, the reaction has been repeated using a  $\frac{1}{2}$  kw. ultra-violet lamp for the irradiation. After three days irradiation at 30 cms. from the lamp, the tube was opened and 4 gms. of volatile material obtained together with 8 gms. crude 1,1,1-trifluoroethylmercuric iodide.

Attempted coupling of 1,1,1-trifluoro-2-iodoethane using yellow mercuric oxide.

1,1,1-trifluoro-2-iodoethane (2.1 gms., .01 mole) was sealed under vacuum in a Carius tube (30 mls. capacity) with yellow mercuric oxide (2.3 gms., .01 moles) and heated for 40 hours at  $190^{\circ}C$ . At the end of this time, the tube was opened and the iodide (2.1 gms.) recovered.

The reaction was repeated at  $230^{\circ}C$ . for 30 hours at the end of which time, the contents of the tube were black. The tube was opened to a vacuum system and the volatile material (.8 gm.) distilled out. It soon became apparent that this volatile material was largely hydrogen fluoride. Analytical G.L.C. (Si. Elast.,  $60^{\circ}C$ ., 1 lit./hr.) showed the only other compound to have a

retention time coincident with 1,1,1-trifluoro-2-iodoethane. On washing out the tube, considerable etching was noted to have taken place.

The ultra-violet irradiation of 1,1,1-trifluoro-2-iodoethane with heptafluoro-2-iodopropane in the presence of mercury.

Heptafluoro-2-iodopropane (3.0 gms., .01 mole) and 1,1,1-trifluoro-2-iodoethane (2.1 gms., .01 mole.) were sealed under vacuum in a thin walled tube (50 mls. capacity) with enough clean dry mercury to form a continuous pool when horizontal. The tube was shaken in a horizontal position 35 cms. from a Hanovia Model 11 Ultra-violet lamp for 96 hours.

The tube was opened to a vacuum system and there distilled out volatile material (2.5 gms.) which was shown by analytical G.L.C. (Si. Elast., 64°C., 1 lit./hr.) to contain only two compounds. These had retention times coincident with perfluoro-(2,3-dimethylbutane),\* and 1,1,1-trifluoro-2-iodoethane. The solid residue was extracted with meths and crude 1,1,1-trifluoroethylmercuric iodide (1 gm.) obtained by distilling off the solvent.

---

\* A sample of perfluoro-(2,3-dimethylbutane) was prepared for comparison purposes by irradiating heptafluoro-2-iodopropane in the presence of mercury.

The reaction between heptafluoro-2-iodopropane and  
1,1,1-trifluoroethylmercuric iodide

1. Thermal Reaction. A Carius tube (25 mls. capacity) charged with heptafluoro-2-iodopropane (2.1 gms., .0072 mole) and 1,1,1-trifluoroethylmercuric iodide (3 gms., .0072 moles) was heated for 44 hours at 200°C. The tube was opened to a vacuum system and volatile products (1.5 gms.) were distilled out (some of the volatile material was hydrogen fluoride as evidenced by the production of white fumes when allowed to warm to room temperature). Remaining in the tube, which was extensively etched, was red mercuric iodide and a black solid which appeared to be carbon. It was extracted with meths and from the solution was extracted .1 gm. of the mercurial. A chromatogram of the volatile material (Si. Elast., 40°C., 1.1 lit./hr.) possessed three peaks of almost equal area. The three components were separated by preparative G.L.C. (Si. Elast., 35°C., 150 mls./min.) but only enough of each compound for an infra-red spectrum was obtained. The infra-red spectrum of the compound having the shortest retention time has not been recognised. The compound having the longest retention time has an infra-red spectrum identical with that of heptafluoro-2-iodopropane. The remaining compound has been recognised by its infra-red spectrum as being 2H,2H,-decafluoro-(3-methylbutane). (page 131).

## 2. Photochemical Reaction

A thin walled tube (25 mls. capacity) charged with heptafluoro-2-iodopropane (1.4 gms., .0048 mole) and 1,1,1-trifluoroethylmercuric iodide (2 gms., .0048 mole) was irradiated 35 cms. from a Hanovia Model 11 lamp for 142 hours. At the end of this time the tube contained a red crystalline compound. It was opened to a vacuum system and 1.4 gms. volatile material distilled out. This was shown by analytical G.L.C. (Si. Elast., 60°C., 1 lit./hr.) to consist of three components. Each was obtained pure using preparative G.L.C. (T.C.P., 50°C., 150 mls./min.) and its infra-red spectrum obtained. The spectra were recognised as being those of perfluoro-(2,3, dimethylbutane), heptafluoro-2-iodopropane and 1,1,1-trifluoro-2-iodoethane. No hydrogen fluoride was produced nor was there any etching of the tube.

## Preparation of Telomer Iodides

### Reaction between pentafluoroiodoethane and 1,1-difluoroethylene

An autoclave (150 mls.) charged with pentafluoroiodoethane (120.5 gms., .49 moles.) and 1,1-difluoroethylene (31.6 gms., .49 moles) was rocked at 190°C. for 45 hours. After allowing to cool to 40-50°C., volatile material (33 gms.) was vented from the autoclave. Of this, 11 gms., was unreacted 1,1-difluoroethylene and the remainder pentafluoroiodoethane. A violet coloured liquid (109 gms.) was poured from the autoclave and from it distilled a further 32 gms. pentafluoroiodoethane. Only 55% of the pentafluoroiodoethane had therefore been converted into telomers.

Analytical G.L.C. (Si. Elast., 170°C., 1.1 lit./hr.) revealed the liquid product (77 gms.) to contain three main components in addition to a trace of pentafluoroiodoethane. Using a 25 cm. electrically heated Vigreux column, atmospheric and controlled reduced pressure distillation of the liquid reaction products afforded the following three fractions;

1. b.p. 89-93°C./756 mms. Hg.; 65 gms.
2. b.p. 75-80°C./80 mms. Hg.; 5 gms.
3. b.p. 68-73°C./7 mms. Hg.; 1.7 gms.

Fraction 1, was redistilled and material obtained better

than 95% pure. Further purification was carried out by preparative G.L.C. (T.C.P., 90°C., 200 mls./min.) and the compound was identified as being 2H,2H-1-iodoheptafluorobutane (Found: F, 43.1; I, 40.9%; M, 306. Calc. for  $C_4H_2F_7I$ ; F, 42.9; I, 40.9%; M, 310). I.R.No. 17, b.pt. 91°C./756 mms. Hg;  $n_D^{20}$ , 1.3578;  $\lambda_{max}$ , 272 m $\mu$ ;  $\epsilon$ , 318. (Haszeldine<sup>52</sup> reports b.pt. 88°C.  $n_D^{20}$ , 1.354.  $\lambda_{max}$ , 271 m $\mu$ .  $\epsilon$ , 300).

### Fraction 2

On redistilling under reduced pressure a material distilling at 79°C./80 mms.Hg. (>95%) was obtained. The use of preparative scale G.L.C. (T.C.P, 130°C., 150 mls./min.) afforded a pure sample of the 1:2 adduct,

$C_2F_5 \cdot (CH_2CF_2)_2I$ . (Found: F, 45.5; I, 33.4%; M, 360.

$C_6H_4F_9I$  requires F, 45.7; I, 33.95%; M, 374) I.R.No. 18,  $n_D^{20}$ , 1.3673.  $\lambda_{max}$ , 272 m $\mu$ .  $\epsilon$ , 345. (Haszeldine<sup>52</sup> reports  $n_D^{20}$ , 1.440; b.pt. 140°C for "supposed"  $C_2F_5 \cdot (CH_2CF_2)_2I$ .)

### Fraction 3

Using a micro-reduced pressure distillation apparatus a material (>95%) boiling at 70°C./7 mms. was obtained. (Found; M, 430.  $C_8H_6F_7I$  requires M, 438.). Dehydroiodination (see page 137) confirms the compound to be the 1:3 adduct,  $C_2F_5(CH_2CF_2)_3I$ .

From the chromatogram, the composition of the crude liquid product was calculated as being:-  $C_2F_5(CH_2CF_2)I$ , 90%;  $C_2F_5(CH_2CF_2)_2I$ , 7%;  $C_2F_5(CH_2CF_2)_3I$ , 3% by weight.

Reaction between heptafluoro-1-iodopropane and 1,1-difluoroethylene

An autoclave (150 mls.) charged with heptafluoro-1-iodopropane (90 gms., .31 moles) and 1,1-difluoroethylene (23 gms., .36 moles) was rocked at 200°C. for 36 hours. After allowing to cool, 1,1-difluoroethylene (1 gm.) was vented and a violet coloured liquid (110 gms.) was poured from the autoclave.

Analytical G.L.C. (Si. Elast., 160°C., 1.1 lits./hr.) showed there to be four main compounds present in the liquid product.

Using a 25 cm. electrically heated Vigreux column, atmospheric distillation yielded two fractions:-

1. b.p. 40-43°C./760 mms. Hg. 9gms.
2. b.p. 108-112°C./760 mms. Hg. 50 gms.

Fraction 1 was shown by analytical G.L.C. (T.C.P., 80°C., 1.1 lit./hr.) and infra-red techniques to be heptafluoro-1-iodopropane.

Fraction 2 was shown by analytical G.L.C. (Si. Elast., 130°C., 1.1 lits./hr.) to have purity greater than 90%. Redistilla-

tion afforded material more than 95% pure. A sample obtained pure using preparative G.L.C. (T.C.P., 80°C., 170 mls./min.) was identified as being the 1:1 adduct, 2H,2H-1-iodononafluoropentane. (Found: F, 47.8.I, 35.0%. M, 355. Calculated for C<sub>5</sub>H<sub>2</sub>F<sub>9</sub>I; F, 47.5; I, 35.3%; M, 360.) n<sub>D</sub><sup>20</sup> 1.3513. b.pt. 108°C./770 mms. (Hauptschein<sup>58</sup> reports n<sub>D</sub><sup>23</sup> 1.3502) I.R.No. 21.

The material remaining in the still pot was assumed to be the 2:1 and 3:1 adducts. The composition of the crude liquid product was calculated from an analytical chromatogram as being n-C<sub>3</sub>F<sub>7</sub>I, 10%; CF<sub>3</sub>(CF<sub>2</sub>)<sub>2</sub>CH<sub>2</sub>CF<sub>2</sub>I, 60%; CF<sub>3</sub>(CF<sub>2</sub>)<sub>2</sub>(CH<sub>2</sub>CF<sub>2</sub>)<sub>2</sub>I, 25%; CF<sub>3</sub>(CF<sub>2</sub>)<sub>2</sub>(CH<sub>2</sub>CF<sub>2</sub>)<sub>2</sub>I, 5% by weight. This represents a conversion of 88% of the heptafluoro-1-iodopropane into telomer iodides.

Reaction between heptafluoro-2-iodopropane and 1,1-difluoroethylene. I.

Molar Ratio Iodide: Olefin = 1:1.

An autoclave (150 mls.) charged with heptafluoro-2-iodopropane (68 gms., .23 moles) and 1,1-difluoroethylene (18 gms., .28 moles) was rocked at 185°C. for 36 hours. After allowing to cool, 1,1-difluoroethylene (1 gm.) was vented and a violet liquid (84 gms.) was poured from the autoclave.

Analytical G.L.C. (Si. Elast., 160°C., 1.1 lits./hr.)

revealed the liquid to consist of three main components and a trace of a fourth. Using a 25 cm. electrically heated Vigreux column, atmospheric and reduced pressure distillation of the liquid reaction products was carried and three fractions were obtained:

1. b.p. 40-45°C./750 mms.Hg; 6.5 gms.
2. b.p.102-105°C./750 mms. Hg; 70 gms.
3. b.p. 63-67°C./25 mms. Hg; 7 gms.

Fraction 1 was shown by analytical G.L.C. (Si. Elast., 80°C., 1.1 lits./hr.) and infra-red spectroscopy to be heptafluoro-2-iodopropane.

Fraction 2 was by analytical G.L.C. (Si. Elast., 120°C., 1.1 lits./hr.) to be greater than 90% pure. Redistillation afforded material more than 95% pure boiling at 103°C./750 mms. A sample obtained pure using preparative G.L.C. (T.C.P., 80°C., 160 mls./min.) was identified as being the 1:1 adduct,

2H,2H-1-iodononafluoro-(3-methylbutane). (Found: F, 48.1; I, 34.8%; M, 354. C<sub>5</sub>H<sub>2</sub>F<sub>7</sub>I requires F, 47.5; I, 35.3%; M, 360.).  $n_D^{20}$ , 1.3555;  $\lambda_{max}$ ; 274 m $\mu$ ;  $\epsilon$ , 332; I.R.No. 19.

Fraction 3 was redistilled under controlled reduced pressure and a sample of purity greater than 95% obtained (b.pt. 65°C./25 mms). A pure sample was obtained using preparative G.L.C. (T.C.P., 130°C., 150 mls./min.) and identified as the 1:2

adduct,  $(CF_3)_2CF(CH_2CF_2)_2I$ . (Found: F, 49.7; I, 29.6%;  
 M, 416.  $C_7H_4F_{11}I$  requires F, 49.3; I, 29.95%; M, 424.)  
 $n_D^{20}$ , 1.3646;  $\lambda_{max}$ , 272  $m\mu$ ;  $\epsilon$ , 313; I.R.No. 20.

The fourth component of the mixture is probably the 3:1 telomer.

The composition of the crude reaction product was calculated from the chromatogram as being  $(CF_3)_2CFI$ , 10%;  $(CF_3)_2CFCH_2CF_2I$ , 80%;  $(CF_3)_2CF.(CH_2CF_2)_2I$ , 10% by weight. This represents a conversion of 88% of the heptafluoro-2-iodopropane into telomers.

A similar reaction in which the same amounts of reactants were heated together for 36 hours at 220°C. yielded a product whose composition was not significantly different from that quoted above.

Reaction between heptafluoro-2-iodopropane and 1,1-difluoroethylene II.

Molar Ratio Iodide: Olefin = 1:3.

An autoclave (150 mls.) charged with heptafluoro-2-iodopropane (44 gms., .15 moles) and 1,1-difluoroethylene (29 gms., .45 moles) was rocked at 220°C. for 36 hours. Unreacted 1,1-difluoroethylene (2 gms.) was vented and a violet coloured liquid (68 gms.) was poured from the cooled autoclave. An analytical chromatogram (Si. Elast., 180°C.,

1.1 lits./hr.) of the liquid showed it to contain five main components of which none was heptafluoro-2-iodopropane. Two of these components had identical retention times to  $(CF_3)_2CFCH_2CF_2I$  and  $(CF_3)_2CF(CH_2CF_2)_2I$ . A controlled reduced pressure distillation through an electrically heated 25 cm. Vigreux column afforded three fractions:-

1. b.p. 102-105°C./752 mms. Hg. 7 gms.
2. b.p. 63-67°C./25 mms. Hg. 22 gms.
3. b.p. 105-110°C./25 mms. Hg. 23 gms.

Fraction 3 was estimated by analytical G.L.C. (Si. Elast., 170°C., 1.1 lits./hr.) to be more than 85% pure. Redistillation afforded a material more than 95% pure boiling at 107°C./26 mms. Hg. Attempts to purify the distillate by preparative scale G.L.C. failed. (Found; M, 480.  $(CF_3)_2CF(CH_2CF_2)_3I$  requires M, 488). The identity of this compound was confirmed as being the 3:1 adduct by dehydroiodination. (see page 135).

The compounds remaining the still-pot were assumed to be the 4:1 and 5:1 telomers.

The composition of the reaction product, calculated from an analytical chromatogram was:-

$(CF_3)_2CFCH_2CF_2I$ , 11%;  $(CF_3)_2CF(CH_2CF_2)_2I$ , 36%;  
 $(CF_3)_2CF(CH_2CF_2)_3I$ , 37%;  $(CF_3)_2CF(CH_2CF_2)_4I$ , 13%

$(\text{CF}_3)_2\text{CF}(\text{CH}_2\text{CF}_2)_5\text{I}$ , 3% by weight.

Reaction between heptafluoro-2-iodopropane and 1,1-difluoroethylene III.

Molar Ratio Iodide: Olefin = 1:4.

An autoclave (150 mls.) charged with heptafluoro-2-iodopropane (45 gms., .15 moles) and 1,1-difluoroethylene (37 gms., .58 moles) was rocked at 220°C. for 36 hours. Unreacted 1,1-difluoroethylene (5 gms.) was vented and a violet coloured liquid (65 gms.) was poured from the cooled autoclave.

The composition of the liquid product was revealed by analytical G.L.C. (Si. Elast., 190°C., 1 lit./hr.) to be:-  $(\text{CF}_3)_2\text{CFCH}_2\text{CF}_2\text{I}$ , 2%;  $(\text{CF}_3)_2\text{CF}(\text{CH}_2\text{CF}_2)_2\text{I}$ , 23%;  $(\text{CF}_3)_2\text{CF}(\text{CH}_2\text{CF}_2)_3\text{I}$ , 36%;  $(\text{CF}_3)_2\text{CF}(\text{CH}_2\text{CF}_2)_4\text{I}$ , 27%;  $(\text{CF}_3)_2\text{CF}(\text{CH}_2\text{CF}_2)_5\text{I}$ , 13%;  $(\text{CF}_3)_2\text{CF}(\text{CH}_2\text{CF}_2)_6\text{I}$ , 3% by weight.

Reaction between tetrafluoro 1,2-diiodoethane and 1,1-difluoroethylene

An autoclave (150 mls.) charged with tetrafluoro 1,2-diiodoethane (107 gms., .3 moles) and 1,1-difluoroethylene (19 gms., .3 moles) and filled with an atmosphere of dry nitrogen at -183°C. was rocked at 185°C. for 36 hours. After allowing to cool, 1,1-difluoroethylene (10 gms.) was vented and a violet coloured liquid (110 gms.) was poured

from the autoclave. Analytical G.L.C. (Si. Elast., 200°C., 1.1 lits./hr.) revealed the liquid product to contain two main components, the larger of which had a retention time coincident with that of tetrafluoro 1,2-diiodoethane.

Controlled reduced pressure distillation using an electrically heated Vigreux column gave two fractions, one with boiling range 110-115°C., the other with boiling range 50-52°C. at 9 mms. Hg. (50 gms.). The first fraction was almost exclusively tetrafluoro 1,2-diiodoethane. The second fraction was redistilled and then a sample of the pure 1:1 adduct, 2H,2H-1,4-diiodohexafluorobutane obtained by preparative G.L.C. (T.C.P., 145°C., 160 mls./min.) (Found: F, 26.8; I, 64.3%; M, 400.  $C_4H_2F_6I_2$  requires F, 27.3; I, 60.7%; M, 418.)  $n_D^{20}$ , 1.4603;  $\lambda_{max}$ , 271  $m\mu$ ;  $\epsilon$ , 694; b.pt. 162°C./760 mms. Hg. I.R. No. 22.

The production of 50 gms. of the 1:1 adduct represents a conversion of 39% of the tetrafluoro-1,2-diiodoethane into adduct.

Reaction between heptafluoro-2-iodopropane and trifluoroethylene.

Trifluoroethylene was prepared by either the dechlorobromination of  $BrCF_2.CHFCl$  by the zinc/ethanol technique described by Park et. al;<sup>96</sup> or by the dechlorination of  $ClCF_2.CFHCl$  by the butyl-lithium technique described by

Savory.<sup>91</sup> Efforts to dechlorinate  $\text{ClCF}_2\cdot\text{CFHCl}$  by the zinc/ethanol technique failed.

An autoclave (150 mls.) charged with heptafluoro-2-iodopropane (90 gms., .305 moles) and trifluoroethylene (25 gms., .305 moles) was rocked at  $190^\circ\text{C}$ . for 36 hours. The pressure in the autoclave did not fall during this time so the temperature was raised to  $240^\circ\text{C}$ . for a further 36 hours. Albeit the pressure had fallen but little, the autoclave was cooled and from it vented trifluoroethylene (15 gms.). A violet liquid (60 gms.) poured from the autoclave was noted to contain large amounts of solid iodine. There remained in the autoclave some carbon in addition to more iodine. All the liquid reaction product distilled at  $40\text{--}45^\circ\text{C}/760^\circ\text{C}$ . and an analytical chromatogram (Si. Elast.,  $100^\circ\text{C}$ ., 1 lit./hr.) showed it to be one compound with a retention time coincident with that of heptafluoro-2-iodopropane.

Attempted reaction between heptafluoro-2-iodopropane and 2H-nonafluoro-(3-methylbut-1-ene)

An autoclave (100 mls.) charged with heptafluoro-2-iodopropane (29 gms., .098 moles) and 2H-nonafluoro-(3-methylbut-1-ene) (23 gms., .10 moles) was rocked for 20 hours at temperatures of  $185^\circ\text{C}$ .,  $240^\circ\text{C}$ ., and  $280^\circ\text{C}$ . In each case, nothing other than starting material was recovered.

Attempted reaction between trifluoromethyl iodide and  
2H-nonafluoro-(3-methylbut-1-ene).

1. Thermal Reaction

An autoclave (50 mls.) charged with trifluoromethyl iodide (16 gms., .08 moles) and 2H-nonafluoro-(3-methylbut-1-ene) (9 gms., .038 moles) was filled with an atmosphere of dry nitrogen at  $-183^{\circ}\text{C}$ . then rocked for 40 hours at  $220^{\circ}\text{C}$ . Nothing other than starting material (identified by analytical G.L.C.) was recovered after this treatment.

Photochemical Reactions.

a) A silica Carius tube charged with trifluoromethyl iodide (8.5 gms., .043 moles) and 2H-nonafluoro-(3-methylbut-1-ene) (5.1 gms., .022 moles) was positioned 10 cms. from a  $\frac{1}{2}$  kw. ultra-violet lamp and irradiated for 240 hours. The liquid phase was shielded to discourage the formation of high telomers. After the irradiation was complete, the contents of the tube were distilled out under reduced pressure. The distillate (13.6 gms.) was shown by analytical G.L.C. and infra-red spectroscopic techniques to consist only of starting materials.

b) The experiment was repeated, both phases being irradiated, but again no telomers were obtained.

Reactions of Telomers of 1,1-difluoroethylene  
Reactions of 2H,2H-1-iodononafluoro-(3-methyl-  
butane).

1. Dehydroiodination

a) Using potassium hydroxide in acetone.

2H,2H-1-iodononafluoro-(3-methylbutane) (9 gms., .025 moles), potassium hydroxide (8 gms., .14 moles) and acetone (10 mls.), were sealed under vacuum in a Carius tube and then shaken at room temperature. The reaction was exothermic and the tube had to be cooled from time to time. After 30 minutes the reaction was complete. The tube was cooled (-78°C.) and opened to a liquid air trap but no gas was evolved on warming the tube to room temperature. The contents of the tube were distilled from a flask fitted with a Vigreux column; about 10 mls. of a distillate (b.p. 25-56°C.) was collected. This was resolved into two fractions by preparative G.L.C. (Si. Elast., 40°C., 200 mls./min.). The compound with the longer retention time proved to be acetone. The compound with the shorter retention time was further purified by recycling through the G.L.C. apparatus (Si. Elast., 23°C., 200 mls./min.) and found to be 2H-nonafluoro-(3-methylbut-1-ene). (Found: F, 73.5%; M, 226. C<sub>5</sub>HF<sub>9</sub> requires F, 73.7%; M, 232).

$n_D^{20} < 1.3$ ; b.pt.  $30^\circ\text{C.}/752$  mms. Hg. I.R. No. 6. Yield 30%.

When all the acetone was distilled from the 'reaction product' there remained in the flask a dark brown tar, evidence of decomposition.

The above reaction was repeated using 2H,2H-1-iodononafluoro-(3-methylbutane) (10 gms., .0277 moles), potassium hydroxide (2 gms., .037 moles) and acetone (20 mls.). The products were the same except that some starting material (2 gms.) was recovered. The yield of 2H-nonafluoro-(3-methylbut-1-ene) based on the amount of iodide reacted was 30%.

A sample of 2H-perfluoropent-1-ene was prepared by the above method from 2H,2H-1-iodononafluoropentane so that its infra-red spectrum (I.R.No. 5) could be compared with those of similar olefins (see page 155).

b) Using potassium fluoride in N,N-dimethyl formamide

A three necked flask (250 mls) fitted with a mercury sealed stirrer, dropping funnel and condenser leading directly to a cold trap ( $-78^\circ\text{C.}$ ) was charged with dry, freshly distilled N,N-dimethyl formamide (50 mls.) and dry potassium fluoride (2.9 gms., .05 moles). The iodide (18 gms., .05 moles) was added and the temperature of the flask was raised to  $100^\circ\text{C.}$  over  $1\frac{1}{2}$  hours, maintained at this temperature for

$\frac{3}{4}$  hours, then raised again to  $150^{\circ}\text{C}$ . for a further  $\frac{1}{2}$  hour. By the end of this time there had collected in the cold trap 10 gms. of a colourless liquid.

Albeit analytical G.L.C. (T.C.P.,  $20^{\circ}\text{C}$ ., 1 lit./hr.) indicated this material to be pure, preparative G.L.C. (T.C.P.,  $20^{\circ}\text{C}$ ., 160 mls./min.) revealed the presence of a small amount of an impurity with a retention time almost identical with that of the main product. A sample of the main product was obtained pure and identified by its infra-red spectrum as being 2H-nonafluoro-(3-methylbut-1-ene). The impurity was not identified.

c) Using solid potassium hydroxide

A three necked flask (250 mls.) fitted with mercury sealed stirrer, dropping funnel and condenser leading directly to a cold trap ( $-78^{\circ}\text{C}$ .) was charged with powdered potassium hydroxide (56 gms., 1.0 mole). The temperature of the flask was raised to  $90^{\circ}\text{C}$ . and the iodide (30 gms., .084 moles) was slowly added. After two hours, volatile material remaining in the flask was swept into the trap with a stream of nitrogen. In the trap collected a colourless liquid (18 gms.) distillation of which yielded a fraction boiling at  $30^{\circ}\text{C}$  and having an infra-red spectrum identical with that of 2H-nonafluoro-(3-methylbut-1-ene). Yield 85%.

d) Using triethylamine

A three necked flask (250 mls.) fitted with mercury sealed stirrer, dropping funnel and condenser leading directly to a cold trap ( $-78^{\circ}\text{C}.$ ) was charged with iodide (80 gms., .22 moles). Triethylamine (27 gms., .268 moles) was added dropwise over ten minutes. Almost as soon as the addition of amine was begun, an exothermic reaction commenced and crystals were precipitated. After stirring for an hour, the product was swept into the cold trap by a stream of nitrogen. Distillation of the contents of the cold trap afforded a material recognised by its infra-red spectrum as being 2H-nonafluoro-(3-methylbut-1-ene) (>98% pure). Yield 75%.

2. Replacement of Iodine by Hydrogen

a) Using Lithium Aluminium Hydride

A three necked flask (250 mls.) fitted with mercury sealed stirrer, dropping funnel and condenser leading directly to a cold trap ( $-78^{\circ}\text{C}.$ ) was purged with dry nitrogen and charged with lithium aluminium hydride (1.5 gms., .04 moles) and dry ether (50 mls.). The mixture was cooled to  $-70^{\circ}\text{C}.$  and a solution of the iodide (10 gms., .028 moles) in ether (25 mls.) slowly added. The reactants were allowed to warm to room temperature at which dilute sulphuric acid was added dropwise until hydrolysis was complete. The

solution was refluxed for six hours.

By the end of the experiment, 15 mls. of a colourless liquid had collected in the cold trap. Another 25 mls. of liquid were distilled from the reaction vessel and collected in a cooled receiver. The two distillates were combined and using analytical G.L.C. (T.C.P., 40°C., 1 lit./hr.) found to contain two products (ratio of peak areas, 3:7) in addition to much ether. Unfortunately, the products had similar retention times and so much recycling through the preparative G.L.C. apparatus (T.C.P., 25°C., 150 mls./min.) was necessary before a pure sample of the main product could be obtained and found to be 1H,2H,2H-nonafluoro-(3-methylbutane) (Found: F, 72.2%; M, 238. C<sub>5</sub>H<sub>3</sub>F<sub>9</sub> requires F, 73.1%; M, 234.)  $n_D^{20} < 1.3$ ; b.pt. 50°C./752 mms. Hg. I.R.No. 14.

Of the minor product, only enough for an infra-red spectrum could be isolated. The spectrum showed the compound to be saturated but could not be recognised.

b) By preparation of the Grignard reagent and its reaction with ethanol.

A three necked flask (250 mls.) fitted with mercury sealed stirrer, dropping funnel and condenser leading directly to a cold trap (-78°C.) was swept with dry nitrogen

and charged with iodide (10 gms., .0277 moles) and ether (20 mls.). This solution was cooled ( $-70^{\circ}\text{C}.$ ), stirred and to it phenyl magnesium bromide (.04 moles) in ether (50 mls.) was added over a period of 20 minutes. The reactants were stirred at  $-70^{\circ}\text{C}.$  for  $1\frac{1}{4}$  hours before an ethanol/water solution (excess) was added. The solution was allowed to warm to room temperature and then refluxed for  $3\frac{1}{2}$  hours. Over this time a colourless liquid (5 mls.) had collected in the cold trap. This was shown by analytical G.L.C.(T.C.P.,  $40^{\circ}\text{C}.$ , 1 lit./hr.) to consist entirely of ether.

The solution remaining in the flask was filtered and separated into two layers. Ether was distilled from the organic layer and there remained a yellow liquid which was distilled under reduced pressure. The distillate was investigated by analytical G.L.C. (Si. Elast.,  $150^{\circ}\text{C}.$ , 1 lit./hr.) and shown to contain a compound having a retention time coincident with that of iodobenzene. This compound (1.6 gms.) was isolated using preparative scale G.L.C. (Si. Elast.,  $140^{\circ}\text{C}.$ , 200 mls./min.) and confirmed as being iodobenzene by its infra-red spectrum. 1.6 gms. iodobenzene corresponds to the exchange reaction having taken place to the extent of 30%. No 1H,2H,2H-nonafluoro-(3-methylbutane) was isolated.

c) Using zinc and sulphuric acid.

A three necked flask (250 mls.) fitted with mercury sealed stirrer, dropping funnel and condenser leading directly to a cold trap ( $-78^{\circ}\text{C}.$ ) was charged with zinc (20 gms.) and iodide (7 gms., .0195 moles). Sulphuric acid (35 mls. 5N) was added and the mixture stirred at  $70^{\circ}\text{C}.$  for 5 hours. At the end of this time volatile materials remaining in the reaction vessel were swept into the cold trap. The contents of the flask were distilled. From the distillate there separated out a liquid (2 gms.) more dense than water which had an infra-red spectrum identical with that of 3H,3H,6H,6H-octafluoro-(2,7-dimethyloctane) (page 132). In the cold trap had collected a colourless liquid (.9 gms.) shown by analytical G.L.C. (Si. Elast.,  $40^{\circ}\text{C}.$ , 1 lit./hr.) to consist of two components. These were separated by preparative G.L.C. (T.C.P.,  $25^{\circ}\text{C}.$ , 150 mls./min.) and identified by their infra-red spectra as being 2H-nonafluoro-(3-methylbut-1-ene) and 1H,2H,2H-nonafluoro-(3-methylbutane).

d) By irradiation in a solvent(cyclohexane).

The iodide (15 gms., .042 moles) and cyclohexane (20 mls.) were sealed under vacuum in a tube which was positioned 10 cms. from a  $\frac{1}{2}$  k.w. ultra-violet lamp. The temperature in the region of the tube was  $60^{\circ}\text{C}.$

After 130 hours the tube was cooled and its contents transferred to a flask fitted with a Vigreux column. Material boiling below 80°C. (.6 gms.) was collected in a cooled receiver and separated into its two components by preparative G.L.C. (T.C.P., 20°C., 150 mls./min.). These were identified by their infra-red spectra as being 2H-nonafluoro-(3-methylbut-1-ene) and 1H,2H,2H-nonafluoro-(3-methylbutane). 12 gms. of starting material was recovered. It was noted the areas of the peaks of the chromatogram were almost equal.

e) Reaction with zinc; preparation and hydrolysis of  
 $(CF_3)_2CFCH_2CF_2ZnI$ .

Zinc dust. Commercial zinc dust was treated with 10% sulphuric acid and allowed to stand for 30 minutes before the super-natant liquid was poured off. The zinc was washed with distilled water until the washings no longer gave a precipitate with barium-chloride solution. After washing the zinc three times with acetone, it was dried under vacuum at 100°C.

Dioxane. Commercial dioxane usually contains a certain amount of glycol, acetal and some water. On storage the acetal is hydrolysed and there is liberated acetaldehyde which gives rise to rapid peroxide formation. The following purification procedure was carried out.

Commercial dioxane (2 litres), concentrated hydrochloric acid (27 mls.), and water (200 mls.) were refluxed together for 12 hours, during which time a slow stream of nitrogen was bubbled through the solution to entrain acetaldehyde. The solution was cooled, and potassium hydroxide pellets were added slowly and with shaking until they no longer dissolved and a second layer had separated. The dioxane was decanted into a clean flask, and refluxed with sodium in an atmosphere of dry nitrogen for 12 hours. The solvent was then distilled and stored under dry nitrogen.

Preparation of  $(CF_3)_2CFCH_2CF_2ZnI$ .

A three necked flask (250 mls.) fitted with a mercury sealed stirrer, dropping funnel and condenser leading directly to a cold trap ( $-78^{\circ}C.$ ) was charged with zinc (20 gms., .3 gm. atoms) and dioxane (40 mls.). The temperature was raised to  $70^{\circ}C.$  and the iodide (30 gms., .083 moles) was added dropwise. When all of the iodide had been added, the solution was refluxed for three hours during which time 0.5 gms. of a colourless liquid collected in the cold trap. The reflux condenser was removed and 15 gms. of liquid were distilled from the

flask. Analytical G.L.C. revealed this material to contain four compounds, one of which had a retention time coincident with that of dioxane. Preparative G.L.C. (T.C.P., 40°C., 200 mls./min.) was used to separate dioxane from the product (7 gms.), then again to resolve the product into its three components (T.C.P., 20°C., 150 mls./min.).

The compound having the shortest retention time was produced in the least quantity and only enough for infra-red (No. 11) and N-M-R spectra could be isolated. Comparing these spectra (see page 129) with those of the compound with the longest retention time suggests the compound to be 1H,2H-octafluoro-(3-methylbut-trans-1-ene). identified by its infra-red spectrum as 1H,2H,2H-nonafluoro-(3-methylbutane). The compound having the longest retention time was identified as being 1H,2H-octafluoro-(3-methylbut-cis-1-ene). (Found, F, 70.8%; M, 208. C<sub>5</sub>H<sub>2</sub>F<sub>8</sub> requires F, 71.0%; M, 214).  $n_D^{20} < 1.3$ ; b.pt. 51°C./752 mms. I.R.No. 12.

From the chromatogram it was calculated that the composition of the product was 1H,2H-octafluoro-(3-methylbut-trans-1-ene), 10%; 1H,2H,2H-nonafluoro-(3-methylbutane), 20%; 1H,2H-octafluoro-(3-methylbut-cis-1-ene), 70% by weight.

Hydrolysis. The reaction mixture was cooled to room temperature and treated with 2N sodium hydroxide (20 mls.), the addition taking 10 minutes. After refluxing the mixture for an hour, about 20 mls. of liquid were distilled from the reaction vessel. This distillate separated into two layers. The organic layer was separated into its components by preparative G.L.C. and there was isolated 1H,2H,2H-nonafluoro-(3-methylbutane) (2 gms.), 1H,2H-octafluoro-(3-methylbut-cis-1-ene) (.5 gms.), 3H,3H,6H,6H-octadecafluoro-(2,7-dimethyloctane (3.5 gms.), and dioxane, each compound being identified by its infra-red spectrum.

Proof of structure of 1H,2H-octafluoro-(3-methylbut-1-ene).

The analysis, molecular weight and infra-red spectrum of the material having the longest retention time (see page 128) are commensurate with a compound with formula  $(CF_3)_2CFCH=CFH$ . The infra-red spectra of the compounds with the longest and shortest retention times are strikingly similar (see page 161), therefore it seems reasonable to suggest that these are the cis and trans isomers of 1H,2H-octafluoro-(3-methylbut-1-ene).

The  $^{19}F$  resonance spectrum of the isomer with the longer retention time shows three groups of chemically shifted peaks in intensity ratio 6:1:1 having chemical shifts

$\text{CF}_2$ ,	+ 1.82 ± .01 p.p.m.	6
=CF ,	+ 32.6 ± .3 p.p.m.	1
CF ,	+ 108.9 ± 0 p.p.m.	1*

These are consistent with a structure  $(\text{CF}_3)_2\text{CFCH}=\text{CFH}$ <sup>187</sup>

The molecule was confirmed to be the 'cis' isomer by the presence in the H<sup>1</sup> spectrum of a  $J_{\text{HH}}$  splitting of 5.9 c/s, a frequency characteristic of cis H-H coupling in olefinic systems.<sup>98</sup> In vinyl fluoride the value of  $J_{\text{HH}}$  cis is 4.7 c/s.<sup>99</sup>

The isomer with the shorter retention time has an F<sup>19</sup> resonance spectrum which shows three groups of fluorine in the ratio 6:1:1 having the chemical shifts

$\text{CF}_3$ ,	+ 2.47 p.p.m.	6
=CF ,	40.17 p.p.m.	1
CF ,	108.67 p.p.m.	1*

These are consistent with a structure  $(\text{CF}_3)_2\text{CFCH}=\text{CFH}$ .<sup>187</sup>

A  $J_{\text{HH}}$  splitting of 11.3 c/s. in the H<sup>1</sup> spectrum shows the material to be the trans isomer.

---

\* The chemical shifts were measured from trifluoroacetic acid as reference signal; positive shifts are high fields of the external reference signal. to

### 3. Replacement of Iodine by fluorine using antimony trifluorodichloride.

#### Purification of Antimony Trifluoride.

Commercial antimony trifluoride was placed in a sintered disc extractor and extracted with dry methanol. After extraction, most of the methanol was distilled off. On cooling the solution, antimony trifluoride was precipitated. The solid was filtered on a Buchner funnel.

#### Preparation of Antimony Trifluorodichloride.

Chlorine gas was passed into molten antimony trifluoride. As more gas was passed into the melt, less heating became necessary for the mass to remain molten. Eventually, on cooling the material remained a sticky gum.

#### Reaction between 2H,2H-1-iodononafluoro-(3-methylbutane) and Antimony Trifluorodichloride.

A three necked flask (250 mls.) fitted with dropping funnel, mercury sealed stirrer and condenser leading directly to a cold trap ( $-78^{\circ}\text{C}.$ ) was purged with dry nitrogen, heated to  $70^{\circ}\text{C}.$  and then charged with

antimony trifluorodichloride (35 gms.). The iodide (15 gms., .0415 moles) was slowly dropped onto the fluorinating agent. Reaction was immediate and much iodine was liberated. After the reactants had refluxed for an hour, volatile material (9 gms.) remaining in the flask was swept into the cold trap in a stream of dry nitrogen. Analytical G.L.C. (Si. Elast., 60°C., 1 lit./hr.) revealed the contents of the cold trap to consist of two compounds, one in far greater concentration than the other. The two components were separated by preparative G.L.C. (T.C.P., 25°C., 150 mls./min).

The main product was identified as being 2H,2H-decafluoro-(3-methylbutane) (Found: F, 75.1%; M, 247.  $C_5H_2F_{10}$  requires F, 75.4%; M, 252). b.pt. 45°C./770 mms. Hg.  $n_D^{20} < 1.3$ . I.R. No. 15.

The second component of the reaction product was not identified.

4. Coupling Reaction; preparation of 3H,3H,6H,6H-octadecafluoro-(2,7-dimethyloctane).

The iodide (75 gms., .208 moles) was sealed under vacuum in a thin walled tube (200 mls. capacity) with just enough clean, dry mercury to form a continuous pool when horizontal. The tube was shaken in a horizontal

position at 14 cms. from a one k.w. ultra-violet lamp until the contents turned black (4 days). The temperature in the region of the tube was 80°C.

The tube was opened and a colourless liquid (23 gms.) distilled out under vacuum. Analytical G.L.C. (T.C.P., 80°C., 1 lit./hr.) showed the distillate to consist of three components, two in small amounts. Distillation of the reaction product afforded two fractions, one boiling from 20-60°C., and the other (28 gms.) with boiling range 139-140°C. The more volatile fraction was separated into its two components by preparative G.L.C. (T.C.P., 25°C., 150 mls./min.). These two compounds were identified by their infra-red spectra as being 2H-nonafluoro-(3-methylbut-1-ene) and 1H,2H,2H-nonafluoro-(3-methylbutane). The high boiling fraction was pure and identified as 3H,3H,6H,6H-octadecafluoro-(2,7-dimethyloctane). (Found: F, 73.3% M, 458. C<sub>10</sub>H<sub>4</sub>F<sub>18</sub> requires F, 73.5%; M, 466).  $n_D^{20} < 1.3$ ;  
I.R.No. 24. Yield 75%.

Some reactions of telomer iodides other than  $(CF_3)_2CFCH_2CF_2I$ .

1. Dehydroiodination

Dehydroiodination of  $(CF_3)_2CF(CH_2CF_2)_2I$ .

a) Using solid potassium hydroxide.

A three necked flask (250mls.) fitted with dropping funnel, mercury sealed stirrer and reflux condenser was charged with powdered potassium hydroxide (30 gms., .54 moles). The flask was heated to 90°C. and the iodide (10 gms., .024 moles) was added dropwise. When about three quarters of the iodide had been added, a vigorous reaction commenced and the heat was removed until it had subsided and the rest of the iodide had been added. After maintaining the reaction vessel at 90°C. and stirring the reactants for an hour, the product (5 gms.) was distilled from the flask and found by analytical G.L.C. (T.C.P., 70°C., 1 lit./hr.) to be largely (>95%) one compound. A pure sample obtained by preparative G.L.C. (T.C.P., 60°C., 150 mls./min.) was identified as being  $(CF_3)_2CFCH_2CF_2CH=CF_2$  (Found: F, 70.0%; M, 291.  $C_7H_3F_{11}$  requires F, 70.6%; M, 296); b.pt., 93°C./756 mms. Hg;  $n_D^{20} < 1.3$  (ca.1.299; I.R.No. 7. Crude yield 70%.

b) Using triethylamine.

Using  $(CF_3)_2CF(CH_2CF_2)_2I$  (12.8 gms., .031 moles) and

triethylamine (3.1 gms., .031 moles), the reaction was carried out as that described for the dehydroiodination of  $(CF_3)_2CF.CH_2CF_2I$  (page 122). After stirring the reactants for an hour, the product was distilled from the reaction vessel under reduced pressure and washed with dilute hydrochloric acid to remove any unreacted amine. The material thus obtained was shown by analytical G.L.C. (T.C.P.,  $70^\circ C.$ , 1 lit./hr.) to be of purity greater than 95%. A sample purified by preparative scale G.L.C. (T.C.P.,  $60^\circ C.$ , 150 mls./min.) had an infra-red spectrum identical with that of  $(CF_3)_2CF.CH_2CF_2CH=CF_2$ . Crude yield, 80%.

Some of the crystals produced during the reaction were washed several times with dry ether, dried and analysed for halide ion. (Found: F, 0; I, 55.6%. Calculated for  $C_6H_{16}IN$ ; F, 0; I, 55.5%). The absence of fluoride ion confirms that no dehydrofluorination has taken place.

Dehydroiodination of supposed  $(CF_3)_2CF(CH_2CF_2)_3I$  using solid potassium hydroxide.

Using supposed  $(CF_3)_2CF(CH_2CF_2)_3I$  (9 gms., .018 moles) and powdered potassium hydroxide (20 gms., .36 moles), the reaction was carried out and followed the same course as that described in the dehydroiodination of  $(CF_3)_2CFCH_2CF_2I$  (page 121). After stirring the reactants for

an hour at 90°C., the product was distilled from the reaction vessel under reduced pressure. The organic layer (5.5 gms.) was shown by analytical G.L.C. (T.C.P., 150°C., 1 lit./hr.) to be largely (>95%) one compound. The use of preparative G.L.C. (T.C.P., 130°C., 160 mls./min.) afforded a pure sample of  $(CF_3)_2CF(CH_2CF_2)_2CH=CF_2$ . (Found: F, 68.0%; M, 354.  $C_9H_5F_{13}$  requires F, 68.6%; M, 360) b.pt. 146°C./760 mms. Hg;  $n_D^{20}$ , 1.3173. I.R.No. 8. Crude yield 83%.

Dehydroiodination of 2H,2H-1-iodoheptafluorobutane using solid potassium hydroxide.

Using the technique described for the dehydroiodination of  $(CF_3)_2CFCH_2CF_2I$  (page 121),  $C_2F_5CH_2CF_2I$  (20 gms., .065 moles) was dehydroiodinated by powdered potassium hydroxide (40 gms., .71 moles) to yield 10 gms. crude product. Analytical G.L.C. showed this material to be of purity greater than 90%. Preparative G.L.C. (T.C.P., 25°C., 150 mls./min.) afforded pure 2H-heptafluorobut-1-ene (Found: F, 72.9%; M, 177.  $C_4HF_7$  requires F, 73.1%; M, 182) b.pt. 10-11°C./760 mms. Hg. (This value has been obtained by R.H. Mobbs in these laboratories when he distilled a large amount of the olefin through the low temperature distillation column). I.R. No. 4. Crude yield 85%.

Dehydroiodination of  $C_2F_5(CH_2CF_2)_2I$  using triethylamine.

Using  $C_2F_5(CH_2CF_2)_2I$  (60 gms., .16 moles) and triethylamine (20 gms., .2 moles), the reaction was carried out using the technique described for the dehydroiodination of  $(CF_3)_2CF(CH_2CF_2)_2I$  (page 122). The crude product was revealed by analytical G.L.C. (T.C.P., 70°C., 1 lit./hr.) to be of purity greater than 90%. A sample was obtained pure by preparative G.L.C. (T.C.P., 65°C., 150 mls./min.) and identified as being  $C_2F_5CH_2CF_2CH=CF_2$ . (Found: F, 69.0%; M, 238.  $C_6H_3F_9$  requires F, 69.5%; M, 246.)  $n_D^{20} < 1.3$ ; b.pt. 75°C./760 mms. Hg. I.R.No. 10. Crude yield 75%.

Dehydroiodination of supposed  $C_2F_5(CH_2CF_2)_3I$  using triethylamine.

Supposed  $C_2F_5(CH_2CF_2)_3I$  (see page 109) (10 gms., .032 moles) was dehydroiodinated in the manner described for the dehydroiodination of  $(CF_3)_2CF(CH_2CF_2)_2I$  (page 134) using triethylamine (3.2 gms. .032 moles). The crude product was purified by preparative G.L.C. (T.C.P., 130°C., 150 mls./min.) and identified as being  $C_2F_5(CH_2CF_2)_2CH=CF_2$  (Found: F, 66.8%; M, 296.  $C_8H_5F_{11}$  requires F, 67.4%; M, 310).  $n_D^{20}$ , 1.3167; b.pt. 134°C./760 mms. I.R.No. 9. Crude yield 55%.

## 2. Coupling reactions

### Coupling of 2H,2H-1-iodoheptafluorobutane; preparation of 3H,3H,6H,6H-tetradecafluorooctane

Using the technique described for the preparation of 3H,3H,6H,6H-octadecafluoro-(2,7-dimethyloctane) (page 132), 2H,2H-1-iodoheptafluorobutane (46 gms., .15 moles) was irradiated for five days in a tube positioned 10 cms. from a 500 watt. ultra-violet lamp. The temperature in the region of the tube was 60°C.

The tube was opened and a colourless liquid (24 gms.) distilled out under vacuum. Analytical G.L.C. (T.C.P., 85°C., 1 lit./hr.) revealed this to contain three components, two in small amount.

The main fraction distilled at 118°C./760 mms. Hg. and was 3H,3H,6H,6H-tetradecafluorooctane (Found: F, 72.5%. M, 359.  $C_8H_4F_{14}$  requires F, 72.7%; M, 366)  $n_D^{20}$ , < 1.3. I.R. No. 26. Yield 70%.

The bulked volatile fractions from several reactions were separated into their component by preparative G.L.C. (T.C.P., 20°C., 150 mls./min.) One component was recognised by its infra-red spectrum as being 1H-heptafluorobut-1-ene and the other was 1,2,2-trihydroheptafluorobutane (found: F, 72.0%; M, 180.  $C_4H_3F_7$  requires F, 72.3%; M, 184) I.R.No. 13.

Coupling of 2H,2H-1-iodononafluoropentane, preparation of  
4H,4H,7H,7H-octadecafluorodecane

Using the technique described for the preparation of 3H,3H,6H,6H-octadecafluoro-(2,7-dimethyloctane) (page 132), 2H,2H-1-iodononafluoropentane (54 gms., .15 moles) was irradiated for five days in a tube positioned 10 cms., from a 500 watt ultra-violet lamp. The temperature in the region of the tube was 60°C.

On cooling the tube to room temperature, the liquid contents set solid. The tube was opened and the organic material extracted from excess mercury and mercuric iodide with ether. Distillation afforded a fraction (26 gms.) with boiling range 156-162°C./770 mms. Hg. This was further purified by preparative G.L.C. (T.C.P., 95°C., 300 mls./min.) and identified as being 4H,4H,7H,7H-octadecafluorodecane. (Found: F, 73.0%; M, 457. C<sub>10</sub>H<sub>4</sub>F<sub>18</sub> requires F, 73.5%. M, 466) b.pt. 157°C./770 mms. Hg; . . .; m.pt. 42°C. I.R. No. 23. Yield, 70%.

It is probable that 2H-nonafluoropent-1-ene and 1H,2H,2H-nonafluoropentane are produced in this reaction but no efforts were made to isolate either.

### 3. Reactions of 2H,2H-1,4-diodohexafluoro- butane

#### 1. With mercury under the influence of ultra-violet radiation.

The diiodide (13 gms.; .031 moles) was sealed under vacuum in a thin walled tube (100 mls. capacity) with just enough clean dry mercury to form a continuous pool when horizontal. The tube was shaken in a horizontal position at 20 cms. from a 1 kw. ultra-violet lamp. The temperature in the region of the tube was 80°C.

The tube was opened but nothing could be distilled out under vacuum. The contents of the tube were extracted with acetone. After filtering the solution and distilling off the solvent, a pale yellow polymeric material was obtained which on standing evolved hydrogen fluoride. The unit of structure in this polymer is presumably  $(CF_2CF_2CH_2CF_2)$ . An infra-red spectrum of material which had stood in air for several days showed absorption in the region 1786-1690  $cm^{-1}$  and at 1429  $cm^{-1}$  indicating the presence of unsaturation and  $-CH_2-$  groups respectively.

When tetrafluoro-1,2-diodoethane was irradiated in a like manner, tetrafluoroethylene was produced.

#### 2. With Sulphur

A Carius tube (50 mls.) charged with sulphur (25 gms.)

and 2H,2H-1,4-diiodohexafluorobutane (17 gms., .04 moles) under vacuum was heated at 200°C. for 4 hours. After this time, the tube was cooled, opened and attached to a vacuum system. On warming the tube, nothing distilled out other than hydrogen fluoride. Remaining in the tube was iodine and other decomposition products. Etching of the tube was noted to have taken place.

The dehydrofluorination of model compounds related  
to "Viton A"\*

The dehydrofluorination of 3H,3H,6H,6H-octadecafluoro-  
(2,7-dimethyloctane)

1. Using ion exchange resin.

i) In the absence of a solvent.

A Carius tube charged with 3H,3H,6H,6H-octadecafluoro-(2,7-dimethyloctane) (5 gms., .0107 moles) and dry fully regenerated I.R.A. 400 (OH) (25 gms., i.e. 50% more than required to remove two HF) was heated to 60°C for five hours. At the end of this time, the tube was opened and the contents distilled out under vacuum. An infra-red spectrum of the distillate was identical with that of the starting material.

ii) With solvent

3H,3H,6H,6H-(2,7-dimethyloctane) (1gm., .0021 moles), fully regenerated I.R.A. 400(OH)(10 gms.) and dry Isceon 113\*\* (10 mls.) were shaken together for six days at room temperature. After this treatment, an analytical gas liquid chromatogram (T.C.P., 80°C., 1 lit./hr.) of the

---

\* Registered trade mark of E.I. du Pont de Nemours & Co. Inc.

\*\* Registered trade mark of the Imperial Smelters Corporation Ltd., -  $\text{CF}_2\text{ClCFCl}_2$

solution revealed there to be present only compounds with retention times identical with those of the starting materials.

2. Using sodium hydroxide in acetone.

i) 3H,3H,6H,6H-octadecafluoro-(2,7-dimethyloctane) (4 gms., .0086 moles), sodium hydroxide pellets (5 gms., .125 moles) and acetone (15 mls.) were sealed under vacuum in a Carius tube. When the tube had warmed to room temperature, a vigorous exothermic reaction commenced and from time to time, it became necessary to cool the tube. After about 30 minutes, no more reaction seemed to be taking place so the tube was opened. The contents were transferred to a flask and distilled through a short Vigreux column. When 10 mls. of acetone had been collected, the distillation was stopped. The remaining liquid was distilled under reduced pressure (water pump). Analytical G.L.C. (T.C.P., 80°C., 1 lit./hr.) revealed this distillate to contain only a trace of starting material and acetone. There remained in the still pot a considerable amount of tar.

ii) The reaction was repeated using milder conditions (3H,3H,6H,6H-octadecafluoro-(2,7-dimethyloctane)(2.3 gms.), sodium hydroxide (4 gms.) and acetone (20 mls.)), but the same products were obtained.

### 3. Using solid potassium hydroxide

i) 3H,3H,6H,6H-octadecafluoro-(2,7-dimethyloctane) (3.1 gms., .0067 moles.) and powdered potassium hydroxide (3.1 gms., .055 moles) were sealed under vacuum in a Carius tube and heated to 100°C. for 8 hours. After this treatment, the contents of the tube appeared brown. The tube was opened and there distilled out under vacuum 2.7 gms. of a colourless liquid a chromatogram of which (T.C.P., 80°C., 1 lit./hr.) showed the main component (80% of total area) to be starting material. The second compound in the product had a retention time shorter than that of the starting material. An infra-red spectrum of the mixture showed absorption at 1727  $\text{cm.}^{-1}$  showing that some dehydrofluorination had taken place.

ii) The above reaction was repeated at 150°C. for 16 hours. At the end of this time, the contents of the tube were dark brown. The tube was opened and .7 gms. of liquid distilled out under vacuum. A chromatogram of the distillate (Si. Elast., 80°C., 1 lit./hr.) showed it to contain two compounds in addition to starting material the area of whose peak was 60% of the total. An infra-red spectrum of the material showed peaks at 1727  $\text{cm.}^{-1}$  and 1681  $\text{cm.}^{-1}$

#### 4. Using aqueous potassium hydroxide.

i) 3H,3H,6H,6H-octadecafluoro-(2,7-dimethyloctane) (5 gms., .011 moles) and an aqueous solution of potassium hydroxide (7 gms. KOH in 10 mls. H<sub>2</sub>O) were sealed together in a tube and shaken together at 150°C. for 10 hours.

After this treatment the aqueous layer was noted to be dark brown. Organic material (1.2 gms.) was recovered from the reaction tube and shown by analytical G.L.C. (T.C.P., 80°C., 1 lit./hr.) to consist of three compounds one of which had a retention time coincident with that of the starting material. This accounted for 60% of the area under the chromatogram. An infra-red spectrum of the organic reaction products showed absorption at 1727 cm<sup>-1</sup> and 1681 cm<sup>-1</sup>.

ii) The same amounts of reactants as used in the above experiment were shaken at 115°C. for four days. Again the contents of the tube had turned brown. Organic material (3 gms.) obtained from the reaction gave an analytical chromatogram similar to the one obtained in the foregoing experiment. In this case, the starting material accounted for 75% of the total area under the chromatogram.

5. Using amines.

i) iso-butylamine in dry ether.

Dry distilled iso-butylamine (.63 gms., .0086 moles) in dry ether (5 mls.) was added to a solution of  $3H,3H,6H,6H^2$  octadecafluoro-(2,7-dimethyloctane) (1 gm., .00217 moles) in dry ether (5 mls.). Almost immediately, a white gel began to be precipitated. The reactants were stood for 12 hours at room temperature during which time, the contents of the flask apparently became solid. The reaction product was filtered through a Buchner funnel.

The precipitate on standing in air became a viscous brown liquid and therefore was not the hoped for amine hydrofluoride. (A sample of the hydrofluoride was prepared and found to be stable in the atmosphere). A "sodium fusion" on the syrup revealed the presence of nitrogen and the infra-red spectrum showed absorption characteristic of N-H stretching ( $3262\text{ cm}^{-1}$ ).

The filtrate was washed with dilute acid to remove excess amine. The ether layer was dried with anhydrous magnesium sulphate. An analytical chromatogram (T.C.P.,  $80^{\circ}\text{C}$ ., 1 lit./hr.) revealed the presence of only ether and a trace starting material.

ii) di-ethylamine in dry ether.

Dry distilled di-ethylamine (.3 gms., .0041 moles) in

dry ether (5 mls.) was added to a solution of 3H,3H,6H,6H-octadecafluoro-(2,7-dimethyloctane) (1 gm., .00217 moles) in dry ether (5 mls.). After 30 minutes, white needle-like crystals began to be precipitated. After standing for 24 hours at room temperature, during which time more of these crystals were precipitated, the solution was filtered through a Buchner funnel.

The crystalline precipitate on standing in the atmosphere broke down and produced a yellow gum. This behaviour revealed the crystals not to be the amine hydrofluoride which is stable in the atmosphere. A 'sodium fusion' showed the gum to contain nitrogen.

The filtrate was shown by analytical G.L.C. (Si. Elast., 80°C., 1 lit./hr.) to contain only ether and starting materials.

· iif) tri-ethylamine in dry ether.

Dry distilled triethylamine (.44 gms., .0044 moles) in dry ether (5 mls.) was added to a solution of 3H,3H,6H,6H-octadecafluoro-(2,7-dimethyloctane) (1 gm., .00217 moles) in dry ether (5 mls.). The solution became yellow but even after several days, no precipitate was produced. An analytical chromatogram (Si. Elast, 80°C., 1 lit./hr.) of the solution after it had been standing for several days

revealed only the presence of ether and starting materials.

iv) tri-n-butylamine

a) 3H,3H,6H,6H-octadecafluoro-(2,7-dimethyloctane) (2 gms., .0043 moles) and dry distilled tri-n-butylamine (1.6 gms., .0086 moles) were sealed under vacuum in a Carius tube (15 mls. capacity) and shaken horizontally at 100°C. for 6 hours at the end of which time, little change appeared to have taken place so the temperature was raised to 160°C. for 4 hours. After this treatment, the contents of the tube were dark brown and viscous. The tube was opened and the contents were washed with dilute hydrochloric acid. The organic material had decomposed to such an extent that two layers did not separate out.

b) A flask fitted with reflux condenser and charged with 3H,3H,6H,6H-octadecafluoro-(2,7-dimethyloctane) (10 gms., .022 moles) and tri-n-butylamine (8 gms., .043 moles) was heated to 130°C. for 5 hours. At the end of this time, the reaction vessel was cooled. A crystalline material was noted to be present in the brown reaction products. A sample was taken, washed with dry ether several times and identified by its infra-red spectrum as tri-n-butylamine hydrofluoride.\* The bulk of the reaction product was

---

\* For comparison purposes, a sample of authentic tri-n-butylamine hydrofluoride was prepared by passing hydrogen fluoride through an ethereal solution of tri-n-butylamine.

washed with dilute hydrochloric acid. The organic layer was separated and from it was distilled under reduced pressure (water pump) three grams of a colourless liquid. Analytical G.L.C. (T.C.P., 80°C., 1 lit./hr.) showed this to be largely (70% of total area) one compound which had a retention time different from that of starting material. This compound was obtained 95% pure (estimated by anal. G.L.C.) using preparative G.L.C. (T.C.P., 65°C., 160 ml.s./min.) but in doing so, the yield was reduced considerably due to the impurities having retention times similar to that of the main product.

The infra-red spectrum has a single peak at 1790 cm.<sup>-1</sup> showing the material to be unsaturated.

The F<sup>19</sup> magnetic resonance spectrum shows four groups of fluorine in the intensity ratio 12:2:1:1 having the chemical shifts:-

		Intensity
(CF <sub>3</sub> ) <sub>2</sub> C=	-12.9, -7.2	3,3
(CF <sub>3</sub> ) <sub>2</sub> CX=C	-11.5	6
CF <sub>2</sub> -	(mean) 35.00 J <sub>AB</sub> =273 c/s	2
CF	34.17	1
CF	132.9	1

Chemical shifts are from trifluoroacetic acid as external reference. Positive shifts are to high field.

The  $H^1$  magnetic resonance spectrum showed two groups of hydrogen in the intensity ratio 1:1. One of these shows an H-F coupling constant of 49.0 c/s.

Dehydrofluorination of 3H,3H,6H,6H-tetradecafluorooctane

1. Using anhydrous potassium hydroxide

i) 3H,3H,6H,6H-tetradecafluorooctane (2 gms., .0055 moles) and powdered potassium hydroxide (3 gms., .054 moles) were sealed under vacuum in a Carius tube and heated to 150°C. for 16 hours. At the end of this time, the contents of the tube were dark brown. When opened, nothing could be distilled from the tube suggesting complete decomposition to have taken place.

ii) The same amount of materials as used in reaction i) (above) were sealed in a Carius tube and heated for 8 hours at 100°C. Organic material (1.2 gms.) distilled from the tube at the end of this time and was shown by analytical G.L.C. (Si. Elast., 70°C., 1 lit./hr.) to contain more than 80% starting material.

Using aqueous potassium hydroxide

An aqueous solution of potassium hydroxide (1.6 gms., in 10 mls.) was refluxed with 3H,3H,6H,6H-tetradecafluorooctane (5 gms., .0137 moles) (oil bath temp. ca. 120°C.)

for 12 hours. The organic layer after this treatment gave chromatogram 'I' (Fig. 6) showing the reaction to have taken place to only a small extent.

The concentration of the solution was increased by adding a further 6 gms. potassium hydroxide and refluxing was continued for a further 8 hours. Chromatogram II (Fig. 6) was obtained from the organic layer after this treatment.

After 10 more hours refluxing chromatogram III was obtained, and finally after a further 12 hours, chromatograms IVa, and IVb. (N.B. Chromatograms IVa and IVb are given by the same material but in one case Silicone Elastomer in the liquid phase and in the other Tricresyl Phosphate is the liquid phase).

An attempt to separate the mixture into two components failed due to the lack of resolution by the preparative scale G.L.C. (T.C.P., 60°C., 160 mls./min.) Almost arbitrary cuts were taken and these were found to be impure by analytical G.L.C. Infra-red spectra of these cuts showed strong absorption at  $1727\text{ cm}^{-1}$ , and  $1678\text{ cm}^{-1}$ , showing the presence of unsaturation.

From the 5 gms. starting material, 3.5 gms. organic material were recovered.

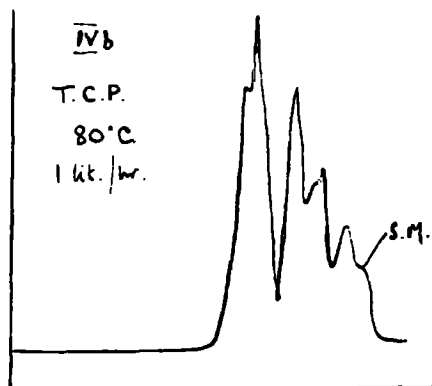
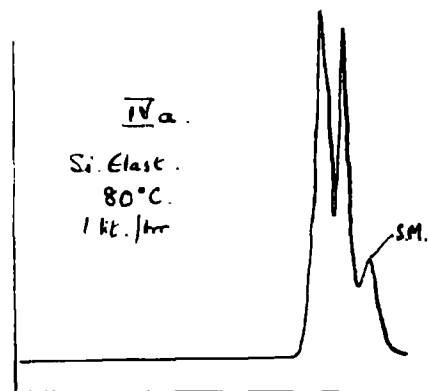
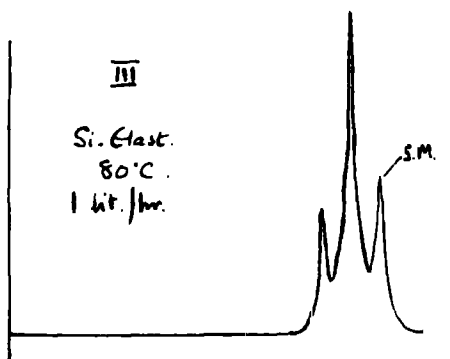
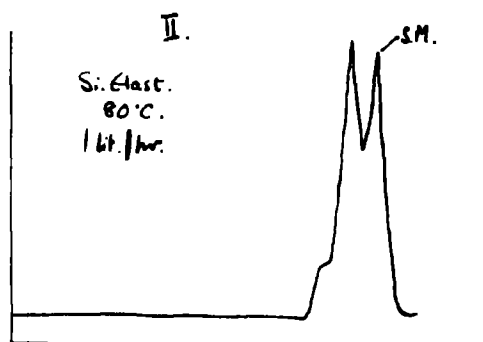
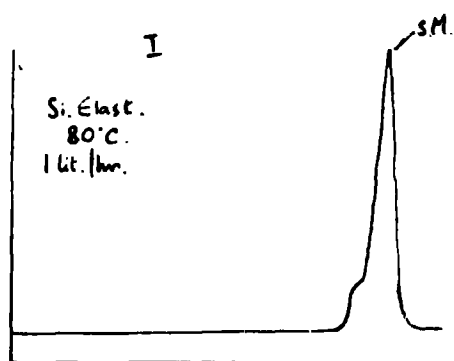

Fig. 6.

Chromatograms of the material produced during the dehydro-fluorination of  $C_2F_5CH_2CF_2CF_2CH_2C_2F_5$  using aqueous potassium hydroxide.  
(S.M. - Starting Material.)

Using tri-n-butylamine.

i) 3H,3H,6H,6H-tetradecafluorooctane (2 gms., .0055 moles) and tri-n-butylamine (1.7 gms., .0092 moles) were sealed under vacuum in a Carius tube (15 mls. capacity) and shaken in a horizontal position at 100°C. for 6 hours. Little change appeared to have taken place by the end of this time so the temperature was raised to 160°C. for 4 hours. After allowing to cool, the tube was opened and the contents were washed with dilute hydrochloric acid to remove excess amine. The organic layer was separated from the aqueous and distilled under reduced pressure. Decomposition had occurred to such an extent that only a few drops of distillate could be obtained. This material was shown by analytical G.L.C. (T.C.P., 75°C., 1 lit./hr.) to contain five compounds, present in similar amounts, other than starting material.

Peaks at 1730  $\text{cm.}^{-1}$  and 1681  $\text{cm.}^{-1}$  in the infra-red spectrum showed the distillate to be unsaturated.

ii) The reaction was repeated as above except that the reactants were heated to 110°C. for 20 hours. The reaction product was worked up as described in the above reaction and 1.2 gms. of distillate were obtained. This was shown by analytical G.L.C. (T.C.P., 80°C., 1 lit./hr.) to consist

largely of starting material (65-70%), together with two other materials with slightly shorter retention times. Again, the infra-red spectrum of the mixture showed absorption at  $1730\text{ cm}^{-1}$  and  $1681\text{ cm}^{-1}$

Infra-red spectra

Very few spectral assignments of fluorocarbon groups have been possible because of the many interactions which occur.

All the olefins which were prepared and which contain the structure  $-\text{CH}=\text{CF}_2$  show a strong peak in the range 1748-1764  $\text{cm.}^{-1}$  due to  $\text{C}=\text{C}$  stretching. This is consistent with the findings of Hauptschein and Oesterling<sup>77</sup> who prepared fluoro-olefins containing this same element of structure and found them to absorb strongly in this region.

All compounds prepared by the present author containing a methylene group show absorption at or near 1429  $\text{cm.}^{-1}$ . This too was observed by Hauptschein,<sup>77</sup> and by Paciorek,<sup>97</sup> Tiers<sup>35</sup> and their co-workers in the spectra of similar compounds which they prepared. ( $\text{RfCH}_2\text{CFXRf}'$ ;  $\text{X}=\text{F}, \text{Cl}, \text{Br}, \text{I}$ .  $\text{Rf}' = \text{F}, \text{CF}_3$ ). This band has been ascribed<sup>35</sup> to the methylene deformation as influenced by the adjacent perfluoro grouping and a halogen substituent or a second perfluoro group.

The infra-red spectra of several compounds ( $\text{CF}_3\text{CH}:\text{CF}_2$ ,  $(\text{CF}_3)_2\text{CFCF}=\text{CF}_2$ ,  $(\text{CF}_3)_2\text{CFCF}_2\text{CF}_2\text{H}$ ) not prepared by the author are included for comparison purposes.

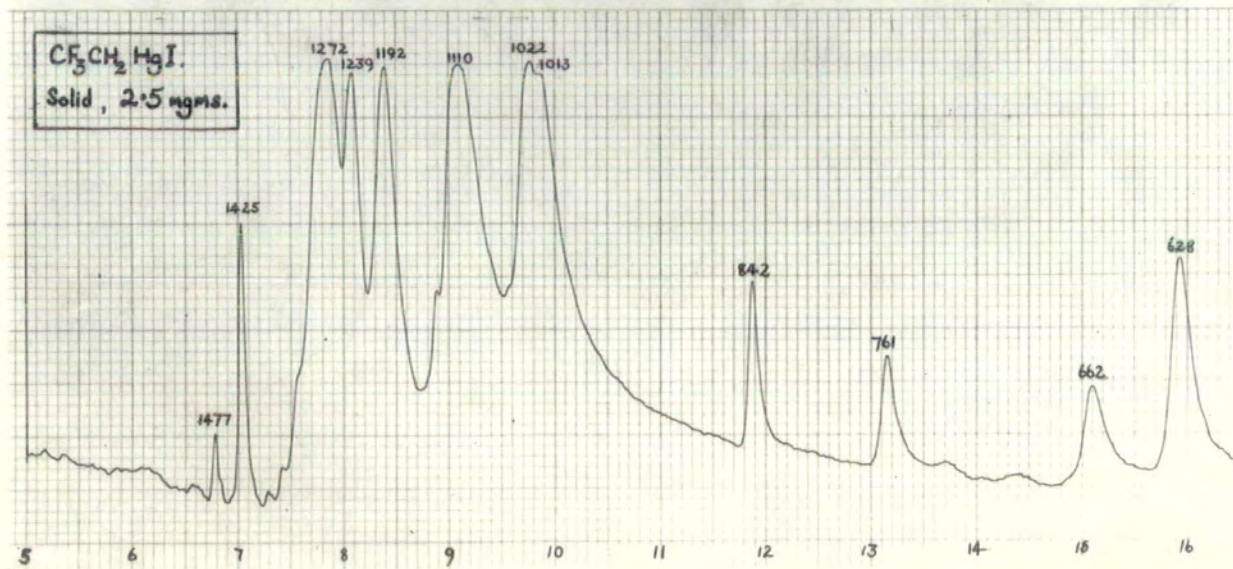
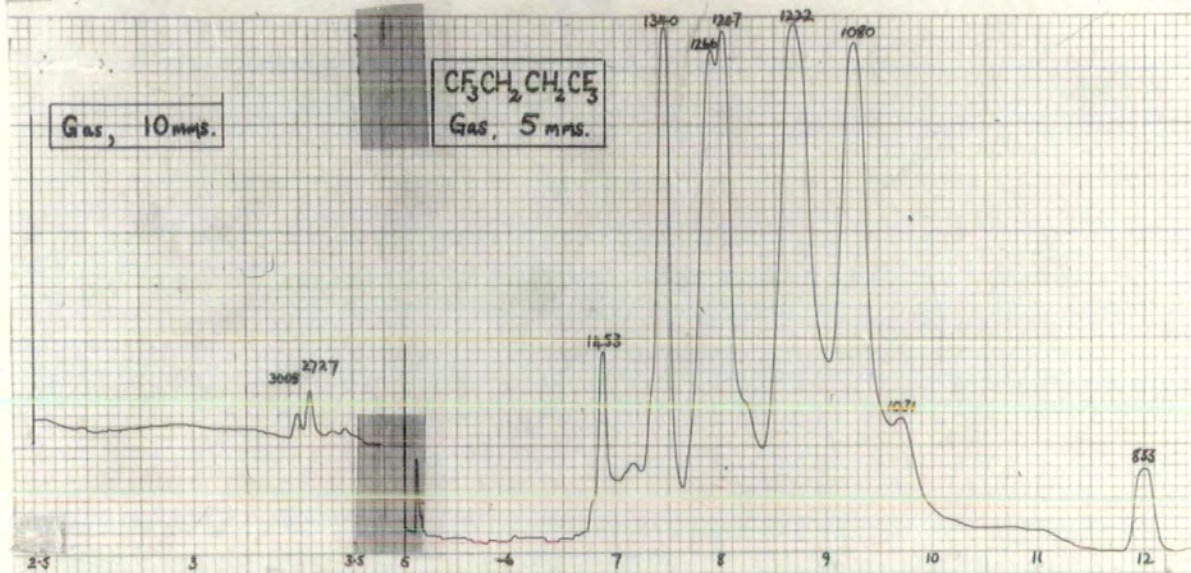

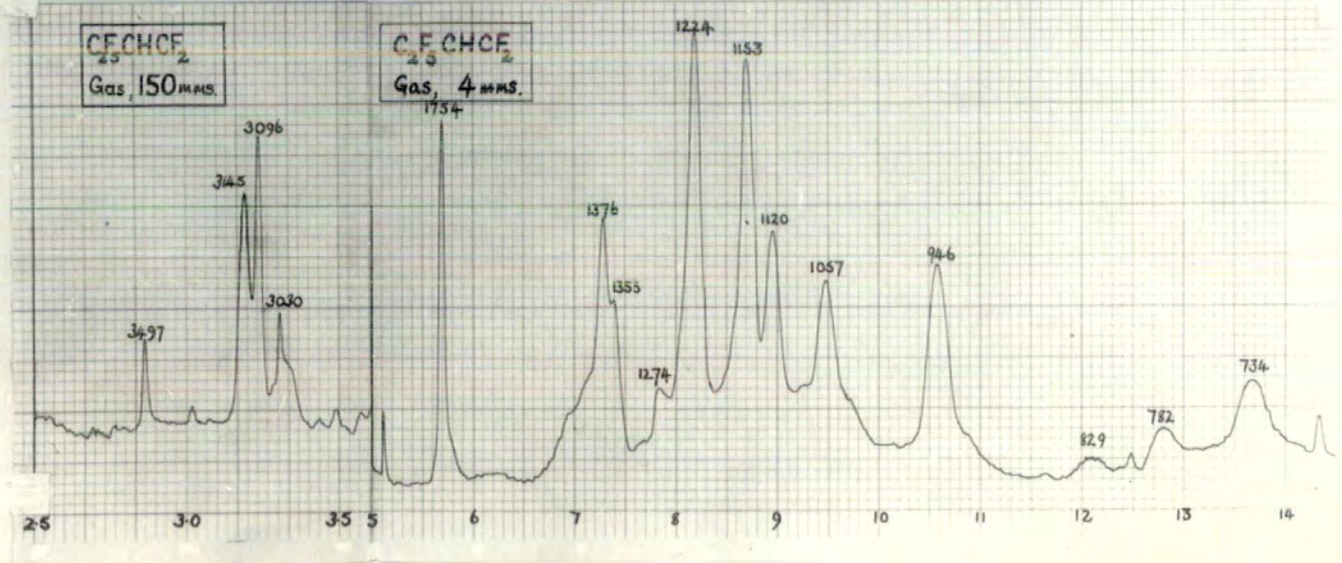
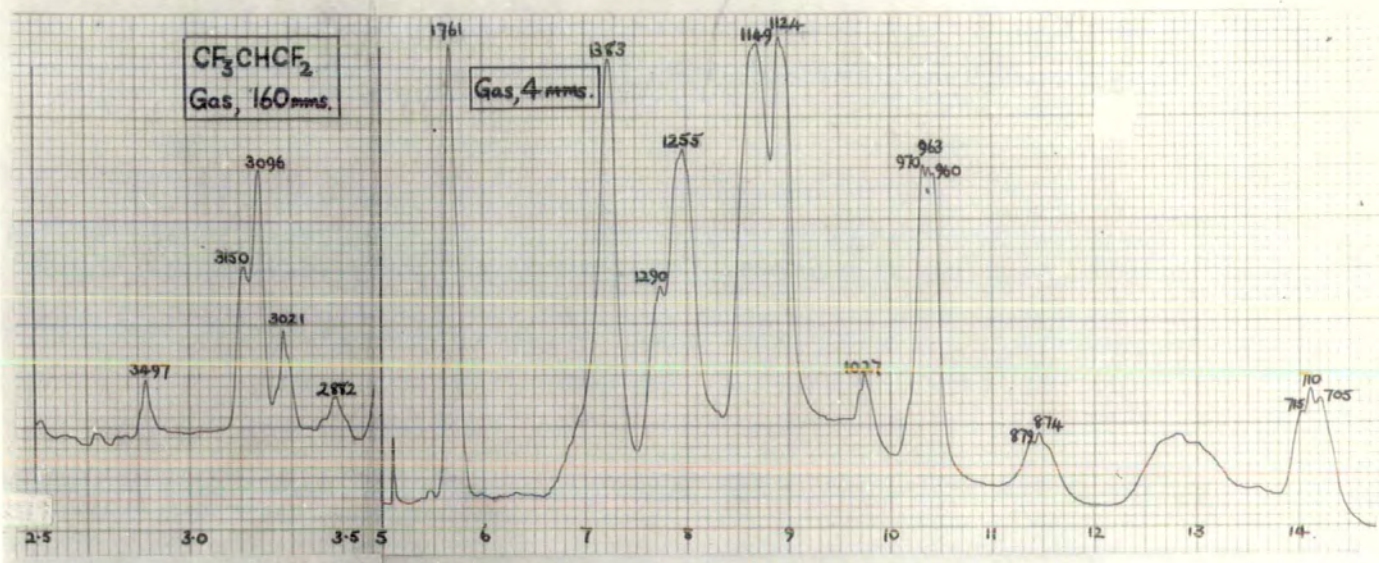

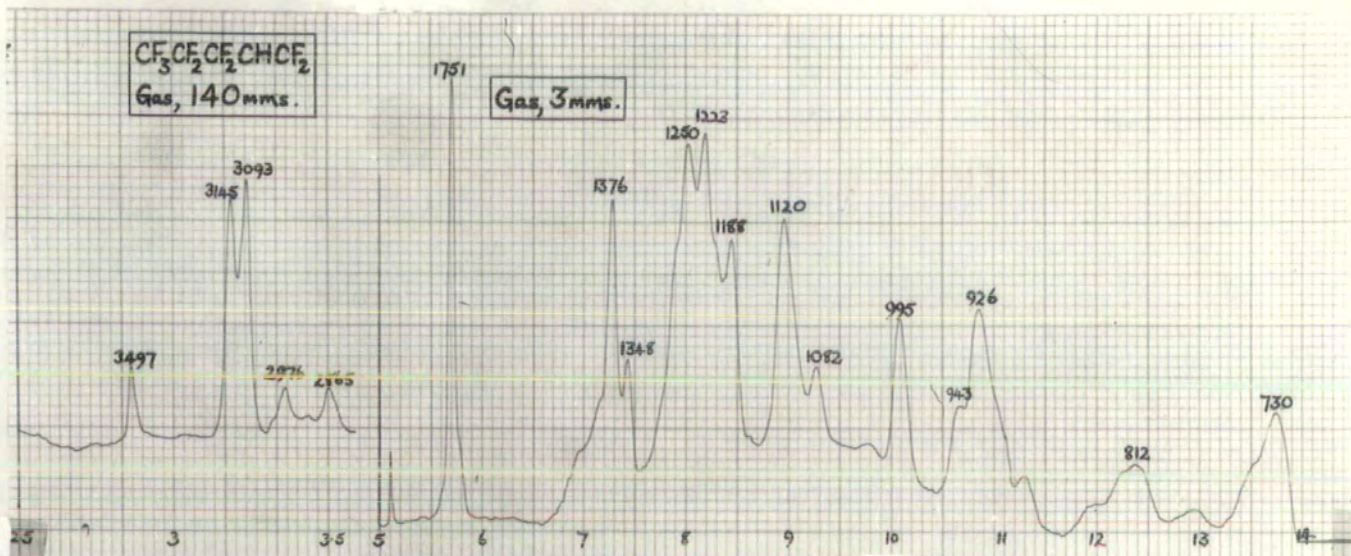

5

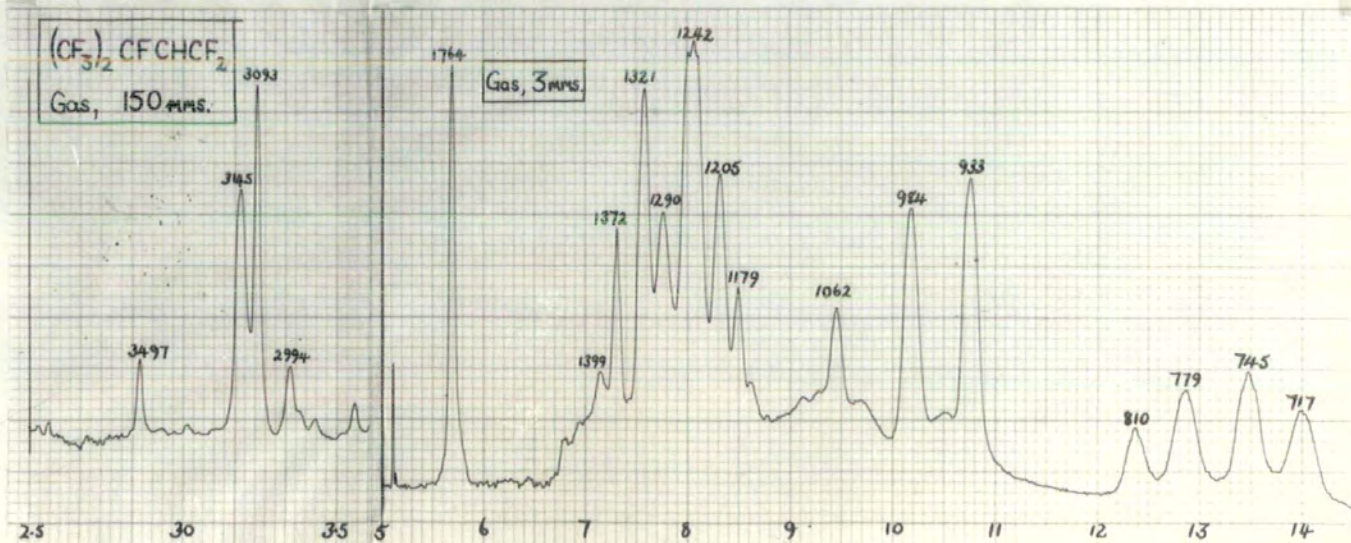

6

$(CF_2)_3CFCH_2CF_2CHCF_2$   
Liquid, Contact film.

Gas, 3mm.

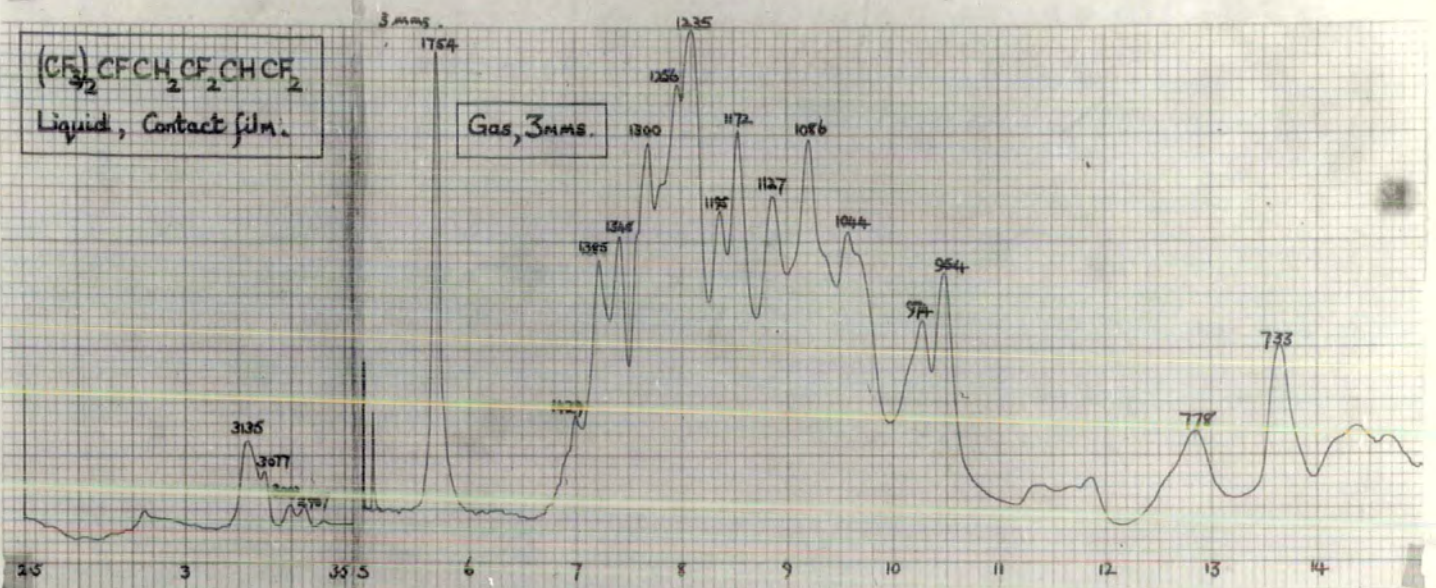

7

$(CF_3)_2CF(CH_2CF_2)_2CHCF_2$   
Liquid, Contact film.

Liquid,  
Contact film.

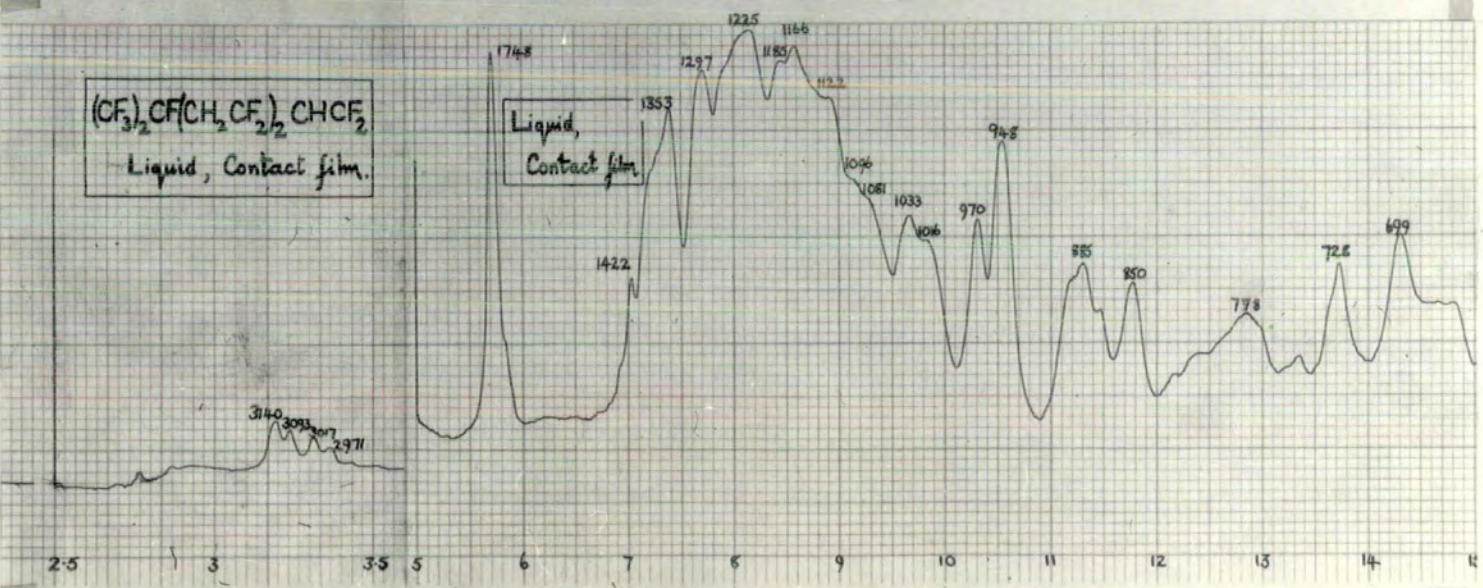

8

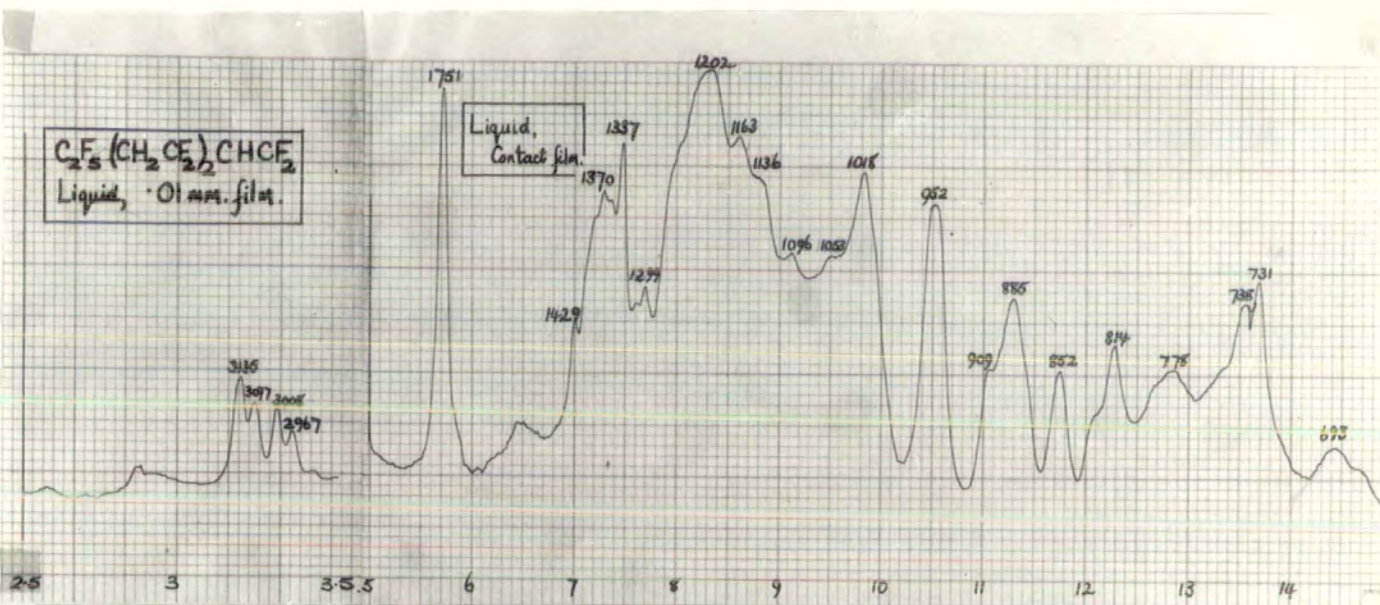

9

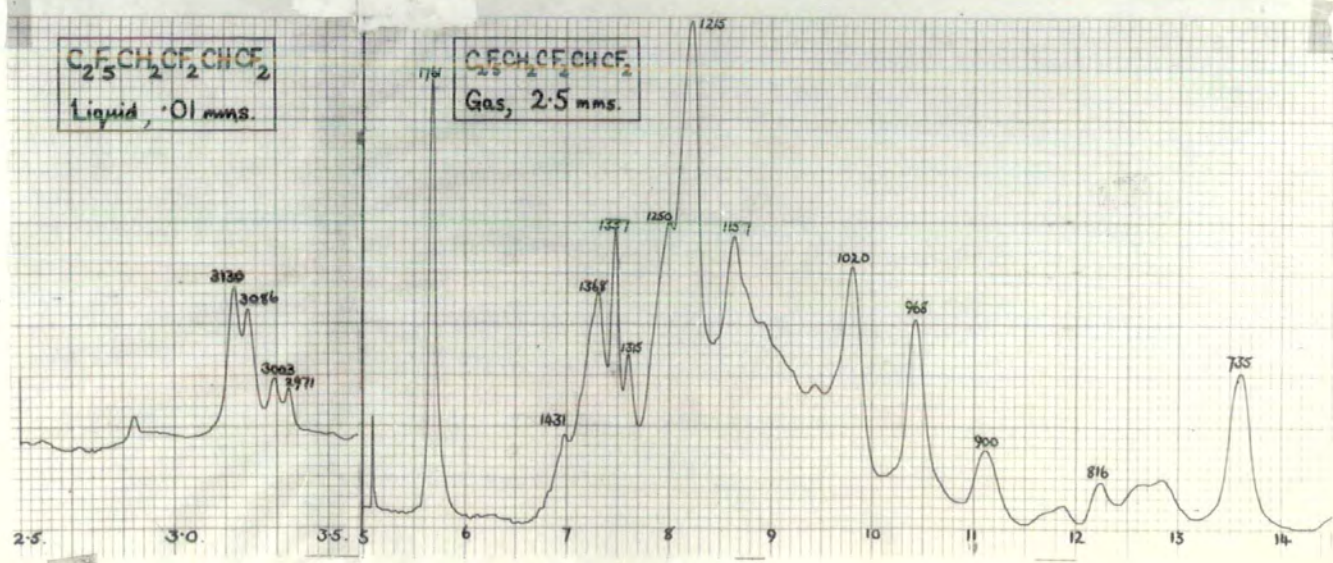

10

Gas, 20 mms.

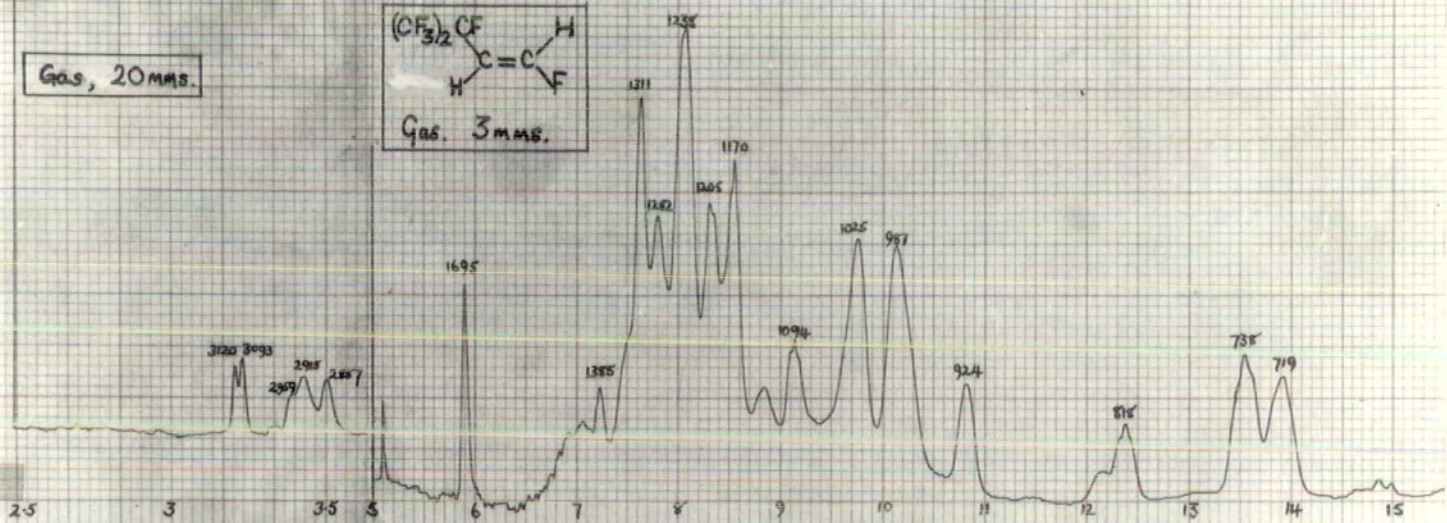
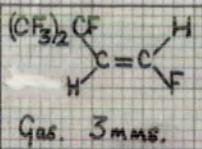

Gas, 71 mms.

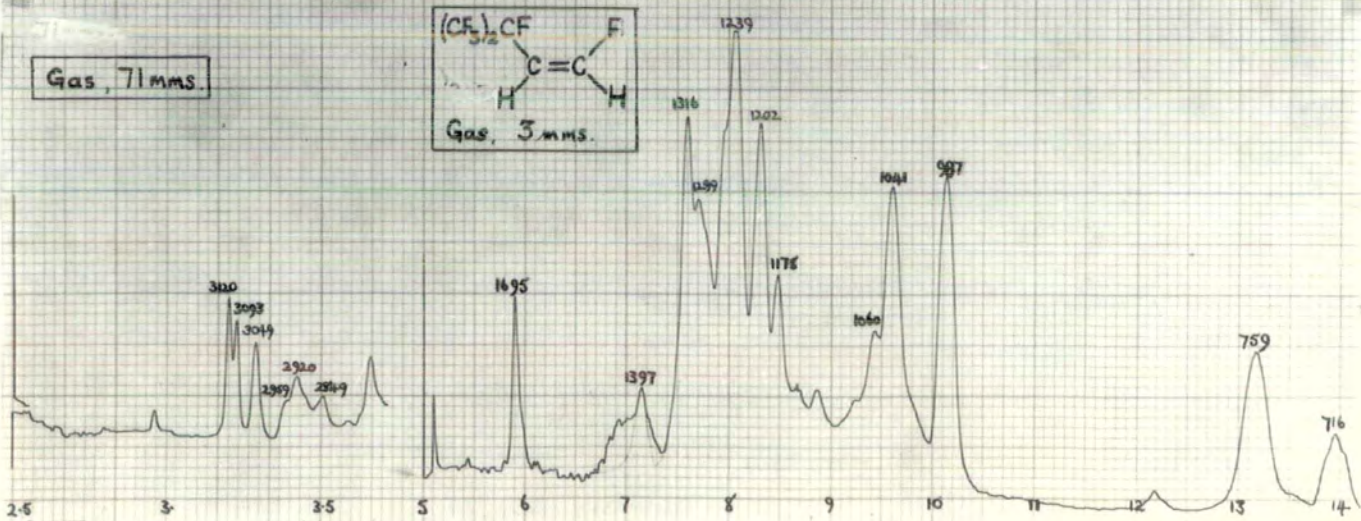
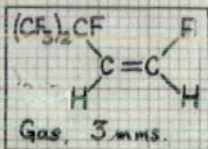

11

12

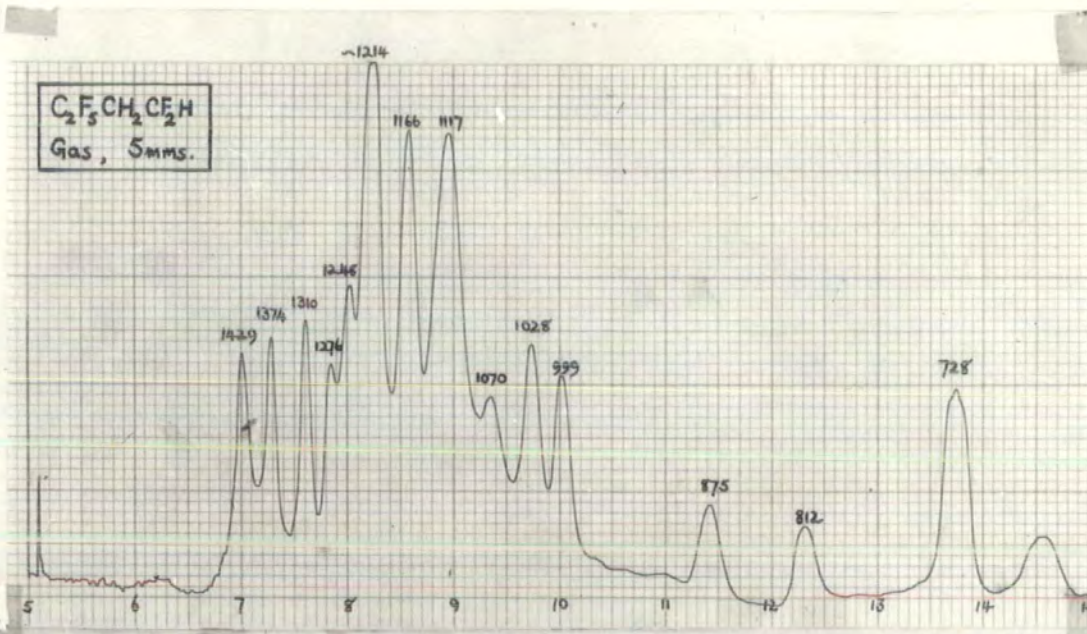

13

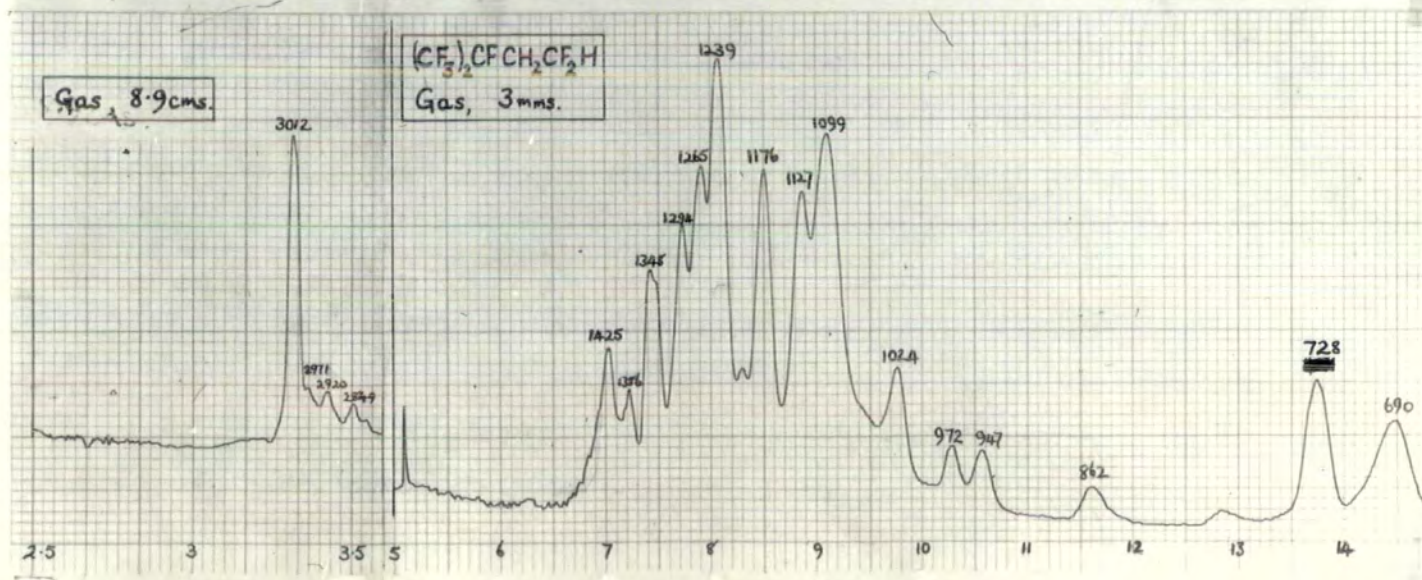

14

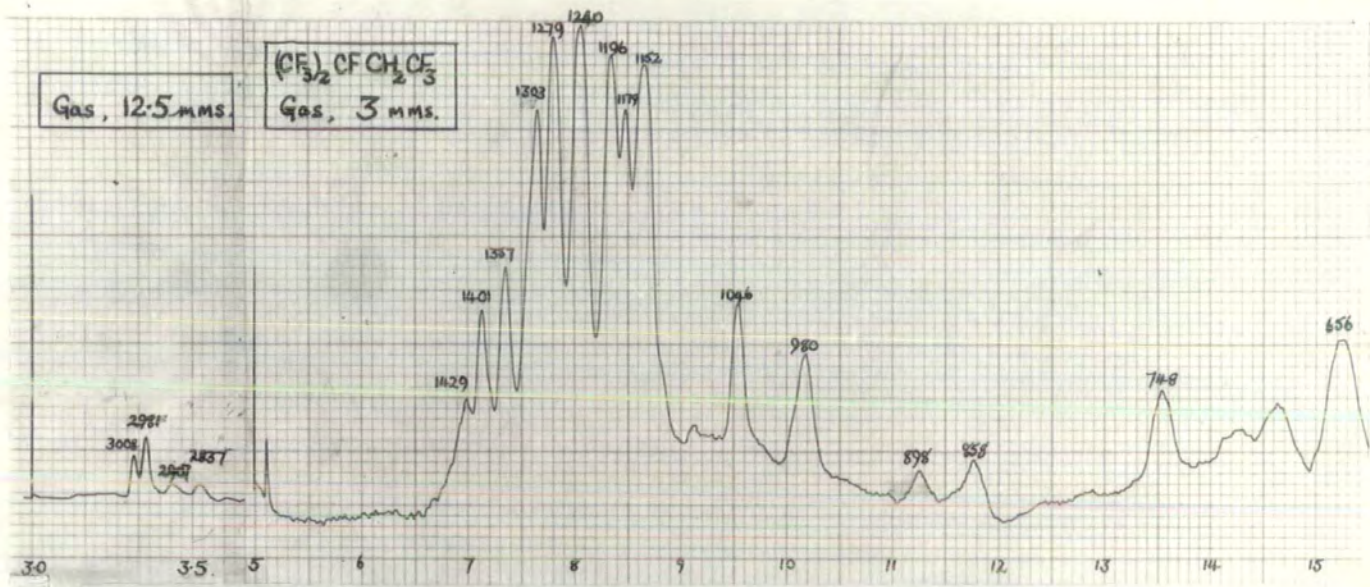

15

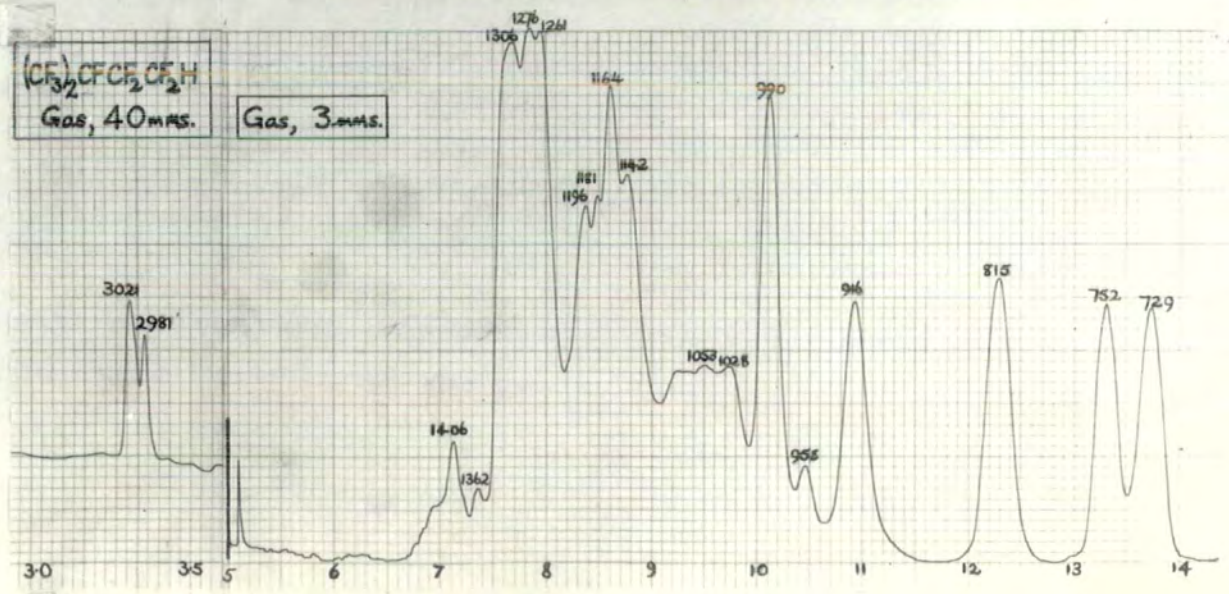

16

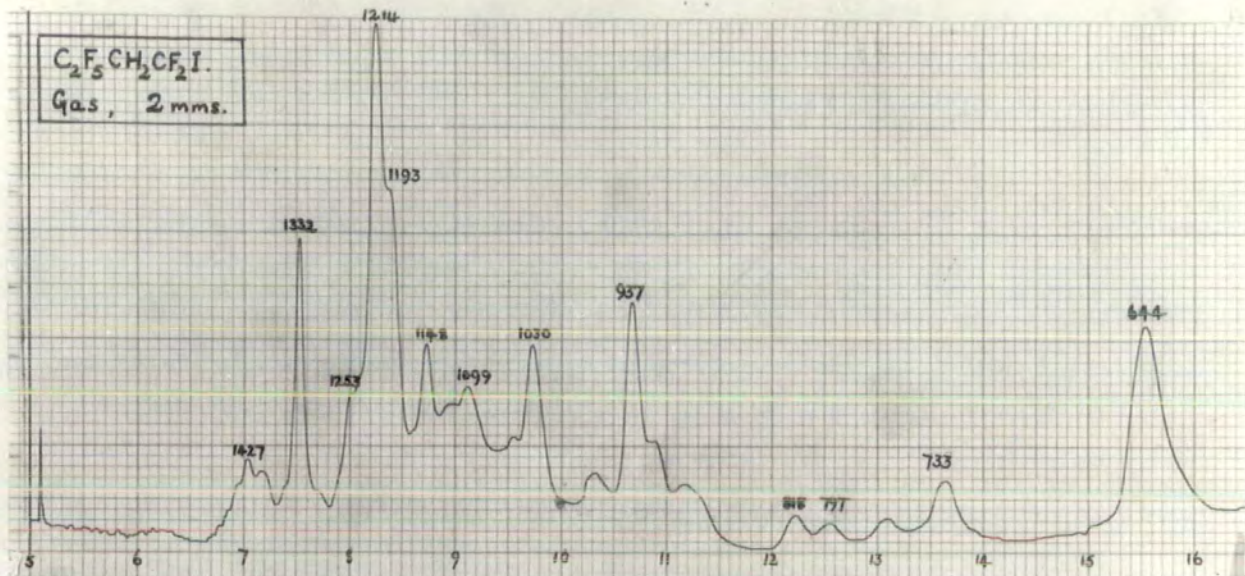

17

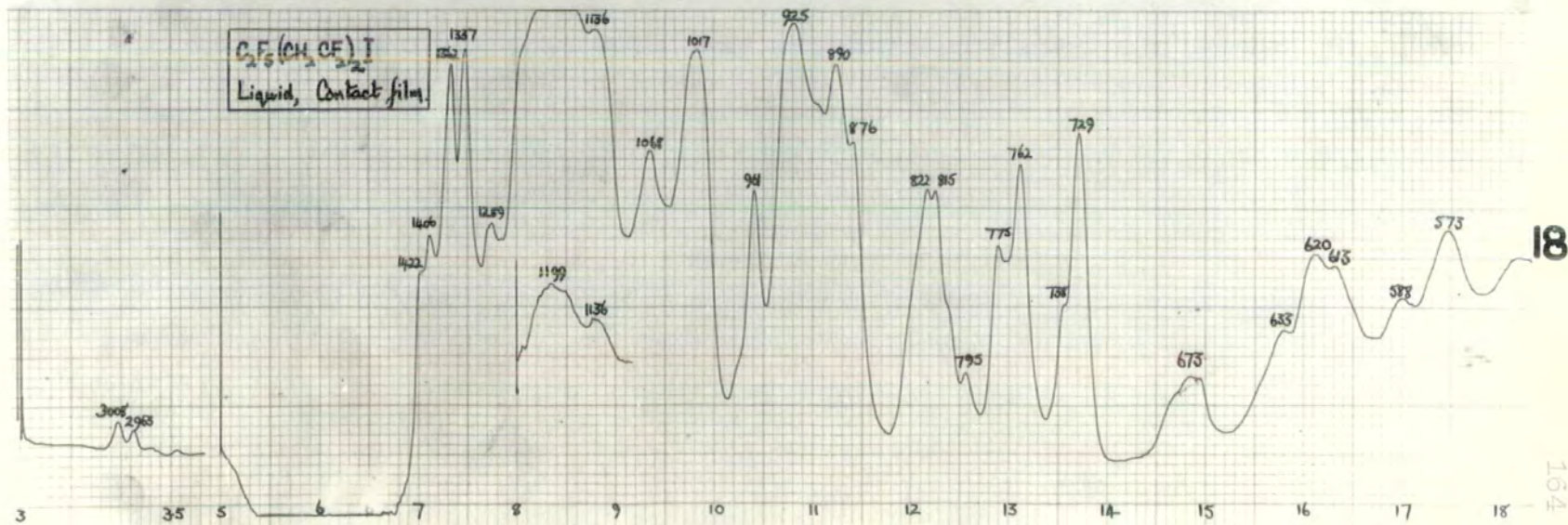

18

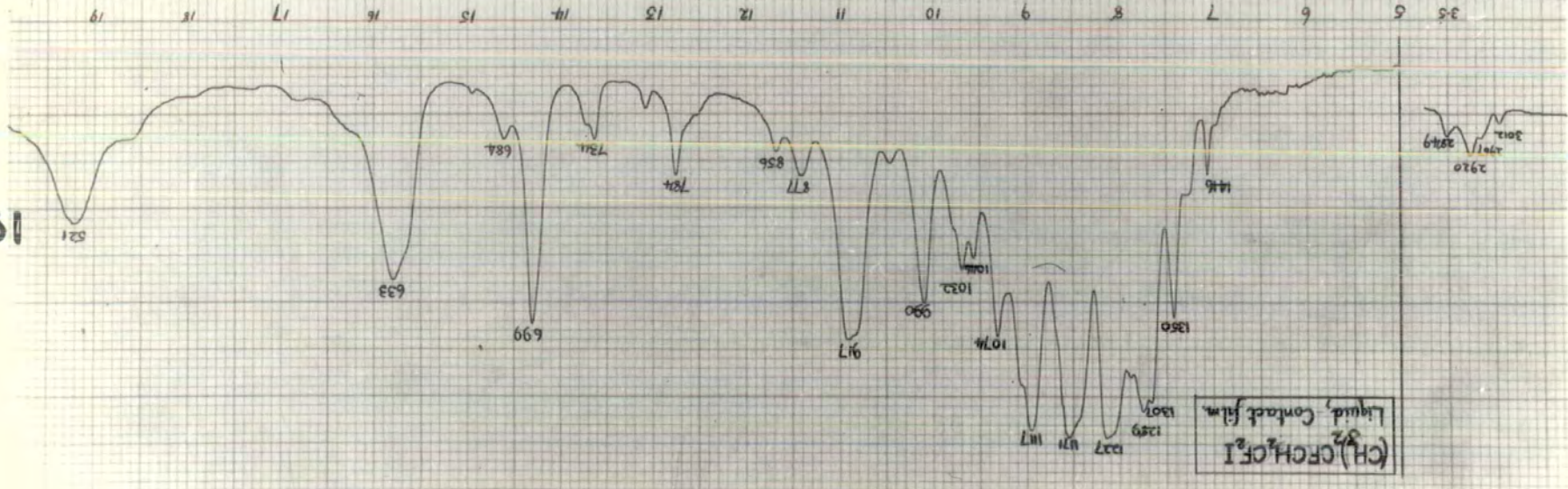
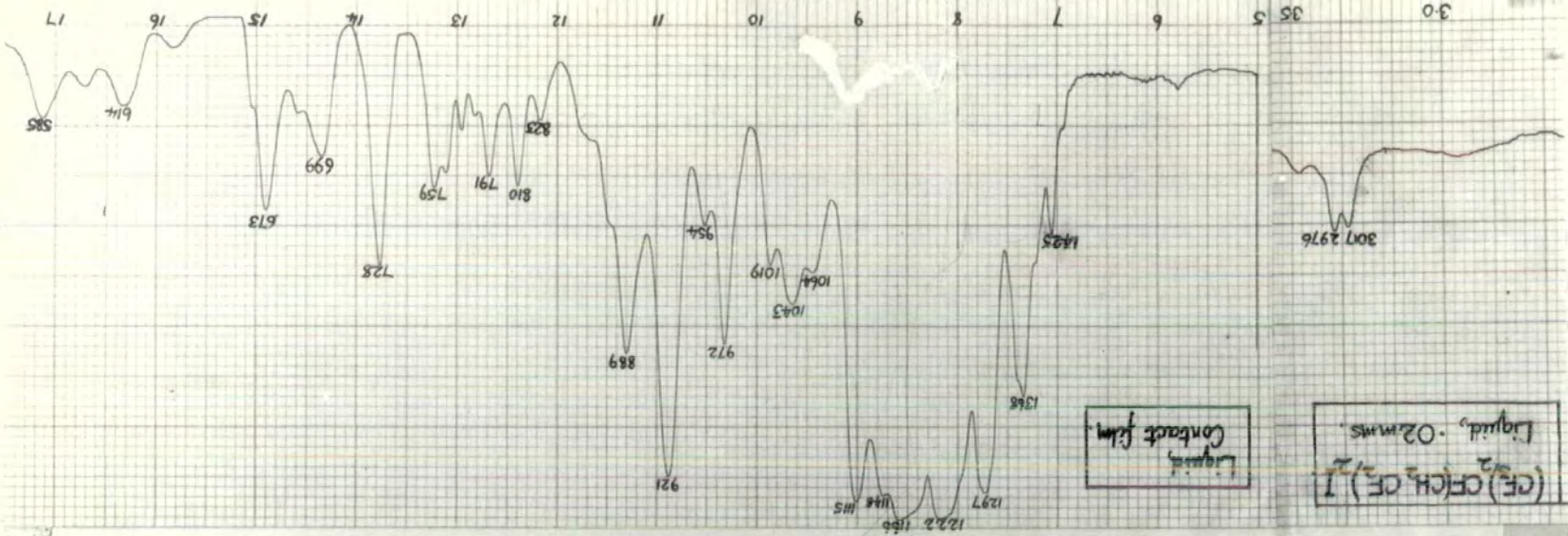

22



21

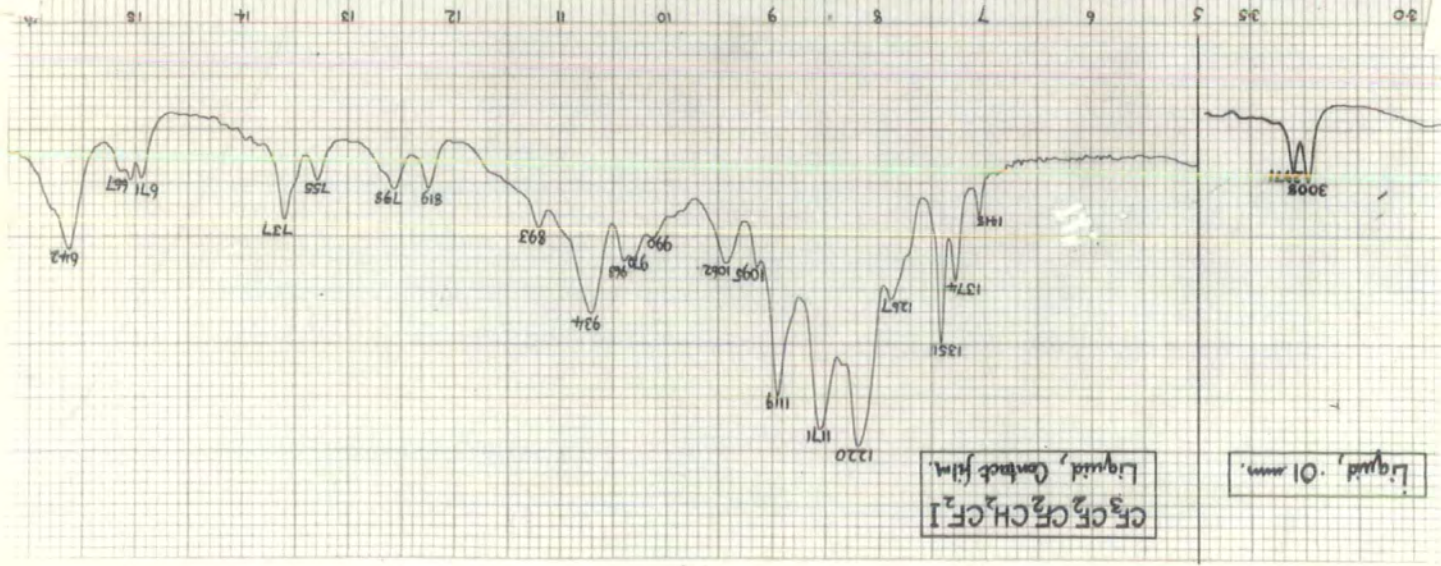

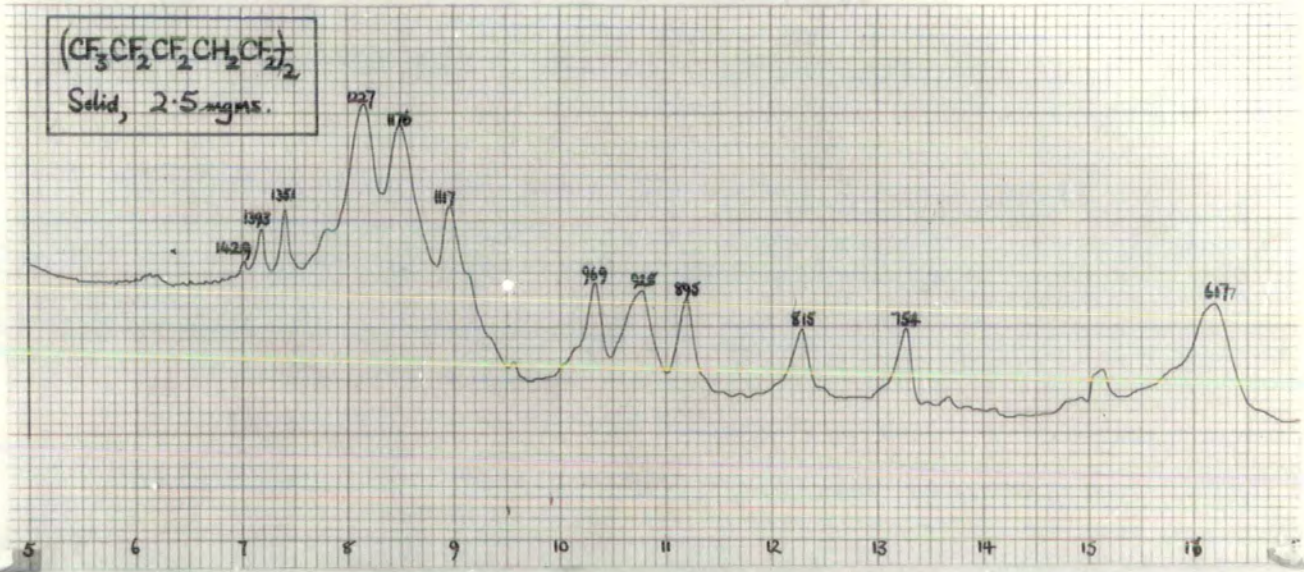

23

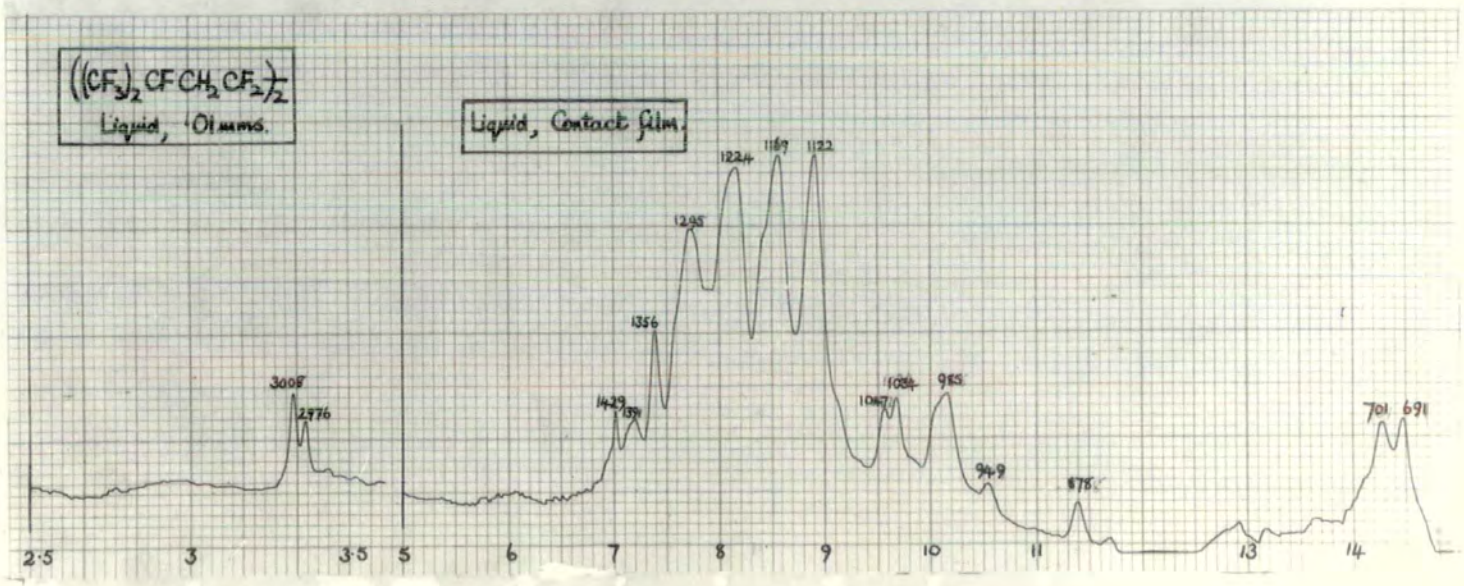

24

$(CF_2)_nCF_2CF_2CF_2$   
Gas, 2 mmms.

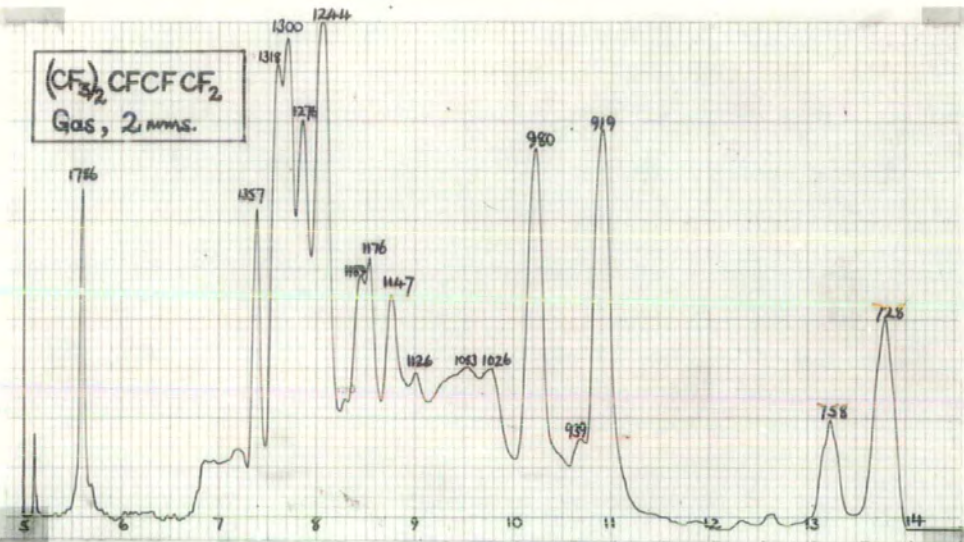

25

$(C_2F_5CH_2CF_2)_n$   
Liquid - Contact film.

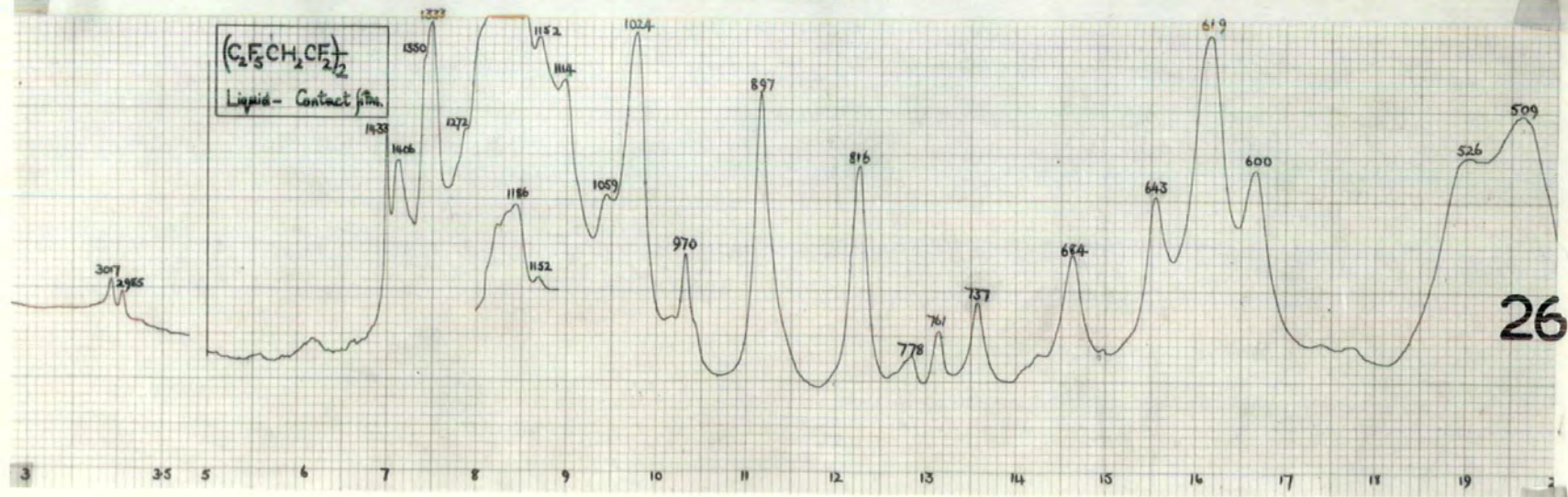

26

PART II

Chapter 4

THE CARBON-IODINE BOND STRENGTH IN POLYFLUORO-  
IODOALKANES

## Introduction

The object of the work described in this chapter was to obtain a measure of the relative C-I bond strengths in a series of polyfluoroiodoalkanes. Hitherto the only information regarding C-I bond strengths (with the exception of  $\text{CF}_3\text{I}$ <sup>190</sup>) has been due to Haszeldine<sup>102</sup> who proposed that the position of maximum absorption in the ultra-violet spectrum of an iodide was directly related to the C-I bond strength and also to the stability of the radical produced by the fission of that bond (see also p. 17). In a series of iodides, the shift of  $\lambda_{\text{max}}$  towards the red parallels a decrease in C-I bond strength.

For most iodoalkanes it seems probable that the mechanism of thermal decomposition is<sup>188</sup>

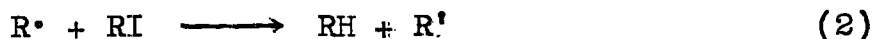

Also if the extent of conversion becomes appreciable, various secondary reactions will come into play, especially



In the case of perfluoroiodoalkanes, a reaction corresponding to (2), and therefore (3), is impossible for the strength of the C-F bond is such that fluorine abstraction cannot take place. In the presence of added iodine a negligible number of alkyl radicals recombine with iodine atoms compared with the number which combine with iodine molecules simply on the basis that the chance of an alkyl radical colliding with an iodine atom in the presence of a third body is less than the chance of an alkyl radical colliding with an iodine molecule. Similarly, the possibility of two alkyl radicals combining is very remote. When a perfluoroiodoalkane is heated in the presence of added iodine therefore, only three reactions can be of importance:-

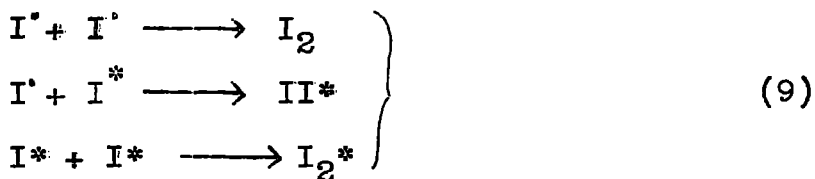
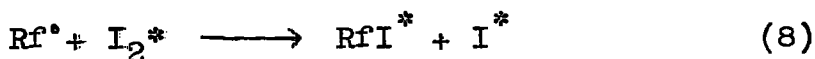

It would seem then that if a perfluoroiodoalkane is heated with radioactive iodine ( $\text{I}^{131}$ ), the amount of radioactivity found in the iodide after a given time would be a measure of the number of perfluoroalkyl radicals that have been produced in that time until of course the reactions



become important. The rate of product<sup>ion</sup> of RfI\* will decrease with time until equilibrium is reached when the amount of RfI\* in the system is constant (neglecting the decay of the I<sup>131</sup>). If the exchange is allowed to proceed for only a short time, the rate of production of RfI\* will be virtually constant.

Accurately known amounts of radioactive iodine and an iodide were sealed up in tubes and heated in the vapour phase at 98°C. After a measured length of time the tubes were opened, the free iodine was removed (see page 180 for details) and the radioactivity in the iodide was measured. From a knowledge of the specific activity of the iodine it was possible to calculate the mole % of the iodide molecules which had undergone fission. The number of C-I bonds broken in a given time must depend on the strength of the C-I bond, and therefore a comparison of rates of production of RfI\* for different values of Rf must also be a comparison of C-I bond strengths. The extent of exchange is not necessarily a measure of the number of radicals produced because there is a possibility that the exchange may be taking place, at least in part, by a four centre process.

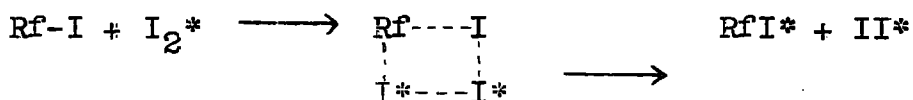

The results of these experiments appear in fig. 7 and in the following tables.

Pentafluoroiodoethane

PdI <sub>2</sub> (gms)	Iodide(gms)	Time(hrs)	Activity of iodide (c.p.m.)	Mole % of RfI which gave RfI*
.00500	.9863	2	4,599	.40 x 10 <sup>-2</sup>
.00498	.9668	4	5,512	.47 x 10 <sup>-2</sup>
.00501	.9652	6	8,120	.70 x 10 <sup>-2</sup>
.00498	.9602	8	10,174	.88 x 10 <sup>-2</sup>

.00347 gms. PdI<sub>2</sub>  $\longrightarrow$  557,500 c.p.m. on decomposition.

1,1,1-difluoro-2-iodoethane

.00402	.6748	4	103	.48 x 10 <sup>-2</sup>
.00399	.6771	6.2	83	.68 x 10 <sup>-2</sup>
.00402	.6761	7.7	59	.84 x 10 <sup>-2</sup>

.00223 gms. PdI<sub>2</sub>  $\longrightarrow$  4,708 c.p.m. on decomposition

heptafluoro-1-iodopropane

.00499	1.1847	3	170	2.2 x 10 <sup>-2</sup>
.00503	1.1815	6	281	3.6 x 10 <sup>-2</sup>
.00499	1.1846	8	373	4.7 x 10 <sup>-2</sup>

.00679 gms. PdI<sub>2</sub>  $\longrightarrow$  7442 c.p.m. on decomposition.

Fig 7

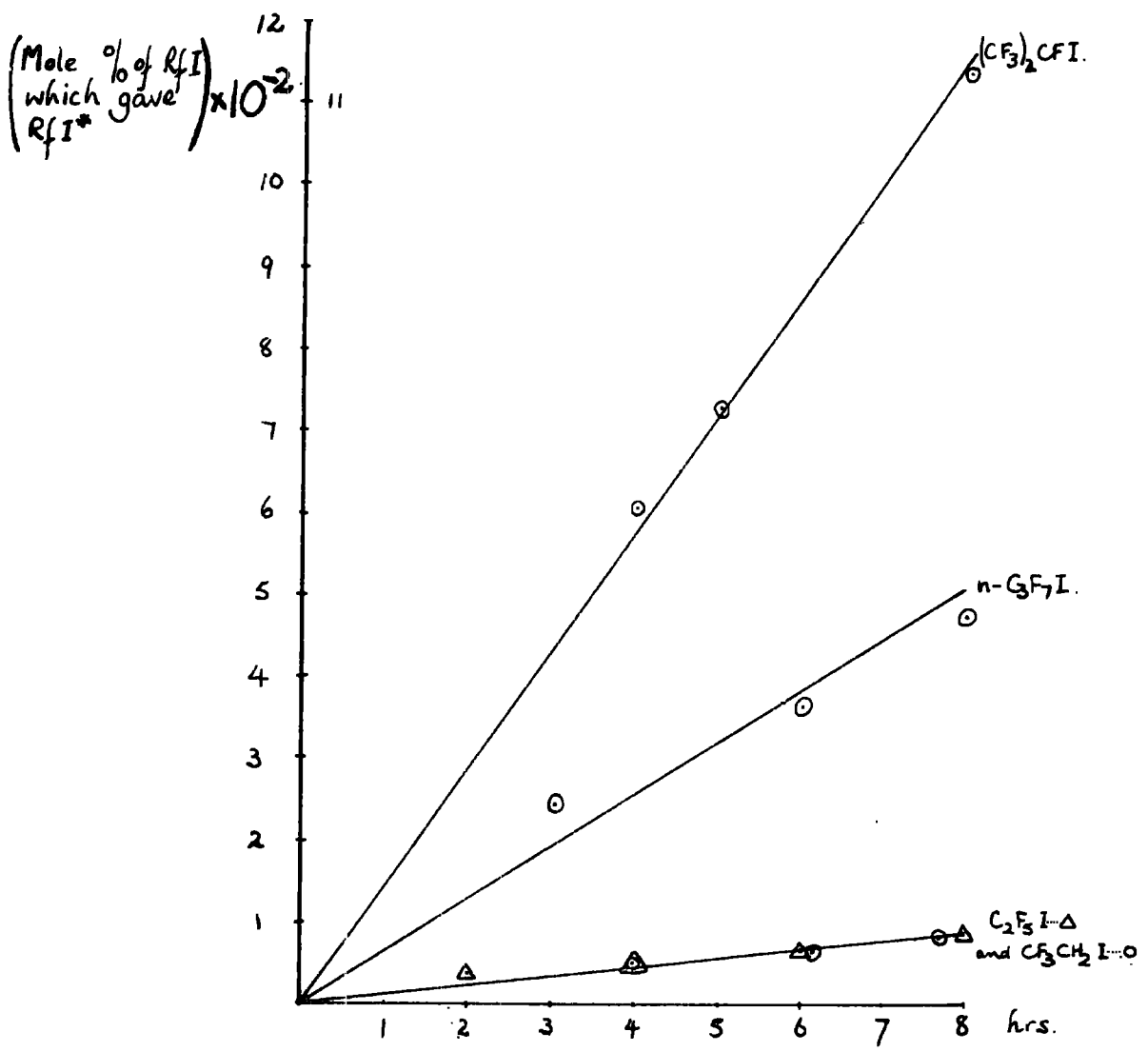

heptafluoro-2-iodopropane

.00503	1.1911	4	532	$6.05 \times 10^{-2}$
.00493	1.1924	5	640	$7.27 \times 10^{-2}$
.00498	1.1928	8	999	$11.35 \times 10^{-2}$

.00547 gms.  $\text{PdI}_2 \longrightarrow$  6627 c.p.m. on decomposition.

In the case of trifluoroiodomethane, less the  $.2 \times 10^{-2}$  mole percent of the iodide molecules had undergone exchange after 8 hours.

That in the case of exchange with 1,1,1-trifluoro-2-iodoethane reactions (2) and (3) did not take place was shown by heating together the iodide with iodine for 8 days. After this time, analytical G.L.C. showed there to be no organic material present except the iodide. This also demonstrated that no coupling of radicals occurred.

These results show that the C-I bond strength decreases in the series  $\text{CF}_3\text{I}$ ,  $\text{C}_2\text{F}_5\text{I}$  and  $\text{CF}_3\text{CH}_2\text{I}$  about the same,  $n\text{-C}_3\text{F}_7\text{I}$  and  $\text{iso-C}_3\text{F}_7\text{I}$ . This order is in accord with what could be predicted from ultra-violet spectra with the lone exception of  $\text{CF}_3\text{CH}_2\text{I}$ .

$\text{CF}_3\text{CH}_2\text{I}$	$\lambda_{\text{max}}$ 262 $\text{m}\mu$
$\text{CF}_3\text{I}$	267.5 $\text{m}\mu$
$\text{C}_2\text{F}_5\text{I}$	268.5 $\text{m}\mu$
$n\text{-C}_3\text{F}_7\text{I}$	271 $\text{m}\mu$
$\text{iso-C}_3\text{F}_7\text{I}$	276 $\text{m}\mu$

The order of decreasing bond strength in the series  $\text{CF}_3\text{I}$ ,  $\text{C}_2\text{F}_5\text{I}$ ,  $n\text{-C}_3\text{F}_7\text{I}$ ,  $\text{iso-C}_3\text{F}_7\text{I}$  parallels increasing conversion of iodide into telomers in reactions with 1,1-difluoroethylene. This increase in conversion can be attributed to the increased number of perfluoroalkyl radicals available for initiation. Decreased C-I bond strength is also associated with higher chain transfer efficiency and therefore decreased yields of higher telomers. In the reactions of the iodides  $\text{CF}_3\text{I}$ ,  $\text{C}_2\text{F}_5\text{I}$ ,  $n\text{-C}_3\text{F}_7\text{I}$ , and  $\text{iso-C}_3\text{F}_7\text{I}$ , with 1,1-difluoroethylene, decreased C-I bond strength parallels decreased yield of higher telomers with the exception of  $\text{C}_2\text{F}_5\text{I}^*$  which gives a lower yield of high telomers than  $n\text{-C}_3\text{F}_7\text{I}$ . We must therefore regard  $\text{C}_2\text{F}_5\text{I}$  as a more efficient chain transfer agent than  $n\text{-C}_3\text{F}_7\text{I}$  despite its having a greater C-I bond strength, or conclude that there are important factors affecting the course of these telomerisations in addition to those outlined in Chapter 1. (p.16). It is conceivable that both radical-chain processes and four-centre type reactions are taking place concurrently but with the information available there is no means of telling.

---

\* Haszeldine and Steele<sup>52</sup> obtained a similar low yield of high telomers when they carried out this reaction.

It was obviously desirable to carry out the exchange reaction with pentafluoriodobenzene but technical difficulties prevented satisfactory results from being obtained. As the C-I bond strength increases in the series iso-C<sub>3</sub>F<sub>7</sub>I, n-C<sub>3</sub>F<sub>7</sub>I, C<sub>2</sub>F<sub>5</sub>I, CF<sub>3</sub>CH<sub>2</sub>I, CF<sub>3</sub>I, the reaction of a polyfluoroiodoalkane with mercury under the influence of ultra-violet light changes from one of coupling to one of mercurial formation

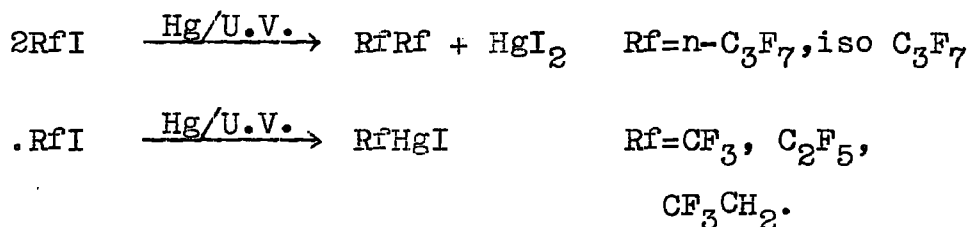

This reaction can therefore be used to give an idea of the C-I bond strength in a polyfluoroiodo compound. The reaction of mercury with pentafluoriodobenzene under the influence of ultra-violet radiation was therefore undertaken. The main product was found to be bis-pentafluorophenyl mercury. This result is not surprising since it is known that pentafluorophenyl mercuric iodide readily disproportionates into mercuric iodide and bis-pentafluorophenyl mercury.<sup>189</sup> (in contrast to C<sub>6</sub>F<sub>5</sub>HgCl and C<sub>6</sub>F<sub>5</sub>HgBr). It therefore seems that the C-I bond strength in pentafluoriodobenzene is of the same order as trifluoroiodomethane and pentafluoroiodoethane rather than that of the perfluoroiodopropanes for it is clear that pentafluorophenylmercuric iodide is the initial product of the reaction.

### Experimental

Tubes were filled with accurately known amounts of iodide and iodine as follows.

An apparatus such as in fig. 8a was constructed. Palladous iodide was weighed out onto a fibre-glass filter 'paper' and introduced through the open end Q. The apparatus was sealed at  $R_1$  taking care not to heat the palladous iodide, and then fitted to the vacuum system in fig. 8 b.

The tap and cone of flask A were carefully greased, avoiding excess grease (Apiezon L). The flask was then fitted to the vacuum system (fig. 8b) and evacuated. With taps  $T_1$ ,  $T_3$  and  $T_4$  closed,  $T_2$  was opened and the bulb removed from the vacuum line. The grease was carefully cleaned from the cone and the rest of the bulb was polished with a chamois leather. After leaving in the balance case for fifteen minutes, the bulb was weighed to the nearest tenth of a milligramme. A was reattached to the vacuum line and with B, which contained the iodide, silver powder and phosphorus pentoxide, cooled in liquid air, and  $T_1$ ,  $T_4$  and  $T_5$  open, the apparatus was again pumped down to a 'sticking' vacuum.  $T_1$  was closed and B was allowed to warm slowly until the pressure in the system was sufficient to introduce the required amount of iodide

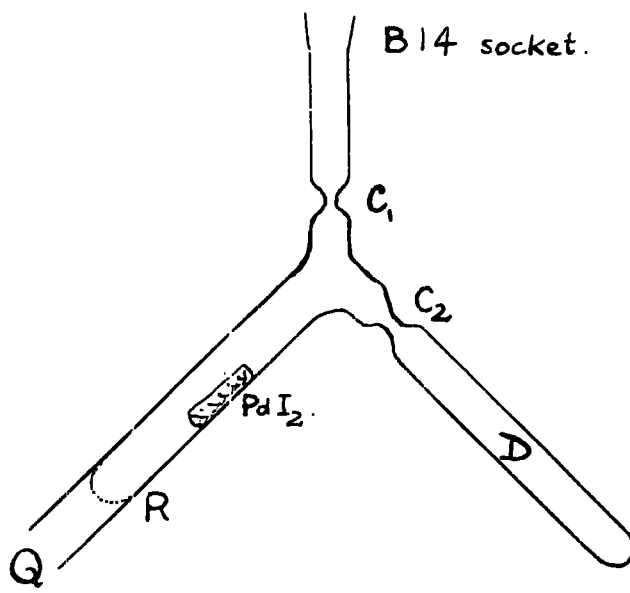

Fig. 8a

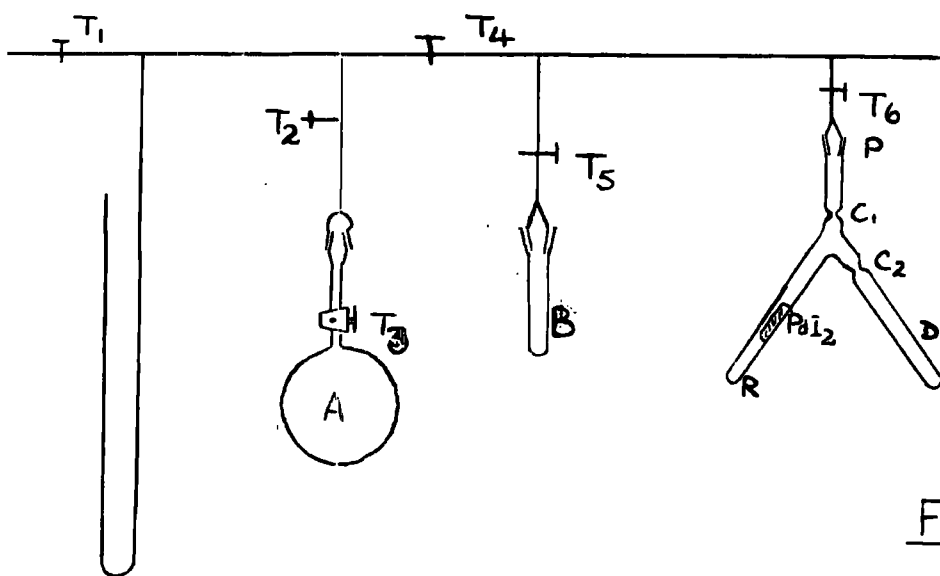

Fig 8b.

into A.  $T_3$  was closed and the weight of the sample found by removing, cleaning and reweighing A as before. A was returned to the vacuum line which was evacuated with  $T_1$ ,  $T_4$ ,  $T_6$  open and  $T_5$  closed. D was 'flamed out' then the sample was transferred to D by closing  $T_1$ , opening  $T_3$  and cooling the lower end of D in liquid air. With  $T_6$  closed the constriction  $C_1$  was sealed. The palladous iodide was gently heated and the iodine produced by its decomposition collected in the cooled end of D. Constriction  $C_2$  was sealed.

Tubes filled in the above manner were heated in an oil bath for a measured length of time, after which the lower tip was plunged into liquid air to 'freeze' the reaction. The tube was opened and the contents washed into a 12 ml. standard flask with A.R. carbon tetrachloride. The solution was shaken with silver powder until the iodine colour disappeared, filtered, and then a 10 ml. aliquot was taken and 'counted' in a liquid counter, a background count having been taken.

In the cases of trifluoroiodomethane and pentafluoroiodoethane, a different technique had to be employed. After the heating, the iodide was distilled from silver powder to a vacuum system (Fig. 2, p.87) and a weighed sample decomposed in the manner described for the analysis of

volatile compounds (page 93). An aliquot of the aqueous solution of iodide ions was counted.

The specific activity of the palladous iodide was determined by decomposing a known weight in an evacuated apparatus similar to that used for the irradiation experiments. The iodine was washed from the tube with either A.R. carbon tetrachloride or alkaline thiosulphate, whichever was appropriate, into a 100 ml. standard flask and a 10 ml. aliquot of this was 'counted'.

Reaction between pentafluoriodobenzene and mercury  
under the influence of ultra-violet radiation

Pentafluoriodobenzene (2 gms., .007 moles) was sealed in a tube with mercury and shaken in a horizontal position at 15 cms. from a 1 kw. ultra-violet lamp. After 4 days, the tube was opened and a small amount of pentafluoriodobenzene (recognised by its retention time) was distilled out under vacuum. The contents of the tube were washed three times with ether. The solution was filtered and the ether distilled off. The residue was sublimed under reduced pressure. The sublimate appeared to be a mixture so a second and more careful sublimation was carried out. A white crystalline sublimate (.3 gms.) was obtained which was recognised by its infra-red spectrum and by its melting point ( $138^{\circ}\text{C}$ ) (lit.<sup>191</sup>  $140^{\circ}\text{C}$ ) as

being bis-pentafluorophenylmercury. Remaining in the sublimation apparatus was a pale yellow glassy solid (.2 gms.) which did not have a definite melting point but which softened on warming.

REFERENCES

1. HENNE & FINNEGAN J.A.C.S., 1950, 72, 3806.
2. HASZELDINE, J.C.S., 1951, 584.
3. HASZELDINE, Nature, 1950, 166, 192.
4. HAUPTSCHHEIN &, GROSSE, J.A.C.S., 1951, 73, 2461.
5. BANKS, EMELEUS, HASZELDINE & KERRIGAN, J.C.S., 1948, 2188.
6. HASZELDINE, J.C.S., 1949, 2856.
7. KRESPAN, J.O.C., 1958, 23, 2016.
8. HASZELDINE, J.C.S., 1952, 993.
9. HASZELDINE, J.C.S., 1952, 4259.
10. SIMONS, & BRICE, U.S.P., 2,614,131., 1952  
c.a. 1953, 8770c.,
11. CHAMBERS, MUSGRAVE & SAVORY, Proc.Chem.Soc., 1961, 113.
12. CHAMBERS, MUSGRAVE & SAVORY, J.C.S., 1961, 3779.
13. HAUPTSCHHEIN, J.A.C.S., 1961, 83, 2383.
14. KRESPAN, J.O.C., 1962, 27, 1813.
15. EMELEUS, & HASZELDINE, J.C.S., 1949, 2948.
16. HENNE & RENOLL, J.A.C.S., 1936, 58, 889.
17. GILMAN, & JONES, J.A.C.S., 1943, 65, 2037.
18. HASZELDINE, & STEELE, J.C.S., 1954, 923.
19. KROGH, REID & BROWN, J.O.C., 1954, 19, 1124.
20. HAUPTSCHHEIN, FAINBERG, & BRAID, J.O.C., 1958, 23, 322.
21. HAUPTSCHHEIN, FAINBERG, & BRAID, U.S.P., 2,920,111, (1960)  
c.a. 1960, 54, 17266h.

22. GILMAN, & JONES, J.A.C.S., 1943, 65, 1458.
23. COFFMAN, RAASCH, RIGBY,  
BARRICK, & HANFORD, J.O.C., 1949, 14, 747.
24. BARR, GIBSON, & LAFFERTY, J.A.C.S., 1951, 73, 1352.
25. HASZELDINE, J.C.S., 1952, 4423.
26. HENNE, & POSTELNECK, J.A.C.S., 1955, 77, 2335.
27. HASZELDINE, & OSBORNE, J.C.S., 1956, 61.
28. HAUPTSCHHEIN, BRAID, &  
FAINBERG, J.A.C.S., 1961, 83, 2495.
29. BISSEL, & SHAW, J.O.C., 1962, 27, 1482.
30. PARK, SEFFL, & LACHER, J.A.C.S., 1956, 78, 59.
31. HASZELDINE, & STEELE, J.C.S., 1957, 2800.
32. HASZELDINE, J.C.S., 1953, 2075.
33. TARRANT, & LILYQUIST, J.A.C.S., 1955, 77, 3640.
34. FRIED, & MILLER, J.A.C.S., 1959, 81, 2078.
35. TIERS, BROWN, & REID, J.A.C.S., 1953, 75, 5978.
36. McBEE, KELLY, & RAPKIN, J.A.C.S., 1950, 72, 5071.
37. MILLER, & FAINBERG, J.A.C.S., 1957, 79, 4164.
38. KRUNYANTS, SHOKINA, &  
KULESHOVA, Invest. Akad. Nauk, S.S.S.R.,  
Otdel, Khim. Nauk. 1960, 1693.  
c.a. 1961, 55, 9254.
39. HAUPTSCHHEIN, STOKES, &  
GROSSE, J.A.C.S., 1952, 74, 1974.
40. WALBORSKY, BAUM, &  
LONCRINI, J.A.C.S., 1955, 77, 3637.
41. HASZELDINE, & OSBORNE, J.C.S., 1955, 3880.
42. MOBBS, Private Communication.

43. HAUPTSCHHEIN, KINSMAN,  
& GROSSE, J.A.C.S., 1952, 74, 849.
44. BRICE, & SIMONS, J.A.C.S., 1951, 73, 4016.
45. HENNE, & KRAUS, J.A.C.S., 1951, 73, 1791.
46. HASZELDINE, & STEELE, J.C.S., 1953, 1592.
47. HASZELDINE, J.C.S., 1953, 3761.
48. HASZELDINE, & LEEDHAM, J.C.S., 1953, 1548.
49. HASZELDINE, & STEELE, J.C.S., 1953, 1199.
50. HASZELDINE, J.C.S., 1953, 3559.
51. HASZELDINE, J.C.S., 1953, 3565.
52. HASZELDINE, & STEELE, J.C.S., 1955, 3005.
53. KISBY, Private Communication.
54. HASZELDINE, Nature, 1951, 167, 139.
- 55 . HASZELDINE, Nature, 1951, 168, 1025.
56. HASZELDINE, J.C.S., 1955, 4291.
57. HAUPTSCHHEIN, BRAID, &  
LAWLOR, J.A.C.S., 1957, 79, 2549.
58. HAUPTSCHHEIN, BRAID, &  
LAWLOR, J.A.C.S., 1958, 80, 846.
59. MILLER, FREID, & GOLDWHITE, J.A.C.S., 1960, 82, 3091.
60. TIERS, J.O.C., 1962, 27, 2261.
61. TIERS, J.A.C.S., 1960, 82, 5513.
62. BRACE, J.O.C. 1962, 27, 3033.
63. BRACE, J.A.C.S., 1962, 84, 3020.
64. BRACE, J.O.C., 1962, 27, 3027.
65. HASZELDINE, J.C.S., 1953, 922.
66. HASZELDINE, Nature, 1950, 165, 152.

67. HASZELDINE, J.C.S., 1952, 2504.
68. HASZELDINE, J.C.S., 1951, 588.
69. HASZELDINE, J.C.S., 1951, 2495.
70. HASZELDINE, J.C.S., 1950, 3037.
71. BANUS, EMELEUS, & HASZELDINE, J.C.S., 1950, 3041.
72. HENNE, & NAGER, J.A.C.S., 1951, 552Z.
73. HASZELDINE, & STEELE, J.C.S., 1957, 2193.
74. HENNE, & KRAUS, J.A.C.S., 1954, 76, 1175.
75. HASZELDINE, J.C.S., 1952, 3490.
76. HASZELDINE, & LEEDHAM, J.C.S., 1952, 3483.
77. HAUPTSCHIEIN, & OESTERLING, J.A.C.S., 1960, 82, 2868.
78. CHAMBERS, Ph.D. Thesis, Durham 1959.
79. KNUNYANTS, SHOKINA, Doklady, Akad. Nauk, S.S.S.R. & CHZHI-YUAN LI 1959, 129, 328.  
c.a. 1960, 54, 7528.
80. ISERSON, HAUPTSCHIEIN, & LAWLOR, J.A.C.S., 1959, 81, 2676.
81. HAUPTSCHIEIN, Chem. & Eng. News., 1958, 36, No. 38, 48.
82. CRAWFORD, & SIMONS, J.A.C.S., 1955, 77, 2605.
83. CRAWFORD, & SIMONS, J.A.C.S., 1953, 75, 5735.
84. BRICE, & SIMONS, U.S.P., 2,554,219, (1951)  
c.a. 1952, 46, 2560.
85. SCHMEISSER & SCHARF, Angew. Chem., 1960, 324.
86. BOWERS, IBANEZ, DENOT, & BACCERRA, J.A.C.S., 1960, 82, 4001.
87. MILLER, FRIED, & GOLDWHITE, J.A.C.S., 1960, 82, 3091.
88. MUSGRAVE, Chem. & Ind. 1959, 46.

89. CHAMBERS, MUSGRAVE, & SAVORY, *Analyst*, 1961, 86, 356.
90. JOHNCOCK, MUSGRAVE, & WIPER, *Analyst*, 1959, 84, 245.
91. SAVORY, Ph.D. Thesis, Durham, 1961.
92. LIGETT, *Anal. Chem.*, 1954, 2, 748.
93. SEZERAT, *Ann. Pharm. Franç.*, 1955, 13, 745.
94. LEWIS, & NAYLOR, *J.A.C.S.*, 1947, 69, 1968.
95. BUTLER, *J.A.C.S.*, 1962, 84, 1393.
96. PARK, LYCAN, & LACHER, *J.A.C.S.*, 1951, 73, 711.
97. PACIOREK, MERKL, & LENK, *J.O.C.*, 1962, 27, 1015.
98. SCHAEFER, *Can. J. Chem.* 1962, 40, 1.
99. BANWELL, & SHEPPARD, *Proc. Roy. Soc.*, 1962, A263, 136.
100. HASZELDINE, & STEELE, *Chem. & Ind.*, 1951, 684.
101. SWARTS, *Bull. acad. roy. Belg.*, 1901, 383.
102. HASZELDINE, *J.C.S.*, 1953, 1764.
103. BRACE, *J.O.C.*, 1962, 27, 4491.
104. HAUPTSCHHEIN, & BRAID, *Belg. Pat.* 612,520. (1962) c.a. 1962, 57, 16,397.
105. ALDRICH, HOWARD, LINN, MIDDLETON, & SHARKEY, *J.O.C.*, 1963, 28, 184.
106. HANFORD, & JOYCE, U.S.P. 2,440,800. (1948)
107. STEPHANI, HERK, & SWARC, *J.A.C.S.*, 1961, 83, 4732.
108. BUCKLEY, & SWARC, *J.A.C.S.*, 1956, 78, 5696.
109. TARRANT, LOVELACE, & LILYQUIST, *J.A.C.S.*, 1955, 77, 2783.
110. COSCIA, *J.O.C.*, 1961, 26, 2995.

111. LOVELACE, RAUSCH, &  
POSTELNEK,  
"Aliphatic Fluorine  
Compound". Reinhold  
Publishing Corp., N.Y.  
1958, p.38.
112. HARRIS, & STACEY,  
J.A.C.S., 1961, 83, 840.
113. CASE, RAY, & ROBERTS,  
J.C.S., 1961, 2070.
114. BURCH, GOLDWHITE, &  
HASZELDINE,  
J.C.S., 1963, 1083.
115. PARK, ROGERS, & LACHER,  
J.O.C., 1961, 26, 2089.
116. MADORSKY, HART, STRAUS,  
& SEDLACK,  
J. Res. Nat. Bur. Standards,  
1953, 51,327.
117. MILLER,  
U.S.P. 2,598,283, (1952).  
c.a. 1952, 46, 7824e.
118. ADAMS, & BOVEY,  
J. Polymer Sci, 1952, 9,  
481.
119. CHAMBERS, TULLOCK, &  
COFFMAN,  
J.A.C.S., 1962, 84, 2337.
120. SAUER,  
U.S.P. 2,549,935, (1951).  
c.a. 1951, 45, 6874c.
121. HAUPTSCHIN, & LESSER,  
J.A.C.S., 1956, 78, 676.
122. DIXON, REXFORD, & RUGG,  
Ind. Eng. Chem., 1957,  
49, 1687.
123. MUSGRAVE & SMITH,  
Unpublished work.
124. ELEUTERIO,  
U.S.P., 2,958,685 (1960)  
c.a. 1961, 55, 6041c.
125. HAUPTSCHIN, FAINBERG, &  
BRAID,  
J.A.C.S., 1958, 80, 842.
126. BROWN,  
J.O.C., 1957, 22, 1256.
127. MANOWITZ,  
Nucleonics, 1953, 11, 18  
c.a., 1954, 48, 3162c.
128. BRO,  
J. App. Polymer Sci.,  
1959, 1, 310.

129. MADORSKI, & STRAUS, J. Res. Nat. Bur. Standards, 1959, 63, 261.
130. INGOLD, Structure and Mechanisms in Organic Chemistry. Cornell U.P. 1953, p. 75.
131. POSTLENECK, Ind. Eng. Chem., 1958, 50, 1602.
132. PARK, ABRAMS, HEIN, GRAY, & LACHER, J.O.C., 1958, 23, 1661.
133. SMITH, Proc. Int. Rubber Conference. 1959.
134. FERGUSON, J.A.C.S., 1960, 82, 2416.
135. PACIOREK, MITCHELL & LENK, J. Polymer Science, 1960, XLV, 405.
136. PACIOREK, MERKL, LENK, J.O.C. 1962, 27, 266.
137. BANUS, EMELEUS, & HASZELDINE, J.C.S., 1951, 60.
138. EMELEUS, Angew, Chem. 1962, 1, 129.
139. LAGOWSKI, Quarterly Revs. 1959, 13 233.
140. HAUPTSCHHEIN & BRAID, J.A.C.S., 1961, 83, 2500.
141. HAUPTSCHHEIN & BRAID, J.A.C.S., 1961, 83, 2505.
142. PIERCE, McBEE & JUDD, J.A.C.S., 1954, 74, 474.
143. PASSINO & RUBIN, U.S.P. 2,686,194, c.a. 1955, 49, 1363.
144. GEYER, HASZELDINE, LEEDHAM, & MARKLOW, J.C.S., 1957, 4472.
145. CLARK & WILLIS, J.C.S., 1960, 82, 1888.
146. CHAMBERS, CLARK & WILLIS, Chem. & Ind. 1960, 76.
147. BANKS, BEVAN & MUSGRAVE, Chem. & Ind. 1959, 296.

- 148.. KAESZ, PHILLIPS & STONE, Chem. & Ind., 1959, 1409.
149. KAESZ, PHILLIPS & STONE, J.A.C.S., 1960, 82, 6228.
150. TREICHEL & STONE, Chem. & Ind., 1960, 837.
151. CLARK & WILLIS, Proc. Chem. Soc., 1960, 282.
152. ELEUTERIO & MOORE, 2nd International Symposium on Fluorine Chemistry, Estes Park, 1962.
153. SPERATI, Proc. Gordon Research Conference. 1962.
154. BENNET, EMELEUS & HASZELDINE, J.C.S., 1953, 1565.
155. BRANDT, EMELEUS & HASZELDINE, J.C.S., 1952, 2552.
156. DALE, EMELEUS, HASZELDINE & MOSS, J.C.S., 1957, 3708.
157. BURG, MAHLER, BILBO, HABER & HERRING, J.A.C.S., 1957, 79, 247.
158. BANKS & HASZELDINE, "Advances in Inorganic Chemistry and Radiochemistry. Vol. III". Academic Press. N.Y. 1961, p.337.
159. CLARK, "Advances in Fluorine Chemistry, Vol. III". Butterworth, 1963. p. 19.
160. HASZELDINE & WEST, J.C.S., 1956, 3631.
161. CULLEN, Canad. J. Chem., 1960, 38, 439.
162. CULLEN, Canad. J. Chem., 1960, 38, 445.
163. CULLEN, GREEN & HOCHSTRASSER, Canad. J. Chem., 1961, 39, 2868.

164. BRANDT, EMELEUS &  
HASZELDINE, J.C.S., 1952, 2198.
165. HAUPTSCHHEIN & GROSSE, J.A.C.S., 1951, 73, 5461.
166. DALE, EMELEUS & HASZELDINE, J.C.S., 1958, 2939.
167. McBEE, ROBERTS & CURTIS, J.A.C.S., 1955, 77, 6387.
168. HENNE & FRANCIS, J.A.C.S., 1953, 75, 992.
169. HASZELDINE, J.C.S., 1953, 1748.
170. HASZELDINE & WALASCHEWSKI, J.C.S., 1953, 3607.
171. MILLER, BERGMAN, &  
FAINBERG, J.A.C.S., 1957, 79, 4159,
172. CHAMBERS, MUSGRAVE, &  
SAVORY, J.C.S., 1962, 1993.
173. EMELEUS & HASZELDINE, J.C.S., 1949, 2953.
174. HAUPTSCHHEIN, SAGGIOMO &  
STOKES, J.A.C.S., 1956, 78, 680.
175. MANUEL, STAFFORD & STONE, J.A.C.S., 1961, 83, 249.
176. McBEE, CAMPBELL & ROBERTS, J.A.C.S., 1955, 77, 3149.
177. KING, TREICHEL, & STONE, J.A.C.S., 1961, 83, 3593.
178. KING, STAFFORD, TREICHEL &  
STONE, J.A.C.S., 1961, 83, 3604.
179. TIERS, J.O.C., 1961, 26, 2538.
180. KRESPAN, J.A.C.S., 1961, 83, 3432.
181. KRESPAN, J.A.C.S., 1961, 83, 3434.
182. HENNE & FOX, J.A.C.S., 1953, 75, 5750.
183. EMELEUS, HASZELDINE &  
WALASCHEWSKI, J.C.S., 1953, 1552.
184. HAUPTSCHHEIN, BRAID &  
LAWLOR, J.A.C.S., 1957, 79, 6248.
185. KNUNYANTS, DYATKIN &  
GERMAN, Doklady Akad. Nauk S.S.S.R.,  
1959, 124, 1065.  
c.a., 1959, 53, 14920e.

186. HASZELDINE, U.S.P., 2,833,831, (1958)  
c.a. 1958, 52, 15,564.
187. EMSLEY, Unpublished work.
188. STEACIE, "Atomic and Free Radical  
Reactions". Reinhold,  
1954. p. 263.
189. CHAMBERS, Unpublished observations.
190. HODGINS & HAINES, Canad. J. Chem., 1952, 30,  
473.
191. CHAMBERS, COATES,  
LIVINGSTONE &  
MUSGRAVE, J.C.S., 1962, 4367.

