

## Durham E-Theses

---

### *Heathland ecology and vegetation history of Tulloch Moor, Inverness-Shire*

David Roland Ascroft

#### How to cite:

---

Ascroft, David Roland (1989) Heathland ecology and vegetation history of Tulloch Moor, Inverness-Shire. Masters thesis, Durham University.

#### Use policy

---

The full-text may be used and/or reproduced, and given to third parties in any format or medium, without prior permission or charge, for personal research or study, educational, or not-for-profit purposes provided that:

- a full bibliographic reference is made to the original source
- a <https://etheses.durham.ac.uk/id/eprint/6525/> is made to the metadata record in Durham E-Theses
- the full-text is not changed in any way

The full-text must not be sold in any format or medium without the formal permission of the copyright holders.

Please consult the [full Durham E-Theses policy](#) for further details.

HEATHLAND ECOLOGY AND VEGETATION HISTORY OF TULLOCH MOOR, INVERNESS-SHIRE

D.R. Ascroft

ABSTRACT of dissertation submitted for the degree of M.Sc. at the University of Durham 1990

Tulloch Moor is part of the RSPB reserve at Loch Garten. It contains a very good example of *Calluna-Arctostaphylos* heath.

The vegetation of the moor was examined by means of 44 2x2m sample plots. 32 of these were in 8 permanently marked 4x4m quadrats, and provide a baseline to measure future change. 7 plots outside the permanent transect showed further variation in the heathland vegetation. The data indicate that time since burning, colonisation by trees, and variation in soil type are the important factors in determining the present variation.

Ordination separated the Tulloch Moor heath relevés from those given by McVean & Ratcliffe (1962) for the *Arctostaphyleto-Callunetum* which more often included *Pyrola media* and *Dicranum scoparium*, however the heath relevés were more similar to the *Arctostaphyleto-callunetum* than to *Callunetum vulgaris*.

The vegetation history of Tulloch Moor was investigated by pollen analysis of a sample of peat and a surface sample of moss. The peat sample was not dated. The pollen analysis indicates that there was a period when the Moor, or at least the sampling locality, was much more wooded than now, mainly with pine and some birch. Prior to this there was an open heath with some trees, much as now. Following the wooded period, the tree cover declined to a low level, and then increased in the recent past to its present level.

Characteristics and measurements of *Ericales* reference pollen were compared with those of fossil pollen, and the results of the different methods of identification were compared. Most of the fossil pollen tetrads were *Erica tetralix* which presently grows on the peat bog surface. Very few tetrads of *Arctostaphylos* pollen were found, and these were at or near the surface.

Examination of the peat for charcoal fragments indicates that fires have occurred in the area throughout the period represented by the peat sample. Some peaks in charcoal abundance are followed by a decline in tree pollen, indicating that fire was a cause of tree decline.



## DECLARATION

No part of this dissertation has previously been submitted by the author for another degree at the University of Durham, nor at any other university.

Assistance from other people is indicated in the Acknowledgements, and information from other sources is indicated in situ and in the References, but responsibility for any error or omission rests with the author.

**HEATHLAND ECOLOGY AND VEGETATION HISTORY OF TULLOCH MOOR,  
INVERNESS-SHIRE**

**A dissertation submitted in partial fulfilment of the requirements for the degree of Master of  
Science at the University of Durham, November, 1990.**

**M.Sc. by Advanced Course in Ecology, Department of Biological Sciences, 1988-89**

The copyright of this thesis rests with the author.  
No quotation from it should be published without  
his prior written consent and information derived  
from it should be acknowledged.

**David Roland Ascroft**



**22 SEP 1992**

## CONTENTS

	Page
ACKNOWLEDGEMENTS	8
INTRODUCTION	9
THE STUDY SITE	19
PRESENT-DAY VEGETATION	
Aims	26
Methods and Materials	26
Minimal Area	26
Permanent Plots	28
Photographic Methods	28
Further Sampling of Vegetation	28
Plant Species List	30
Results	
Minimal area	31
Permanent plots	31
Further vegetation sampling	36
Plant species list	37
Analysis and Discussion	
Ordination	37
Permanent plots	38
Further vegetation sampling	43
Comparison with other <i>Calluna-Arctostaphylos</i> heaths	54
Soils	61
Plant species list	62
VEGETATION HISTORY	
Aims	63
Methods and Materials	63
Choice of Peat Sampling Site	63
Laboratory Methods	65
Pollen Identification and Counting	67
Ericales Pollen	69
Charcoal	69
Juniper Ring Counts	70
Historical Ecology	70
Results and Discussion	
Reference Pollen	71
Comparison of Pollen in Profiles A & B	71
The Pollen Record and Vegetation History	74
Ericales Pollen and Heathland History	83
Charcoal and Fire History	95
Value of the Peat Sampling Site	98
Juniper Ring Counts	98
Historical Ecology	99
CONCLUSIONS	105
FURTHER STUDIES	106
REFERENCES	107
LIST OF MAPS & AERIAL PHOTOGRAPHS	112
APPENDICES	113

## List of Appendices

- 1 Climate at Loch Garten
- 2 Photographs of 4x4m permanent plots  
& Layout of photographs 34 to 38
- 3 Data for determination of minimal area
- 4 Domin Scale of plant cover/abundance
- 5 Data for permanent plots 1 and 2
- 6 Domin scores for permanent plots 1 and 2. Plot 1  
.. .. Plot 2
- 7 Scheme for conversion of Domin scores from 16 1x1m to four 2x2m  
sub-plots within permanent plot numbers 1 and 2
- 8 Domin scores for permanent plots, divided into four 2x2m sub-plots  
& Physical data for permanent plots
- 9 Domin scores for 2x2m relevés  
& Physical data for relevés 100 to 122
- 10 List of plant species found on Tulloch Moor within RSPB reserve
- 11 Comparison of pollen frequencies in A and B profiles
- 12 Pollen frequencies in peat from Tulloch Moor
- 13 Pollen percentages in peat from Tulloch Moor
- 14 Diameter of *Arctostaphylos* reference pollen  
& Diameter of Ericales fossil pollen
- 15 Characteristics of Ericales reference pollen
- 16 Measurements of Ericales reference pollen
- 17 Characteristics of Ericales fossil pollen
- 18 Measurements of Ericales fossil pollen
- 19 Ericales fossil pollen identities. Agreement between methods of  
identification
- 20 Occurrence of Ericales fossil and surface pollen
- 21 Charcoal particles in 0.5cm<sup>3</sup> peat samples

## List of Figures

		Page
1	Distribution of <i>Arctostaphylos uva-ursi</i>	10
2	Distribution of <i>Arctostaphylos uva-ursi</i> in the British Isles	11
3	10km-square distribution of <i>Arctostaphylo-Callunetum</i>	11
4	Locations of <i>Arctostaphylos-Calluna</i> heaths studied by Ward (1971)	13
5	Locations of <i>Arctostaphylos-Calluna</i> heaths recorded by McVean & Ratcliffe, Ward, & Urquhart	13
6	Locations of stands of <i>Arctostaphylo-Callunetum</i> given by McVean & Ratcliffe (1962)	15
7	Sites of <i>Arctostaphylos</i> heathland listed by Urquhart (1962)	15
8	Sites of Flandrian pollen diagrams	18
9	Location of Tulloch Moor	18
10	Map of Tulloch Moor and the RSPB Loch Garten Reserve	20
11	Soil map of the RSPB Loch Garten Reserve	22
12	NCC habitat map for Abernethy Forest SSSI (part)	24
13	Locations of permanent plots and relevés on Tulloch Moor	27
14	Determination of minimal area	32
15	<i>Calluna</i> + <i>Arctostaphylos</i> cover in 2x2m sub-plots in transect	34
16	Juniper cover in 2x2m sub-plots in transect	34
17	Cover of minor dwarf shrubs in 2x2m sub-plots in transect	34
18	Sum of Domin scores of grasses in 2x2m sub-plots in transect	35
19	Sum of Domin scores of mosses in 2x2m sub-plots in transect	35
20	Sum of Domin scores of herbs in 2x2m sub-plots in transect	35
21	Decorana: 2x2m sub-plots Axes 1x2. Samples plotted as sample number	40
22	Decorana: 2x2m sub-plots Axes 1x2. Species	39
23	Decorana: 2x2m sub-plots Axes 1x2. Species (plant type plotted as symbol)	40
24	Decorana: 2x2m sub-plots Axes 1x2. Samples plotted as Juniper Domin score	41
25	Decorana: 2x2m sub-plots Axes 1x2. Samples plotted as sum of lichen scores	41
26	Decorana: 2x2m sub-plots Axes 1x2. Samples plotted as sum of grass scores	42
27	Decorana: 2x2m sub-plots Axes 1x2. Samples plotted as sum of herb scores	42
28	Decorana: heath & woodland relevés. Samples plotted as sample number	44
29	Decorana: heath relevés Axes 1x2. Samples shown as sample number	44
30	Decorana: heath relevés (downweighting). Soil indicator species	46
31	Decorana: heath relevés (downweighting). Species preferring mineral soils	46
32	Decorana: heath relevés Axes 1x2. Species (rare species downweighted)	48
33	Decorana: heath relevés (downweighting). Samples plotted as sample number	49
34	Decorana: heath relevés (downweighting). Samples plotted as no. of herb species	49

35-39	Decorana: heath relevés with downweighting of rare species. Samples are plotted as the Domin score of the species given	
35	<i>Hypericum pulchrum</i>	50
36	<i>Viola riviniana</i>	50
37	<i>Anemone nemorosa</i>	51
38	<i>Vaccinium myrtillus</i>	51
39	<i>Erica cinerea</i>	52
40	Decorana: Tulloch Moor heath relevés + 8 stands of <i>Arctostaphylo-Callunetum</i>	56
41	Samples plotted as Domin score of <i>Pyrola media</i>	56
42	Samples plotted as Domin score of <i>Dicranum scoparium</i>	57
43	Samples plotted as Domin score of <i>Hypericum pulchrum</i>	57
44	Decorana: Tulloch Moor heath relevés + 19 stands from McVean & Ratcliffe (1962)	59
45	Decorana: relevés from 1x1m quadrats in <i>Arctostaphylos</i> heathland (Urquhart 1986)	59
46	Location of peat sample site	64
47	Sketch of peat sampling site	66
48	Sampling of peat	66
49	Tetrad measurements	66
50	Pollen percentages in A & B profiles at 3cm depth	72
	Pollen percentages in profile A at 3 and 6cm depth	72
51	Pollen diagram	73
52	Age vs depth in peat profile by Birks (1970). Dates from Birks & Mathewes (1978)	78
53a	Principal Components Analysis of pollen samples + O'Sullivan's (1973a) surface samples. Principal taxa only	81
53b	Pollen surface samples on Tulloch Moor	82
54	<i>Arctostaphylos</i> reference pollen. Tetrad diameter (any orientation)	82
55	Ericales reference pollen measurements d vs D	85
56	Ericales reference pollen measurements: means and 95% confidence limits	86
57	Comparison of Inflated & Non-inflated <i>Erica tetralix</i> tetrads on CVA plot	88
58	Canonical Variates Analysis of Ericales reference pollen measurements	90
59	Characteristics of Ericales reference pollen tetrads on CVA plot	91
60	Characteristics of Ericales fossil pollen tetrads on CVA plot	92
61	Ericales pollen diagram	94
62	Charcoal diagram (scaled values)	96
63	Archaeological sites near Tulloch Moor	102

#### List of Plates

1	1978 Aerial photograph of Tulloch Moor	25
2	The transect from plot 3 eastwards	33
3	The transect from plot 4 westwards	33

## ACKNOWLEDGEMENTS

I am grateful for the help, advice, encouragement and patience throughout this project of my supervisor, Dr. Brian Huntley.

I am also grateful to:

The RSPB for permission to work on the Loch Garten reserve,  
and in particular:

John Hunt, Senior Reserves Manager in Scotland

Stewart Taylor, Warden at Loch Garten

Dr. Ceri Evans

Richard Thaxton

The Nature Conservancy Council, and the staff of the area office at Achantoul, Aviemore

In particular:

Mrs. Lucy Norval

Mr. Andrew Dorin

Dr. Nigel Buxton.

I have received help of many and various kinds from the following:

Mrs. Marina Dennis

Mr. Hamish Gordon

Mr. Basil Dunlop, Forest Conservation Services, Lynemacgregor, Grantown-on-Spey, Moray  
PH26 3PR

Dr. J.H. Gauld, and the Macaulay Land-use Research Institute, Craigiebuckler, Aberdeen  
AB9 2QJ

Dr. Annabel Gear

Mrs. Jacqui Huntley

Mr. Stephen Palmer

Dr. Judith Turner

Dr. D.B. Jackson

Miss Sarah Wilson

Mr. Mark Erikson

The technicians and secretarial staff of the Department of Biological Sciences at Durham  
University.

## INTRODUCTION

### Overall aim

This project is concerned with the heathland ecology and vegetation history of Tulloch Moor in general, but in particular it is concerned with this site as one of the foremost examples of *Arctostaphylos* heaths in Britain.

Tulloch Moor is part of the RSPB reserve at Loch Garten, and it is part of the Abernethy Site of Special Scientific Interest (SSSI). The project arose out of discussions between myself and John Hunt who is the Senior Reserves Manager in Scotland for the Royal Society for the Protection of Birds (RSPB), Stewart Taylor who is the Warden at Loch Garten, and Dr. Brian Huntley who acted as supervisor.

The overall aim of the project is to produce information which will help to determine the value of, and the best management for, the site in question.

### *Arctostaphylos uva-ursi*

*Arctostaphylos uva-ursi*(L.) Sprengel is described by Hultén (1970) as a circumpolar species, and which he includes in the group having separate east-west races (Figure 1). The distribution of this species in Britain is given by Perring and Walters (1976) (Figure 2). It is clearly widespread in the Scottish Highlands but not elsewhere. The Nature Conservancy Council (NCC) (1986) list 63 'local species' of vascular plants in Britain which have declined through afforestation. This list includes *Arctostaphylos uva-ursi*, *Antennaria dioica*, *Genista anglica* and *Pyrola media*, all of which grow on Tulloch Moor.

### *Calluna-Arctostaphylos* heaths

Smith (1911) described a variant of *Calluna* heath in the eastern highlands of Scotland in which *Arctostaphylos uva-ursi* is locally sub-dominant, and is the first plant to recover after burning. Certain herbaceous species are more abundant here than in other heath types. Muir and Fraser (1940) list, among others, a dry *Calluna-Arctostaphylos* heath type with many subsidiary species. They state that after burning *Arctostaphylos* becomes dominant and the subsidiaries enjoy increased vigour.

Figure 1  
 Distribution of *Arctostaphylos uva-ursi*

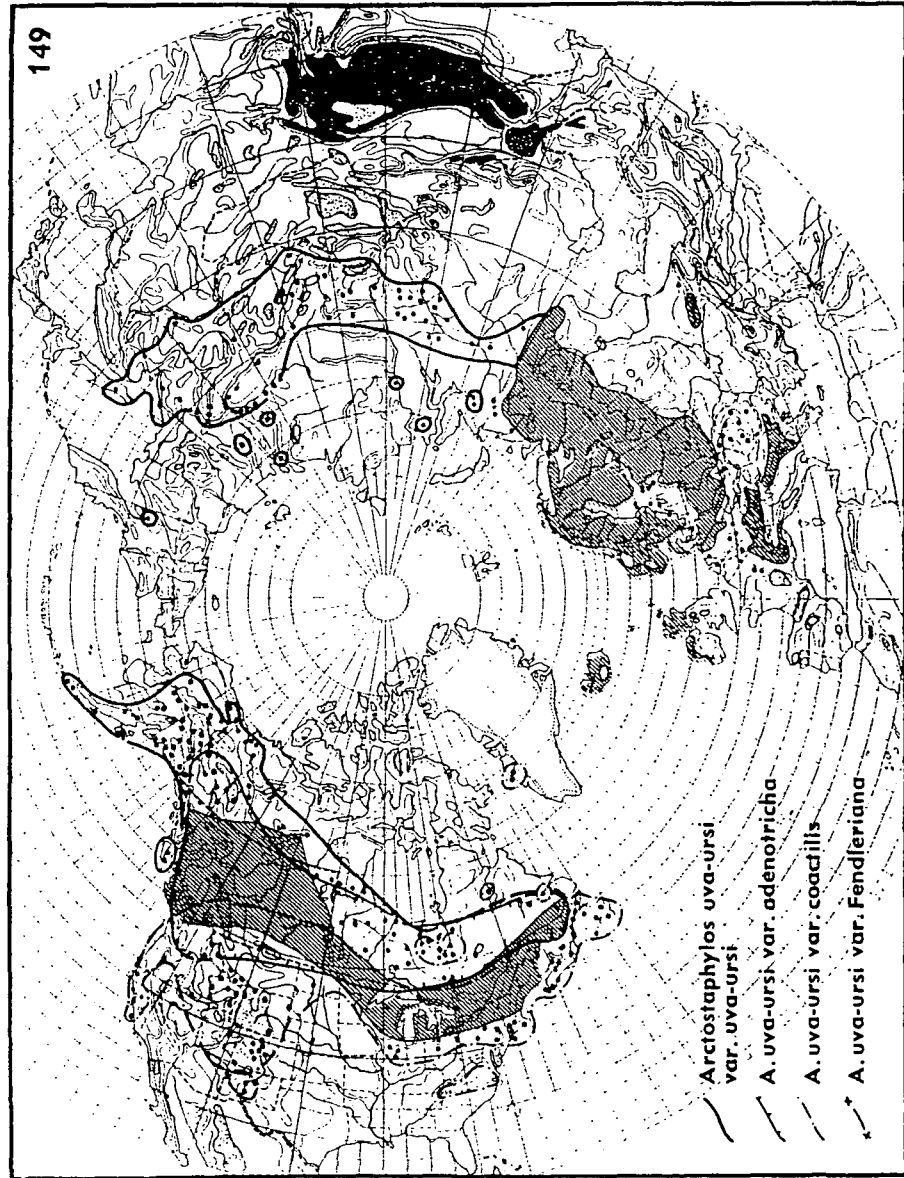

Figure 2 Distribution of *Arctostaphylos uva-ursi* in the British Isles

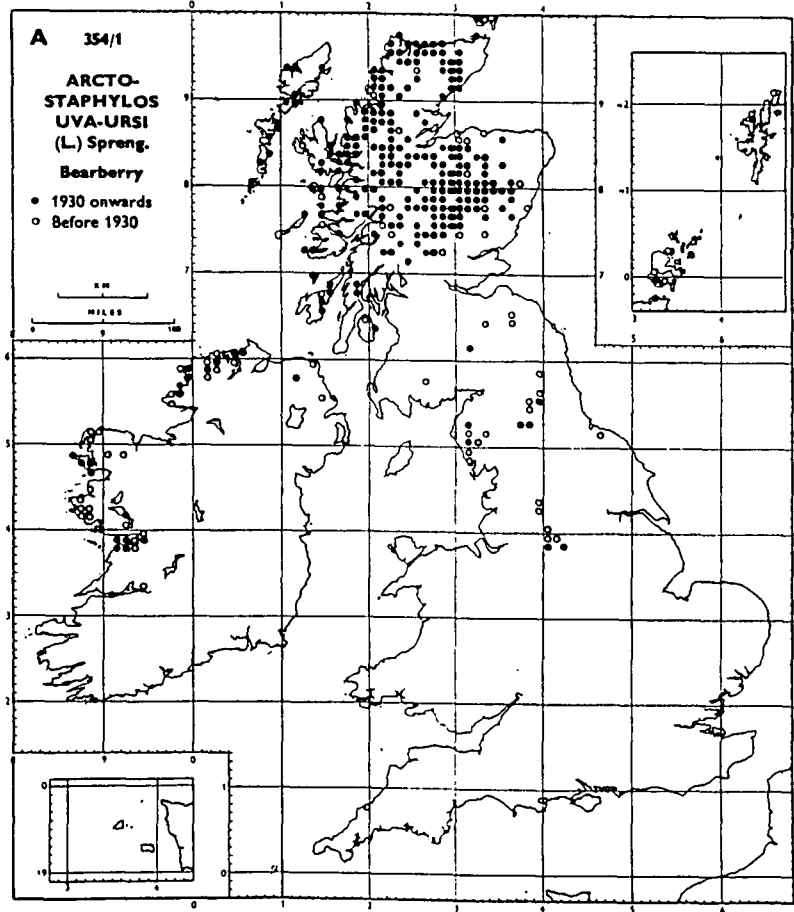
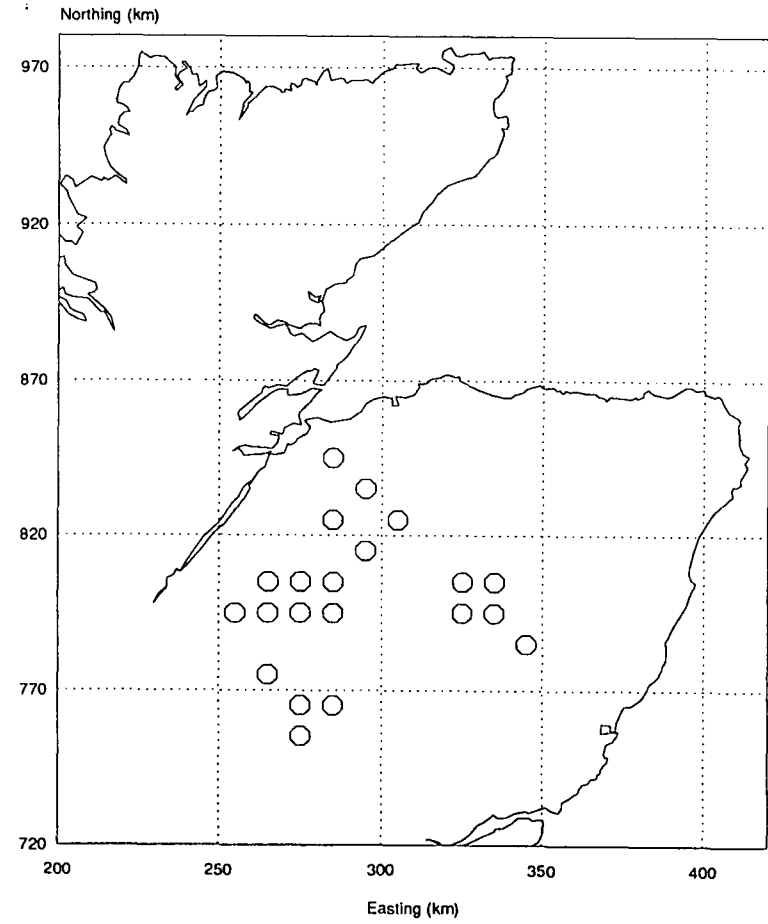

Fig. 3 *Arctostaphyleto-Callunetum*: 10km square distribution by Mcvean & Ratcliffe 1962



This type of heath community is described by McVean & Ratcliffe (1962) as an Association, and they name it *Arctostaphyleto-Callunetum*. They say that it is close enough to pure heather moor (*Callunetum vulgaris*) to be regarded as a mere facies of the latter, although they give *Lathyrus montanus*, *Lotus corniculatus*, *Pyrola media*, and *Viola riviniana* as differential species which are present in *Arctostaphyleto-Callunetum*. *Arctostaphylos* may be abundant in heather moor, and it also occurs with *Calluna* in other Associations, for example in lichen-rich dwarf *Calluna* heath found at higher altitude (700m+) in the Cairngorms, and in *Racomitrium*-rich dwarf *Calluna* heath in the northern Highlands. These examples lie outwith the altitudinal and geographic range of the *Arctostaphyleto-Callunetum*, and experience different environments. McVean & Ratcliffe also mention another type of *Racomitrium*-rich *Calluna-Arctostaphylos* vegetation in the north-west Highlands, which they say may be an oceanic development of the *Arctostaphyleto-Callunetum*, but there the climate is wetter than in the east where the *Arctostaphyleto-Callunetum* occurs (Met.Office, 1989). Their map of the distribution of *Arctostaphyleto-Callunetum* in Scotland is shown in Figure 3, and the locations of their sample plots are shown in Figure 6.

Gimingham (1964) describes a distinctive *Calluna-Arctostaphylos* heath community in the eastern Highlands, mainly in the altitudinal range 225-600m. He recognizes this as the *Arctostaphyleto-Callunetum* of McVean & Ratcliffe, although his list of the most constant species is not quite the same as their constants. Gimingham (1961) gives data for species-rich stands containing *Calluna* and *Arctostaphylos* from S.W. Norway and S.W. Sweden, but subsequently (Gimingham, 1964), he says the Scottish heath-type bears only a slight relationship to Scandinavian heaths.

Ward (1971a & b) reviews the *Arctostaphyleto-Callunetum* based on 58 stands in Scotland. Their locations are shown in Figure 4. From his multivariate data analysis he considers that McVean & Ratcliffe placed too much importance on *Pyrola media*, and he uses their original criteria to produce new lists of constant species, and new differential constants which are *Anemone nemorosa*, *Campanula rotundifolia*, *Hypericum pulchrum* and *Viola riviniana*.

Gimingham (1964) and other authors emphasize that many *Calluna* heaths, including *Calluna-Arctostaphylos* heaths, are derived from woodland anthropogenically, and are maintained by burning and grazing. He describes the seral processes of these heaths following burning, and Ward(1970) investigated the ecology of an extensive example of *Calluna-Arctostaphylos* heath at Muir of Dinnet. He extended this study to cover the other sites shown in Figure 4 (Ward 1970a). These include Tulloch Moor.

Urquhart (1986) surveyed *Arctostaphylos* heathlands in north-east Scotland, listing and describing some new sites, as well as some sites already investigated. She does not distinguish between sites with *Arctostaphyleto-Callunetum* and others, but she states that the survey covered lowland

Fig. 4 Arctostaphylos-Calluna heaths studied by Ward (1971)

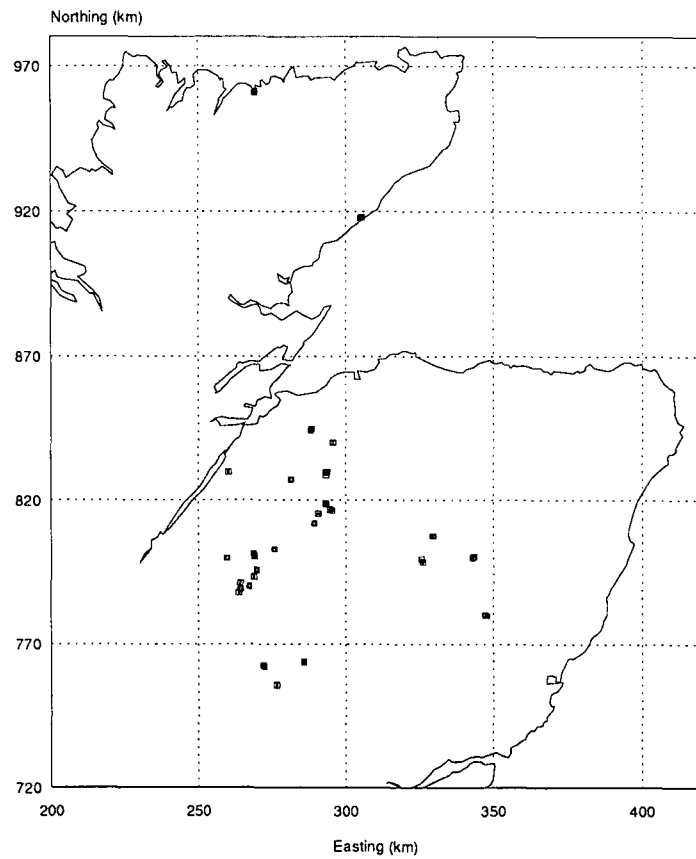
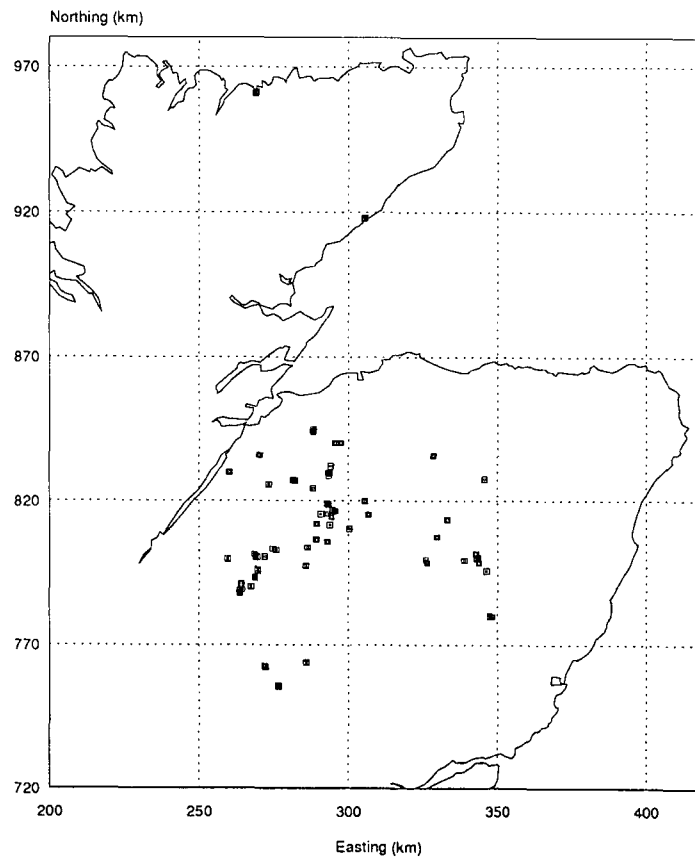

Fig. 5 Arctostaphylos-Calluna heaths recorded by McV. & Rat., Ward & Urquhart



heathland communities and was aimed at species-rich *Arctostaphylos* heathland. Locations of the sites she lists are shown in Figure 7.

The locations of all the sites listed by McVean & Ratcliffe (1962), Ward (1971a) and Urquhart (1986) are shown together in Figure 5. This reinforces the original distribution given by McVean & Ratcliffe, although Ward excludes some of these from the *Arctostaphylo-Callunetum*. Urquhart lists some losses of, or changes to, known sites, including those of McVean & Ratcliffe at Lagganlia (Glen Feshie), and Boat of Garten. In addition the Bin and Clashindarroch forests described by Muir and Fraser have been planted with conifers.

### Conservation and the need for monitoring

Gimingham (1975) advocates the conservation of heathlands within nature reserves, but he stresses the need for management based on sound ecological principles. He recommends that burning be the minimum required to control succession to woodland. Urquhart (*op.cit.*) emphasises the need for burning to maintain *Arctostaphylos* heathland. General statements by McVean & Ratcliffe (*op.cit.*) and Gimingham (1964) indicate that *Calluna-Arctostaphylos* heathland reverts to birch woodland if unmanaged. Birches (*Betula pendula* & *B. pubescens*), Scots pine (*Pinus sylvestris*), and juniper (*Juniperus communis*) appear to be colonizing the moor, and RSPB management has included burning in small patches, as well as birch control by hand. From aerial photographs taken in the 1960s and 70s it is clear that tree regeneration/colonization has occurred. Some management practices are either prohibited or restricted on the SSSI by the NCC as Potentially Damaging Operations (PDOs). Both the NCC and the RSPB acknowledge the need to monitor the situation. In 1988 the RSPB set up a series of eight permanent 4x4m plots along a 200m transect across part of the moor, and recording these plots as a baseline against which to measure future vegetation change was a primary objective of the project.

Existing information on the ecology of Tulloch Moor includes that held by the NCC under the description of the Abernethy SSSI, of which The Moor forms the western extremity. The RSPB holds much information in the Reserve management plans and annual reports.

Success in conservation management could be measured in different ways, for example. stability, maintenance of diversity, maximising diversity, progression of natural succession to 'climax', or maximising size of remaining fragments of semi-natural habitats. Not all of these may be compatible in one site. In order to choose between criteria for management, the vegetation history and origin of present habitats may be enlightening (Huntley, in press b).

Figure 6

Stands of *Arctostaphylo*-*Callunetum*  
given by McVean & Ratcliffe (1962)

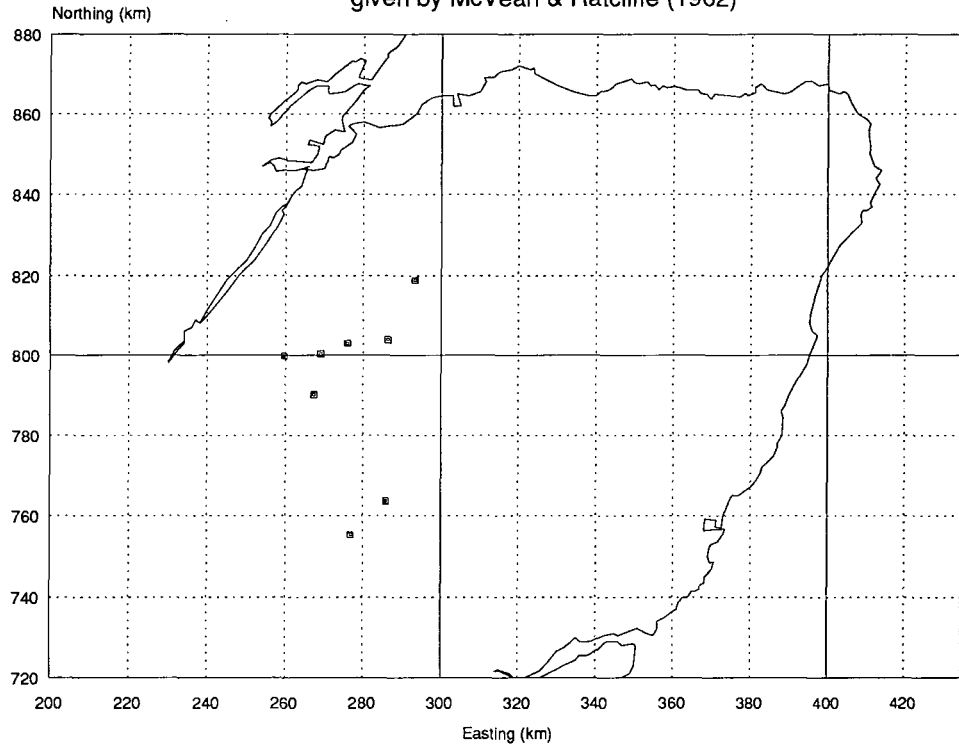
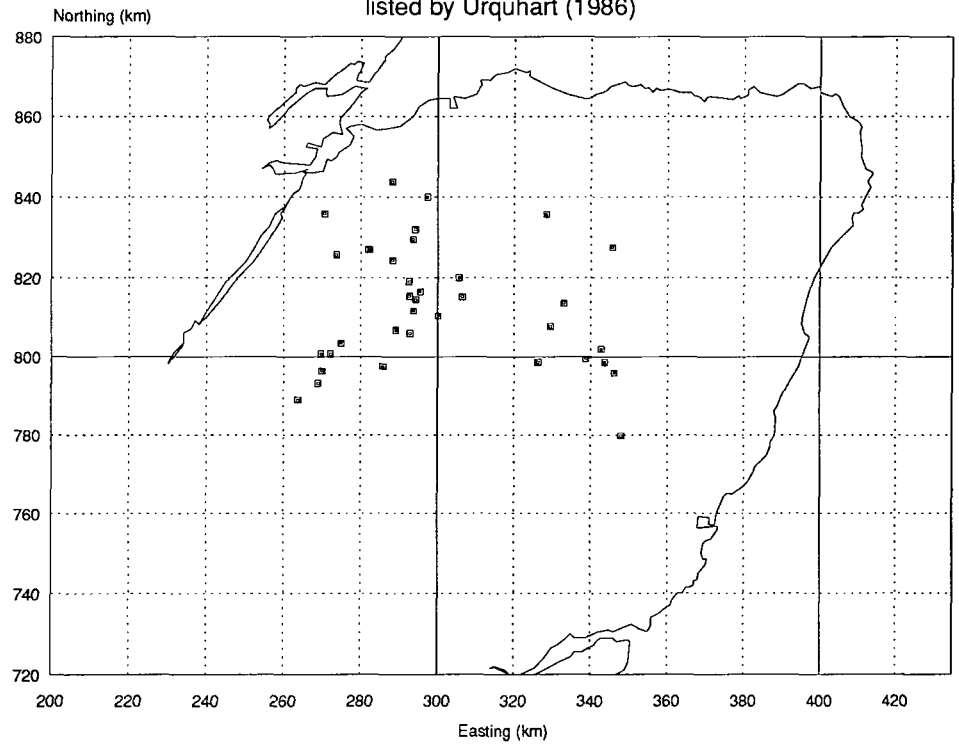

Figure 7

Sites of *Arctostaphylos* heathland  
listed by Urquhart (1986)



## History of *Arctostaphylos uva-ursi* in the British Isles

Fossil evidence of the history in Britain and Ireland of *Arctostaphylos uva-ursi*, *Calluna*, and other species found on Tulloch Moor, and on other *Calluna-Arctostaphylos* heaths is given by Godwin (1975). *Calluna*, *Erica tetralix*, *E.cinerea*, *Vaccinium vitis-idaea* and *Empetrum* are all recorded from previous interglacial deposits. *Arctostaphylos uva-ursi* seeds have been found at Histon Rd., Cambridge in a deposit from the Ipswichian Interglacial. This is roughly 80-120 thousand years BP (Before Present). (Timing of the Ipswichian taken from Bradley, 1985, p.186). *Arctostaphylos* has also been recorded from a number of sites in deposits from the last glacial epoch (the Weichselian). Several of these sites lie outside the present range of the species in Britain. Godwin (op.cit.) considers that it was widespread during the Late Weichselian, and it has been subsequently restricted to higher latitudes. Birks (1980) describes the vegetation types on the moraines below the Klutlan Glacier at 61 °N in Yukon Territory, Canada; among these are communities in which *A. uva-ursi* is a major component of the vegetation. The January mean temperature in this region is -28 °C and the July mean is 14 °C. Connolly & Dahl (1970) associate the range limit of this species in Britain with the isotherm corresponding to the maximum summer temperature on the hills. This is the 24 °C isotherm in Scotland and Ireland, and the 26 °C isotherm in England.

### Background to vegetation history

There have been studies of Quaternary vegetation history in Scotland since early this century. Lewis (1905, 1906, etc.) looked at the macroscopic plant remains in peat deposits which he examined stratigraphically (i.e. in successive layers down a profile). He attempted to reconstruct past environments by analogy with the present-day environment found where these plants grow today, eg. *Salix reticulata* in the Arctic tundra. Lewis looked at numerous peat profiles in different areas and identified regional and local differences in the patterns of vegetation history.

Several quantitative methods have been developed, of which pollen analysis has been very widely used and much refined (Faegri & Iversen, 1964). In principle, changes in the relative abundance of pollen from the base toward the surface in a stratified deposit are taken to reflect changes in the vegetation with time. Godwin (1975) synthesized much pollen and 'macrofossil' evidence into a general outline of the vegetation history of the British Isles.

Durno (1959) produced pollen diagrams from peat deposits in the eastern Grampians (see Figure 8) which he was able to compare with diagrams which he produced earlier (1956) from Aberdeenshire, Kincardineshire, and elsewhere. The late-glacial and early post-glacial history of the central Grampians has been studied by Walker (1975). Some long pollen diagrams showing a continuous record throughout the post-glacial in the region have been produced, eg. from Loch

Kinord in Deeside (Vasari & Vasari, 1968). Unlike lochs such as Kinord, the small basin which Huntley (in press a) sampled at Morrone Birkwoods National Nature Reserve will have a narrow pollen catchment and so will reflect much more local changes in the vegetation.

Bennett (1984) has produced a complete record of the post-glacial history of Scots Pine in the British Isles, and a general summary of the forest history, with maps, has been made by Birks et al. (1975), and more recently for the uplands by Birks (1988) See also Birks (1989). A summary of the vegetation history of the native pinewoods is given by O'Sullivan (1975).

Birks (1970) produced a long pollen diagram from very close to Tulloch Moor, the sampling site being between Lochs Garten & Mallachie. The pollen spectra in the diagram are dominated by tree taxa, and they show the forest history rather than that of the Moor. Birks and Matthews (1978) returned to the site to take a new core which was analysed for both pollen and microfossils, but this study covered the late Devensian (late-glacial) and early Flandrian (early post-glacial) periods, and not the recent past.

O'Sullivan (1973c, 1974a, 1976) has studied the vegetation history of Abernethy in detail, with pollen diagrams being produced from Loch Garten, Loch a' Chnuic and Loch Pityoulish, as well as from mor humus profiles and surface samples, both from within Abernethy Forest, and from outside, including Tulloch Moor.

#### Archaeological & historical ecology

Rackham (1986) and Sheail (1980) illustrate the wide range of approaches to historical ecology. Old maps and some other information collected by O'Sullivan (1973b & 1974b) and Dunlop (unpublished) about the history of Abernethy Forest is relevant to Tulloch Moor. Both oral and documentary evidence was forthcoming from the graziers Mrs. Dennis and Hamish Gordon, as well as from the Warden. O.S. maps date from 1874 and aerial photographs from 1948 (see Maps & Aerial Photographs after References).

In summary, there is a good background of information on the ecology of *Arctostaphylos* heaths, and on the vegetation history of the region.

Fig. 8 Sites of Flandrian pollen diagrams

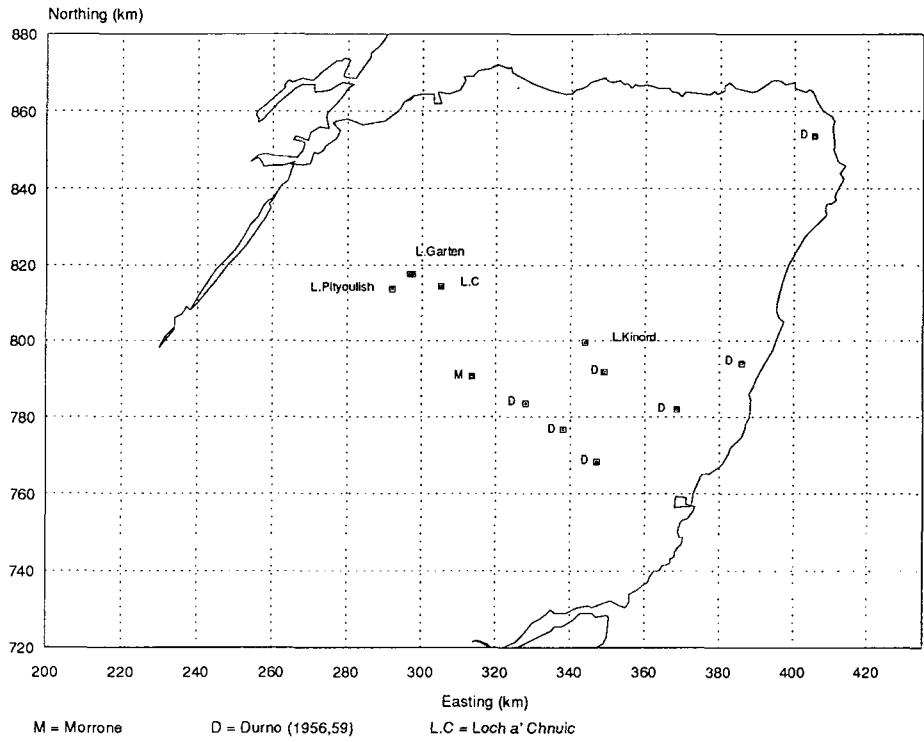
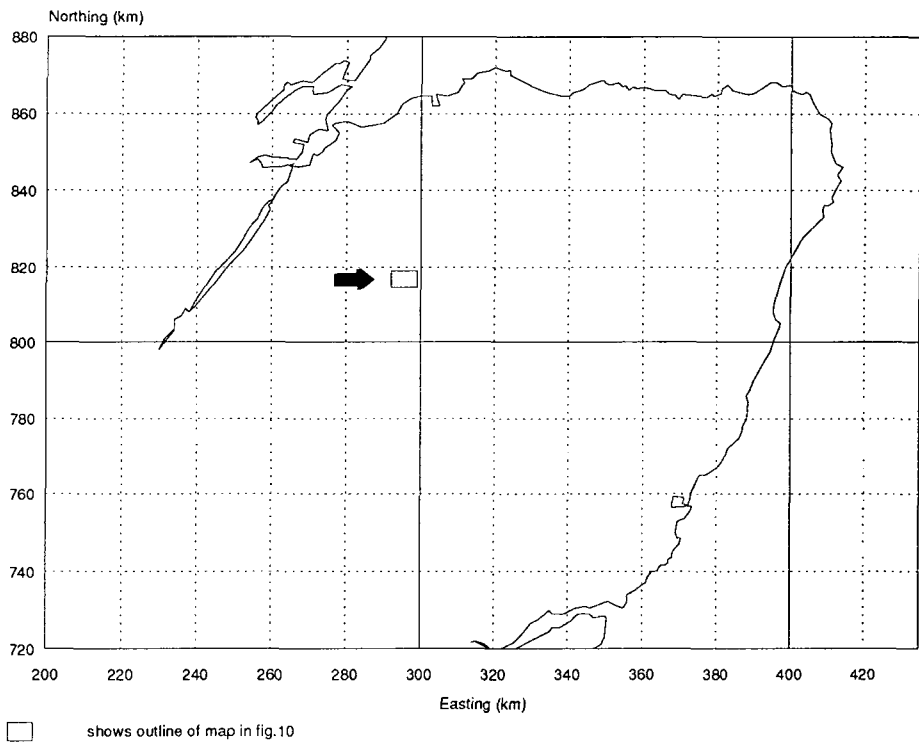

Fig. 9 Location of Tulloch Moor



## THE STUDY SITE

### Location and extent

Figure 9 shows the location of Tulloch Moor, and Figure 10 is a map of the Moor. I have not defined the Moor boundaries, but it may be thought of as the unenclosed land outwith the continuous woodland. This allows for changes in the boundary over time, for example by the establishment of the more recent conifer plantation on the west side, bordering the B970 road. In recent years trees, mainly birch, have spread in from the south and east so that there is now more continuous woodland along the roadside than shown on the map in square 96 16. Most of the Moor is within the RSPB reserve, but part of it lies to the south and west of the reserve boundary.

### Ownership & land use

The area within the RSPB reserve is shown (see Figure 10). It was purchased in 1975 from Seafield Estates. The area south of the road is part of the Reidhaven Estate. The grazing rights on Tulloch Moor are divided into 5 shares which presently belong to 3 crofts:

Inchdryne

Mains of Tulloch

Tontearie

The present stock are all sheep. Not all the shares are currently used, and so the present stocking rate of sheep is well below what it could be. Grazing and browsing are consequently reduced. In addition to peat cutting by the RSPB, each of the crofts currently hold peat cutting rights. Peat is traditionally cut by hand, but since 1985 there has also been some cutting by machine.

### Geology

The bedrock of the region is partly composed of granite masses, the largest of which is the Cairngorms. These masses or batholiths are surrounded by metamorphic rocks of the Moine series, i.e. schists and granulites (see Institute of Geological Sciences 1979). The IGS 1 inch geological map (IGS 1964) shows bedrock over the entire area of Tulloch Moor to be overlain by fluvio-glacial sand and gravel, covered in places by peat.

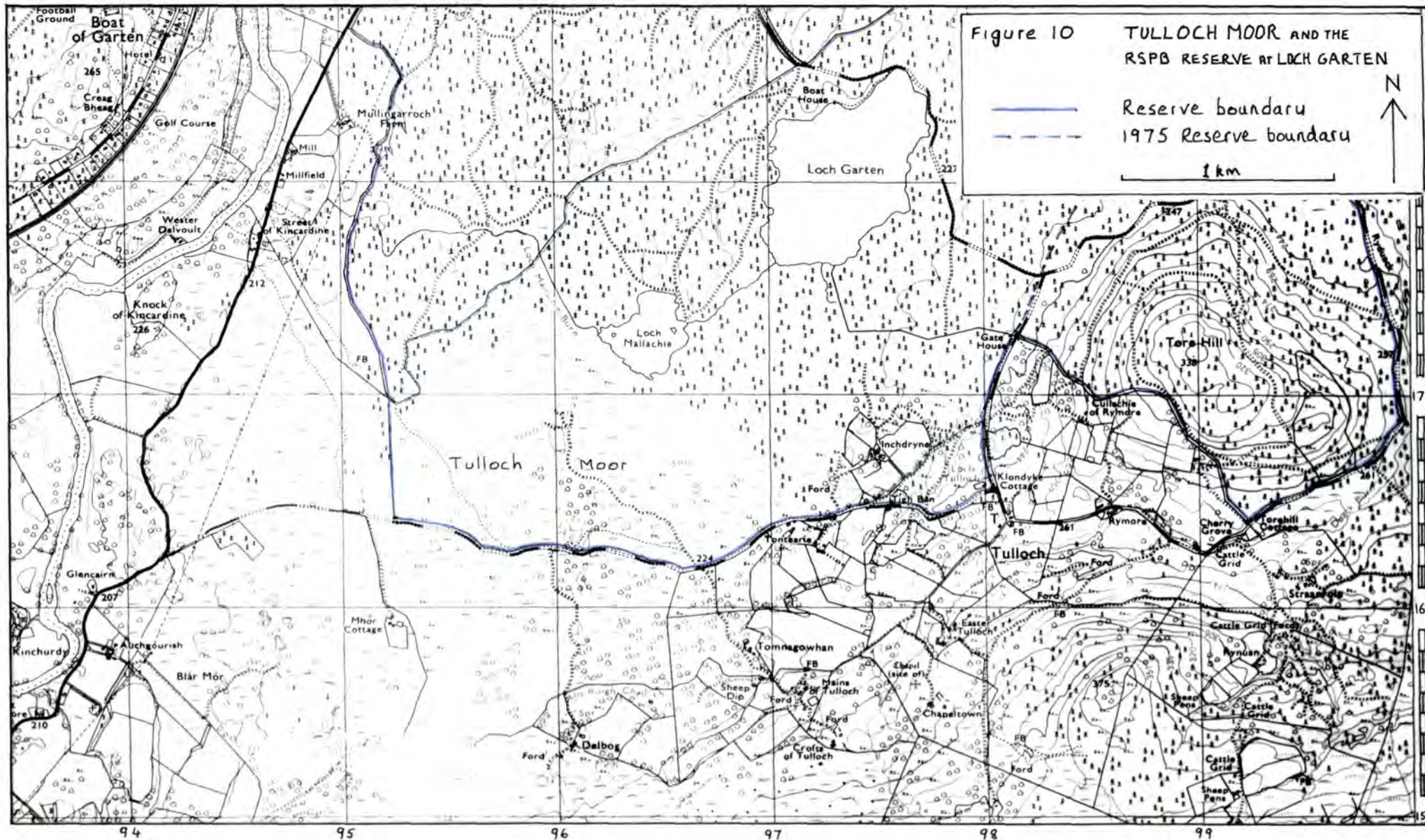

## Landforms

The glacial geomorphology of the area has been investigated in detail by Young (1977) who mapped the landforms resulting from deglaciation. Lochs Garten and Mallachie and the surrounding peat-filled basin are a large kettle-hole, with a number of smaller kettle-holes around it, eg. Delbog. The heath on Tulloch Moor lies on the sand and gravel of eskers and kame-and-kettle topography.

## Soils

Soil types in Scotland are described and illustrated by Fitzpatrick (1964). The soils of Abernethy, including Tulloch Moor, were surveyed by Gauld (1982). Apart from peat, he describes the soil beneath the 'boreal heather-moor' community on Tulloch Moor. This is an iron humus podzol which possesses a slight variation in its surface organic horizons. He identifies a 'herb-rich variant of the boreal heather-moor' with a further, distinctive humus iron podzol variant which is typical of the surrounding birchwoods. Most notably he states that an 'old cultivated horizon' is discernible in this soil, which is described, together with the other soils, in more detail in Gauld (unpublished). This paper includes a soil map of the Loch Garten Reserve as purchased in 1975 (see Figure 11), and a map of peat deposits.

## Climate

A summary of the weather records from the Loch Garten reserve made by the warden over the period 1977-89 is given in Appendix 1. The climate is drier than in the west of Scotland: total annual precipitation averages 810 mm, as compared with 1098 mm at Fort Augustus, or 1981 mm at Onich, near Fort William (Meteorological Office, 1989). Rainfall is very variable from month to month, but on average, it is well spread throughout the year, for example see the 1989 figures in Appendix 1. The winters are cold: the mean daily minimum temperature in January is -4.6 °C, and the lowest temperature recorded on the reserve is -26 °C. The January mean daily min. at Braemar over 1951-1980 was -2.5 °C and at Onich it was 0.9 °C (Met. Office, Op.cit.). The lowest temperature recognized by the Met. Office in Britain is -27.2 °C which was recorded at Braemar in February 1895 and again in January 1982. The Summers are relatively warm: this is illustrated by the July mean daily maximum temperature which is 19.5 °C. The corresponding figure for Onich, is 17.2 °C, but if this adjusted to the same altitude as Loch Garten, it becomes 15.8 °C. The July mean daily maximum for Braemar is also 17.2 °C, but this is at 339m above sea level, and so it becomes 18 °C when adjusted to the altitude of Loch Garten.

Figure 11 Soil map of the RSPB Loch Garten Reserve

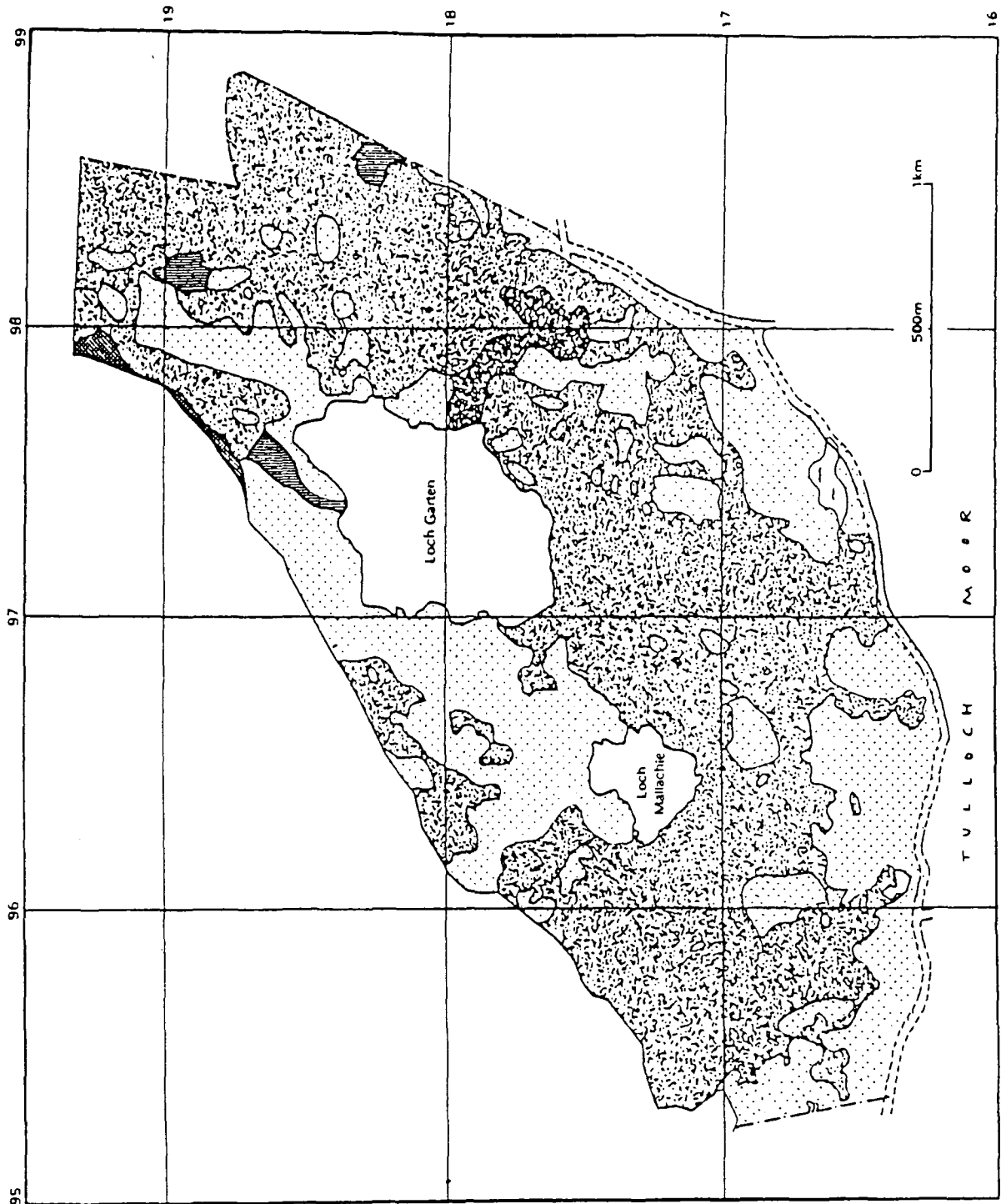

ASSOCIATION	PARENT MATERIAL	SERIES	
		Iron Humus Podzols Freely Drained	Peaty Gleys Poorly Drained
DULSIE	Stratified & partially sorted gravelly fine sands derived from acid schists and granites		
CORBY	Fluvioglacial sands and gravels mainly derived from acid schists and granites		
BOYNDIE	Fluvioglacial sands		
		<i>includes Iron Podzols</i>	
<p>depth 0.5-1m <math>&gt;1m</math></p>		UNDIFFERENTIATED ALLUVIUM	
BASIN PEAT			

To summarise, this is a relatively continental climate in comparison to the west of Scotland where the climate is oceanic. The climate of Scotland is described by Green (1964), and climate patterns are described and illustrated in Met.Office (1952) for Britain, and in Met.Office (1989) for Scotland.

## Vegetation

The distribution of woodland, open water and open heath + mire can be seen in Figure 10, and on the habitat map in Figure 12. These can be seen in more detail on the aerial photograph (Plate 1). Peat cuttings, burns and the courses of drains are also clearly visible. The ground and field vegetation of the Abernethy SSSI has been mapped by the NCC at 1:10000 scale (see Figure 12). In broad terms, the vegetation types surrounding the Moor are: loch and margin, conifer plantation, native pine or pine-birch woodland, farmland (crofts), birch and alder woodland, and unenclosed rough grazing. Again in broad terms, the vegetation types on Tulloch Moor are: heathland, mire/peat bog, birch woodland, birch/juniper/heath, pine/birch woodland, lochan & margins, roadside & tracks.

## Other wildlife interest

See RSPB (undated) In addition to the heath and associated vegetation, the conservation interest includes the peat-mire where there are cranberry (*Vaccinium oxycoccos*) and sundews (*Drosera* spp.). Black grouse, red grouse, curlew, cuckoo, skylark, meadow pipit, and carrion/hooded crow are among the birds which breed. Among other mammals, roe deer are resident, and red deer probably cross the moor, and may graze on it. Molehills were evident on each of my visits to the Moor in 1989. Common lizards are present. Invertebrates include large red damselfly, common blue damselfly, and butterflies: scotch argus, common blue, small pearl-bordered fritillary, small heath, large heath, and painted lady. The diversity of butterflies may depend on the diversity of flowering plants on the Moor.

FIGURE 12

Nature Conservancy Council habitat map  
(Field layer) for Abernethy Forest SSSI

This is an extract from the original by Clive McKay in 1986/87

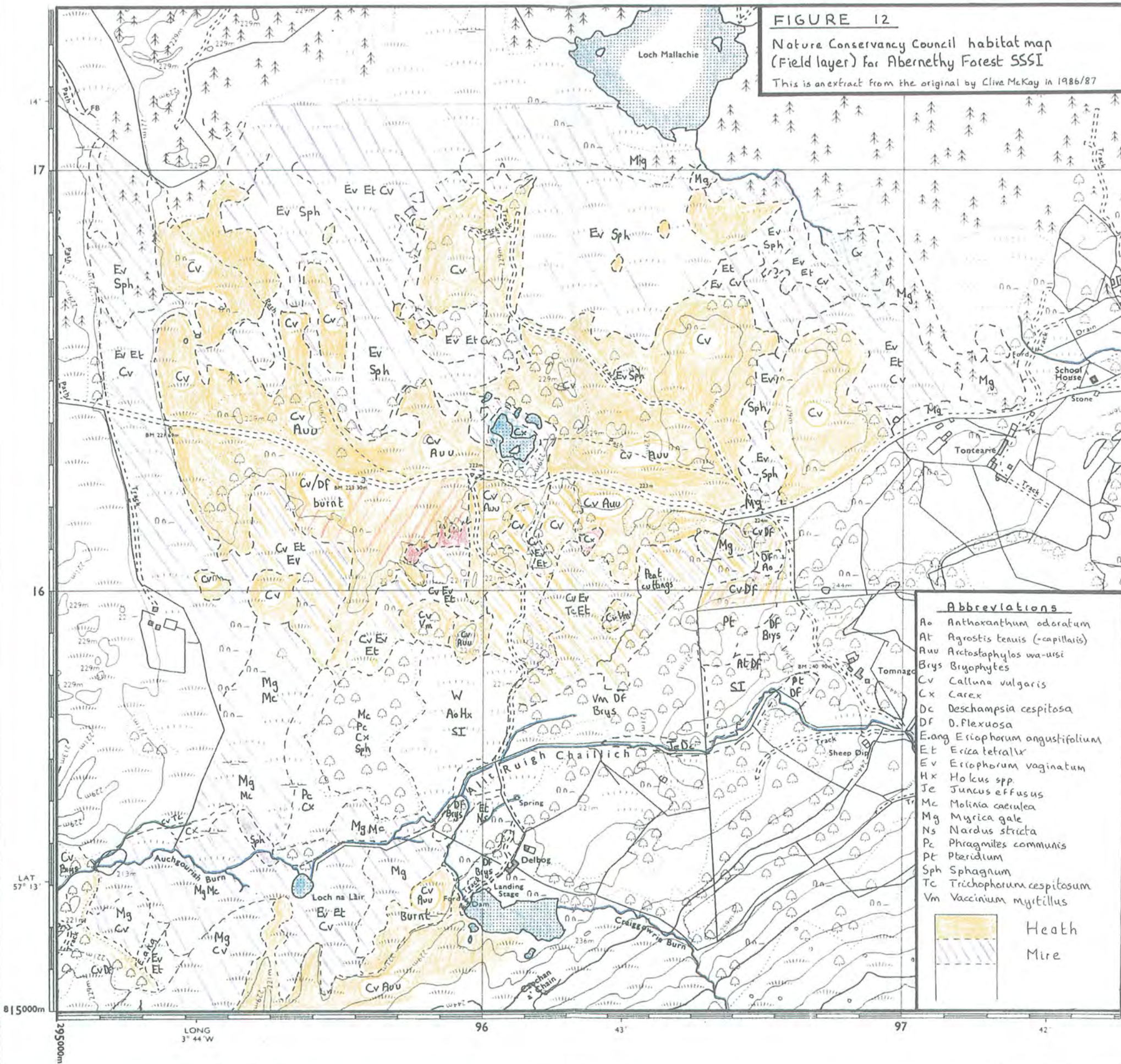

Abbreviations

Ao	Anthoxanthum odoratum
At	Agrostis tenuis (-capillaris)
Auu	Arctostaphylos wa-ursi
Bry	Bryophytes
Cv	Calluna vulgaris
Cx	Carex
Dc	Deschampsia cespitosa
Df	D. flexuosa
E.ang	Eriophorum angustifolium
Et	Erica tetralix
Ev	Eriophorum vaginatum
Hx	Holcus spp.
Je	Juncus effusus
Mc	Molinia caerulea
Mg	Myrica gale
Ns	Nardus stricta
Pe	Phragmites communis
Pt	Pteridium
Sph	Sphagnum
Tc	Trichophorum cespitosum
Vm	Vaccinium myrtillus



Heath  
Mire

1:50000

295000m

LONG 3° 44' W

96

43'

97

42'



← N

←

## PRESENT-DAY VEGETATION

### Aims

1. To establish a baseline for detecting vegetation change in the juniper heath - open heath transition area (see permanent plots on Figure 13) by means of permanent plots.
2. To improve on existing descriptions of this *Arctostaphylos* heath in terms of quantitative data i.e. relevés.
3. To explore and illustrate the variation in the heath, with particular attention to the area rich in juniper. In addition, to discover major vegetation gradients, and explain these where possible, eg. burning.
4. To use the relevés to compare the *Arctostaphylos* heath on Tulloch Moor with published relevés from other *Arctostaphylos* heaths.
5. To make species lists of plants
  - (a) on the heath
  - (b) on Tulloch Moor

### Methods and Materials

The fieldwork described below was carried out from 25th June to 3rd July, 1989.

#### Minimal Area

Prior to recording the permanent plots, an attempt was made to assess the minimal area of stand required to represent the species-rich heath vegetation, and where a 4x4m plot would lie on the resulting curve. This exercise was also used as practise in plant identification. A 'representative' area was chosen subjectively. The location is shown in Figure 13. This area contained all eight of the species listed as constant by McVean and Ratcliffe (1962) in their *Arctostaphylo-Callunetum*. A 1x1m square plot was marked out with canes and string, and the plant species occurring within it were listed. Keeping one corner of the plot as fixed, the area of the plot was increased by increments, and the new species listed for each new area, up to a maximum of 4x4m or 16m<sup>2</sup>.

Figure 13

Locations of permanent plots and relevés

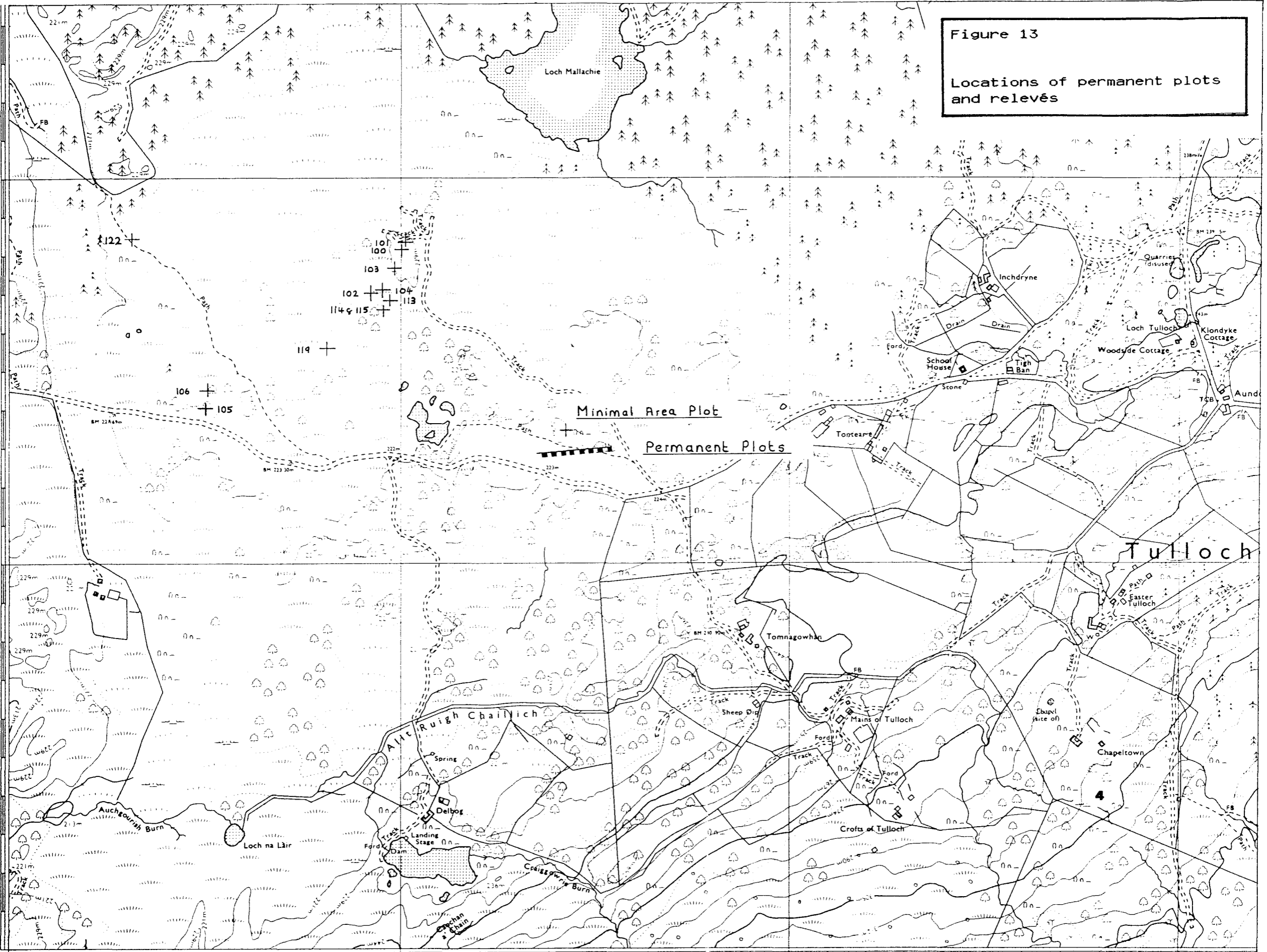

LAT 57° 13'

815000m

LONG 3° 44' W

96

43'

97

42'

98

## Permanent Plots

The 4x4m plots were marked out with corner posts by the RSPB before this project started. The plots lie in a straight line which is marked on Figure 13. I assigned numbers to the plots, in a sequence from 1 to 8, the first being at the eastern end. The plots were recorded in order from east to west over the period 28th June to 1st July, 1989. In each case the perimeter of the plot was marked out with string passing around the outside of each corner post. The plot was then divided using canes and string. The first two plots were divided into sixteen 1x1m squares or sub-plots, but recording these by this method proved to be too slow, and so numbers 3 to 8 were divided into four 2x2m squares. A plot divided in this way is shown in the photograph in Plate 2.

The visible plant species found in each sub-plot were listed. For each species in the sub-plot, the proportion of the plot covered by that species was recorded on the Domin scale. The scale used is given in Appendix 4. Initially a square 1x1m frame, with cross-wires which divide the area into 100 equal squares was used to help in determining the cover values, but after some experience this was discarded to save time. Domin scores from the sixteen 1x1m sub-plots in each of the first two 4x4m plots were converted to scores for four 2x2m sub-plots to make the data comparable with that for plots 3 to 8. The system for conversion is given in Appendix 7. Both sets of data are given in the results, so that future comparisons may be made on either basis.

Other data recorded for each plot were: slope, aspect, and drainage. The following data were also recorded for each sub-plot: % of ground covered by live vegetation, % of ground covered by dead vegetation, % of bare ground, and the vegetation height in the centre of the sub-plot. Photographs were taken of each plot. Photographic methods are described below.

## Photographic Methods

Four photographs were taken of each of the permanent plots, one from each corner. The camera was a 35mm Pentax ME Super with a lens of 50mm focal length. It was mounted on a tripod so that the camera was vertically above the top of the corner post, at about 90cm above the ground, and pointed so that the opposite corner post appeared at the top centre of the frame. The film used was Kodachrome 64, which makes colour transparencies. The pictures were taken over the middle period of a bright, sunny day. This was 2nd July, and the glare of reflected light from the vegetation is conspicuous in some of the photographs. Details of the point from which each picture was taken, together with some additional pictures are given in Appendix 2.

## Further Sampling of Vegetation

In order to explore the variation in heath vegetation outside the area of the permanent plots, seven further 2x2m plots were marked and recorded. In addition, one 2x2m plot was recorded in

woodland, and four 2x2m plots were recorded on the mire or peat bog. The locations of all twelve of these plots are shown on Figure 13.

#### Numbering of 2x2m plots

For the purposes of comparison, the 32 sub-plots within the permanent plots are numbered as follows:

Plot	1	2	3	4
Sub-plot	11,12,13,14	21,22,23,24	31,32,33,34	41,42,43,44
Plot	5	6	7	8
Sub-plot	51,52,53,54,	61,62,63,64	71,72,73,74	81,82,83,84

The 12 further 2x2m plots from which relevés were taken are numbered:

Heath	100,101,102,103,104,105,106
Bog	113,114,115,119
Woodland	122

(Relevé 104 was taken from a patch of grassland within the heath)

#### Choice of plots for further sampling

Each of the sites for plots 100 to 122 was chosen for particular reasons:

Plots 100 and 101, 105 and 106 were chosen to increase the geographic spread of samples. 105 and 106 were positioned on either side of a visible vegetation boundary. This boundary probably results from a difference in the time since burning, and is visible in the aerial photograph (Plate 1). Plot 102 was chosen to represent the heath vegetation near to the site from which peat was taken for pollen analysis, and to represent the rank heather growing there which was not represented in plots 100 or 101. Patches in which *Arctostaphylos* is dominant are conspicuous in amongst the otherwise dominant *Calluna*, and plot 103 was in one of these. Grassy hollows are frequent in the heathland area on Tulloch Moor. Plot 104 was in one such, but this patch was larger than most.

Plot 122 was in Pine-birch woodland which has grown up on the north-west side of the Moor, next to Garten Wood. Plots 113 to 115 are intended to represent the vegetation around the peat-sampling site. 113 was adjacent to the sampling site, but did not include any peat débris or detached vegetation. Plots 114 and 115 were 25m away to the south-west. The peat here

appeared to be uncut, and the bog surface was much drier and the vegetation was obviously different from other areas where there was clear evidence of peat cutting. Plot 119 was situated in an area believed to have been cut over, and where standing water was visible, or filled one's footsteps.

Several vegetation types which were observed on Tulloch Moor were not investigated. Some of these are indicated on the vegetation map in Figure 12.

### Plant Species List

All the plant species encountered on the heath were recorded, and additional species seen in other habitats on Tulloch Moor were also listed. All the species listed were found within the RSPB reserve.

### Plant identification

The following texts were used. Nomenclature is taken from those marked \*.

- \* Clapham et al. (1987)
- Daniels & Eddy (1985)
- \* Hill (1978)
- Hubbard (1954)
- Jermy et al.(1982)
- Jahns (1983)
- Macvicar (1926)
- Martin (1969)
- Ross-Craig (1948-1973)
- \* Smith (1978)
- Watson (1981)

## Results

### Minimal Area

The data are given in Appendix 3, and plotted in Figure 14. More than half of the final number of species were found when the plot was only 1m<sup>2</sup>. The number of species recorded rises steadily from 22 in 1m<sup>2</sup> to 32 in 6m<sup>2</sup> at which the slope changes abruptly, and the species total rises only another 3 to 35 by 16m<sup>2</sup>. These data indicate that if permanent plots were less than 6m<sup>2</sup>, then a slight change in the distribution of plants within a plot would cause some new species to appear, and some others to disappear, but at 16m<sup>2</sup> this effect will be small, and changes in the vegetation within a plot are likely to represent changes in the surrounding vegetation.

### Permanent Plots

The data for plots 1 and 2, which were divided into sixteen 1x1m sub-plots, are given in Appendices 5 and 6. The vegetation is dominated by *Calluna* and *Arctostaphylos uva-ursi* is present in all but one of the sub-plots, but Juniper is also a major component of the vegetation. *Pyrola media* is absent from both plots. *Erica cinerea* is absent from plot 2, and it occurs in only 2 sub-plots of plot 1.

The data for the eight 4x4m permanent plots, recorded as 2x2m sub-plots, are given in Appendix 8. The converted Domin scores from plots 1 and 2 are included.

*Calluna* is dominant in all the plots except number 8 which lies in a patch that was burnt in 1987, and still included bare ground in 1989.

*Arctostaphylos uva-ursi* occurs in all the sub-plots, the cover varied relatively little, and unlike *Calluna*, it was not less abundant in plot 8.

<i>Arctostaphylos</i> Domin score	3	4	5	6
Number of sub-plots	3	14	13	2

*Arctostaphylos* and *Calluna* Domin scores in each sub-plot are shown in Figure 15.

Juniper occurs in all the plots except 8, but it is notably less abundant in plots 5 to 7, i.e. the western part of the transect. See Figure 16, and compare the photographs in Plates 2 and 3.

The constancy of *Vaccinium vitis-idaea*, while the other vegetation changes, is striking. The scores of the minor dwarf-shrubs (*V. vitis-idaea*, *V. myrtillus*, *Empetrum nigrum*, *Erica cinerea* and *Genista anglica*) are compared in the histogram in Figure 17.

Figure 14  
Determination of minimal area

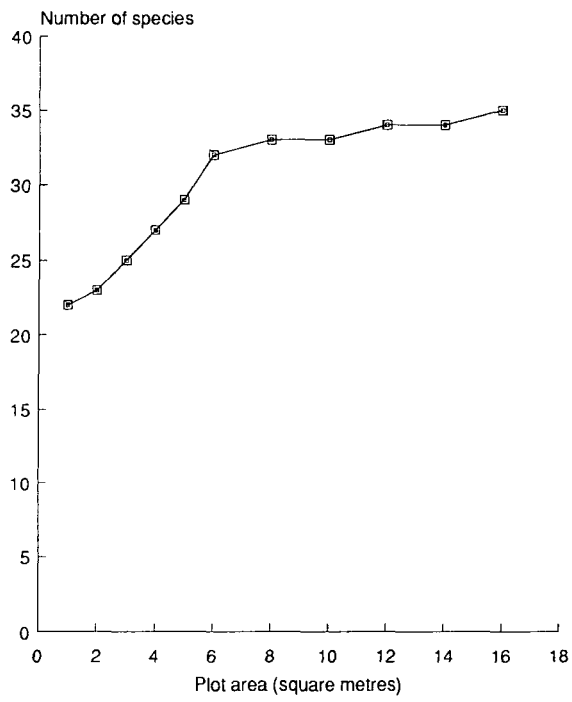

**Plate 2**

**The transect from plot 3 eastwards**

**Plot 3 is divided into four 2x2m sub-plots with canes and string**

**Plate 3**

**The transect from plot 4 westwards**

**Plot 8 lies in the yellow grassy area in the mid-distance**



Figure 15

*Calluna + Arctostaphylos*  
cover in 2x2m sub-plots in transect

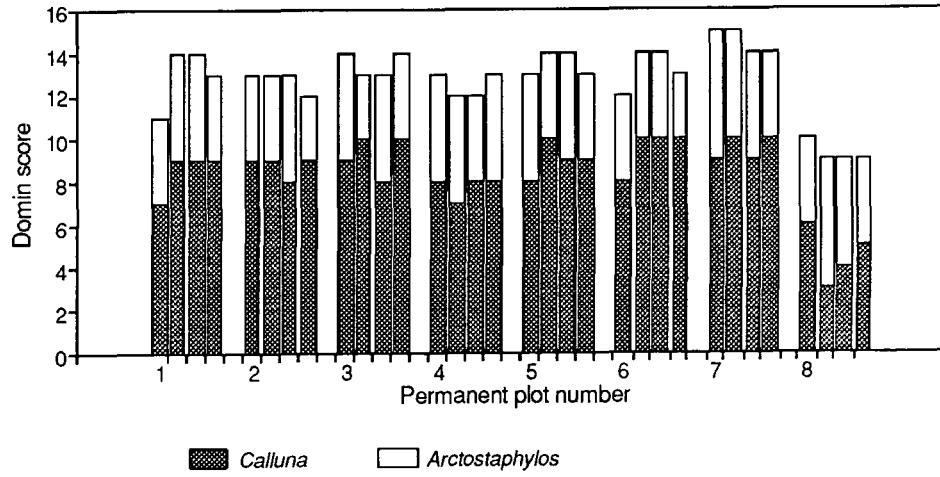

Figure 16

Juniper  
cover in 2x2m sub-plots in transect

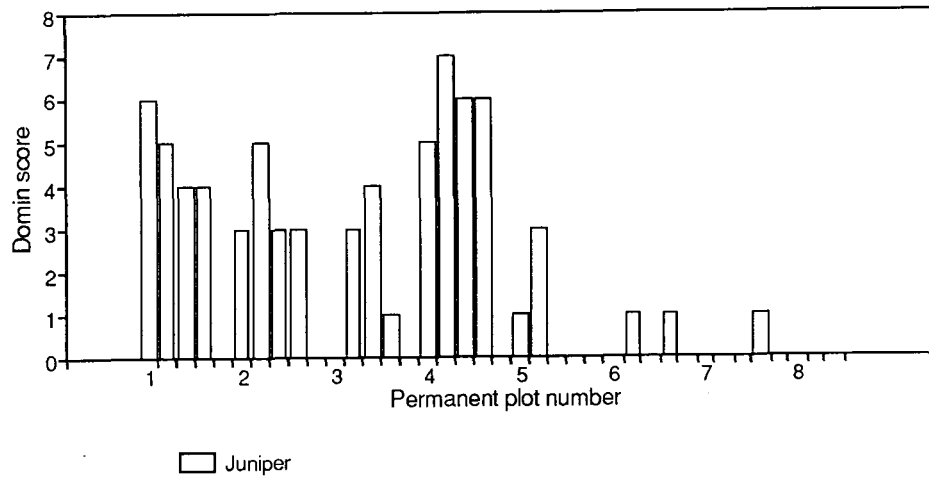

Figure 17

Cover of minor dwarf shrubs  
in 2x2m sub-plots in transect

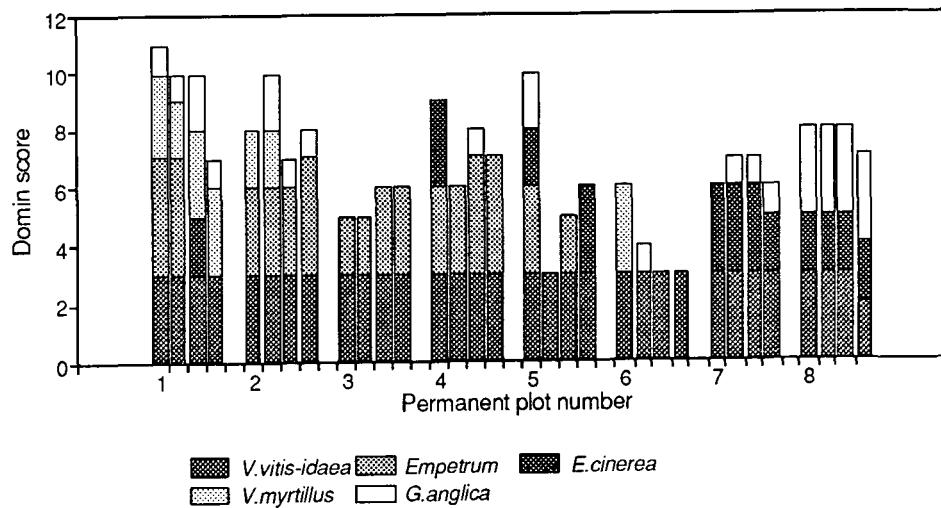

Figure 18 Sum of Domin scores of grasses in 2x2m sub-plots in transect

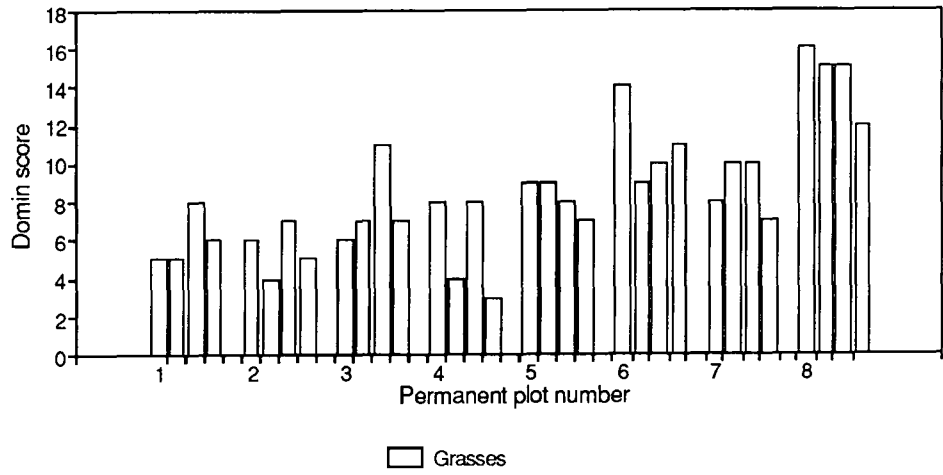

Figure 19 Sum of Domin scores of mosses in 2x2m sub-plots in transect

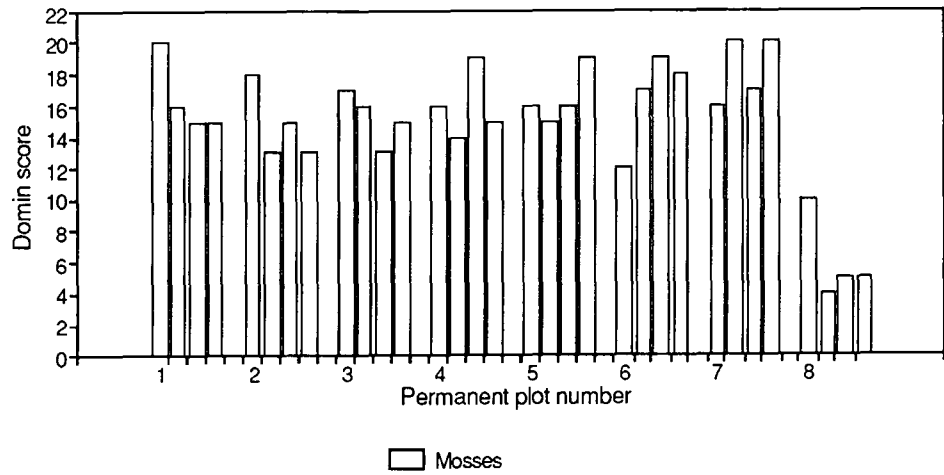
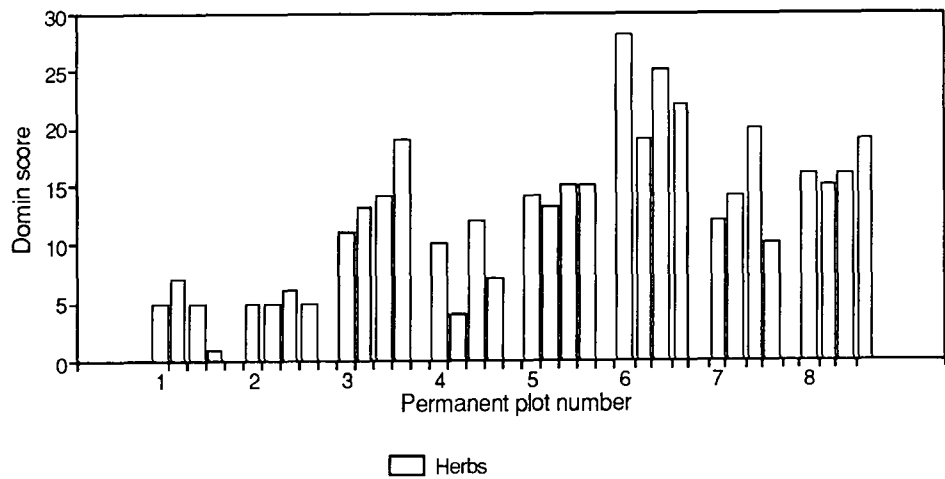

Figure 20 Sum of Domin scores of herbs in 2x2m sub-plots in transect



Plot 8 is dominated by grasses, particularly *Anthoxanthum odoratum* and *Festuca ovina* and the grasses cause the burnt area to show up as a pale yellowish patch on the photograph in Plate 3. Whereas juniper decreases toward the western part of the transect, the grasses appear to increase. In Figure 18 the sum of the Domin scores is used as a crude measure of the abundance of grasses in each 2x2m sub-plot.

Moss cover is much lower in plot 8 than in the rest of the transect. The sum of Domin scores of mosses is plotted in Figure 19. The Hypnaceous mosses such as *Hylocomium splendens*, *Pleurozium shreberi*, *Hypnum cupressiforme* and *Rhytidiadelphus* spp. are present in all the 2x2m sub-plots except those in plot 8 where *Polytrichum juniperinum* and the unidentified, soil encrusting acrocarpous moss appear to have colonized the bare ground after burning.

Herb cover varies much between the plots. The sum of Domin scores varies from 1 in sub-plot 11 to 28 in sub-plot 61. In the histogram in Figure 20 there appears to be an increase from east to west, but within this pattern, some plots are richer in herbs (plots 3 and 6) than others. A histogram of the number of species of herbs reveals an almost identical pattern.

Of McVean & Ratcliffe's constants, *Pyrola media* is absent and *Erica cinerea* is absent from 3 of the 8 plots.

#### Further Vegetation Sampling

Data for relevés 100 to 122 are given in Appendix 9. Four new species were encountered in the heath relevés (numbers 100 to 106). These are *Sorbus aucuparia*, *Nardus stricta*, *Poa pratensis* and *Trientalis europaea*, although the two grasses only occurred in the grassland plot (number 104). Plots 100 and 106 contained fewer species (12 and 15 respectively) than any of the 2x2m sub-plots in the transect (17 to 30 species). Neither of plots 101 nor 105 are as species-poor (24 and 20 species) as their respective neighbours 100 and 106. Plot 102 was chosen to represent rank heather and the mean vegetation height was 33cm and there was 7% cover with dead vegetation, as compared with 18cm and 5% for plot 100, however, the figures for plot 106 are 46cm and 10%. Both of plots 102 and 106 are similarly species-poor with 17 and 15 species respectively. Plot 105 which was near 106, but in a stand of heather which appeared to have been burnt more recently than the latter, contained shorter vegetation (mean 39cm), less dead vegetation (3%) and, as already mentioned, more species. Plot 103 was chosen for its high cover of *Arctostaphylos*, and it had a Domin score of 8, which is higher than in any other plot. In general, the 2x2m heathland relevés outwith the permanent plots have extended the variation much as intended.

## Plant Species List

The list is in Appendix 10. Including lichens, 110 species were recorded on Tulloch Moor, all of which were found within the RSPB reserve. Of the 110 species, 68 were found on the heath, but to this could be added 4 species which were recorded in the grassy patches in the heathland, i.e. *Nardus stricta*, *Poa pratensis*, *Ranunculus repens*, and *Plagiomnium undulatum*. It must be emphasised that the recording of species within habitats is far from complete, for example, several species such as *Thymus praecox* and *Euphrasia* sp. probably occur in the grassy patches, as well as on waysides, but were not recorded there. Notable species are *Pyrola media* and *Listera cordata*.

Species listed by the NCC (1986) as local and which have declined through afforestation are:

<i>Lycopodium clavatum</i>	<i>Pyrola media</i>
<i>Juniperus communis</i>	<i>Trientalis europaea</i>
<i>Helianthemum nummularium</i>	<i>Antennaria dioica</i>
<i>Genista anglica</i>	<i>Listera cordata</i>
<i>Arctostaphylos uva-ursi</i>	<i>Gymnadenia conopsea</i> .

## Analysis and Discussion

### Ordination

Multivariate data analysis offers the opportunity to analyse an entire set of vegetation data simultaneously. Ordination methods are helpful in showing relationships between samples and between species. Detrended Correspondence Analysis (Decorana) is a popular ordination method available as a Fortran computer program. The program will order the species and samples in such a way as to display the maximum amount of variation among them. This is axis 1. For each species a score is computed which indicates the position of the species along the scale on axis 1. These scores are then used to compute the position of each sample along axis 1. The process is repeated for the order which gives the second greatest amount of variation. This is axis 2. In Decorana, Axis 2 is not correlated with axis 1. The process is repeated again for axes 3 and 4.

In addition to showing relationships between samples and between species the method can be used to compare the amount of variation on the different axes by a statistic called the eigenvalue. Ordination was used:

- (1) to show variation in the vegetation on Tulloch Moor and to indicate the likely environmental causes of that variation

- (2) to compare vegetation on Tulloch Moor with that on other *Calluna-Arctostaphylos* heaths.

### Permanent Plots

The 32 sub-plots in the transect were analysed by Decorana as 32 separate samples. The resulting eigenvalues were:

axis 1 0.251

axis 2 0.078

axis 3 0.046

axis 4 0.029

The first eigenvalue is more than 3 times as large as the second. This means that much more of the variation in the vegetation is represented in the first axis, than in the second and subsequent axes. If less weight is given to those species which occur less often in the sample (the downweighting option), the difference between the first and second eigenvalues is increased.

### Axis 1: principal sources of variation

Ordination of the samples on axes 1 and 2 is shown in Figure 21 and the species in Figures 22 and 23. In Figure 21 the separation of the samples in the burnt plot (81 to 84) from the rest is conspicuous, and appears to dominate the variation on axis 1. In Figure 22, those species which occur exclusively in plot 8, i.e. *Antennaria dioica*, *Polytrichum juniperinum*, and the unidentified acrocarpous moss, are all placed at the end on axis 1. *Lotus corniculatus* and *Polygala serpyllifolia* which are rare except in plot 8 are next on axis 1. At the other end of axis 1, we find three of the four lichens and the 'trees' i.e. juniper and the two birches. At a smaller scale, of the samples in plot 8, 81 is nearer the main body of samples than 82, 83 and 84. Sample 81 included small amounts of Hypnaceous mosses i.e. *Hypnum cupressiforme*, *Hylocomium splendens* and *Rhytidiadelphus triquetrus* which are largely absent from this burnt area, including from samples 82 to 84.

The Domin score of juniper and the sum of Domin scores of lichens, of grasses, and of herbs are plotted in place of their respective samples on axes 1 and 2 in Figures 24 to 27. Even if samples 81 to 84 are not considered, the juniper and lichen scores tend to be higher to the left on axis 1, and the grass and herb scores tend to be higher to

Figure 22

Decorana: 2x2m sub-plots Axes 1x2  
Species

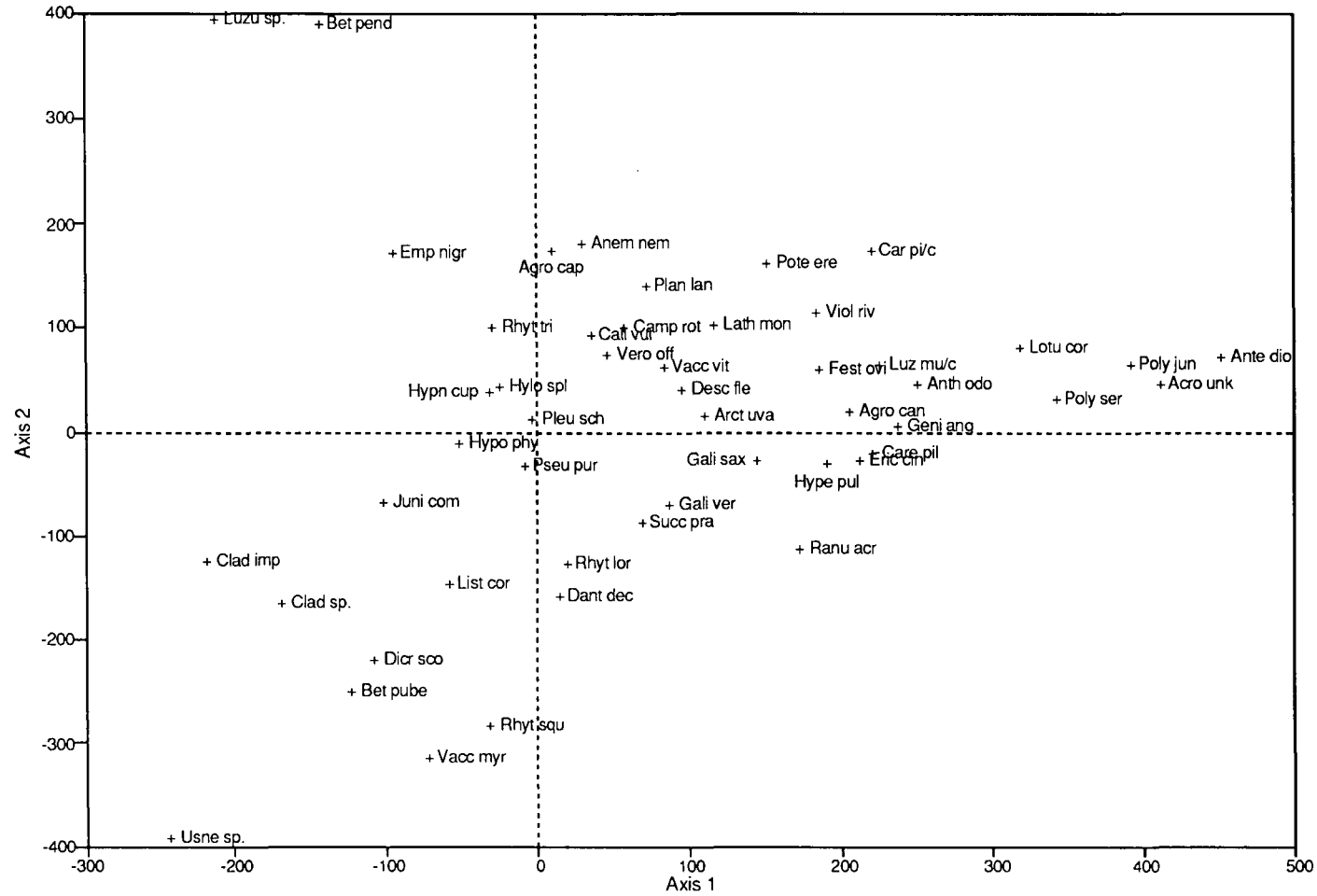

Highest and lowest Axis 2 scores reduced for display

Figure 21 Decorana: 2x2m sub-plots Axes 1x2 samples plotted as sample number

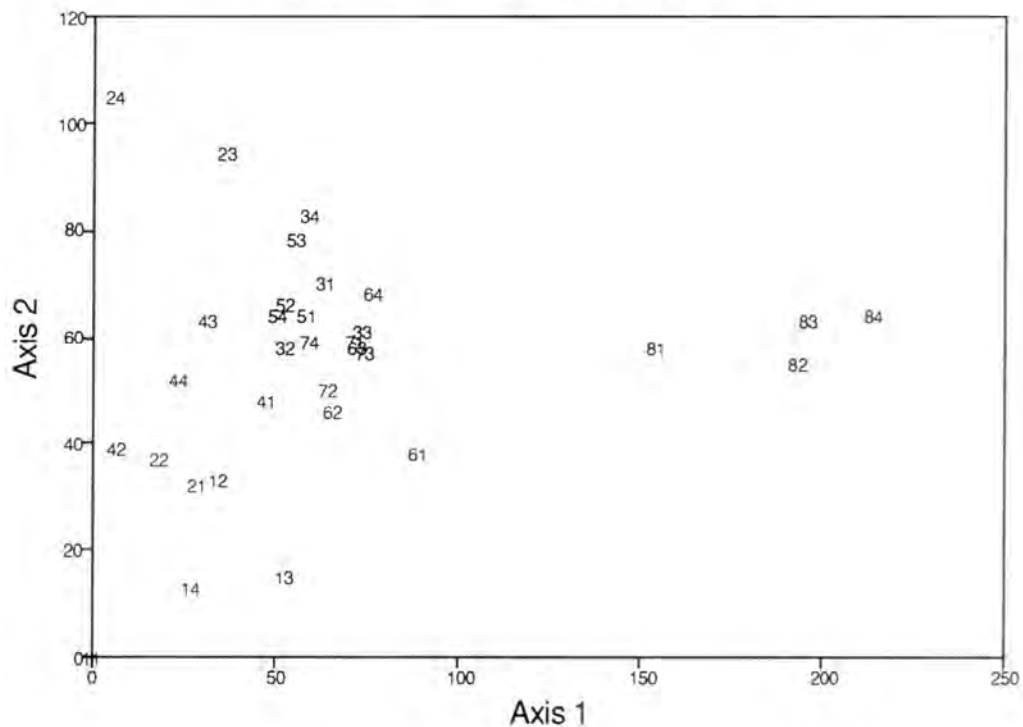

Figure 23 Decorana: 2x2m sub-plots Axes 1x2 species (plant types plotted as symbol)

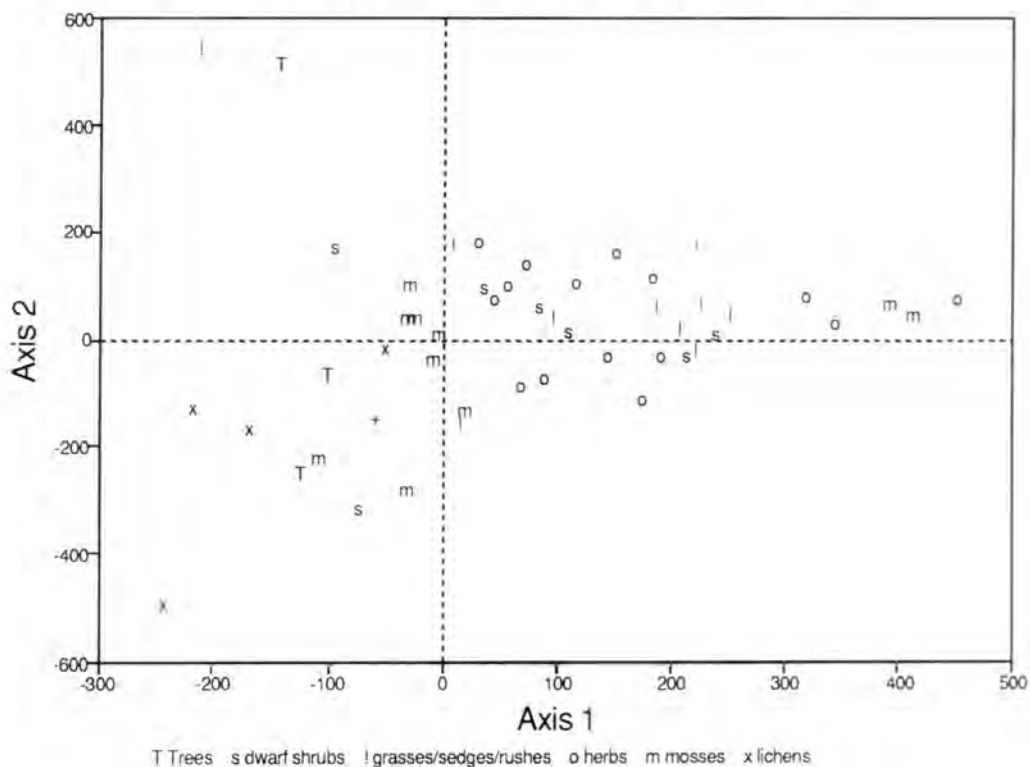

Figure 24

Decorana: 2x2m sub-plots Axes 1x2  
samples plotted as Juniper Domin score

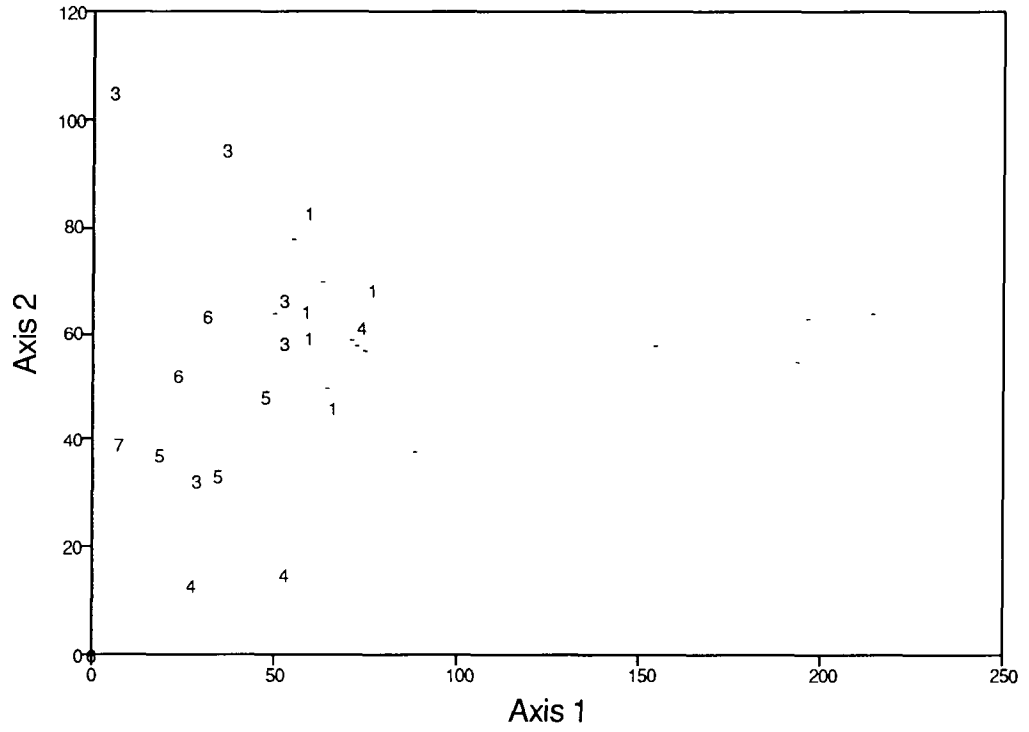

Figure 25

Decorana: 2x2m sub-plots Axes 1x2  
samples plotted as sum of Lichen scores

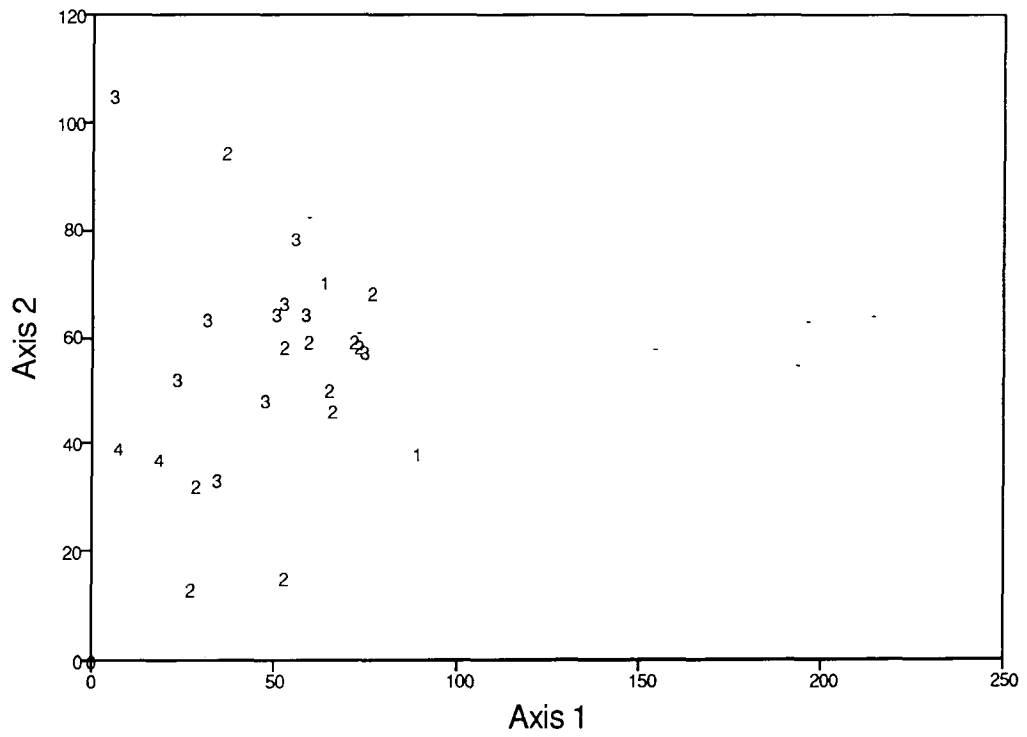

Figure 26

Decorana: 2x2m sub-plots Axes 1x2  
 samples plotted as sum of grasses score

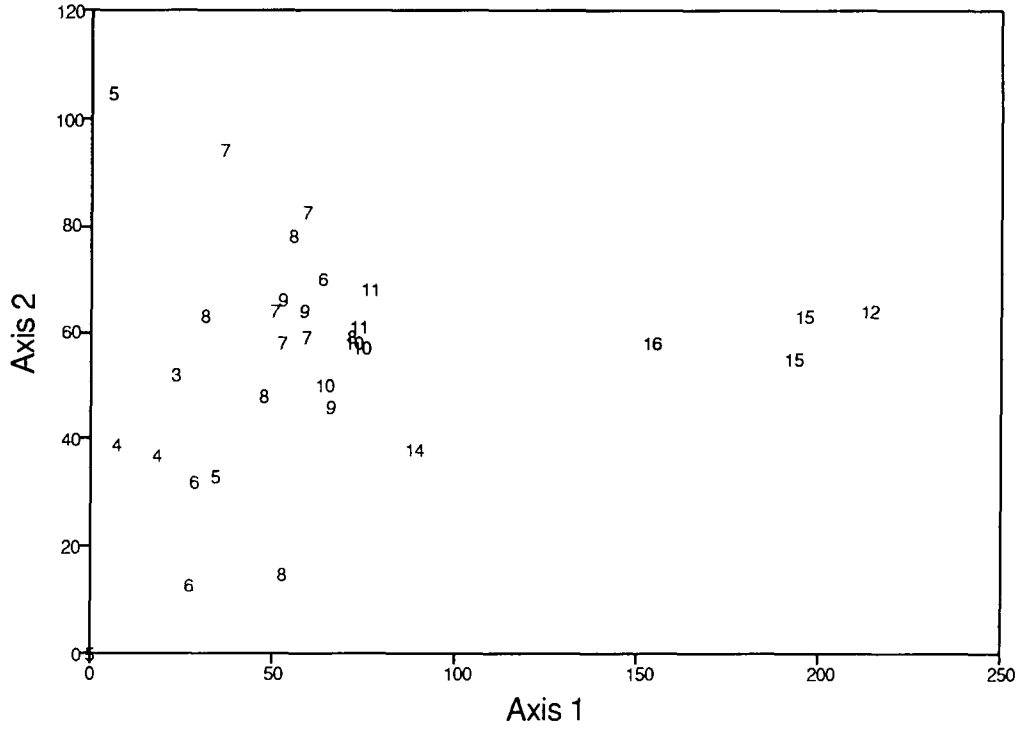
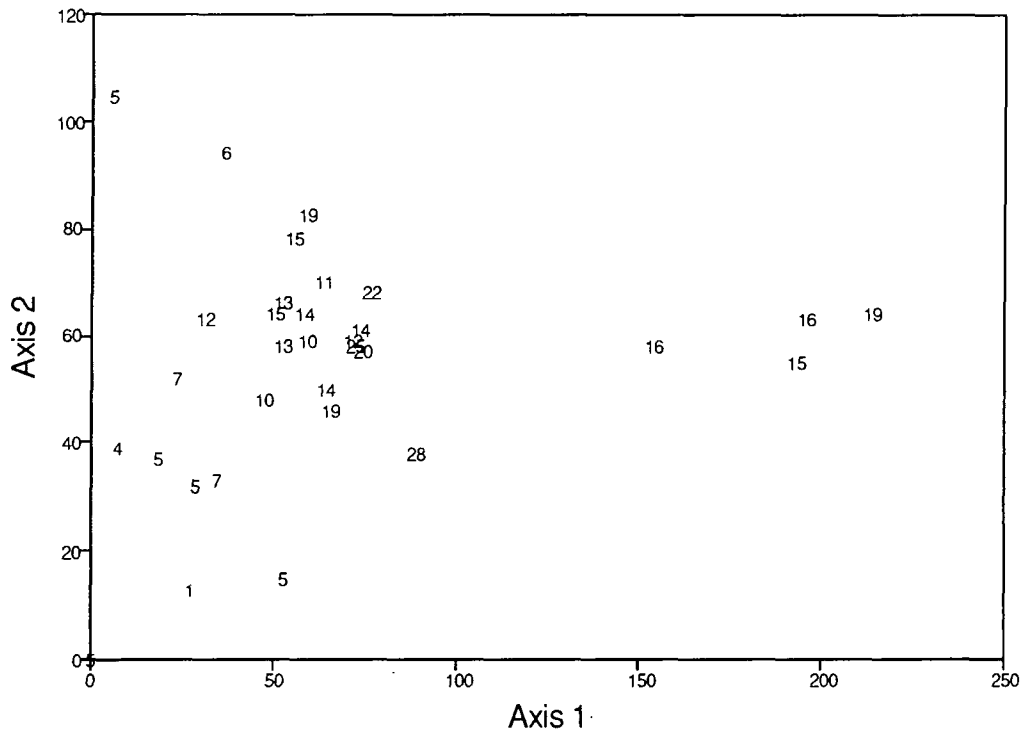

Figure 27

Decorana: 2x2m sub-plots Axes 1x2  
 samples plotted as sum of herb scores



the right. If the Decorana is rerun omitting samples 81 to 84, similar trends appear. In other words the major variation in the vegetation as revealed by axis 1 is much as already perceived in the histograms above.

Juniper and young birch are easily killed by burning, whereas on a suitable substrate, grasses are encouraged. If hypnaceous mosses are not killed by burning itself, the removal of shade from direct sunlight and shelter from wind and desiccation is likely to kill them. The differences in species and samples along axis 1 seems to be at least partly explained by a gradient of time since burning. Despite the presence of sheep and roe deer, juniper and birch appear to be spreading from the south and east along the transect (see photographs), and this process of colonisation seems also to be reflected in axis 1. Variation in grazing may also be an important factor, for example deer and sheep may be attracted by the herbs and grasses in plots 3 and 6, and so there may be more browsing of juniper and birch seedlings in these plots.

#### Axis 2: subsidiary variation

Attempts to explain variation on axis 2 have not yielded any clear result, at least with this data set from the 32 2x2m sub-plots. Removal of samples 81 to 84 from the analysis caused the order of samples and species on axis 2 to change completely, and downweighting of rare species caused changes to the scale and to the order on axis 2, while axis 1 remained largely stable. Given that axes 3 and 4 each contain successively less variation than axis 2, they are not considered here.

#### Further Vegetation Sampling

Decorana was used again to examine the relationships between the relevés 100 to 122 and those from the permanent plots, i.e. 11 to 84.

Heath and woodland relevés.

Samples 100 to 106 and 122, together with 11 to 84 were analysed and the ordination of samples on axes 1 and 2 are plotted in Figure 28. Axis 1 is almost unchanged from the first ordination of samples 11 to 84, whereas axis 2 looks different, and the scale now covers a wider range. The eigenvalue of axis 2 is now closer to that of axis 1 than before, viz.:

Samples:	11-81,100-106,122	11-81
axis 1	0.242	0.251
axis 2	0.99	0.078
axis 3	0.047	0.046
axis 4	0.042	0.029

The additional relevés have increased the amount of variation, but by relatively little.

Figure 28

Decorana: Heath & woodland relevés samples plotted as sample number

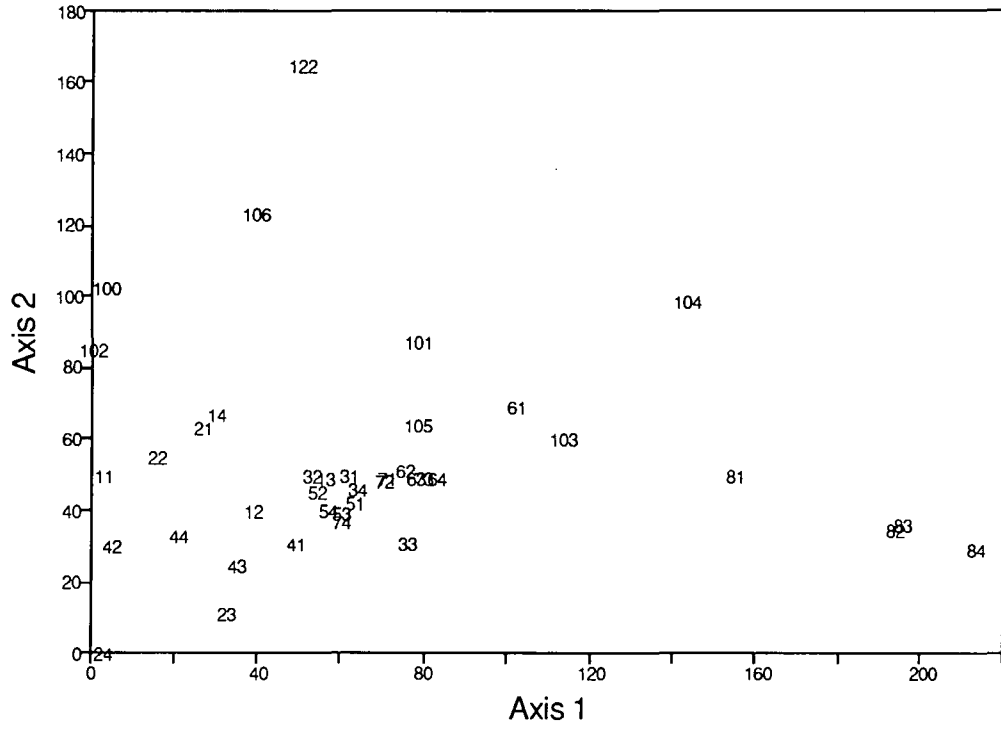
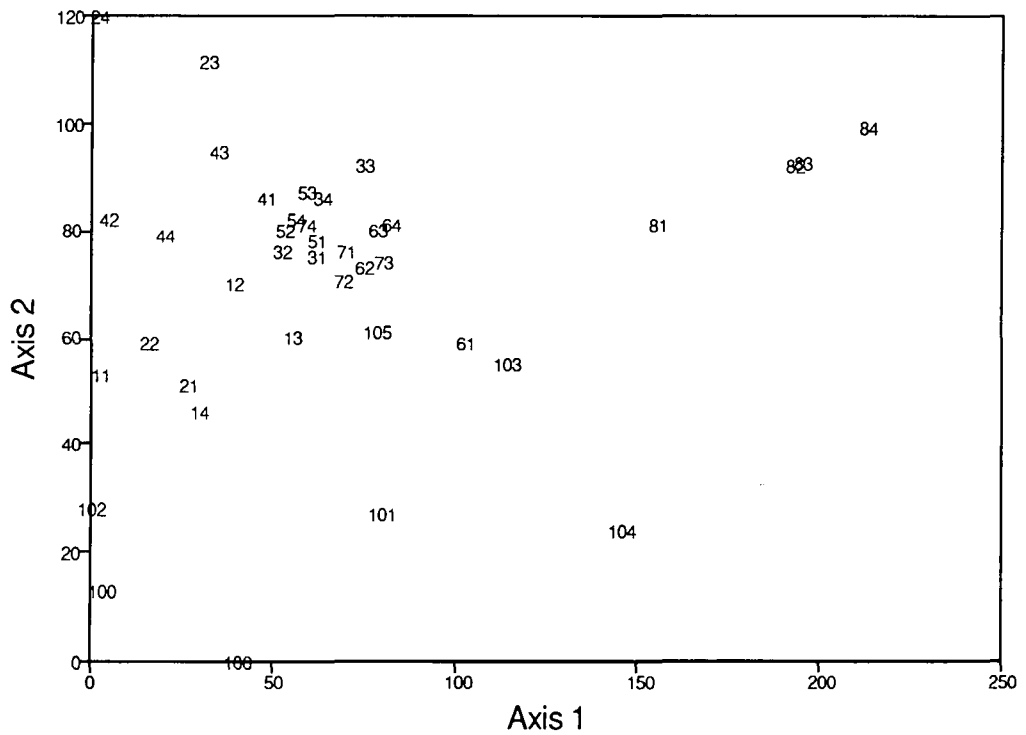

Figure 29

Decorana: heath relevés Axes 1x2  
Samples shown as sample number



In the plot in Figure 28 the woodland relevé, sample 122, forms the extreme end of axis 2 and lies outside the main body of samples. This sample contains only 10 species and is like an impoverished heathland sample with the addition of *Trientalis europaea*. The trees in this woodland are relatively young, and if they have colonised former heathland on this site, then an impoverished heathland flora may be expected.

#### Heathland relevés

The Decorana above was rerun omitting the woodland relevé, sample 122. The eigenvalues were:

axis 1 0.242

axis 2 0.083

axis 3 0.047

axis 4 0.037

Axis 2 is now about one third as large as axis 1, and so the additional relevés on the heathland, samples 100 to 106 have contributed very little to the extent of variation already present in the sub-plots 11 to 84. The ordination of samples on axes 1 and 2 are plotted on Figure 29. Although axis 2 is inverted with respect to Figure 28, the overall distribution of the samples is very similar.

#### Time since burning

In the analysis of the sub-plots 11 to 84 above, if axis 1 is related to time since burning, then the same is almost certainly true in this analysis. If so, it is notable that plot 102 which was chosen to represent rank, and by implication, old, heather, lies at the far left side of axis 1, i.e. at the opposite end from the burnt plot. If rare species are downweighted, sample 102 is still very close to the left side of axis 1. As mentioned above, sample 106 contained higher vegetation, and more dead vegetation than 102, but floristically it is more similar to the other samples, at least on axis 1. Evidence from the aerial photograph indicated that sample 105 was burnt more recently than 106, and so we would expect 105 to be plotted to the right of the latter, which it is.

#### Soil

Plot 100 did not appear to contain especially old or rank heather, but it was notably species-poor (12 species), especially in grasses, sedges & rushes, and herbs, nearly all of which plot to the right on axis 1. This sample contains more *Vaccinium myrtillus* than any other, and this species is listed by McVean & Ratcliffe (1962) among those which are relatively indifferent to soil base status, but preferring the oligotrophic end of the spectrum.

Figure 30 Decorana: heath releves (downweighting)  
Soil indicator species

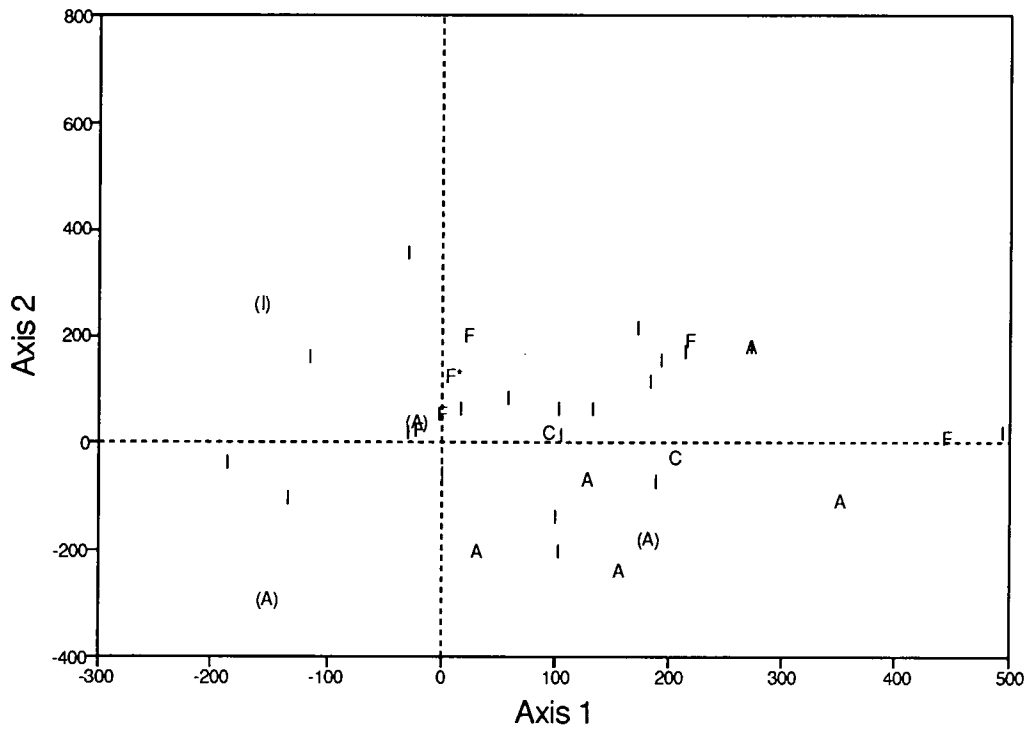

Soil indicators as described by McVean & Ratcliffe (1962)  
C Calcicole, A Avoid worst soil, I Indifferent, F calcifuge

Highest and lowest axis 2 scores reduced for display

Figure 31 Decorana: heath releves (downweighting)  
Species preferring mineral soils

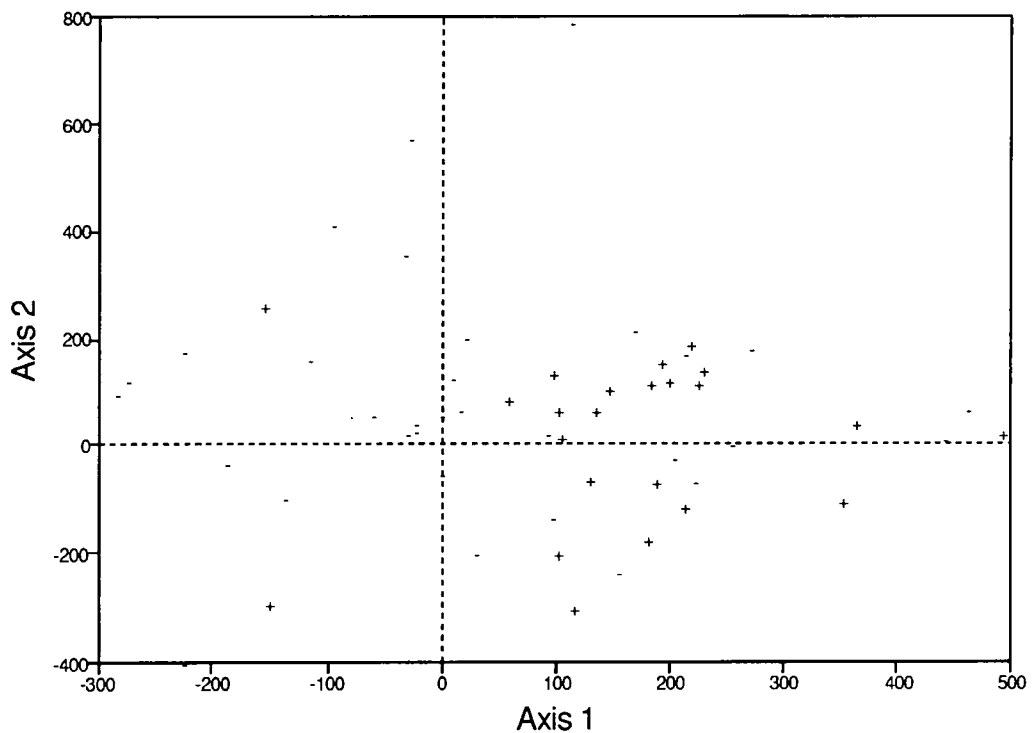

Mineral soil indicators as listed by Ward (1970)

Highest and lowest axis 2 scores reduced for display

There is no *a priori* reason to suppose that plots 101 and 104 have been burnt more recently than 100, and yet they appear well to the right. This situation is not affected by downweighting the less frequent species. Both samples are richer in sedges & rushes, and in herbs than sample 100, and sample 104 which lacks *Calluna* is especially rich in grasses. None of samples 100, 101, nor 104 contain any tree species, and so it seems likely that the vegetation within these plots, and hence their axis 1 score, is responding strongly to some other factor beside time since burning or tree colonisation. Soil conditions would seem to be a likely candidate. Figure 30 is a plot of the species on axes 1 and 2, but the species names have been replaced by the class of soil indicator species used by McVean and Ratcliffe (1962). The species do not fall into any clear pattern on this basis. Ward (1970) explains the distribution of herbs in his samples at Muir of Dinnet in terms of the distribution of mineral versus organic soils, and he lists the plant species in his samples which display a preference for mineral soils:

<i>Agrostis canina</i>	<i>Hypericum pulchrum</i>
<i>Agrostis capillaris</i>	<i>Lathyrus montanus</i>
<i>Antennaria dioica</i>	<i>Lotus corniculatus</i>
<i>Campanula rotundifolia</i>	<i>Polygala serpyllifolia</i>
<i>Carex pilulifera</i>	<i>Potentilla erecta</i>
<i>Deschampsia flexuosa</i>	<i>Pyrola media</i>
<i>Erica cinerea</i>	<i>Danthonia decumbens</i>
<i>Festuca ovina</i>	<i>Vaccinium vitis-idaea</i>
<i>Galium saxatile</i>	<i>Veronica</i> spp.
<i>Genista anglica</i>	<i>Viola riviniana</i>

Those occurring in the heath relevés on Tulloch Moor are marked on the plot in Figure 31. There is a very clear trend to the right on axis 1. The major environmental gradients which seem to be affecting the vegetation are:

- Time since burning
- Tree colonisation
- Organic vs mineral content of soil

#### Patterns of distribution

Different patterns of distribution of species other than those such as juniper which have already been described, are compared on the ordination plots as listed below. Figure 33 shows the ordination of the heathland relevés with downweighting of rarer species (DWRS) on axes 1 and 2, and Figure 32 shows the ordination of species in the same analysis.

#### Figure 34 Number of species of herbs

Numbers tend to be higher to the right on axis 1, but also to the bottom on axis 2.

#### Figure 35 Domin score of *Hypericum pulchrum*

The higher scores are to the right and to the bottom of the plot.

Figure 32

Decorana: heath releves - Axes 1 x 2  
Species (rare species downweighted)

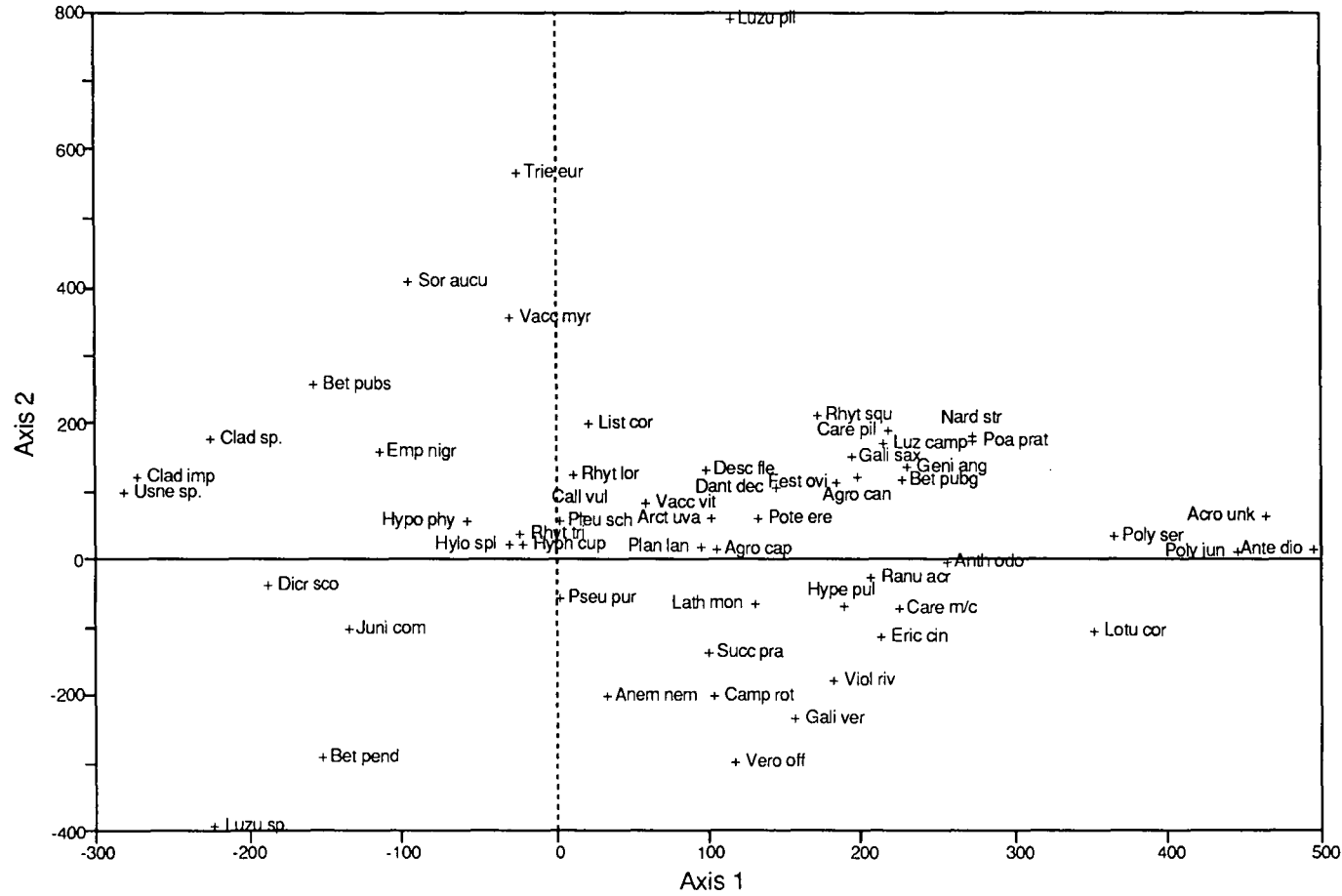
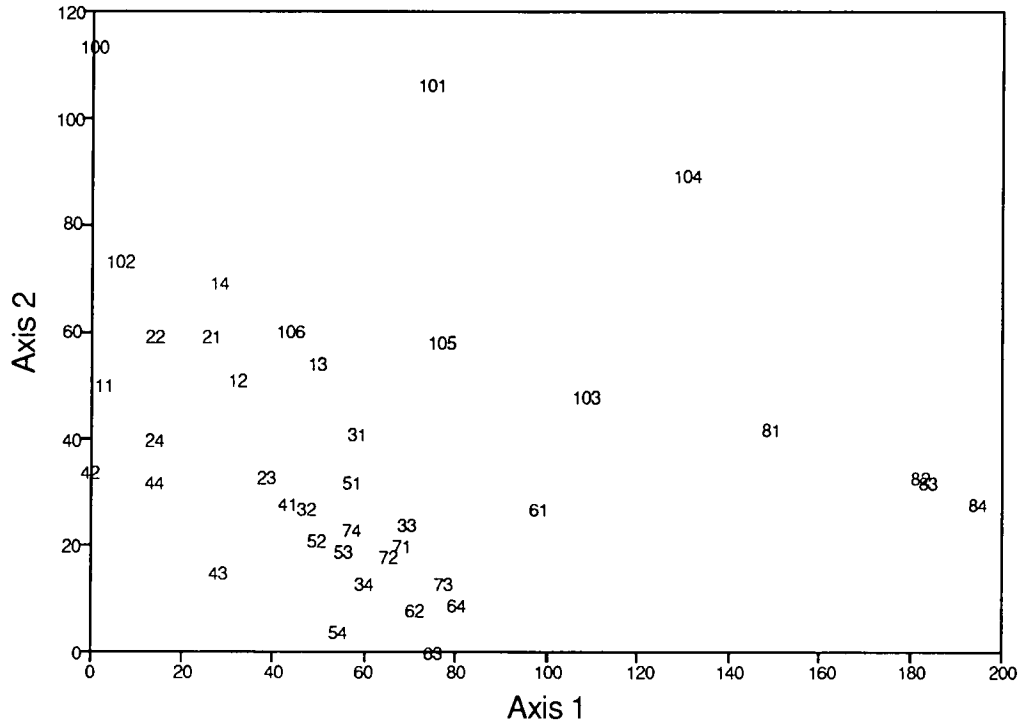

Figure 33

Decorana: heath releves (downweighting)  
 Samples plotted as sample number



(downweighting) indicates downweighting of rare species

Figure 34

Decorana: heath releves (downweighting)  
 Samples plotted as no. of herb species

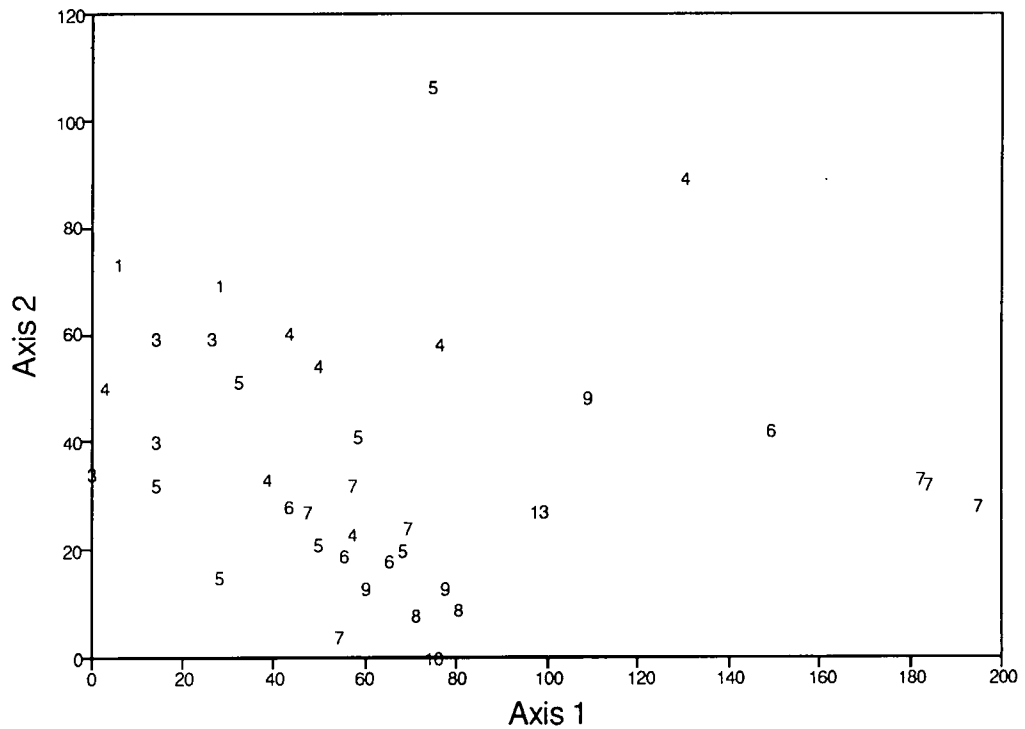

Figures 35 - 39 Decorana: heath releves, with downweighting of rare species  
 Samples are plotted as the Domin score of the species given

Figure 35

*Hypericum pulchrum*

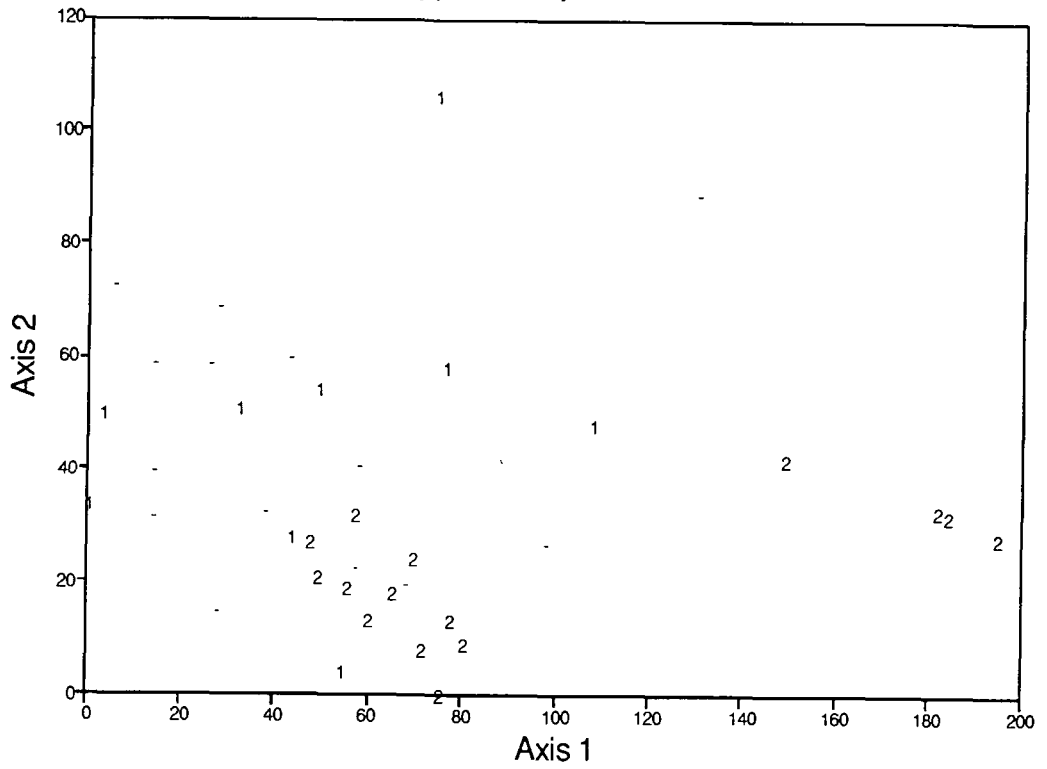

Figure 36

*Viola riviniana*

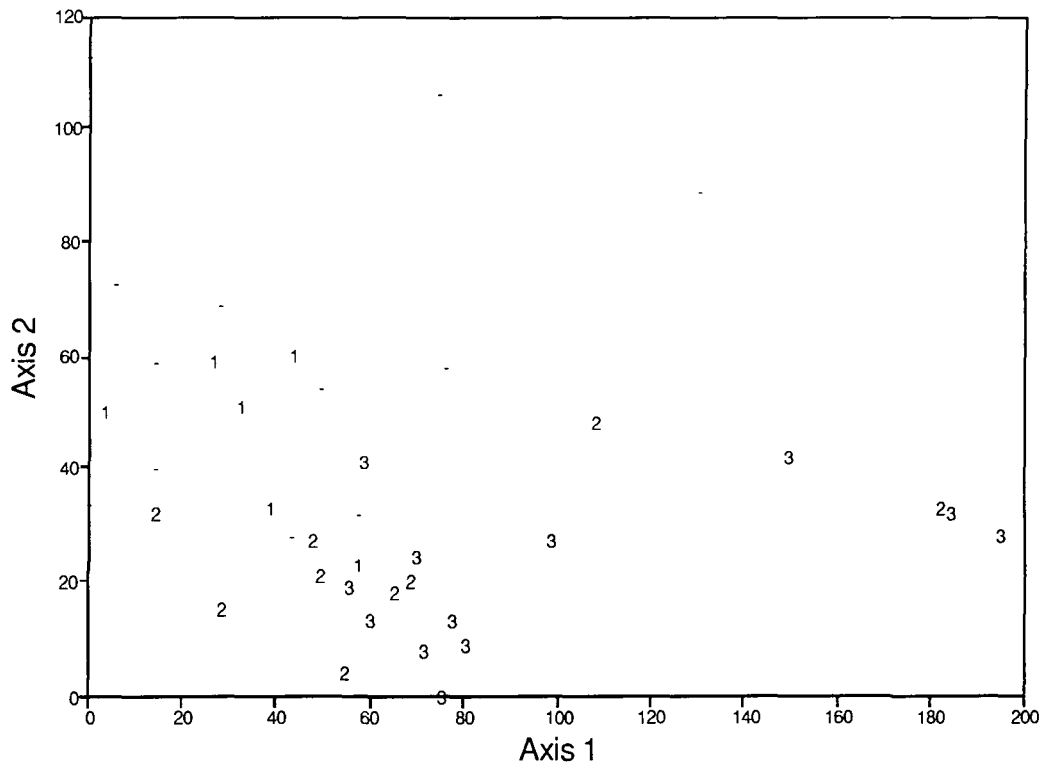

Figure 37

*Anemone nemorosa*

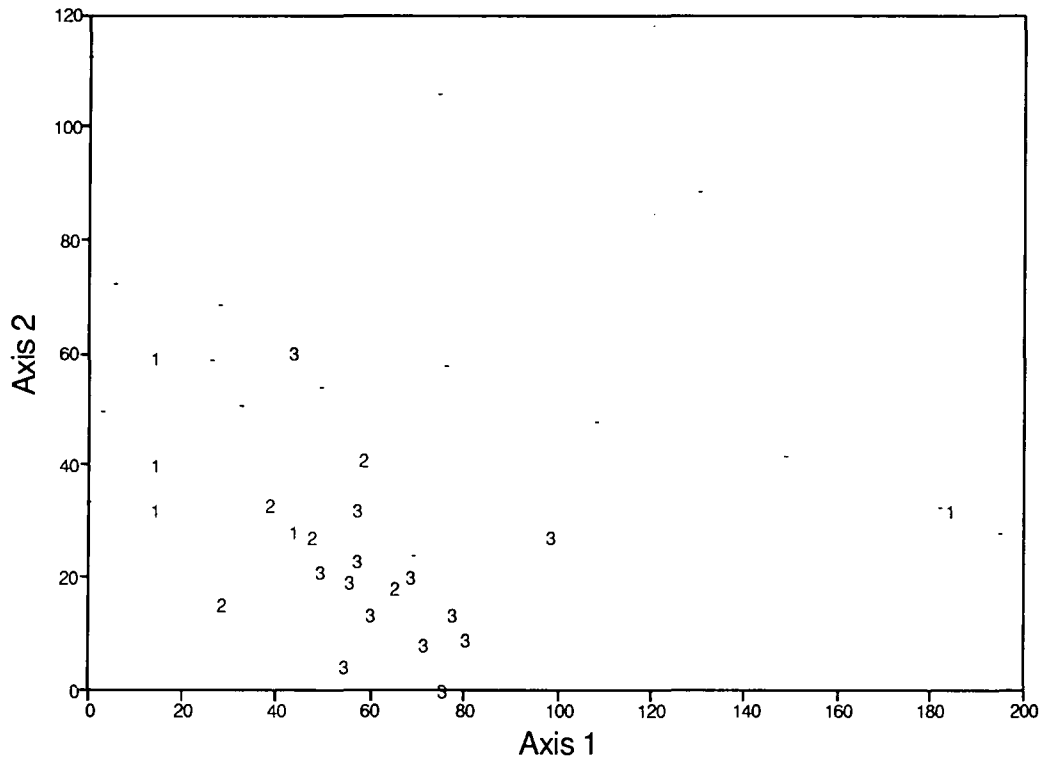

Figure 38

*Vaccinium myrtillus*

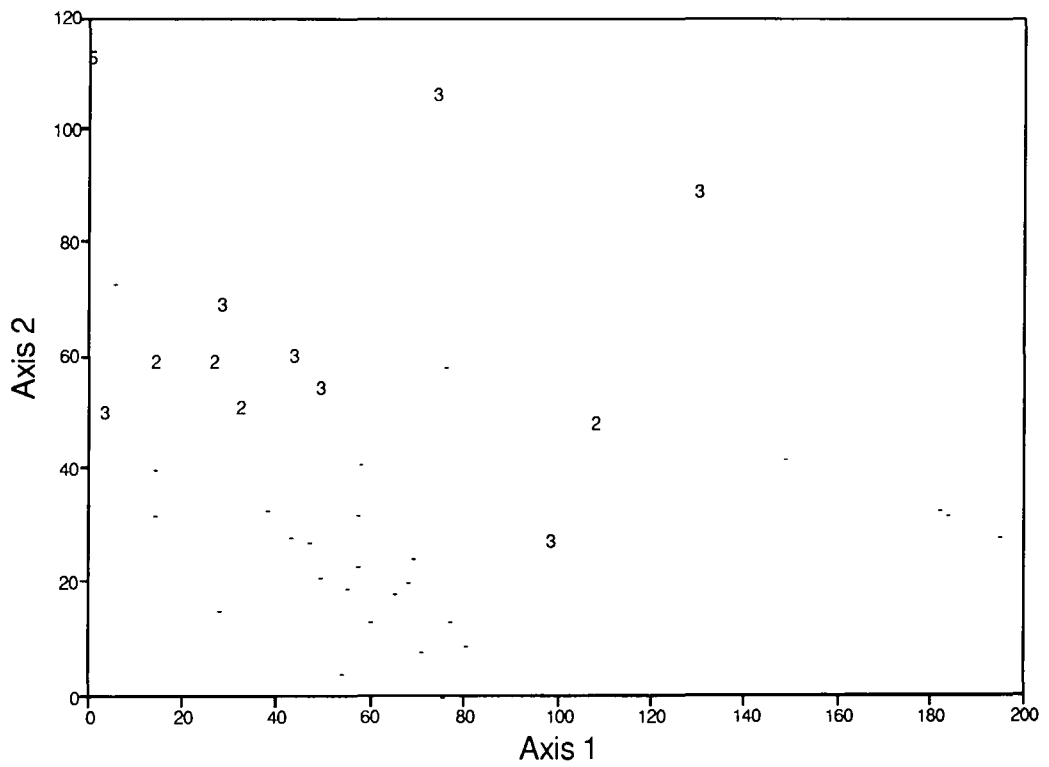

Figure 39

*Erica cinerea*

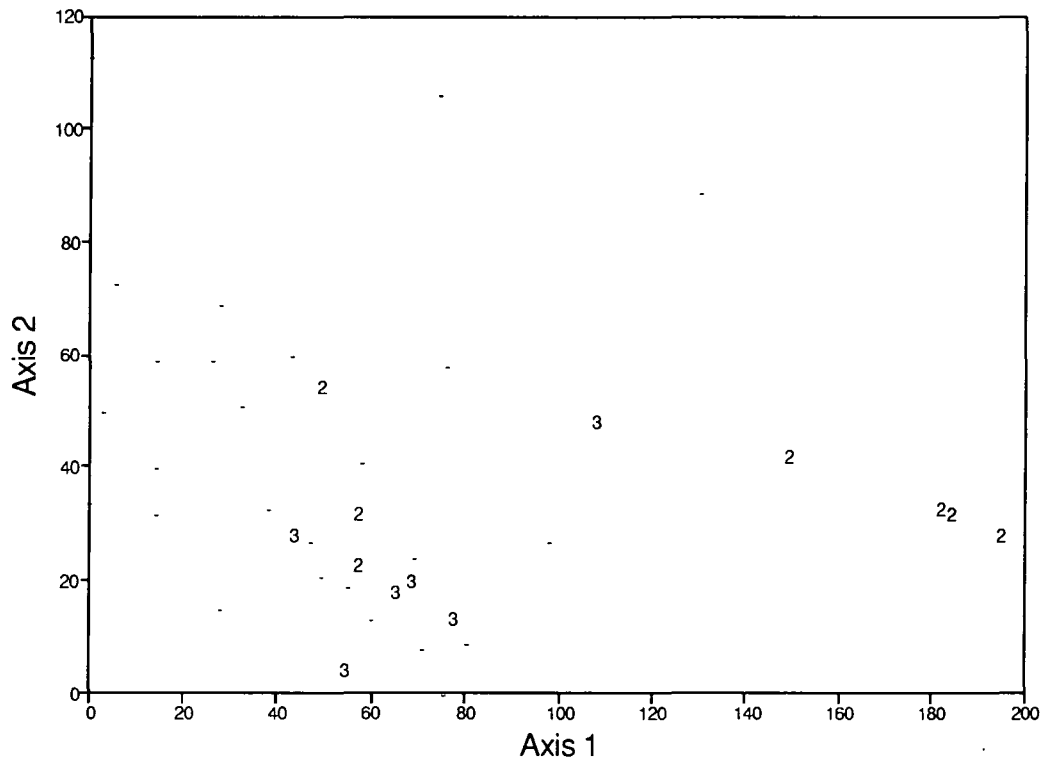

Figure 36 Domin score of *Viola riviniana*

This species varies more in abundance than *Hypericum pulchrum*, but the pattern of distribution is very similar.

Figure 37 Domin score of *Anemone nemorosa*

Unlike the last two species, samples containing *Anemone nemorosa* do not appear on the right, but show a strong tendency toward the lower end of axis 2.

Figure 38 Domin score of *Vaccinium myrtillus*

The tendency toward the top of axis 2 is obvious. A few samples contain both *Anemone nemorosa* and *Vaccinium myrtillus*, but clearly they show opposite trends.

Figure 39 Domin score of *Erica cinerea*

The pattern shown by *Vaccinium myrtillus* does not represent the other non-dominant dwarf shrubs. *Erica cinerea* shows a similar pattern to that of *Hypericum pulchrum*.

In these patterns there is evidence that there is an environmental gradient affecting the vegetation along axis 2. In Figure 31, some of the species preferring mineral soils are positioned well below 0 on axis 2. From Figure 33 we can see that this includes *Viola riviniana* and to a lesser extent *Erica cinerea*. It may be that this soil gradient is not parallel to axis 1, but is correlated with axis 2, although to a lesser extent. *Anemone nemorosa*, however, is not included in Ward's list and yet this species scores -201 on axis 2. Furthermore, *Rhytidadelphus squarrosus*, *Nardus stricta*, and *Poa pratensis* all score over 170 on axis 2, and yet all tend to prefer mineral soils. I think that axis 2 is related to some other environmental gradient or factor affecting the vegetation, but what that is, is not clear.

#### Peat bog vegetation

Casual observation of the vegetation on site, or inspection of the data for the four relevés 113 to 119 in Appendix 9 reveals that

1. the vegetation on the peat bog is very different from that on the heath. Ordination merely confirms this.
2. peat bog vegetation shows an obvious discontinuity between the surfaces above and below the edge of old peat cuttings. The lower, cut-over area being wetter, and dominated by *Eriophorum vaginatum* and *Sphagnum* species whereas the upper area is drier and dominated by *Calluna* with other dwarf shrubs and *Trichophorum cespitosum*. Ordination isolates sample 119 (cut-over) from samples 113, 114 and 115 (above peat cuttings), as expected.

The four relevés were compared with the following published material.

**McVean & Ratcliffe (1962)**

Trichophoreto-Eriophoretum typicum	(Western blanket bog)
Calluneto-Eriophoretum	(Pennine blanket bog)
Trichophoreto-Callunetum	( <i>Trichophorum-Calluna</i> bog)
Trichophoreto-Callunetum caricetosum	( <i>Trichophorum-Carex</i> mire)

**Birse (1980)**

Narthecio-Ericetum tetralicis	(Bog heather moor)
<i>Trichophorum germanicum-Calluna vulgaris</i> Association	(Deer-grass moor)
Erico-Sphagnetum papillosum	(Blanket & raised bog)

From these data, none of these communities had variation which would include any of the four relevés, but the nearest resemblance was with a sample of the Trichophoreto-Callunetum from the Moss of Bednawinny, near Dallas, Morayshire.

McVean & Ratcliffe (1962, p.128) discuss the mire complex in the pinewoods to the west of Loch Garten, but this discussion does not appear to include the wider expanse of basin peat to the south. The western mires will have been affected by drainage operations and by planting of Garten Wood in the late 1960's, as well as by subsequent extensive management since the Wood was purchased by the RSPB.

#### Comparison With Other *Calluna-Arctostaphylos* Heaths

##### 1. Comparison with McVean & Ratcliffe's Associations

Decorana was used to compare the heathland relevés from Tulloch Moor with the eight relevés published by these authors (1962) for their Arctostaphyleto-Callunetum (see Figure 40). Only species within the plots were considered. Liverworts were excluded from the analysis, and *Cladonias* were grouped into *Cladonia impexa* and *Cladonia* spp..

The entire range of axis 1 is taken up by the Tulloch Moor relevés, but all of these have lower axis 2 scores than McVean & Ratcliffe's. This implies that there is more variation in the Tulloch Moor heath relevés than between the relevés from the different sites, despite their geographic and altitudinal range. There are 2 obvious reasons for the greater variation in the Tulloch Moor samples.

- (i) There are 39 samples from Tulloch Moor compared with 8 from McVean & Ratcliffe. By chance alone there is likely to be more variation in a set of 39 samples than in a set of 8 samples selected at random from the same population.
- (ii) Given that McVean and Ratcliffe selected their stands to be representative of the Association, they will have avoided areas which were recently burnt or being colonized by trees and shrubs, and also species-poor stands of intermediate status, which form the extremes of the variation on axis 1.

In retrospect, a chosen sub-set of samples from Tulloch Moor would have made a better comparison.

The difference on axis 2 between the samples from Tulloch Moor and those of McVean & Ratcliffe are attributable to differences both in species composition and species abundance. Species present in McVean & Ratcliffe's samples but not in those from Tulloch Moor are:

*Hypochoeris radicata*  
*Pyrola media*  
*Solidago virgaurea*  
*Peltigera canina*  
*Polytrichum alpestre*  
*Polytrichum commune*  
*Blechnum spicant*  
*Orthilia secunda*  
*Plagiothecium undulatum*  
*Racomitrium lanuginosum*

and also *Empetrum nigrum* ssp. *hermaphroditum*

Only *Pyrola media* and *Peltigera canina* occur in more than one sample. *Pyrola media* is placed by McVean and Ratcliffe in constancy class V (present in 80 to 100% of samples), although in 3 cases it was present near, **but not in**, their sample plot. The last 5 only occur in a single, high altitude sample.

Species present in the Tulloch Moor samples but not in McVean & Ratcliffe's are:

*Betula* spp.  
*Nardus stricta*  
*Poa pratensis*  
*Luzula pilosa*  
*Listera cordata* (although present near sample 5)  
*Galium verum*  
*Plantago lanceolata*  
*Ranunculus acris*  
*Usnea* sp.  
*Hypogymnia physodes*

and *Empetrum nigrum* ssp. *nigrum*

Figure 40 Decorana: Tulloch Moor heath releves + 8 stands of Arctostaphyleto-Callunetum

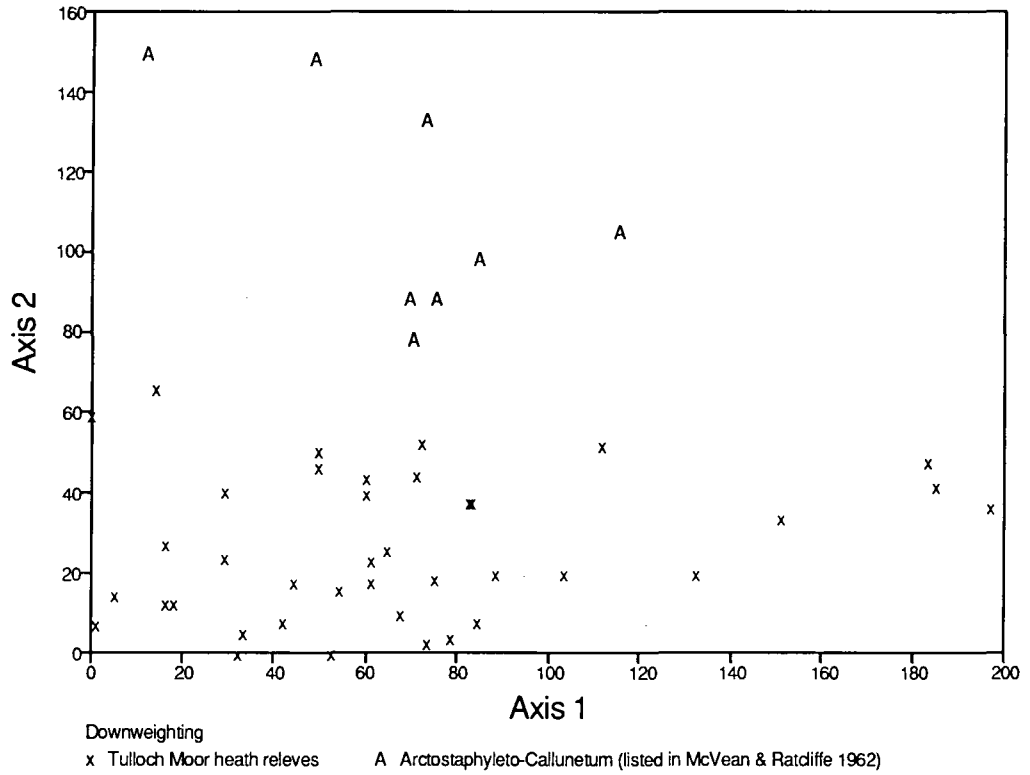

Figure 41 Samples plotted as Domin score of *Pyrola media*

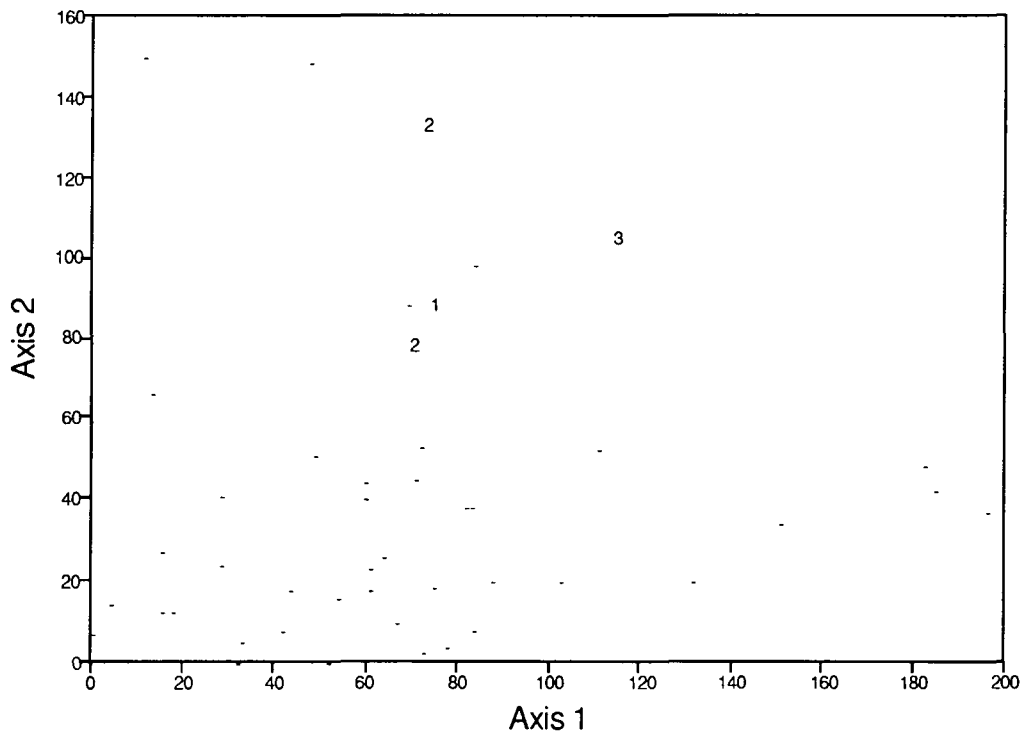

Figure 42 Samples plotted as Domin score of *Dicranum scoparium*

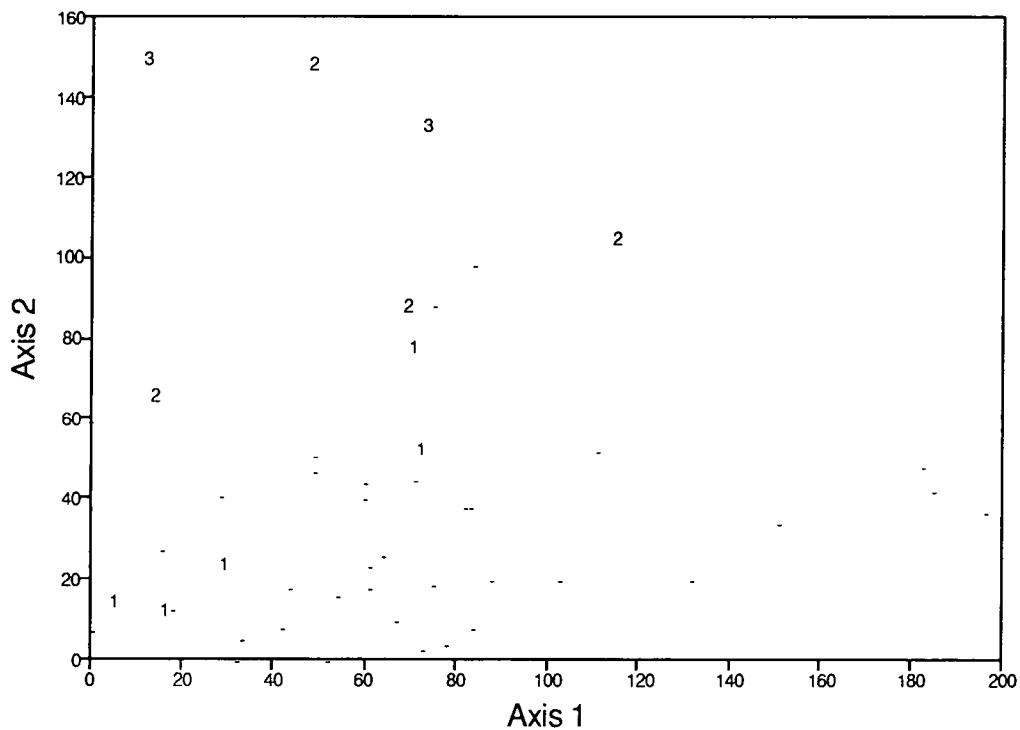
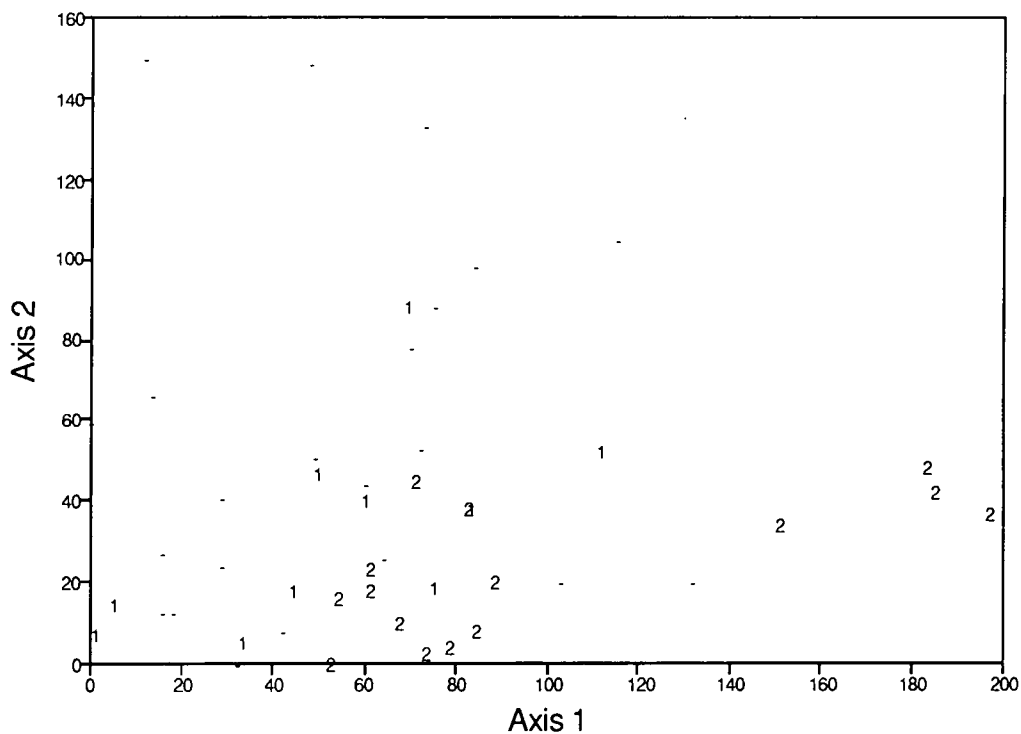

Figure 43 Samples plotted as Domin score of *Hypericum pulchrum*



Only *Hypogymnia physodes* and *Empetrum nigrum* occur in more than 5 of the 39 samples, and *Hypogymnia physodes* is the only one which occurs in more than half of them. Figures 41 to 43 show the Domin score of species which illustrate the patterns of differences. *Dicranum scoparium* is more common in McVean & Ratcliffe's samples, whereas *Hypericum pulchrum* is more common in the ones from Tulloch Moor.

In an attempt to solve the problems 1 and 2 above, and to put the analysis into a wider context, the analysis was repeated but with the addition of those 12 relevés of McVean and Ratcliffe's *Callunetum vulgaris* which are from the eastern Highlands (see Figure 44). Three important features emerge:

- (a) Apart from the outlying plots A4 and A5, the data form a continuum.
- (b) On axis 1, the samples show trends as follows:
 

<i>Callunetum vulgaris</i>	to the right
Arctostaphyleto- <i>Callunetum</i>	to the centre
Tulloch Moor heath relevés	to the left.
- (c) Four of the Arctostaphyleto-*Callunetum* samples are more closely associated with the Tulloch Moor samples than with the *Callunetum vulgaris*.

Of the two Tulloch Moor relevés which overlap with the *Callunetum vulgaris* on axis 1 (100 & 102), number 102 was chosen to represent old, rank heather, and both are notably species-poor.

## 2. Comparison with relevés from Urquhart (1986)

Urquhart (1986) gives only one 1m<sup>2</sup> relevé for each of the 36 sites she visited, including Tulloch Moor, although she took 110 relevés in all. Decorana yielded the ordination of samples in Figure 45. The Tulloch Moor relevé lies within the spread of points, and is close to the middle both on axis 1, and on axis 3 on another plot, but it is unsafe to conclude much from a single 1m<sup>2</sup> relevé.

Numbers of species in each of Urquhart's samples (including species recorded near the plots) were calculated from her data table, and are given below. There were 14 in the relevé from Tulloch Moor, and this number is typical.

No. of species	No. of samples
9-10	5
11-12	5
13-14	12
15-16	7
17-18	2
19-20	1
21-22	2

Figure 44 Decorana: Tulloch Moor heath relevés + 19 stands from McVean & Ratcliffe(1962)

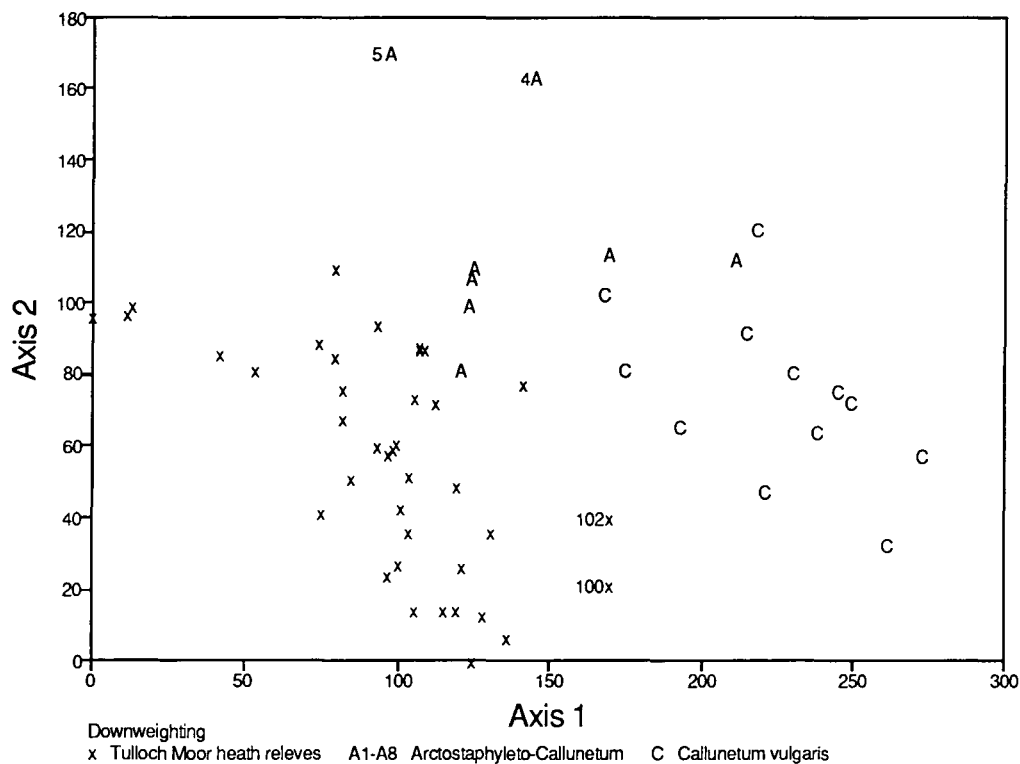
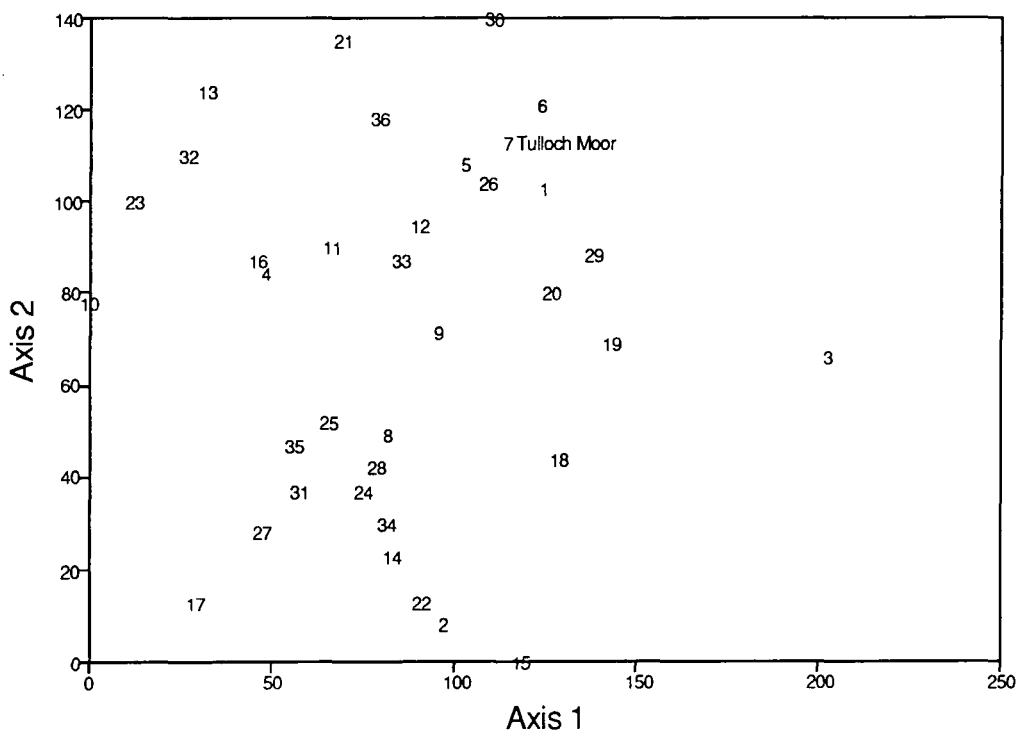

Figure 45 Decorana: relevés from 1x1m quadrats in Arctostaphylos heathland (Urquhart 1986)



### 3. Comparisons by Ward (1970 a & b)

In his analysis of 58 stands from *Calluna-Arctostaphylos* heaths Ward (1971a) used association analysis which divided the stands into two groups on the presence/absence of *Hypericum pulchrum*. Those stands with *Hypericum pulchrum* were herb-rich as compared with the rest. Details for his three stands on Tulloch Moor are:

Grid reference	<i>Hypericum pulchrum</i>	No. vascular plant spp.	Soil type
NH 946 166	-	15	Podsol
NH 947 168	-	14	Podsol
NH 954 164	+	22	brown earth

The two species-poor stands on the podsoles are on the western part of the moor, in the area which was planted with exotic conifers in the late 1970s. The species-rich stand is within the RSPB reserve.

Ward sampled stands of 10x10m and so deductions from his data are much more reliable than from my analysis of the available data by Urquhart. Of his original 58 stands which come from about 31 sites, 22 contained *Hypericum pulchrum* and fell into the herb-rich group. Of these only 12 contained all 8 of McVean and Ratcliffe's constants, Ward describes these 12 as representing the *Arctostaphylo-Callunetum* at its optimum development. The stand from within the reserve on Tulloch Moor was one of these.

### 4. Comparison with Birse (1980)

Birse (1980) classifies Scottish vegetation in an hierarchical system. He recognizes an Association called *Empetro-Ericetum cinereae* (Boreal heather moor) within which several types contain *Arctostaphylos uva-ursi*, but of these, the Subassociation with *Viola riviniana* which he calls Herb-rich boreal heather moor is similar to the heath on Tulloch Moor. In his synoptic table for this Association Birse gives only the constancy class for each species. In a comparison of the species lists from the heath relevés from Tulloch Moor and from his table, 19 species out of a combined total of 82 differed by more than one constancy class. If the Tulloch Moor relevés with a Juniper score  $\geq 5$  and Juniper + Birch  $\geq 6$  are excluded, the differences become 17/78. The most favourable comparison was between the same selection from Tulloch Moor and his C1 group of 11 relevés in which the differences were 15/66. The principal differences were in the greater constancy of *Arctostaphylos uva-ursi*, *Hypericum pulchrum*, *Succisa pratensis*, *Pseudoscleropodium purum*, *Rhytidiadelphus triquetrus*, and *Hypogymnia physodes* on Tulloch Moor, and the greater constancy of *Erica cinerea*, *Vaccinium myrtillus*, *Luzula pilosa*, *Anemone nemorosa*, *Galium saxatile*, *Trientalis europaea*, *Dicranum scoparium* and *Cladonia impexa* in Birse's table as well as the presence in his data of species not represented in the Tulloch Moor

relevés. Beside the C1 type mentioned, Birse includes in the Subassociation two lists lacking *Arctostaphylos*. These differences are placed in perspective by Birse's description of the Subassociation.

*Soils:* Brown forest soils usually of low base status but including some of moderate base status and brown magnesian soils. Rarely of flushed humus iron podzol.

*Morphology:* Dwarf shrub heath up to 40cm tall with *Calluna vulgaris* less clearly dominant than in most of the typical subassociation. *Erica cinerea* is usually abundant and there is a rich complement of forbs and grasses below the canopy layer.

*Status and land use:* Secondary community derived from Quercion robori-petraeae at lower altitude and latitude and Vaccinio-Piceetalia at the higher. The subassociation with *Anemone nemorosa* of Trientali-Juniperetum communis is clearly related to it. Grazed by sheep, usually Blackface, and is the highest quality ground for grouse-moor. Periodically burned over.

*Distribution:* Widely distributed and locally extensive in the hemioceanic areas of the eastern Highlands. More local in the eastern Southern Uplands and the extent of its occurrence north of the Great Glen not known."

Some of the relevés used by Birse (1980) are published in Birse & Robertson (1976), and of 6 relevés which Ward might call *Calluna-Arctostaphylos* heaths, 3 appear to meet the criteria for the Arctostaphyleto-Callunetum and contain 7 each of McVean & Ratcliffe's constants. The 6 relevés include variation like that found within Ward's (1971 a) data, and 5 of them vary similarly to those from Tulloch Moor except that they contain more *Erica cinerea*, *Trientalis europaea* and *Pyrola media*.

In summary, the evidence from Tulloch Moor indicates that the heath varies through all grades from stands which are like ordinary heather moor to stands which represent species-rich *Calluna-Arctostaphylos* heath, i.e. the Arctostaphyleto-Callunetum, at its best. The extent of the latter on Tulloch Moor is substantially less than the area which is currently heath.

## Soils

Both the patchiness of the vegetation and the use of a soil-probing rod indicate that the soils on the heath area of Tulloch Moor are patchy. In some places the probing rod met a hard sand or gravel substrate within a few centimetres of the surface, but in others there appeared to be a mull-like humus. The presence of molehills indicated that earthworms, or at least some of the larger soil fauna, were present (Mead-Briggs 1977). In both of Ward's studies (a) at Muir of Dinnet and (b) on the 58 stands from various *Calluna-Arctostaphylos* heaths, variation in soil type on a local scale is evident.

In Ward's (1971 a) analysis of 58 stands of *Calluna-Arctostaphylos* heaths, all the samples with *Hypericum pulchrum* were on brown earth soils, and all but one of these were species-rich ( $\geq 20$

spp. vascular plants). Of the 36 stands without *Hypericum pulchrum*, 10 or 11 were on brown earths and these contained 18 species of vascular plants on average whereas 24 or 25 were on podzols and contained an average of 12 species.

Ward's record of a brown earth soil under the herb-rich stand on Tulloch Moor would seem to be at odds with Gauld's (1982 and unpublished) descriptions of The soils on Tulloch Moor as podzols and humus iron podzols. Gauld (1980) indicates that the boreal heather moor on Tulloch Moor occurs only on the humus iron podzols, and that the herb-rich variant is restricted there to certain localities. "In all cases in which the herb-rich boreal heather moor was identified, the soil profile includes an old cultivated horizon which, by virtue of possessing abundant bleached sand grains, was probably undergoing a further cycle of podzolization." In their description of the *Arctostaphyleto-Callunetum*, McVean & Ratcliffe (1962) state "Soils exhibit a wide range of profile development from the typical iron-humus podsol of heather moor to brown loams resembling those of the *Betula-herb nodum*." In the quotation from Gauld (1982) in the introduction, Gauld also remarks on the similarity of the soil under the herb-rich heath to that of the surrounding birchwoods, furthermore, in his description he refers to a thin moder/mull horizon and thorough mixing of organic and other horizons of a previous iron-humus podzol. At least some of this apparent discrepancy may be the result of a difference in terminology.

#### Plant Species List

The moss *Pohlia nutans* was not recorded. Ward (1971 a) recorded it in one of the stands to the west of the RSPB reserve boundary, in the area now under trees.

In her description Urquhart mentions that many *Cladonia* species are present on Tulloch Moor, and this group may be under-represented in the data I have given. Only "basal squamules" are recorded in the relevé she gives. In her table of relevés, *Lathyrus pratensis* appears to have been inadvertently substituted for *L. montanus*, although in the text she gives *L. montanus* as one of the characteristic species of this community. On Tulloch Moor I saw and recorded numerous individuals of *L. montanus*, but none of *L. pratensis*.

## VEGETATION HISTORY

### Aims

To investigate the vegetation history of Tulloch Moor. In particular :

1. to investigate the history of the heath, and especially the history of *Arctostaphylos uva-ursi* on the site
2. to determine whether the moor was wooded in the past, and if so,
3. to broadly characterize the past woodland from the pollen assemblage,
4. to determine the major vegetation changes on the moor from the the period of woodland decline to the present, and
5. to investigate the fire history of the site, and the role of fire in the history of the vegetation.

### Methods and Materials

Peat is largely composed of accumulated plant remains and so it is a suitable medium for investigation of vegetation history. Pollen grain walls are especially resistant to decay (Faegri & Iversen 1964) and the wall of spores of pteridophytes and cryptogams is made of the same material. Macrofossils can be used for the study of vegetation history but because they are larger they usually travel less far from the parent plant. Macrofossils observed in the peat sample from Tulloch Moor consisted very largely of *Sphagnum* and *Eriophorum*. Pollen and spores are more suitable as indicators of past vegetation around, as opposed to on, the sampling site (Moore & Webb 1978). They are readily counted, and so they lend themselves to quantitative comparison through time.

### Choice of Peat Sampling Site

The sample was collected by Dr. B.Huntley, Mrs.J.P.Huntley, Steve Palmer and myself on a visit from 14-16/4/1989. Sampling from the lochan at grid ref.NH 961 164 was considered but rejected for practical and other reasons. Areas of deep peat were identified on the map of peat deposits produced by the Macaulay Land-use Research Institute. Unsuitable areas of peat subject to cutting were

Location of Peat Sample Site

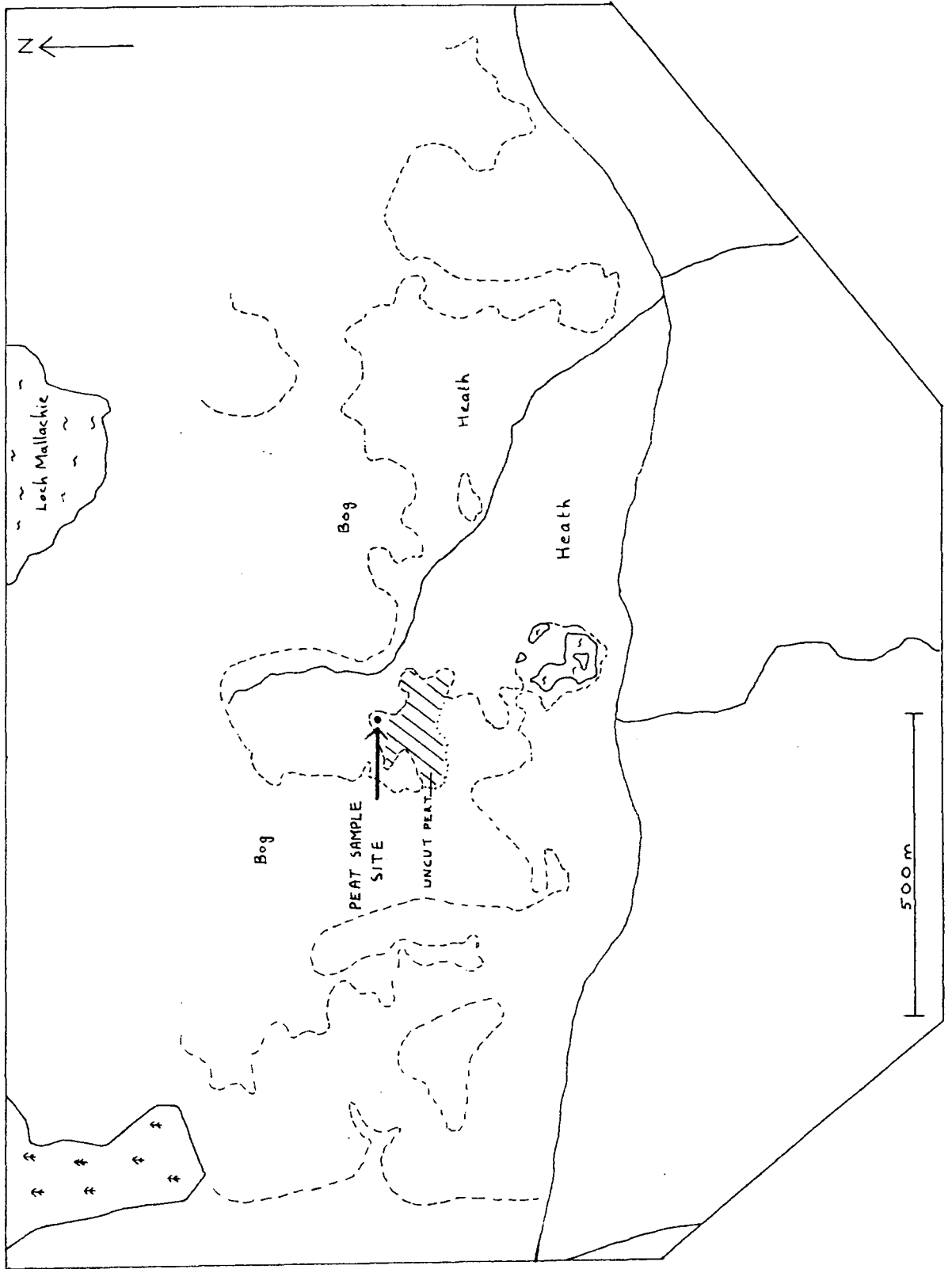

identified on the 1978 aerial photograph. The remaining possible peat basins were explored on foot. Some of these were deemed likely to have been cut over because:

- 1) The vegetation was like that of the obviously cut-over areas. (Dominated by *Eriophorum* & *Sphagnum*)
- 2) Accessibility (proximity to road)
- 3) Traces of very old peat cuttings or surface disturbance

Very few areas remained. The site chosen is shown in Figures 46 and 47. The heath rises on 3 sides of the peat which lies in a basin ca. 30m diameter. According to the model of pollen source and site diameter by Jacobson & Bradshaw (1980), in a basin of this size the majority of the pollen will be local in origin (i.e. from within 20m of the edge of the basin). The vegetation immediately adjacent to the site is represented in relevé 113 (Appendix 9), and this is similar to 114 and 115 which were 25m away. These are unlike the relevé from the cut-over peat, number 119. There is no evidence of peat cutting in this basin on the aerial photographs which date back to 1948. Cutting which was recent in 1948 is still clearly visible on the 1978 picture. Furthermore, cuttings which appear to have been last used a long time before 1948 are equally clear on the 1978 photograph, and so if the peat in the sampling basin was ever cut, it must have been taken some hundreds of years before 1948.

A vertical pillar or monolith of peat was excavated from the site to a depth of 82cm at which depth there were 2 sections of wood and 2 pale rounded stones of ca. 5cm and 7cm diameter. A livingstone corer was used to extract a peat core of 5cm diameter from depth 82 cm to the base of the peat at 143cm, although this was obtained in two sections. Grit on the base of the core was taken as confirmation that it reached to the surface of the underlying till. The sample sections are summarised below.

Monolith	0-82 cm
5cm core	82-125 cm
5cm core	125-143 cm

The monolith was wrapped in polythene and the core sections in film-wrap and aluminium foil to prevent desiccation and contamination by pollen and spores. Each section was labelled with its depth and orientation.

#### Laboratory Methods

The peat samples were stored in a cold room at ca. 5 °C. The peat profile was cut square and the exposed surface cleaned by lateral scraping with a razor before sampling. Samples for pollen and charcoal analysis were 1x1cm in area and 0.5cm deep. Two profiles, A and B, 10cm apart

Figure 47  
Sketch of peat sampling site

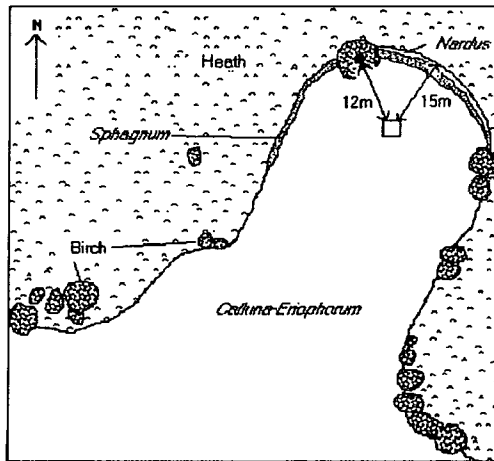

Figure 48

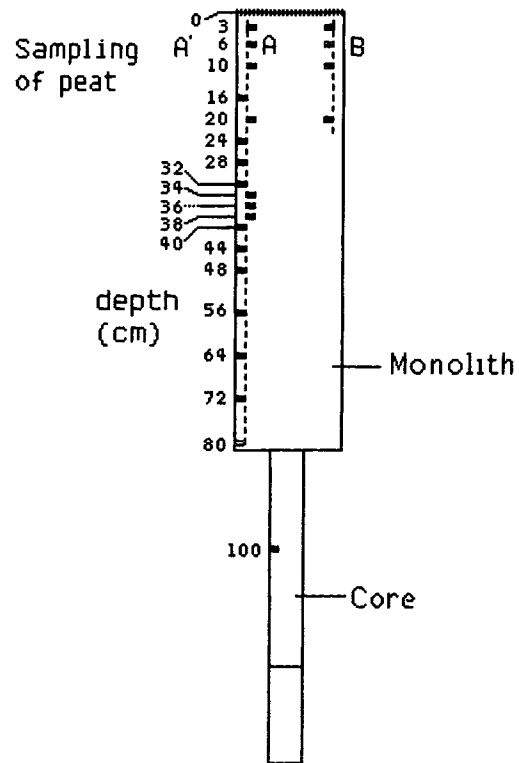
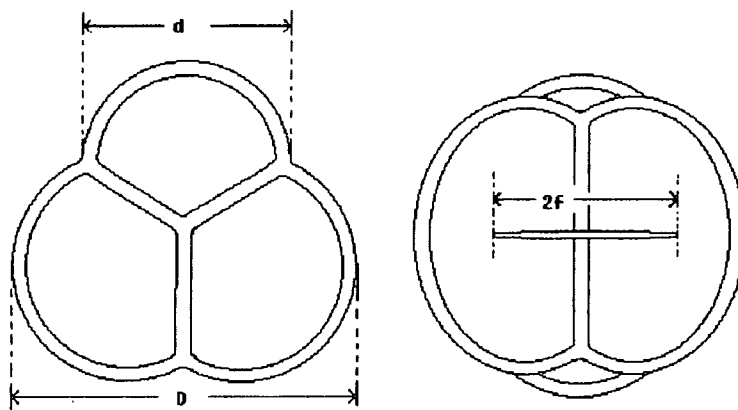

Figure 49 Tetrad measurements



were sampled initially in an attempt to test for peat disturbance by comparison of the pollen frequencies. Only profile A was sampled further. Samples from profile A were either cut directly from the monolith or from an adjacent 1x1cm column (A') which was taken from the monolith in 20cm sections (see Figure 48). The 1x1x0.5cm peat samples were stored in glycerine in sealed glass bottles until used.

A surface sample was prepared from the vegetation on the top of the monolith. This vegetation was largely mosses, lichen and heather, and contained *Pleurozium schreberi*, *Hypnum cupressiforme*, *Cladonia impexa*, *Erica tetralix*, *Calluna vulgaris* and *Eriophorum vaginatum*.

### Peat Stratigraphy

This was restricted to a simple physical description of the peat monolith.

### Pollen preparation

Samples were treated with the following processes:

- Digestion in hot NaOH
- Wash through 60 mesh sieve (apertures ca.214µm)
- Acetolysis
- Suspension in silicone oil (2000 centistokes)
- Oven overnight + 24hrs+ to dry and settle
- Mount on slide

These are described by Moore & Webb (1978) with variations as follows:

1. Hot NaOH was initially for 2 min., but in the poorly humified peat the slides were obscured by excess detritus, and so the time was increased to 5 or 10 min.
2. 2ml of exotic pollen (*Eucalyptus*) suspension @  $40 \times 10^3$  grains  $\text{cm}^{-3}$  in glycerine was added to samples from the following depths (cm) 10,16,20,28,34,36,38,44,100
3. Aqueous safranin was used to stain the samples from the following depths (cm) 0(surface),3,6,16,28,34,36,38,44,100

### Pollen Identification & Counting

Slides were examined with a Vickers binocular laboratory microscope, initially at 100x and 400x magnification. Difficult pollen grains were examined under oil immersion at 1000x. Pollen was

counted at 400x in a series of traverses at 0.5mm intervals. Microscope stage coordinates of unidentified grains, grains of uncertain identity, and non-*Calluna* Ericales pollen grains were noted down for later reference.

Pollen grains and spores were identified with the aid of:

- 1) texts: Faegri & Iversen (1964)  
Moore & Webb (1978)  
Oldfield (1959)
- 2) reference material in collections at Durham:  
in the Palaeoecology Laboratory.  
in Dr. J. Turner's collection  
in the Geography Dept. collection
- 3) reference material made up during the project
- 4) and especially with help from Drs. Huntley, Gear & Turner.

A second Vickers microscope was set up adjacent to the first for rapid comparison of reference and fossil pollen under similar conditions.

A target count of 300 grains per slide was adopted initially, but some supplementary slides were counted with a target of 100 grains per slide (see Moore & Webb pp.79-88).

Preliminary pollen percentages and diagrams were prepared with calculator & graph paper, but final versions have been executed with an updated version of the program POLLDATA by B. Huntley & H.J.B. Birks.

Pollen for reference slides

Small numbers of flowers of those common species required which were in flower, were collected locally to the study site. For those species of which samples were not obtained there, or the flowers were immature, specimens were collected locally around Durham. Unused material was added to the collection kept by Dr. J. Turner for this purpose.

Excised anthers or whole flowers were used to prepare pollen as per the process described for the fossil pollen in peat. Samples were placed in NaOH before taking them into the preparation laboratory as a precaution against contamination of other material.

## Ericales Pollen

### Ericales reference pollen

Among other species, reference slides of Ericales pollen, i.e. *Arctostaphylos uva-ursi*, *Empetrum nigrum*, *Erica cinerea*, *E. tetralix*, *Vaccinium myrtillus*, and *Vaccinium vitis-idaea* were prepared because these species were either not present in the existing collections, or the existing specimens were decayed or mounted in a different medium which affects the size or shape of the grains. *Calluna* pollen was so abundant in the fossil pollen slides, and is sufficiently distinctive that it was considered unnecessary to make new reference material of this species. *Pyrola* pollen was not collected.

Samples of these Ericales pollen were measured under a Leitz microscope at 400x with an eyepiece graticule calibrated against a measure with divisions of 10  $\mu\text{m}$ . In addition to a measurement of gross tetrad size irrespective of orientation, nomenclature and measurements of Ericales tetrads follows Oldfield (1959), and included tetrad diameter (D) and grain diameter (d) which were taken on individuals in polar view. (see Figure 49) Occasionally other measurements, eg. furrow length (2f), were taken, but because of the orientation required, these were usually on different tetrads to those used for D and d. In addition to measurements, other characteristics noted were: tetrad shape, surface texture (sculpturing), furrow width, presence/absence of costae, and costa width and shape.

### Ericales fossil pollen

Any slides of fossil pollen not fully scanned during counting were scanned at 100x or 400x for non-*Calluna* Ericales pollen tetrads, and the coordinates noted. The best-preserved specimens were then examined and measured in the same way as for the reference material. The measurements D and d of the fossil pollen were compared with those of the reference pollen using Canonical Variates Analysis (=Discriminant analysis) (Blackith & Reyment 1971) which is available as an option in the SPSS-x statistical package on the Durham University mainframe computer. Other characteristics were compared with graphs.

## Charcoal

Charcoal analysis was similar to the method of Gear (1989) The residue on the sieve after washing peat samples was saved in petri dishes. If dry, the residue was re-wetted and stirred to disaggregate it, sometimes with a small amount of household liquid detergent. Charcoal particles in six 1x1cm squares were divided into size classes:

large particles	> 2.0 mm
small particles	2.0 - 0.2 mm
microscopic ..	< 0.2 mm

and counted using a dissecting microscope with magnification 10x to 50x. Charcoal particles were distinguished from other dark material by their all-black colour, often shiny lustre, and angular shape.

Data were plotted with POLLDATA as Macrofossils

Microscopic charcoal was also counted on some of the pollen slides at depths given in Appendix 21. Counts were expressed per 100 pollen grains and were made for a sample part of the slide only. In each case the number was counted over a sample of > 100 pollen, except at 64cm depth at which there were 300 carbon particles per 57 pollen.

#### Juniper Ring Counts

Trunk sections were taken from each of four juniper bushes from along the side of the road across Tulloch Moor. These bushes were all east of NH 964 162, and had been cut by the local authority roads department. Each section was reduced to between 3 and 6cm thick, taken from nearest the base, and then one face was sanded with successively finer abrasive paper of 100, 150, and 220 grade. Rings were counted under a binocular dissecting microscope at approximately x10. A damp cloth was used to moisten the surface in order to improve the definition of rings which were close together.

#### Historical Ecology

No systematic search was made, but the possible sources of information encountered were so numerous and diverse that this subject could be made a study in itself. The material consulted is that which was readily available and includes:

- published literature
- published maps
- aerial photographs
- copies of unpublished documents supplied by Mrs.Dennis, S.Taylor & B.Dunlop
- Oral evidence from graziers and from the warden.

## Results & Discussion

### Reference Pollen

Apart from the Ericales species mentioned earlier, reference pollen slides were also made of the following species.

Species	Date	Place
<i>Antennaria dioica</i>	not known	The Burren, Eire
<i>Genista anglica</i>	25.6.89	Strathspey
<i>Hypericum pulchrum</i>	25.6.89	Strathspey
<i>Helianthemum nummularium</i> (= <i>H. chamaecistus</i> )	83	Rumania
<i>Juniperus communis</i>	21.5.89	Teesdale
<i>Lathyrus montanus</i>	21.5.89	Teesdale
<i>Melampyrum</i> (cf. <i>M. pratense</i> )	25.6.90	Strathspey
<i>Sorbus aucuparia</i>	21.5.90	Co. Durham
<i>Viola riviniana</i>	09.5.66	Teesdale

### Comparison of Pollen in Profiles A & B

Time allowed for the counting of only one sample (3cm depth) from profile B. Pollen frequencies and percentages for this sample and for profile A at 3cm are given in Appendix 11. The data, excepting minor taxa, are shown on the histogram in Figure 50. Differences in pollen percentages are comparable in magnitude to those between consecutive samples (3 and 6cm) in profile A. The differences are smaller than those between 3cm and 16 or 20cm, and probably reflect the spongy, unconsolidated nature of the peat near the surface in which stratification has not yet developed.

Turner et al (1989) found differences in pollen percentages in 2 peat profiles 1m apart from the North York Moors, although the differences were small as compared with the overall similarity of the two diagrams. They attribute some of the differences to variation in the microtopography of the mire surface. Wilkinson & Huntley (1987) attribute variations in pollen concentration of a factor of 20 over their 20x20m grid of cores to variation in the rate of pollen destruction, which in turn they attribute to mire surface microtopography and aerobic conditions in pools. Air was present in the top 5 to 6cm of the peat sample from Tulloch Moor, and variation in pollen preservation might account for the small differences between profiles A and B, but no pools were present at the sample site, and lower down the profile all the peat was waterlogged, and horizontal variations in consistency appeared to be minimal.

In these results from Tulloch Moor there is no evidence of peat-cutting or other major peat disturbance in the peat profile.

Figure 50

Pollen percentages in A & B profiles at 3cm depth

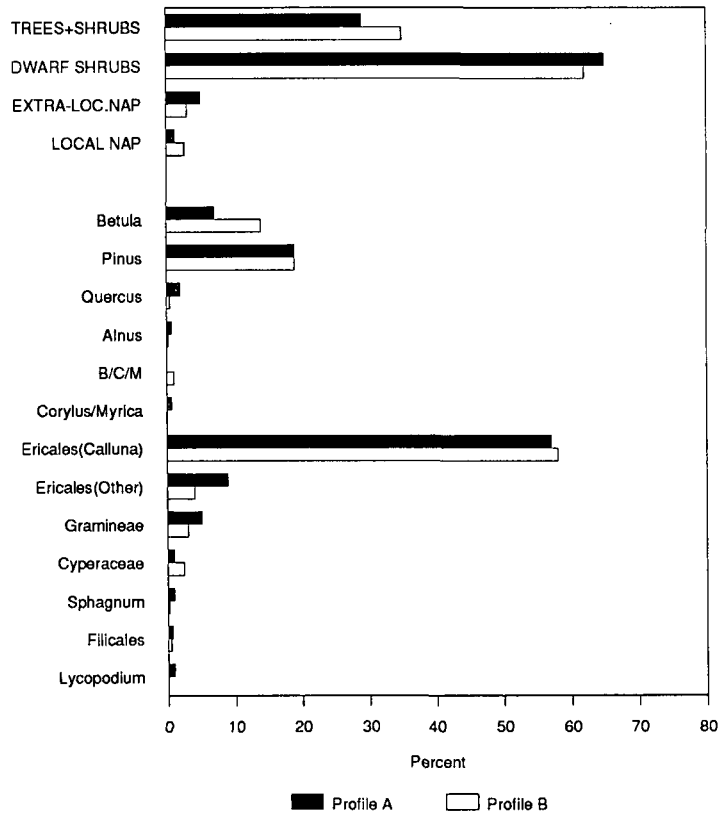

Pollen percentages in profile A at 3 and 6cm depth

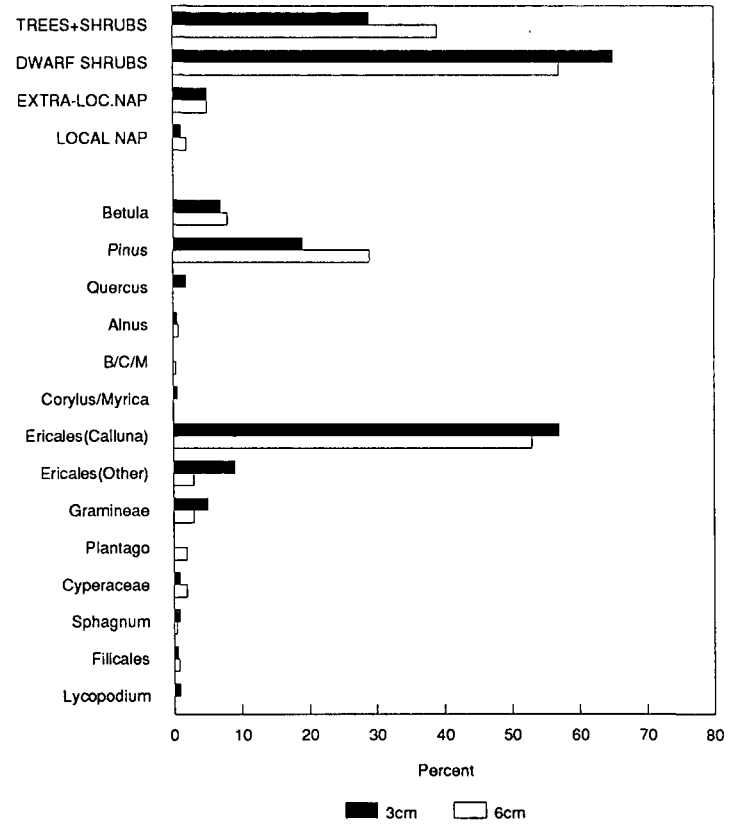
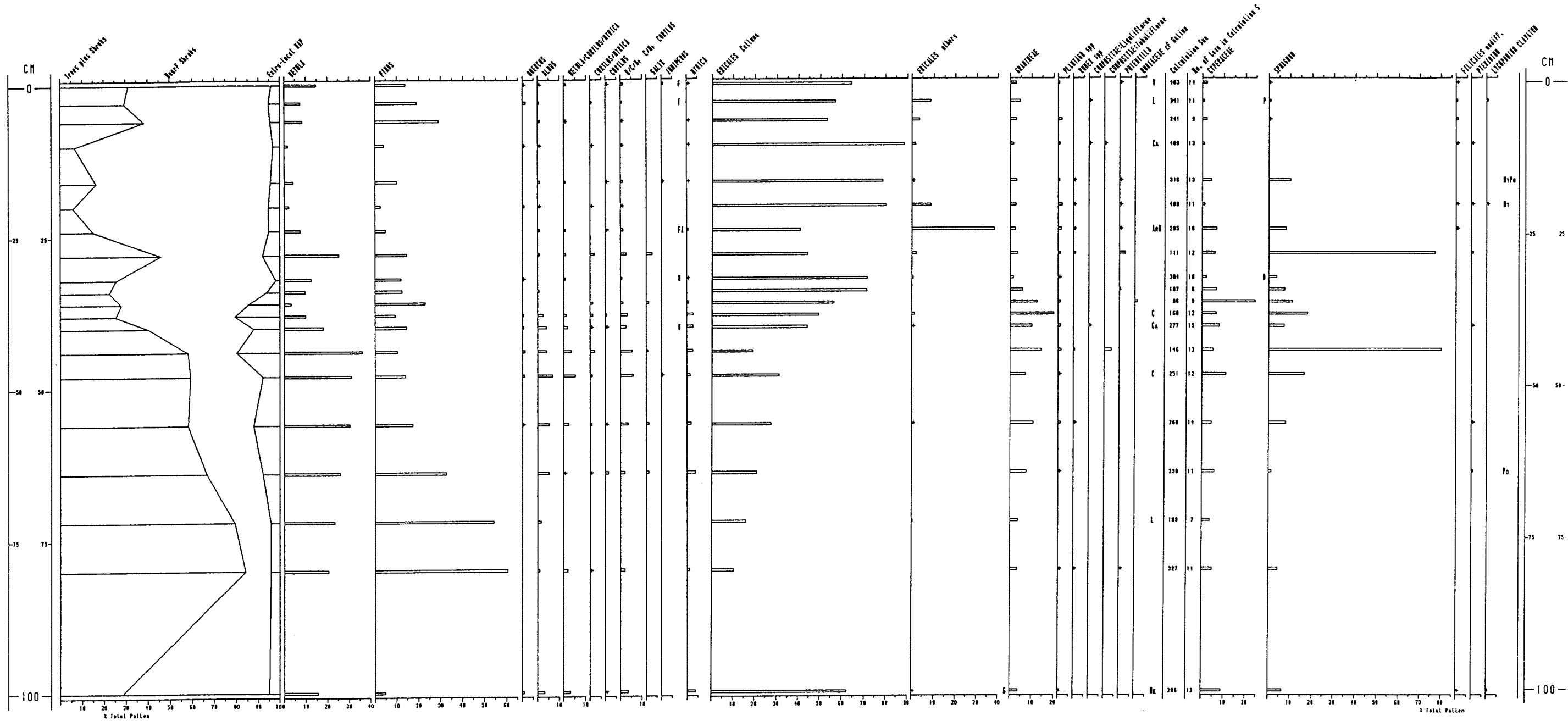

Figure 51

Percentage pollen diagram from Tulloch Moor peat



Tulloch Moor, R. Ascroft, 20/9/1989

- List of abbreviations  
 Taxa with less than 3 occurrences at values less than 1.00
- F FIGUS
  - A ACER
  - U ULMUS
  - T TILIA
  - S SORBUS Lpp.
  - C CORYLACEAE
  - CA CARYOPHYLLACEAE
  - AN ANEMONE
  - H HYPERICUM
  - HE HELIANTHUS
  - L LACTUCA
  - V VICIA cf. Sativica
  - P PEDICULARIS
  - B BRASSICA
  - HY HYPERUZIA SELAGO
  - PH PHTYSIDIA

## The Pollen Record and Vegetation History

Pollen analysis yielded clear information about the vegetation history of Tulloch Moor in general, but not about the history of the herb-rich *Arctostaphylos* heath community in particular.

The frequencies of pollen & spore types found in the fossil and surface samples of peat are given in Appendix 12. Pollen of some plants is variable such that some grains may be distinguished from those of similar species whereas others may not, and it is convenient to include combined categories for those grains of uncertain identity. *Betula/Corylus/Myrica* (B/C/M) is such a category. The results of pollen analysis are summarised in the pollen diagram in Figure 51. In the diagram, pollen frequencies at each level are expressed as percentages of the Calculation Sum which is made up of Subsums as follows:

Trees + shrubs

Dwarf shrubs

Extra-local NAP (Non-Arboreal Pollen which originates from outwith the peat bog)

Outwith the Calculation Sum are:

Local NAP (Non-Arboreal Pollen pollen which, or which probably originated from plants on the peat bog, eg. *Cyperaceae: Eriophorum, Trichophorum*, etc.)

*Sphagnum* spores

Pteridophyte spores (ferns, etc.)

Pollen and spore percentages are given in Appendix 13

Pollen diagram: summary diagram

The summary diagram is in the left of the pollen diagram and shows the ratio of Trees+shrubs:Dwarf shrubs:Extra-local NAP. There are four important results:

- 1) The percent of Trees+Shrubs pollen is lower in levels 10 to 24cm than at or just below the surface.

<u>Depth (cm)</u>	<u>% Trees+Shrubs</u>	<u>Mean</u>	
0	32		
3	29	33%	t-test with arcsine transformation:
6	39		
10	7		
16	16	11%	t = 6.60
20	6		v = 5
24	15		P < 0.01

In other words the tree cover is greater now than in the recent past. The recent increase in trees appears to have been at the expense of dwarf shrubs.

- 2) From 20cm downwards the percent of Trees+Shrubs pollen increases to exceed 50% at 44cm and rises to a maximum of 84% at 80cm. This indicates that the tree cover was substantially greater than now for an extended period, that there has been a woodland canopy for a shorter period, and that there has been a great woodland decline.
- 3) As Trees+Shrubs pollen declines from 80cm upward, so the proportion of Dwarf Shrubs pollen increases. Therefore, corresponding to the woodland decline, there has been a large increase in heath.
- 4) At 100cm depth the percent of Trees+Shrubs pollen is similar to contemporary levels, and the pollen is dominated by Dwarf Shrubs. Contrary to the continuous woodland history anticipated prior to the decline, there have been phases of woodland increase and decline.

In addition to the above results: (5) there is a temporary rise in Extra-Local NAP at the main tree decline (44 to 36cm), after which the pollen curve becomes more stable. (6) Because canopy cover at the sampling site has varied markedly, so too will the pollen catchment area have varied (Jacobson & Bradshaw 1981).

#### Pollen diagram: further woodland history

- 1) Pine and birch dominate the arboreal pollen throughout, and have probably been the dominant trees throughout.
- 2) Declines in pine pollen from 80 to 44cm and from 36 to 34cm are accompanied by increases in birch pollen. The rise in pine pollen from 44 to 36cm is accompanied by a decrease in birch pollen. At least one of the major factors causing vegetation change has affected these two trees differently. The large decline in pine pollen from 61% at 80cm to 10% at 44cm coincides with a decrease in Trees+Shrubs pollen, but the latter decrease is smaller (84% to 58%). Opening of the canopy will allow more pollen from elsewhere to enter, but this result indicates a real increase in the amount of birch pollen, and probably an increase in the amount of birch in the vegetation. In other words decline or removal of pine has allowed an increase in birch.

<u>Percent Change from 80 to 44cm</u>	
Pine decrease	51%
Trees+Shrubs decrease	<u>26%</u>
difference	25%
Birch increase	16%
Increase in other trees & shrubs	<u>9%</u>
sum	25%

- 3) Simultaneous rises in pine and birch pollen occur from 100 to 80cm and from 10 to 6cm, and probably from 20 to 16cm. A simultaneous decrease occurs from 28 to 20cm, and probably another from 16 to 10cm. Either one process has affected birch and pine similarly, or two or more factors with similar effects have affected them at the same time.
- 4) *Alnus* pollen exceeds 5% from 64 to 48 cm. Alder has been a more important tree in the past than it is now.
- 5) There is a sharp increase in Trees+Shrubs pollen from 10 to 6cm which is caused by an increase in *Pinus* and to a lesser extent *Betula* pollen. This is followed by a decline in *Pinus*, whereas *Betula* increases from 3cm to the surface. These changes in the pollen are believed to represent corresponding changes in the vegetation associated with planting and felling of pine in Abernethy forest, and the colonisation of Tulloch Moor by birch trees.

#### Pollen diagram: heathland history

Dwarf shrub pollen, consisting very largely of *Calluna* is dominant at 100cm (67%) but declines to 12% at 80cm, and does not rise above 50% again until 38cm. The present phase of open heath is not the first.

The percentage of grass pollen (Gramineae) tends to rise when Trees+Shrubs pollen is declining, but it returns to 3 or 4% afterward, even if the Trees+Shrubs pollen stays low. This is consistent with a flush of grasses following burning as seen in permanent plot number 8 in the previous chapter.

Following the peak in Gramineae pollen at 38cm, Dwarf Shrub pollen peaks at 34 to 32cm followed by a peak in *Betula* pollen at 28cm. This looks very like an ecological succession following fire.

The presence of herb pollen such as *Helianthemum*, *Lathyrus*, *Hypericum*, *Potentilla*, and

Rubiaceae cf. *Galium* at various levels in the profile is consistent with the presence of herb-rich *Arctostaphylos* heath, but they are not sufficient in number or variety at any one level to demonstrate this.

#### Pollen diagram: cultural indicators

The occurrence of *Plantago* pollen at most levels from 100cm to the surface, often together with *Rumex*, and *Pteridium* indicates the presence of man and/or domestic grazing animals from the earliest time represented in the peat profile.

#### Discussion

As in Figure 51, the top 80cm of Birks' (1970) pollen diagram shows a decline and resurgence of tree pollen, mirrored by an increase and decline of *Calluna*. As one would expect, these changes appear smaller than in my diagram, because her core was taken from a point within the pinewood some 500-600m from the present edge of Tulloch Moor.

<u>Percent Trees+Shrubs</u>		
	Tulloch Moor	Birks (1970) - top 80cm
min.	6	42
max.	84	82

The *Alnus* curves are also similar: in Figure 51 it peaks at 48cm and then declines, in Birks' diagram *Alnus* peaks at 50cm. Further comparison however, reveals some differences in Birks' diagram, such as the rise in pine pollen relative to other trees.

Birks names her uppermost pollen assemblage zone *Calluna-Plantago lanceolata*, and in it there is an increase in the occurrence of *Rumex* and other weeds indicative of human presence or grazing by domestic animals. Well below the large expansion in *Calluna* in her top pollen assemblage zone, there is a smaller *Calluna* peak at 160cm which is accompanied by a decrease in Arboreal Pollen and the occurrence of *Rumex acetosa*. This appears to represent a temporary phase of forest clearance and heathland expansion/formation which may be the one on Tulloch Moor represented at 100cm on Figure 51.

#### Dating

If the radiocarbon dates from Birks & Mathewes (1978) profile are transposed to the equivalent levels (identified by the pollen assemblage) on Birks' (1970) diagram and extrapolated to 0cm (see Figure 52), the arboreal maximum

Figure 52

Age vs depth in peat profile by Birks  
(1970) Dates from Birks & Mathewes(1978)

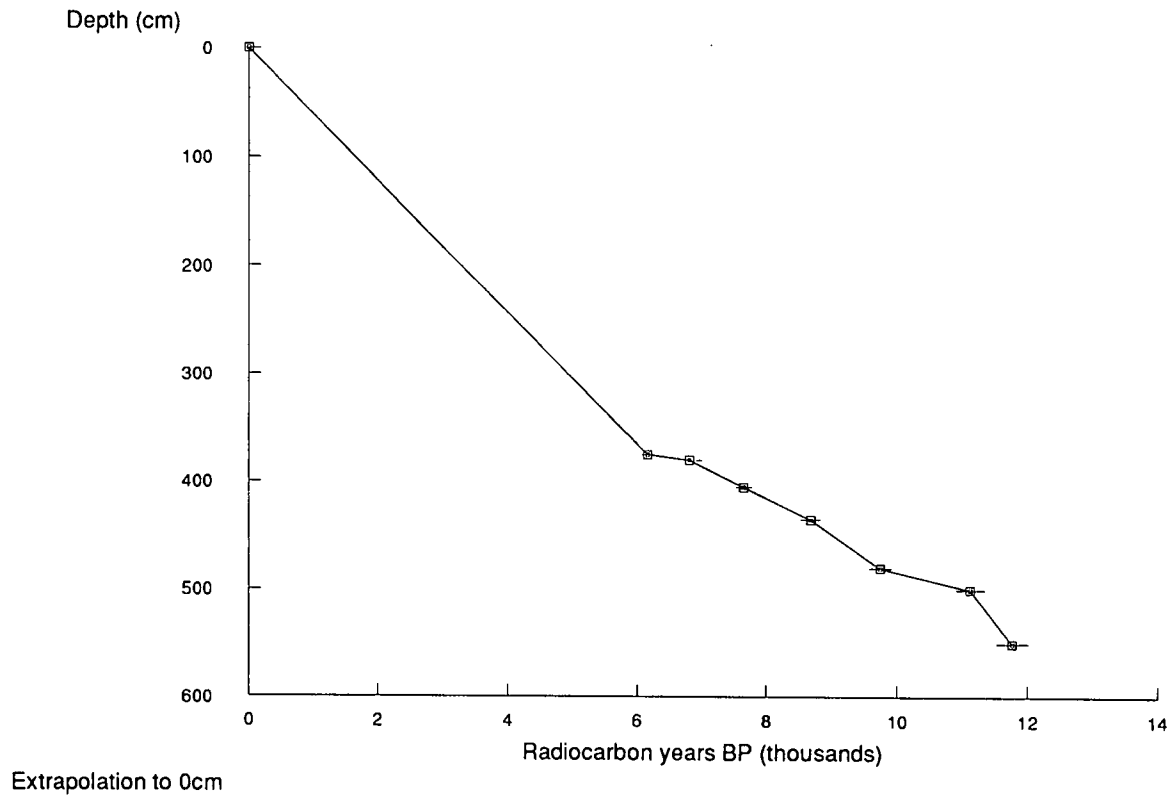

prior to the *Calluna-Plantago lanceolata* pollen assemblage zone (80cm) occurs ca. 900 BP, and the lower *Calluna* phase occurs ca. 2600 BP. This extrapolation assumes a constant rate of peat accumulation despite changing peat consistency, and a faster rate than that prior to the uppermost date at 6159 ±100 BP. Furthermore, if the lower *Calluna* phase at 160cm in Birks (1970) diagram is the one seen at 100cm in Figure 51, then this presupposes a reduction or an interruption in the peat growth at the Tulloch Moor site between the heathland phases. This would be consistent with the presence of the two sticks and two round stones in the peat at 82cm.

On his pollen diagram from Loch Garten, O'Sullivan (1974 a) identifies his uppermost pollen assemblage zone with low Arboreal Pollen, high *Calluna*, and high Gramineae values, associated with frequent *Plantago* and *Rumex*. He dates the lower boundary of this zone to 3635 ±205 BP. The zone spans only 20cm of the core. There appear to be two *Calluna* phases, but three dips in Arboreal Pollen. O'Sullivan (1974 b) interprets the pollen evidence as indicating forest clearance by people moving into Strathspey in the second millennium B.C.. This in turn he associates with the presence in the area of Clava-type chambered tombs (Burl 1976), one of which is at Aviemore (see Figure 63).

On his pollen diagram from Loch Pityoulish O'Sullivan (1976) identifies two phases of anthropogenic forest clearance and heath formation, and from a series of radiocarbon determinations he dates the start of these phases at 3000 BP and ca. 1000 BP, with a period of forest regeneration ca. 1650 BP. These phases therefore overlap with the tentative dates given to the two *Calluna* phases on Birks' (1970) diagram mentioned above. The foundations of Kincardine Church (location on Figure 63) date from the 12th century (RCAHMS undated), which would seem to conform to the pattern of forest clearance and settlement around Pityoulish from ca. 1000 BP, although according to a framed notice inside the door, the first Christian church here was Celtic, probably founded by missionaries from Iona in the 7th century.

In Figure 62 the rise in pollen slide charcoal (psc) from 24 to 6cm and the abrupt decline to 3cm is suggestive of the rise in smoke emissions, especially from coal burning, and the subsequent improvement in air quality following the Clean Air Act of 1956 (Woodin 1989). Steven & Carlisle (1959) quote evidence that Pope Pius II commented on the use of coal in Scotland which he visited during the reign of James I, in the 15th century.

The sharp increase in *Pinus* pollen from 10 to 6cm is consistent with pollen changes in a mor humus profile from near the Loch Mallachie outflow, analysed by O'Sullivan (1973c). From tree-ring counts and documentary evidence he identified two generations of trees in this stand which were planted in 1830-40 and 1870.

As mentioned earlier, the recent rise in *Betula* pollen from 3cm to the surface is attributable to the

spread of birch trees across Tulloch Moor. Aerial photographs dating back to 1948 show that trees have been spreading across the Moor from about that time, but a detectable rise in *Betula* pollen from these trees may have been more recent than this date.

#### Reconstructing past vegetation: method

O'Sullivan (1973 a) took surface pollen samples throughout Abernethy, including Tulloch Moor. His data are expressed as % total land pollen (LP), which is very similar to my Calculation Sum, and so they are well suited to interpretation of the fossil pollen spectra in this study. His samples were collected from the following vegetation types:

- Pinewood
- Clearings in pinewood (<300m dia.)
- Pine-heath
- Heath (open, >300m dia)
- Birch (small clumps)

For the purposes of comparison I reduced both sets of pollen data to 5 principal taxa: *Betula*, *Pinus*, Coryloid, *Calluna*, and Gramineae, the remainder being omitted. Principal Components Analysis (PCA) was used on the combined data from this study and O'Sullivan's surface samples. The PCA results were used in conjunction with the pollen diagram to reconstruct past vegetation on Tulloch Moor.

#### Reconstructing past vegetation: results

Figure 53a shows the results of the PCA.

Principal features:

- 1) Surface samples in each vegetation type give a wide spread of points, and so only broad distinctions are possible.
- 2) Fossil samples from 10, 16, 20, 24, 38, 44, and 100 cm lie outwith the spread of surface samples because they contain more *Betula* and less *Pinus* than the latter.
- 3) In Figure 53b the surface sample in this study lies on the plot below the surface samples which O'Sullivan took from Tulloch Moor because it contains less *Pinus* and in most cases more *Calluna* pollen than O'Sullivan's samples. It also contains less Gramineae and more *Betula*. Evidence from 1966 and 1978 aerial photographs (see Plate 1), and from personal observation indicate that birch has increased on the Moor since O'Sullivan took his

Figure 53a

Principal Components Analysis of pollen samples +  
O'Sullivan's (1973a) surface samples. Principal taxa only

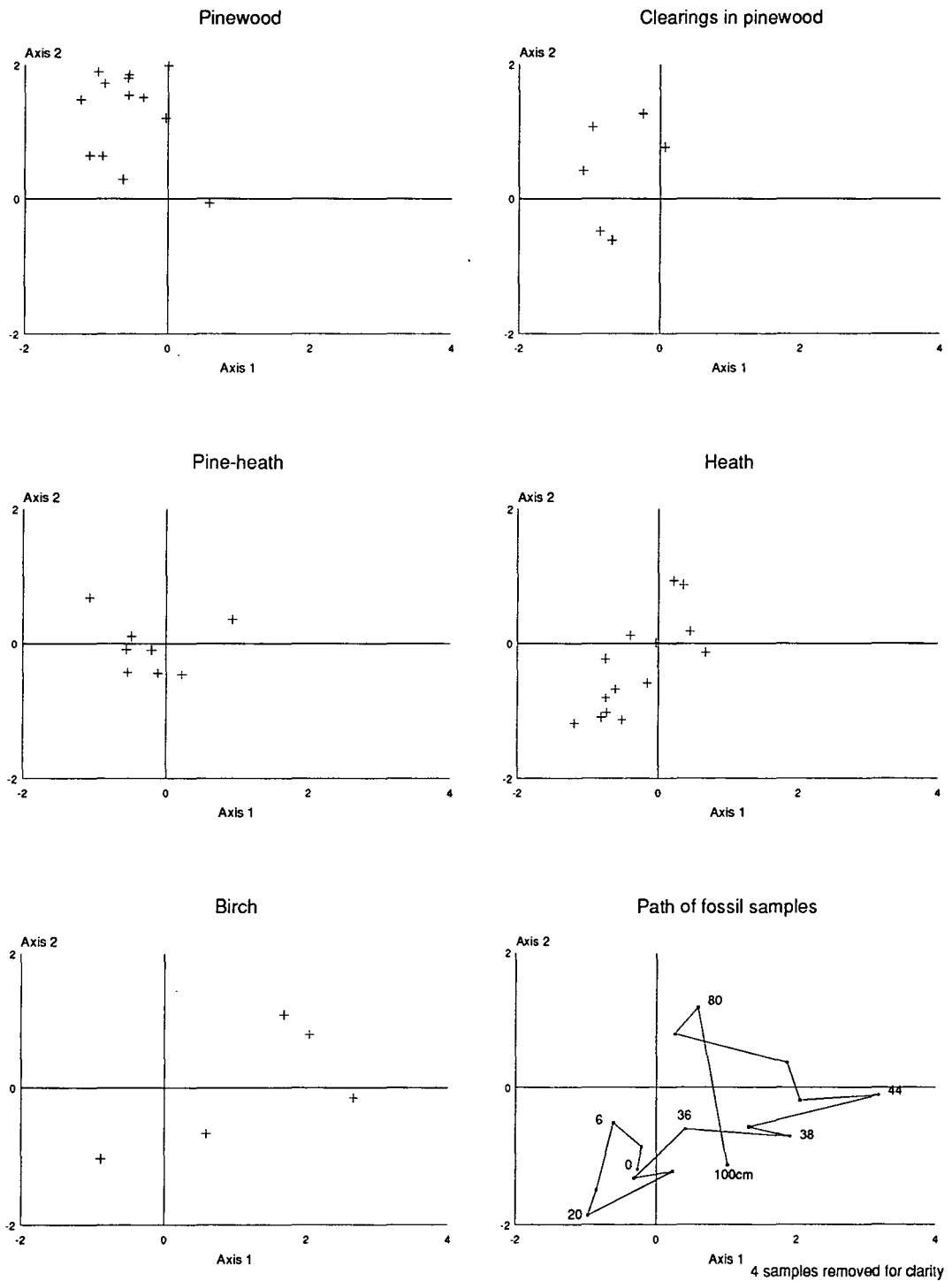

Figure 53b

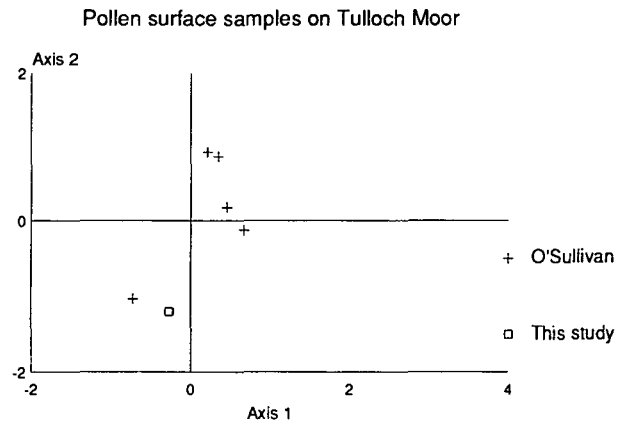

Figure 54

Arctostaphylos reference pollen  
Tetrad diameter (any orientation)



samples, and there were birch trees within 20m of the sample site in this study. The same evidence shows that pine has also increased over this period, and particularly in neighbouring areas through planting in Garten Wood, and on the western part of Tulloch Moor, but there were no pines of reproductive age within 50m or more of the sampling site.

- 4) The close relationship between *Betula* and Gramineae on the plot may reflect the ecological association between them described by Miles (1981).

A tentative reconstruction of the past vegetation at the following levels is offered.

100cm	Heath with birch
80-72cm	Pine-birch wood with <i>Calluna</i> on the mire surface and/or as shrub layer in the wood.
56-44cm	Birch-heath with some pine. Alder present, perhaps on mire edge. Grasses under the birch and some <i>Myrica</i> on the mire.
32-34cm	The vegetation is in the process of change, but at this time it passes through a phase in which it looks similar to the present.
20-10cm	Open heath. Few if any trees on the moor.
0cm	The present-day vegetation in 1989, i.e. heathland with scattered individuals and clumps of birch and less often, pine.

#### Ericales Pollen and Heathland History

##### Ericales reference pollen

There was some success in identifying ways in which to distinguish the pollen of the 6 species investigated, but this was not achieved in all cases.

Tetrad diameter measurements of *Arctostaphylos uva-ursi* are in Appendix 14. The size distribution is shown in Figure 54.

Also in Appendix 14, diameter at any orientation is compared with Oldfield's measurement D for 10 *Arctostaphylos uva-ursi* reference pollen tetrads and for 12 fossil pollen tetrads of unspecified identity, although none were *Calluna*. Although Diameter is not significantly different from D, the difference is not so small as to be negligible, and so the two sets of data could not be combined.

Results of examination of Ericales reference pollen tetrads are given in Appendix 15, and measurements are in Appendix 16. sample sizes are:

<i>Arctostaphylos uva-ursi</i>	30
<i>Erica cinerea</i>	25
<i>Erica tetralix</i>	30
<i>Vaccinium myrtillus</i>	20
<i>Vaccinium vitis-idaea</i>	20
<i>Empetrum nigrum</i>	20

Measurements D vs d are plotted in Figure 55, and the mean and 95% confidence limits for each species are plotted separately in Figure 56. From these small samples it appears that the measurements are useful aids for the identification of tetrads where  $D > 40 \mu\text{m}$  (*A. uva-ursi* and *E. cinerea*) or where  $D \leq 30 \mu\text{m}$  (likely to be *Empetrum nigrum*), but where D lies in the range 30 - 40  $\mu\text{m}$ , other methods are necessary. *V. myrtillus*, *E. tetralix*, and *V. vitis-idaea* are very similar in size and shape.

A one-way multivariate analysis of variance (MANOVA) using minimum Mahalanobis  $D^2$  was performed on the two measurements d and D for all the reference pollen tetrads. The results in the following table are expressed as variance ratios (f), and the probability (p) of achieving such a ratio by chance.

		<i>A.u-u.</i>	<i>E.cin.</i>	<i>E.tet.</i>	<i>V.myr.</i>	<i>V.v-i.</i>
<i>E.cin.</i>	f	61.4				
	p	0.00				
<i>E.tet.</i>	f	76.8	131.3			
	p	0.00	0.00			
<i>V.myr.</i>	f	33.2	83.4	4.3		
	p	0.00	0.00	0.01		
<i>V.v-i.</i>	f	77.9	131.2	1.4	7.9	
	p	0.00	0.00	0.26	0.00	
<i>Em.n.</i>	f	125.5	205.2	17.1	27.4	7.5
	p	0.00	0.00	0.00	0.00	0.00

In each case, except for *Erica tetralix/Vaccinium vitis-idaea*,  $p < 0.05$ , in other words the variance between species is greater than that within species. This means that samples of tetrads are distinguishable on the basis of the measurements d and D, although *E. tetralix* cannot be distinguished from *V. vitis-idaea*, and *E. tetralix* cannot be distinguished from *V. myrtillus* with such great confidence as the remainder. These results might be applied to identification of fossil pollen samples, for example

Ericales reference pollen measurements  
d vs D

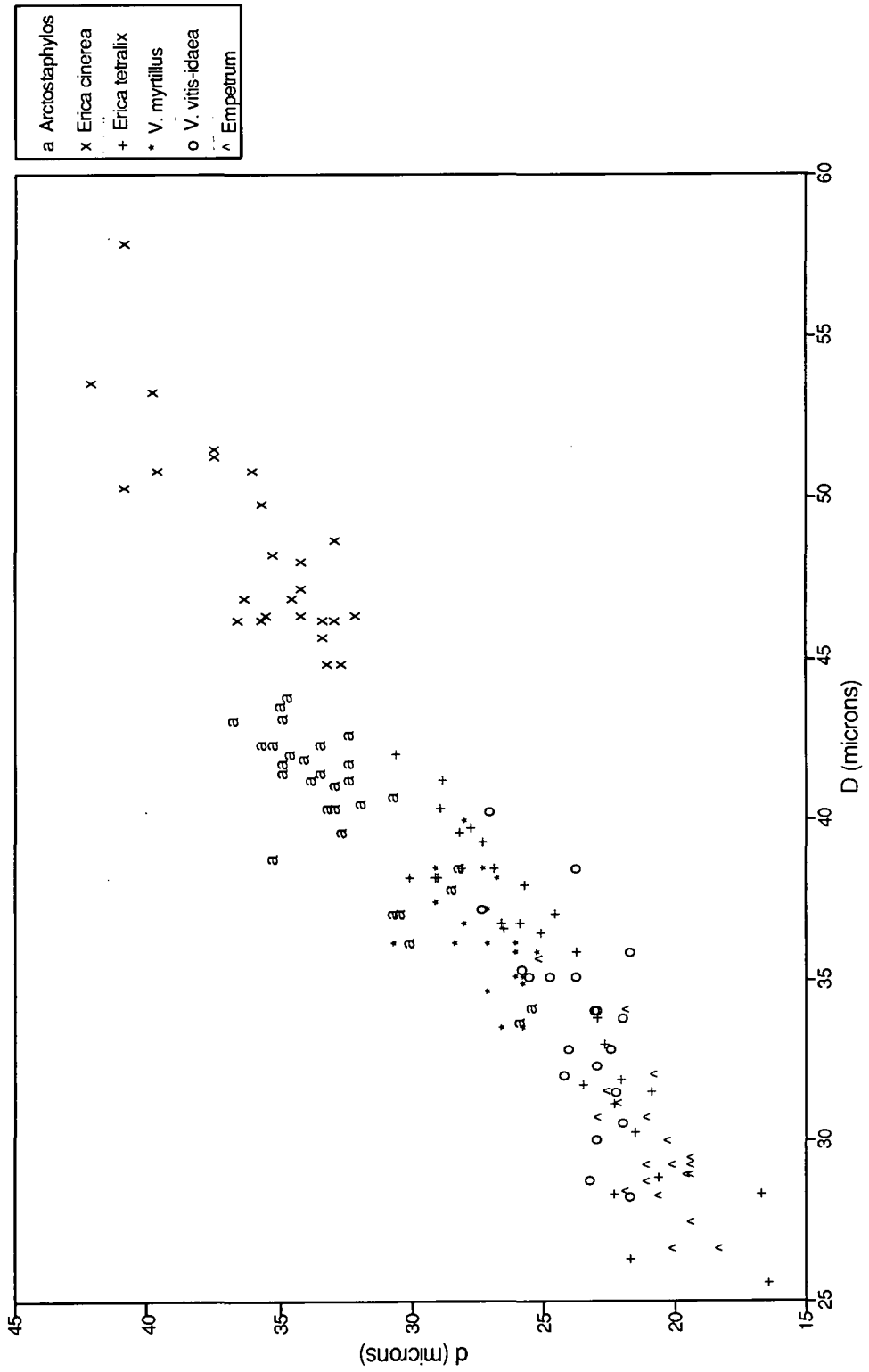
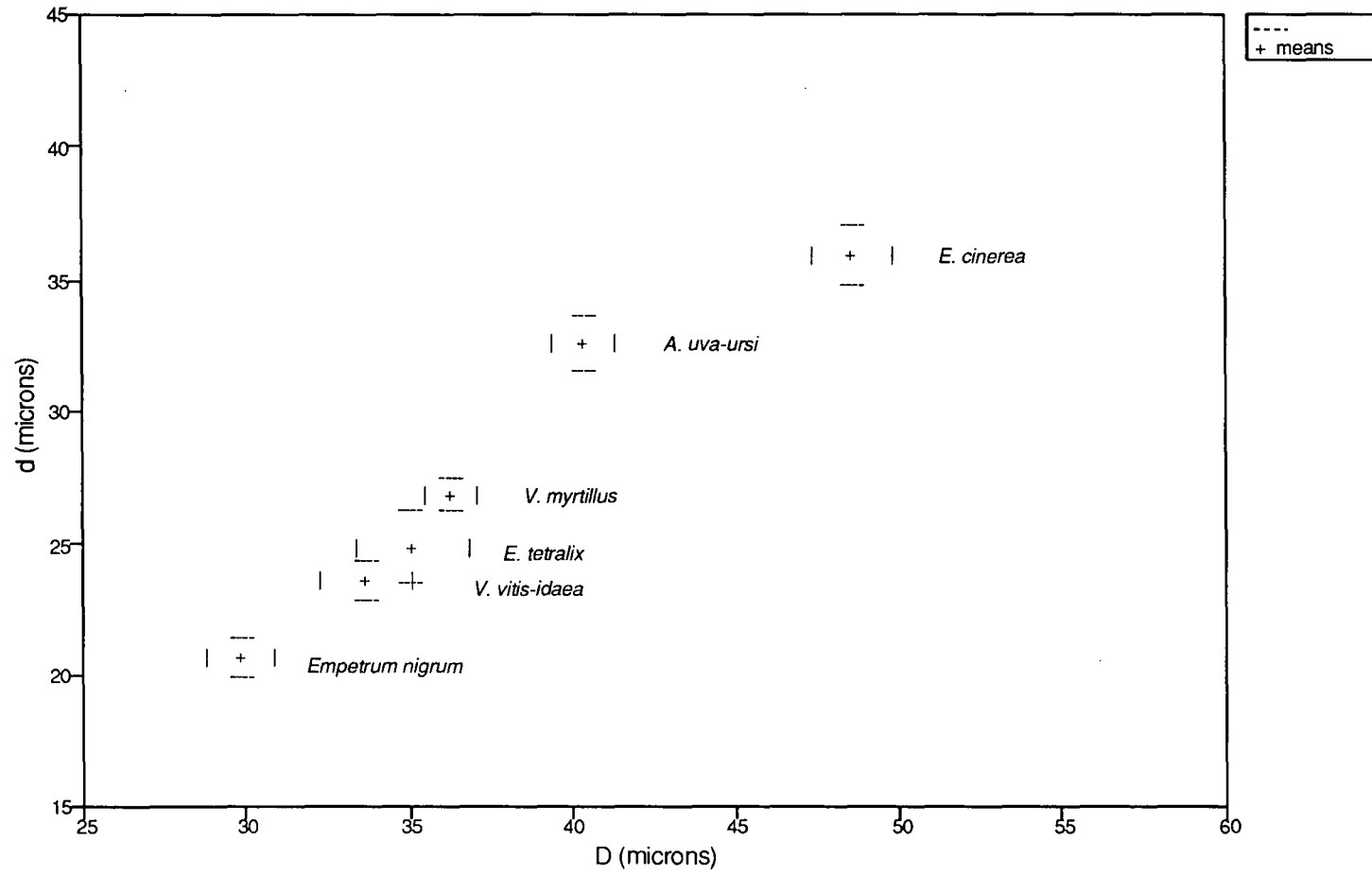

Figure 56

Ericales reference pollen measurements  
means and 95% confidence limits



where there is some independent evidence that a group of grains all belong to a single species, but this is not the case in this study.

Except for *E. cinerea*, for which D is greater, the mean for each species is less than that given by Oldfield (1959), but he does not give the standard deviation or confidence limits. The average difference, including *E. cinerea*, is 2.5  $\mu\text{m}$ .

#### Inflated tetrads

Some tetrads, especially those of *E. tetralix* appeared to be inflated or distended, or partially so. These are indicated by 'INF' and 'PI' respectively in Appendix 15. Canonical Variates Analysis (CVA) was used on D and d measurements of the Ericales pollen, and the Inflated tetrads may be compared with the Not Inflated ones in the plot of *E. tetralix* in Figure 57. CVA is described later.

The Inflated tetrads are separated from the others on the plot because they are larger. A t-test was used to compare the means of D for each group:

Means of Inflated vs Not Inflated tetrads of <i>E. tetralix</i>			
	Inflated	Not Inflated	
mean ( $\mu\text{m}$ )	38.4	30.0	p < 0.001
s.e.m.	0.46	0.75	

This variation causes the standard deviation of D and of d for *E. tetralix* to be greater than for the other 5 species (see Appendix 16), and therefore also the 95% confidence limits of the means (see Figure 56). If this variation were removed, there would be a greater chance of distinguishing *E. tetralix* from the 2 *Vaccinium* species in the MANOVA above.

The cause of the difference is not known, but it may be that because both new unopened and open flowers were used, some of the tetrad walls were incompletely developed, and this would probably cause a difference in response to the pollen preparation process. Time did not allow for experimental investigation of this problem.

Figure 57

Comparison of inflated & non-inflated  
*Erica tetralix* tetrads on CVA plot

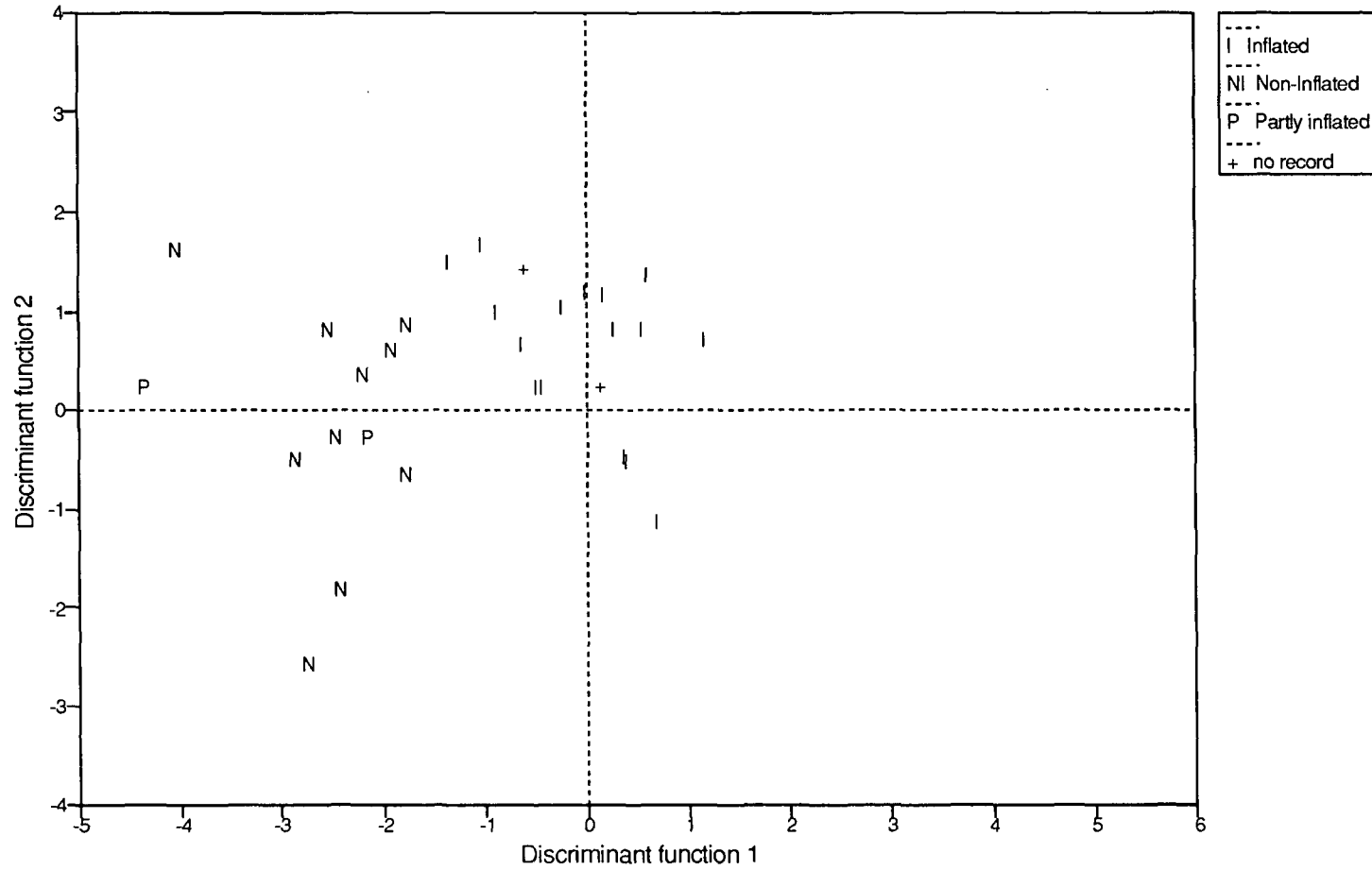

## Canonical Variates Analysis (CVA)

This is a useful technique for the simultaneous analysis of several measurements on a number of individuals, and is particularly appropriate where a series of unknown individuals are to be compared with, and identified on the basis of measurements of known reference samples.

Results of CVA on measurement D and d from reference pollen tetrads are plotted in Figure 58.

The relationship between each of the Discriminant Functions 1 and 2 may be seen in the following table.

	Function 1	Function 2
d	0.99	-0.15
D	0.90	0.43

From the plot it appears that this multivariate technique is hardly, if any more successful at separating the species than the scatterplot of the original measurements in Figure 55. This was confirmed by using the Discriminant Functions to re-classify the reference tetrads as if they were unknowns:

	Correctly classified	Mis-classified	Total
<i>Arctostaphylos uva-ursi</i>	26	4	30
<i>Erica cinerea</i>	25	0	25
<i>Erica tetralix</i>	5	25	30
<i>Vaccinium myrtillus</i>	11	9	20
<i>Vaccinium vitis-idaea</i>	9	11	20
<i>Empetrum nigrum</i>	18	2	20

CVA would probably be much more powerful here if there were more than 2 measurements on each tetrad. Time and orientation did not allow additional measurements, eg. furrow length (2f), to be made on the same tetrads from which D and d were taken.

### Discrimination of Ericales pollen with CVA + other characters

Although CVA itself was not especially successful, the scatterplots are used to display the results of using a selection of the other characters given in Appendix 15, to discriminate between the tetrads of the 6 species. See Figure 59.

### Ericales fossil & surface pollen

This part of the study was unsuccessful, i.e. it did not produce any useful information about the history of the heath vegetation. *Erica tetralix* pollen in the peat is presumed to have come from plants growing on the bog surface.

Figure 58

Canonical Variates Analysis of Ericales  
reference pollen measurements

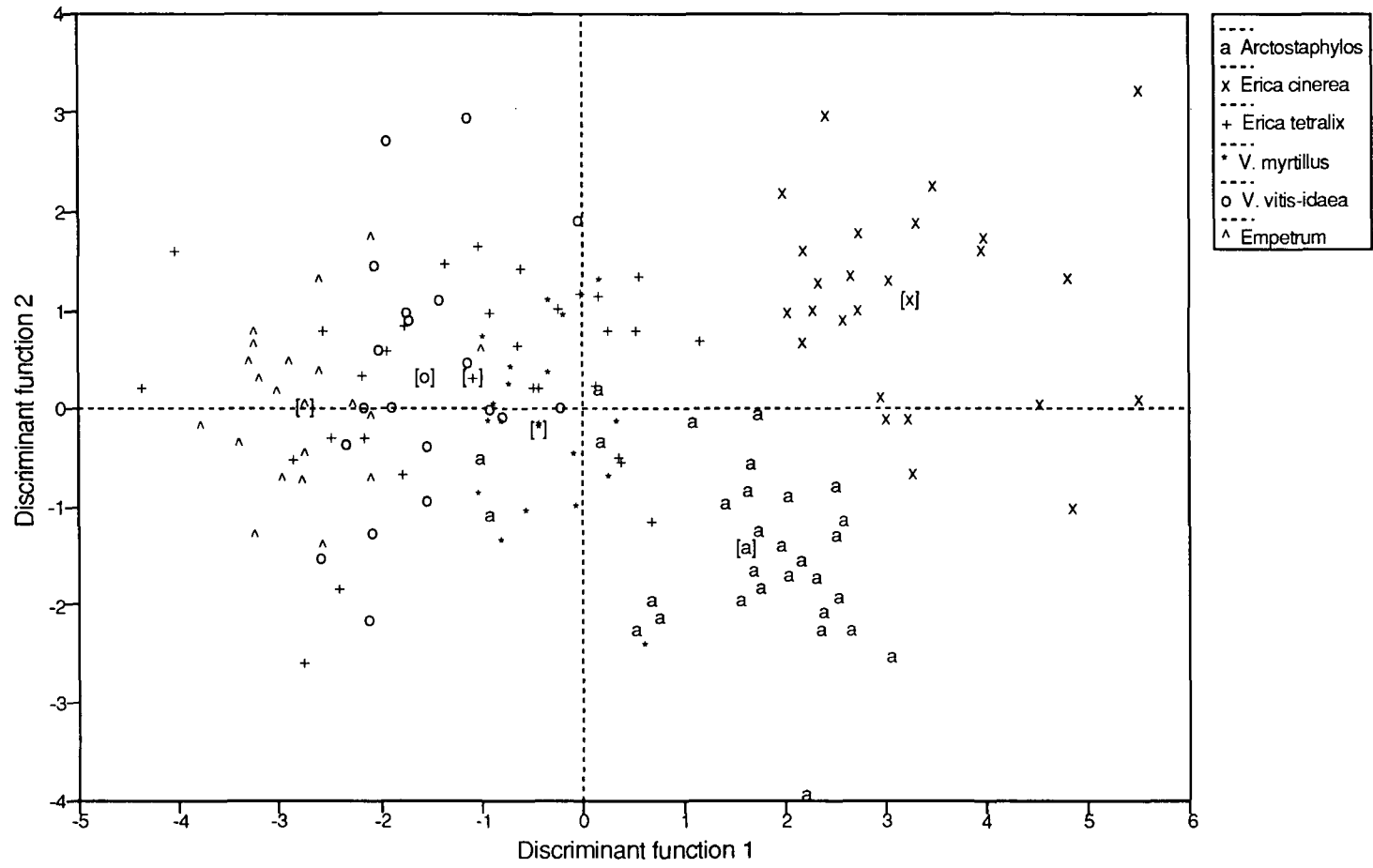

[ ] = means

Figure 59

Characteristics of Ericales reference pollen tetrads on CVA plot

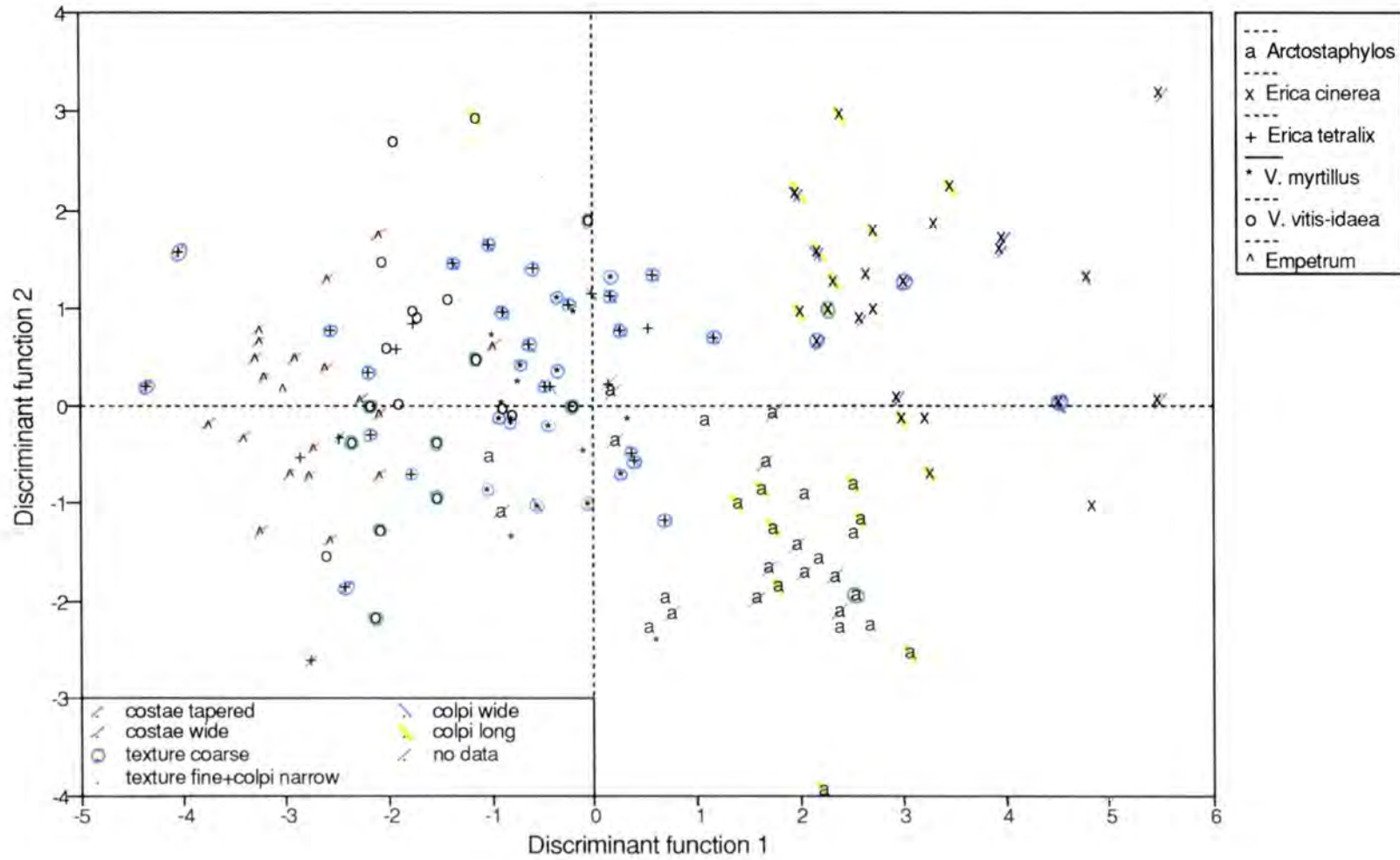
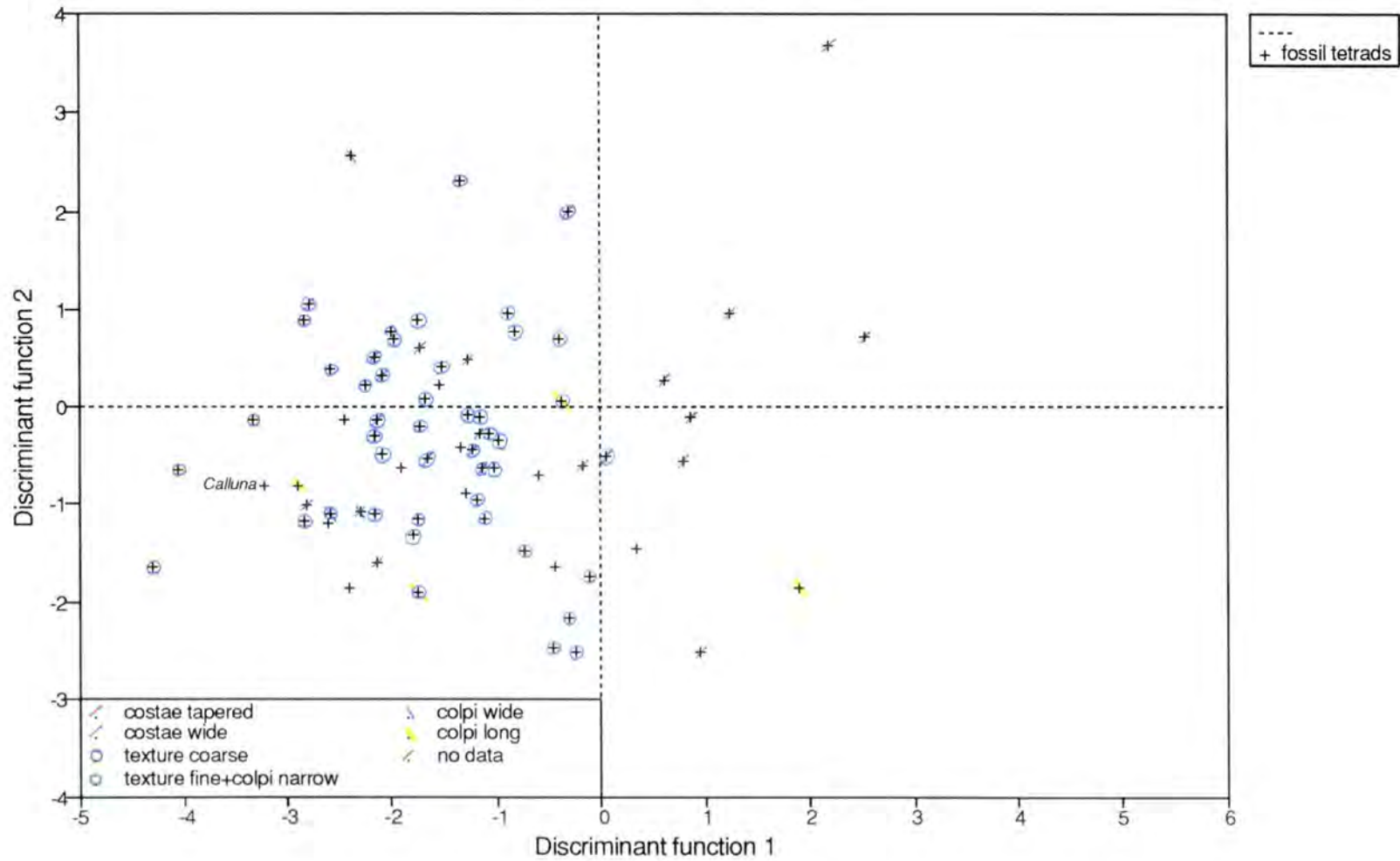

Figure 60

Characteristics of Ericales fossil pollen tetrads on CVA plot



In this section fossil & surface pollen tetrads will be referred to as fossil tetrads. Details of the best preserved tetrads are given in Appendix 17, and measurements in Appendix 18. Three different methods were applied to identify these tetrads, as follows:

- 1) Initial inspection
- 2) Canonical Variates Analysis
- 3) CVA + other characters

The identity of each tetrad resulting from each method is given in Appendix 19, together with the identity used in the final diagram. Different identities often occur for any given tetrad. The results of CVA are expressed as the Highest Probability Group, that is the likeliest species to which the unknown tetrad may belong. Given the large number of mis-classified cases when the reference tetrads were treated as unknowns, many of the fossil tetrads are likely to have been mis-identified by CVA.

The use of CVA + other characters was applied to fossil tetrads in the same way as to the reference material (see Figures 60 and 59) Two fossil tetrads clearly lie within the compass of *E. cinerea*, and one or two within that of *A. uva-ursi*. Several doubtful cases lie in the vicinity of these species, but are not easily identified. In the fossil pollen there is a preponderance of tetrads in the *V. vitis-idaea*-*E. tetralix*-*V. myrtillus* size range, although the majority are smaller (to the left) of *V. myrtillus*. Most are coarse-textured, and none for which the data exist exhibit the combination of fine texture + narrow colpi which distinguishes about half of the *V. vitis-idaea* reference tetrads. It is likely, therefore, that the majority of this group belong to *E. tetralix*, although some may be *V. myrtillus* or *V. vitis-idaea*. A more detailed, stepwise version of this graphical technique produced similar results. Attempts to produce a key proved largely unsuccessful, and I consider that further effort would not be justified on this data set.

Occurrence of Ericales pollen as identified after further analysis (AFA) is given in Appendix 20. Occurrence of the non-*Calluna* Ericales pollen as identified by inspection, and then after further analysis, is shown on the Ericales Pollen Diagram in Figure 61. "Ericales others" is the same taxon as used on the earlier pollen diagram. *Arctostaphylos uva-ursi* is rare and does not occur below 3cm. This result is disappointing but not surprising because this is an insect-pollinated flower and the fossil pollen is dominated by wind-pollinated plants. It is possible that this plant has only appeared very recently in this part of the moor, but there is some circumstantial evidence to the contrary found by O'Sullivan (1973c), viz:

- 1) *Arctostaphylos* pollen occurred in 5 out of 8 mor humus profiles from Abernethy Forest, including one by Loch Mallachie

Figure 61

Ericales pollen diagram

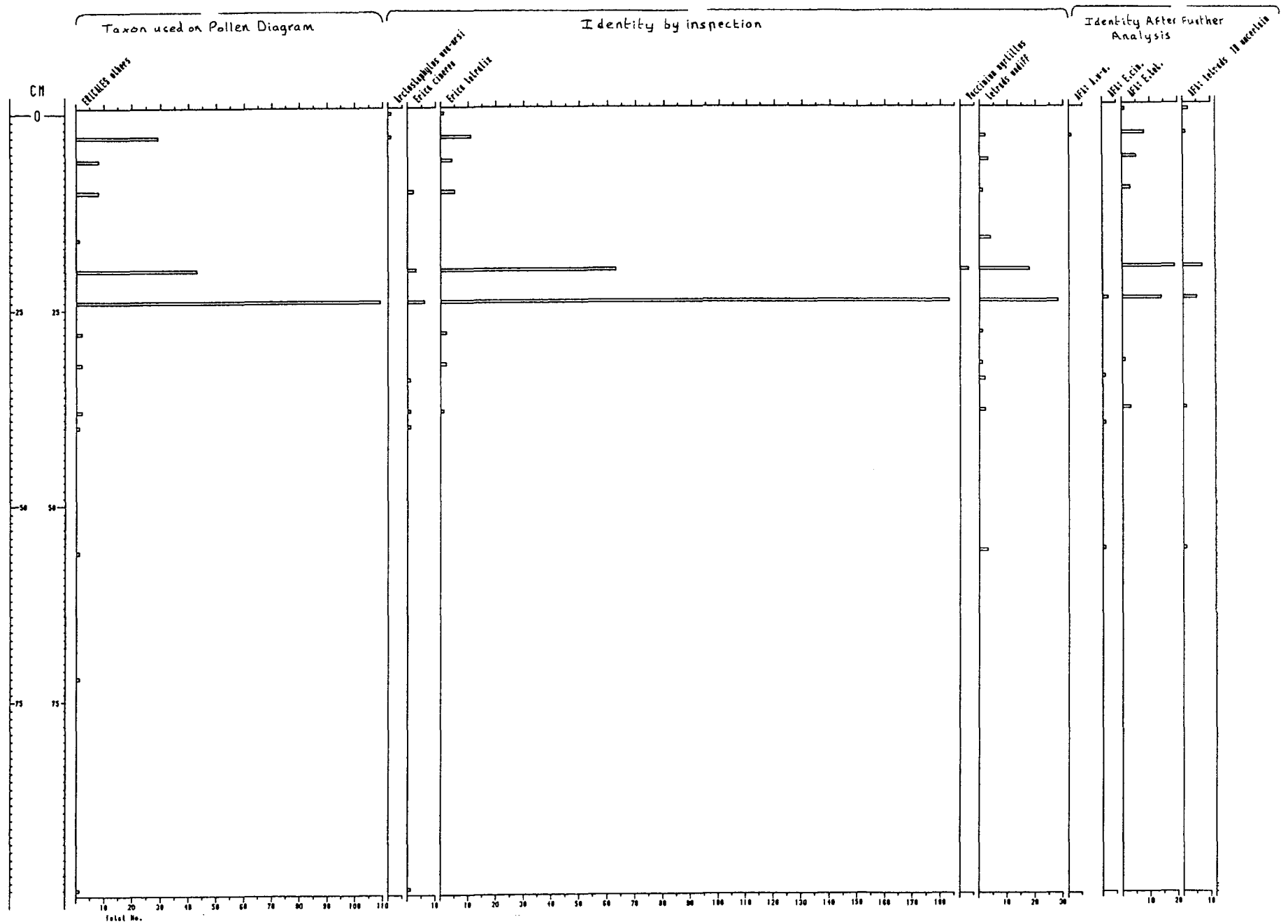

TULLOCH MOOR R. ASCROFT 1989 - ERICALES SHRUB POLLEN

- 2) *Arctostaphylos* pollen occurred below radiocarbon dated layers as follows:
- |                    |             |
|--------------------|-------------|
| Carn a' Chnuic I   | 1035 ±70 BP |
| Carn a' Chnuic III | 1340 ±70 BP |
| Ryvoan Pass        | 1425 ±70 BP |
- 3) At Carn a' Chnuic I there is an almost continuous record of *Arctostaphylos* spanning about 1000 years
- 4) At at least 3 of the sites, *Arctostaphylos* has either survived a woodland phase, or re-colonized afterward.

The obvious scarcity of non-*Calluna* tetrads below 24cm may also be because trees and *Calluna* tend to dominate the pollen rain or deposition, and so the less abundant or less prolific dwarf shrubs show up near the woodland minimum, but they are only prominent when not swamped by *Calluna*.

The profile of "Ericales others" is much the same as that shown by *E. tetralix*, as identified by inspection. In some cases totals for the latter are greater, and this is because slides were scanned for more tetrads after pollen counting was finished. The similarity of this *E. tetralix* profile and that for "tetrads undiff." suggests that the majority of the undifferentiated tetrads are also *E. tetralix*. The profile under "AFA: E.tet." appears slightly different, but given that fewer tetrads from 24cm than from 20cm were given further analysis, *E. tetralix* exhibits the same pattern again here. Apart from *Calluna*, this is the commonest species of Ericales on the monolith surface, and on the peat bog around the sample site (see relevés 113 to 115 in Appendix 9). *Empetrum nigrum* is also present on the peat-bog, and its absence from the pollen record is surprising.

Direct evidence of the history of *Arctostaphylos* on Tulloch Moor remains that in O'Sullivan's (1973c) mor humus profile from near the Loch Mallachie outflow at NH 972 163. Samples in the lower zone of this profile are unusually high in *Arctostaphylos*, and also rich in species of other Ericaceae and herbs which are associated with *Arctostaphyleto-Callunetum*.

#### Charcoal and Fire History

Charcoal evidence indicates a history of fires on the sample site and in the surrounding area. There is evidence that at least some fires have been accompanied by a change in the vegetation, and especially by a decline in trees.

Numbers of charcoal particles in the peat samples from 3 to 100cm depth are given in Appendix 21. The data from profile A are displayed in the Charcoal Diagram in Figure 62. In the diagram values have been adjusted by scaling factors (sf) for convenience.

Figure 62

# TULLOCH MOOR - CHARCOAL PARTICLES Scaled values

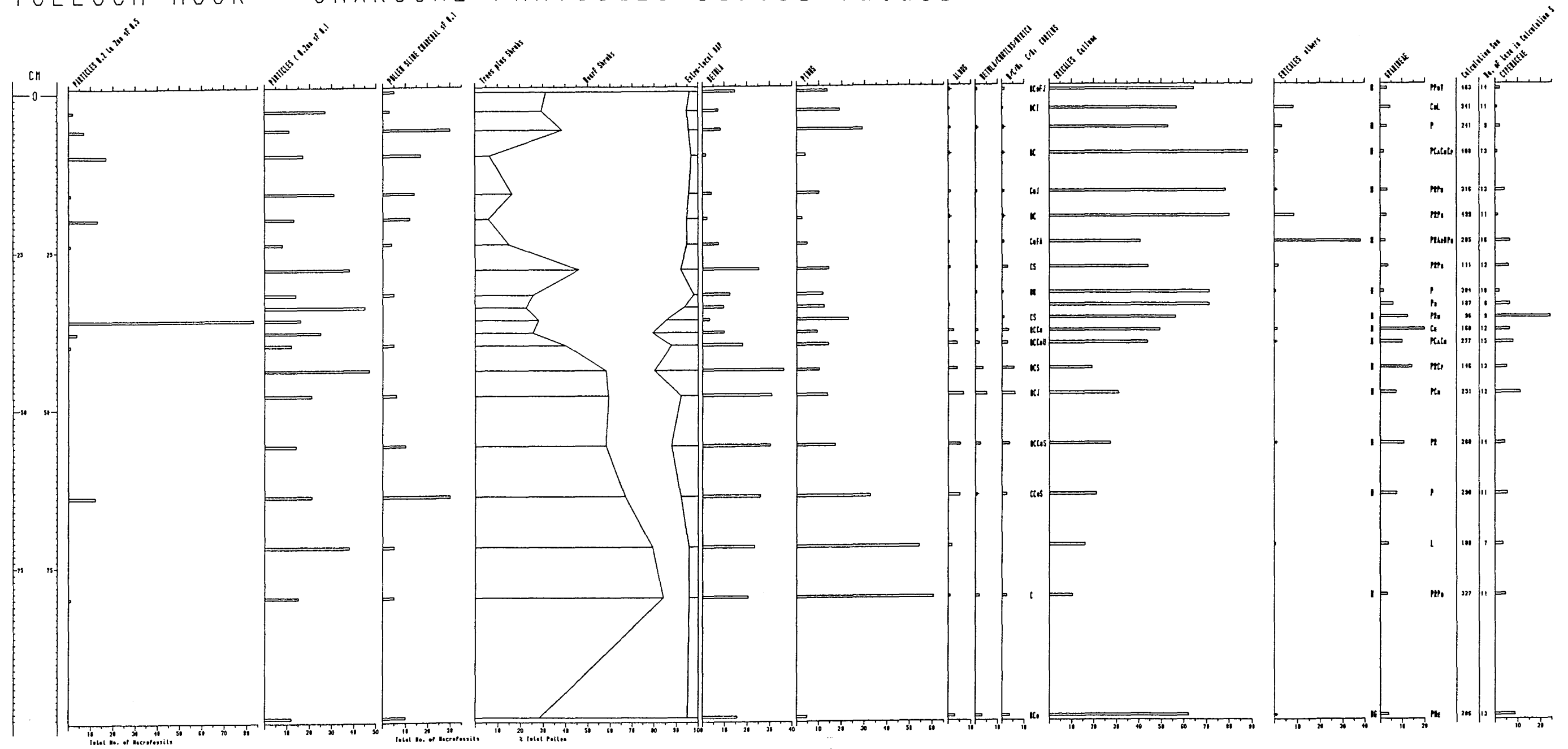

## Particle size and source area.

There were no particles larger than 2.0mm. This is almost certainly the result of mechanical breakdown of larger particles when peat samples were stirred and disaggregated on the sieve. The three types of particles on the diagram show very different patterns. This feature was also observed by Gear (1989) and is attributable to differences in the source area. According to Clark (1988 a & b) pollen slide charcoal comes from a sub-continental to global source area and may be ignored, but Simmons and Innes (1988) considered that the presence of pollen slide charcoal indicated fires within the region of their study site on the North York Moors. In this study, the size of pollen slide charcoal was limited by a sieve mesh size of ca. 214 $\mu$ m, but most particles on the slides were much smaller than this. Medium-sized particles (0.2 to 2.0mm) are mainly local in origin, and indicate local fires. The prominent peak at 36cm coincides with a dark band across the peat monolith, and is presumed to be the result of a substantial fire which included the sample site. Small particles (<0.2mm) are mostly larger than pollen slide charcoal which is limited by the sieve mesh size to less than 60 $\mu$ m, and unlike the medium-sized particles (0.2-2.0mm), they occur at all the levels sampled. This difference would be expected if the small particles originate from a regional catchment, given that in this region fires are, and have been, common. Small particles are present when local fires take place, but do not show a peak because most of them are convected away from the fire (Clark op. cit.). Theoretical predictions by Clark (1988 a) indicate that in light winds the radius of the principal charcoal source areas would be as follows:

		Particle size	
		Small	Medium
		0.02-0.2mm	0.2-2.0mm
Smoke	10m	100m	50m
plume	100m	1500m	500m
height	1000m	20km	7km

These figures are consistent with the view that at least some of the peaks in small particles represent fires on Tulloch Moor. Secondly, if they do apply, neither the small nor the medium-sized particles from nearby dwellings, the school, or past lime kilns will have significantly affected the results.

## Fire and vegetation history

Fire may affect trees by:

- Destroying mature trees (forest fire)
- Preventing regeneration (eg. frequent muirburning)
- Promoting regeneration (eg. occasional muirburning)

Local fires at 56 and 36cm are each followed by a drop in pine pollen, but not at 20 and 10cm. The decline in pine began well below 56cm, so if these were cause and effect, then this was part of a larger process. The brief peak in pine pollen at 36cm is likely to have been caused by a local

clump of trees, which could have been destroyed by this intense local fire. At 10 and 20cm tree pollen was already very low, and the fires were probably muirburns. There is no unequivocal evidence that peaks in Gramineae pollen are caused by fire, but the present record is not a continuous history, and so important fires or responses may have been missed. The peak in Cyperaceae at 36cm may be attributable to an increase in *Eriophorum* and/or *Trichophorum* on the bog surface following burning of *Calluna* in the fire at this level. Conversely, at 28 and 44cm when *Sphagnum* spores peak, there are no local fires, and this may be the result of wetter conditions, eg. raised water levels through impeded drainage. Peaks in the number of small particles at 72, 44, 28, and 16cm are each followed by a decrease in Trees+Shrubs pollen, and this may reflect the destruction of trees by fire. If so, the catchment area for small charcoal particles overlaps with the tree pollen catchment, but is not the same.

#### Value of the Peat Sampling Site

The basin from which the peat sample was taken is one of the few, if not the only area, of uncut peat on Tulloch Moor. The present study has far from exhausted the potential for useful study at this site. The existence of radiocarbon-dated pollen diagrams and other local background information greatly aids interpretation of fossil material and increases its value.

#### Juniper Ring Counts

The centre of section 3 was decayed and so the age is approximate.

Section No.	Ring Count	Year
1	93	1896
2	51	1938
3	108	ca.1881
4	101	1888

Section 3 was asymmetric and appeared to have been damaged on one side in the early part of its life, but the cause was not evident.

## Discussion

Trees and bushes along the roadside in the area which these juniper stems came from are visible in each of the aerial photographs back to 1948. Such vegetation is absent from this part of the six-inch O.S. map from 1874, although the map shows small clumps of trees and/or bushes in other places which are visible on the 1948 photograph. This indicates that these junipers were pioneers and not the offspring of bushes in the same locality, and this is also consistent with heavy grazing in the late 18th Century (see Historical & documentary evidence below). Since then, the survival, growth and spread of juniper on Tulloch Moor from ca.1881 to the present indicates that browsing, although present, has not been intense over this period.

Juniper (*Juniperus communis*) can survive fire, but is often killed by it, and this factor may determine its distribution on a local scale (Diotte & Bergeron 1989). It is likely that this part of Tulloch Moor, i.e. the roadside east of NH 967 162 has not been burned since 1881, whereas, from the aerial photographs, the area just to the west was burned between 1948 and 1961 (see Vegetation changes seen in aerial photographs). These findings correspond to the greater abundance of juniper in the eastern half of the vegetation transect mentioned in the last chapter.

## Historical Ecology

### Historical & documentary evidence

This section summarises evidence, such as not already mentioned, from the sources indicated and chiefly relates to the last 250 years. Many possible sources of further information were not consulted.

Cartographic evidence collected by O'Sullivan (1973 b) shows that Tulloch Moor has been open ground, i.e. not afforested since at least 1750. Grant (1799) describes excess grazing caused by sheep in addition to cattle in the parishes of Abernethy & Kincardine. Although Tulloch Moor is not mentioned specifically, as an area of common grazing it seems likely to have been affected, and if so this will have inhibited the natural regeneration of trees and shrubs. O'Sullivan uses William Johnson's map of 1830 to show that Abernethy Forest was at its minimum extent at this time, and other documentary evidence indicates that this was followed by extensive replanting. The northern part of Garten Wood is drawn on William Brown's plan of Abernethy from 1858 (O'Sullivan (op.cit.)), and the present-day outline is clear on the 1874 O.S. six-inch map. This map shows the central part of Tulloch Moor was devoid of trees, but there were substantial areas of deciduous woodland (presumably birch) around Tomgown (Tomnagowhan) and Delbog, and scrub on the peat-bog between Inchdryne and Loch Mallachie. Garten Wood, and each building

and field adjoining the Moor is shown surrounded by a fence or wall, indicating that livestock were present on the Moor.

Grant (op.cit.) mentions local peat-cutting for fuel. Tulloch Moor is marked as an extensive peat moss on the 1830 map mentioned above. The 1874 O.S. map does not distinguish between peat-bog and heath, but it shows at least 6 separate tracks into areas where there are now old peat cuttings. Mr. Hamish Gordon of Mains of Tulloch, who currently cuts his peats on the moor, told me that peat-cutting had been more extensive in the past, and involved people from communities outside Tulloch. Comparison of the 1874 map with the 1973 1:10,000 map or with the evidence on the ground shows that most of the old peat-tracks are disused and the network of paths over the moor which connected dwellings and other buildings has given way to the road and farm-tracks for motor vehicles. Although only sheep are grazed on the moor at present, Mrs. M.Dennis told me that both cattle and horses were grazed on the moor in the past, up to the 1950's and 60's.

#### Vegetation changes seen in aerial photographs

Coverage used:            1948  
                                 1961 (western part only)  
                                 1966  
                                 1978

Further details in List of Maps & Aerial Photographs.

#### Transect

The 4 permanent plots in the western part of the transect contain more grasses & herbs and less juniper than those in the eastern part. In the 1966 picture, there is evidence that part of this area was burnt more recently than the rest. This vegetation boundary is not visible on the 1948 picture, and had almost disappeared by the time the 1978 photograph was taken.

#### Plots 105 & 106

The boundary between these 2x2m plots on the 1978 picture, attributed to more recent burning on the 105 side, is obvious on the 1966 and 1961 pictures but not in 1948.

Woodland next to south end of Garten Wood.

There has been an increase in the size, number, and extent of trees in most parts of Tulloch Moor. This area was selected because there is a clear progression from open heath to woodland over the period of the photographs.

Southwards extent of bush-sized plants (m) from the boundary of Garten Wood.		
	West of path	East of path
1948	50	45
1961	150	60
1966	200	70
1978	350	200

Minor differences of scale between pictures are neglected

In 1948 the heath is open with 3 trees of canopy width  $\geq 3\text{m}$  and a scatter of bush-sized plants just tall enough to cast a shadow. The path to Knock of Kincardine & Mullingaroch is clearly visible.

In 1961 the 3 trees are larger and plants which were bush-sized in 1948 are approaching tree-size. The number of bush-sized plants has increased, both in density and extent.

In 1966 The original 3 trees bear substantial canopies. Over an area of about 1 ha, trees that were bush-sized in 1948 have developed crowns that are beginning to coalesce, and these are beginning to obscure the path in one or two places. In this area, between 1 and 2 ha of heath is peppered with bush-sized young trees.

In 1978 The crowns of trees have coalesced to form a woodland of about 4 ha, although this is more open towards the south. This woodland is now continuous with a fringe of woodland which has grown up along the eastern boundary of Garten Wood. It is also beginning to coalesce with new trees on the ribbon of peat-bog to the west. The path is still visible across the heath, but in the wood a stretch is now obscured by trees, although part of its course follows a short avenue. Beyond the woodland, bush-sized trees now extend southwards as far as trees which were isolated in 1948. Over the rest of the moor there are numerous other areas with young trees which have grown up around parents which were small clumps or isolated individuals in 1948.

#### Local archaeological & historical sites

Sites close to Tulloch Moor are shown on Figure 63. No proper search was made of the literature on ancient monuments, archaeological sites or finds of artefacts. Furthermore, there is no direct evidence which links the sites shown with the vegetation on Tulloch Moor.



Figure 63  
 Archaeological Sites Near Tulloch Moor

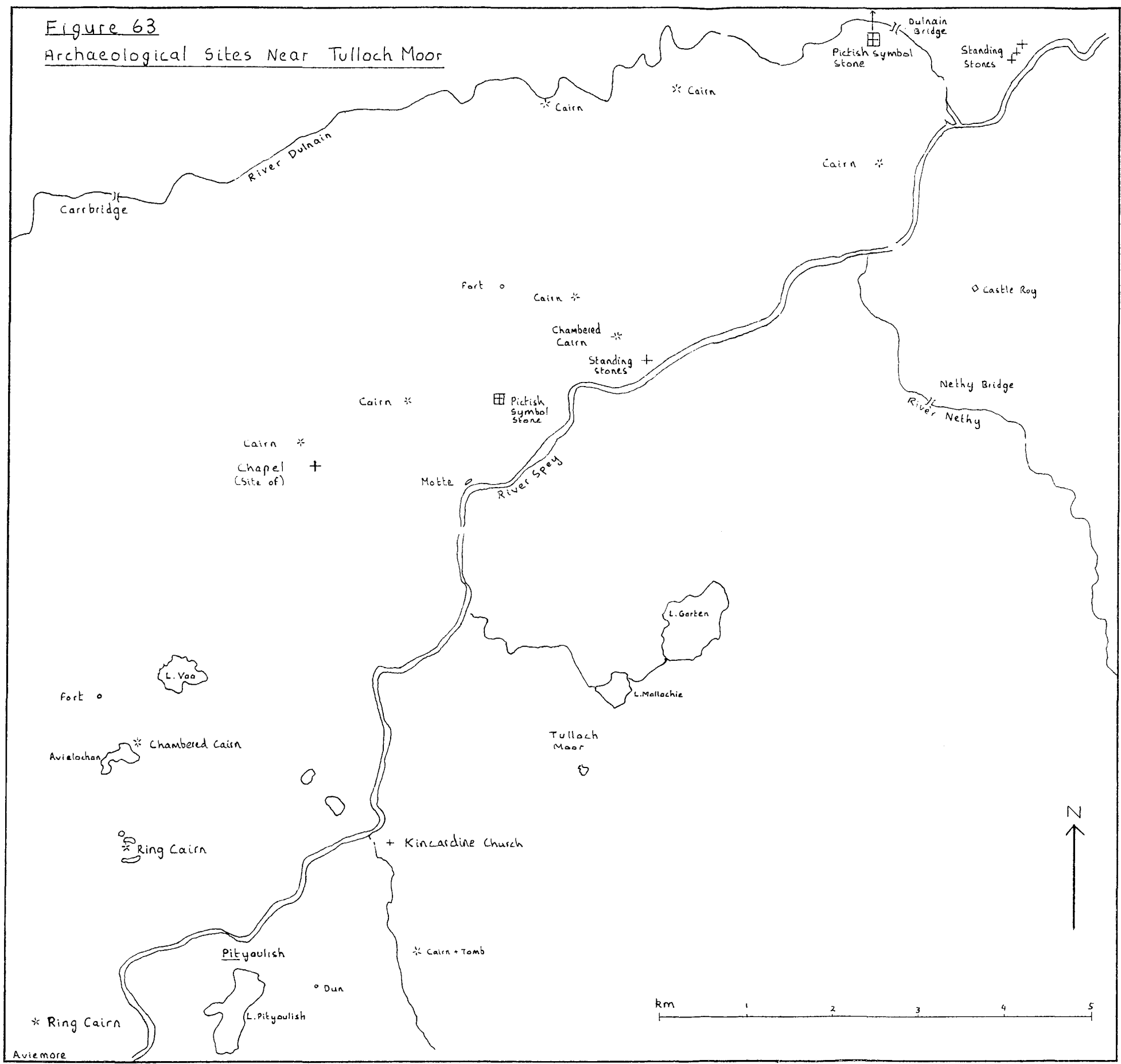

Sources

- Feachem (1963)
- Jackson (1984)
- RCAHMS (unpublished)
- Ordnance Survey 1:50 000 (1986)
- Ordnance Survey 1:25 000 (1982)

The sites in Figure 63, and several others just outwith the area shown, indicate local human presence since the Neolithic. This presence may not have been continuous, but it is clear from the number and size of each of these features that people have been present and probably resident in the locality in sufficient numbers to affect the vegetation.

In her comprehensive work Henshall (1963) lists the following sites in this area:

Avielochan	NH 908 167	Clava passage-grave + smaller cairn adjacent
Aviemore	NH 896 134	ring cairn + stone circle
Delfour(Alvie)	NH 844 085	ring cairn + one standing stone
Grenish	NH 907 154	ring cairn + stone circle + many small cairns to west
Tullochgorm	NH 965 214	? Clava passage-grave + probably had a stone circle

Burl (1976) states that the combination of tomb + ring-cairn + stone circle is peculiar to the Clava group (named after the site at Balnuaran of Clava, Inverness-shire), and he considers (Burl 1983) that among the stone circles, these are early types. He quotes the mean of 3 radiocarbon dates from the very large passage-grave + stone circle at Newgrange, Co. Meath as 3250 BC.

In addition to those mentioned, there is a cairn near Speybridge at NJ 046 258. Close-Brooks (1986) identifies the ring cairn at Aviemore with the Clava Cairns which she says are attributed to the very late Neolithic, but she states that there is no secure dating evidence. Thom (1967) gives a list of megalithic sites in Britain which includes stone circles around the some of the cairns already mentioned, and also the following standing stones:

Dulnanbridge	NJ 011 246
Boat of Garten	NH 967 210

Mrs. Dennis told me of Bronze age graves at Delbog, and the 1874 six-inch O.S. map marks a stone coffin with human remains, presumably a cist burial, with a cairn near Milton NH 942 144. In their list of Bronze Age dress fasteners Hawkes & Clarke (1963) mention a gold one from Cromdale, Inverness-shire. The settlement at Tullochgrue NH 914 087 may also be of this period.

Many hill forts are associated with the Iron Age (Megaw & Simpson 1979). Feachem (1963) lists the site above Avielochan with the many other typical hill forts, and he separates these from the smaller duns, such as the dun on Creag Phitiulais.

Pictish symbol stones: Jackson (1984) distinguishes between early Christian monuments and pagan symbol stones which, where intact, have symbols in pairs. He lists the stones, and those local to the study site are at: (PTO)

NJ 058 262	Congash 1
NJ 058 262	Congash 2
NJ 026 260	Inverallan
NJ 049 288	Grantown
NH 994 254	Findlarig
NH 951 206	Lynchurn
NH 821 048	Dunachton

Jackson places the period of Pictish monumental sculpture between ca.683 and ca.842 AD, but he gives the much shorter period of ca.693 to ca.728 AD for the so called class I stones which have incised figures only, and this includes all those in the above list. Nicolaisen (1976) associates place-names containing Pit- with the Picts or with Pictish influence on Gaelic names persisting some centuries after the Picts were defeated by the Scots under Kenneth MacAlpin in 840. Apart from Pityoulish, local examples are Tom Pitlac (NH 947 197) and Pitmain Farm, Kingussie. He also associates the Aber- prefix with P-Celtic languages i.e. Pictish and Cumbric, and a greater number of examples, such as Abernethy, lie in the Pictish region.

Apart from the precursor to the present Kincardine Church mentioned earlier, there are chapel sites at Deishar (NH 930 198) and Chapeltown (NH 977 156).

## CONCLUSIONS

- 1) The evidence from the present-day vegetation, and from the peat profile indicates the importance of fire in the past and present vegetation of the moor. Fire was probably the principal agent in the creation of the present phase of heath.
- 2) The present phase of heathland was preceded by pine-birch forest.
- 3) There was an earlier phase of heathland, but the circumstances of its origin are unknown.
- 4) There is purely circumstantial archaeological evidence that the first heathland phase may have been anthropogenic (caused by humans).
- 5) The current trend in the spread of birch, pine and juniper probably began in the last century, despite the presence of sheep, and sometimes cattle and deer.
- 6) The herb-rich areas of *Calluna-Arctostaphylos* heath are among the best examples on record.
- 7) Parts of the heath are more herb-rich than others, and the amount or area of herb-rich heath is less than the extent of *Arctostaphylos*. *Pyrola media* is particularly restricted.
- 8) Patchiness in the heath probably relates to stand age and soil type.
- 9) Most *Arctostaphylos* tetrads may be distinguished from other Ericales pollen, but it does not travel far enough from its source to be represented in peat deposits except occasionally.
- 10) Evidence from the literature indicates that *Arctostaphylos* heath was present on Tulloch Moor by early in the last century, and has been in Abernethy for at least the last 1400 years (O'Sullivan 1973c).
- 11) There has been a long history of peat-cutting, since at least the 18th century. The area of uncut peat at the site used is valuable for further study.

## POSSIBLE FURTHER STUDIES

- 1) A radiocarbon-dated pollen and charcoal diagram from the same site, extending to the base of the peat, to determine when the first heathland formation on Tulloch Moor began, when fires began, and whether these were at the same time.
- 2) Pollen and charcoal diagrams at close (eg 2 or 3mm) sampling intervals and sampled continuously over the sections where there is existing evidence of fire causing vegetation change. This should reveal whether the change was caused by fire, or related to fire frequency.
- 3) Examination of existing slides/residues of fossil pollen for cereal grains. Sampling + radiocarbon dating of new peat core if indicated. Sampling & pollen analysis of Gauld's (1982 & unpublished) "old cultivated horizon" if possible.
- 4) Mapping of heather stands from the most recent aerial photographs, and determination of the approximate age of each stand from earlier aerial photographs, counts of rings in *Calluna* stems, and information on recent burning by the RSPB from the Warden.
- 5) Quadrat-sampling of vegetation in each heather stand as mapped in (3) above + mapping of herb-rich stands. Prediction of the future floristic change and development of the stand if it were burned, on the basis of work by Hobbs & Gimingham (1984 et seq.) at the Muir of Dinnet.

## REFERENCES

- BENNETT K.D. (1984) The post-glacial history of *Pinus sylvestris* in the British Isles. *Quat.Sci.Rev.* **3**: 133-155
- BIRKS H.H. (1970) Studies in the vegetational history of Scotland I. A pollen diagram from Abernethy Forest, Inverness-shire. *J.Ecol.* **58**: 827-846
- BIRKS H.H. & MATTHEWES R.W. (1978) Studies in the vegetational history of Scotland V. Late Devensian and early Flandrian pollen and macrofossil stratigraphy at Abernethy Forest, Inverness-shire. *New Phytol.* **80**: 455-484
- BIRKS H.J.B., DEACON J. & PEGLAR S.M. (1975) Pollen maps for the British Isles 5000 years ago. *Proc.R.Soc. B*: **189**: 87-105
- BIRKS H.J.B. (1980) The present flora and vegetation of the moraines of the Klutlan Glacier, Yukon Territory, Canada: a study in plant succession. *Quat.Res.* **14**: 60-86
- BIRKS H.J.B. (1988) Long-term ecological change in the British uplands  
IN: USHER M.B. & THOMPSON D.B.A. (eds.) *Ecological Change in the Uplands*. Blackwell, Oxford : 37-56
- BIRSE E.L. (1980) *Plant Communities of Scotland A Preliminary Phytocoenonia*. Macaulay Inst. Soil Res., Aberdeen
- BIRSE E.L. & ROBERTSON J.S. (1976) *Plant Communities and Soils of the Lowland and Southern Upland Regions of Scotland*. Macaulay Inst. Soil Res., Aberdeen
- BLACKITH R.E. & REYMENT R.A. (1971) *Multivariate Morphometrics*. Academic Press, London
- BRADLEY R.S. (1985) *Quaternary Paleoclimatology*. Allen & Unwin, Boston, U.S.A
- BURL A. (1976) *The Stone Circles of the British Isles*. Yale University Press, London
- BURL A. (1983) *Prehistoric Stone Circles (2nd ed.)*. Shire, Aylesbury, Bucks.
- CLAPHAM A.R., TUTIN T.G. & MOORE D.M. (1987) *Flora of the British Isles (3rd ed.)*. C.U.P., Cambridge
- CLARK J.S. (1988 a) Particle motion and the theory of charcoal analysis: source area, transport, deposition, and sampling. *Quaternary Research* **30**: 67-80
- CLARK J.S. (1988 b) Stratigraphic charcoal analysis on petrographic thin sections: recent fire history in northwestern Minnesota. *Quaternary Research* **30**: 81-91
- CLOSE-BROOKS J. (1986) *Exploring Scotland's Heritage: The Highlands*. HMSO, Edinburgh
- CONOLLY A.P. & DAHL E. (1970) Maximum summer temperature in relation to the modern and Quaternary distributions of certain arctic-montane species in the British Isles.  
IN: WALKER D. & WEST R.G. (eds.) *Studies in the vegetational history of the British Isles..* C.U.P.,Cambridge :159-223
- DANIELS R.E. & EDDY A. (1985) *Handbook of European Sphagna*. Institute of Terrestrial Ecology, Monkswood
- DIOTTE M. & BERGERON Y. (1989) Fire and the distribution of *Juniperus communis* L. in the boreal forest of Quebec, Canada. *J. Biogeog.* **16**: 91-96

- DUNLOP B.M.S. (unpublished) The History of Abernethy Forest (Some notes prepared for the Hill Land Use and Ecology Group excursion on 24th May, 1972)
- DURNO S.E. (1956) Pollen analysis of peat deposits in Scotland. *Scot.Geogr.Mag.* 72: 177-187
- DURNO S.E. (1959) Pollen analysis of peat deposits in the Eastern Grampians. *Scot.Geogr.Mag.* 75: 102-111
- FAEGRI K. & IVERSEN J. (1964) Textbook of pollen analysis (2nd. ed.). Blackwell, Oxford
- FEACHEM R. (1963) A Guide to Prehistoric Scotland. Batsford, London
- FITZPATRICK E.A. (1964) The soils of Scotland  
IN: BURNETT J.H. The Vegetation of Scotland. Oliver & Boyd, Edinburgh : 36-63
- GAUCH H.G. (1982) Multivariate Analysis in Community Ecology. C.U.P., Cambridge
- GAULD J.H. (1982) Native pinewood soils in the northern section of Abernethy Forest. *Scot.Geogr.Mag.* 98: 48-56
- GAULD J.H. (unpublished) The soils developed under native pinewood on the Loch Garten Nature Reserve, Inverness-shire. Unpublished report for the RSPB. Macaulay Institute for Soil Research, Aberdeen
- GEAR A.J. (1989) Holocene vegetation history and the palaeoecology of *Pinus sylvestris* in northern Scotland. Vols. 1 & 2. Ph.D. Thesis, University of Durham
- GIMINGHAM C.H. (1961) North European heath communities: a network of variation. *J. Ecol.* 49: 655-694
- GIMINGHAM C.H. (1964) Dwarf-Shrub Heaths  
IN: BURNETT J.H. (ed.) The Vegetation of Scotland. Oliver & Boyd, Edinburgh : 232-288
- GIMINGHAM C.H. (1975) Heathland Ecology. Oliver & Boyd, Edinburgh
- GODWIN H. (1975) History of the British Flora (2nd ed.). C.U.P., Cambridge
- GRANT, THE REV. J. (1799) United Parishes of Abernethy and Kincardine  
IN: SINCLAIR, SIR JOHN, BT. (ed.) The Statistical Account of Scotland. Edinburgh 13: 129-152
- GREEN F.H.W. (1964) The Climate of Scotland  
IN: BURNETT J.H. (ed.) The Vegetation of Scotland. Oliver & Boyd, Edinburgh : 15-35
- HAWKES C.F.C. & CLARKE R.R. (1963) Gahistorf and Caister-on-Sea: two finds of late bronze age Irish Gold  
IN: FOSTER I.L. & ALCOCK L. (eds.) Culture and Environment: Essays in honour of Sir Cyril Fox. Routledge & Kegan Paul, London : 193-250
- HENSHALL A.S. (1963) The Chambered Tombs of Scotland 2 vols.. E.U.P., Edinburgh
- HILL M.O. (1978) *Sphagnum*  
IN: SMITH A.J.E..The Moss Flora of Britain and Ireland. C.U.P., Cambridge
- HILL M.O. (1979) DECORANA - A FORTRAN program for detrended correspondence analysis and reciprocal averaging. Cornell University, Ithaca, N.Y.
- HOBBS R.J. & GIMINGHAM C.H. (1984) Studies on fire in Scottish heathland communities II. Post-fire vegetation development. *J. Ecol.* 72: 585-610
- HOBBS R.J. & GIMINGHAM C.H. (1987) Vegetation, fire and herbivore interactions in heathland  
IN: MACFADYEN A. & FORD E.D.(eds.) Advances in Ecological Research. Academic Press, London

- HUBBARD C.E. (1954) *Grasses*. Penguin, Harmondsworth, Middlesex
- HULTÉN E. (1970) *The Circumpolar Plants. II Dicotyledons*. Almqvist & Wiksell, Stokholm
- HUNTLEY B. (in press a) *Morrone Birkwoods National Nature Reserve*  
IN: *Geological Conservation Review: The Quaternary of Scotland*. N.C.C.
- HUNTLEY B. (in press b) *Historical lessons for the future*  
IN: SPELLERBERG I.F., GOLDSMITH & MORRIS M.G. (eds.) *Scientific Management of Temperate Communities for Conservation*. British Ecological Society symposium. Blackwell, Oxford
- JACKSON A. (1984) *The Symbol Stones of Scotland*. Orkney Press, Kirkwall
- JACOBSON G.L. & BRADSHAW R.H.W. (1981) *The selection of sites for palaeovegetational studies*.  
*Quaternary Research* 16: 80-96
- JAHNS H.M. (1983) *Ferns, Mosses and Lichens of Britain and North and Central Europe*. Collins, London
- JERMY A.C., CHATER A.O. & DAVID R.W. (1982) *Sedges of the British Isles*. BSBI Handbook No.1.  
Botanical Society of the British Isles
- LEWIS F.J. (1905) *The plant remains in the Scottish peat mosses Part I. The Scottish Southern Uplands*.  
*Trans.R.Soc.Edinb.* 41: 699-712
- LEWIS F.J. (1906) ----- Part II. *The Scottish Highlands*. *Trans.R.Soc.Edinb.* 45: 335-361
- MACVICAR S.M. (1926) *Student's Handbook of British Hepatics (2nd ed.)*. Sumfield, Eastbourne
- MARTIN W.K. (1969) *The Concise British Flora (2nd ed.)*. Ebury Press and Michael Joseph
- MCVEAN D.N. & RATCLIFFE D.A. (1962) *Plant Communities of the Scottish Highlands*. HMSO, London
- MEAD-BRIGGS A.R. (1977) *Mole *Talpa europaea**  
IN: CORBET G.B. & SOUTHERN H.N. (eds.) *The Handbook of British Mammals (2nd ed.)*.  
Blackwell, Oxford : 37-45
- MEGAW J.V.S., SIMPSON D.D.A. & EDS. . (1979) *Introduction to British Prehistory*. Leicester University Press
- METEOROLOGICAL OFFICE . (1952) *Climatological Atlas of the British Isles*. HMSO, London
- METEOROLOGICAL OFFICE . (1989) *The Climate of Scotland some facts and figures*. HMSO, London
- MILES J. (1981) *Effect of birch on moorlands*. I.T.E., Cambridge (now through HMSO)
- MOORE P.D. & WEBB J.A. (1978) *An Illustrated Guide to Pollen Analysis*. Hodder & Stoughton
- MUIR A. & FRASER G.K. (1940) *The soils and vegetation of the Bin and Clashindarroch Forests*.  
*Trans.R.Soc.Edinb.* 60: 233-342
- NCC . (1986) *Nature Conservation and Afforestation in Britain*. Nature Conservancy Council, Peterborough
- NICOLAISEN W.F.H. (1976) *Scottish Place-Names*. Batsford, London
- O'SULLIVAN P.E. (1973 a) *Contemporary pollen studies in a native Scots pine ecosystem*. *Oikos* 24: 143-150
- O'SULLIVAN P.E. (1973 b) *Land-use changes in the Forest of Abernethy, Inverness-shire (1750-1900 A.D.)*.  
*Scot.Geogr.Mag.* 89: 95-106

- O'SULLIVAN P.E. (1973 c) Pollen analysis of Mor humus layers from a native Scots pine ecosystem, interpreted with surface samples. *Oikos* **24**: 259-272
- O'SULLIVAN P.E. (1974 a) Two pollen diagrams from the East-Central Highlands of Scotland. *Pollen et Spores* **16**: 35-57
- O'SULLIVAN P.E. (1974 b) Radiocarbon-dating and prehistoric forest clearance on Speyside (East-Central Highlands of Scotland). *Proc. Prehist. Soc.* **40**: 206-208
- O'SULLIVAN P.E. (1975) Vegetation history and the native pinewoods  
IN: BUNCE R.G.H. & JEFFERS J.N.R. (eds.) *Native Pinewoods of Scotland*. Institute of Terrestrial Ecology : 60-69
- O'SULLIVAN P.E. (1976) Pollen analysis and radiocarbon dating of a core from Loch Pityoulish, Eastern Highlands of Scotland. *J. Biogeog.* **3**: 293-302
- OLDFIELD F. (1959) The pollen morphology of some of the West European Ericales. *Pollen et Spores* **1**: 19-48
- PERRING F.H. & WALTERS S.M. (1976) *Atlas of the British Flora* (2nd.ed.). Ebury press
- RACKHAM O. (1986) *The History of the Countryside*. Dent, London
- ROSS-CRAIG S. (1948-1973) *Drawings of British Plants Parts I to XXX*. G.Bell & Sons, London
- ROYAL COMMISSION ON THE ANCIENT & HISTORICAL MONUMENTS OF SCOTLAND (RCAHMS).  
National Monuments Record of Scotland.
- RSPB . (undated) Loch Garten Reserve (reserve information leaflet). RSPB, Sandy, Bedfordshire
- SHEAIL J. (1980) *Historical Ecology: The Documentary Evidence*. I.T.E., Monks Wood (now through HMSO)
- SIMMONS I.G. & INNES J.B. (1988) Late Quaternary vegetational history of the North York Moors X. Investigations on East Bilsdale Moor. *J. Biogeog.* **15**: 299-324
- SMITH A.J.E. (1978) *The Moss Flora of Britain and Ireland*. C.U.P., Cambridge
- SMITH W.G. (1911) *Scottish Heaths*  
IN: TANSLEY A.G. (ed.) *Types of British Vegetation*. C.U.P., Cambridge
- STEVEN H.M. & CARLISLE A. (1959) *The Native Pinewoods of Scotland*. Oliver & Boyd, Edinburgh
- THOM A. (1967) *Megalithic Sites in Britain*. Clarendon, Oxford
- TURNER J., INNES J.B. & SIMMONS I.G. (1989) Two pollen diagrams from the same site. *New Phytologist* **113**: 409-416
- URQUHART U.H. (1986) *Arctostaphylos* Heathland in N E Scotland. Report to Nature Conservancy Council
- VASARI Y. & VASARI A. (1968) Late- and post- glacial macrophytic vegetation in the lochs of northern Scotland. *Acta Bot. Fenn.* **80**: 1-116
- WALKER M.J.C. (1975) A pollen diagram from the pass of Drumochter, Central Grampian Highlands, Scotland. *Trans. Bot. Soc. Edinb.* **42**: 335-343
- WARD S.D. (1970) The phytosociology of *Calluna-Arctostaphylos* heaths in Scotland and Scandinavia. I Dinnet Moor, Aberdeenshire. *J. Ecol.* **58**: 847-863

- WARD S.D. (1971 a) The phytosociology of *Calluna-Arctostaphylos* heaths in Scotland and Scandinavia. II The North-east Scottish heaths. *J. Ecol.* **59**: 679-696
- WARD S.D. (1971 b) The phytosociology of *Calluna-Arctostaphylos* heaths in Scotland and Scandinavia. III A critical examination of the *Arctostaphyleto-Callunetum*. *J. Ecol.* **59**: 697-712
- WATSON E.V. (1981) *British Mosses and Liverworts* (3rd edition). C.U.P., Cambridge
- WELCH D. (1984) Studies in the grazing of heather moorland in north-east Scotland. III Floristics. *J. Appl. Ecol.* **21**: 209-225
- WILKINSON D.M. & HUNTLEY B. (1987) Differential pollen preservation in a topogenous mire by High Force, Teesdale, northern England. *Pollen et Spores* **29**: 455-460
- WOODIN S.J. (1989) Environmental effects of air pollution in Britain. *J. Appl. Ecol.* **26**: 749-761
- YOUNG J.A.T. (1977) Glacial geomorphology of the Aviemore-Loch Garten area, Strathspey, Inverness-shire. *Geography* **62**: 25-34

## MAPS & AERIAL PHOTOGRAPHS

### Ordnance Survey

Scale	Sheet no.	Sheet name/area	Year
6"/mile	59	Inverness Mainland (Abernethy & Kincardine)	1874
1:10000	NH 91 NE	Inverness-shire (Abernethy & Kincardine)	1973
1:25000	NH 81/91 NH 80/90	Aviemore & Boat of Garten Kincaig	1982 1987
1:50000	36	Grantown, Aviemore & Cairngorm area	1986

INSTITUTE OF GEOLOGICAL SCIENCES (1964) One-inch geological map Sheet 74: Grantown on Spey.  
Solid and drift edition.  
IGS (now British Geological Survey)

INSTITUTE OF GEOLOGICAL SCIENCES (1979) Geological Map of the United Kingdom, North. 3rd  
edition, Solid.  
IGS (now British Geological Survey)

### Aerial Photographs

Year	Sortie	Print Nos.	Supplier
1948	541/A/0433	4119 4121	Air Photographs Unit, Scottish Development Dept.
1961	543/1428	F21: 0048	.. ..
1966	OS/66/151	020	.. ..
1978	RC8-CT	234	Committee for Aerial Photography, University of Cambridge

## Appendix 1

### Climate at Loch Garten

Weather records made by the warden 1977 to 1989 at Grianan (NH 973 165).  
Data supplied by the warden, Stewart Taylor

#### Annual precipitation (mm)

1978	79	80	81	82	83	84	85	86	87	88	89	Mean
777	821	917	733	998	808	830	880	716	702	822	717	810

#### Monthly precipitation in 1989 (mm)

Jan	Feb	Mar	Apr	May	Jun	Jul	Aug	Sept	Oct	Nov	Dec	Year
72.6	142	89.7	38.2	40.3	64.4	41.2	70.9	49.9	70.0	10.2	27.8	717

#### Annual depth of snowfall (mm)

1979	80	81	82	83	84	85	86	87	88	89	Mean
1754	824	1320	880	1111	1300	1340	1200	692	733	639	1072

#### Temperature

##### Mean daily maximum in July (°C)

1977	78	79	80	81	82	83	84	85	86	87	88	Mean
20.5	17.9	18.8	18.0	19.2	22.3	22.9	21.1	19.2	18.9	18.2	17.1	19.5

##### Mean daily minimum in January (°C)

1977	78	79	80	81	82	83	84	85	86	87	88	Mean
-3.3	-3.6	-7.9	-3.4	-1.4	-5.0	0.2	-7.5	-6.8	-4.6	-7.1	-5.1	-4.6

The month with the lowest mean daily minimum was February 1986 with -9.7 °C.

Highest temperature recorded was 30 degrees Celsius in June/July 1976

Lowest temperature recorded was -26 degrees Celsius

#### Frost

Frosts occur regularly each year until the end of May, and again from early September. July and August sometimes pass without frost.

#### Sunshine

Annual average 1977 to 1988 was 135 hours

## Appendix 2

### Photographs of 4x4m permanent plots

Transparency number	Permanent plot no.	Corner from which picture taken	Date
2	1	SE	29.06.1989
3	.	NE	..
4	.	NW	..
5	.	SW	..
6	2	NE	29.06.1989
7	.	SE	..
8	.	SW	..
9	.	NW	..
10	8	NE	2.07.1989
11	.	SE	..
12	.	NW	..
13	.	SW	..
14	7	NE	..
15	.	SE	..
16	.	NW	..
17	.	SW	..
18	6	NE	..
19	.	SE	..
20	.	NW	..
21	.	SW	..
22	5	NE	..
23	.	SE	..
24	.	NW	..
25	.	SW	..
26	4	NW	..
27	.	SW	..
28	.	NE	..
29	.	SE	..
30	3	NE	..
31	.	SE	..
32	.	NW	..
33	.	SW	..

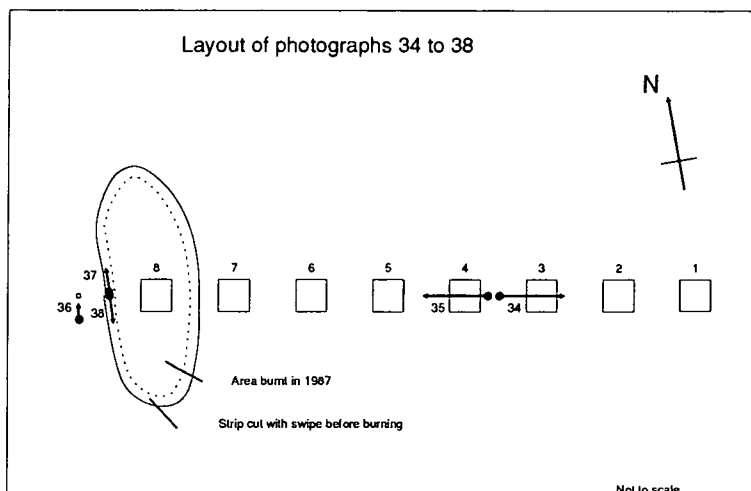

Appendix 3

Data for determination of minimal area

Plot area (m <sup>2</sup> )	1	2	3	4	5	6	8	10	12	14	16
<i>Agrostis canina</i>	+	+	+	+	+	+	+	+	+	+	+
<i>Agrostis capillaris</i>	+	+	+	+	+	+	+	+	+	+	+
<i>Anemone nemorosa</i>	+	+	+	+	+	+	+	+	+	+	+
<i>Arctostaphylos uva-ursi</i>	+	+	+	+	+	+	+	+	+	+	+
<i>Calluna vulgaris</i>	+	+	+	+	+	+	+	+	+	+	+
<i>Deschampsia flexuosa</i>	+	+	+	+	+	+	+	+	+	+	+
<i>Festuca ovina</i>	+	+	+	+	+	+	+	+	+	+	+
<i>Galium saxatile</i>	+	+	+	+	+	+	+	+	+	+	+
<i>Galium verum</i>	+	+	+	+	+	+	+	+	+	+	+
<i>Hypericum pulchrum</i>	+	+	+	+	+	+	+	+	+	+	+
<i>Lathyrus montanus</i>	+	+	+	+	+	+	+	+	+	+	+
<i>Lotus corniculatus</i>	+	+	+	+	+	+	+	+	+	+	+
<i>Potentilla erecta</i>	+	+	+	+	+	+	+	+	+	+	+
<i>Vaccinium vitis-idaea</i>	+	+	+	+	+	+	+	+	+	+	+
<i>Viola riviniana</i>	+	+	+	+	+	+	+	+	+	+	+
<i>Hylocomium splendens</i>	+	+	+	+	+	+	+	+	+	+	+
<i>Hypnum cupressiforme</i>	+	+	+	+	+	+	+	+	+	+	+
<i>Pleurozium schreberi</i>	+	+	+	+	+	+	+	+	+	+	+
<i>Pseudoscleropodium purum</i>	+	+	+	+	+	+	+	+	+	+	+
<i>Rhytidiadelphus triquetrus</i>	+	+	+	+	+	+	+	+	+	+	+
<i>Lophocolea bidentata</i>	+	+	+	+	+	+	+	+	+	+	+
<i>Hypogymnia physodes</i>	+	+	+	+	+	+	+	+	+	+	+
<i>Polygala serpyllifolia</i>		+	+	+	+	+	+	+	+	+	+
<i>Empetrum nigrum</i>			+	+	+	+	+	+	+	+	+
<i>Succisa pratensis</i>			+	+	+	+	+	+	+	+	+
<i>Campanula rotundifolia</i>				+	+	+	+	+	+	+	+
<i>Pyrola media</i>				+	+	+	+	+	+	+	+
<i>Danthonia decumbens</i>					+	+	+	+	+	+	+
<i>Genista anglica</i>					+	+	+	+	+	+	+
<i>Erica cinerea</i>						+	+	+	+	+	+
<i>Juniperus communis</i>						+	+	+	+	+	+
<i>Vaccinium myrtillus</i>						+	+	+	+	+	+
<i>Dicranum scoparium</i>							+	+	+	+	+
<i>Luzula multi./camp.</i>									+	+	+
<i>Carex</i> (cf. <i>caryophyllea</i> )											+
TOTAL NO. OF SPECIES	22	23	25	27	29	32	33	33	34	34	35

+ indicates the species is present

Other species seen near the plot

*Betula pubescens*  
*Deschampsia cespitosa*  
*Veronica officinalis*

Slope 5-10°  
Aspect East  
% vegetation cover 100

Location NH 964 163/4  
(see map)

Appendix 4

Domin Scale of plant cover/abundance

% of ground covered	Domin score
91-100	10
76-90	9
51-75	8
34-50	7
26-33	6
11-25	5
4-10	4
<4 many individuals	3
.. several ..	2
.. few ..	1

Appendix 5

Data for permanent plots 1 and 2

Sub-plot no.	1	2	3	4	5	6	7	8	9	10	11	12	13	14	15	16
Plot 1																
Veg.height in centre(cm)	34	35	28	38	28	27	44	36	54	33	33	44	42	32	32	22
% live veg.	100	99	98	99	100	100	100	100	99	100	99	100	100	98	100	100
% dead veg.	1	2	3	2	2	1	2	1	2	4	3	2	1	2	2	1
% bare ground	0	0	0	1	0	0	0	0	0	0	0	0	0	0	0	0
Plot2																
Veg.height in centre(cm)	34	25	35	26	20	17	37	34	36	38	31	25	14	33	28	38
% live veg.	100	100	100	100	100	100	99	100	100	100	100	100	100	99	100	100
% dead veg.	3	6	3	2	3	2	3	2	3	2	1	2	3	3	2	3
% bare ground	0	0	0	0	0	0	0	0	0	0	0	0	0	0	0	0

Location of sub-plots within each plot

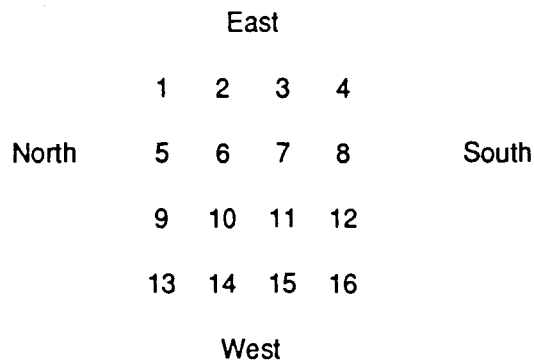

Appendix 6

Domin scores for permanent plots 1 and 2

Sub-plot number	Plot 1															
	1	2	3	4	5	6	7	8	9	10	11	12	13	14	15	16
<i>Betula pendula</i>																
<i>Betula pubescens</i>												1			1	
<i>Juniperus communis</i>	5	6	5	5	6	7	5	5	6		5	2	2	4	4	
<i>Arctostaphylos uva-ursi</i>	3	4	5	4	4	5	5	3	3	3	4	4	7	4	5	3
<i>Calluna vulgaris</i>	7	7	8	9	6	8	9	9	8	9	8	9	9	9	8	10
<i>Empetrum nigrum</i>	5	4	4	4												
<i>Erica cinerea</i>													2	1		
<i>Genista anglica</i>	1	1					1		1	2			2	1		1
<i>Vaccinium myrtillus</i>	3	2	1		4	3		2	4	3	3	3	3	3	4	3
<i>Vaccinium vitis-idaea</i>	3	3	3	3	3	3	3	3	3	3	3	2	2	2	3	3
<i>Agrostis canina</i>		1				1	1								1	
<i>Agrostis capillaris</i>																1
<i>Anthoxanthum odoratum</i>						1	2				1		2	1		
<i>Danthonia decumbens</i>													1			
<i>Deschampsia flexuosa</i>	2	2		1		2			2	1	2	1	2	2	3	2
<i>Festuca ovina</i>				1		2	2	1	1	1	1	1	1	2	3	2
<i>Carex pilulifera</i>												1				
<i>Carex pil./caryo.</i>			1													
<i>Listera cordata</i>								1								
<i>Luzula multi./camp.</i>				1			2						1	1	1	1
<i>Luzula sp.</i>																
<i>Anemone nemorosa</i>																
<i>Galium saxatile</i>																1
<i>Hypericum pulchrum</i>		1	1			1	1								1	
<i>Lathyrus montanus</i>		2	2	1		2	2	1							1	
<i>Potentilla erecta</i>			1	1			1	2	1	2	1					
<i>Succisa pratensis</i>		1					1			1						
<i>Viola riviniana</i>		1					1									
<i>Dicranium scoparium</i>							1									
<i>Hylocomium splendens</i>	6	5	5	3	9	4	3	6	5	8	6	4	3	3	4	7
<i>Hypnum cupressiforme</i>	3	2	2	4	1	3	3	3	2	1	2	1	3	3	2	2
<i>Pseudoscleropodium purum</i>			3	3	2			1				1	1	1		2
<i>Pleurozium schreberi</i>	3	3	1	3	3	1	3		2	3	2	3	3	3	3	3
<i>Rhytidiadelphus loreus</i>											1					
<i>R. squarrosus</i>	1						1									
<i>R. triquetrus</i>	3	3	2	3	2	3	3	4	3	3	2	4	3	3	3	3
<i>Cladonia sp. (cf. impexa)</i>	2															
<i>Cladonia sp.</i>																
<i>Hypogymnia physodes</i>	4		3	3	3	2	2	2	2	2			2	3	2	1
<i>Usnea sp.</i>	1	1														

Domin scores for permanent plots 1 and 2

Plot 2

Sub-plot number	1	2	3	4	5	6	7	8	9	10	11	12	13	14	15	16
<i>Betula pendula</i>									1	5						5
<i>Betula pubescens</i>	4															
<i>Juniperus communis</i>	1	1	1	3	4	1	3	8	3	1	4			4	3	1
<i>Arctostaphylos uva-ursi</i>		5	3	3	3	4	5	3	3	4	3	3	5	5	4	3
<i>Calluna vulgaris</i>	9	8	10	9	9	9	9	7	9	8	8	10	8	9	10	9
<i>Empetrum nigrum</i>	2	4	3	3			3	4	2	2	4	2	4	3	4	3
<i>Erica cinerea</i>																
<i>Genista anglica</i>			1	1				1		1	1		1		1	
<i>Vaccinium myrtillus</i>		2	3			2										
<i>Vaccinium vitis-idaea</i>	3	3	3	2	3	3	2	3	3	3	3	3	3	3	3	3
<i>Agrostis canina</i>	1				1	1			2	1			1			
<i>Agrostis capillaris</i>																1
<i>Anthoxanthum odoratum</i>														1	1	
<i>Danthonia decumbens</i>																
<i>Deschampsia flexuosa</i>	2	2	2	2	2	2	2	2	2	2	2	2	3	1	2	1
<i>Festuca ovina</i>	1	1			1			2		1	1		1	2	1	
<i>Carex pilulifera</i>																
<i>Carex pil./caryo.</i>	1												1	2		
<i>Listera cordata</i>			1													
<i>Luzula multi./camp.</i>	1	1			1		1				1		1		1	
<i>Luzula sp.</i>																1
<i>Anemone nemorosa</i>							1	1	2			1	2	2	1	
<i>Galium saxatile</i>																
<i>Hypericum pulchrum</i>																
<i>Lathyrus montanus</i>	1	2		1			2					1		1	2	2
<i>Potentilla erecta</i>	2	1	2	1	1	1	1	1	2	1	1	2	2	1		2
<i>Succisa pratensis</i>																
<i>Viola riviniana</i>	1				1					1			1			
<i>Dicranium scoparium</i>					1											
<i>Hylocomium splendens</i>	5	7	7	7	6	9	5	5	6	6	5	5	7	5	5	7
<i>Hypnum cupressiforme</i>	4			2	1			1	2	1	1	1		2		3
<i>Pseudoscleropodium purum</i>	2												1			1
<i>Pleurozium schreberi</i>	3	3	1	3	3	3	3	1	3	3	3		3	3	3	2
<i>Rhytidiadelphus loreus</i>																
<i>R. squarrosus</i>																
<i>R. triquetrus</i>	2	3	3	3	4	3	3	3	3	3	3	4	3	3	3	3
<i>Cladonia sp.(cf. impexa)</i>				1									1			
<i>Cladonia sp.</i>								1								
<i>Hypogymnia physodes</i>	1	1	2		2	1	1	3	3	2	1	2	2	1	1	2
<i>Usnea sp.</i>																

Appendix 7

Scheme for conversion of Domin scores from sixteen 1x1m to four 2x2m sub-plots within permanent plots numbers 1 and 2.

Layout of sub-plots within each plot

1	2	3	4
<b>1</b>		<b>2</b>	
5	6	7	8
9	10	11	12
<b>3</b>		<b>4</b>	
13	14	15	16

Sub-plot numbers

1x1m to	2x2m
1,2,5,6	<b>1</b>
3,4,7,8	<b>2</b>
9,10,13,14	<b>3</b>
11,12,15,16	<b>4</b>

Conversion of scores from four 1x1m to one 2x2m sub-plots:

For each species there were four Domin scores, ranging from 0 to 10.

Let the four values be a, b, c and d

These represent % cover A,B,C and D

For the 2x2m sub-plot, let the % cover of the species be V, and let the Domin score that we wish to deduce be v.

(1) Where each of a,b,c,and d are  $\leq 3$ , then v is given by

If $a + b + c + d \leq 2$	$v = 1$
If $3 \leq a + b + c + d \leq 9$	$v = 2$
If $a + b + c + d \geq 10$	$v = 3$

See score conversion table overleaf.

(2) Where each of a,b,c or d  $\geq 4$ , then the range of % cover of the 2x2m sub-plot was calculated as follows:

$$V_{\min} = 1/4 (A_{\min} + B_{\min} + C_{\min} + D_{\min})$$

$$V_{\max} = 1/4 (A_{\max} + B_{\max} + C_{\max} + D_{\max})$$

where  $A_{\max}$ ,  $A_{\min}$ , etc.  
are read from the  
Domin table

The median value of V is given by

$$1/2 (V_{\max} + V_{\min})$$

In other words, in this case, the median = mean.  
And so we get

$$V_{\text{mean}} = 1/2 (V_{\max} + V_{\min})$$

(3) Where values of a, b, c and d are both  $\leq 3$  and  $\geq 4$ , then discretion was used with the smaller values, according to the species, as follows:

	Domin	%Cover		
Small spp.	1	0	<i>Polygala serpyllifolia</i>	
	2	0	<i>Galium saxatile</i>	
	3	1	<i>Lotus corniculatus</i>	
			Fine grasses	
			Bryophytes + Lichens	
Medium spp	1	0	<i>Vaccinium</i> spp.	<i>Trientalis europaea</i>
	2	1	<i>Arctostaphylos</i>	<i>Genista anglica</i>
	3	2	<i>Empetrum nigrum</i>	<i>Potentilla erecta</i>
			<i>Erica cinerea</i>	<i>Hypericum pulchrum</i>
			Larger grasses	<i>Veronica officinalis</i>
			<i>Anemone nemorosa</i>	<i>Campanula rotundifolia</i>
			<i>Viola riviniana</i>	<i>Antennaria dioica</i>
Large/spreading spp.			<i>Juniperus communis</i>	
	1	1	<i>Betula</i> spp.	
	2	2	<i>Succisa pratensis</i>	
	3	3		

Minimum and maximum values of V were then calculated, much as in (2) above, for example, if a=1, b=2, c=4, d=5, then one might get:

	Domin		%Cover		Min		Max
a	1	A	0		0		0
b	2	B	1		+ 1		+ 1
c	4	C <sub>min</sub>	4		+ 4		+10
		C <sub>max</sub>	10		+11		+25
d	5	D <sub>min</sub>	11		---		---
		D <sub>max</sub>	25		=16		=36

$$V_{\min} = 16/4 \quad V_{\max} = 36/4$$

$$= 4 \quad = 9$$

$$V = 7$$

$$\text{and therefore } v = 4$$

Domin score conversions where all values  $\leq 3$

1x1m	2x2m	1x1m	2x2m	1x1m	2x2m	1x1m	2x2m
1	1	1 3	2	2	2	3	2
1 1	1	1 1 3	2	2 2	2	3 3	2
1 1 1	2	1 1 1 3	2	2 2 2	2	3 3 3	2
1 1 1 1	2	1 3 3	2	2 2 2 2	2	3 3 3 3	3
1 2	2	1 1 3 3	2	2 3	2		
1 1 2	2	1 3 3 3	3	2 2 3	2		
1 1 1 2	2	1 2 3	2	2 2 2 3	2		
1 2 2	2	1 1 2 3	2	2 3 3	2		
1 1 2 2	2	1 2 2 3	2	2 3 3 3	3		
1 2 2 2	2	1 2 3 3	2	2 2 3 3	3		

Appendix 8

Domin scores for permanent plots, divided into four 2x2m sub-plots

Plot number	1				2				3				4			
Sub-plot number	1	2	3	4	1	2	3	4	1	2	3	4	1	2	3	4
<i>Betula pendula</i>							4	4								
<i>Betula pubescens</i>				1	2											
<i>Juniperus communis</i>	6	5	4	4	3	5	3	3		3	4	1	5	7	6	6
<i>Arctostaphylos uva-ursi</i>	4	5	5	4	4	4	5	3	5	3	5	4	5	5	4	5
<i>Calluna vulgaris</i>	7	9	9	9	9	9	8	9	9	10	8	10	8	7	8	8
<i>Empetrum nigrum</i>	4	4			3	3	3	4	2	2	3	3	3	3	4	4
<i>Erica cinerea</i>			2										3			
<i>Genista anglica</i>	1	1	2	1		2	1	1							1	
<i>Vaccinium myrtillus</i>	3	2	3	3	2	2										
<i>Vaccinium vitis-idaea</i>	3	3	3	3	3	3	3	3	3	3	3	3	3	3	3	3
<i>Agrostis canina</i>	1	1	1		2	2			1	2	3		1			
<i>Agrostis capillaris</i>				1				1			1	2	1		2	
<i>Anthoxanthum odoratum</i>	1	1	2	1			1	1	1		2		2	1	2	
<i>Danthonia decumbens</i>			1													
<i>Deschampsia flexuosa</i>	2	1	2	2	2	2	2	2	2	2	2	2	2	3	2	2
<i>Festuca ovina</i>	1	2	2	2	2	2	2	1	2	3	3	3	2		2	1
<i>Carex pilulifera</i>				1					2	1						
<i>Carex pil./caryo.</i>		1			1	2			2	2	3				1	
<i>Listera cordata</i>		1							1							
<i>Luzula multi./camp.</i>	2	1	1		2	1	1	1	2		2		1			2
<i>Luzula pilosa</i>												1 (dead)				
<i>Luzula sp.</i>							1									
<i>Anemone nemorosa</i>						1	2	1	2	2		3	1		2	1
<i>Antennaria dioica</i>																
<i>Campanula rotundifolia</i>												2				
<i>Galium saxatile</i>				1								1	1			
<i>Galium verum</i>										1						
<i>Hypericum pulchrum</i>	1	1	1						2	2	2		1	1		
<i>Lathyrus montanus</i>	2	2	1		2	2	1	2	2	2	3	3	3	2	3	2
<i>Lotus corniculatus</i>																1
<i>Plantago lanceolata</i>									1		1	1				
<i>Polygala serpyllifolia</i>																
<i>Potentilla erecta</i>		2	2		2	2	2	2	3	3	3	3	3	1	3	1
<i>Ranunculus acris</i>																
<i>Succisa pratensis</i>	1	1	1							1	1	1	1			
<i>Veronica officinalis</i>											1				2	
<i>Viola riviniana</i>	1	1			1	1			3	2	3	3			2	2
<i>Dicranium scoparium</i>	1				1											1
<i>Hylocomium splendens</i>	7	5	5	5	7	6	6	5	7	8	2	6	5	5	7	5
<i>Hypnum cupressiforme</i>	3	3	2	2	2	2	2	2	3	2	3	3	3	2	3	3
<i>Pleurozium schreberi</i>	3	2	3	3	3	2	3	2	2	3	3	3	3	3	3	3
<i>Polytrichum juniperinum</i>																
<i>Pseudoscleropodium purum</i>	2	2	1	2	2		1	1	2		3		2	1	3	
<i>Rhytidiadelphus loreus</i>			1													
<i>R. squarrosus</i>	1	1														
<i>R. triquetrus</i>	3	3	3	3	3	3	3	3	3	3	2	3	3	3	3	3
Unknown acrocarpous moss																
<i>Cladonia sp.(cf. impexa)</i>	2					1	1							1		
<i>Cladonia sp.</i>						1										
<i>Hypogymnia physodes</i>	3	3	2	2	2	2	2	2	1	2			3	3	3	3
<i>Usnea sp.</i>	1															
NUMBER OF SPECIES	25	26	24	20	22	20	23	23	21	22	24	22	24	17	22	19

Plot number	5				6				7				8				
Sub-plot number	1	2	3	4	1	2	3	4	1	2	3	4	1	2	3	4	
<i>Betula pendula</i>																	
<i>Betula pubescens</i>																	
<i>Juniperus communis</i>	1	3				1	1				1						
<i>Arctostaphylos uva-ursi</i>	5	4	5	4	4	4	4	3	6	5	5	4	4	6	5	4	
<i>Calluna vulgaris</i>	8	10	9	9	8	10	10	10	9	10	9	10	6	3	4	5	
<i>Empetrum nigrum</i>	3		2														
<i>Erica cinerea</i>	2			3					3	3	3	2	2	2	2	2	
<i>Genista anglica</i>	2					1				1	1	1	3	3	3	3	
<i>Vaccinium myrtillus</i>					3												
<i>Vaccinium vitis-idaea</i>	3	3	3	3	3	3	3	3	3	3	3	3	3	3	3	2	
<i>Agrostis canina</i>	1	3			3	2	3	2	2	3	2	2	4	3	3	3	
<i>Agrostis capillaris</i>	3	2	3	3	2	2		3		1	3	1					
<i>Anthoxanthum odoratum</i>			1		2		2	2				2	5	5	5	5	
<i>Danthonia decumbens</i>										2							
<i>Deschampsia flexuosa</i>	2	2	2	2	3	2	2	1	3	2	2	2	3	3	3		
<i>Festuca ovina</i>	3	2	2	2	4	3	3	3	3	2	3		4	4	4	4	
<i>Carex pilulifera</i>	1				1	1		1					2		1	1	
<i>Carex pil./caryo.</i>		1	2		1	2	2	2	1			1	3	2	3	3	
<i>Listera cordata</i>																	
<i>Luzula multi./camp.</i>					2							1	3	2	3	3	
<i>Luzula pilosa</i>																	
<i>Luzula sp.</i>																	
<i>Anemone nemorosa</i>	3	3	3	3	3	3	3	3	3	2	3	3			1		
<i>Antennaria dioica</i>																2	
<i>Campanula rotundifolia</i>				2	2	2	3	3		2	2						
<i>Galium saxatile</i>					3	2	2	3		2			2				
<i>Galium verum</i>					3	2	2										
<i>Hypericum pulchrum</i>	2	2	2	1		2	2	2		2	2		2	2	2	2	
<i>Lathyrus montanus</i>	3	3	3	3	3	2	3	3	3	3	3	3	3	2	2	3	
<i>Lotus corniculatus</i>					1			2	1				3	3	3	3	
<i>Plantago lanceolata</i>					1												
<i>Polygala serpyllifolia</i>	1				1						1			2	2	3	
<i>Potentilla erecta</i>	3	3	3	3	3		3	3	3	3	3	3	3	3	3	3	
<i>Ranunculus acris</i>					1												
<i>Succisa pratensis</i>	1		1	1	2	3	2				1			1			
<i>Veronica officinalis</i>	1				2		2										
<i>Viola riviniana</i>			2	3	2	3	3	3	3	2	2	3	1	3	2	3	3
<i>Dicranium scoparium</i>										1							
<i>Hylacomium splendens</i>	7	6	7	6	5	6	7	6	5	7	4	7	3				
<i>Hypnum cupressiforme</i>	3	3	3	4	1	1	3	3	3	4	3	3					
<i>Pleurozium schreberi</i>	3	3	3	3	3	3	3	3	3	4	5	3	3				
<i>Polytrichum juniperinum</i>													2	2	3	3	
<i>Pseudoscleropodium purum</i>				3	2	3	3	3	2	3	3	2					
<i>Rhytidiadelphus loreus</i>												2					
<i>R. squarrosus</i>					1	1											
<i>R. triquetrus</i>	3	3	3	3		3	3	3	2	2	2	3	2				
Unknown acrocarpous moss														2	2	2	
<i>Cladonia sp.(cf. impexa)</i>																	
<i>Cladonia sp.</i>																	
<i>Hypogymnia physodes</i>	3	3	3	3	1	2	2	2	2	2	3	2					
<i>Usnea sp.</i>																	
NUMBER OF SPECIES	24	19	20	20	30	25	24	24	20	22	24	23	21	20	20	19	

Appendix 8

Physical data for permanent plots

Plot Number	1				2				3				4			
2x2m Sub-plot	1	2	3	4	1	2	3	4	1	2	3	4	1	2	3	4
Aspect (degrees)	133				308				135				253			
Slope (degrees)	0 to 5				5				0				5 to 15			
Drainage	4				4				3				4			
Vegetation height in centre (cm)	20	25	23	33	40	32	20	13	36	50	42	41	40	69	30	26
% Live vegetation	100	99	99	100	100	100	100	100	100	100	99	100	100	100	100	100
% Dead vegetation	2	2	2	2	4	3	3	2	3	2	3	3	2	1	0	1
% Bare ground	0	0	0	0	0	0	0	0	0	0	0	0	0	0	0	0

Plot Number	5				6				7				8			
2x2m Sub-plot	1	2	3	4	1	2	3	4	1	2	3	4	1	2	3	4
Aspect (degrees)	218				70				126				151			
Slope (degrees)	0 to 5				10				5 to 12				10			
Drainage	3				4				4				4			
Vegetation height in centre (cm)	36	44	12	13	37	40	38	42	43	39	46	51	14	6	7	3
% Live vegetation	100	100	100	100	100	100	100	100	99	100	100	100	90	90	95	85
% Dead vegetation	3	1	2	3	1	3	2	1	2	2	3	3	4	5	5	4
% Bare ground	0	0	0	0	0	0	0	0	0	0	0	0	10	10	5	15

Notes	1				2				3				4			
Plot Number	1				2				3				4			
2x2m Sub-plot	1	2	3	4	1	2	3	4	1	2	3	4	1	2	3	4
Vegetation height near centre (cm)	45	33														
Old droppings of mammal herbivore	+															
Old molehill									+							
Anthill	+															

Position of plots: East 1 2 3 4 5 6 7 8 West

Transect bearing: 264 degrees (North as per grid on O.S. map)



Scale of drainage	5	very good	2	poor
	4	good	1	bad
	3	fair	0	nil (standing water)

## Appendix 9

## Domin scores for 2x2m relevés

Plot number	100	101	102	103	104	105	106	122
<i>Betula pubescens</i>				1				
<i>Sorbus aucuparia</i>							1	
<i>Arctostaphylos uva-ursi</i>	3	5	3	8	3	3		
<i>Calluna vulgaris</i>	8	5	10	5		10	10	8
<i>Empetrum nigrum</i>	3	7	3					
<i>Erica cinerea</i>				3				
<i>Genista anglica</i>		2	1		2			
<i>Vaccinium myrtillus</i>	5	3		2	3		3	2
<i>Vaccinium vitis-idaea</i>	3	3	3	3		3	3	4
<i>Agrostis canina</i>		4	1	2	4	2	3	
<i>Agrostis capillaris</i>		2		2	5	2		
<i>Anthoxanthum odoratum</i>				3	2	2		
<i>Danthonia decumbens</i>				2				
<i>Deschampsia flexuosa</i>	3	5	2	3	6	2	3	3
<i>Festuca ovina</i>		5	1	4	7	3	3	4
<i>Nardus stricta</i>					4			
<i>Poa pratensis</i>					2			
<i>Carex pilulifera</i>		2		2				
<i>Carex pil./caryo.</i>					4	2		
<i>Listera cordata</i>						2		
<i>Luzula multi./camp.</i>		3	1	2	4	3		
<i>Luzula pilosa</i>		1						
<i>Anemone nemorosa</i>							3	
<i>Campanula rotundifolia</i>				2				
<i>Galium saxatile</i>		3		3	5	3		3
<i>Galium verum</i>				1				
<i>Hypericum pulchrum</i>		1		1		1		
<i>Lathyrus montanus</i>		2		3	3	3		
<i>Polygala serpyllifolia</i>				1				
<i>Potentilla erecta</i>	1	3	2	2	2	3	3	2
<i>Succisa pratensis</i>				1				
<i>Trientalis europaea</i>		1					2	3
<i>Veronica officinalis</i>					1			
<i>Viola riviniana</i>				2			1	
<i>Dicranium scoparium</i>			2					
<i>Hylocomium splendens</i>	6		4	3	3	5	6	5
<i>Hypnum cupressiforme</i>		2	3	3		6	3	
<i>Pleurozium schreberi</i>	1	3	6	3	3	3	4	3
<i>Pseudoscleropodium purum</i>		2						
<i>Rhytidiadelphus squarrosus</i>		1			3			
<i>R. triquetrus</i>	1	3	2		3	2		
<i>Cladonia sp.(cf. impexa)</i>	1		4					
<i>Hypogymnia physodes</i>	2	2	3	2		2	2	
TOTAL NUMBER OF SPECIES	12	24	17	27	20	20	15	10

Appendix 9

Domin scores for 2x2m relevés

2x2m Relevés taken on peat bog

Releve number	113	114	115	119
<i>Betula pubescens</i>				1
<i>Calluna vulgaris</i>	7	7	8	
<i>Erica tetralix</i>	3	3	3	
<i>Empetrum nigrum</i>		3		
<i>Carex</i> (cf. <i>nigra</i> )				1
<i>Eriophorum vaginatum</i>	5	7	6	9
<i>Trichophorum cespitosum</i>	4		4	
<i>Aulacomnium palustre</i>	(2)	(3)		
<i>Hypnum cupressiforme</i>	3	3	3	
<i>Pleurozium schreberi</i>	3	3	4	
<i>Sphagnum cuspidatum</i>				4
<i>Sphagnum papillosum</i>				5
<i>Sphagnum subnitens</i>	3	4	4	5
<i>Cephalozia bicuspidata</i>	(2)			
<i>Cephalozia connivens</i>	(2)			
<i>Odontoschisma sphagni</i>	(1)			
<i>Cladonia impexa</i>	5	4	4	
<i>Hypogymnia physodes</i>	2	2	3	
TOTAL NO. OF SPECIES	13	10	9	6

( ) indicates estimate

Physical data for relevés 100 to 122 (plots are 2x2m throughout)

Relevé number	100	101	102	103	104	105	106	122	113	114	115	119
Aspect (degrees)	186			246			38		(sw)			
Slope (degrees)	<5	<5	≤5	20	≤5	≤5	10	0	0	0	0	0
Drainage (0 to 5 scale)	4	3	4	5	2	4	4	3/2	1	1	1	0
Vegetation height in centre (cm)	18	13						nd				
Vegetation height in each quarter (cm)	1		19	16	32	42	44		44	35	25	9
	2		31	17	20	41	46		35	30	36	15
	3		31	19	9	24	48		22	28	43	9
	4		49	12	15	48	46		26	31	50	28
Mean veg. height (cm)	18	13	33	16	19	39	46		32	31	39	15
% Live vegetation	100	97	100	99	98	100	100	100	98	95	95	100
% Dead vegetation	5	10	7	3	4	3	10	3	5	10	10	5
% Bare ground	0	0	0	0	0	0	0	0	0	0	1	0
Piles of droppings from mammal herbivore					1							

Data collected on 2-3.7.1989

nd = no data

Drainage scale in earlier appendix

## Appendix 10

## List of plant species found on Tulloch Moor within RSPB reserve

Vascular plants	Heath	Grassland in heath	Bog & flushes	Lochan	Woodland	Waysides
<i>Betula pendula</i>	+					
<i>Betula pubescens</i>	+		+	+	+	+
<i>Cytisus scoparius</i>	+					+
<i>Juniperus communis</i>	+				+	+
<i>Pinus sylvestris</i>	+		+		+	
<i>Rosa</i> sp. (cf. <i>pimpinellifolia</i> )						+
<i>Sorbus aucuparia</i>	+					
<i>Arctostaphylos uva-ursi</i>	+	+				+
<i>Calluna vulgaris</i>	+		+		+	+
<i>Empetrum nigrum</i>	+		+			+
<i>Erica cinerea</i>	+					
<i>Erica tetralix</i>			+		+	
<i>Genista anglica</i>	+	+				
<i>Vaccinium myrtillus</i>	+	+			+	
<i>Vaccinium vitis-idaea</i>	+				+	
<i>Agrostis canina</i>	+	+				
<i>Agrostis capillaris</i>	+	+				+
<i>Anthoxanthum odoratum</i>	+	+				
<i>Danthonia decumbens</i>	+					
<i>Deschampsia cespitosa</i>	+					+
<i>Deschampsia flexuosa</i>	+	+			+	
<i>Festuca ovina</i>	+	+			+	
<i>Holcus lanatus</i>	+	+				+
<i>Nardus stricta</i>		+				+
<i>Poa pratensis</i>		+				+
[ <i>Carex flacca</i> ]						
<i>Carex nigra</i>			+	+		
<i>Carex pilulifera</i>	+					
<i>Carex caryophyllea</i>						+
<i>Carex</i> (cf. <i>caryophyllea</i> )	+					
<i>Carex pil./caryo.</i>	+	+				
<i>Carex rostrata</i>				+		
<i>Dactylorhiza maculata</i> ssp. <i>ericetorum</i>	+					
<i>Eriophorum angustifolium</i>				+		
<i>Eriophorum vaginatum</i>			+			
<i>Gymnadenia conopsea</i>	+					
<i>Juncus</i> cf. <i>acutiflorus</i>						
<i>Juncus effusus</i>				+		
<i>Juncus squarrosus</i>				+		
<i>Listera cordata</i>	+					
<i>Luzula multi./camp.</i>	+	+				
<i>Luzula pilosa</i>	+					
<i>Trichophorum cespitosum</i>			+			

	Heath	Grassland in heath	Bog & flushes	Lochan	Woodland	Waysides
<i>Achillea millefolium</i>						+
<i>Anemone nemorosa</i>	+					
<i>Antennaria dioica</i>	+					
<i>Bellis perennis</i>						+
<i>Campanula rotundifolia</i>	+					
<i>Cerastium</i> sp.						+
<i>Cirsium</i> sp.	+					
<i>Conopodium majus</i>						+
<i>Drosera rotundifolia</i>			+			
<i>Euphrasia</i> sp.						+
<i>Galium saxatile</i>	+	+			+	
<i>Galium verum</i>	+					+
<i>Helianthemum nummularium</i>						+
<i>Hieracium pilosella</i>	+					+
<i>Hypericum pulchrum</i>	+					
<i>Hypochoeris radicata</i>	+					+
<i>Lathyrus montanus</i>	+	+				+
<i>Lotus corniculatus</i>	+					+
<i>Melampyrum</i> cf. <i>pratense</i>					+	
<i>Plantago lanceolata</i>	+					+
<i>Polygala serpyllifolia</i>	+	+				
<i>Potentilla erecta</i>	+	+			+	+
<i>Pyrola media</i>	+					
<i>Ranunculus acris</i>	+					+
<i>Ranunculus repens</i>		+				+
<i>Rhinanthus minor</i>						+
<i>Rumex acetosa</i>						+
<i>Sagina procumbens</i>						+
<i>Succisa pratensis</i>	+					
<i>Taraxacum</i> sp.						+
<i>Thymus praecox</i>						+
<i>Trientalis europaea</i>	+				+	
<i>Trifolium pratense</i>						+
<i>Trifolium repens</i>						+
<i>Urtica dioica</i>						+
<i>Veronica chamaedrys</i>						+
<i>Veronica officinalis</i>	+	+				+
<i>Vicia cracca</i>						+
<i>Viola riviniana</i>	+					
<i>Blechnum spicant</i>	+				+	
<i>Lycopodium clavatum</i>	+					

Bryophytes & lichens	Heath	Grassland in heath	Bog & flushes	Lochan	Woodland	Waysides
<i>Aulacomnium palustre</i>			+			
<i>Dicranium scoparium</i>	+					
<i>Hylocomium splendens</i>	+	+			+	+
<i>Hypnum cupressiforme</i>	+		+			+
<i>Leucobryum glaucum</i>	+					
<i>Plagiomnium undulatum</i>		+				
<i>Pleurozium schreberi</i>	+	+	+		+	
<i>Polytrichum commune</i>				+		
<i>Polytrichum juniperinum</i>	+					
<i>Pseudoscleropodium purum</i>	+					
<i>Rhytidiadelphus loreus</i>	+					
<i>R. squarrosus</i>	+	+				
<i>R. triquetrus</i>	+	+				
<i>Sphagnum cuspidatum</i>			+			
<i>Sphagnum papillosum</i>			+			
<i>Sphagnum recurvum</i>				+		
<i>Sphagnum subnitens</i>			+			
Unknown acrocarpous moss	+					
<i>Barbilophozia cf. floerkii</i>	+					
<i>Cephalozia bicuspidata</i>			+			
<i>Cephalozia connivens</i>			+			
<i>Lophocolea bidentata</i>			+			
<i>Odontoschisma sphagni</i>			+			
<i>Cladonia impexa</i>	+		+			
<i>Cladonia furcata</i>	+					
<i>Cladonia</i> sp.						
<i>Hypogymnia physodes</i>	+		+			
<i>Usnea</i> sp.	+				+	

The absence of a + against a habitat does not necessarily mean that the species is absent from that habitat

[ ] = not confirmed

Appendix 11

Comparison of pollen frequencies in A and B profiles

3cm depth only

	Pollen frequency		Pollen percentage	
	A	B	A	B
<i>Betula</i>	25	71	7	14
<i>Pinus</i>	65	92	19	19
<i>Quercus</i>	5	2	2	0.4
<i>Alnus</i>	2	1	0.6	0.2
B/C/M		5		1
<i>Corylus/Myrica</i>	2		0.6	
<i>Tilia</i>	1		0.3	
TREES+SHRUBS	100	171	29	35
Ericales( <i>Calluna</i> )	194	285	57	58
Ericales(Other)	29	19	9	4
DWARF SHRUBS	223	304	65	62
Gramineae	16	15	5	3
Compositae	1		0.3	
<i>Lathyrus</i>	1		0.3	
EXTRA-LOCAL NAP	18	15	5	3
CALCULATION SUM	341	490	100	100
NO. OF TAXA in Calculation Sum	11	10		
<i>Pedicularis</i>	1	1	0.3	0.2
Cyperaceae	3	12	0.9	2.4
LOCAL NAP	4	13	1.2	2.6
<i>Sphagnum</i>	3	1	0.9	0.2
Filicales undiff.	2	2	0.6	0.4
<i>Lycopodium clavatum.</i>	3		0.9	

B/C/M = *Betula/Corylus/Myrica*

NAP = Non Arboreal Pollen

## Appendix 12

## Pollen frequencies in peat from Tulloch Moor

Depth (cm)	0	3	6	10	16	20	24	28	32	34
<i>Betula</i>	68	25	20	8	13	10	21	28	38	18
<i>Pinus</i>	64	65	70	20	32	12	14	16	36	23
<i>Quercus</i>	1	5		1		4			1	
<i>Alnus</i>	1	2	2	1	3	2	2	1		1
<i>B/C/M</i>	4		1		2		2	1	2	
<i>Corylus/Myrica</i>		2		2		1		2		
<i>Corylus</i>	1				1		1			
<i>B/C/M+C/M+Co</i>	5	2	1	2	3	1	3	3	2	
<i>Fagus</i>	2						2			
<i>Acer</i>							1			
<i>Ulmus</i>									1	
<i>Salix</i>								3		
<i>Tilia</i>		1								
<i>Juniperus</i>	4				1					
TREES+SHRUBS	145	100	93	32	52	29	43	51	78	42
<i>Myrica</i>	1		1	1	1		2		1	
Ericales ( <i>Calluna</i> )	298	194	128	431	248	400	116	49	217	133
Ericales (Other)		29	8	8	1	43	109	2	2	
<i>Genista</i> type										
DWARF SHRUBS	299	223	137	440	250	443	227	51	220	133
Gramineae	14	16	7	8	10	14	7	4	5	11
<i>Plantago</i> spp.	3		4	4	2	9	4	1	1	
<i>Rumex</i> spp.					1	2	1	1		
Chenopodiaceae										
Caryophyllaceae				2						
<i>Artemisia</i>							1			
Compositae: Liguliflorae		1		1						
Compositae: Tubuliflorae				1						
<i>Hypericum</i>							1			
<i>Helianthemum</i>										
<i>Potentilla</i>	1				1	2	1	3		1
Rubiaceae										
<i>Lathyrus</i>		1								
<i>Vicia</i> (cf. <i>sylvatica</i> )	1									
EXTRA-LOCAL NAP	19	18	11	16	14	27	15	9	6	12
CALCULATION SUM	463	341	241	488	316	499	285	111	304	187
NO. OF TAXA	14	11	9	13	13	11	16	12	10	6
<i>Pedicularis</i>		1								
<i>Drosera</i>									1	
Cyperaceae	10	3	5	5	14	6	20	7	6	13
LOCAL NAP	10	4	5	5	14	6	20	7	7	13
<i>Sphagnum</i>	2	3	1		36		25	375	12	15
Filicales undiff.	1	2	2	1		2	1			
<i>Pteridium</i>				2		1		1		
<i>Huperzia selago</i>					1	1				
<i>Lycopodium clavatum</i>		3				1				
<i>Polypodium</i>					1					
PTERIDOPHYTES	1	5	2	3	2	5	1	1		

Depth (cm)	36	38	40	44	48	56	64	72	80	100
<i>Betula</i>	3	16	50	53	78	79	75	44	67	45
<i>Pinus</i>	22	15	40	15	35	45	95	102	198	14
<i>Quercus</i>		1	2	2	3	1				3
<i>Alnus</i>		4	11	6	17	14	15	3	3	9
B/C/M		2	5	5	13	6	1		6	9
<i>Corylus/Myrica</i>	1	2	1	3	2	2	1		1	
<i>Corylus</i>		1	1			1	4			1
B/C/M+C/M+Co	1	5	7	8	15	9	6		7	10
<i>Fagus</i>										
<i>Acer</i>										
<i>Ulmus</i>			2							
<i>Salix</i>	1			1		3	3			
<i>Tilia</i>										
<i>Juniperus</i>					1					
TREES+SHRUBS	27	41	112	85	149	151	194	149	275	81
<i>Myrica</i>	1	5	8	4	4	5	12		4	11
Ericales ( <i>Calluna</i> )	54	79	122	28	78	71	61	30	34	178
Ericales (Other)		2	1			1		1		1
<i>Genista</i> type										1
DWARF SHRUBS	55	86	131	32	82	77	73	31	38	191
Gramineae	12	32	28	21	18	28	22	7	11	11
<i>Plantago</i> spp.	1		3	2	1	3	1		1	2
<i>Rumex</i> spp.				1		1			1	
Chenopodiaceae		1			1					
Caryophyllaceae			2							
<i>Artemisia</i>										
Compositae: Liguliflorae			1							
Compositae: Tubuliflorae				5						
<i>Hypericum</i>										
<i>Helianthemum</i>										1
<i>Potentilla</i>									1	
Rubiaceae	1									
<i>Lathyrus</i>								1		
<i>Vicia</i> (cf. <i>sylvatica</i> )										
EXTRA-LOCAL NAP	14	33	34	29	20	32	23	8	14	14
CALCULATION SUM	96	160	277	146	251	260	290	188	327	286
NO. OF TAXA	9	12	15	13	12	14	11	7	11	13
<i>Pedicularis</i>										
<i>Drosera</i>										
Cyperaceae	31	11	24	8	31	12	17	7	16	28
LOCAL NAP	31	11	24	8	31	12	17	7	16	28
<i>Sphagnum</i>	12	35	22	592	50	23	4		15	20
Filicales undif										1
<i>Pteridium</i>			1			1	2			
<i>Huperzia selago</i>										
<i>Lycopodium clavatum</i>										2
<i>Polypodium</i>							2			
PTERIDOPHYTES			1			1	4			3

## Appendix 13

## Pollen percentages in peat from Tulloch Moor

Depth (cm)	0	3	6	10	16	20	24	28	32	34
<i>Betula</i>	15	7.3	8.3	1.6	4.1	2	7.4	25	13	9.6
<i>Pinus</i>	14	19	29	4.1	10	2.4	4.9	14	12	12
<i>Quercus</i>	0.2	1.5		0.2		0.8			0.3	
<i>Alnus</i>	0.2	0.6	0.8	0.2	0.9	0.4	0.7	0.9		0.5
B/C/M	0.9		0.4		0.6		0.7	0.9	0.7	
<i>Corylus/Myrica</i>		0.6		0.4		0.2		1.8		
<i>Corylus</i>	0.2				0.3		0.4			
B/C/M+CO/MY+CO	1.1	0.6	0.4	0.4	0.9	0.2	1.1	2.7	0.7	
<i>Fagus</i>	0.4						0.7			
<i>Acer</i>							0.4			
<i>Ulmus</i>									0.3	
<i>Salix</i>								2.7		
<i>Tilia</i>		0.3								
<i>Juniperus</i>	0.9				0.3					
TREES+SHRUBS	31	29	39	6.6	16	5.8	15	46	26	22
<i>Myrica</i>	0.2		0.4	0.2	0.3		0.7		0.3	
Ericales ( <i>Calluna</i> )	64	57	53	88	78	80	41	44	71	71
Ericales (other)		8.5	3.3	1.6	0.3	8.6	38	1.8	0.7	
<i>Genista</i> type										
DWARF SHRUBS	65	65	57	90	79	89	80	46	72	71
Gramineae	3.0	4.7	2.9	1.6	3.2	2.8	2.5	3.6	1.6	5.9
<i>Plantago</i> spp.	0.6		1.7	0.8	0.6	1.8	1.4	0.9	0.3	
<i>Rumex</i> spp.					0.3	0.4	0.4	0.9		
Chenopodiaceae										
Caryophyllaceae				0.4						
<i>Artemisia</i>							0.4			
Compositae: Liguliflorae		0.3		0.2						
Compositae: Tubuliflorae				0.2						
<i>Hypericum</i>							0.4			
<i>Helianthemum</i>										
<i>Potentilla</i>	0.2				0.3	0.4	0.4	2.7		0.5
Rubiaceae										
<i>Lathyrus</i>		0.3								
<i>Vicia</i> (cf. <i>sylvatica</i> )	0.2									
EXTRA-LOCAL NAP	4.2	5.3	4.6	3.3	4.4	5.4	5.3	8.1	2	6.4
CALCULATION SUM	463	341	241	488	316	499	285	111	304	187
NO.of TAXA	14	11	9	13	13	11	16	12	10	6
<i>Pedicularis</i>		0.3								
<i>Drosera</i>									0.3	
Cyperaceae	2.2				4.2		6.6	5.9	1.9	6.5
LOCAL NAP	2.2	1.2	2	1	4.2	1.2	6.6	5.9	2.3	6.5
<i>Sphagnum</i>	0.4	0.9	0.4		10		8.1	77	3.8	7.4
Filicales undiff.	0.2	0.6	0.8	0.2		0.4	0.3			
<i>Pteridium</i>				0.4		0.2		0.9		
<i>Huperzia selago</i>					0.3	0.2				
<i>Lycopodium clavatum</i>		0.9				0.2				
<i>Polypodium</i>					0.3					
PTERIDOPHYTES	0.2	1.4	0.8	0.6	0.6	1	0.3	0.9		

Depth (cm)	36	38	40	44	48	56	64	72	80	100
<i>Betula</i>	3.1	10	18	36	31	30	26	23	20	16
<i>Pinus</i>	23	9.4	14	10	14	17	33	54	61	4.9
<i>Quercus</i>		0.6	0.7	1.4	1.2	0.4				1
<i>Alnus</i>		2.5	4.0	4.1	6.8	5.4	5.2	1.6	0.9	3.1
B/C/M		1.3	1.8	3.4	5.2	2.3	0.3		1.8	3.1
<i>Corylus/Myrica</i>	1	1.3	0.4	2.1	0.8	0.8	0.3		0.3	
<i>Corylus</i>		0.6	0.4			0.4	1.4			0.3
B/C/M+CO/MY+CO	1	3.1	2.5	5.5	6	3.5	2.1		2.1	3.5
<i>Fagus</i>										
<i>Acer</i>										
<i>Ulmus</i>			0.7							
<i>Salix</i>	1			0.7		1.2	1			
<i>Tilia</i>										
<i>Juniperus</i>					0.4					
TREES+SHRUBS	28	26	40	58	59	58	67	79	84	28
<i>Myrica</i>	1	3.1	2.9	2.7	1.6	1.9	4.1		1.2	3.8
Ericales ( <i>Calluna</i> )	56	49	44	19	31	27	21	16	10	62
Ericales (other)		1.3	0.4			0.4		0.5		0.3
<i>Genista</i> type										0.3
DWARF SHRUBS	57	54	47	22	33	30	25	16	12	67
Gramineae	13	20	10	14	7.2	11	7.6	3.7	3.4	3.8
<i>Plantago</i> spp.	1.0		1.1	1.4	0.4	1.2	0.3		0.3	0.7
<i>Rumex</i> spp.				0.7		0.4			0.3	
Chenopodiaceae		0.6			0.4					
Caryophyllaceae			0.7							
<i>Artemisia</i>										
Compositae: Liguliflorae			0.4							
Compositae: Tubuliflorae				3.4						
<i>Hypericum</i>										
<i>Helianthemum</i>										0.3
<i>Potentilla</i>									0.3	
Rubiaceae	1									
<i>Lathyrus</i>								0.5		
<i>Vicia</i> (cf. <i>sylvatica</i> )										
EXTRA-LOCAL NAP	15	21	12	20	8	12	7.9	4.3	4.3	4.9
CALCULATION SUM	96	160	277	146	251	260	290	188	327	286
NO.of TAXA	9	12	15	13	12	14	11	7	11	13
<i>Pedicularis</i>										
<i>Drosera</i>										
Cyperaceae	24	6.4	8.0	5.2	11	4.4	5.5		4.7	8.9
LOCAL NAP	24	6.4	8.0	5.2	11	4.4	5.5	3.6	4.7	8.9
<i>Sphagnum</i>	11	18	7.4	80	17	8.1	1.4		4.4	6.5
Filicales undiff.										0.3
<i>Pteridium</i>			0.4			0.4	0.7			
<i>Huperzia selago</i>										
<i>Lycopodium clavatum</i>										0.7
<i>Polypodium</i>							0.7			
PTERIDOPHYTES			0.4			0.4	1.4			1

Appendix 14

*Arctostaphylos* reference pollen  
Diameter ( $\mu\text{m}$ ) (any orientation)

39.2	39.2	39.5	38.1	41.4
41.2	44.0	36.7	40.6	39.5
39.2	42.0	39.2	39.8	38.9
34.4	39.2	40.1	41.7	40.0
40.0	39.2	44.0	41.2	33.6
33.0	41.2	39.8	32.5	31.1
41.2	42.6	38.9	39.2	40.1
38.6	42.6	37.8	43.4	36.4
39.2	40.6	37.0	40.3	40.6
42.3	39.5	38.1	36.4	36.4
36.7	39.8	40.6	42.3	40.3
37.8	36.7	37.0	41.7	43.4
38.4	38.6	41.2	35.3	39.5
44.5	38.1	40.1	40.3	43.4
37.8	37.0	38.9	38.9	39.2
38.6	40.1	39.8	42.6	42.0
35.0	38.9	41.4	41.2	40.6
39.2	37.8	42.0	39.5	41.5
36.7	38.9	40.3	32.5	39.2
43.1	36.7	40.6	39.5	41.4

n = 100  
 mean = 39.37  $\mu\text{m}$   
 st.deviation = 2.58  $\mu\text{m}$   
 s.e.m. = 0.258  $\mu\text{m}$

Comparison of Diameter (any orientation) with measurement D

*Arctostaphylos* reference  
pollen tetrads

Fossil pollen tetrads  
(identity unspecified)  
Sample: 24 cm depth

Dia ( $\mu\text{m}$ )	D ( $\mu\text{m}$ )	Dia ( $\mu\text{m}$ )	D ( $\mu\text{m}$ )
41.7	41.7	36.7	36.7
36.7	37.0	35.8	35.0
42.3	42.3	35.3	33.9
41.2	41.4	31.9	33.6
36.7	36.1	36.4	36.4
42.0	42.3	37.0	37.0
37.8	38.4	31.1	30.8
42.3	42.3	33.6	32.2
32.8	33.6	33.9	33.6
39.2	40.6	33.9	33.9
	32.8	33.6	
	33.0	33.0	

Paired t-test:

t = -1.75  
 0.2 > P > 0.1  
 Not significant

Paired t-test:

t = 0.57  
 P > 0.2  
 Not significant

Appendix 15  
Ericales reference pollen

*Arctostaphylos uva-ursi*

No.	Shape	Texture	Colpi	Costae	Notes
1					
2	R	mf even	n	+ n sl	
3	R	mf even	m	+ vn	
4	R	±mf unev	n/m	+ m jp	
5	R	mf even	±n	+ m db	
6	R	mf even	n	+ db	
7	R	±mf unev crks	±l ±n	+ mw ±db	ie
8	Ro	f even	m n	+ m db	
9	R/Rd	f even	m	+ m db	
10	R	mf even	m n	+ db	
11					
12					
13					
14					
15					
16		mf ±even			
17					
18					
19					
20					
21	R	mc even fbr	l/m n	+ m	
22	R	mc even fbr	m n	+ n	
23	R	mc even fbr	l ±n	+ n	
24	R	m	l n	+ n db we	
25	R	mf even fbr	l n	+ n db	
26	R	mf even	l ±n	+ m db	
27	R	m unev	l m	+ m db	
28	R	mc unev	l ±n	+ m we	
29	R	mf unev	l n	+ m db	
30	R	m	l m	+ m db	

*Erica cinerea*

31	Rdf	c br	m m	+ w db we	
32	Rdf	m	m ±n	+ w db we se	
33	R	mf	m n	+ m db	
34	Rd	m	l ±n	+ m we	
35	Rd	m	l m	+ w ±db we se	
36	Rdf	m	m n spl.e	+ w	
37	Rdf	mf gir crks	m	+ ±w db we se	
38	R	mf crm	l m/n	+ m db se	
39	R	mf fbr	m m	+ m db se	
40	R dist	mf unev	m n	+ w ±db we se	
41	Rd	f	m n	+ w we	
42	Rdf	f	l ±n	+ m db	
43	Rd	c unev crm	m ±w	+ w we	
44	Rdf	mf fbr	l n	+ m db ±we ±s	
45	Rdf	mf	m n	+ m db se	
46	Rd	m unev	±l w	+ m db	INF
47	Rd	mc unev	m m	+ w db we ±s	PI
48	Rd	mf vfbr	l n	+ w db we se	
49	Rdf	f unev	l m	+ m db se	
50	Rd ti	m fbr	l w	+ w we	INF
51	Rdf	mf fbr	l m	+ m	
52	Rdf	m fbr	m m	+ m db we se	
53	Rdf	m	l w	+ w db we se	
54	Rdf	f unev	m m/n	+ m db se	
55	Rd	m	l n	+ m db se	

*Erica tetralix*

No.	Shape	Texture	Colpi	Costae	Notes
56	Rd	c fbr	±w	± n/vn	INF
57	Rd	c gir	w	± vn/-	INF
58	±Rd	m	w	-	INF
59	Rd s.dam	mc fbr	w	-	INF
60	Rd	±fbr	w	+ n sl	INF
61	Rd	mc br	w	-	INF
62	Rd	c br	w	-	INF
63	±Rd s.m-s	c ±br	w	-	INF
64	Rdf	m fbr	w	-	INF
65	±Rd	c br	w	-	INF
66	C tri m		n	+ w ±db	NI
67	Tlf	c ±br	n	+ we db	NI
68	±Rd	m	m n	+ n	NI
69	Tlf		m n	+ db	NI
70	±Rd	c br	m ±n	+ ±n db	PI
71	C tri m		m n	+ w db	NI
72	C tri mc		m n	+ w db	NI
73	Rd	c br	s ±n	+ ±w ±re	PI
74	Squat	mc br	±l n	+ m db ±se	NI
75	Cf	mc	m n	+ w db re	NI
76	Rdf	mc br	m/s m/w	± n	
77	Rd	c br	m w	± (n)	INF
78					
79	Rdf	c br	m ±w	-	INF
80	Rdf	c br	m w	-	INF
81	Rdf	c	l/m w	±	INF
82	Rdf	c br	m w	±	INF
83	Rdf	mc	m m re	±	INF
84	Rdf	m br	m n	+ m db se	NI
85	Rdf	c	m n	+ m db se	NI

*Vaccinium myrtillus*

No.	Shape	Texture	Colpi	Costae	Notes
86	Rdf	c br	m w	-	
87	Rdf	c br	m	± n	
88	Rdf	c br	±s n	-	
89	Rdf	c br	m re	± n	
90	Rdf	f	m re	± n	
91	Rdf skew	c	s re	± (n)	
92	Rdf	c br	m	+ n	
93	Rdf	c br	m m	+ n	
94	Rdf	c br	m m/n we	+ n	
95	Rdf	mf	m n re	± (n)	
96	Rdf	c br	l m re	+ n	
97	Rdf skew	m fbr	m m re	+ n	
98	Rdf skew	m	m m	+ n	
99	Rdf	m	m re	± (n)	
100	Rdf	m br	m n	+ n	
101	Rdf C	m br	m m	+ n	
102	Rdf	c br	s m	+ n	
103	Rdf	m fbr	m m re	+ n	
104	Rdf C	mc br	m m re	± (n)	
105	Rdf C	m fbr	m m re	± (n)	

*Vaccinium vitis-idaea*

No.	Shape	Texture	Colpi	Costae	Notes
106	Rd C	m fbr	m n	-	
107		f fbr	m n	± (n)	
108	Rdf C	f fbr	m n	+ n	
109	Rd squat	mf	m n/m	± (n)	
110	Rd C	f	m n	+ n	
111	Rd C	f fbr	m n	+ n	
112	Rd C	f	m n	+ n	
113	Rdf C	f fbr	m n	± (n)	
114	Rdf	f	m n	+ n	
115	Rdf	m	m n re	± (n)	
116	Rdf squat	m/f	s n	± n	
117	Rdf squat	f fbr	m n re	± (n)	
118	Rdf C	m+f	unev m re	-	
119	Rd	m fbr	m m re	-	
120	Rdf C	f	m n	+ n db se	sm.split
121		mf fbr	l n	± (n)	
122	Rd C	m fbr	±s (n)	-	
123	Rdf	m+f fbr	m n	± n db	
124	TI	m	m n ±re	± (n)	
125	Rdf C	mf fbr	m m re	± (n)	

*Empetrum nigrum*

No.	Shape	Texture	Colpi	Costae	Notes
126	RdC	f	s n re	+tap se	
127	RdC	mf	s n re	+tap	imp
128	RdC	mf	s	+tap	
129	RdC	m	s re	+tap	split
130	RdC	m	s n	+	
131	RdC	m	s n	+m	
132	tri	m	s n	+tap se	
133	RdC	m	s n	+tap	
134	Rd	mf	m nm re	+tap se	
135	tri	mf	s	+tap se	
136	Rd	mf	s n	+tap se	
137	Rd	mf	s n re	+tap se	
138	Rdtri AP	mf	s	+tap	
139	TI AP	mf	s n	+tap	
140	RdC	m	s n	+tap	
141	RdC	m	s re	+tap	
142	Rd	f	s n	+tap	
143	Rd	f	s n	+tap	
144	RdC AP	mf	s n re	+	
145	RdC AP	f	s n re	+tap	

## Abbreviations

### Shape

R	Round
Rd	Rounded
o	circular
tl	trilobed
tri	triangular
C	compact
f	flattened
squat	squat
dist	distorted
m-s	mis-shapen
dam	damaged
skew	asymmetric
imperf	imperfect
s	slightly
AP	

### Texture

f	fine
c	coarse
m	medium
br	brain
gir	giraffe
crm	cracked mud
crks	cracks

### Colpi

w	wide
m	medium
n	narrow
s	short
re	ragged end
l	long
spl.e	split ends

### Costae

tap	taper
se	square end
ie	indistinct end
db	dark border
we	wavy edge
re	ragged edge
sl	strap-like
w	wide
m	medium
n	narrow
vn	very narrow
jp	join perimeter

### Notes

INF	Inflated
NI	Not Inflated
PI	Partly Inflated
sm.split	small split
imp	imperfect

## Appendix 16

Measurements of Ericales reference pollen ( $\mu\text{m}$ )

<i>Arctostaphylos uva-ursi</i>				<i>Erica cinerea</i>			
No.	D	d	D/d	No.	D	d	D/d
1	41.7	32.5	1.28	31	44.8	33.3	1.35
2	37.0	30.5	1.21	32	46.3	34.3	1.35
3	42.3	35.8	1.18	33	50.2	41.0	1.22
4	41.4	35.0	1.18	34	48.6	33.0	1.47
5	36.1	30.2	1.20	35	46.1	33.5	1.38
6	42.3	33.6	1.26	36	46.3	35.6	1.30
7	38.4	28.3	1.36	37	51.4	37.6	1.37
8	42.3	35.3	1.20	38	46.1	36.7	1.26
9	33.6	26.0	1.29	39	47.1	34.3	1.37
10	40.6	30.8	1.32	40	53.5	42.2	1.27
11	37.8	28.6	1.32	41	57.8	41.0	1.41
12	41.2	33.9	1.22	42	45.6	33.5	1.36
13	41.4	33.6	1.23	43	50.7	39.7	1.28
14	42.0	34.7	1.21	44	46.1	35.8	1.29
15	42.6	32.5	1.31	45	46.8	36.4	1.29
16	41.7	35.0	1.19	46	53.2	39.9	1.33
17	40.3	33.0	1.22	47	48.1	35.3	1.36
18	37.0	30.8	1.20	48	51.2	37.6	1.36
19	34.1	25.5	1.34	49	44.8	32.8	1.37
20	39.5	32.8	1.20	50	46.3	32.2	1.44
21	41.8	34.2	1.22	51	50.7	36.1	1.40
22	43.1	35.0	1.23	52	46.8	34.6	1.35
23	40.3	33.3	1.21	53	46.1	33.0	1.40
24	43.8	34.8	1.26	54	49.7	35.8	1.39
25	43.0	36.9	1.17	55	47.9	34.3	1.40
26	43.5	35.1	1.24				
27	40.4	32.0	1.26				
28	38.7	35.3	1.10				
29	41.2	32.5	1.27				
30	41.0	33.0	1.24				
n	30	30	30	25	25	25	
mean	40.34	32.68	1.237	48.49	35.98	1.350	
S.D.	2.61	2.76	0.056	3.13	2.81	0.058	

<i>Erica tetralix</i>				<i>Vaccinium myrtillus</i>			
No.	D	d	D/d	No.	D	d	D/d
56	36.7	26.0	1.41	86	34.6	26.9	1.29
57	39.5	28.3	1.40	87	34.8	25.6	1.36
58	39.2	27.4	1.43	88	38.1	26.6	1.43
59	38.4	26.9	1.43	89	36.1	28.2	1.28
60	40.3	29.0	1.39	90	35.8	25.9	1.38
61	37.0	24.6	1.50	91	37.4	28.9	1.29
62	36.4	25.2	1.44	92	36.1	26.9	1.34
63	38.1	30.2	1.26	93	35.1	25.9	1.36
64	36.7	26.7	1.37	94	37.1	26.9	1.38
65	35.8	23.8	1.50	95	35.8	25.1	1.43
66	30.2	21.6	1.40	96	39.9	27.9	1.43
67	31.5	21.0	1.50	97	36.7	27.9	1.32
68	33.0	22.7	1.45	98	33.5	26.4	1.27
69	28.8	20.7	1.39	99	38.4	28.9	1.33

<i>Erica tetralix</i>				<i>Vaccinium myrtillus</i>			
No.	D	d	D/d	No.	D	d	D/d
70	31.1	22.4	1.39	100	35.1	25.6	1.37
71	26.3	21.8	1.21	101	36.1	30.5	1.18
72	28.3	22.4	1.26	102	36.1	25.9	1.39
73	25.5	16.5	1.55	103	38.4	27.1	1.42
74	31.9	22.1	1.44	104	33.5	25.6	1.31
75	28.3	16.8	1.68	105	35.8	25.9	1.38
76	37.9	25.8	1.47				
77	39.7	27.9	1.42				
78	38.4	28.2	1.36				
79	36.6	26.6	1.38				
80	41.2	28.9	1.43				
81	38.1	29.2	1.30				
82	42.0	30.7	1.37				
83	38.1	29.1	1.31				
84	33.8	23.0	1.47				
85	31.7	23.6	1.34				
n	30	30	30	20	20	20	
mean	35.02	24.97	1.409	36.22	26.93	1.35	
S.D.	4.55	3.66	0.091	1.60	1.37	0.06	

<i>Vaccinium vitis-idaea</i>				<i>Empetrum nigrum</i>			
No.	D	d	D/d	No.	D	d	D/d
106	28.2	21.8	1.29	126	34.0	21.8	1.56
107	32.8	24.1	1.36	127	35.6	25.1	1.42
108	30.0	23.0	1.30	128	27.4	19.2	1.43
109	35.8	21.8	1.64	129	31.5	22.5	1.40
110	31.5	22.3	1.41	130	29.4	19.2	1.53
111	35.1	24.8	1.42	131	29.2	20.0	1.46
112	28.7	23.3	1.23	132	28.2	20.5	1.38
113	32.0	24.3	1.32	133	30.7	22.8	1.35
114	37.1	27.4	1.35	134	32.0	20.7	1.55
115	35.1	25.6	1.37	135	30.7	21.0	1.46
116	34.0	23.0	1.48	136	28.9	19.2	1.51
117	40.2	27.1	1.48	137	30.0	20.2	1.49
118	34.0	23.1	1.47	138	28.9	19.5	1.48
119	35.3	25.9	1.36	139	26.6	18.2	1.46
120	30.5	22.0	1.39	140	29.2	19.2	1.52
121	38.4	23.8	1.61	141	26.6	20.0	1.33
122	32.8	22.5	1.46	142	29.2	21.0	1.39
123	32.3	23.0	1.40	143	28.7	21.0	1.37
124	35.1	23.8	1.47	144	31.2	22.0	1.42
125	33.8	22.0	1.54	145	28.4	21.8	1.30
n	20	20	20	20	20	20	
mean	33.63	23.73	1.42	29.82	20.74	1.44	
S.D.	2.99	1.64	0.10	2.21	1.57	0.07	

Appendix 17

Ericales fossil pollen

No.	Depth (cm)	Shape	Texture	Colpi	Costae	Notes
146	0	Rd	c br	m n	+ ±db ±we	
147	0	R/Rd		n	+ m ±sl	
148	0			s n	+ re	
149	3	Rd	c	m n	+ w we	
150	3	R/Rd	±f	l n	+ mn db sl	
151	3	Rd	c	m ±n	+ mw ±sl	
152	3	Rd	c gir	m n	+ m db sl	
153	3	Rd	mc	m n	+ mn db sl	
154	3	Rd	c	m ±n	+ w	
155	3	±Rd	c	m m	+ ±we	
156	3	Rdf	c	±l m	+ ±w we	
157	3	±Rd	c br	±l n	+ m we	
158	3	Ctri	mc fbr	l n	+ n db	
159	6	Rd	c br	m ±n	+ m	
160	6	±Rd	c fbr	m m	+ n	
161	6	Rd	c br	±l n/m	+ ±db we ±se nipv	
162	6	Rd	c br	m n/m	+ ±db we ±se	
163	6	RdC	mc			degrad
164	10	Rd	c gir	m n	+ m db sl	
165	10	Rd	c br	m n	+ w we	
166	10	±Rd	c	m n	+ m db we ±se	
167	16	Rd	m			dam
168	20		m fbr	l m	±	s.cr.
169	20	RdC	c br	m ±w	+ n	
170	20	Rdf	c br	m n	+ m db sl	
171	20	R/Rd	c fbr	m m	+ db sl	
172	20		mc fbr		+ m db sl	
173	20	Tlf	mc	m n	+ m db sl	
174	20		mc fbr			
175	20		mc fbr		+	
176	20		mc fbr	m re	±	
177	20					
178	20		c	m n	+ we	
179	20		c fbr	m n	+ db sl	
180	20		m	m	-	
181	20					
182	20					
183	20			m w	+	
184	20	R/o			+±w we	
185	20	R	m fbr	w	±	INF
186	20					
187	20	Ctri±Rd	c fbr	m n	+ db	
188	20		c retic			
189	20	Rd	m	m	+	
190	20	Rd(f)	c	w	± (vn)	
191	20	RdfC	mc fbr		± vn	th.wa
192	20		f		+ w db we	dist
193	20	Rdf	m vfbr		+ m we ±se	
194	24	Rd	c br	l ±n	+ ±ib	
195	24					s.cr.
196	24	Rd	c br	m n	+ we	
197	24	Rd	mc ±br	±l n r	+ ±ie	
198	24	Rd	c br	m+n	+ n+m	
199	24	±RD	c gir	n	+ m db sl	

No.	Depth (cm)	Shape	Texture	Colpi	Costae	Notes
200	24	Rd	c br	m	+ n	
201	24	Rd	m gir	m ±n	+ m db	
202	24	Rd	c br/gir	n	+ db sl	
203	24	Rd	c br			
204	24	Rd	m	±n	+ w we ±se	
205	24	C	c/mc	±l n	+ w we	th.wa
206	24	C	mc br/gir	m n	+ n db sl	±th.wa
207	24	Rd	c br	m n	+ we ±se	s.dam
208	24	Rd/C	c/m ±br	m n	+ m	sl
209	24	±Rd	c br	±l n	+ ±w we ±se	
210	24	±RD	c ±br	m n	+ we	
211	24					
212	24	tri fl	mc gir	m m	+ m db sl	
213	24	Rd	mf	m n	+ m db sl se	cwb
214	24	Rd	±m	m ±n	+ w ±db ±we ±se	
215	32	Rd f	mc	n	+ w db we	
216	34	Rd	m/f	n	+ w we	
217	38	o	mc	n	+ w se	
218	38	Rd	m fbr	n	+ n db	cwb
219	38	Rd	m/f		+ n db	
220	38	Rd	c	±n	+ ±w ±db	cwb
221	40	Rd	m/f	m	+ w ±db we ±se	cwb
222	56	m-s	m gir			
223	56	m-s	m	n	+ n	

#### Abbreviations

Shape	Texture	Colpi	Costae
R	Round	f	w wide
Rd	Rounded	c	m medium
o	circular	m	n narrow
tl	trilobed	br	s short
tri	triangular	gir	re ragged edge
C	compact	crm	l long
f	flattened		spl.e split ends
squat	squat		
dist	distorted		
m-s	mis-shapen		Costae
dam	damaged		tap taper
skew	asymmetric		se square end
s	slightly		db dark border
cr	crushed		ib indistinct border
AP			we wavy edge
			re ragged edge
			sl strap-like
			w wide
Notes			
th.wa.	thick walls	m	medium
nipv	not in polar view	n	narrow
degrad	degraded	vn	very narrow
INF	Inflated	cwb	costae with breaks
NI	Not Inflated		
PI	Partly Inflated		

Appendix 18

Measurements of Ericales fossil pollen ( $\mu\text{m}$ )

No.	Depth (cm)	D	d	2f	No.	Depth (cm)	D	d	2f
146	0	33.0	27.7		190	20	31.6	22.0	
147	0	42.6	30.8	25.2	191	20	23.2	17.4	11.2
148	0	33.6	23.2		192	20	37.0	31.4	22.8
149	3	31.4	22.4		193	20	34.2	27.4	16.2
150	3	40.6	33.6						16.5
151	3	31.1	20.2		194	24	36.7	26.9	
152	3	31.1	22.7		195	24	35.0	26.6	
153	3	36.4	25.5		196	24	33.9	23.8	
154	3	37.2	28.3		197	24	33.6	25.2	
155	3	33.0	25.5		198	24	36.4	25.2	
156	3	32.2	22.1		199	24	37.0	23.5	
157	3	34.4	25.5		200	24	30.8	20.2	
158	3	30.1	24.1		201	24	32.8	24.9	
159	6	30.0	22.7		202	24	37.5	26.6	19.9
160	6	32.5	23.5		203	24	33.9	28.0	
161	6	35.0	28.3		204	24	39.8	29.4	
162	6	34.2	25.2		205	24	32.2	23.8	
163	6	31.1	23.8		206	24	33.0	25.2	
164	10	33.9	25.5		207	24	33.6	28.3	
165	10	31.4	22.4		208	24	33.9	23.0	
166	10	31.1	22.4		209	24	33.6	25.2	
167	16	27.4	19.9		210	24	33.0	22.4	
168	20	28.3	20.7		211	24	36.4	27.7	
169	20	28.8	21.6		212	24	34.2	24.9	
170	20	33.6	26.6		213	24	36.7	29.4	
171	20	30.8	21.0		214	24	39.2	30.2	
172	20	33.9	24.6	18.2	215	32	33.6	24.9	19.9
173	20	33.0	23.5		216	34	40.0	30.2	
174	20	31.1	22.4		217	38	39.5	26.3	22
175	20	28.0	21.0		218	38	30.5	21.6	17
176	20	28.0	19.3		219	38	28.6	21.6	17.4
177	20	37.4	24.4		220	38	32.2	22.4	
178	20	31.4	22.4		221	40	45.9	34.2	
179	20	30.8	23.8		222	56	49.0	32.2	
180	20	31.4	23.2		223	56	33.6	23.8	(15.4)
181	20	33.3	24.6						
182	20	29.4	23.0						
183	20	29.7	22.4						
184	20	34.0	25.0	14.3					
185	20	34.4	20.7	17.4					
186	20	28.3	21.0						
187	20	25.2	17.6						
188	20	33.0	22.5						
189	20	28.3	22.4						

( ) indicates measurement suspect, eg. tetrad mis-shapen

## Appendix 19

## Ericales fossil pollen identities

No.	Depth (cm)	Identity by inspection	CVA highest prob. group	CVA + other characters	ID used in pollen diagram
146	0	<i>E.tet</i>	<i>V.myr</i>	<i>E.t/V.m</i>	<i>E.tet</i>
147	0	<i>A.u-u</i>	<i>E.cin</i>	<i>E.cin</i>	
148	0	-	<i>V.v-i</i>	<i>E.t/V.m/V.v</i>	
149	3	<i>E.tet</i>	<i>Em.n</i>	<i>E.tet</i>	<i>E.tet</i>
150	3	<i>A.u-u</i>	<i>A.u-u</i>	<i>A.u-u</i>	<i>A.u-u</i>
151	3	<i>E.tet</i>	<i>Em.n</i>	<i>E.tet</i>	<i>E.tet</i>
152	3	<i>E.tet</i>	<i>Em.n</i>	<i>E.tet</i>	<i>E.tet</i>
153	3	<i>E.tet</i>	<i>E.tet</i>	<i>E.t/V.m</i>	<i>E.tet</i>
154	3	<i>E.tet</i>	<i>V.myr</i>	<i>V.m/E.t</i>	
155	3	<i>E.tet</i>	<i>V.myr</i>	<i>E.t/V.m</i>	<i>E.tet</i>
156	3	<i>E.tet</i>	<i>V.v-i</i>	<i>E.t/V.m</i>	<i>E.tet</i>
157	3	<i>E.tet</i>	<i>V.myr</i>	<i>E.t/V.m</i>	<i>E.tet</i>
158	3	<i>E.t/E.c</i>	<i>Em.n</i>	<i>E.tet</i>	<i>E.tet</i>
159	6	<i>E.tet</i>	<i>Em.n</i>	<i>E.tet</i>	<i>E.tet</i>
160	6	<i>E.tet</i>	<i>V.v-i</i>	<i>E.tet</i>	<i>E.tet</i>
161	6	<i>E.tet</i>	<i>V.myr</i>	<i>E.t/V.m</i>	<i>E.tet</i>
162	6	<i>E.tet</i>	<i>E.tet</i>	<i>E.t/Vm</i>	<i>E.tet</i>
163	6	-	<i>V.v-i</i>	<i>E.tet</i>	<i>E.tet</i>
164	10	<i>E.tet</i>	<i>V.myr</i>	<i>E.t/V.m</i>	<i>E.tet</i>
165	10	<i>E.tet</i>	<i>Em.n</i>	<i>E.tet</i>	<i>E.tet</i>
166	10	<i>E.tet</i>	<i>Em.n</i>	<i>E.tet</i>	<i>E.tet</i>
167	16	<i>C.v.</i>	<i>Em.n</i>		
168	20	<i>E.t/Em</i>	<i>Em.n</i>	<i>E.tet</i>	<i>E.tet</i>
169	20	<i>E.t/Em</i>	<i>Em.n</i>	<i>E.tet</i>	<i>E.tet</i>
170	20	<i>E.tet</i>	<i>V.myr</i>	<i>E.t/V.m</i>	<i>E.tet</i>
171	20	<i>E.tet</i>	<i>Em.n</i>	<i>E.tet</i>	<i>E.tet</i>
172	20	<i>E.tet</i>	<i>E.tet</i>	<i>E.tet</i>	<i>E.tet</i>
173	20	<i>E.tet</i>	<i>V.v-i</i>	<i>E.tet</i>	<i>E.tet</i>
174	20	<i>E.tet</i>	<i>Em.n</i>	<i>E.tet</i>	<i>E.tet</i>
175	20	<i>E.tet</i>	<i>Em.n</i>	<i>E.tet</i>	<i>E.tet</i>
176	20	<i>E.t/Em</i>	<i>Em.n</i>	<i>E.tet</i>	<i>E.tet</i>
177	20	<i>E.tet</i>	<i>E.tet</i>	<i>E.t/V.m/V.v</i>	<i>E.tet</i>
178	20	<i>E.tet</i>	<i>Em.n</i>	<i>E.tet</i>	<i>E.tet</i>
179	20	<i>E.tet</i>	<i>V.v-i</i>	<i>E.tet</i>	<i>E.tet</i>
180	20	<i>V.myr</i>	<i>V.v-i</i>	<i>V.v/V.m</i>	<i>Vacc.sp.</i>
181	20	<i>E.tet</i>	<i>V.v-i</i>	<i>E.t/V.m/V.v</i>	<i>E.tet</i>
182	20	<i>E.tet</i>	<i>Em.n</i>	-	<i>E.tet</i>
183	20	<i>E.t/V.m</i>	<i>Em.n</i>	<i>E.t/V.m/V.v</i>	
184	20	<i>E.cin</i>	<i>E.tet</i>	<i>E.tet</i>	
185	20	<i>E.tet</i>	<i>V.v-i</i>	<i>E.tet</i>	<i>E.tet</i>
186	20	<i>E.tet</i>	<i>Em.n</i>	<i>E.t/V.v</i>	<i>E.tet</i>
187	20	<i>E.tet</i>	<i>Em.n</i>	<i>E.tet</i>	<i>E.tet</i>
188	20	<i>V.myr</i>	<i>V.v-i</i>	<i>E.tet</i>	
189	20	-	<i>Em.n</i>	<i>V.m/V.v/Em</i>	
190	20	<i>E.tet</i>	<i>Em.n</i>	<i>E.tet</i>	<i>E.tet</i>
191	20	<i>E.tet</i>	<i>Em.n</i>	<i>E.tet</i>	<i>E.tet</i>
192	20	-	<i>A.u-u</i>	<i>A.u-u/E.c</i>	
193	20	-	<i>V.myr</i>	<i>V.m/V.v</i>	<i>Vacc.sp.</i>
194	24	<i>E.tet</i>	<i>V.myr</i>	<i>E.t/V.m</i>	<i>E.tet</i>
195	24	<i>E.tet</i>	<i>V.myr</i>	<i>E.t/V.m/V.v</i>	<i>E.tet</i>
196	24	<i>E.tet</i>	<i>V.v-i</i>	<i>E.tet</i>	<i>E.tet</i>
197	24	<i>E.tet</i>	<i>V.myr</i>	<i>E.tet</i>	<i>E.tet</i>

No.	Depth (cm)	Identity by inspection	CVA highest prob. group	CVA + other characters	ID used in pollen diagram
198	24	<i>E.tet</i>	<i>E.tet</i>	<i>E.tet</i>	<i>E.tet</i>
199	24	<i>E.tet</i>	<i>E.tet</i>	<i>E.tet</i>	<i>E.tet</i>
200	24	<i>E.tet</i>	<i>Em.n</i>	<i>E.tet</i>	<i>E.tet</i>
201	24	<i>E.tet</i>	<i>V.myr</i>	<i>V.m/V.v</i>	
202	24	<i>E.tet</i>	<i>E.tet</i>	<i>E.t/V.m</i>	<i>E.tet</i>
203	24	<i>E.tet</i>	<i>V.myr</i>	<i>E.t/V.m</i>	<i>E.tet</i>
204	24	<i>E.cin</i>	<i>V.myr</i>	<i>E.cin</i>	<i>E.cin</i>
205	24	<i>E.t/Em</i>	<i>V.v-i</i>	<i>E.tet</i>	<i>E.tet</i>
206	24	<i>E.t/Em</i>	<i>V.myr</i>	<i>E.t/V.m</i>	<i>E.tet</i>
207	24	<i>E.tet</i>	<i>A.u-u</i>	<i>V.m/E.t</i>	
208	24	<i>E.tet</i>	<i>V.v-i</i>	<i>E.t/V.m</i>	<i>E.tet</i>
209	24	<i>E.tet</i>	<i>V.myr</i>	<i>E.tet</i>	<i>E.tet</i>
210	24	<i>E.tet</i>	<i>V.v-i</i>	<i>E.tet</i>	<i>E.tet</i>
211	24	-	<i>V.myr</i>	<i>E.t/V.m</i>	
212	24	<i>E.tet</i>	<i>E.tet</i>	<i>E.t/V.m</i>	
213	24	<i>E.cin</i>	<i>A.u-u</i>	<i>A.u-u</i>	
214	24	<i>E.cin</i>	<i>A.u-u</i>	<i>A.u-u/E.c</i>	<i>E.cin</i>
215	32	-	<i>E.tet</i>	<i>E.tet</i>	<i>E.tet</i>
216	34	<i>E.cin</i>	<i>V.myr</i>	<i>E.cin</i>	<i>E.cin</i>
217	38	<i>E.cin</i>	<i>E.tet</i>	<i>E.tet</i>	
218	38	-	<i>Em.n</i>	<i>E.tet</i>	<i>E.tet</i>
219	38	-	<i>Em.n</i>	<i>E.tet</i>	<i>E.tet</i>
220	38	<i>E.tet</i>	<i>V.v-i</i>	<i>E.tet</i>	<i>E.tet</i>
221	40	<i>E.cin</i>	<i>E.cin</i>	<i>E.cin</i>	<i>E.cin</i>
222	56	-	<i>E.cin</i>	<i>E.cin</i>	<i>E.cin</i>
223	56	<i>V.m/V.v</i>	<i>V.v-i</i>	<i>V.v-i</i>	<i>Vacc.sp.</i>

no. cases = 78

Agreement between methods of identification					
CVA-highest prob. group vs ID by inspection				CVA+Other Chars. vs ID by inspection	
		cases	percent	cases	percent
agreement	full	10	13%	30	38%
	part	4	5%	30	38%
part+part				2	3%
SUM		14	18%	62	79%
NO agreement		64	82%	16	21%

#### Abbreviations

<i>Arctostaphylos uva-ursi</i>	<i>A.u-u</i>	<i>Vaccinium myrtillus</i>	<i>V.myr</i>	<i>V.m</i>
<i>Calluna vulgaris</i>	<i>C.v.</i>	<i>Vaccinium vitis-idaea</i>	<i>V.v-i</i>	<i>V.v</i>
<i>Erica cinerea</i>	<i>E.cin</i>	<i>Empetrum nigrum</i>	<i>Em.n</i>	<i>Em</i>
<i>Erica tetralix</i>	<i>E.tet</i>			

#### Canonical Variates Analysis

Identity

Alternatives (eg. *E.t/V.m*) with both methods+ agreement between at least one pair prob.

CVA

ID

part+part

probability

Appendix 20

Occurrence of Ericales fossil and surface pollen  
as identified after further analysis (AFA)

Number of tetrads

Depth (cm)	<i>A.u-u</i>	<i>E.cin</i>	<i>E.tet</i>	<i>Vacc.sp.</i>	Uncertain	Total
0			1		2	3
3	1		8		1	10
6			5			5
10			3			3
16						
20			19	2	5	26
24		2	14		5	21
28						
32			1			1
34		1				1
36						
38			3		1	4
40		1				1
44						
48						
56		1		1		2
64						
72						
80						
100						
Totals	1	5	54	3	14	77

Abbreviations in previous Appendix

Appendix 21

Charcoal particles in 0.5 cm<sup>3</sup> peat samples

Profile A

Depth (cm)	Pollen slide charcoal (per 100 pollen)	Particles over six 1cm squares on a petri dish		
		< 0.2mm	0.2-2.0mm	> 2.0mm
0	32	no data	no data	
3	10	273	3	none
6	164	105	14	..
10	173	167	34	..
16	140	307	2	..
20	115	133	25	..
24	21	80	1	..
28	no data	375		..
32	26	135		..
34	no data	448		..
36	no data	164	165	..
38	no data	252	8	..
40	44	115	2	..
44	no data	465		..
48	64	207		..
56	59	135		..
64	526	209	23	..
72	44	382		..
80	27	149	1	..
100	32	117		..

Profile B

Depth (cm)	Pollen slide charcoal (per 100 pollen)	Particles over six 1cm squares on a petri dish		
		< 0.2mm	0.2-2.0mm	> 2.0mm
3	9	134	12	none
6	no data	236	3	..
10	no data	280	15	..
20	no data	539	34	..

