

Durham E-Theses

A dermatoglyphic investigation of selected skin disorders

David Blackwell

How to cite:

Blackwell, David (1994) A dermatoglyphic investigation of selected skin disorders. Doctoral thesis, Durham University.

Use policy

The full-text may be used and/or reproduced, and given to third parties in any format or medium, without prior permission or charge, for personal research or study, educational, or not-for-profit purposes provided that:

- a full bibliographic reference is made to the original source
- a <https://etheses.durham.ac.uk/id/eprint/5536/> is made to the metadata record in Durham E-Theses
- the full-text is not changed in any way

The full-text must not be sold in any format or medium without the formal permission of the copyright holders.

Please consult the [full Durham E-Theses policy](#) for further details.

A Dermatoglyphic Investigation of Selected Skin Disorders
in two volumes
Volume Two.

David Blackwell

The copyright of this thesis rests with the author.
No quotation from it should be published without
his prior written consent and information derived
from it should be acknowledged.

Thesis submitted for the degree of Doctor of Philosophy
Department of Anthropology
University of Durham

1994



12 SEP 1994

CONTENTS

VOLUME TWO

CHAPTER SEVEN RESULTS: PART TWO - MAIN SAMPLE: VARIABLES ON PALMS

7.1	Palmar Patterns	568
(a)	Palmar Pattern Occurrence	568
(b)	Interdigital Pattern Intensity Indices	600
(c)	Hypothenar Pattern Intensity Indices	614
7.2	Palmar Triradii	627
(a)	accessory triradii	627
(b)	axial triradii	627
(c)	axial triradial counts	636
(d)	Palmar Pattern Intensity Indices	636
(e)	Maximal atd angles	651
7.3	Palmar Ridge Counts	666
(a)	Individual Ridge Counts	666
(b)	Summed Palmar Ridge Counts	686
(d)	Factor Analysis - Palmar Ridge Counts	705
7.4	Palmar Mainline Directions	718
7.5	Palmar Flexion Creases	725
7.6	Palmar Ridge Disturbances	732

CHAPTER EIGHT - RESULTS: PART THREE - SMALLER STUDIES OF RARE

DISORDERS

8.1	Introduction	742
8.2	Dermatitis Herpetiformis and Coeliac Disease	742
(a)	Finger Patterns	742
(i)	Finger Pattern Types	742
(ii)	Ulnar and Radial Loop Scores	759
(iii)	Finger Delta Scores	776
(iv)	Finger Pattern Intensity Indices	791
(b)	Finger Ridge Counts	794
(i)	Individual Finger Ridge Counts	794
(ii)	Unilateral Finger Ridge Counts	808
(iii)	Absolute Ridge Counts	819
(iv)	Summed Ulnar and Radial Counts	833
(v)	Summed Radial and Ulnar Counts	844
(vi)	Summed Unilateral Ridge Counts	847
(vii)	Summed Absolute Ridge Counts	850
(c)	Finger Ridge Disturbances	862
(i)	White Lines	862
(ii)	Finger Ridge Hyperlinearity	866
(iii)	Discriminant Analysis	870
(iv)	Ridge Atrophy	881

(d) Palmar Patterns	884
(i) Palmar Pattern Occurrence	884
(ii) Hypothenar Pattern Intensity Indices	899
(iii) Interdigital Pattern Intensity Indices	902
(e) Palmar Triradii	905
(i) Accessory Triradii	905
(ii) Axial Triradii	908
(iii) Axial Triradial Counts	911
(iv) Palmar Pattern Intensity Indices	914
(v) Maximal atd angles	917
(f) Palmar Ridge Counts	920
(i) Individual and Summed Ridge Counts	920
(ii) Summed Total Palmar Ridge Counts	929
(iii) Factor Analysis	932
(g) Palmar Mainline Direction	937
(h) Palmar Flexion Creases	941
(i) Transverse Flexion Crease	941
(ii) Thenar Flexion Creases	944
(i) Palmar Ridge Disturbances	947
(i) Ridge Atrophy	947
(ii) Hyperlinearity	950
8.3 Incontinentia Pigmenti	952
8.4 Anhidrotic Ectodermal Dysplasia	960
8.5 Darier's Disease	961
(i) Introduction	961
(ii) Finger Ridge Counts	967
(iii) Finger Patterns	989
(iv) Finger Ridge Disturbances	1000
(v) Palmar Patterns	1015
(vi) Palmar Triradii	1023
(vii) Palmar Ridge Disturbances	1025
(viii) Pits and Plaques	1028

CHAPTER NINE: DISCUSSION AND CONCLUSIONS

9.1 Introduction	1029
9.2 Individual Skin Disorders	1029
(a) Psoriasis	1030
(b) Atopic Eczema	1032
(c) Alopecia areata	1034
(d) Vitiligo	1037
(e) BCC	1040
(f) Actinic keratosis	1042
(g) Dermatitis Herpetiformis	1044
9.3 Families of Skin Disorders	1046
(i) Finger Patterns	1046
(ii) Finger Ridge Counts	1047
(iii) Finger Ridge Disturbances	1049
(iv) Palmar Patterns	1049
(v) atd angles	1050
(vi) Palmar Ridge Counts	1050

9.4	Physical Effects of Skin Disorders on Epidermal Ridges	1050
	(i) Atopic Eczema	1050
	(ii) Dermatitis herpetiformis and coeliac disease	1052
	(iii) IP and AED	1053
	(iv) Darier's Disease	1053
	(v) Usefulness of physical changes of ridges in diagnosis	1054
9.5	Conclusions related to the original aims and objectives	1054
9.6	Critical Appraisal and Concluding Remarks	1056
	BIBLIOGRAPHY	1071
	ADDENDUM	1091
	APPENDIX 1 - Self Printing Kit	1092
	APPENDIX 2 - Computer data sheet and variable coding information	1098
	APPENDIX 3 - Subject data obtained from questionnaires	1107
	APPENDIX 4 - Assessment of epidermal ridge pitting in Darriers disease	1111
	APPENDIX 5 - Method for Sweat Pore Counting	1113

Volume One contains pages 1 - 567

Volume Two contains pages 568 - 1114

CHAPTER SEVEN - RESULTS: PART TWO - MAIN SAMPLE: VARIABLES ON PALMS

7.1 Palmar Patterns

(a) Palmar Pattern Occurrence (Variables PTL to PARR)

The percentage frequencies of occurrence of pattern (loops) in each of the palmar areas are shown for male subjects in Table 7.1. The results for the left hand are shown in Table 7.1(a) and those for the right hand are set out in Table 7.1(b). The results of intergroup comparisons using the Mann-Whitney U Test are shown in Tables 7.2(a) and (b).

On the thenar area of the left hand, vitiligo patients had a statistically significantly higher frequency of occurrence of peripheral pattern in comparison to controls and to alopecia areata subjects. Actinic keratosis male subjects showed a significantly lower occurrence of radial pattern on the thenar area in comparison to controls, psoriasis and to vitiligo. On the right hand atopic eczema males showed a highly significantly greater incidence of peripheral pattern on the thenar area in comparison to controls and BCC and a significantly greater incidence compared to psoriasis. Vitiligo males were found to have significantly higher incidence of radial loops in comparison to alopecia areata and controls and a significantly lower incidence of peripheral loops in comparison to actinic keratosis male subjects. Actinic keratosis males were found to have significantly lower frequency of occurrence of radial loops on the thenar area of the right hand (see Table 7.1 and 7.2).

On the second interdigital area (I_2) of both hands no significant differences were found for the frequency of occurrence of either peripheral or central pattern. For I_3 no significant differences were found for occurrence of central patterns on either hand but statistically significant differences were found for peripheral pattern occurrence. Actinic keratosis males had a highly significantly greater frequency of occurrence of peripheral loops in comparison to alopecia areata, vitiligo, atopic eczema and controls, for both hands, and compared to BCC for the left hand only. Psoriasis male subjects were found to have a highly significant

increase in occurrence of peripheral loops on I_3 when compared to atopic eczema, vitiligo and alopecia areata for both hands and a significant increase compared with controls on the left hand only. BCC males were found to have significantly greater occurrence of peripheral loops when compared to vitiligo, on both hands, and when compared to alopecia areata and atopic eczema for the left hand only.

On I_4 , no significant differences were found for frequency of occurrence of either central or ulnar patterns. For peripheral patterns, however, actinic keratosis males were found to have a significantly decreased incidence on both hands in comparison to atopic eczema, vitiligo and alopecia areata. A highly significantly lower incidence for peripheral patterns was also found for actinic keratosis in comparison to controls on the left hand only. Controls were found to have a significantly increased incidence of peripheral patterns on I_4 of the left hand in comparison to psoriasis, BCC and actinic keratosis. Atopic eczema males had a significantly higher incidence of peripheral patterns on left hand I_4 compared to psoriasis, BCC and actinic keratosis (both hands). Also BCC males had a significantly lower incidence compared to vitiligo, controls and atopic eczema on the left hand only. The results for peripheral patterns on I_4 were directly the reverse to those found for I_3 .

In the hypothenar area, a statistically significant increase in peripheral loop incidence was found on both hands for male psoriatics compared to alopecia areata males and on the right hand only in comparison to vitiligo male subjects. For central loops in the hypothenar area a statistically significant increase was found in atopic eczema males in comparison to psoriasis, BCC and vitiligo males, on both hands, compared to controls on the right hand only and actinic keratosis on the left hand only. Also, for the right hand only, significantly lower incidences of central loops were found for alopecia areata males compared to BCC, vitiligo and controls and for BCC males compared to actinic keratosis and psoriasis. For radial loops on the hypothenar area, psoriasis male subjects were found to have statistically significantly increased occurrence compared to controls, vitiligo and to BCC. On the right hand, radial hypothenar loop incidence was found to be significantly decreased in actinic keratosis patients, in fact none were recorded, in comparison to all the other groups apart from vitiligo.

Table Percentage Frequencies : Palmar Pattern Occurrence
 7.1(a)
 Males — Left Hands

		Percentage Frequencies														
Group	Cases	PTL		RTL		P2L		C2L		P3L		C3L		P4L		
		0	1	0	1	0	1	0	1	0	1	0	1	0	1	2
Controls	206	92.7	7.3	93.6	6.4	97.6	2.4	100.0	0.0	46.3	53.7	99.5	0.5	39.0	60.0	1.0
Psoriasis	202	92.1	7.9	92.6	7.4	96.5	3.5	100.0	0.0	32.7	67.3	100.0	0.0	48.5	51.5	0.0
Atop Ecz	203	87.2	12.8	94.1	5.9	97.0	3.0	100.0	0.0	51.7	48.3	100.0	0.0	36.5	63.1	0.5
Vitiligo	201	86.1	13.9	92.0	8.0	97.5	2.5	100.0	0.0	53.2	46.8	100.0	0.0	40.3	58.7	1.0
Alop Are	209	92.8	7.2	96.2	3.8	98.1	1.9	100.0	0.0	49.5	50.5	100.0	0.0	45.2	53.3	1.4
BCC	211	91.0	9.0	94.8	5.2	96.2	3.8	100.0	0.0	37.4	62.6	99.5	0.5	51.7	47.9	0.5
Act Ker	129	91.5	8.5	98.4	1.6	96.1	3.9	100.0	0.0	21.7	78.3	99.2	0.8	57.4	41.9	0.8

		Percentage Frequencies																
Group	Cases	C4L		U4L		PHL			CHL		RHL		UHTL		PARL		HARL	
		0	1	0	1	0	1	2	0	1	0	1	0	1	0	1	0	1
Controls	206	100.0	0.0	98.0	2.0	87.8	12.2	0.0	71.2	28.8	99.0	1.0	100.0	0.0	100.0	0.0	98.5	1.5
Psoriasis	202	99.5	0.5	99.5	0.5	80.7	18.8	0.5	76.2	23.8	97.6	2.4	100.0	0.0	100.0	0.0	100.0	0.0
Atop Ecz	203	100.0	0.0	99.0	1.0	85.2	14.8	0.0	62.4	37.6	99.0	1.0	100.0	0.0	100.0	0.0	99.5	0.5
Vitiligo	201	100.0	0.0	99.5	0.5	87.6	12.4	0.0	74.1	25.9	97.6	2.4	100.0	0.0	99.5	0.5	100.0	0.0
Alop Are	209	99.5	0.0	98.6	1.4	89.0	11.0	0.0	70.0	30.0	98.1	1.9	100.0	0.0	99.5	0.5	99.5	0.5
BCC	211	100.0	0.0	86.3	13.7	86.3	13.7	0.0	75.8	24.2	97.5	2.5	100.0	0.0	100.0	0.0	99.1	0.9
Act Ker	129	99.2	0.8	99.2	0.8	86.8	13.2	0.0	76.0	24.0	99.4	0.6	100.0	0.0	100.0	0.0	100.0	0.0

Table Percentage Frequencies : Palmar Pattern Occurrence
 7.1(b)
 Males — Right Hand

Group	Cases	Variable and Percentage Frequencies																	
		PTR		RTR		P2R		C2R		P3R			C3R		P4R			C4R	
		0	1	0	1	0	1	0	1	0	1	2	0	2	0	1	2	0	1
Controls	205	95.6	4.4	96.6	3.4	94.6	5.4	100.0	0.0	37.6	62.4	0.0	99.5	0.5	51.2	47.8	1.0	99.0	1.0
Psoriasis	202	93.6	6.4	92.6	7.4	96.5	3.5	100.0	0.0	29.7	69.3	1.0	100.0	0.0	49.0	50.5	0.5	99.5	0.5
Atop Ecz	203	87.2	12.8	94.1	5.9	98.0	2.0	100.0	0.0	41.9	58.1	0.0	100.0	0.0	43.8	56.2	0.0	100.0	0.0
Vitiligo	201	92.0	8.0	90.5	9.5	98.0	2.0	100.0	0.0	46.3	53.7	0.0	100.0	0.0	47.3	52.7	0.0	100.0	0.0
Alop Are	210	93.3	6.7	96.7	3.3	97.6	2.4	100.0	0.0	44.3	55.7	0.0	100.0	0.0	46.7	52.9	0.5	100.0	0.0
BCC	211	96.2	3.8	94.8	5.2	97.6	2.4	100.0	0.0	36.0	64.0	0.0	100.0	0.0	51.2	48.8	0.0	100.0	0.0
Act Ker	219	90.7	9.3	98.4	1.6	97.7	2.3	100.0	0.0	27.1	72.9	0.0	98.4	0.6	58.9	41.1	0.0	100.0	0.0

Group	Cases	Variable and Percentage Frequencies															
		U4R		PHR			CHR			RHR		UHTR		PARR		HRAR	
		0	1	0	1	2	0	1	2	0	1	0	1	0	1	0	1
Controls	206	99.5	0.5	87.3	12.7	0.0	76.6	23.4	0.0	94.6	5.4	100.0	0.0	100.0	0.0	99.0	1.0
Psoriasis	202	99.5	0.5	82.7	17.3	0.0	71.3	28.7	0.0	96.5	3.5	100.0	0.0	100.0	0.0	99.0	1.0
Atop Ecz	203	99.5	0.5	85.7	14.3	0.0	61.1	38.9	0.0	96.6	3.4	100.0	0.0	100.0	0.0	99.5	0.5
Vitiligo	200	99.0	1.0	89.5	10.5	0.0	74.6	25.4	0.0	98.5	1.5	100.0	0.0	100.0	0.0	100.0	0.0
Alop Are	210	100.0	0.0	89.5	10.5	0.0	65.7	33.3	0.0	96.7	3.3	100.0	0.0	100.0	0.0	99.5	0.5
BCC	211	100.0	0.0	84.4	15.6	0.0	80.1	19.9	0.0	94.8	5.2	100.0	0.0	100.0	0.0	99.1	0.9
Act Ker	129	100.0	0.0	89.1	10.9	0.0	69.0	31.0	0.0	100.0	0.0	100.0	0.0	100.0	0.0	100.0	0.0

Table Mann-Whitney U Test Results
7.2(a)
Palmar Patterns

Left Hand : Males

Group 1	Group 2	Probability								
		PTL	RTL	P2L	C2L	P3L	C3L	P4L	C4L	U4L
Control	Psoriasis	0.8186	0.6758	0.5410	1.0000	0.0049**	0.3209	0.0431*	0.3137	0.1829
Control	Atop Ecz	0.0654	0.8465	0.7476	1.0000	0.2774	0.3197	0.6414	1.0000	0.4182
Control	Vitiligo	0.0306*	0.5360	0.9749	1.0000	0.1654	0.3221	0.7986	1.0000	0.1848
Control	Alop Are	0.9562	0.2353	0.7091	1.0000	0.5170	0.3115	0.2298	0.3231	0.6797
Control	BCC	0.5304	0.6134	0.4286	1.0000	0.0661	0.9837	0.0090**	1.0000	0.1674
Control	Act Ker	0.6882	0.0390*	0.4538	1.0000	0.0000**	0.7407	0.0012**	0.2074	0.3895
Psoriasis	Atop Ecz	0.1072	0.5418	0.7714	1.0000	0.0001**	1.0000	0.0124*	0.3161	0.5656
Psoriasis	Vi tiligo	0.0534	0.8406	0.5641	1.0000	0.0000**	1.0000	0.0791	0.3183	0.9972
Psoriasis	Alop Are	0.7756	0.1104	0.3265	1.0000	0.0005**	1.0000	0.4170	0.9781	0.3346
Psoriasis	BCC	0.6929	0.3553	0.8596	1.0000	0.3108	0.3279	0.5567	0.3068	0.9734
Psoriasis	Act Ker	0.8444	0.0184*	0.8457	1.0000	0.0312*	0.2108	0.1346	0.7488	0.7488
Atop Ecz	Vitiligo	0.7406	0.4181	0.7728	1.0000	0.7616	1.0000	0.4717	1.0000	0.5685
Atop Ecz	Alop Are	0.0566	0.3204	0.4878	1.0000	0.6552	1.0000	0.0949	0.3255	0.6808
Atop Ecz	BCC	0.2145	0.7569	0.6385	1.0000	0.0035**	0.3267	0.0020**	1.0000	0.5403
Atop Ecz	Act Ker	0.2277	0.0543	0.6484	1.0000	0.0000**	0.2097	0.0002**	0.2097	0.8440
Vitiligo	Alop Are	0.0259*	0.0732	0.6869	1.0000	0.4525	1.0000	0.3472	0.3279	0.3371
Vitiligo	BCC	0.1164	0.2607	0.4497	1.0000	0.0013*	0.3291	0.0193*	1.0000	0.9726
Vitiligo	Act Ker	0.1385	0.0125*	0.4735	1.0000	0.0000**	0.2119	0.0027**	0.2119	0.7515
Alop Are	BCC	0.4928	0.4884	0.2453	1.0000	0.0125*	0.3185	0.1621	0.3162	0.3133
Alop Are	Act Ker	0.6514	0.2333	0.2737	1.0000	0.0000**	0.2020	0.0289*	0.7275	0.5891
BCC	Act Ker	0.8804	0.0879	0.9686	1.0000	0.0025**	0.7249	0.3226	0.2009	0.7249

Table Mann-Whitney U Test Results
 7.2(a) continued
 Palmar Pattern Occurrence

Left hand : Males

Group 1	Group 2	Probability (* = significant, ** - highly significant)					
		PHL	CHL	RHL	UHTL	HARL	PARL
Control	Psoriasis	0.0472*	0.2508	0.0179*	1.0000	0.0848	1.0000
Control	Atop Ecz	0.4455	0.0585	0.4045	1.0000	0.3203	1.0000
Control	Vitiligo	0.9408	0.5112	0.9842	1.0000	0.0856	0.3125
Control	Alop Are	0.6926	0.7854	0.0601	1.0000	0.3040	0.3231
Control	BCC	0.6388	0.2871	0.6767	1.0000	0.6299	1.0000
Control	Act Ker	0.7922	0.3416	0.6387	1.0000	0.1682	1.0000
Psoriasis	Atop Ecz	0.2188	0.0026**	0.1011	1.0000	0.3185	1.0000
Psoriasis	Vi tiligo	0.0574	0.6246	0.0197*	1.0000	1.0000	0.3161
Psoriasis	Alop Are	0.0172*	0.1542	0.5716	1.0000	0.3267	0.3267
Psoriasis	BCC	0.1235	0.9227	0.0403*	1.0000	0.1659	1.0000
Psoriasis	Act Ker	0.1434	0.9555	0.1071	1.0000	1.0000	1.0000
Atop Ecz	Vitiligo	0.4933	0.0144*	0.4183	1.0000	0.3197	0.3149
Atop Ecz	Alop Are	0.2457	0.1022	0.2665	1.0000	0.9809	0.3255
Atop Ecz	BCC	0.7637	0.0031**	0.6655	1.0000	0.5855	1.0000
Atop Ecz	Act Ker	0.6840	0.0100**	0.7798	1.0000	0.4254	1.0000
Vitiligo	Alop Are	0.6397	0.3518	0.0645	1.0000	0.3279	0.9753
Vitiligo	BCC	0.6949	0.6907	0.6929	1.0000	0.1670	0.3056
Vitiligo	Act Ker	0.8441	0.7075	0.6533	1.0000	1.0000	0.4231
Alop Are	BCC	0.3846	0.1789	0.1251	1.0000	0.5656	0.3162
Alop Are	Act Ker	0.5380	0.2340	0.2333	1.0000	0.4332	0.4232
BCC	Act Ker	0.8825	0.9767	0.9240	1.0000	0.2681	1.0000

Table 7.2(b) Mann-Whitney U Test Results

Palmar Patterns

Right Hand - Males

		Probability for Variables (* = Significant, ** = Highly Significant)								
Group 1	Group 2	PTR	RTR	P2R	C2R	P3R	C3R	P4R	C4R	U4R
Control	Psoriasis	0.3621	0.0739	0.3517	1.0000	0.0721	0.3209	0.6949	0.5714	0.9917
Control	Atop Ecz	0.0024**	0.2320	0.0688	1.0000	0.3741	0.3197	0.1689	0.1588	0.9945
Control	Vitiligo	0.1351	0.0131*	0.0717	1.0000	0.0757	0.3221	0.4897	0.1609	0.5512
Control	Alop Are	0.3115	0.9635	0.1148	1.0000	0.1642	0.3115	0.3872	0.1518	0.3115
Control	BCC	0.7581	0.3679	0.1126	1.0000	0.7447	0.3103	0.9285	0.1509	0.3103
Control	Act Ker	0.0722	0.3064	0.1777	1.0000	0.0497*	0.3170	0.1498	0.2612	0.4276
Psoriasis	Atop Ecz	0.0299*	0.5418	0.3554	1.0000	0.0078**	1.0000	0.3252	0.3161	0.9972
Psoriasis	Vitiligo	0.5542	0.4647	0.3641	1.0000	0.0004**	1.0000	0.7660	0.3185	0.5598
Psoriasis	Alop Are	0.9246	0.0651	0.5134	1.0000	0.0016**	1.0000	0.6384	0.3079	0.3079
Psoriasis	BCC	0.2220	0.3553	0.5080	1.0000	0.1354	1.0000	0.6243	0.3068	0.3068
Psoriasis	Act Ker	0.3365	0.0184*	0.5552	1.0000	0.7192	0.0763	0.0732	0.4242	0.4242
Atop Ecz	Vitiligo	0.1109	0.1817	0.9887	1.0000	0.3740	1.0000	0.4905	1.0000	0.5569
Atop Ecz	Alop Are	0.0351*	0.2118	0.7754	1.0000	0.6209	1.0000	0.6027	1.0000	0.3081
Atop Ecz	BCC	0.0008**	0.7569	0.7809	1.0000	0.2226	1.0000	0.1353	1.0000	0.3080
Atop Ecz	Act Ker	0.3288	0.0543	0.8265	1.0000	0.0065**	0.0756	0.0075**	1.0000	0.4254
Vitiligo	Alop Are	0.6147	0.0109*	0.7869	1.0000	0.6888	1.0000	0.8636	1.0000	0.1478
Vitiligo	BCC	0.0713	0.0982	0.7924	1.0000	0.0347*	1.0000	0.4267	1.0000	0.1469
Vitiligo	Act Ker	0.6699	0.0042**	0.8367	1.0000	0.0005**	0.0771	0.0390*	1.0000	0.2565
Alop Are	BCC	0.1855	0.3410	0.9939	1.0000	0.0840	1.0000	0.3307	1.0000	1.0000
Alop Are	Act Ker	0.3767	0.3222	0.9740	1.0000	0.0016**	0.0708	0.0265*	1.0000	1.0000
BCC	Act Ker	0.0364*	0.0879	0.9793	1.0000	0.0904	0.0701	0.1658	1.0000	1.0000

Table Mann-Whitney U Test Results
 7.2(b) continued
 Palmar Patterns

Right Hand - Males

Group 1	Group 2	Probabilities (* = Significant, ** = Highly Significant)					
		PHR	CHR	RHR	UHTR	HRAR	PARR
Control	Psoriasis	0.1900	0.2239	0.3517	1.0000	0.9882	1.0000
Control	Atop Ecz	0.6359	0.0007**	0.3462	1.0000	0.5685	1.0000
Control	Vitiligo	0.4934	0.6463	0.0327*	1.0000	0.1609	1.0000
Control	Alop Are	0.4827	0.0147*	0.3101	1.0000	0.5487	1.0000
Control	BCC	0.3880	0.3854	0.9446	1.0000	0.9767	1.0000
Control	Act Ker	0.6165	0.1257	0.0076**	1.0000	0.2612	1.0000
Psoriasis	Atop Ecz	0.4021	0.0302*	0.9925	1.0000	0.5598	1.0000
Psoriasis	Vi tiligo	0.0484*	0.4510	0.2036	1.0000	0.1578	1.0000
Psoriasis	Alop Are	0.0443*	0.2242	0.9411	1.0000	0.5402	1.0000
Psoriasis	BCC	0.6444	0.0370*	0.3850	1.0000	0.9651	1.0000
Psoriasis	Act Ker	0.1063	0.6561	0.0329*	1.0000	0.2577	1.0000
Atop Ecz	Vitiligo	0.2496	0.0036**	0.2064	1.0000	0.3197	1.0000
Atop Ecz	Alop Are	0.2400	0.3292	0.9486	1.0000	0.9809	1.0000
Atop Ecz	BCC	0.6999	0.0000**	0.3793	1.0000	0.5855	1.0000
Atop Ecz	Act Ker	0.3646	0.1436	0.0333*	1.0000	0.4254	1.0000
Vitiligo	Alop Are	0.9937	0.0488*	0.2265	1.0000	0.3279	1.0000
Vitiligo	BCC	0.1236	0.1850	0.0374*	1.0000	0.1679	1.0000
Vitiligo	Act Ker	0.9194	0.2645	0.1640	1.0000	1.0000	1.0000
Alop Are	BCC	0.1164	0.0009**	0.3410	1.0000	0.5656	1.0000
Alop Are	Act Ker	0.9131	0.5339	0.0364*	1.0000	0.4332	1.0000
BCC	Act Ker	0.2153	0.0204*	0.0085**	1.0000	0.2681	1.0000

Vitiligo males were found to have a significantly decreased radial hypothenar loop occurrence on the right hand when compared to BCC and to controls. No significant differences were found for any of the intergroup comparisons for hypothenar radial arch or ulnar hypothenar tented arch on for patterns in the parathenar area on either of the hands.

For male subjects there were no significant differences for peripheral thenar patterns (see Table 7.4). Alopecia areata males were found to have significantly decreased incidence in radial thenar patterns compared to both psoriasis and atopic eczema on the left hand. On the right palm, BCC males were found to have a statistically significantly reduced occurrence of radial thenar patterns compared to psoriasis and controls. No significant differences were found on I_2 for either peripheral or central patterns on either hand. On I_3 , no significant differences were found for central patterns on either hand but on the left hand control females were found to have a statistically significantly lower incidence of peripheral patterns when compared to BCC and alopecia areata. For I_3 on the right hand, actinic keratosis females were found to have a statistically significantly greater frequency of peripheral patterns in comparison to vitiligo females (Table 7.3). On interdigital area I_4 of the left hand, peripheral loop occurrence was found to be significantly higher in controls compared to all of the other groups (Table 7.4(a)). On the right hand I_4 , vitiligo females had a significantly greater frequency of peripheral loops in comparison to atopic eczema females. Vitiligo females were found to have a statistically significantly reduced occurrence of ulnar patterns in comparison to controls on I_4 of the left hand. No significant differences were found for ulnar loop occurrence on right hand I_4 or for central loop occurrence on either hand.

Female control subjects were found to have a statistically significant decrease in peripheral loops in comparison to all of the other groups on the right hand. No significant differences for hypothenar peripheral loop occurrence on the left hand were found nor were any found for hypothenar radial loop occurrence on either hand. Female controls were found to have a statistically significant decrease in central loop occurrence compared to alopecia areata and actinic keratosis on the left hand. Actinic keratosis females were

found to have highly significantly increased occurrence of hypothenar central loops on the right hand in comparison to controls, psoriasis, atopic eczema and vitiligo. In addition alopecia areata females were shown to have a statistically significantly higher occurrence of hypothenar central loops in comparison to atopic eczema females on the right hand (Tables 7.3 and 7.4). No statistically significant differences were found for ulnar hypothenar tented patterns, hypothenar radial arches or parathenar patterns on either hand for any of the intergroup comparisons using the Mann-Whitney U Tests (Table 7.4).

Discriminant analysis was carried out for male subjects using the variables PTL to HRAR. Table 7.5 shows the Canonical Discriminant Functions. As can be seen Function 1 accounts for 41.9% of the variance and Function 2 takes out another 24.17%. The Standardized Canonical Discriminant Function coefficients are shown in Table 7.6. From Table 7.7 it can be seen that peripheral patterns on I_3 and I_2 of both hands and I_3 right hand are important in the first two functions along with U4R and CH on both hands and HARL. The F Statistics and significances (Table 7.8) show that the groups which are most separated are vitiligo and actinic keratosis ($F = 5.4114$) followed by atopic eczema and actinic keratosis ($F = 4.8259$).

The territorial map shows actinic keratosis and vitiligo and atopic eczema and BCC to be the most separated (Figure 7.1). The scatterplot shows the distribution of the various groups (Figure 7.2) and the group centroid relationships are shown in Figure 7.3. Actinic keratosis is removed from the other groups with psoriasis being closest to it. Atopic eczema and alopecia areata and controls and BCC are grouped together with vitiligo being the group furthest to the left.

The classification results (Table 7.9) show 22.60% correct classification using this set of variables. BCC (36.5% correct) and vitiligo (34.3% correct) are the best classified groups.

Table 7.10 shows the Canonical Discriminant Functions produced for females using variable PTL to HRAR. Function 1 accounts for 49.32% of the variance and Function 2 accounts for another 17.07%. It can be seen from Table 7.12 that I_4 and hypothenar patterns are most important in Functions 1 and 2. The F Statistics in Table 7.13

Table Percentage Frequencies : Palmar Pattern Occurrence

7.3(a)

Females — Left Hand

Group	Cases	Percentage Frequencies																	
		PTL		RTL		P2L		C2L		P3L			C3L		P4L			C4L	
		0	1	0	1	0	1	0	1	0	1	2	0	2	0	1	2	0	1
Controls	203	92.1	7.9	94.6	5.4	98.5	1.5	100.0	0.0	51.2	48.3	0.5	99.5	0.5	36.9	62.1	1.0	99.0	1.0
Psoriasis	205	92.7	7.3	94.1	5.9	98.5	1.5	100.0	0.0	43.9	56.1	0.0	100.0	0.0	51.2	48.3	0.5	99.0	1.0
Atop Ecz	203	91.1	8.9	93.6	6.4	99.0	1.0	100.0	0.0	43.8	56.2	0.0	100.0	0.0	48.8	50.7	0.5	99.5	0.5
Vitiligo	205	90.2	9.8	95.6	4.4	96.6	3.4	100.0	0.0	43.9	56.1	0.0	100.0	0.0	49.8	49.8	0.5	100.0	0.0
Alop Are	206	92.2	7.8	98.1	1.9	96.6	3.4	100.0	0.0	46.1	53.9	0.0	100.0	0.0	50.5	49.5	0.0	100.0	0.0
BCC	202	90.6	9.4	97.0	3.0	98.5	1.5	100.0	0.0	40.6	59.4	0.0	99.5	0.5	53.5	46.5	0.0	100.0	0.0
Act Ker	174	94.3	5.7	96.6	3.4	97.1	2.9	100.0	0.0	39.1	60.9	0.0	100.0	0.0	51.7	48.3	0.0	100.0	0.0

Group	Cases	Percentage Frequencies															
		U4L		PHL			CHL		RHL		UH ¹ L		PARL		HARL		
		0	1	0	1	2	0	1	0	1	0	1	0	1	0	1	
Controls	203	97.5	2.5	85.7	13.8	0.5	76.4	23.6	99.0	1.0	100.0	0.0	100.0	0.0	100.0	0.0	
Psoriasis	205	98.5	1.5	81.5	18.5	0.0	73.2	26.8	97.6	2.4	100.0	0.0	100.0	0.0	99.5	0.5	
Atop Ecz	203	99.5	0.5	82.8	17.2	0.0	74.4	25.6	99.0	1.0	100.0	0.0	100.0	0.0	100.0	0.0	
Vitiligo	205	100.0	0.0	88.3	11.7	0.0	74.6	25.4	97.6	2.4	100.0	0.0	100.0	0.0	100.0	0.0	
Alop Are	206	99.5	0.5	84.0	16.0	0.0	65.5	34.5	98.1	1.9	100.0	0.0	100.0	0.0	99.5	0.5	
BCC	202	99.5	0.5	84.7	15.3	0.0	68.8	31.2	97.5	2.5	100.0	0.0	100.0	0.0	99.0	1.0	
Act Ker	174	98.9	1.1	85.6	14.4	0.0	66.7	33.3	99.4	0.6	100.0	0.0	100.0	0.0	100.0	0.0	

Table Percentage Frequencies : Palmar Pattern Occurrences
 7.3(b)
 Females — Right Hand

Group	Cases	Percentage Frequencies																	
		PTR		RTR		P2R		C2R		P3R			C3R		P4R			C4R	
		0	1	0	1	0	1	0	1	0	1	2	0	1	0	1	2	0	1
Controls	203	94.1	5.9	94.1	5.9	98.0	2.0	100.0	0.0	38.9	61.1	0.0	100.0	0.0	46.8	53.2	0.0	99.5	0.5
Psoriasis	205	95.1	4.9	93.7	6.3	98.0	2.0	100.0	0.0	38.5	61.5	0.0	100.0	0.0	49.8	50.2	0.0	99.5	0.5
Atop Ecz	203	93.6	6.4	95.6	4.4	98.5	1.5	100.0	0.0	35.5	64.5	0.0	100.0	0.0	54.7	45.3	0.0	100.0	0.0
Vitiligo	205	93.7	6.3	94.6	5.4	96.6	3.4	100.0	0.0	44.9	55.1	0.0	100.0	0.0	44.4	55.1	0.5	100.0	0.0
Alop Are	1.0	91.7	8.3	97.6	2.4	96.6	3.4	100.0	0.0	39.3	60.7	0.0	100.0	0.0	51.5	48.1	0.5	100.0	0.0
BCC	202	92.6	7.4	98.0	2.0	97.5	2.5	100.0	0.0	39.1	60.9	0.0	100.0	0.0	51.0	49.0	0.0	100.0	0.0
Act Ker	174	94.2	5.8	96.0	4.0	97.7	2.3	100.0	0.0	33.9	66.1	0.0	100.0	0.0	54.0	46.0	0.0	100.0	0.0

Group	Cases	Percentage Frequencies															
		U4R		PHR			CHR			RHR		UHTR		PARR		HRAR	
		0	1	0	1	2	0	1	2	0	1	0	1	0	1	0	1
Controls	203	99.5	0.5	92.6	6.9	0.5	74.4	25.1	0.5	98.5	1.5	99.0	1.0	100.0	0.0	99.0	1.0
Psoriasis	205	100.0	0.0	82.0	18.0	0.0	76.1	23.9	0.0	95.6	4.4	99.5	0.5	100.0	0.0	99.0	1.0
Atop Ecz	203	100.0	0.0	82.3	17.7	0.0	78.3	21.7	0.0	95.6	4.4	99.5	0.5	99.5	0.5	100.0	0.0
Vitiligo	205	99.0	1.0	85.4	14.6	0.0	76.1	23.9	0.0	97.6	2.4	100.0	0.0	100.0	0.0	100.0	0.0
Alop Are	206	99.0	1.0	84.0	15.5	0.5	68.4	31.6	0.0	98.1	1.9	100.0	0.0	100.0	0.0	99.5	0.5
BCC	202	100.0	0.0	84.7	15.3	0.0	70.3	29.2	0.5	96.0	4.0	100.0	0.0	100.0	0.0	98.5	1.5
Act Ker	174	100.0	0.0	83.3	16.7	0.0	61.5	37.9	0.6	97.1	2.9	100.0	0.0	100.0	0.0	100.0	0.0

Table Mann-Whitney U Test Results

7.4(a)

Palmar Pattern Occurrence

Left Hand : Females

		Probability (* = significant, ** = highly significant)								
Group 1	Group 2	PTL	RTL	P2L	C2L	P3L	C3L	P4L	C4L	U4L
Control	Psoriasis	0.8298	0.8491	0.9904	1.0000	0.1548	0.3149	0.0035**	0.9921	0.4671
Control	Atop Ecz	0.7204	0.6742	0.6531	1.0000	0.1524	0.3173	0.0150*	0.5627	0.1003
Control	Vitiligo	0.5050	0.6309	0.2064	0.3197	0.1548	0.3149	0.0085*	0.1548	0.0239*
Control	Alop Are	0.9656	0.0617	0.2092	1.0000	0.3278	0.3138	0.0044**	0.1538	0.0967
Control	BCC	0.5857	0.2198	0.9951	1.0000	0.0372*	0.9972	0.0006**	0.1578	0.1016
Control	Act Ker	0.4155	0.3587	0.3492	1.0000	0.0217*	0.3545	0.0031**	0.1898	0.3469
Psoriasis	Atop Ecz	0.5664	0.8170	0.6611	1.0000	0.9903	1.0000	0.6232	0.5685	0.3203
Psoriasis	Vi tiligo	0.3774	0.5020	0.2009	0.3173	1.0000	1.0000	0.7689	0.1568	0.0825
Psoriasis	Alop Are	0.8631	0.0406*	0.2036	1.0000	0.6523	1.0000	0.9206	0.1558	0.3132
Psoriasis	BCC	0.4469	0.1577	0.9855	1.0000	0.4998	0.3137	0.6183	0.1599	0.3227
Psoriasis	Act Ker	0.5400	0.2732	0.3419	1.0000	0.3434	1.0000	0.8861	0.1920	0.7898
Atop Ecz	Vitiligo	0.7576	0.3685	0.0952	0.3197	0.9903	1.0000	0.8428	0.3149	0.3149
Atop Ecz	Alop Are	0.6874	0.0240*	0.0967	1.0000	0.6443	1.0000	0.6924	0.3138	0.9917
Atop Ecz	BCC	0.8509	0.1027	0.6491	1.0000	0.5086	0.3161	0.3226	0.3185	0.9972
Atop Ecz	Act Ker	0.2501	0.1915	0.1763	1.0000	0.3504	1.0000	0.5375	0.3545	0.4749
Vitiligo	Alop Are	0.4762	0.1567	0.9926	0.3161	0.6523	1.0000	0.8443	1.0000	0.3185
Vitiligo	BCC	0.9046	0.4477	0.2093	0.3209	0.4998	0.3137	0.4280	1.0000	0.3137
Vitiligo	Act Ker	0.1502	0.6397	0.7646	0.3569	0.3434	1.0000	0.6698	1.0000	0.1243
Alop Are	BCC	0.5550	0.5023	0.2121	1.0000	0.2610	0.3126	0.5474	1.0000	0.4668
Alop Are	Act Ker	0.4377	0.3613	0.7711	1.0000	0.1679	1.0000	0.8101	1.0000	0.7124
BCC	Act Ker	0.1854	0.7929	0.3529	1.0000	0.7654	0.3534	0.7363	1.0000	0.7094

Table Mann-Whitney U Test Results
7.4(a) continued
Palmar Patterns

Left Hand : Females

		Probability (* = significant, ** = highly significant)					
Group 1	Group 2	PHL	CHL	RHL	UHTL	HARL	PARL
Control	Psoriasis	0.2575	0.4597	0.2588	0.3197	0.3185	1.0000
Control	Atop Ecz	0.4281	0.6454	1.0000	1.0000	1.0000	1.0000
Control	Vitiligo	0.4291	0.6866	0.2588	1.0000	1.0000	1.0000
Control	Alop Are	0.6413	0.0161*	0.4217	1.0000	0.3209	1.0000
Control	BCC	0.7805	0.0892	0.2506	1.0000	0.1558	1.0000
Control	Act Ker	0.9975	0.0372*	0.6551	1.0000	1.0000	1.0000
Psoriasis	Atop Ecz	0.7332	0.7808	0.2588	0.3197	0.3185	1.0000
Psoriasis	Vi tiligo	0.0539	0.7362	1.0000	0.3173	0.3161	1.0000
Psoriasis	Alop Are	0.5002	0.0936	0.7308	0.3161	0.9948	1.0000
Psoriasis	BCC	0.3917	0.3331	0.9812	0.3209	0.5570	1.0000
Psoriasis	Act Ker	0.2780	0.1683	0.1479	0.3569	0.3571	1.0000
Atop Ecz	Vitiligo	0.1125	0.9539	0.2588	1.0000	1.0000	1.0000
Atop Ecz	Alop Are	0.7403	0.0513	0.4217	1.0000	0.3209	1.0000
Atop Ecz	BCC	0.6061	0.2143	0.2506	1.0000	0.1558	1.0000
Atop Ecz	Act Ker	0.4477	0.1008	0.6551	1.0000	1.0000	1.0000
Vitiligo	Alop Are	0.2065	0.0442*	0.7308	1.0000	0.3185	1.0000
Vitiligo	BCC	0.2835	0.1927	0.9812	1.0000	0.1537	1.0000
Vitiligo	Act Ker	0.4423	0.0890	0.1479	1.0000	1.0000	1.0000
Alop Are	BCC	0.8520	0.4814	0.7141	1.0000	0.5513	1.0000
Alop Are	Act Ker	0.6560	0.8165	0.2446	1.0000	0.3595	1.0000
BCC	Act Ker	0.7907	0.6575	0.1431	1.0000	0.1900	1.0000

Table Mann-Whitney U Test Results

7.4(b)
Palmar Patterns

Right Hand - Females

		Probability for Variables (* = Significant, ** = Highly Significant)								
Group 1	Group 2	PTR	RTR	P2R	C2R	P3R	C3R	P4R	C4R	U4R
Control	Psoriasis	0.6445	0.8564	0.9888	1.0000	0.9373	1.0000	0.5504	0.9945	0.3149
Control	Atop Ecz	0.8366	0.5019	0.7034	1.0000	0.4728	1.0000	0.1127	0.3173	0.3173
Control	Vitiligo	0.8564	0.8114	0.3684	0.3197	0.2229	1.0000	0.5896	0.3149	0.5685
Control	Alop Are	0.3570	0.0779	0.3728	1.0000	0.9333	1.0000	0.3747	0.3138	0.5714
Control	BCC	0.5418	0.0425*	0.7307	0.3161	0.9683	1.0000	0.3993	0.3185	0.3185
Control	Act Ker	0.9570	0.4041	0.8257	1.0000	0.3149	1.0000	0.1625	0.3545	0.3545
Psoriasis	Atop Ecz	0.5046	0.3942	0.7131	1.0000	0.5215	1.0000	0.3201	0.3197	1.0000
Psoriasis	Vitiligo	0.5202	0.6743	0.3598	0.3173	0.1934	1.0000	0.2563	0.3173	0.1568
Psoriasis	Alop Are	0.1679	0.0528	0.3641	1.0000	0.8707	1.0000	0.7683	0.3161	0.1578
Psoriasis	BCC	0.2851	0.0281*	0.7196	0.3137	0.9058	1.0000	0.8036	0.3209	1.0000
Psoriasis	Act Ker	0.6966	0.3150	0.8147	1.0000	0.3514	1.0000	0.4081	0.3569	1.0000
Atop Ecz	Vitiligo	0.9794	0.6631	0.2064	0.3197	0.0529	1.0000	0.0342*	1.0000	0.1588
Atop Ecz	Alop Are	0.4740	0.2651	0.2093	1.0000	0.4214	1.0000	0.4864	1.0000	0.1598
Atop Ecz	BCC	0.6856	0.1619	0.4713	0.3161	0.4492	1.0000	0.4576	1.0000	1.0000
Atop Ecz	Act Ker	0.8017	0.8439	0.5566	1.0000	0.7515	1.0000	0.8986	1.0000	1.0000
Vitiligo	Alop Are	0.4570	0.1240	0.9926	0.3161	0.2544	1.0000	0.1552	1.0000	0.9961
Vitiligo	BCC	0.6660	0.0702	0.5758	0.9917	0.2390	1.0000	0.1683	1.0000	0.1599
Vitiligo	Act Ker	0.8204	0.5407	0.5196	0.3569	0.0299*	1.0000	0.0564	1.0000	0.1920
Alop Are	BCC	0.7564	0.7589	0.5817	0.3126	0.9652	1.0000	0.9633	1.0000	0.1609
Alop Are	Act Ker	0.3520	0.3761	0.5248	1.0000	0.2765	1.0000	0.5883	1.0000	0.1931
BCC	Act Ker	0.5248	0.2418	0.9113	0.3534	0.2975	1.0000	0.5576	1.0000	1.0000

Table . Mann-Whitney U Test Results

7.4(b) continued
Palmar Patterns

Right Hand - Females

		Probabilities (* = Significant, ** = Highly Significant)					
Group 1	Group 2	PHR	CHR	RHR	UHTR	HRAR	PARR
Control	Psoriasis	0.0014**	0.6688	0.0821	0.5570	0.9921	1.0000
Control	Atop Ecz	0.0018**	0.3380	0.0791	0.5627	0.1568	1.0000
Control	Vitiligo	0.0209*	0.6688	0.4844	0.1548	0.1548	1.0000
Control	Alop Are	0.0071**	0.1965	0.7179	0.1538	0.5542	1.0000
Control	BCC	0.0126*	0.3612	0.1248	0.1578	0.6491	1.0000
Control	Act Ker	0.0056**	0.0076**	0.3492	0.1898	0.1898	1.0000
Psoriasis	Atop Ecz	0.9340	0.5922	0.9830	0.9945	0.1588	1.0000
Psoriasis	Vi tiligo	0.3504	1.0000	0.2773	0.3173	0.1568	1.0000
Psoriasis	Alop Are	0.6011	0.0836	0.1567	0.3161	0.5599	1.0000
Psoriasis	BCC	0.4655	0.1783	0.8286	0.3209	0.6412	1.0000
Psoriasis	Act Ker	0.7240	0.0020**	0.4359	0.3569	0.1920	1.0000
Atop Ecz	Vitiligo	0.3958	0.5922	0.2691	0.3149	1.0000	1.0000
Atop Ecz	Alop Are	0.6606	0.0240*	0.1514	0.3138	0.3209	1.0000
Atop Ecz	BCC	0.5185	0.0614	0.8126	0.3185	0.0817	1.0000
Atop Ecz	Act Ker	0.7847	0.0063**	0.4252	0.3545	1.0000	1.0000
Vitiligo	Alop Are	0.6824	0.0836	0.7308	1.0000	0.3185	1.0000
Vitiligo	BCC	0.8407	0.1783	0.3834	1.0000	0.0803	1.0000
Vitiligo	Act Ker	0.5870	0.0020**	0.7928	1.0000	1.0000	1.0000
Alop Are	BCC	0.8358	0.7110	0.2282	1.0000	0.3061	1.0000
Alop Are	Act Ker	0.8819	0.1464	0.5523	1.0000	0.3581	1.0000
BCC	Act Ker	0.7278	0.0733	0.5657	1.0000	0.1070	1.0000

Table 7.5 - Canonical Discriminant Functions - Variables: PTL to HRAR - Males

FUNCTION	EIGENVALUE	PERCENT OF VARIANCE	CUMULATIVE PERCENT	CANONICAL CORRELATION
1*	0.06402	41.90	41.90	0.2452999
2*	0.03694	24.17	66.08	0.1887382
3*	0.01962	12.84	78.91	0.1387066
4*	0.01361	8.90	87.82	0.1158566
5*	0.01142	7.48	95.29	0.1062716
6*	0.00719	4.71	100.00	0.0844897

* MARKS THE 6 CANONICAL DISCRIMINANT FUNCTIONS

Table 7.6 - Males - Variables: PTL to HRAR

STANDARDIZED CANONICAL DISCRIMINANT FUNCTION COEFFICIENTS

	FUNC 1	FUNC 2	FUNC 3	FUNC 4	FUNC 5	FUNC 6
PTL	-0.22054	-0.37060	-0.13387	-0.29332	0.36338	0.12637
P3L	1.06241	0.02553	0.16755	0.41403	0.48198	0.18455
P4L	0.30854	0.23205	0.46650	0.71866	0.55635	-0.18073
PHL	0.19121	0.12048	-0.34821	0.34366	0.21978	0.29518
CHL	-0.33060	-0.09618	0.18038	0.32635	0.14674	0.26604
RHL	0.11679	0.33039	-0.53945	0.12404	-0.28906	-0.40578
PTR	0.05070	0.66612	0.25741	-0.02376	0.18143	0.14691
RTR	-0.16460	-0.16231	-0.45190	0.08020	0.49169	-0.18070
C3R	0.31663	0.07527	0.46026	-0.18050	0.13667	-0.21954
C4R	0.13151	-0.01385	0.07905	0.42095	0.04490	-0.57798
CHR	0.06824	0.74679	-0.14012	-0.08690	-0.19259	0.04197
RHR	-0.15749	-0.27538	0.18122	0.32462	-0.19668	0.71055

Table 7.7 - Structure Matrix - Males - Variables: PTL to HRAR

POOLED WITHIN-GROUPS CORRELATIONS BETWEEN DISCRIMINATING VARIABLES
AND CANONICAL DISCRIMINANT FUNCTIONS
(VARIABLES ORDERED BY SIZE OF CORRELATION WITHIN FUNCTION)

	FUNC 1	FUNC 2	FUNC 3	FUNC 4	FUNC 5	FUNC 6
P3L	0.79356*	-0.08147	-0.12005	-0.12241	0.04226	0.34009
P3R	0.41015*	-0.08539	-0.13837	-0.05337	0.03377	0.22368
P4R	-0.21003*	0.06740	0.15210	0.20254	0.12979	-0.20147
P2R	0.11691*	-0.05506	0.01029	0.07831	-0.00026	-0.00295
U4R	-0.02598*	-0.00980	-0.02031	0.01054	0.01101	-0.01960
CHR	-0.09543	0.72398*	-0.00498	-0.02493	-0.07645	0.16591
CHL	-0.25262	0.34589*	0.23413	0.17560	-0.00843	0.34570
P2L	0.07541	-0.07678*	-0.03611	-0.00676	-0.00926	0.00251
HARL	0.01362	-0.04039*	0.03055	0.00963	-0.01599	0.00888
RHL	0.09844	0.22546	-0.48799*	0.24063	-0.34265	-0.14334
C3R	0.27436	0.06430	0.44043*	-0.22609	0.11593	-0.19901
PHL	0.13769	0.07966	-0.36834*	0.32416	0.26756	0.22241
C3L	0.14828	0.03256	0.23965*	-0.14673	0.00901	-0.12325
RHR	-0.07510	-0.22263	0.02516	0.53772*	-0.26532	0.41904
C4R	0.05949	-0.10511	0.16346	0.53333*	0.00182	-0.40069
P4L	-0.43193	0.12837	0.25833	0.45259*	0.24685	-0.32622
PHR	0.11303	0.06846	-0.23577	0.25926*	0.18192	0.10719
U4L	-0.05473	-0.04950	0.00127	-0.14688*	-0.01517	-0.08368
C4L	0.09680	-0.06593	0.10356	-0.11900*	0.09974	-0.07237
PTL	-0.19703	0.05528	-0.05876	-0.26823	0.60879*	0.16917
RTR	-0.18457	-0.10197	-0.48092	0.02911	0.59893*	-0.14110
PTR	-0.09856	0.47611	0.07682	-0.16086	0.48033*	0.24251
RTL	-0.12817	-0.08630	-0.31552	0.02789	0.43250*	-0.08253
HRAR	-0.00288	-0.03028	-0.02758	-0.03231	-0.03210	-0.04360*
PARL	-0.02330	-0.01307	0.01852	-0.00221	-0.01224	-0.02648*

Table 7.8 - F Statistics and significances between pairs of groups: Males - Variables PTL to HRAR

GROUP	0	1	2	3	5	6
1	2.7415 0.0011					
2	2.6069 0.0019	3.5478 0.0000				
3	1.4928 0.1200	2.3988 0.0045	3.8428 0.0000			
5	2.1924 0.0102	2.6501 0.0016	1.3821 0.1675	2.5346 0.0026		
6	3.5277 0.0000	2.3089 0.0065	4.8259 0.0000	3.7105 0.0000	4.0380 0.0000	
7	2.1230 0.0133	3.6065 0.0000	2.0724 0.0161	1.9178 0.0286	1.8026 0.0430	5.4114 0.0000

Code Group
 0 - Controls
 1 - Psoriasis
 2 - Alopecia Areata
 3 - ITC
 5 - Alopecia areata
 6 - Actinic Keratosis
 7 - Vitiligo

Figure 7.1 - Territorial Map - Males - Variables PTL to HRAR

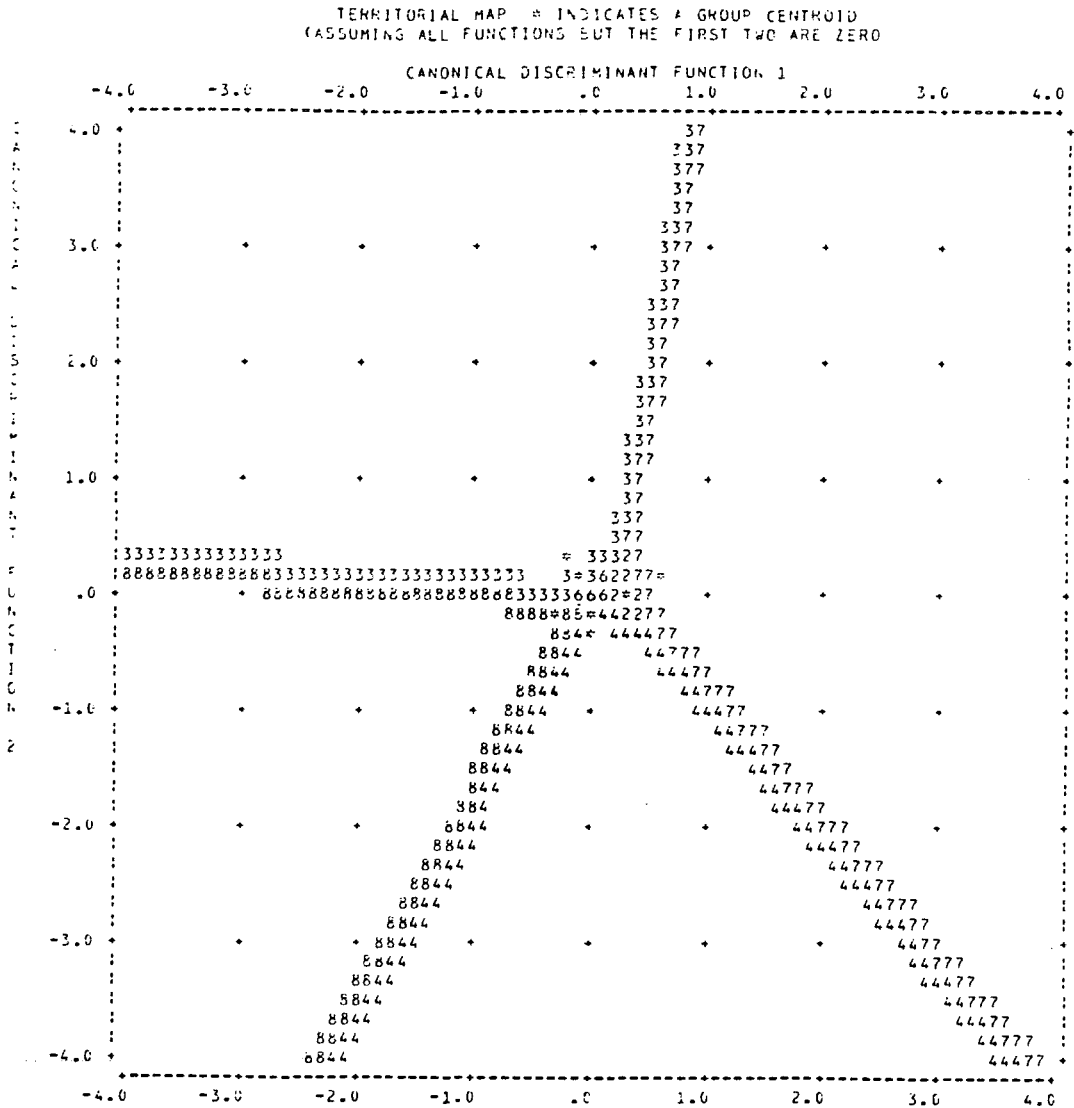

Code Group

- 1 - Controls
- 2 - Psoriasis
- 3 - Atopic Eczema
- 4 - BCI
- 6 - Alopecia areata
- 7 - Actinic Keratosis
- 8 - Vitiligo

Figure 7.2 - Scatterplot - Males - Variables: PTL to HRAR

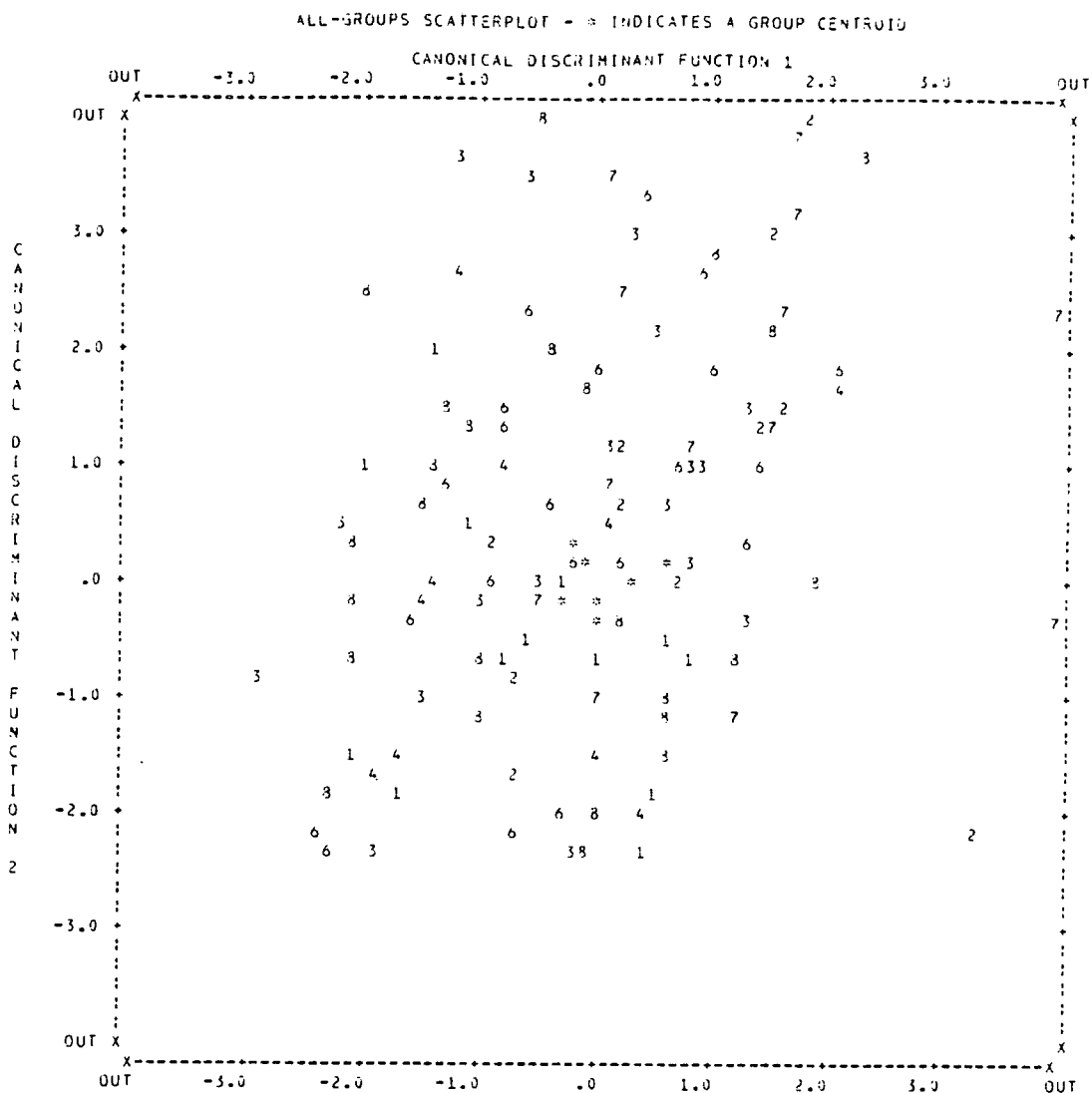

- Code Group
- 1 - Controls
 - 2 - Psoriasis
 - 3 - Atopic Eczema
 - 4 - UIC
 - 6 - Alopecia areata
 - 7 - Actinic Keratosis
 - 8 - Vitiligo

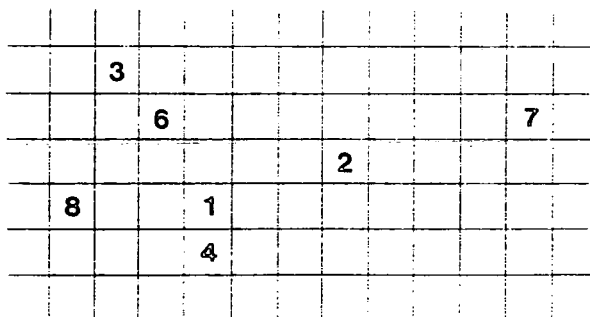

Figure 7.3 - Group Centroids

Table 7.9 - Classification Results - Males - Variables: PTL to HRAR

ACTUAL GROUP	NO. OF CASES	PREDICTED GROUP MEMBERSHIP							
		0	1	2	3	5	6	7	
GROUP 0	200	12 6.0%	20 10.0%	19 9.5%	50 25.0%	17 8.5%	27 13.5%	55 27.5%	
GROUP 1	202	3 1.5%	41 20.3%	15 7.4%	55 27.2%	29 14.4%	30 14.9%	29 14.4%	
GROUP 2	202	8 4.0%	23 11.4%	37 18.3%	29 14.4%	33 16.3%	25 12.4%	47 23.3%	
GROUP 3	211	8 3.8%	27 12.8%	17 8.1%	77 36.5%	15 7.1%	23 10.9%	44 20.9%	
GROUP 5	209	8 3.8%	23 11.0%	24 11.5%	39 18.7%	36 17.2%	20 9.6%	59 28.2%	
GROUP 6	129	1 0.8%	15 11.6%	7 5.4%	32 24.8%	22 17.1%	34 26.4%	18 14.0%	
GROUP 7	201	6 3.0%	21 10.4%	27 13.4%	46 22.9%	19 9.5%	13 6.5%	69 34.3%	

Code Group
 0 - Controls
 1 - Psoriasis
 2 - Atopic Dermatitis
 3 - BCC
 4 - Alopecia areata
 5 - Alopecia areata
 6 - Actinic Keratosis
 7 - Vitiligo

PERCENT OF "GROUPED" CASES CORRECTLY CLASSIFIED: 22.60%

Table 7.10 - Canonical Discriminant Functions - Females - Variables: PTL to HRAR

FUNCTION	EIGENVALUE	PERCENT OF VARIANCE	CUMULATIVE PERCENT	CANONICAL CORRELATION
1*	0.04832	49.32	49.32	0.2146962
2*	0.01673	17.07	66.40	0.1282585
3*	0.01475	15.05	81.45	0.1205522
4*	0.00843	8.60	90.05	0.0914134
5*	0.00554	5.65	95.70	0.0742191
6*	0.00421	4.30	100.00	0.0647459

Table 7.11 - Females - Variables: PTL to HRAR

STANDARDIZED CANONICAL DISCRIMINANT FUNCTION COEFFICIENTS

	FUNC 1	FUNC 2	FUNC 3	FUNC 4	FUNC 5	FUNC 6
RTL	0.21761	-0.52182	0.39237	0.01029	-0.59897	-0.09831
P3L	0.37907	0.19925	0.16029	0.29961	-0.60550	0.75463
C3L	0.20368	0.19942	0.04822	-0.33213	-0.40495	0.12429
P4L	0.91919	0.41335	0.25828	0.72849	-0.58911	0.16481
C4L	0.29318	-0.14834	0.05240	-0.00359	0.30737	0.08325
U4L	0.45914	0.09597	0.10559	-0.09585	0.25837	0.00609
PHL	0.40835	0.09595	0.22307	-0.21183	0.33068	-0.31444
RTR	0.06019	0.15060	-0.49665	0.19192	0.80168	0.57312
P4R	-0.28441	0.05861	-0.63234	-0.43230	0.00069	0.43347
U4R	-0.12532	0.23375	-0.57544	0.06090	0.06564	-0.39149
PHR	-0.59485	-0.33567	0.20536	0.17583	0.09451	0.11760
CHR	-0.19674	0.71874	0.36006	0.23302	0.29715	0.15233
UHTR	0.31100	-0.11080	0.01295	0.06023	0.06075	-0.02911
HRAR	0.04185	0.14581	0.17373	-0.65755	0.06487	0.06864

Table 7.12 - Structure Matrix - Females - Variables: PTL to HRAR

POOLED WITHIN-GROUPS CORRELATIONS BETWEEN DISCRIMINATING VARIABLES AND CANONICAL DISCRIMINANT FUNCTIONS (VARIABLES ORDERED BY SIZE OF CORRELATION WITHIN FUNCTION)						
	FUNC 1	FUNC 2	FUNC 3	FUNC 4	FUNC 5	FUNC 6
P4L	0.44555*	0.19670	-0.24610	0.26757	-0.13908	-0.18675
U4L	0.39802*	0.07633	-0.00010	-0.22823	0.33997	-0.05756
UHTR	0.30133*	-0.08107	0.02095	0.05755	0.07164	-0.04209
CHR	-0.22076	0.70043*	0.37425	0.22920	0.19864	0.19604
CHL	-0.18813	0.44387*	0.22036	0.14468	0.11518	0.18161
RTL	0.21656	-0.40551*	0.00652	0.17010	-0.03160	0.29743
PHR	-0.29619	-0.35373*	0.26190	0.05550	0.27641	-0.06272
RHR	0.01149	-0.06864*	-0.04804	-0.00864	-0.02998	-0.04420
P4R	0.07665	0.09575	-0.52579*	-0.18930	-0.01986	0.24512
U4R	-0.05179	0.17542	-0.49972*	0.07416	0.06178	-0.44553
P3R	0.05227	-0.04680	0.44407*	0.20633	-0.05744	0.04010
P2L	0.03257	0.05996	-0.12860*	0.00857	-0.00653	-0.07227
P2R	0.03534	0.08220	-0.12320*	0.02168	0.00837	-0.04332
C2R	-0.01305	0.00755	0.02312*	0.00676	0.00055	0.00404
HRAR	0.11345	0.14558	0.14676	-0.69568*	0.07206	0.05810
HARL	0.01955	0.05220	0.08310	-0.35509*	0.01444	0.03118
C4R	0.15204	0.05121	0.05763	-0.17653*	-0.06344	0.04807
C2L	-0.03843	-0.02242	-0.03228	-0.04407*	0.02368	-0.01966
PHL	0.05618	-0.19050	0.29902	-0.11954	0.36257*	-0.23562
C4L	0.28802	-0.17936	0.03865	-0.05363	0.35298*	0.09681
C3L	0.14223	0.21994	0.07077	-0.33991	-0.34807*	0.07863
RTR	0.20679	-0.22756	-0.22989	0.22386	0.34423	0.52966*
P3L	-0.24002	-0.08603	0.25175	-0.03456	-0.11196	0.47245*
PTR	0.01422	-0.03517	0.00093	0.09982	0.08809	0.13455*
UHTL	0.01236	-0.05771	-0.04471	0.00130	0.01286	0.08364*
PTL	0.03320	-0.03720	0.01949	0.07315	0.04960	0.08237*
RHL	0.02717	-0.00408	0.04142	0.00429	0.03239	0.04796*

Table 7.13 - F Statistics and significances between pairs of groups - Females - Variables: PTL to HRAR

GROUP	GROUP	0	1	2	3	5	6
1		1.9696 0.0170					
2		2.2867 0.0043	0.61988 0.8505				
3		2.9205 0.0002	1.0247 0.4252	1.2284 0.2475			
5		3.2583 0.0000	1.2205 0.2533	1.4594 0.1189	0.67937 0.7964		
6		3.1358 0.0001	1.3989 0.1456	1.3497 0.1708	0.79732 0.6730	0.62745 0.8440	
7		3.4250 0.0000	1.3014 0.1987	1.4906 0.1068	1.2469 0.2344	0.79470 0.6758	1.3205 0.1873

Code Group

- 0 - Controls
- 1 - Psoriasis
- 2 - Alopecia areata
- 3 - BCC
- 5 - Alopecia areata
- 6 - Actinic Keratosis
- 7 - Vitiligo

Table 7.14 - Classification Results - Females - Variables: PTL to HRAR

ACTUAL GROUP		NO. OF CASES	PREDICTED GROUP MEMBERSHIP						
			0	1	2	3	5	6	7
GROUP	0	202	75 37.1%	7 3.5%	32 15.8%	2 1.0%	5 2.5%	35 17.3%	46 22.8%
GROUP	1	205	44 21.5%	17 8.3%	51 24.9%	2 1.0%	6 2.9%	42 20.5%	43 21.0%
GROUP	2	203	48 23.6%	11 5.4%	61 30.0%	0 0.0%	1 0.5%	39 19.2%	43 21.2%
GROUP	3	202	30 14.9%	11 5.4%	54 26.7%	6 3.0%	1 0.5%	49 24.3%	51 25.2%
GROUP	5	206	27 13.1%	15 7.3%	44 21.4%	1 0.5%	4 1.9%	60 29.1%	55 26.7%
GROUP	6	172	32 18.6%	13 7.6%	36 20.9%	0 0.0%	2 1.2%	56 32.6%	33 19.2%
GROUP	7	205	28 13.7%	10 4.9%	53 25.9%	0 0.0%	1 0.5%	42 20.5%	71 34.6%

Code Group
 0 - Controls
 1 - Psoriasis
 2 - Atopic Eczema
 3 - BTT
 5 - Alopecia areata
 6 - Actinic Keratosis
 7 - Vitiligo

PERCENT OF "GROUPED" CASES CORRECTLY CLASSIFIED: 20.79%

show that the groups furthest apart are vitiligo and controls ($F = 3.4250$) and alopecia areata and controls ($F = 3.2583$). The territorial map (Figure 7.4) shows controls to be furthest removed from alopecia areata and vitiligo, whilst actinic keratosis is removed in the opposite direction from atopic eczema.

The scatterplot and group centroids (Figures 7.5 and 7.6) show that controls are separated for the other groups. Psoriasis and atopic eczema occupy the same centroid and are removed from the other four groups.

Classification results show 20.79% correct grouping. The best classified groups were found to be controls (37.1%) and vitiligo (34.6% correct).

When the groups were regrouped according to aetiology of disorder significant differences were found for male controls compared to GD males for the frequency of occurrence of peripheral loops on I_2 of the right hand, central loops on I_3 of both hands, central loops on I_4 of the right hand, central hypothenar loops on the right hand and hypothenar radial arches on the right hand (see Table 7.15). No significant differences were found for control males compared to ND males for the right hand, but on the left hand highly significant statistical differences were found for peripheral loop occurrence of I_3 and I_4 . For GD males compared to ND males significant differences were found peripheral and central patterns on I_3 and peripheral patterns on I_4 of both hands. A highly significant difference for hypothenar central pattern occurrence was also found on the right hand.

For female controls compared to GD females, significant differences were found for frequency of occurrence of central pattern on I_3 and peripheral patterns and ulnar patterns on I_4 of the left hand. On the right hand a highly significant difference was found for peripheral hypothenar loop occurrence when control and GD females were compared. When female controls were compared to ND controls highly significant differences were found for peripheral patterns on I_3 and I_4 and significant differences for ulnar patterns on I_4 of the left hand. A highly significant difference was also found for peripheral hypothenar pattern occurrence on the right hand and central hypothenar loop occurrence (significant difference) on the left hand (see Table 7.15).

Figure 7.4 - Territorial Map - Females - Variables: PTL to HRAR

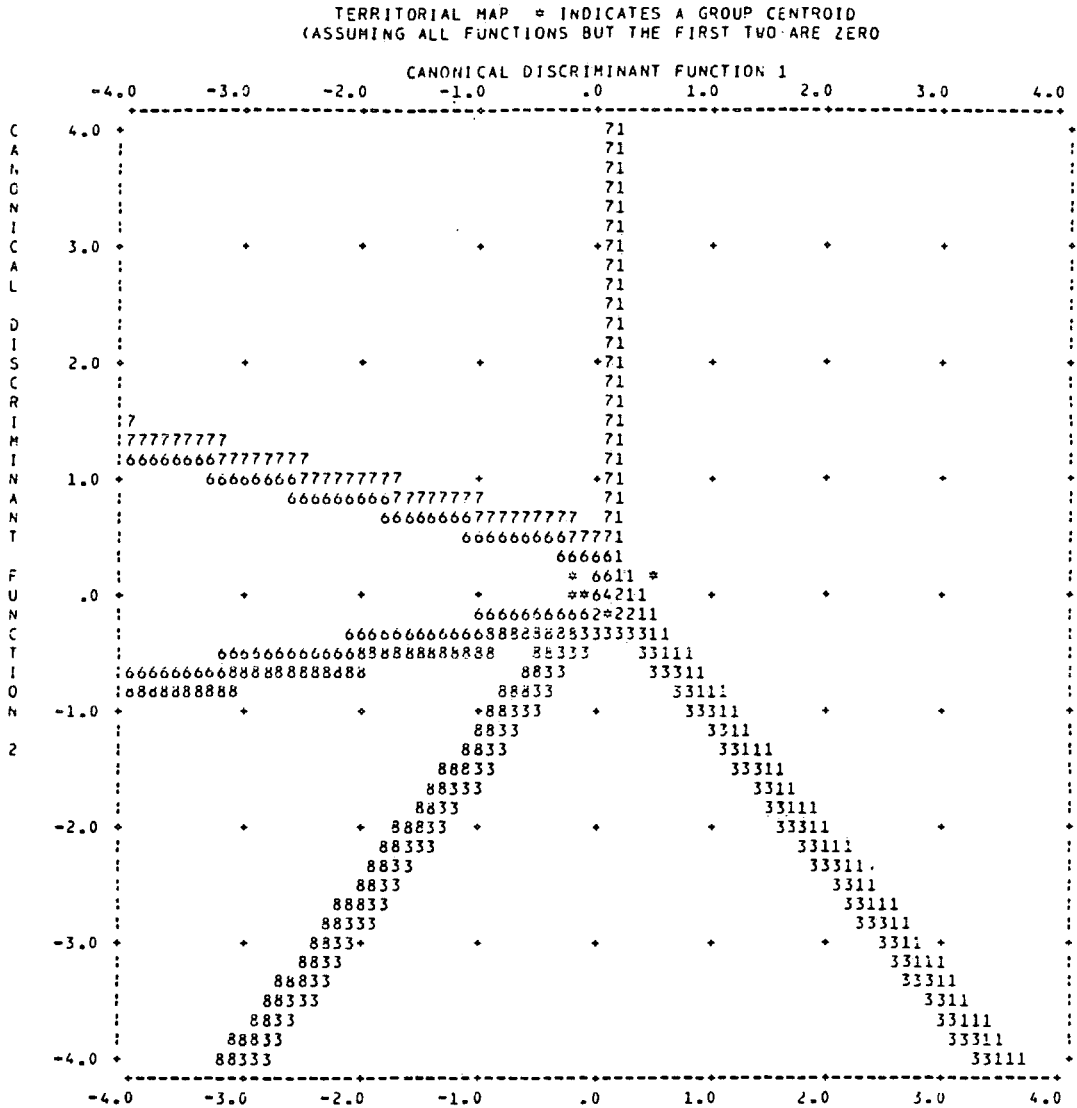

Code Group

- 1 - Controls *
- 2 - Psoriasis
- 3 - Atopic Eczema
- 4 - BCF
- 6 - Alopecia areata
- 7 - Actinic Keratosis
- 8 - Vitiligo

Figure 7.5 Scatterplot - Females - Variables: PTL to HRAR

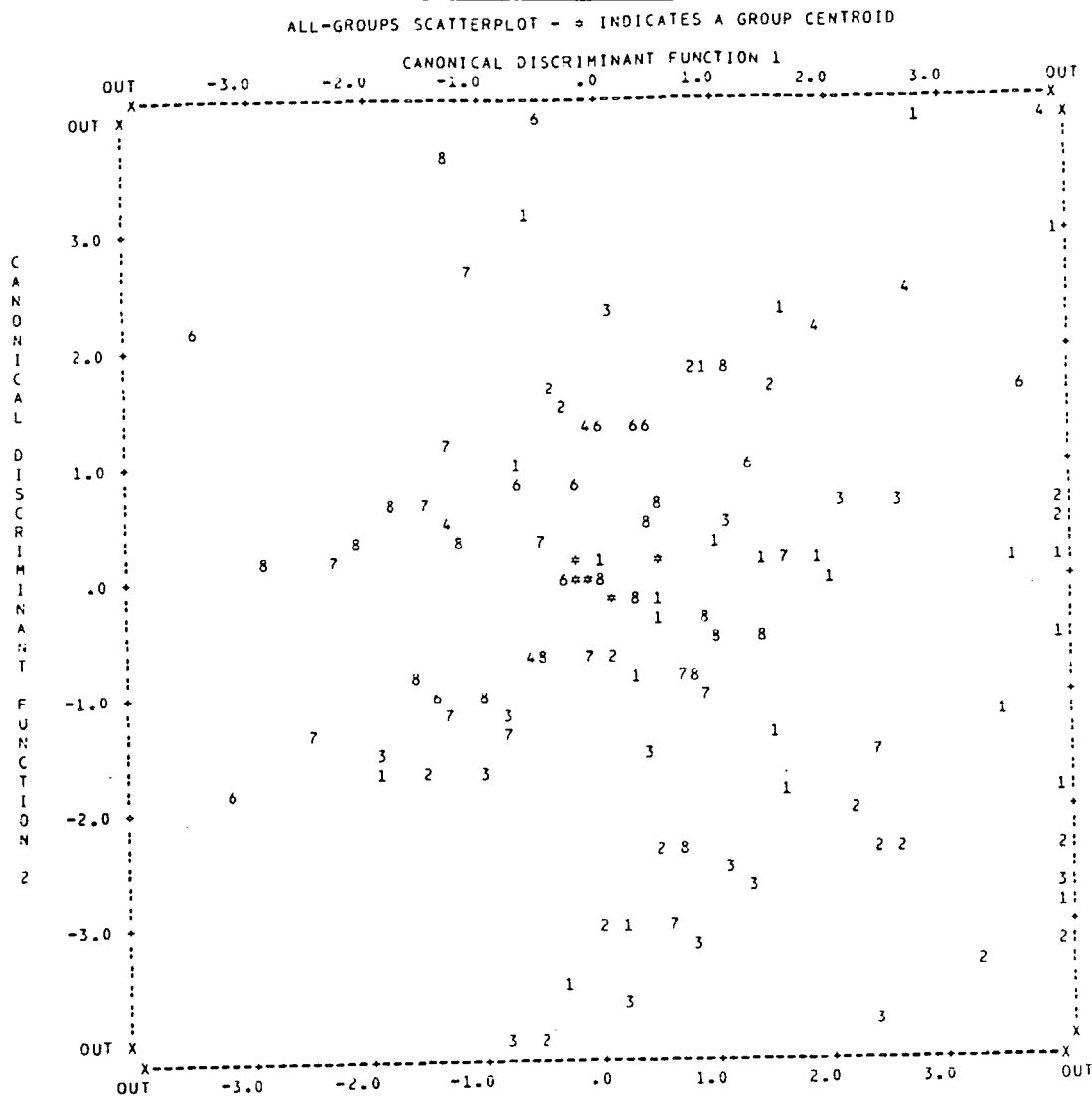

- | Code | Group |
|------|-------------------|
| 1 | Controls |
| 2 | Psoriasis |
| 3 | Atopic Eczema |
| 4 | BCC |
| 6 | Alopecia areata |
| 7 | Actinic Keratosis |
| 9 | Vitiligo |

6+7				1
8	4			
		2+3		

Figure 7.6 - Group Centroids

Table 7.15 - Mann-Whitney U Test Results: Palmar Pattern Frequencies - Subjects classified by disorder type

(a) Left hand

Variables and Probabilities

SEX	Gp1	Gp2	PTL	RTL	P2L	C2L	P3L	C3L	P4L	C4L	U4L	PHL	CHL	RHL
M	Cont	GD	0.1432	0.8831	0.8773	1.0000	0.8363	0.0434*	0.2756	0.4836	0.4099	0.2945	0.8181	0.1194
M	Cont	ND	0.4549	0.1570	0.4084	1.0000	0.0007**	0.8941	0.0006**	0.4431	0.2859	0.4955	0.2611	0.6409
M	GD	ND	0.4063	0.1004	0.3082	1.0000	0.0000**	0.0284*	0.0005**	0.8814	0.6348	0.7134	0.0719	0.1454
F	Cont	GD	0.8164	0.6315	0.4645	0.6194	0.0842	0.0441*	0.0005**	0.2556	0.0160*	0.6139	0.2168	0.3516
F	Cont	ND	0.9433	0.1911	0.5846	1.0000	0.0090**	0.6570	0.0002**	0.0541	0.0128*	0.8610	0.0309*	0.5482
F	GD	ND	0.6955	0.2525	0.8456	0.4992	0.1363	0.1389	0.3726	0.2414	0.4372	0.6912	0.1334	0.6775

SEX	Gp1	Gp2	UHTL	HARL	PARL
M	Cont	GD	1.0000	0.0231*	0.4836
M	Cont	GD	1.0000	0.2859	1.0000
M	GD	ND	1.0000	0.3655	0.3611
F	Cont	GD	0.6194	0.4820	1.0000
F	Cont	ND	1.0000	0.2976	1.0000
F	GD	ND	0.4992	0.4199	1.0000

Table 7.15 continued

(b) Right hand

Variables and Probabilities

SEX	Gp1	Gp2	PTR	RTR	P2R	C2R	P3R	C3R	P4R	C4R	U4R	PHR	CHR	RHR
M	Cont	GD	0.0598	0.1075	0.0247*	1.0000	0.4523	0.0434*	0.3898	0.0405*	0.3214	0.9614	0.0211*	0.1470
M	Cont	ND	0.4918	0.8477	0.0555	1.0000	0.2522	0.8941	0.3607	0.0649	1.0000	0.7871	0.8710	0.3061
M	GD	ND	0.1349	0.0746	0.9213	1.0000	0.0136*	0.0284*	0.0196*	0.5186	0.1961	0.7517	0.0086**	0.7904
F	Cont	GD	0.7821	0.4432	0.6307	0.6194	0.9064	1.0000	0.3880	0.2832	0.9903	0.0011**	0.8624	0.1723
F	Cont	ND	0.7225	0.0796	0.7426	0.4624	0.5581	1.0000	0.1790	0.1736	0.1736	0.0037**	0.0502	0.1657
F	GD	ND	0.8811	0.1704	0.8719	0.5695	0.3353	1.0000	0.4307	0.4992	0.1760	0.8012	0.0023**	0.8733

SEX	Gp1	Gp2	UHTR	HRAR	PARR
M	Cont	GD	1.0000	0.9858	1.0000
M	Cont	ND	1.0000	0.8941	1.0000
M	GD	ND	1.0000	0.8327	1.0000
F	Cont	GD	0.1287	0.2556	1.0000
F	Cont	ND	0.0541	0.8167	1.0000
F	GD	ND	0.3390	0.3237	1.0000

For female GD subjects compared to female ND subjects only one highly significant difference was found and that was for the frequency of occurrence of central hypothenar loops on the right hand.

(b) Interdigital Pattern Intensity Indices - Variables: INTOR, INTOL
and INTBT

For male subjects, it was found that psoriasitic males had highly significantly smaller occurrence of 0 and 1 loop and highly significantly greater occurrence of 2, 3 and 4 loops in comparison to alopecia areata males on both hands independently and for both hands combined (see Tables 7.16 and 7.17). Male psoriatics were also found to have the same significant differences when compared to controls and to vitiligo although for the right hand only. Atopic eczema were found to have highly significantly greater frequency of occurrence of 2 and 3 loops and smaller incidence of 1 loop in comparison to alopecia areata for both hands independently and combined. The same pattern of statistical differences were found when atopic eczema males were compared to BCC males for right hand. For INTOL and INTBT alopecia areata males were found to have significantly different frequencies in comparison to controls and to actinic keratosis (see Table 7.17). A highly significant difference was found for INTOL and a significant difference for INTBT was found when control females were compared to alopecia areata females (Tables 7.16 and 7.17).

When discriminant analysis was carried out for male subjects using variables INTOR, INTOL and INTBT two canonical discriminant functions were produced with Function 1 accounting for 71.86% of the variance (Table 7.18). Tables 7.19 and 7.20 show that the two variables INTOR and INTBT are most important in Function 1 with INTOR having the greatest correlation value. From the table of F Statistics (Table 7.21) it can be seen that the groups which are the furthest apart are psoriasis and alopecia areata ($F = 6.4483$) followed by psoriasis and BCC ($F = 4.9471$). The territorial map shows psoriasis, actinic keratosis, vitiligo and alopecia areata to be separated (Figure 7.7). The scatterplot shows that all of the group centroids are clustered together in the centre of the plot. Alopecia areata and actinic keratosis and BCC and psoriasis are the group centroids which are furthest separated (Figure 7.9). Classification Results (Table 7.22) show that the best classified group cases were for alopecia areata (73.2% correct) followed by psoriasis (30.7% correct).

When discriminant analysis was carried out for females only one canonical discriminant function was produced and that the most important variable was INTOL with a coefficient and correlation of 1.0000 (Tables 7.23 to 7.25). The table of F Statistics shows that controls and alopecia areata ($F = 7.9009$) and controls and BCC ($F = 4.3974$) are the most widely separated pairs of groups (Table 7.26). From Figure 7.10 controls and alopecia areata are the furthest separated groups with the centroids of the other groups tightly clustered in the centre of the histogram. Classification results show that best classified groups to be alopecia areata (84% correct) followed by controls (29.2% correct) but no other groups had any cases correctly classified (Table 7.27). Overall the percentage of correct classification was found to be only 16.63%.

Table Percentage Frequencies
7.16
Interdigital Pattern Intensity Indices

(a) Males

Group	Cases	Percentage Frequencies										
		INTOR					INTOL					
		0	1	2	3	4	0	1	2	3	4	5
Controls	206	0.5	76.1	19.0	4.4	0.0	0.0	70.6	25.0	3.9	0.5	0.0
Psoriasis	202	0.0	67.8	24.3	6.9	1.0	0.0	71.3	20.8	5.9	2.0	0.0
Atop Ecz	203	0.0	70.0	24.6	5.4	0.0	0.5	70.9	22.2	5.9	0.5	0.0
Vitiligo	201	0.5	78.1	15.4	6.0	0.0	0.5	73.6	19.4	6.0	0.5	0.0
Alop Are	210	0.5	80.0	16.7	2.9	0.0	1.0	80.4	14.8	3.8	0.0	0.0
BCC	211	0.5	77.7	19.0	2.8	0.0	0.0	74.9	21.3	2.4	1.4	0.0
Act Ker	129	0.0	73.6	24.0	2.3	0.0	0.0	68.2	24.9	2.3	0.8	0.8

Group	Cases	Percentage Frequencies										
		INTBT										
		0	1	2	3	4	5	6	7	8	9	
Controls	206	0.0	0.0	64.7	15.7	14.7	2.9	2.0	0.0	0.0	0.0	
Psoriasis	202	0.0	0.0	59.9	17.8	12.9	3.5	4.0	2.0	0.0	0.0	
Atop Ecz	203	0.0	0.5	64.5	10.3	16.7	4.4	3.4	0.0	0.0	0.0	
Vitiligo	201	0.5	0.0	69.2	11.4	11.4	4.0	3.5	0.0	0.0	0.0	
Alop Are	210	0.5	0.0	73.2	13.9	7.7	3.8	1.0	0.0	0.0	0.0	
BCC	211	0.0	0.5	68.7	12.3	14.7	1.9	1.9	0.0	0.0	0.0	
Act Ker	129	0.0	0.0	63.6	14.7	17.1	3.1	0.8	0.8	0.0	0.0	

(b) Females
7.16 continued

Group	Percentage Frequencies											
	Cases	INTOR					INTOL					
		0	1	2	3	4	0	1	2	3	4	5
Controls	203	2.5	71.9	20.7	3.9	1.0	3.0	68.0	24.1	4.4	0.0	0.5
Psoriasis	205	2.4	74.1	19.5	3.5	0.5	2.9	74.1	21.0	1.5	0.5	0.0
Atop Ecz	203	1.0	79.3	3.4	0.0	0.5	0.5	77.7	17.7	3.9	0.0	0.0
Vitiligo	205	1.0	76.1	17.1	5.9	0.0	1.5	78.5	14.1	5.4	0.5	0.0
Alop Are	206	1.0	77.0	18.0	2.4	1.0	2.4	81.6	13.1	2.4	0.5	0.0
BCC	202	0.5	79.0	17.3	2.0	0.5	0.5	80.2	17.3	2.0	0.0	0.0
Act Ker	174	0.6	76.3	22.0	1.2	0.0	1.1	78.2	17.8	2.9	0.0	0.0

Group	Percentage Frequencies											
	Cases	INTBT										
		0	1	2	3	4	5	6	7	8	9	
Controls	203	2.0	1.5	60.1	17.2	13.3	2.5	3.0	0.0	0.0	0.5	
Psoriasis	205	1.5	2.4	67.3	10.2	14.1	2.9	1.5	0.0	0.0	0.0	
Atop Ecz	203	0.0	1.5	73.4	7.4	13.8	2.0	2.0	0.0	0.0	0.0	
Vitiligo	205	0.5	1.5	69.3	13.2	8.3	4.4	2.4	0.5	0.0	0.0	
Alop Are	206	1.0	1.5	72.3	12.6	8.7	1.9	1.0	0.5	0.5	0.0	
BCC	202	0.0	1.0	73.8	10.9	11.9	1.0	1.0	0.5	0.0	0.0	
Act Ker	174	0.6	0.6	71.7	10.4	14.5	1.2	0.0	1.2	0.0	0.0	

Table Mann-Whitney U Test Results
7.17
Interdigital Pattern Intensity Indices

(a) Males

Group 1	Group 2	Probability		
		INTOR	INTOL	INTBT
Control	Psoriasis	0.0333*	0.9279	0.2513
Control	Atop Ecz	0.1182	0.8996	0.7505
Control	Vitiligo	0.7104	0.4854	0.4056
Control	Alop Are	0.3215	0.0089*	0.0353*
Control	BCC	0.6500	0.3355	0.3469
Control	Act Ker	0.5825	0.6787	0.7841
Psoriasis	Atop Ecz	0.5453	0.8256	0.4100
Psoriasis	Vi tiligo	0.0144*	0.4399	0.0522
Psoriasis	Alop Are	0.0018**	0.0086**	0.0014**
Psoriasis	BCC	0.0090**	0.3117	0.0391*
Psoriasis	Act Ker	0.1687	0.7409	0.4670
Atop Ecz	Vitiligo	0.0574	0.5789	0.2876
Atop Ecz	Alop Are	0.0099**	0.0155*	0.0225*
Atop Ecz	BCC	0.0406*	0.4223	0.2248
Atop Ecz	Act Ker	0.3890	0.6049	0.9770
Vitiligo	Alop Are	0.5528	0.0640	0.2429
Vitiligo	BCC	0.9479	0.8269	0.9326
Vitiligo	Act Ker	0.3783	0.3046	0.3235
Alop Are	BCC	0.5822	0.0883	0.2537
Alop Are	Act Ker	0.1421	0.0058*	0.0334*
BCC	Act Ker	0.3301	0.2006	0.2724

(b) Females

Group 1	Group 2	Probability		
		INTOR	INTOL	INTBT
Control	Psoriasis	0.6050	0.1532	0.1682
Control	Atop Ecz	0.2654	0.2286	0.0819
Control	Vitiligo	0.7838	0.1127	0.2281
Control	Alop Are	0.4587	0.0048**	0.0300*
Control	BCC	0.2890	0.0649	0.0544
Control	Act Ker	0.6806	0.1299	0.1557
Psoriasis	Atop Ecz	0.5557	0.7922	0.7715
Psoriasis	Vi tiligo	0.8000	0.8537	0.7893
Psoriasis	Alop Are	0.8328	0.1478	0.4900
Psoriasis	BCC	0.5974	0.7073	0.6657
Psoriasis	Act Ker	0.9111	0.8994	0.9833
Atop Ecz	Vitiligo	0.3911	0.6399	0.5505
Atop Ecz	Alop Are	0.6926	0.0750	0.7031
Atop Ecz	BCC	0.9383	0.5084	0.9122
Atop Ecz	Act Ker	0.4666	0.6952	0.7668
Vitiligo	Alop Are	0.6398	0.2047	0.3367
Vitiligo	BCC	0.4275	0.8717	0.4817
Vitiligo	Act Ker	0.8941	0.9477	0.7882
Alop Are	BCC	0.7463	0.2423	0.7736
Alop Are	Act Ker	0.7301	0.1864	0.4888
BCC	Act Ker	0.5020	0.8137	0.6678

Table 7.18 - Males - Variables: INTOR - INTBT

CANONICAL DISCRIMINANT FUNCTIONS

FUNCTION	EIGENVALUE	PERCENT OF VARIANCE	CUMULATIVE PERCENT	CANONICAL CORRELATION
1*	0.01290	71.86	71.86	0.1128540
2*	0.00505	28.14	100.00	0.0709029

* MARKS THE 2 CANONICAL DISCRIMINANT FUNCTIONS

Table 7.19 - Males - Variables: INTOR - INTBT

STANDARDIZED CANONICAL DISCRIMINANT FUNCTION COEFFICIENTS

	FUNC 1	FUNC 2
INTOR	0.99661	-1.91767
INTBT	0.00382	2.16117

Table 7.20 - Males - Variables: INTOR - INTBT

STRUCTURE MATRIX:

POOLED WITHIN-GROUPS CORRELATIONS BETWEEN DISCRIMINATING VARIABLES AND CANONICAL DISCRIMINANT FUNCTIONS (VARIABLES ORDERED BY SIZE OF CORRELATION WITHIN FUNCTION)

	FUNC 1	FUNC 2
INTOR	1.00000*	-0.00177
INTBT	0.88733*	0.46114
INTOL	0.60867	0.79342*

Table 7.21 - Males - Variables: INTOR - INTBT

Code Group
 0 - Controls
 1 - Psoriasis
 2 - Atopic Eczema
 3 - BCC
 4 - Alopecia areata
 5 - Actinic Keratosis
 6 - Vitiligo

F STATISTICS AND SIGNIFICANCES BETWEEN PAIRS OF GROUPS

GROUP	GROUP	0	1	2	3	4	5
1		3.1694 0.0423					
2		1.3150 0.2688	0.51523 0.5975				
3		0.32355 0.7236	4.9471 0.0072	2.3059 0.1001			
4		2.4084 0.0903	6.4483 0.0016	3.4504 0.0320	1.2953 0.2742		
5		0.14928 0.8613	2.9232 0.0541	1.5353 0.2158	0.63321 0.5310	3.0341 0.0484	
6		0.73491 0.9291	3.4969 0.0306	1.4068 0.2453	0.12141 0.8857	1.6472 0.1930	0.37251 0.6891

Figure 7.7 - Territorial Map - Males - Variables:INTOR - INTBT

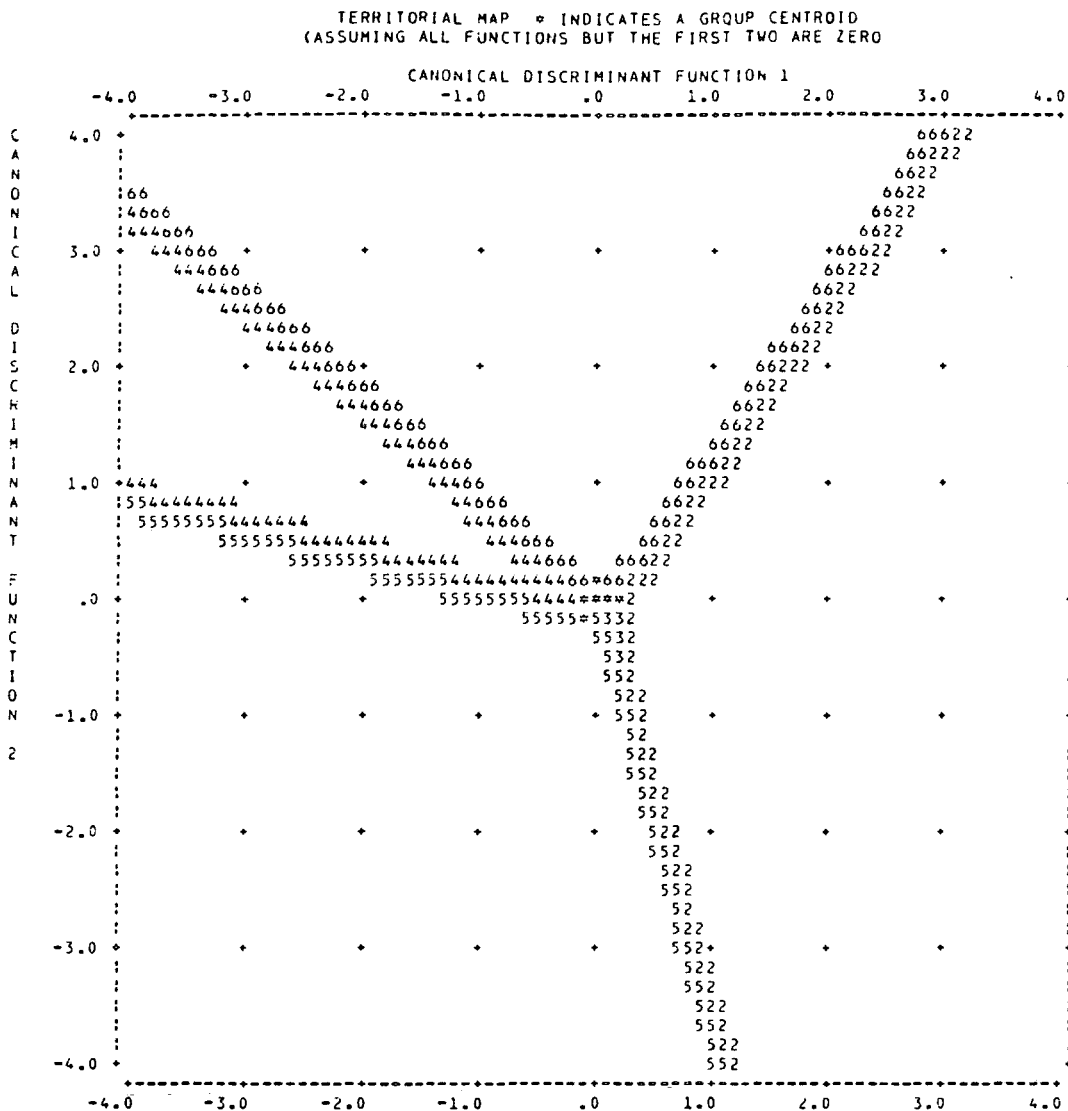

Code Group

- 1 - Controls
- 2 - Psoriasis
- 3 - Atopic Dermatitis
- 4 - BCT
- 5 - Alopecia areata
- 6 - Actinic Keratosis
- 7 - Vitiligo

Figure 7.8 - Scatterplot - Males - Variables: INTOR - INTBT

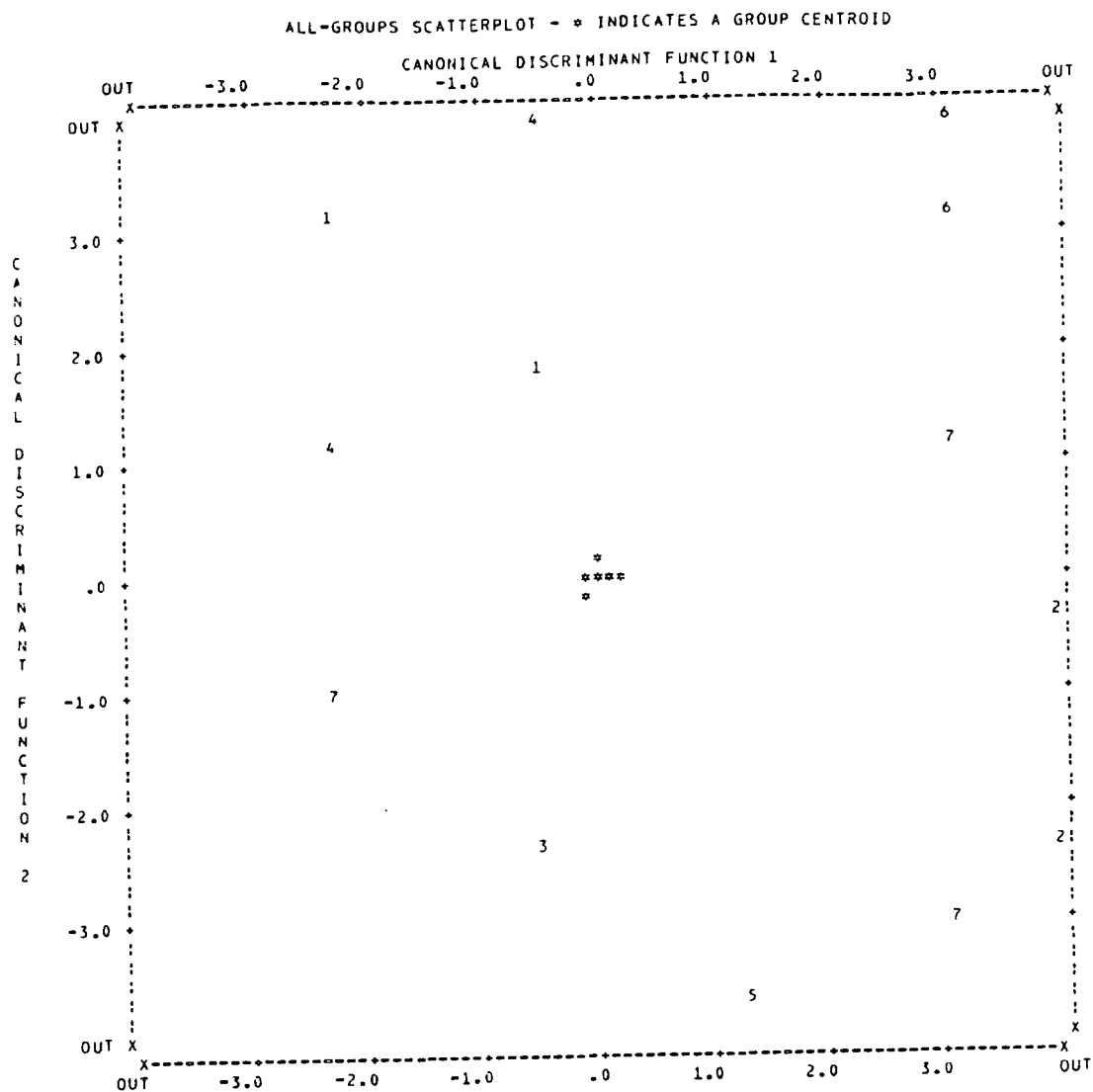

		6		
4	1+7	3	2	
5				

- | Code | Group |
|------|---------------------|
| 1 | - Controls |
| 2 | - Psoriasis |
| 3 | - Atopic Eczema |
| 4 | - BCI |
| 5 | - Alopecia areata |
| 6 | - Actinic Keratosis |
| 7 | - Vitiligo |

Figure 7.9 - Group Centroids

Table 7.22 - Classification Results - Males - Variables: INTOR to INTBT

ACTUAL GROUP	NO. OF CASES	PREDICTED GROUP MEMBERSHIP							
		0	1	2	3	4	5	6	
GROUP 0	199	0 0.0%	47 23.6%	0 0.0%	0 0.0%	127 63.8%	25 12.6%	0 0.0%	
GROUP 1	202	0 0.0%	62 30.7%	0 0.0%	0 0.0%	121 59.9%	19 9.4%	0 0.0%	
GROUP 2	203	0 0.0%	57 28.1%	0 0.0%	0 0.0%	132 65.0%	14 6.9%	0 0.0%	
GROUP 3	211	0 0.0%	44 20.9%	0 0.0%	1 0.5%	145 68.7%	21 10.0%	0 0.0%	
GROUP 4	209	0 0.0%	37 17.7%	0 0.0%	0 0.0%	153 73.2%	19 9.1%	0 0.0%	
GROUP 5	129	0 0.0%	30 23.3%	0 0.0%	0 0.0%	82 63.6%	17 13.2%	0 0.0%	
GROUP 6	201	0 0.0%	39 19.4%	0 0.0%	0 0.0%	140 69.7%	22 10.9%	0 0.0%	

PERCENT OF "GROUPED" CASES CORRECTLY CLASSIFIED: 17.21%

Table 7.23 - Females - Variables: INTOR - INTBT

CANONICAL DISCRIMINANT FUNCTIONS

FUNCTION	EIGENVALUE	PERCENT OF VARIANCE	CUMULATIVE PERCENT	CANONICAL CORRELATION
1*	0.00668	100.00	100.00	0.0814538

* MARKS THE 1 CANONICAL DISCRIMINANT FUNCTIONS REMAINING

Table 7.24 - Females - Variables: INTOR - INTBT

STANDARDIZED CANONICAL DISCRIMINANT FUNCTION COEFFICIENTS

	FUNC 1
INTOL	1.00000

Table 7.25 - Females - Variables: INTOR - INTBT

STRUCTURE MATRIX:

POOLED WITHIN-GROUPS CORRELATIONS BETWEEN DISCRIMINATING VARIABLES
AND CANONICAL DISCRIMINANT FUNCTIONS
(VARIABLES ORDERED BY SIZE OF CORRELATION WITHIN FUNCTION)

	FUNC 1
INTOL	1.00000
INTBT	0.91206
INTOR	0.66779

Table 7.26 - Females - Variables: INTOR - INTBT

Code Group
 0 - Controls
 1 - Psoriasis
 2 - Atopic Eczema
 3 - BCC
 4 - Alopecia areata
 5 - Actinic Keratosis
 6 - Vitiligo

F STATISTICS AND SIGNIFICANCES BETWEEN PAIRS OF GROUPS

GROUP	0	1	2	3	4	5
1	3.2410 0.0720					
2	1.6925 0.1935	0.24679 0.6194				
3	4.3974 0.0362	0.92681 0.7608	0.63783 0.4246			
4	7.9009 0.0050	1.0245 0.3116	2.2712 0.1320	0.49506 0.4818		
5	3.8495 0.0500	0.60181 0.8062	0.51647 0.4725	0.21113 0.9634	0.51784 0.4719	
6	1.8210 0.1774	0.20478 0.6510	0.20578 0.9638	0.57046 0.4502	2.1469 0.1431	0.45819 0.4986

Table 7.27 - Classification Results - Females - Variables: INTOR - INTBT

ACTUAL GROUP	NO. OF CASES	PREDICTED GROUP MEMBERSHIP						
		0	1	2	3	4	5	6
GROUP 0	202	59 29.2%	0 0.0%	0 0.0%	0 0.0%	143 70.8%	0 0.0%	0 0.0%
GROUP 1	205	47 22.9%	0 0.0%	0 0.0%	0 0.0%	158 77.1%	0 0.0%	0 0.0%
GROUP 2	203	44 21.7%	0 0.0%	0 0.0%	0 0.0%	159 78.3%	0 0.0%	0 0.0%
GROUP 3	202	39 19.3%	0 0.0%	0 0.0%	0 0.0%	163 80.7%	0 0.0%	0 0.0%
GROUP 4	206	33 16.0%	0 0.0%	0 0.0%	0 0.0%	173 84.0%	0 0.0%	0 0.0%
GROUP 5	172	35 20.3%	0 0.0%	0 0.0%	0 0.0%	137 79.7%	0 0.0%	0 0.0%
GROUP 6	205	41 20.0%	0 0.0%	0 0.0%	0 0.0%	164 80.0%	0 0.0%	0 0.0%

PERCENT OF "GROUPED" CASES CORRECTLY CLASSIFIED: 16.63%

(c) Hypothenar Pattern Intensity Indices - Variables: HYPOR, HYPOL and HYPBH

For male subjects, atopic eczema patients were found to have a statistically significantly higher occurrence of 1 and 2 pattern on the hypothenar area in comparison to vitiligo, actinic keratosis, controls and BCC (see Tables 7.28 and 7.29) for both hands separately and when combined. Vitiligo males had a significantly lower incidence in comparison to psoriasis and alopecia areata for the right hand only.

For females, actinic keratosis sufferers had a significantly higher occurrence of 1 loop scores in comparison to vitiligo, atopic eczema, psoriasis and controls for HYPOR and HYPBH. Alopecia areata patients were found to have significantly higher 1 and 2 loop scores in comparison to controls for both hands separately and combined (Tables 7.28 and 7.29).

When discriminant analysis was carried out for male subjects using variables HYPOR and HYPBH only one canonical discriminant function was produced which accounted for all of the variance (Table 7.30). The largest variable with the coefficient and correlation value of 1.0000 was HYPOR (Table 7.31 and 7.32). Figure 7.11 show that atopic eczema and vitiligo are the furthest separated groups with the others clustered in the centre. Table 7.33 shows vitiligo and atopic eczema ($F = 13.117$) to be the furthest separated groups followed by BCC and atopic eczema ($F = 8.8685$). Classification results (Table 7.34) show 17.27% correct classification. All groups except two have no cases correctly classified, however, vitiligo has 64.5% correct and atopic eczema has 51.7% correct classification.

Discriminant analysis for females shows that two canonical discriminant functions are produced. Function 1 accounts for 72.74% of the total variance (Table 7.35) and is composed of HYPOR and HYPBH (Table 7.37). The Table of F Statistics shows that the furthest separated groups are actinic keratosis and controls ($F = 7.4806$) followed by actinic keratosis and vitiligo ($F = 4.5608$) (see Table 7.38). The territorial map (Figure 7.12) shows that controls and actinic keratosis and also alopecia areata and vitiligo are the most separated groups. The centroids in Figures 7.13 and 7.14 show actinic keratosis and controls to be furthest apart.

Table Percentage Frequencies
7.28
Hypothenar Pattern Intensity Indices

(a) Sex = Males

Group	Cases	Percentage Frequencies													
		HYPOR				HYPOL				HYPBH					
		0	1	2	3	0	1	2	3	0	1	2	3	4	5
Controls	206	61.0	36.6	2.4	0.0	60.5	37.6	1.5	0.5	53.7	13.7	29.3	2.9	0.0	0.5
Psoriasis	202	54.0	42.6	3.5	0.0	53.0	45.5	1.5	0.0	45.5	15.3	34.7	4.5	0.0	0.0
Atop Ecz	203	48.3	46.8	4.9	0.0	48.0	49.5	2.5	0.0	40.1	15.8	38.1	4.5	1.5	0.0
Vitiligo	200	64.5	34.0	1.5	0.0	60.7	39.3	0.0	0.0	54.0	17.5	27.0	1.5	0.0	0.0
Alop Are	210	53.3	45.2	1.4	0.0	58.1	39.0	2.9	0.0	48.6	13.3	34.8	3.3	0.0	0.0
BCC	211	64.5	30.3	5.2	0.0	62.1	36.5	1.4	0.0	55.0	16.1	23.2	5.2	0.5	0.0
Act Ker	129	58.9	40.3	0.8	0.0	61.2	38.8	0.0	0.0	53.5	13.2	32.6	0.8	0.0	0.0

(b) Sex = Females

Group	Cases	Percentage Frequencies													
		HYPOR				HYPOL				HYPBH					
		0	1	2	3	0	1	2	3	0	1	2	3	4	
Controls	206	66.5	30.5	3.0	0.0	63.1	34.5	2.5	0.0	54.2	20.7	20.7	3.9	0.5	
Psoriasis	205	57.1	39.0	3.9	0.0	54.6	42.4	2.9	0.0	48.8	13.2	34.1	2.0	2.0	
Atop Ecz	203	58.6	38.4	3.0	0.0	58.1	39.9	2.0	0.0	48.8	18.7	29.1	2.5	1.0	
Vitiligo	205	63.9	31.2	4.9	0.0	62.0	36.6	1.5	0.0	57.1	11.7	26.3	3.4	1.5	
Alop Are	206	54.9	40.3	4.9	0.0	50.0	47.6	2.4	0.0	46.6	11.2	36.4	4.9	1.0	
BCC	202	55.9	39.1	4.5	0.5	55.4	40.1	4.5	0.0	49.5	9.9	35.6	2.5	2.5	
Act Ker	174	44.8	51.7	3.4	0.0	52.3	47.1	0.6	0.0	39.7	17.2	40.2	2.3	0.6	

Mann-Whitney U Test Results

7.29

Hypothesis Pattern Intensity Indices

(a) Males

Group 1	Group 2	Probability		
		HYPOR	HYPOL	HYPBH
Control	Psoriasis	0.1438	0.1468	0.1044
Control	Atop Ecz	0.0078**	0.0128*	0.0051**
Control	Vitiligo	0.4317	0.8413	0.6089
Control	Alop Are	0.1494	0.5805	0.2702
Control	BCC	0.6298	0.7108	0.7288
Control	Act Ker	0.8059	0.7844	0.9358
Psoriasis	Atop Ecz	0.2239	0.2879	0.2300
Psoriasis	Vitiligo	0.0251*	0.0935	0.0283*
Psoriasis	Alop Are	0.9467	0.3730	0.5956
Psoriasis	BCC	0.0573	0.0657	0.0480*
Psoriasis	Act Ker	0.2870	0.1155	0.1256
Atop Ecz	Vitiligo	0.0006**	0.0063**	0.0007**
Atop Ecz	Alop Are	0.1854	0.0531	0.0832
Atop Ecz	BCC	0.0021**	0.0039**	0.0016**
Atop Ecz	Act Ker	0.0318*	0.0124*	0.0099**
Vitiligo	Alop Are	0.0249*	0.4450	0.0960
Vitiligo	BCC	0.7751	0.8631	0.8944
Vitiligo	Act Ker	0.3404	0.9214	0.6952
Alop Are	BCC	0.0581	0.3520	0.1465
Alop Are	Act Ker	0.2992	0.4424	0.2844
BCC	Act Ker	0.5022	0.9570	0.8139

(b) Females

Group 1	Group 2	Probability		
		HYPOR	HYPOL	HYPBH
Control	Psoriasis	0.0516	0.0885	0.00750
Control	Atop Ecz	0.1147	0.3444	0.1900
Control	Vitiligo	0.5064	0.8836	0.9205
Control	Alop Are	0.0147*	0.0102*	0.0125*
Control	BCC	0.0257*	0.0988	0.0538
Control	Act Ker	0.0000**	0.0564	0.0012**
Psoriasis	Atop Ecz	0.7021	0.4406	0.5935
Psoriasis	Vitiligo	0.2095	0.1139	0.1206
Psoriasis	Alop Are	0.6098	0.3919	0.4473
Psoriasis	BCC	0.7552	0.9850	0.8258
Psoriasis	Act Ker	0.0272*	0.8171	0.1673
Atop Ecz	Vitiligo	0.3752	0.4173	0.2688
Atop Ecz	Alop Are	0.3718	0.1012	0.1941
Atop Ecz	BCC	0.4902	0.4615	0.4613
Atop Ecz	Act Ker	0.0095**	0.3209	0.0474*
Vitiligo	Alop Are	0.0806	0.0140*	0.0248*
Vitiligo	BCC	0.1223	0.1260	0.0879
Vitiligo	Act Ker	0.0007**	0.0733	0.0038**
Alop Are	BCC	0.8472	0.3918	0.6030
Alop Are	Act Ker	0.0900	0.5415	0.5638
BCC	Act Ker	0.0609	0.8065	0.2687

Table 7.30 - Males - Variables: HYPOR - HYPBH

CANONICAL DISCRIMINANT FUNCTIONS

FUNCTION	EIGENVALUE	PERCENT OF VARIANCE	CUMULATIVE PERCENT	CANONICAL CORRELATION
1*	0.01344	100.00	100.00	0.1151407

* MARKS THE 1 CANONICAL DISCRIMINANT FUNCTIONS REMAINING

Table 7.31 - Males - Variables: HYPOR to HYPBH

STANDARDIZED CANONICAL DISCRIMINANT FUNCTION COEFFICIENTS

	FUNC 1
HYPOR	1.00000

Table 7.32 - Males - Variables: HYPOR - HYPBH

STRUCTURE MATRIX:

POOLED WITHIN-GROUPS CORRELATIONS BETWEEN DISCRIMINATING VARIABLES
AND CANONICAL DISCRIMINANT FUNCTIONS
(VARIABLES ORDERED BY SIZE OF CORRELATION WITHIN FUNCTION)

	FUNC 1
HYPOR	1.00000
HYPBH	0.91586
HYPOL	0.66197

Table 7.33 - Males - Variables: HYPOR - HYPBH

Code Group
 0 Controls
 1 Psoriasis
 2 Atopic Eczema
 3 BCC
 5 Alopecia areata
 6 Actinic Keratosis
 7 Vitiligo

F STATISTICS AND SIGNIFICANCES BETWEEN PAIRS OF GROUPS

GROUP	GROUP	0	1	2	3	5	6
1		2.1159 0.1460					
2		7.8622 0.0051	1.8299 0.1764				
3		0.18559 0.8917	2.5941 0.1075	8.8685 0.0030			
5		1.4640 0.2265	0.67228 0.7955	2.6409 0.1044	1.8615 0.1727		
6		0.33479E+02 0.9539	1.5116 0.2191	5.8745 0.0155	0.31953 0.8582	1.0206 0.3126	
7		0.66534 0.4148	5.1634 0.0232	13.117 0.0003	0.47651 0.4901	4.1434 0.0420	0.60869 0.4354

Figure 7.11 - Males - Variables: HYPOR - HYPBH

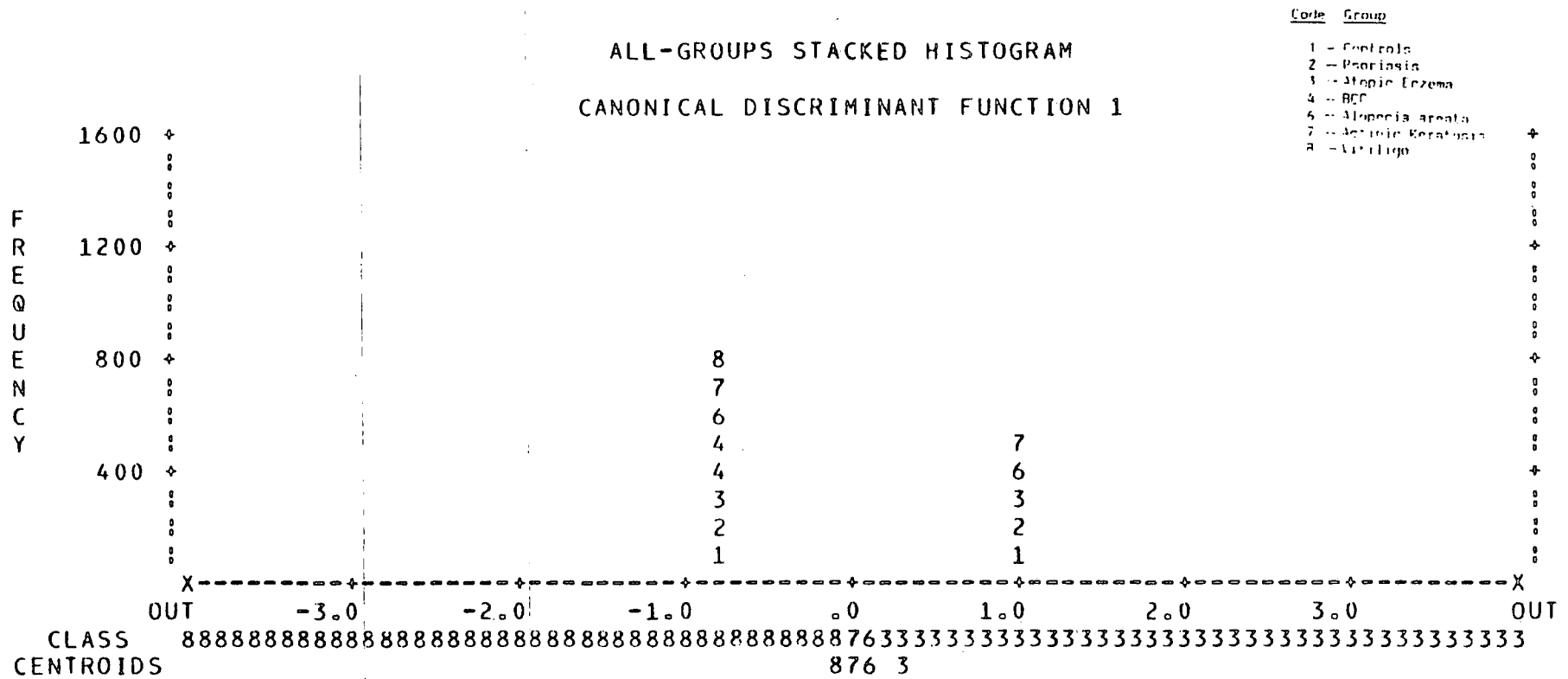

Table 7.34 - Males - Variables: HYPOR - HYPBH

CLASSIFICATION RESULTS -

ACTUAL GROUP	NO. OF CASES	PREDICTED GROUP MEMBERSHIP							
		0	1	2	3	5	6	7	
GROUP 0	200	0 0.0%	0 0.0%	78 39.0%	0 0.0%	0 0.0%	0 0.0%	0 0.0%	122 61.0%
GROUP 1	202	0 0.0%	0 0.0%	93 46.0%	0 0.0%	0 0.0%	0 0.0%	0 0.0%	109 54.0%
GROUP 2	203	0 0.0%	0 0.0%	105 51.7%	0 0.0%	0 0.0%	0 0.0%	0 0.0%	98 48.3%
GROUP 3	211	0 0.0%	0 0.0%	75 35.5%	0 0.0%	0 0.0%	0 0.0%	0 0.0%	136 64.5%
GROUP 5	210	0 0.0%	0 0.0%	98 46.7%	0 0.0%	0 0.0%	0 0.0%	0 0.0%	112 53.3%
GROUP 6	129	0 0.0%	0 0.0%	53 41.1%	0 0.0%	0 0.0%	0 0.0%	0 0.0%	76 58.9%
GROUP 7	200	0 0.0%	0 0.0%	71 35.5%	0 0.0%	0 0.0%	0 0.0%	0 0.0%	129 64.5%

PERCENT OF "GROUPED" CASES CORRECTLY CLASSIFIED: 17.27%

Table 7.35 - Canonical Discriminant Functions - Females - Variables: HYPOR - HYPBH

FUNCTION	EIGENVALUE	PERCENT OF VARIANCE	CUMULATIVE PERCENT	CANONICAL CORRELATION
1*	0.01251	72.74	72.74	0.1111356
2*	0.00469	27.26	100.00	0.0682964

* MARKS THE 2 CANONICAL DISCRIMINANT FUNCTIONS REMAINING

Table 7.36 - Females - Variables: HYPOR - HYPBH

STANDARDIZED CANONICAL DISCRIMINANT FUNCTION COEFFICIENTS

	FUNC 1	FUNC 2
HYPOL	-1.12896	2.08923
HYPBH	1.90375	-1.41957

Table 7.37 - Females - Variables: HYPOR - HYPBH

STRUCTURE MATRIX:

POOLED WITHIN-GROUPS CORRELATIONS BETWEEN DISCRIMINATING VARIABLES AND CANONICAL DISCRIMINANT FUNCTIONS (VARIABLES ORDERED BY SIZE OF CORRELATION WITHIN FUNCTION)

	FUNC 1	FUNC 2
HYPOR	0.99633*	0.08555
HYPBH	0.87977*	0.47540
HYPOL	0.59778	0.80166*

Table 7.38 - Females - Variables: HYPOR - HYPBH

Code Group
 0 - Controls
 1 - Psoriasis
 2 - Atopic Dermatitis
 3 - BCC
 5 - Alopecia areata
 6 - Actinic Keratosis
 7 - Vitiligo

F STATISTICS AND SIGNIFICANCES BETWEEN PAIRS OF GROUPS

GROUP	GROUP	0	1	2	3	5	6
1		1.7646 0.1716					
2		0.92176 0.3981	0.35324 0.7025				
3		2.5907 0.0753	0.13913 0.8701	0.52343 0.5926			
5		3.3685 0.0347	0.29959 0.7412	1.2803 0.2783	0.30211 0.7393		
6		7.4806 0.0006	3.3665 0.0348	3.3840 0.0342	2.1982 0.1114	3.4187 0.0330	
7		0.53618 0.5851	1.3416 0.2618	0.32686 0.7212	1.6507 0.1923	2.9038 0.0552	4.5608 0.0106

Figure 7.12 - Females - Variables: HYPOR - HYPBH

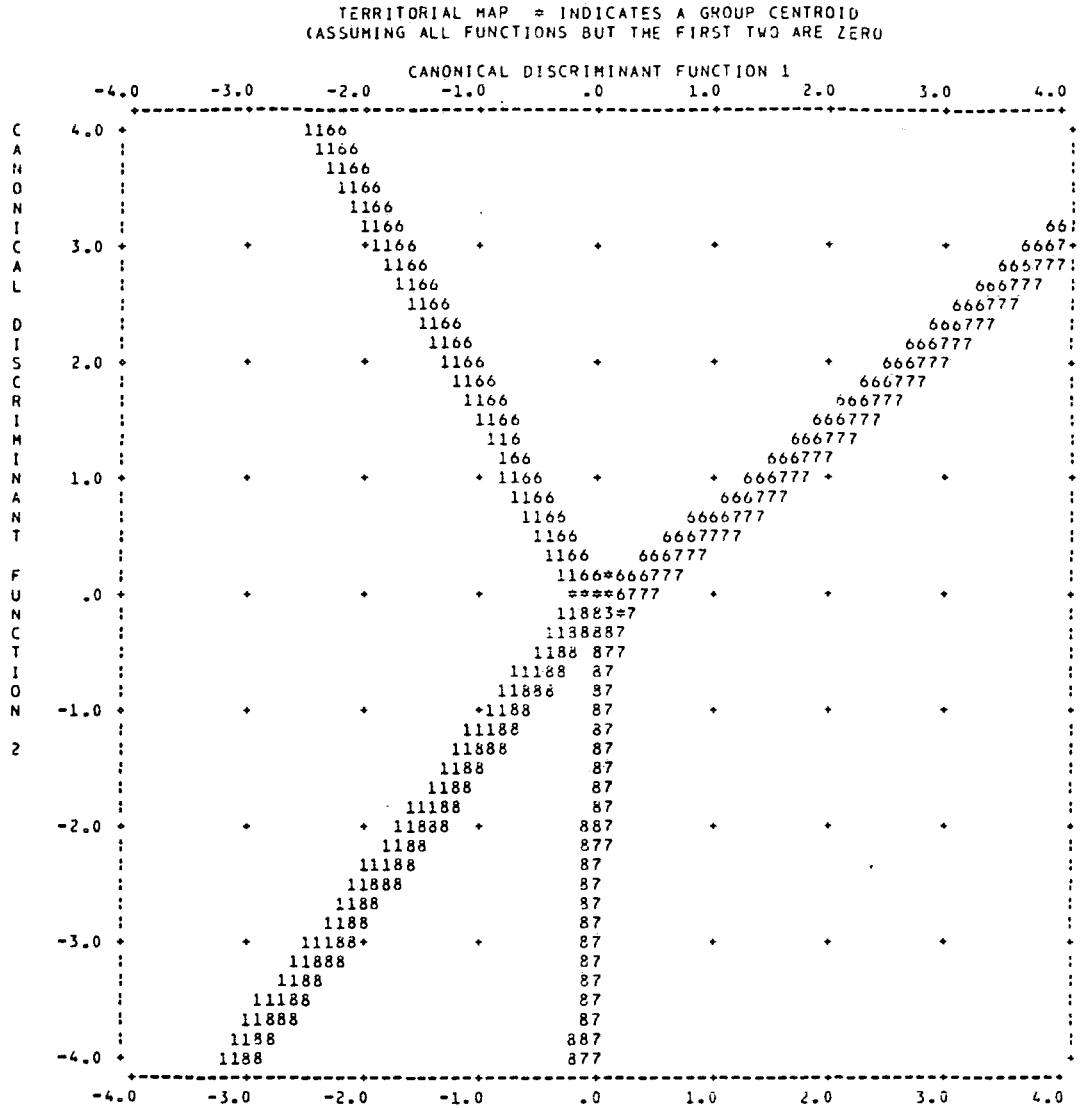

Code Group

1 - Controls
 2 - Psoriasis
 3 - Atopic Eczema
 4 - SCC
 6 - Alopecia areata
 7 - Actinic Keratosis
 8 - Vitiligo

Figure 7.13 - Females - HYPOR - HYPBH

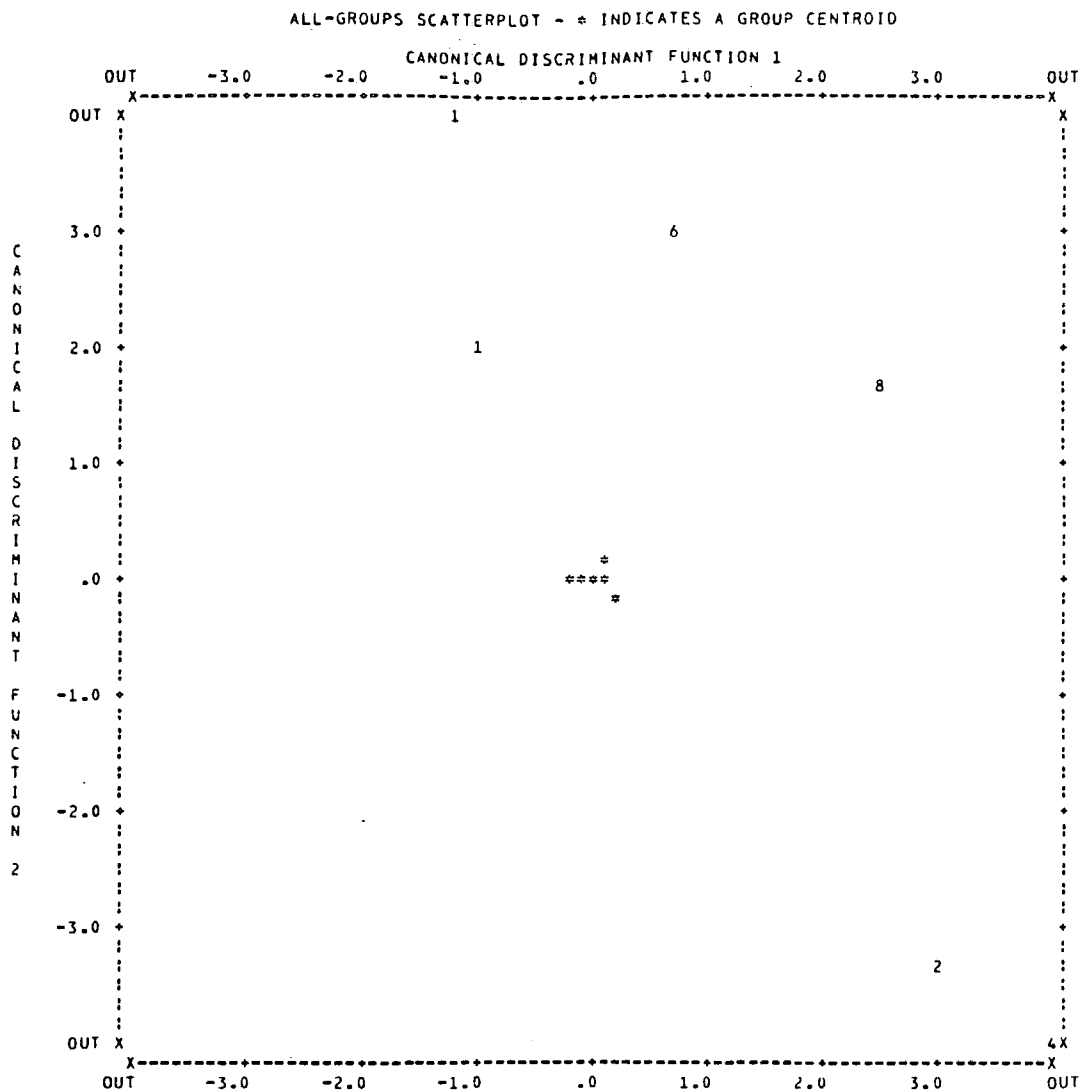

			6		
1	8	2+3	4		
				7	

- Code Group
- 1 - Controls
 - 2 - Psoriasis
 - 3 - Atopic Eczema
 - 4 - BCC
 - 6 - Alopecia areata
 - 7 - Actinic Keratosis
 - 8 - Vitiligo

Figure 7.14 - Group Centroids

Table 7.39 - Females - Variables: HYPOR - HYPBH

CLASSIFICATION RESULTS -

ACTUAL GROUP		NO. OF CASES	PREDICTED GROUP MEMBERSHIP						
			0	1	2	3	5	6	7
GROUP	0	202	109 54.0%	0 0.0%	0 0.0%	0 0.0%	28 13.9%	65 32.2%	0 0.0%
GROUP	1	205	100 48.8%	0 0.0%	0 0.0%	0 0.0%	19 9.3%	86 42.0%	0 0.0%
GROUP	2	203	99 48.8%	0 0.0%	0 0.0%	0 0.0%	22 10.8%	82 40.4%	0 0.0%
GROUP	3	202	100 49.5%	0 0.0%	0 0.0%	0 0.0%	15 7.4%	87 43.1%	0 0.0%
GROUP	5	206	96 46.6%	0 0.0%	0 0.0%	0 0.0%	19 9.2%	91 44.2%	0 0.0%
GROUP	6	172	68 39.5%	0 0.0%	0 0.0%	0 0.0%	9 5.2%	95 55.2%	0 0.0%
GROUP	7	205	117 57.1%	0 0.0%	0 0.0%	0 0.0%	14 6.8%	74 36.1%	0 0.0%

PERCENT OF "GROUPED" CASES CORRECTLY CLASSIFIED: 15.99%

Next are alopecia areata and vitiligo. The classification results show 15.99% correct classification with actinic keratosis having 55.2% correct, controls 54% correct and alopecia areata having 9.2% correctly classified cases (Table 7.39). All other groups show 0% correct classification.

When groups were reclassified according to aetiology of disorder the only statistically significant differences which were found for male subjects were between GD and ND for all of the variables HYPOR, HYPOL and HYPBH (Table 7.40). GD males were found to have significantly higher frequency of occurrence for all of the three variables.

Female controls were found to have a significantly lower frequency of occurrence for HYPOR in comparison to both GD and ND and for HYPOL and HYPBH also when compared to ND. GD females were found to have a statistically significantly lower frequency of occurrence for HYPOR in comparison to ND females.

Table 7.40 - Probabilities from Mann-Whitney U Tests

Subjects grouped by disorder type - Variables: HYPOR - HYPBH

			PROBABILITIES		
Sex	Gp1	Gp2	HYPOR	HYPOL	HYPBH
M	Cont	GD	0.1291	0.1269	0.0859
M	Cont	ND	0.8337	0.8187	0.8890
M	GD	ND	0.338*	0.0282*	0.0200*
F	Cont	GD	0.0425*	0.1003	0.0804
F	Cont	ND	0.0004**	0.0399*	0.0034**
F	GD	ND	0.0164*	0.4103	0.0714

7.2 Palmar Triradii

(a) Accessory Triradii (extra triradii in interdigital areas) - Variables: LX2 - RX4

For male subjects, psoriasis patients were found to have statistically highly significantly greater frequency of occurrence of extra triradii in I_4 of both hands in comparison to vitiligo, alopecia areata and BCC patients (sig.). Also for I_4 , actinic keratosis males had a significantly higher frequency of occurrence of extra triradii on both hands when compared to vitiligo and on the left hand in comparison to alopecia areata and BCC. Control subjects were found to have a statistically higher incidence of extra triradii on I_4 in comparison to vitiligo for both hands and in comparison to alopecia areata for the left hand only. For occurrence of extra triradii in I_3 a statistically higher frequency was found in BCC females when compared to atopic eczema, vitiligo and controls on the right hand. BCC females were also found to have a statistically higher occurrence of extra triradii in I_3 in comparison to psoriasis on the left hand. Psoriasis female patients were found to have a statistically higher incidence of extra triradii in I_3 of the right hand (see Tables 7.41(a) and 7.42(a)).

The results for female subjects show that a highly significantly greater frequency of occurrence of extra triradii on I_4 of the left hand in comparison to atopic eczema, vitiligo, alopecia areata, BCC (both hands) and actinic keratosis (sig.). On the right hand I_3 a statistically significantly higher frequency of occurrence of extra triradii was found in psoriasis females when compared to vitiligo females (see Tables 7.41(b) and 7.42(b)).

(b) Axial Triradii - Variables: LTO - TBR

For frequency of occurrence of the axial triradius in the most proximal position, designated as t, there were found to be no statistically significant differences in any of the intergroup comparisons for male subjects. For t' psoriasis males were found to have a significantly higher frequency of occurrence in comparison to controls on the right hand and compared to BCC males on the left hand. BCC males were found to have a statistically significantly higher occurrence of t" in comparison to vitiligo and actinic keratosis

on both hands. Control male subjects were found to have a statistically significantly higher frequency of occurrence of t" on both hands in comparison to actinic keratosis and on the right hand only in comparison to alopecia areata (see Tables 7.43 and 7.45(a)). For the frequency of occurrence of border triradius, atopic eczema males were found to have a statistically significantly greater incidence in comparison to vitiligo, BCC and controls for both hands and in comparison to psoriasis and actinic keratosis for the left hand only. Vitiligo males were also found to have a statistically significantly higher occurrence compared to BCC and a statistically lower occurrence compared to alopecia areata on the right hand only (Tables 7.43 and 7.45(a)).

In female subjects a statistically significantly higher incidence of t was found in vitiligo when compared to controls and BCC on the left hand only. Vitiligo females were also found to have a smaller occurrence of t' on the left hand in comparison to alopecia areata subjects with the difference being found to be highly significant statistically. For t" occurrence, alopecia areata females were found to have a lower frequency which was statistically highly significant compared to BCC and psoriasis on both hands, and to controls on the left hand only. The difference was found to be statistically significant in comparison to actinic keratosis (left hand only) and to atopic eczema (right hand only). BCC females were found to have a higher incidence of t" in comparison to alopecia areata (H.Sig. on both hands) and to atopic eczema and vitiligo (sig. on left hand only). For border triradius occurrence, actinic keratosis female subjects were found to have a statistically highly significantly greater incidence on the right hand in comparison to vitiligo, atopic eczema, controls and psoriasis (sig.). On the left hand alopecia areata females had a greater frequency of occurrence which was highly significant in comparison to controls and significant compared to atopic eczema (see Tables 7.44 and 7.45(b)).

Percentage Frequencies

7.41

Occurrence of Extra Triradii in Interdigital Areas

(a) Sex = Male

Group	Cases	Percentage Frequencies													
		LX2		LX3		LX4			RX2		RX3		RX4		
		0	1	0	1	0	1	2	0	1	0	1	0	1	2
Controls	205	97.6	2.4	99.5	0.5	82.0	18.0	0.0	94.6	5.4	100.0	0.0	85.4	14.6	0.0
Psoriasis	202	96.5	3.5	100.0	0.0	80.2	19.8	0.0	97.0	3.0	97.5	2.5	78.7	20.8	0.5
Atop Ecz	203	97.0	3.0	100.0	0.0	86.2	13.7	0.0	98.0	2.0	100.0	0.0	85.2	14.8	0.0
Vitiligo	201	97.5	2.5	100.0	0.0	90.0	10.0	0.0	98.0	2.0	100.0	0.0	92.5	7.5	0.0
Alop Are	210	98.1	1.9	99.0	1.0	91.9	7.6	0.5	97.6	2.4	99.0	1.0	90.5	9.5	0.0
BCC	211	96.7	3.3	98.6	1.4	88.2	11.8	0.0	98.1	1.9	97.2	2.8	89.1	10.9	0.0
Act Ker	129	96.1	3.9	98.4	1.6	78.3	20.9	0.8	97.7	2.3	99.2	0.8	85.3	14.7	0.0

(b) Sex = Female

Group	Cases	Percentage Frequencies													
		LX2		LX3		LX4			RX2		RX3		RX4		
		0	1	0	1	0	1	2	0	1	0	1	0	1	2
Controls	203	98.5	1.5	99.0	1.0	81.3	17.7	1.0	98.0	2.0	99.5	0.5	83.3	16.7	0.0
Psoriasis	205	98.5	1.5	99.0	1.0	89.3	10.7	0.0	98.0	2.0	98.0	2.0	87.3	12.7	0.0
Atop Ecz	203	99.0	1.0	99.0	1.0	91.1	8.9	0.0	98.5	1.5	99.5	0.5	89.7	10.3	0.0
Vitiligo	205	96.6	3.4	99.5	0.5	90.7	9.3	0.0	96.6	3.4	100.0	0.0	85.4	14.6	0.0
Alop Are	206	96.6	3.4	100.0	0.0	93.7	6.3	0.0	96.6	3.4	99.0	1.0	89.8	10.2	0.0
BCC	202	98.5	1.5	100.0	0.0	92.6	7.4	0.0	97.5	2.5	99.0	1.0	90.1	9.9	0.0
Act Ker	174	97.1	2.9	99.4	0.6	88.5	11.5	0.0	97.7	2.3	99.4	0.6	87.9	12.1	0.0

Mann Whitney U Test Results

7.42(a)

Extra Triradii in Interdigital Areas

Males

		Probability (* = significant, ** = highly significant)					
Group 1	Group 2	LX2	LX3	LX4	RX2	RX3	RX4
Control	Psoriasis	0.5410	0.3209	0.6520	0.2277	0.0236*	0.0775
Control	Atop Ecz	0.7476	0.3197	0.2408	0.0688	1.0000	0.9672
Control	Vitiligo	0.9749	0.3221	0.0190*	0.0717	1.0000	0.0215*
Control	Alop Are	0.7091	0.5769	0.0029**	0.1148	0.1618	0.1103
Control	BCC	0.5929	0.3297	0.0762	0.0580	0.0151*	0.2541
Control	Act Ker	0.4538	0.3170	0.3944	0.1777	0.2074	0.9811
Psoriasis	Atop Ecz	0.7714	1.0000	0.1062	0.5173	0.0243*	0.0854
Psoriasis	Vi tiligo	0.5641	1.0000	0.0055**	0.5276	0.0250*	0.0001**
Psoriasis	Alop Are	0.3265	0.1649	0.0007**	0.7110	0.2324	0.0009**
Psoriasis	BCC	0.9340	0.0267*	0.0267*	0.4781	0.8164	0.0038*
Psoriasis	Act Ker	0.8457	0.0763	0.6521	0.7254	0.2589	0.1323
Atop Ecz	Vitiligo	0.7728	1.0000	0.2332	0.9887	1.0000	0.0196*
Atop Ecz	Alop Are	0.4878	0.1639	0.0667	0.7754	0.1639	0.1021
Atop Ecz	BCC	0.8330	0.0886	0.5543	0.9560	0.0156*	0.2383
Atop Ecz	Act Ker	0.6484	0.0756	0.0576	0.8265	0.2097	0.9901
Vitiligo	Alop Are	0.6869	0.1660	0.5227	0.7869	0.1660	0.4548
Vitiligo	BCC	0.6170	0.0901	0.5375	0.9448	0.0162*	0.2286
Vitiligo	Act Ker	0.4735	0.0771	0.0030**	0.8367	0.2119	0.0344*
Alop Are	BCC	0.3641	0.6570	0.2063	0.7310	0.1558	0.6413
Alop Are	Act Ker	0.2737	0.6211	0.0004**	0.9740	0.8659	0.1454
BCC	Act Ker	0.7869	0.9240	0.0143*	0.7868	0.1931	0.2986

Mann-Whitney U Test Results

7.42(b)

Extra Triradii in Interdigital Areas

Females

		Probability (* = significant, ** = highly significant)					
Group 1	Group 2	LX2	LX3	LX4	RX2	RX3	RX4
Control	Psoriasis	0.9904	0.9921	0.0212*	0.9888	0.1811	0.2469
Control	Atop Ecz	0.6531	1.0000	0.0037**	0.7034	1.0000	0.0597
Control	Vitiligo	0.2064	0.5570	0.0055**	0.3684	0.3149	0.5575
Control	Alop Are	0.2092	0.1538	0.0001**	0.3728	0.5714	0.0523
Control	BCC	0.9951	0.1578	0.0007**	0.7307	0.5598	0.0429*
Control	Act Ker	0.3492	0.6551	0.0494*	0.8257	0.9130	0.2000
Psoriasis	Atop Ecz	0.6611	0.9921	0.5270	0.7131	0.1811	0.4601
Psoriasis	Vitiligo	0.2009	0.5628	0.6218	0.3598	0.0447*	0.5656
Psoriasis	Alop Are	0.2036	0.1558	0.1088	0.3641	0.4079	0.4285
Psoriasis	BCC	0.9855	0.1599	0.2466	0.7196	0.4217	0.3761
Psoriasis	Act Ker	0.3419	0.6612	0.8139	0.8147	0.2425	0.8568
Atop Ecz	Vitiligo	0.0952	0.5570	0.8879	0.2064	0.3149	0.1908
Atop Ecz	Alop Are	0.0967	0.1538	0.3293	0.2092	0.5714	0.9600
Atop Ecz	BCC	0.6491	0.1578	0.5965	0.4713	0.5598	0.8824
Atop Ecz	Act Ker	0.1763	0.6551	0.3989	0.5560	0.9130	0.5963
Vitiligo	Alop Are	0.9926	0.3161	0.2636	0.9926	0.1578	0.1727
Vitiligo	BCC	0.2093	0.3209	0.5023	0.5758	0.1537	0.1463
Vitiligo	Act Ker	0.7646	0.9075	0.4778	0.5196	0.2777	0.4664
Alop Are	BCC	0.2121	1.0000	0.6564	0.5817	0.9843	0.9216
Alop Are	Act Ker	0.7711	0.2766	0.0742	0.5248	0.6642	0.5619
BCC	Act Ker	0.3529	0.2813	0.1764	0.9113	0.6521	0.5018

Table 7.43

Percentage Frequencies : Axial Triradii Occurrence

Males

(a) Left Hand

Group	Cases	Percentage Frequencies									
		LTO			LT1			LT11		TBL	
Controls	206	24.9	75.1	0.0	70.2	29.8	0.0	92.2	7.8	71.3	28.7
Psoriasis	202	20.8	79.2	0.0	66.3	33.2	0.5	94.1	5.9	70.3	29.7
Atop Ecz	203	20.2	79.8	0.0	70.0	30.0	0.0	95.1	4.9	59.6	40.4
Vitiligo	201	22.9	76.6	0.5	70.6	29.4	0.0	94.0	6.0	73.6	26.4
Alop Are	210	21.0	78.6	0.5	71.9	28.1	0.0	96.2	3.8	66.2	33.8
BCC	211	19.4	80.6	0.0	75.8	24.2	0.0	91.5	8.5	73.9	26.1
Act Ker	129	20.2	79.8	0.0	69.8	30.2	0.0	97.7	2.3	73.6	26.4

(b) Right Hand

Group	Cases	Percentage Frequencies									
		RT			RT1			RT11		TBR	
Controls	206	19.5	80.5	0.0	76.6	22.9	0.5	90.7	9.3	72.1	27.9
Psoriasis	202	23.3	76.7	0.0	65.8	34.2	0.0	95.0	5.0	67.3	32.7
Atop Ecz	203	20.2	79.8	0.0	69.5	30.5	0.0	95.1	4.9	58.1	41.9
Vitiligo	201	21.4	78.6	0.0	72.1	27.9	0.0	95.0	5.0	73.1	26.9
Alop Are	210	21.0	79.0	0.0	72.9	27.1	0.0	96.2	3.8	62.9	37.1
BCC	211	21.8	78.2	0.0	72.0	28.0	0.0	91.0	9.0	74.9	25.1
Act Ker	129	23.3	76.7	0.0	69.8	30.2	0.0	96.9	3.1	68.2	31.8

Table 7.44

Percentage Frequencies : Axial Triradii Occurrence

Females

(a) Left Hand

Group	Cases	Percentage Frequencies									
		LTO			LT1			LT11		TBL	
Controls	203	29.6	70.4	0.0	63.1	36.5	0.5	92.6	7.4	75.4	24.6
Psoriasis	205	22.9	77.1	0.0	67.3	32.2	0.2	91.7	8.3	70.2	29.8
Atop Ecz	203	21.7	78.3	0.0	65.5	34.5	0.0	96.1	3.9	72.9	27.1
Vitiligo	205	18.5	81.5	0.0	73.7	26.3	0.0	96.6	3.4	72.2	27.8
Alop Are	206	25.2	74.8	0.0	60.7	38.8	0.5	98.5	1.5	63.6	36.6
BCC	202	26.7	73.3	0.0	67.3	32.7	0.0	90.6	9.4	67.3	32.7
Act Ker	174	25.3	74.7	0.0	64.9	35.1	0.0	94.8	5.2	66.7	33.3

(b) Right Hand

Group	Cases	Percentage Frequencies									
		RT			RT1			RT11		TBR	
Controls	203	27.6	72.4	0.0	69.0	31.0	0.0	95.1	4.9	72.4	27.6
Psoriasis	205	22.0	77.6	0.5	67.3	32.7	0.0	93.2	6.8	70.7	29.3
Atop Ecz	203	20.7	79.3	0.0	66.5	33.5	0.0	93.6	6.4	74.9	25.1
Vitiligo	205	19.5	80.5	0.0	70.7	29.3	0.0	95.1	4.9	74.1	25.9
Alop Are	206	23.3	76.7	0.0	62.6	37.4	0.0	98.1	1.9	67.0	33.0
BCC	202	26.2	73.8	0.0	65.3	34.7	0.0	92.1	7.9	67.8	32.2
Act Ker	174	23.0	77.0	0.0	65.2	36.8	0.0	95.4	4.6	59.8	40.2

Table 7.45(a)

Mann-Whitney U Test Results

Axial Triradii Occurrence

Males

		Probability (* = Significant, ** = Highly Significant)							
Group 1	Group 2	LTO	LT1	LT11	TBL	RT	RT1	RT11	TBR
Control	Psoriasis	0.3269	0.3803	0.4581	0.8270	0.3561	0.0186*	0.0908	0.3001
Control	Atop Ecz	0.2585	0.9485	0.2345	0.0136*	0.8625	0.1128	0.0883	0.0032**
Control	Vitiligo	0.5781	0.9292	0.4665	0.5988	0.6389	0.3207	0.0935	0.8085
Control	Alop Are	0.3016	0.7094	0.0816	0.2654	0.7154	0.4003	0.0244*	0.0461*
Control	BCC	0.1813	0.1997	0.7873	0.5469	0.5649	0.3042	0.9258	0.5153
Control	Act Ker	0.3191	0.9264	0.0356*	0.6412	0.4138	0.1171	0.0305*	0.4543
Psoriasis	Atop Ecz	0.8822	0.4172	0.6528	0.0243*	0.4543	0.4372	0.9910	0.559
Psoriasis	Vitiligo	0.6814	0.3366	0.9900	0.4567	0.6519	0.1723	0.9909	0.2029
Psoriasis	Alop Are	0.9571	0.2106	0.3149	0.3715	0.5717	0.1228	0.5716	0.3421
Psoriasis	BCC	0.7304	0.0314*	0.3112	0.4104	0.7217	0.1740	0.1074	0.0905
Psoriasis	Act Ker	0.8889	0.4980	0.1236	0.5109	0.9981	0.4582	0.4155	0.8661
Atop Ecz	Vitiligo	0.5775	0.8785	0.6442	0.0028**	0.7674	0.5540	0.9819	0.0015**
Atop Ecz	Alop Are	0.9253	0.6623	0.5789	0.1665	0.8496	0.4463	0.5789	0.3262
Atop Ecz	BCC	0.8452	0.1788	0.1447	0.0020**	0.6892	0.5644	0.1045	0.0003**
Atop Ecz	Act Ker	0.9926	0.9717	0.2345	0.0090**	0.5083	0.9525	0.4206	0.0652
Vitiligo	Alop Are	0.6435	0.7784	0.3094	0.1008	0.9131	0.8707	0.5643	0.0259*
Vitiligo	BCC	0.4504	0.2352	0.3180	0.9446	0.9200	0.9817	0.1104	0.6864
Vitiligo	Act Ker	0.6190	0.8648	0.1215	0.9981	0.6912	0.6429	0.4105	0.3364
Vitiligo	BCC	0.7726	0.3600	0.0445*	0.0832	0.8320	0.8510	0.0298*	0.0078**
Alop Are	Act Ker	0.9271	0.6739	0.4547	0.1502	0.6187	0.5405	0.7321	0.3162
BCC	Act Ker	0.8709	0.2196	0.0213*	0.9530	0.7550	0.6543	0.0357*	0.1831

Table 7.45(b)

Mann Whitney U Test Results : Axial Triradii Occurrence

Females

Group 1	Group 2	Probability (* = Significant, ** = Highly Significant)							
		LTO	LT1	LT11	TBL	RT	RT1	RT11	TBR
Control	Psoriasis	0.1254	0.3695	0.7346	0.2453	0.1632	0.7212	0.4146	0.7068
Control	Atop Ecz	0.0692	0.5806	0.1334	0.5714	0.1049	0.5960	0.5201	0.5737
Control	Vitiligo	0.0093**	0.0200*	0.0759	0.4660	0.0549	0.6978	0.9821	0.6929
Control	Alop Are	0.3286	0.6241	0.0035**	0.0096**	0.3203	0.1769	0.0974	0.2334
Control	BCC	0.5280	0.0350	0.4649	0.0738	0.7599	0.4387	0.2195	0.3133
Control	Act Ker	0.3558	0.6785	0.3801	0.0628	0.3077	0.2398	0.8816	0.0096**
Psoriasis	Atop Ecz	0.7616	0.7276	0.0672	0.5516	0.8302	0.8614	0.8630	0.3474
Psoriasis	Vi tiligo	0.2735	0.1517	0.0356*	0.6630	0.6114	0.4552	0.4006	0.4397
Psoriasis	Alop Are	0.5835	0.1642	0.0013**	0.1524	0.6779	0.3190	0.0156*	0.4134
Psoriasis	BCC	0.3747	0.9711	0.6929	0.5259	0.2755	0.6744	0.6739	0.5251
Psoriasis	Act Ker	0.5924	0.6519	0.2317	0.4552	0.7439	0.4037	0.3552	0.0253*
Atop Ecz	Vitiligo	0.4296	0.0742	0.7779	0.8723	0.7669	0.3579	0.5046	0.8657
Atop Ecz	Alop Are	0.3952	0.2953	0.1209	0.0434*	0.5244	0.4126	0.0240*	0.0795
Atop Ecz	BCC	0.2353	0.7002	0.0277*	0.2205	0.1882	0.8064	0.5544	0.1168
Atop Ecz	Act Ker	0.4091	0.9071	0.5662	0.1880	0.5901	0.5057	0.4465	0.0018**
Vitiligo	Alop Are	0.1006	0.0047**	0.1982	0.0621	0.3497	0.0815	0.1012	0.1119
Vitiligo	BCC	0.0484*	0.1618	0.0136*	0.2855	0.1066	0.2446	0.2100	0.1602
Vitiligo	Act Ker	0.1122	0.0662	0.3970	0.2440	0.4092	0.1208	0.8984	0.0029**
Alop Are	BCC	0.7318	0.1530	0.0004**	0.4283	0.4925	0.5669	0.0052**	0.8580
Alop Are	Act Ker	0.9920	0.3745	0.0393*	0.5318	0.9427	0.9046	0.1407	0.1453
BCC	Act Ker	0.7506	0.6264	0.1195	0.8922	0.4672	0.6679	0.1893	0.1051

(c) Axial Triradial Counts - Variables: AXR, AXL and TTAX

For counts of the axial triradial present, atopic eczema males were found to have statistically significantly higher values for both hands individually and combined in comparison to actinic keratosis, BCC, vitiligo and controls and for the left hand only compared to alopecia areata. Psoriasis males were found to have statistically significantly higher total counts (for both hands combined) in comparison to vitiligo and BCC (see Tables 7.46(a) and 7.47(a)).

Actinic keratosis females were found to have statistically significantly higher counts, on the right hand and both hands combined, in comparison to vitiligo, atopic eczema and controls, and for right hand only in comparison to BCC and psoriasis. Control females were found to have significantly lower counts in comparison to BCC and psoriasis (right only), alopecia areata (both hands individually and combined) and actinic keratosis (right hand and both hands combined). Alopecia areata females had significantly higher counts compared to vitiligo (left hand and both combined) and controls (all three variables), see Tables 7.46(b) and 7.47(b).

(d) Palmar Pattern Intensity Indices - Variables: LPPII, RPPII, TPPII

Atopic eczema males were found to have statistically significantly greater values for Palmar Pattern Intensity Indices on both hands individually and combined when compared to BCC, alopecia areata and controls (RPPII and TPPII only). Psoriatic males were found to have statistically significantly higher values compared to alopecia areata (for all three indices), to vitiligo (for RPPII and TPPII) and to controls (RPPII only) and significantly lower values compared to BCC (for RPPII and TPPII), see Tables 7.48(a) and 7.49(a).

For female subjects, actinic keratosis were found to have a highly significantly greater RPPII mean value in comparison to controls, atopic eczema and vitiligo. TPPII was also significantly higher for actinic keratosis compared to vitiligo (see Tables 7.48(b) and 7.49(b)).

When discriminant analysis was carried out for males using the Palmar Pattern Intensity Indices only one canonical discriminant function was produced (Table 7.50(a)). The most important variable

in Function 1 was found to be LPPII (Tables 7.50(b) and (c)). The Table of F Statistics shows that the groups furthest separated were alopecia areata and atopic eczema ($F = 3.5708$) and BCC and actinic keratosis ($F = 3.5285$). In neither of the groups was the significance at the 1% or 5% level (Table 7.51). Figure 7.15 shows alopecia areata and atopic eczema to be the furthest separated groups. The classification for males (Table 7.52) shows 17.4% correct classification. Atopic eczema has the best correct classification (65.5%) followed by alopecia areata (49%). All other groups had 0% correct classification.

Female subjects were subjected to discriminant analysis using this set of variables. Two canonical discriminant functions were produced (Table 7.53(a)) with Function 1 accounting for 92.69% of the variance. RPPII was found to be the most important variable in Function 1 (Table 7.53(c)).

Table 7.54 shows that the groups which are furthest apart are actinic keratosis ($F = 6.4879$) followed by BCC and actinic keratosis ($F = 4.5860$). The territorial map (Figure 7.16) shows controls, actinic keratosis and vitiligo to be the most widely separated groups. The All-Groups Scatterplot (Figure 7.17) and the group centroids from it (Figure 7.18) shows BCC, atopic eczema and controls to occupy the centroid furthest to the left with another centroid occupied by vitiligo, alopecia areata and psoriasis closely adjacent to it. The centroid for actinic keratosis is removed to the right away from the other two group centroids.

The Table of Classification Results (Table 7.55) shows that only 15.08% of cases were correctly grouped. The best groups were controls (47%), vitiligo (38.5%) and actinic keratosis (20.9%). All the other groups had 0% correct classification.

Table 7.46

Means and Standard Deviation

Axial Triradii

(a) Sex = Male

Group	Cases	Variables					
		AXR		AXL		TTAX	
		Mean	Std. Dev.	Mean	Std. Dev.	Mean	Std. Dev.
Control	206	1.417 +/- 0.551		1.411 +/- 0.550		2.882 +/- 1.006	
Psoriasis	202	1.485 +/- 0.557		1.490 +/- 0.530		2.975 +/- 0.995	
Atop Ecz	203	1.571 +/- 0.587		1.552 +/- 0.546		3.123 +/- 1.039	
Vitiligo	201	1.383 +/- 0.536		1.393 +/- 0.490		2.776 +/- 0.930	
Alop Are	210	1.471 +/- 0.528		1.452 +/- 0.553		2.924 +/- 0.985	
BCC	211	1.403 +/- 0.589		1.393 +/- 0.518		1.796 +/- 1.001	
Act Ker	129	1.419 +/- 0.511		1.388 +/- 0.489		2.806 +/- 0.928	

(b) Sex = Female

Group	Cases	Variables					
		AXR		AXL		TTAX	
		Mean	Std. Dev.	Mean	Std. Dev.	Mean	Std. Dev.
Control	203	1.360 +/- 0.530		1.399 +/- 0.539		2.759 +/- 0.942	
Psoriasis	205	1.473 +/- 0.565		1.483 +/- 0.557		2.956 +/- 1.040	
Atop Ecz	203	1.443 +/- 0.554		1.438 +/- 0.536		2.882 +/- 0.978	
Vitiligo	205	1.405 +/- 0.538		1.390 +/- 0.518		2.795 +/- 1.032	
Alop Are	206	1.490 +/- 0.582		1.524 +/- 0.547		3.015 +/- 1.048	
BCC	202	1.485 +/- 0.609		1.480 +/- 0.583		2.965 +/- 1.085	
Act Ker	174	1.586 +/- 0.549		1.483 +/- 0.513		3.069 +/- 0.959	

Table 7.47

Mann-Whitney U Test Results

Axial Triradii

(a) Males

Group 1	Group 2	Probability		
		AXR	AXL	TTAX
Control	Psoriasis	0.1810	0.0855	0.0887
Control	Atop Ecz	0.0057**	0.0051**	0.0023**
Control	Vitiligo	0.5367	0.9855	0.8037
Control	Alop Are	0.2058	0.4106	0.2360
Control	BCC	0.5779	0.8504	0.8005
Control	Act Ker	0.7935	0.9103	0.9547
Psoriasis	Atop Ecz	0.1455	0.2672	0.1753
Psoriasis	Vi tiligo	0.0508	0.0758	0.0450*
Psoriasis	Alop Are	0.9137	0.3723	0.5971
Psoriasis	BCC	0.0617	0.0525	0.0489*
Psoriasis	Act Ker	0.3453	0.0967	0.1394
Atop Ecz	Vitiligo	0.0008**	0.0040**	0.0007**
Atop Ecz	Alop Are	0.1089	0.0474*	0.0590
Atop Ecz	BCC	0.0011**	0.0024**	0.0009**
Atop Ecz	Act Ker	0.0256*	0.0085**	0.0075**
Vitiligo	Alop Are	0.0579	0.3894	0.1388
Vitiligo	BCC	0.9590	0.8631	0.9839
Vitiligo	Act Ker	0.4120	0.9214	0.7672
Alop Are	BCC	0.0701	0.3043	0.1480
Alop Are	Act Ker	0.3841	0.3936	0.3088
BCC	Act Ker	0.4483	0.9570	0.7719

(b) Females

Group 1	Group 2	Probability		
		AXR	AXL	TTAX
Control	Psoriasis	0.0316*	0.1086	0.0677
Control	Atop Ecz	0.1051	0.3977	0.1950
Control	Vitiligo	0.5463	0.9579	0.9855
Control	Alop Are	0.0182*	0.0135*	0.0150*
Control	BCC	0.0372*	0.1734	0.0879
Control	Act Ker	0.0000**	0.0702	0.0010**
Psoriasis	Atop Ecz	0.5945	0.4406	0.5527
Psoriasis	Vitiligo	0.1326	0.0931	0.0888
Psoriasis	Alop Are	0.8171	0.3919	0.5273
Psoriasis	BCC	0.9819	0.8328	0.9724
Psoriasis	Act Ker	0.0323*	0.8171	0.1790
Atop Ecz	Vitiligo	0.3246	0.3628	0.2244
Atop Ecz	Alop Are	0.4478	0.1012	0.2203
Atop Ecz	BCC	0.6184	0.5875	0.6022
Atop Ecz	Act Ker	0.0079**	0.3209	0.0435*
Vitiligo	Alop Are	0.0859	0.0106*	0.0224*
Vitiligo	BCC	0.1460	0.1524	0.1084
Vitiligo	Act Ker	0.0004**	0.0591	0.0024**
Alop Are	BCC	0.8041	0.2938	0.5197
Alop Are	Act Ker	0.0580	0.5415	0.4944
BCC	Act Ker	0.0344*	0.6642	0.1816

Table 7.48

Means and Standard Deviations :

Palmar Pattern Intensity Indices

(a) Sex = Males

Group	Cases	Variables					
		LPPII		RPPII		TPPII	
		Mean	Std. Dev.	Mean	Std. Dev.	Mean	Std. Dev.
Control	206	5.878 +/- 2.419		5.688 +/- 0.804		11.566 +/- 2.659	
Psoriasis	202	5.837 +/- 0.976		5.881 +/- 0.861		11.718 +/- 1.628	
Atop Ecz	203	5.887 +/- 0.828		5.916 +/- 0.855		11.803 +/- 1.558	
Vitiligo	201	5.711 +/- 0.798		5.637 +/- 0.808		11.348 +/- 1.466	
Alop Are	210	5.662 +/- 0.780		5.695 +/- 0.759		11.357 +/- 1.391	
BCC	211	5.687 +/- 0.748		5.929 +/- 4.221		11.616 +/- 4.309	
Act Ker	129	5.767 +/- 0.776		5.705 +/- 0.678		11.473 +/- 1.323	

(b) Sex = Females

Group	Cases	Variables					
		LPPII		RPPII		TPPII	
		Mean	Std. Dev.	Mean	Std. Dev.	Mean	Std. Dev.
Control	203	5.719 +/- 0.882		5.643 +/- 0.852		11.365 +/- 1.572	
Psoriasis	205	5.647 +/- 0.984		5.737 +/- 0.798		11.377 +/- 1.554	
Atop Ecz	203	5.673 +/- 0.806		5.660 +/- 0.807		11.337 +/- 1.475	
Vitiligo	205	5.634 +/- 0.809		5.683 +/- 0.859		11.317 +/- 1.535	
Alop Are	206	5.689 +/- 0.784		5.748 +/- 0.793		11.437 +/- 1.466	
BCC	202	5.698 +/- 0.775		5.688 +/- 0.879		11.386 +/- 1.503	
Act Ker	174	5.661 +/- 0.843		5.971 +/- 2.436		11.632 +/- 2.800	

Table 7.49

Mann-Whitney U Test Results :

Palmar Pattern Intensity Indices :

(a) Males

Group 1	Group 2	Probability		
		LPPII	RPPII	TPPII
Control	Psoriasis	0.2940	0.0136*	0.0658
Control	Atop Ecz	0.7722	0.0041**	0.0194*
Control	Vitiligo	0.5906	0.5156	0.4894
Control	Alop Are	0.2604	0.7433	0.6228
Control	BCC	0.4633	0.7732	0.6556
Control	Act Ker	0.7612	0.4551	0.6513
Psoriasis	Atop Ecz	0.4988	0.6995	0.5656
Psoriasis	Vitiligo	0.1166	0.0015**	0.0101*
Psoriasis	Alop Are	0.0315*	0.0227*	0.0149*
Psoriasis	BCC	0.0693	0.0034**	0.0167*
Psoriasis	Act Ker	0.4935	0.1129	0.2243
Atop Ecz	Vitiligo	0.0220*	0.0004**	0.0017**
Atop Ecz	Alop Are	0.0039**	0.0073**	0.0027**
Atop Ecz	BCC	0.0095**	0.0009**	0.0026**
Atop Ecz	Act Ker	0.1708	0.0521	0.0770
Vitiligo	Alop Are	0.5603	0.3038	0.8363
Vitiligo	BCC	0.8722	0.6843	0.7660
Vitiligo	Act Ker	0.4171	0.1570	0.2370
Alop Are	BCC	0.6555	0.5080	0.9259
Alop Are	Act Ker	0.1771	0.6166	0.3107
BCC	Act Ker	0.3098	0.2641	0.3264

(b) Females

Group 1	Group 2	Probability		
		LPPII	RPPII	TPPII
Control	Psoriasis	0.9483	0.1113	0.4488
Control	Atop Ecz	0.8779	0.6332	0.9218
Control	Vitiligo	0.3433	0.6430	0.7685
Control	Alop Are	0.9986	0.0799	0.4271
Control	BCC	0.9886	0.2442	0.6958
Control	Act Ker	0.8115	0.0021**	0.0615
Psoriasis	Atop Ecz	0.7982	0.2396	0.5309
Psoriasis	Vitiligo	0.2723	0.2516	0.3156
Psoriasis	Alop Are	0.9277	0.9005	0.8687
Psoriasis	BCC	0.9107	0.6727	0.8034
Psoriasis	Act Ker	0.8900	0.1228	0.2579
Atop Ecz	Vitiligo	0.3961	0.9912	0.7277
Atop Ecz	Alop Are	0.8577	0.1835	0.4151
Atop Ecz	BCC	0.8881	0.4607	0.7018
Atop Ecz	Act Ker	0.6616	0.0060**	0.0756
Vitiligo	Alop Are	0.2912	0.1931	0.2556
Vitiligo	BCC	0.3242	0.4744	0.4763
Vitiligo	Act Ker	0.1839	0.0076**	0.0322*
Alop Are	BCC	0.9727	0.5808	0.6997
Alop Are	Act Ker	0.7994	0.1443	0.3653
BCC	Act Ker	0.7673	0.0527	0.1929

Table 7.50 - Males - Variables: LPP11, RPP11, IPP11

(a) Canonical Discriminant Functions

FUNCTION	EIGENVALUE	PERCENT OF VARIANCE	CUMULATIVE PERCENT	CANONICAL CORRELATION
1*	0.00529	100.00	100.00	0.0725659

* MARKS THE 1 CANONICAL DISCRIMINANT FUNCTIONS REMAINING

(b) STANDARDIZED CANONICAL DISCRIMINANT FUNCTION COEFFICIENTS

	FUNC 1
LPP11	1.00000

(c) STRUCTURE MATRIX:

POOLED WITHIN-GROUPS CORRELATIONS BETWEEN DISCRIMINATING VARIABLES AND CANONICAL DISCRIMINANT FUNCTIONS (VARIABLES ORDERED BY SIZE OF CORRELATION WITHIN FUNCTION)

	FUNC 1
LPP11	1.00000
TPP11	0.64225
RPP11	0.16336

* Table 7.51 - Males - Variables: LPPII, RPPPII, TPPII

Code Group
 0 Controls
 1 Psoriasis
 2 Atopic Eczema
 3 BCC
 4 Alopecia areata
 5 Actinic Keratosis
 6 Vitiligo

F STATISTICS AND SIGNIFICANCES BETWEEN PAIRS OF GROUPS

GROUP	0	1	2	3	4	5
1	0.10127 0.7504					
2	0.94404 0.9226	0.17374 0.6769				
3	2.4790 0.1156	1.5776 0.2093	2.8189 0.0934			
4	3.1845 0.0746	2.1520 0.1426	3.5708 0.0590	0.46117 0.8300		
5	0.62107 0.4308	0.25802 0.6116	0.76798 0.3810	0.35285 0.5526	0.60933 0.4352	
6	1.8359 0.1757	1.0810 0.2987	2.1237 0.1453	0.41404 0.8388	0.17254 0.6779	0.16868 0.6814

Figure 7.15 - Males - Variables: LPPII, RPPII, TPPII

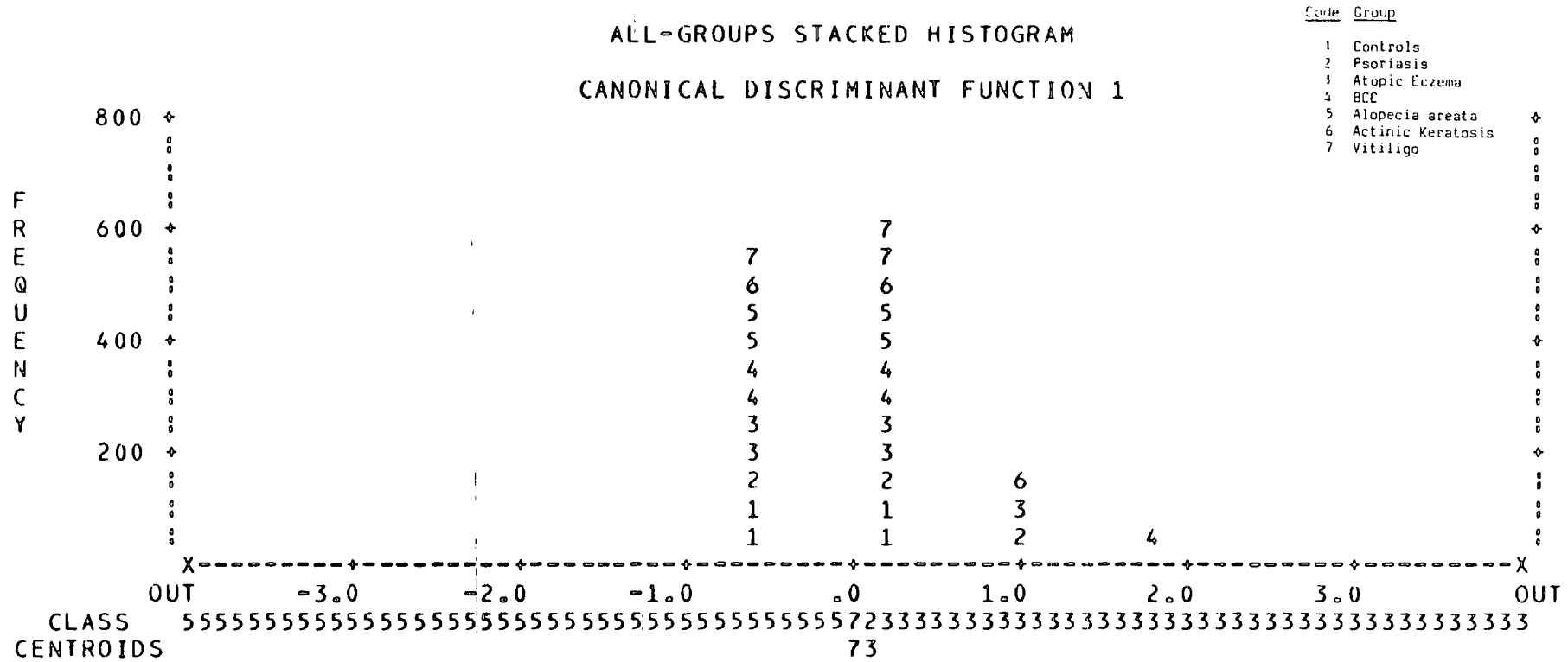

Table 7.52 - Males - Variables: LPPII, RPPII, TPPII

CLASSIFICATION RESULTS -

ACTUAL GROUP		NO. OF CASES	PREDICTED GROUP MEMBERSHIP						
			0	1	2	3	4	5	6
GROUP	0	200	0 0.0%	0 0.0%	112 56.0%	0 0.0%	88 44.0%	0 0.0%	0 0.0%
GROUP	1	202	0 0.0%	0 0.0%	123 60.9%	0 0.0%	79 39.1%	0 0.0%	0 0.0%
GROUP	2	203	0 0.0%	0 0.0%	133 65.5%	0 0.0%	70 34.5%	0 0.0%	0 0.0%
GROUP	3	211	0 0.0%	0 0.0%	116 55.0%	0 0.0%	95 45.0%	0 0.0%	0 0.0%
GROUP	4	210	0 0.0%	0 0.0%	107 51.0%	0 0.0%	103 49.0%	0 0.0%	0 0.0%
GROUP	5	129	0 0.0%	0 0.0%	80 62.0%	0 0.0%	49 38.0%	0 0.0%	0 0.0%
GROUP	6	201	0 0.0%	0 0.0%	108 53.7%	0 0.0%	93 46.3%	0 0.0%	0 0.0%

PERCENT OF "GROUPED" CASES CORRECTLY CLASSIFIED: 17.40%

Table 7.53 - Females - Variables: LPPII, RPPII, TPPII

(a) CANONICAL DISCRIMINANT FUNCTIONS

FUNCTION	EIGENVALUE	PERCENT OF VARIANCE	CUMULATIVE PERCENT	CANONICAL CORRELATION
1*	0.01131	92.69	92.69	0.1057421
2*	0.00089	7.31	100.00	0.0298428

* MARKS THE 2 CANONICAL DISCRIMINANT FUNCTIONS REMAINING

(b) STANDARDIZED CANONICAL DISCRIMINANT FUNCTION COEFFICIENTS

	FUNC 1	FUNC 2
LPPII	-0.70959	0.89331
RPPII	1.12457	0.19202

(c) STRUCTURE MATRIX:

POOLED WITHIN-GROUPS CORRELATIONS BETWEEN DISCRIMINATING VARIABLES
AND CANONICAL DISCRIMINANT FUNCTIONS
(VARIABLES ORDERED BY SIZE OF CORRELATION WITHIN FUNCTION)

	FUNC 1	FUNC 2
RPPII	0.78302*	0.62199
LPPII	-0.16832	0.98573*
TPPII	0.44278	0.89663*

Table 7.54 - Females - Variables: LPP11, RPP11, IPP11

Code Group
 0 Controls
 1 Psoriasis
 2 Atopic Dermatitis
 3 BCC
 4 Alopecia areata
 5 Actinic Keratosis
 6 Vitiligo

F STATISTICS AND SIGNIFICANCES BETWEEN PAIRS OF GROUPS

GROUP	GROUP 0	GROUP 1	GROUP 2	GROUP 3	GROUP 4	GROUP 5
1	1.2641 0.2828					
2	0.28490 0.7521	0.39822 0.6716				
3	0.19656 0.8216	0.46890 0.6258	0.46929 0.9542			
4	0.80426 0.4476	0.13457 0.8741	0.28514 0.7520	0.21498 0.8066		
5	6.4870 0.0016	2.5982 0.0748	4.7331 0.0089	4.5860 0.0103	2.9126 0.0547	
6	0.98845 0.3724	0.86768 0.9169	0.21120 0.8096	0.35974 0.6979	0.25917 0.7717	3.5432 0.0292

Figure 7.16 - Females - Variables: LPPII - TPPII

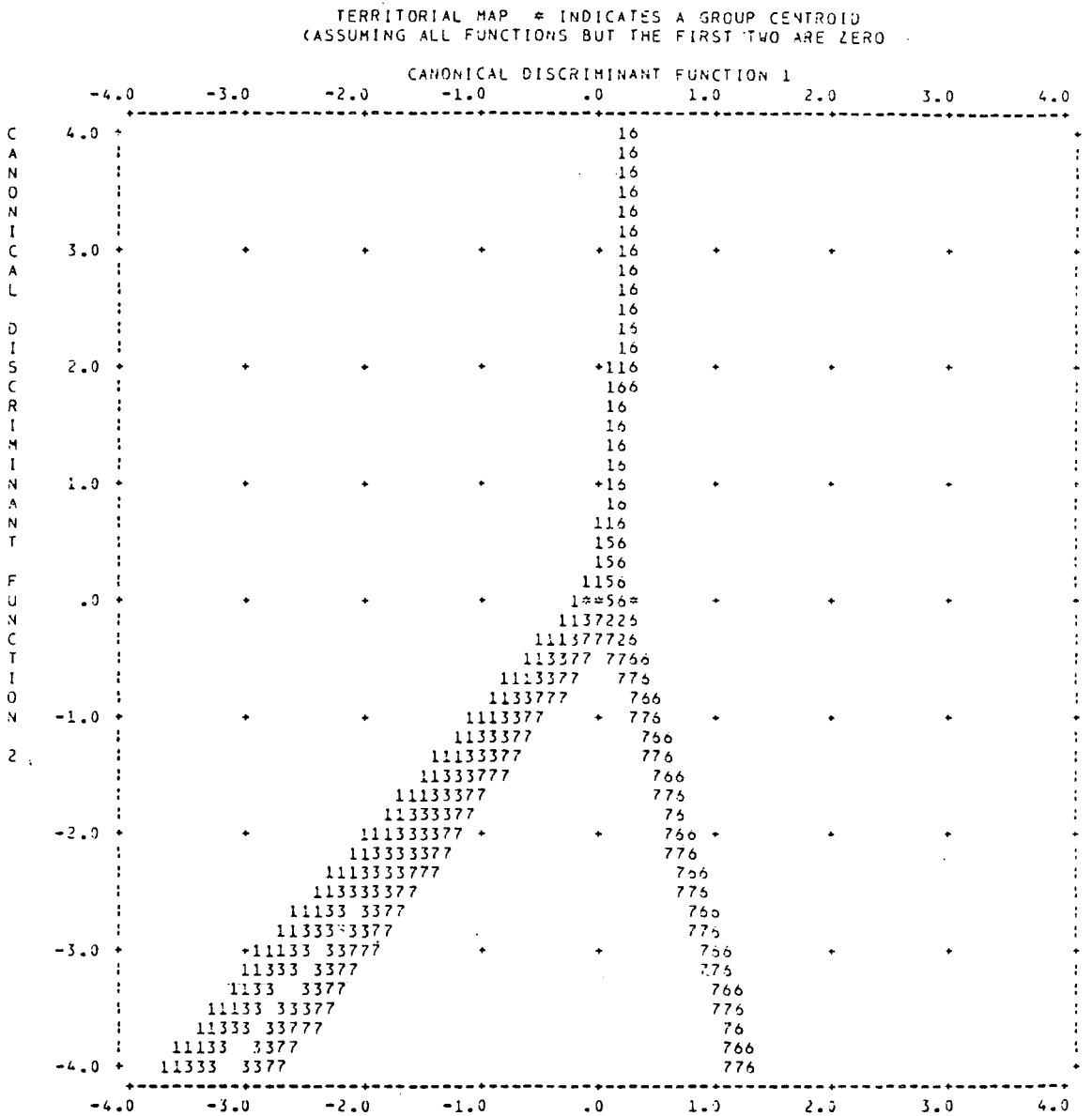

- | Form | Group |
|------|-------------------|
| 1 | Controls |
| 2 | Psoriasis |
| 3 | Atopic Eczema |
| 4 | BCC |
| 5 | Alopecia areata |
| 6 | Actinic Keratosis |
| 7 | Vitiligo |

Figure 7.17 - Females - Variables: LPPII - TPPII

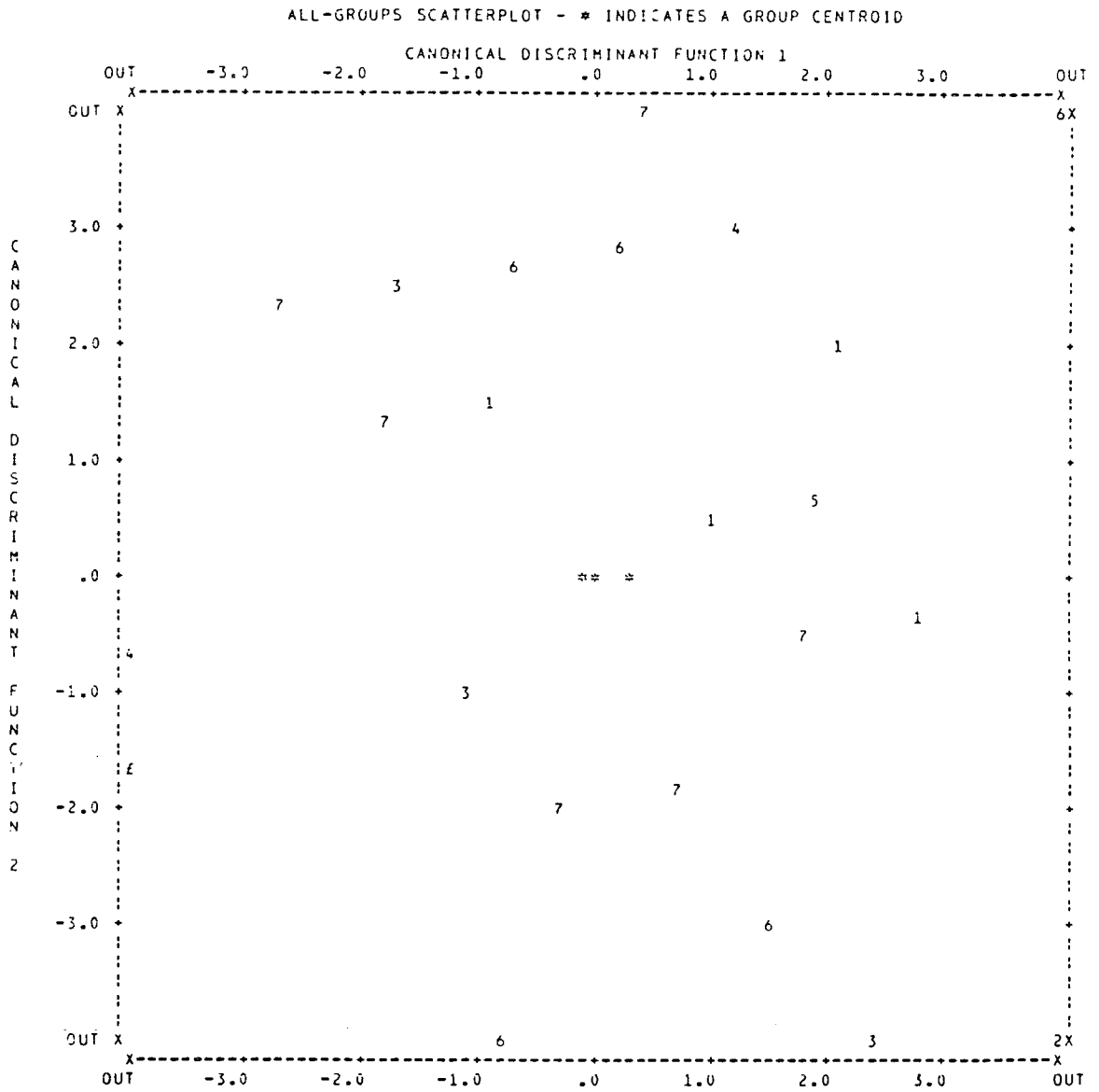

431.752	6
---------	---

- | Code | Group |
|------|-------------------|
| 1 | Controls |
| 2 | Psoriasis |
| 3 | Atopic Eczema |
| 4 | BCC |
| 5 | Alopecia areata |
| 6 | Actinic Keratosis |
| 7 | Vitiligo |

Figure 7.18 - Group Centroids

Table 7.55 - Females - Variables: LPPII, RPPII, TPPII

CLASSIFICATION RESULTS -

ACTUAL GROUP	NO. OF CASES	PREDICTED GROUP MEMBERSHIP							
		0	1	2	3	4	5	6	
GROUP 0	202	95 47.0%	0 0.0%	0 0.0%	0 0.0%	0 0.0%	34 16.8%	73 36.1%	
GROUP 1	204	106 52.0%	0 0.0%	0 0.0%	0 0.0%	0 0.0%	34 16.7%	64 31.4%	
GROUP 2	202	99 49.0%	0 0.0%	0 0.0%	0 0.0%	0 0.0%	30 14.9%	73 36.1%	
GROUP 3	202	98 48.5%	0 0.0%	0 0.0%	0 0.0%	0 0.0%	26 12.9%	78 38.6%	
GROUP 4	206	98 47.6%	0 0.0%	0 0.0%	0 0.0%	0 0.0%	35 17.0%	73 35.4%	
GROUP 5	172	90 52.3%	0 0.0%	0 0.0%	0 0.0%	0 0.0%	36 20.9%	46 26.7%	
GROUP 6	205	82 40.0%	0 0.0%	0 0.0%	0 0.0%	0 0.0%	44 21.5%	79 38.5%	

PERCENT OF "GROUPED" CASES CORRECTLY CLASSIFIED: 15.08%

(e) Maximal atd angles - Variables: LATD, RATD and SATD

For male subjects, psoriatics had the highest mean atd angles for the right hand and both hands combined followed in each case by atopic eczema probands. For mean atd angle on the left hand, the situation was reversed with atopics having the highest value followed by psoriatics (see Table 7.56(a)). When intergroup comparisons were carried out using the Mann-Whitney U Test, psoriasis males were found to have significantly higher mean atd angles in comparison to alopecia areata and actinic keratosis for all three variables LATD, RATD and SATD. Atopic eczema males were found to have a significantly higher angle on the left hand compared to alopecia areata and to actinic keratosis. Atopics were also found to have a significantly higher mean atd angle than actinic keratosis males for the summed angles of both hands, i.e. SATD (see Table 7.57(a)).

For female subjects vitiligo patients were found to have significantly lower atd angles compared to psoriasis, BCC, actinic keratosis and atopic eczema females for all three variables, and to controls for LATD and SATD. BCC female patients were found to have significantly higher atd angles in comparison to alopecia areata and vitiligo, for all three variables, and to controls, for RATD only (see Table 7.56(b) and 7.57(b)).

When discriminant analysis was carried out for male subjects two canonical discriminant functions were extracted with Function 1 accounting for 56.39% of the variance (see Table 7.58(a)). The atd angle on the right hand followed by the summed atd angle and then that on the left hand was the order of importance of correlation (see Tables 7.58(b) and (c)). The table of F Statistics shows that the widest separated pair of groups was atopic eczema and BCC (F = 3.0684) and this was the only pair that showed significance at the 5% level (see Table 7.59).

The territorial map (Figure 7.19) shows that BCC, atopic eczema and actinic keratosis are the most widely separated groups. Figures 7.20 and 7.21 show that vitiligo, atopic eczema and psoriasis occupy a single group centroid. This centroid is to the right of three adjacent centroids occupied by BCC, alopecia areata, controls and actinic keratosis.

Classification results show 15.06% correct classification of grouped cases. The best classified groups were found to be

actinic keratosis (59.7% correct), BCC (28.4%) and atopic eczema (26.2%) see Table 7.60.

Discriminant analysis for females using the atd angle variables shows that two canonical discriminant functions were extracted and Function 1 accounted for 60.53% of the variance (Table 7.61(a)). The most important variables were found to be LATD and SATD in that order (Tables 7.61(b) and (c)). The table of F Statistics (Table 7.62) shows that the most widely separated pairs of groups were controls and vitiligo ($F = 5.7394$), vitiligo and BCC ($F = 5.6972$) and vitiligo and psoriasis ($F = 5.3383$). The territorial map (Figure 7.22) shows the most separated groups to be controls, vitiligo, alopecia areata and atopic eczema. Figures 7.23 and 7.24 show that vitiligo is the group furthest to the left with psoriasis and BCC being most removed to the right and sharing the same centroid. In the opposite direction controls and atopic eczema are the groups furthest apart.

Classification results for females (Table 7.63) show 16.80% correct classification. The best classified groups were found to be vitiligo (52% correct) followed by controls (26.2%) and BCC (21.1%).

Factor analysis using the variables LATD to SATD show that by Principal Components Analysis only 1 factor was extracted and this factor accounted for 90.8% of the variance (Table 7.64(a)). The Factor Matrix and Communalities (Tables 7.64(b) and (c)) show that the order of importance of the three variables were SATD, RATD and LATD. Since only one function was produced no rotation of the factor matrix could be carried out neither was it possible to produce a variable plot.

Table 7.56

Means and Standard Deviation

Axial Triradii Angles

(a) Sex = Male

Group	Cases	Variables					
		LATD		RATD		SATD	
		Mean	Std. Dev.	Mean	Std. Dev.	Mean	Std. Dev.
Control	206	41.493 +/- 7.114		41.444 +/- 8.532		82.617 +/- 14.948	
Psoriasis	202	42.040 +/- 7.012		41.416 +/- 7.437		83.300 +/- 15.528	
Atop Ecz	203	42.054 +/- 7.126		41.163 +/- 7.252		83.139 +/- 13.571	
Vitiligo	201	41.557 +/- 7.014		40.746 +/- 6.954		82.220 +/- 13.264	
Alop Are	210	40.776 +/- 6.429		40.486 +/- 7.356		81.262 +/- 12.940	
BCC	211	41.469 +/- 7.952		41.810 +/- 8.852		83.280 +/- 15.480	
Act Ker	129	40.380 +/- 5.957		39.915 +/- 6.627		80.295 +/- 11.346	

(b) Sex = Female

Group	Cases	Variables					
		LATD		RATD		SATD	
		Mean	Std. Dev.	Mean	Std. Dev.	Mean	Std. Dev.
Control	203	42.103 +/- 7.884		40.512 +/- 6.132		82.616 +/- 12.751	
Psoriasis	205	42.707 +/- 7.966		42.259 +/- 7.617		84.897 +/- 14.130	
Atop Ecz	203	41.695 +/- 7.161		41.700 +/- 7.965		83.317 +/- 13.854	
Vitiligo	205	40.400 +/- 6.581		40.600 +/- 7.257		80.912 +/- 13.106	
Alop Are	206	41.141 +/- 6.217		40.699 +/- 6.178		81.756 +/- 11.753	
BCC	202	42.871 +/- 7.971		45.535 +/- 7.809		85.201 +/- 14.554	
Act Ker	174	42.178 +/- 7.393		41.713 +/- 7.381		83.803 +/- 13.704	

Table 7.57

Mann-Whitney U Test Results

Axial Triradii Angles

(a) Males

Group 1	Group 2	Probability		
		LATD	RATD	SATD
Control	Psoriasis	0.2605	0.1529	0.1712
Control	Atop Ecz	0.1742	0.5259	0.2190
Control	Vitiligo	0.8381	0.8716	0.8289
Control	Alop Are	0.2923	0.3868	0.4495
Control	BCC	0.8545	0.5955	0.4564
Control	Act Ker	0.2319	0.1906	0.3574
Psoriasis	Atop Ecz	0.8176	0.4003	0.8165
Psoriasis	Vitiligo	0.3879	0.1189	0.2255
Psoriasis	Alop Are	0.0312*	0.0187*	0.0267*
Psoriasis	BCC	0.2264	0.3991	0.5379
Psoriasis	Act Ker	0.0297*	0.0098**	0.0280*
Atop Ecz	Vitiligo	0.2807	0.4792	0.3381
Atop Ecz	Alop Are	0.0195*	0.1376	0.0534
Atop Ecz	BCC	0.1233	0.9514	0.6192
Atop Ecz	Act Ker	0.0166*	0.0630	0.0410*
Vitiligo	Alop Are	0.2086	0.3964	0.2992
Vitiligo	BCC	0.6992	0.4920	0.6021
Vitiligo	Act Ker	0.1793	0.2250	0.2619
Alop Are	BCC	0.5492	0.1584	0.1684
Alop Are	Act Ker	0.7885	0.6192	0.8321
BCC	Act Ker	0.3675	0.0787	0.1223

(b) Females

Group 1	Group 2	Probability		
		LATD	RATD	SATD
Control	Psoriasis	0.2679	0.0194*	0.0869
Control	Atop Ecz	0.8413	0.2072	0.7385
Control	Vitiligo	0.0181*	0.2533	0.0330*
Control	Alop Are	0.4188	0.7340	0.5179
Control	BCC	0.2275	0.0086**	0.0829
Control	Act Ker	0.6234	0.1558	0.4026
Psoriasis	Atop Ecz	0.1515	0.3542	0.1822
Psoriasis	Vitiligo	0.0002**	0.0012**	0.0001**
Psoriasis	Alop Are	0.0509	0.0465*	0.0179*
Psoriasis	BCC	0.9313	0.7365	0.9291
Psoriasis	Act Ker	0.5072	0.4196	0.3708
Atop Ecz	Vitiligo	0.0254*	0.0242*	0.0139*
Atop Ecz	Alop Are	0.5577	0.3225	0.3302
Atop Ecz	BCC	0.1108	0.2013	0.1577
Atop Ecz	Act Ker	0.4733	0.9043	0.6072
Vitiligo	Alop Are	0.0975	0.1621	0.1318
Vitiligo	BCC	0.0002**	0.0004**	0.0001**
Vitiligo	Act Ker	0.0034**	0.0173*	0.0035**
Alop Are	BCC	0.0388*	0.0200*	0.0177*
Alop Are	Act Ker	0.1955	0.2705	0.1424
BCC	Act Ker	0.4406	0.2780	0.3632

Table 7.58 - Males - Variables: LATD - SATD

(a) CANONICAL DISCRIMINANT FUNCTIONS

FUNCTION	EIGENVALUE	PERCENT OF VARIANCE	CUMULATIVE PERCENT	CANONICAL CORRELATION
1*	0.00642	56.59	56.59	0.0798990
2*	0.00493	43.41	100.00	0.0700269

* MARKS THE 2 CANONICAL DISCRIMINANT FUNCTIONS REMAINING

(b) STANDARDIZED CANONICAL DISCRIMINANT FUNCTION COEFFICIENTS

	FUNC 1	FUNC 2
RATD	-2.86607	1.00436
SATD	3.03695	-0.00462

(c) STRUCTURE MATRIX:

POOLED WITHIN-GROUPS CORRELATIONS BETWEEN DISCRIMINATING VARIABLES
AND CANONICAL DISCRIMINANT FUNCTIONS
(VARIABLES ORDERED BY SIZE OF CORRELATION WITHIN FUNCTION)

	FUNC 1	FUNC 2
RATD	0.00152	1.00000*
SATD	0.33071	0.94373*
LATD	0.64833	0.76136*

Table 7.59 - Males - Variables: LATD - SATD

Code Group
 0 Controls
 1 Psoriasis
 2 Atopic Eczema
 3 BCC
 4 Alopecia areata
 5 Actinic Keratosis
 6 Vitiligo

F STATISTICS AND SIGNIFICANCES BETWEEN PAIRS OF GROUPS

GROUP	GROUP	0	1	2	3	4	5
1		0.85594 0.4251					
2		1.4639 0.2317	0.13405 0.8746				
3		0.59166 0.5535	1.9192 0.1471	3.0684 0.0468			
4		0.33108 0.7182	1.5265 0.2177	1.9478 0.1430	1.7207 0.1793		
5		0.94098 0.3905	2.0361 0.1309	2.1960 0.1116	2.5727 0.0767	0.22341 0.7998	
6		0.64370 0.5255	0.31006 0.7335	0.33730 0.7138	2.2859 0.1021	0.67457 0.5095	0.94301 0.3897

Figure 7.19 - Males - Variables: LATD - SATD

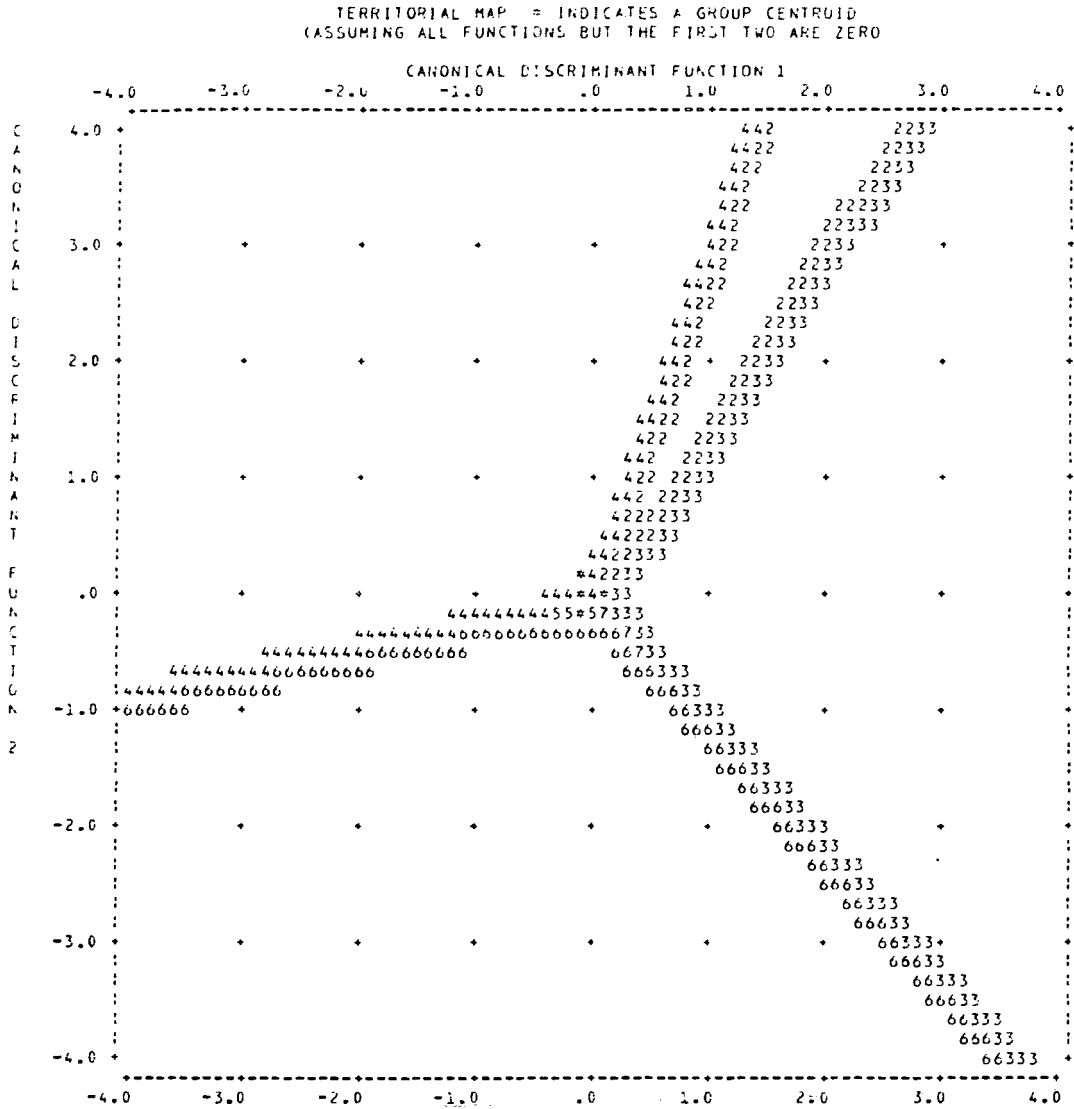

Code Group

- 1 - Controls
- 2 - Psoriasis
- 3 - Alopecia Areata
- 4 - HCC
- 5 - Alopecia areata
- 6 - Actinic Keratosis
- 7 - Vitiligo

Figure 7.20 - Males - Variables: LATD - SATD

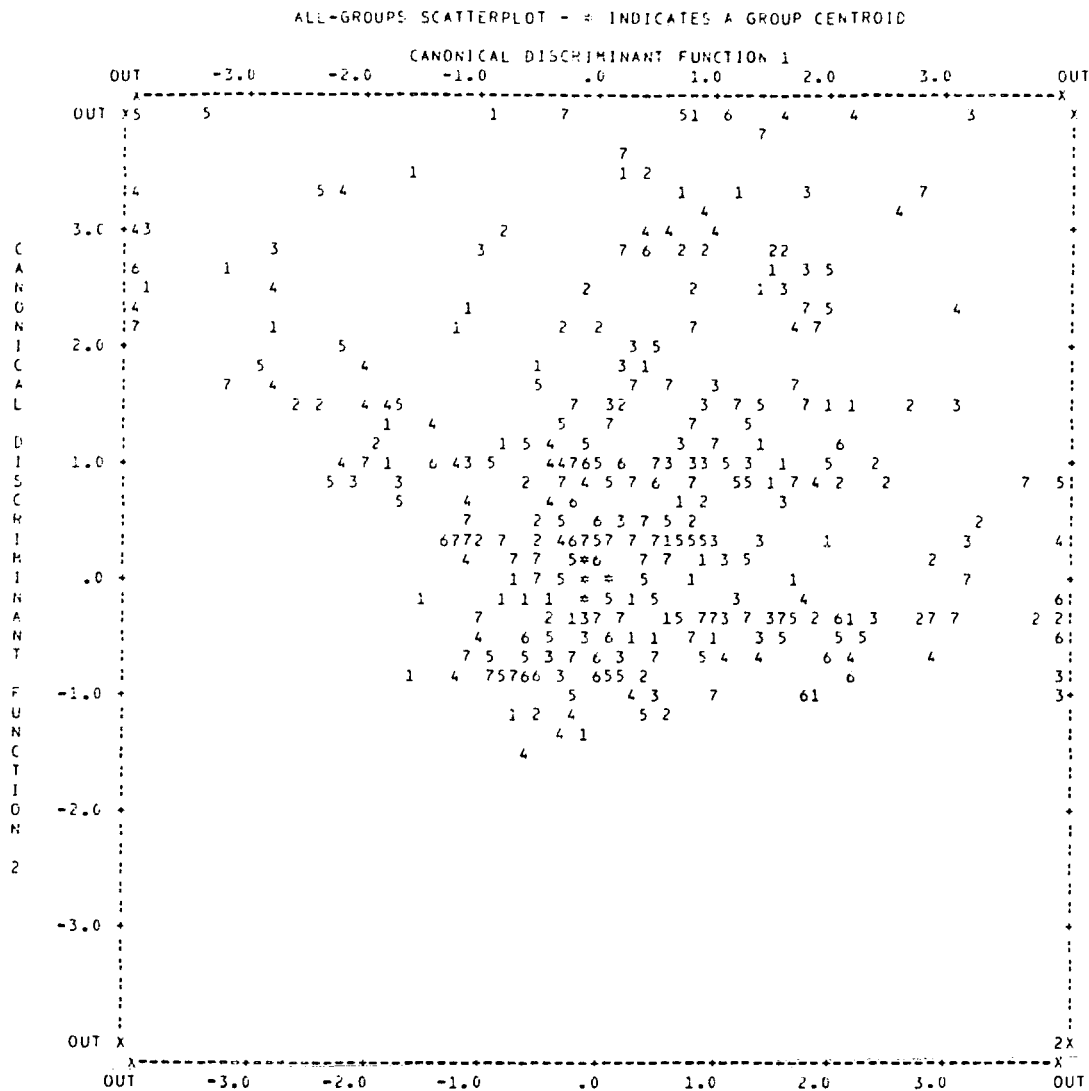

	4	
	5+1	732
	6	

- Code Group
- 1 - Controls
 - 2 - Psoriasis
 - 3 - Atopic Eczema
 - 4 - BCC
 - 5 - Alopecia areata
 - 6 - Actinic Keratosis
 - 7 - Vitiligo

Figure 7.21 - Group Centroids

Table 7.60 - Males - Variables: LATD - SATD

CLASSIFICATION RESULTS -

ACTUAL GROUP		NO. OF CASES	PREDICTED GROUP MEMBERSHIP						
			0	1	2	3	4	5	6
GROUP	0	196	0 0.0%	5 2.6%	44 22.4%	33 16.8%	0 0.0%	113 57.7%	1 0.5%
GROUP	1	200	0 0.0%	9 4.5%	46 23.0%	45 22.5%	0 0.0%	98 49.0%	2 1.0%
GROUP	2	202	0 0.0%	12 5.9%	53 26.2%	36 17.8%	0 0.0%	96 47.5%	5 2.5%
GROUP	3	211	0 0.0%	5 2.4%	37 17.5%	60 28.4%	0 0.0%	102 48.3%	7 3.3%
GROUP	4	210	0 0.0%	1 0.5%	53 25.2%	34 16.2%	0 0.0%	117 55.7%	5 2.4%
GROUP	5	129	0 0.0%	2 1.6%	17 13.2%	30 23.3%	0 0.0%	77 59.7%	3 2.3%
GROUP	6	200	0 0.0%	8 4.0%	46 23.0%	32 16.0%	0 0.0%	110 55.0%	4 2.0%

PERCENT OF "GROUPED" CASES CORRECTLY CLASSIFIED: 15.06%

Table 7.61 - Females - Variables: LATD - SATD

(a) CANONICAL DISCRIMINANT FUNCTIONS

FUNCTION	EIGENVALUE	PERCENT OF VARIANCE	CUMULATIVE PERCENT	CANONICAL CORRELATION
1*	0.01267	60.53	60.53	0.1118548
2*	0.00826	39.47	100.00	0.0905252

* MARKS THE 2 CANONICAL DISCRIMINANT FUNCTIONS REMAINING

(b) STANDARDIZED CANONICAL DISCRIMINANT FUNCTION COEFFICIENTS

	FUNC 1	FUNC 2
LATD	0.99550	-2.45812
SATD	0.00485	2.65205

(c) STRUCTURE MATRIX:

POOLED WITHIN-GROUPS CORRELATIONS BETWEEN DISCRIMINATING VARIABLES
AND CANONICAL DISCRIMINANT FUNCTIONS
(VARIABLES ORDERED BY SIZE OF CORRELATION WITHIN FUNCTION)

	FUNC 1	FUNC 2
LATD	1.00000*	-0.00183
SATD	0.92687*	0.37537
RATD	0.71115*	0.70304

Figure 7.22 - Females - Variables: LATD - SATD

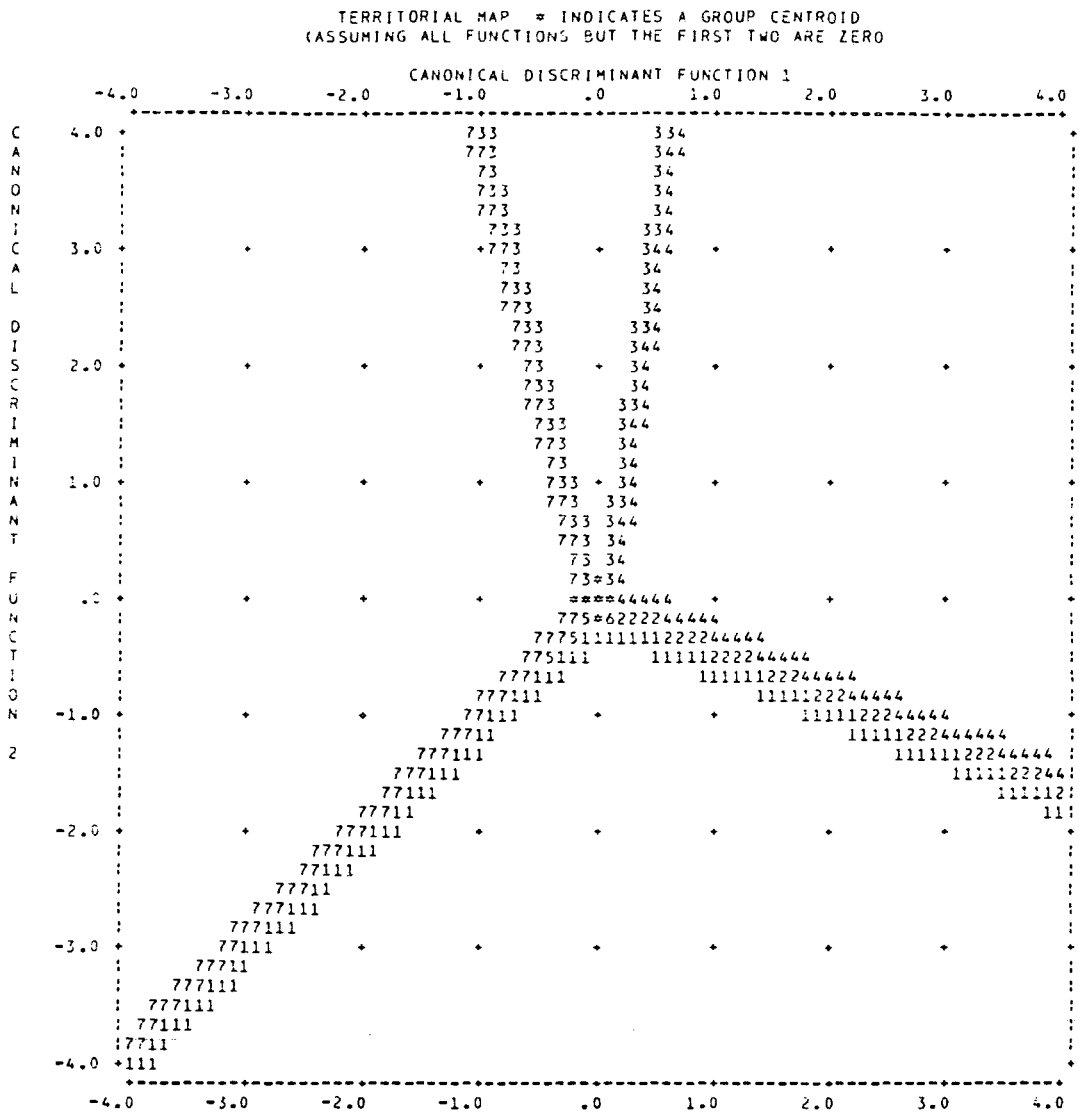

Code	Group
1	Controls
2	Psoriasis
3	Atopic Eczema
4	BCC
5	Alopecia areata
6	Actinic Keratosis
7	Vitiligo

Figure 7.23 - Females - Variables: LATD - SATD

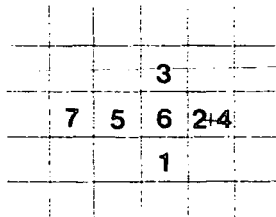
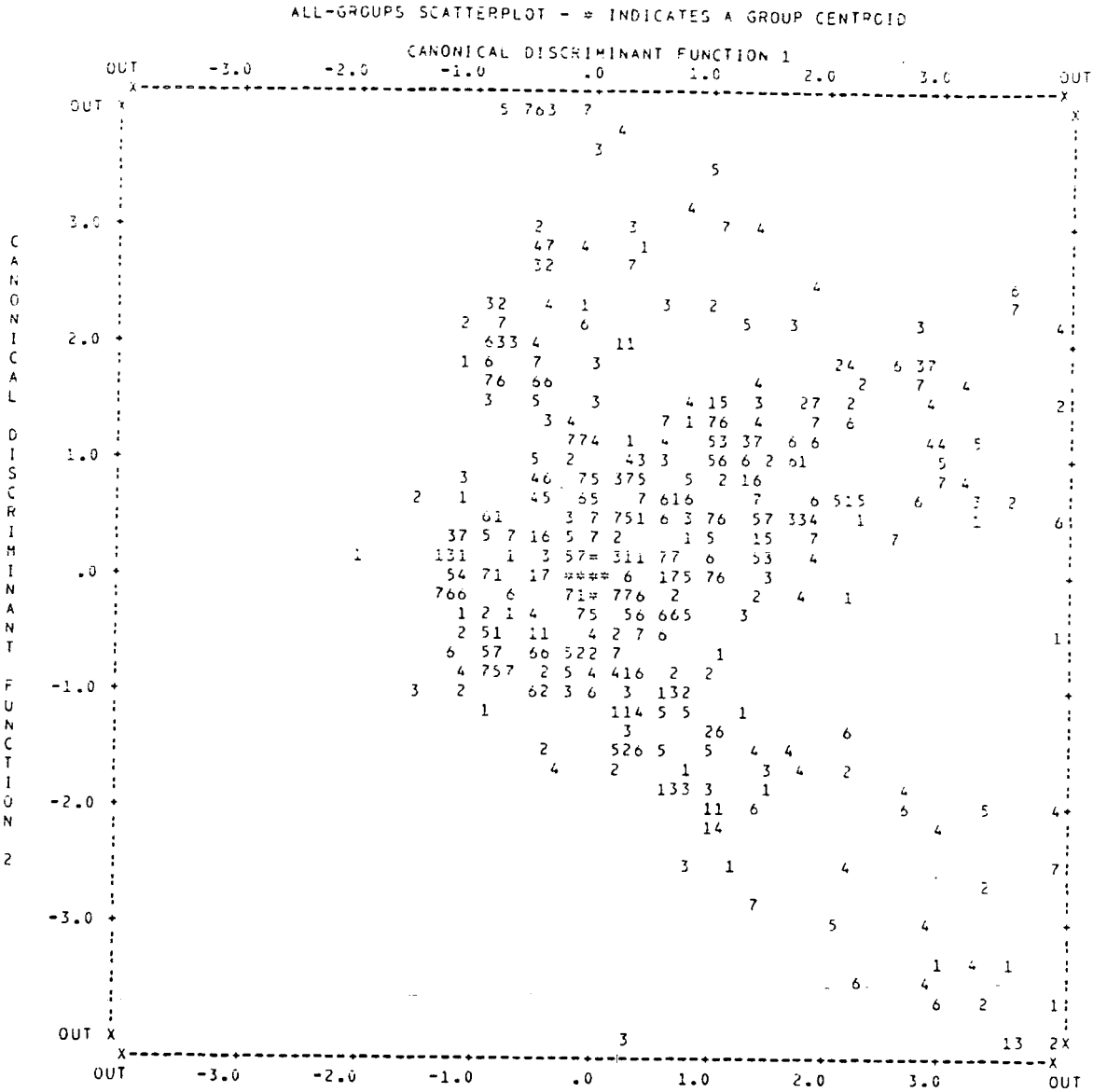

Code	Group
1	Controls
2	Psoriasis
3	Atopic Eczema
4	BCC
5	Alopecia areata
6	Actinic Keratosis
7	Vitiligo

Figure 7.24 - Group Centroids

Table 7.62 - Females - Variables: LATD - SATD

Code Group
 0 Controls
 1 Psoriasis
 2 Atopic Eczema
 3 BCC
 4 Alopecia areata
 5 Actinic keratosis
 6 Vitiligo

F STATISTICS AND SIGNIFICANCES BETWEEN PAIRS OF GROUPS

GROUP	0	1	2	3	4	5
1	3.2499 0.0391					
2	4.2942 0.0138	1.2319 0.2921				
3	4.0901 0.0169	0.53546 0.9479	1.2965 0.2738			
4	2.2907 0.1016	2.8155 0.0602	1.0348 0.3556	3.3225 0.0364		
5	2.2032 0.1108	0.41762 0.6587	0.35153 0.7037	0.61506 0.5408	0.92611 0.3963	
6	5.7394 0.0033	5.3383 0.0049	1.6638 0.1898	5.6972 0.0034	0.81493 0.4429	2.4985 0.0826

Table 7.63 - Females - Variables: LATD - SATD

CLASSIFICATION RESULTS -

ACTUAL GROUP		NO. OF CASES	PREDICTED GROUP MEMBERSHIP						
			0	1	2	3	4	5	6
GROUP	0	202	53 26.2%	7 3.5%	7 3.5%	39 19.3%	5 2.5%	0 0.0%	91 45.0%
GROUP	1	204	49 24.0%	7 3.4%	11 5.4%	53 26.0%	3 1.5%	0 0.0%	81 39.7%
GROUP	2	202	51 25.2%	1 0.5%	16 7.9%	43 21.3%	6 3.0%	0 0.0%	85 42.1%
GROUP	3	199	51 25.6%	4 2.0%	19 9.5%	42 21.1%	8 4.0%	0 0.0%	75 37.7%
GROUP	4	205	47 22.9%	3 1.5%	11 5.4%	42 20.5%	9 4.4%	0 0.0%	93 45.4%
GROUP	5	171	48 28.1%	8 4.7%	12 7.0%	33 19.3%	4 2.3%	0 0.0%	66 38.6%
GROUP	6	204	42 20.6%	5 2.5%	12 5.9%	37 18.1%	2 1.0%	0 0.0%	106 52.0%

PERCENT OF "GROUPED" CASES CORRECTLY CLASSIFIED: 16.80%

Table 7.64 - Factor Analysis Results - Variables: LATD - SATD

(a) PRINCIPAL COMPONENTS ANALYSIS (PC)

FACTOR	EIGENVALUE	PCT OF VAR	CUM PCT
1	2.72280	90.8	90.8
2	.27720	9.2	100.0
3	.00000	.0	100.0

PC EXTRACTED 1 FACTOR

(b) FACTOR MATRIX:

	FACTOR 1
SATD	.99999
RATD	.92910
LATD	.92713

(c) FINAL STATISTICS:

VARIABLE	COMMUNALITY
RATD	.86323
LATD	.85958
SATD	.99999

7.3 Palmar Ridge Counts

(a) Individual Ridge Counts - Variables: LAB to RCD

No significant differences were found for intergroup comparison of male subjects for a-b ridge count on either hand. For b-c ridge count male control subjects were found to have a significantly lower count on both hands in comparison to psoriasis, atopic eczema (H.Sig) and vitiligo. Atopic eczema males were found to have a statistically significantly higher b-c ridge count in comparison to vitiligo, BCC and actinic keratosis, on the right hand only, and in comparison to alopecia areata on both hands (see Tables 7.65(a) and 7.66(a)). For c-d ridge counts actinic keratosis males were found to have a significantly lower mean value in comparison to BCC and atopic eczema, on the right hand, and compared to vitiligo on the left. Atopic eczema patients were found to have a significantly higher mean value for c-d ridge count on the right hand in comparison to controls.

For female subjects, controls had the highest mean a-b ridge count on both hands and this was found to be significantly higher in comparison to actinic keratosis and BCC on both hands, and to vitiligo and alopecia areata on the left hand only (Tables 7.65(b) and 7.66(b)). BCC females were found to have a significantly smaller a-b count in comparison to alopecia areata, vitiligo, atopic eczema and psoriasis on the left hand only, and compared to controls on both hands. Control females were found to have a significantly lower b-c ridge count on both hands in comparison to atopic eczema, alopecia areata, BCC and actinic keratosis, and on the left hand only compared to vitiligo. No significant differences were found for c-d count on the left hand. For the right hand, however, BCC females were found to have a significantly lower c-d count in comparison to vitiligo and psoriasis. Vitiligo were found to have a higher ridge c-d count in comparison to controls and alopecia areata.

Discriminant analysis for males shows that five canonical discriminant functions were produced (Table 7.67) with Function 1 accounting for 54.68% of the variance. From Table 7.69 it can be seen that b-c ridge counts on both hands (i.e. RBC and LBC) make up Function 1. The table of F Statistics (Table 7.70) shows that the groups with the widest separation were found to be controls and

atopic eczema ($F = 6.8578$) followed by atopic eczema and actinic keratosis ($F = 4.0894$). The territorial map (Figure 7.25) shows that the most separated groups were controls, atopic eczema and actinic keratosis. The same pattern is shown in Figures 7.26 and 7.27 with controls and atopic eczema being furthest removed in the horizontal direction and actinic keratosis being removed vertically. The other four groups are clustered together centrally with pairs occupying adjacent centroids.

Classification results show 18.81% correct classification (Table 7.71) with atopic eczema (38.1%), actinic keratosis (29.5%) and controls (26.6%) having the greatest number of correctly grouped cases.

When discriminant analysis was carried out for females using the variables LAB to RCD five canonical discriminant functions were produced (see Table 7.72). Function 1 accounted for 62.26% of the total variance. Variable LAB was responsible for Function 1 and RCD for Function 2. Function 3 was composed the b-c counts for both hands (see Table 7.74). The table of F Statistics shows the most widely separated groups were BCC and controls ($F = 11.639$) followed by all of the other groups in turn in comparison to controls (see Table 7.75). The territorial map (Figure 7.28) shows controls, vitiligo and BCC to be the most widely separated. Figures 7.29 and 7.30 show that controls are removed from the other groups with actinic keratosis and BCC being furthest away and the other groups closely gathered in the centre.

Classification results (Table 7.76) show grouped cases to be 20.44% correctly classified. The groups with the best classification results were found to be controls (41.9% correct) followed by BCC (33.5%) and actinic keratosis (24.7%).

When the groups were regrouped according to aetiology of disorder type highly significant statistical differences were found for b-c ridge counts on both hands when GD males were compared to controls. A significant difference was also found for the comparison between male controls and ND males (see Table 7.78). For females, highly significant differences for b-c counts on both hands were found for female controls in comparison to both GD and ND. Highly significant differences were also found for a-b ridge counts on both hands when ND females were compared to controls. On the right hand significant

differences were found for all three ridge counts when GD and ND females were compared and for a-b palmar ridge count on the left hand (H.Sig.). From Table 7.77 it can be seen that male controls have a lower mean b-c count than GD and ND males. For females controls were found to have higher a-b counts and lower b-c and c-d counts in comparison to GD and ND on both hands. GD females had higher a-b and c-d palmar ridge counts and lower b-c ridge counts on both hands in comparison to ND females.

Table Means and Standard Deviations :

7.65(a)
Palmar Ridge Counts

(a) Sex = Male

Group	Cases	Variables					
		LAB		LBC		LCD	
		Mean	Std. Dev.	Mean	Std. Dev.	Mean	Std. Dev.
Control	206	41.112	+/- 5.133	27.137	+/- 5.592	35.716	+/- 5.963
Psoriasis	202	41.337	+/- 5.322	28.391	+/- 5.061	35.366	+/- 4.682
Atop Ecz	203	41.044	+/- 4.842	29.149	+/- 4.777	35.851	+/- 5.676
Vitiligo	201	41.015	+/- 5.052	28.294	+/- 5.443	35.929	+/- 5.579
Alop Are	210	40.695	+/- 4.998	27.808	+/- 5.225	35.418	+/- 6.181
BCC	211	40.346	+/- 6.029	28.105	+/- 5.217	35.243	+/- 5.371
Act Ker	129	41.240	+/- 5.137	28.380	+/- 5.393	34.109	+/- 6.336

Group	Cases	Variables					
		RAB		RBC		RCD	
		Mean	Std. Dev.	Mean	Std. Dev.	Mean	Std. Dev.
Control	206	40.337	+/- 5.360	27.132	+/- 5.752	34.624	+/- 6.216
Psoriasis	202	40.302	+/- 5.996	28.604	+/- 4.727	35.158	+/- 4.910
Atop Ecz	203	40.054	+/- 4.527	29.773	+/- 4.912	35.941	+/- 5.438
Vitiligo	201	40.483	+/- 4.930	28.226	+/- 5.388	35.141	+/- 5.137
Alop Are	210	39.410	+/- 5.201	27.986	+/- 5.387	35.120	+/- 5.123
BCC	211	40.047	+/- 5.881	28.000	+/- 5.366	35.133	+/- 5.184
Act Ker	129	39.884	+/- 5.209	28.271	+/- 5.461	33.729	+/- 5.959

Table 7.65(b)

(b) Sex = Female

Group	Cases	Variables					
		LAB		LBC		LCD	
		Mean	Std. Dev.	Mean	Std. Dev.	Mean	Std. Dev.
Control	203	41.926 +/- 5.603		26.271 +/- 6.661		34.663 +/- 7.331	
Psoriasis	202	41.244 +/- 5.022		27.409 +/- 5.078		34.581 +/- 6.597	
Atop Ecz	203	41.133 +/- 5.425		28.498 +/- 5.430		35.179 +/- 6.333	
Vitiligo	205	40.615 +/- 5.195		27.690 +/- 5.444		35.355 +/- 5.431	
Alop Are	206	40.816 +/- 4.893		28.692 +/- 4.805		34.915 +/- 5.212	
BCC	202	39.094 +/- 4.841		28.095 +/- 5.473		34.184 +/- 5.807	
Act Ker	174	39.943 +/- 4.552		28.727 +/- 6.390		35.302 +/- 5.260	

Group	Cases	Variables					
		RAB		RBC		RCD	
		Mean	Std. Dev.	Mean	Std. Dev.	Mean	Std. Dev.
Control	203	40.793 +/- 5.873		26.465 +/- 6.055		33.585 +/- 6.315	
Psoriasis	205	40.190 +/- 5.189		27.415 +/- 4.888		35.100 +/- 5.924	
Atop Ecz	203	40.089 +/- 5.831		27.940 +/- 5.234		34.622 +/- 6.075	
Vitiligo	205	39.605 +/- 5.073		27.581 +/- 5.248		35.419 +/- 5.474	
Alop Are	206	39.966 +/- 4.859		28.387 +/- 5.213		34.436 +/- 5.027	
BCC	202	39.322 +/- 5.171		28.199 +/- 5.546		33.622 +/- 5.879	
Act Ker	174	39.161 +/- 4.447		28.489 +/- 5.205		34.040 +/- 5.884	

Table Mann-Whitney U Test Results :
7.66(a)
Palmar Ridge Counts

Males

Group 1	Group 2	Probability					
		LAB	LBC	LCD	RAB	RBC	RCD
Control	Psoriasis	0.6475	0.0178*	0.4998	0.9896	0.0032**	0.8506
Control	Atop Ecz	0.9956	0.0003**	0.6100	0.3226	0.0000**	0.0314*
Control	Vitiligo	0.9970	0.0161*	0.3300	0.9574	0.0238*	0.6014
Control	Alop Are	0.5172	0.2441	0.7630	0.0581	0.1137	0.6968
Control	BCC	0.1410	0.0779	0.6030	0.5327	0.1233	0.5031
Control	Act Ker	0.4238	0.0182	0.1913	0.3635	0.0703	0.1098
Psoriasis	Atop Ecz	0.6376	0.2162	0.2069	0.4276	0.0624	0.0544
Psoriasis	Vitiligo	0.6520	0.8410	0.0991	0.9058	0.6661	0.7447
Psoriasis	Alop Are	0.2471	0.2078	0.3597	0.0768	0.2271	0.8355
Psoriasis	BCC	0.0608	0.5295	0.9692	0.5819	0.1926	0.6036
Psoriasis	Act Ker	0.7438	0.6592	0.3743	0.4213	0.6217	0.0878
Atop Ecz	Vitiligo	0.9983	0.3425	0.6924	0.2990	0.0222*	0.1008
Atop Ecz	Alop Are	0.5098	0.0119*	0.8111	0.2540	0.0025**	0.0764
Atop Ecz	BCC	0.1455	0.0598	0.2555	0.8847	0.0017**	0.1222
Atop Ecz	Act Ker	0.4417	0.5378	0.0651	0.8048	0.0334*	0.0010**
Vitiligo	Alop Are	0.5098	0.1657	0.4880	0.0403*	0.5019	0.9192
Vitiligo	BCC	0.1412	0.4274	0.1216	0.4509	0.4657	0.8473
Vitiligo	Act Ker	0.4214	0.8184	0.0415*	0.3159	0.8597	0.0521
Alop Are	BCC	0.4282	0.5281	0.3838	0.2304	0.9537	0.7510
Alop Are	Act Ker	0.2032	0.1380	0.1304	0.4765	0.6602	0.0587
BCC	Act Ker	0.0643	0.3501	0.3895	0.7734	0.6702	0.0310*

Table Mann-Whitney U Test Results :
7.66(b)
Palmar Ridge Counts

Females

Group 1	Group 2	Probability					
		LAB	LBC	LCD	RAB	RBC	RCD
Control	Psoriasis	0.1143	0.0646	0.7041	0.3046	0.2305	0.0635
Control	Atop Ecz	0.1606	0.0007**	0.6043	0.4169	0.0341*	0.1950
Control	Vitiligo	0.0072**	0.0270*	0.3574	0.0599	0.1234	0.0089**
Control	Alop Are	0.0319*	0.0003**	0.9209	0.2402	0.0057**	0.3140
Control	BCC	0.0000**	0.0056**	0.4145	0.0193*	0.0099**	0.5381
Control	Act Ker	0.0001**	0.0000**	0.3238	0.0140*	0.0007**	0.4338
Psoriasis	Atop Ecz	0.9182	0.0551	0.3596	0.8346	0.3670	0.4770
Psoriasis	Vitiligo	0.2113	0.6336	0.1578	0.3816	0.7044	0.5833
Psoriasis	Alop Are	0.5654	0.0377*	0.6578	0.9025	0.0924	0.3262
Psoriasis	BCC	0.0001**	0.2603	0.7151	0.1596	0.1288	0.0268*
Psoriasis	Act Ker	0.0217*	0.0054**	0.1534	0.1483	0.0125*	0.2813
Atop Ecz	Vitiligo	0.2138	0.1573	0.6699	0.2712	0.5670	0.2268
Atop Ecz	Alop Are	0.5248	0.8341	0.5761	0.7064	0.4866	0.7704
Atop Ecz	BCC	0.0002**	0.4055	0.2115	0.1031	0.5976	0.1236
Atop Ecz	Act Ker	0.0217*	0.5725	0.6708	0.0915	0.1803	0.6286
Vitiligo	Alop Are	0.4915	0.1268	0.2746	0.4243	0.2231	0.0976
Vitiligo	BCC	0.0104*	0.5222	0.0903	0.5954	0.2769	0.0039**
Vitiligo	Act Ker	0.3087	0.0305*	0.9629	0.5464	0.0477*	0.0915
Alop Are	BCC	0.0009**	0.3713	0.4961	0.2034	0.9032	0.1465
Alop Are	Act Ker	0.0826	0.5306	0.2374	0.1637	0.4812	0.9223
BCC	Act Ker	0.1302	0.1268	0.0877	0.9810	0.4508	0.2121

Table 7.67 - Males - Variables: LAB - RCD

CANONICAL DISCRIMINANT FUNCTIONS

FUNCTION	EIGENVALUE	PERCENT OF VARIANCE	CUMULATIVE PERCENT	CANONICAL CORRELATION
1*	0.02691	54.68	54.68	0.1618715
2*	0.01270	25.81	80.49	0.1120011
3*	0.00494	10.03	90.53	0.0700957
4*	0.00424	8.61	99.13	0.0649475
5*	0.00043	0.87	100.00	0.0206285

* MARKS THE 5 CANONICAL DISCRIMINANT FUNCTIONS REMAINING

Table 7.68 - Males - Variables: LAB - RCD

STANDARDIZED CANONICAL DISCRIMINANT FUNCTION COEFFICIENTS

	FUNC 1	FUNC 2	FUNC 3	FUNC 4	FUNC 5
LAB	-0.05456	-1.06425	-0.28521	0.97413	0.44186
LCD	-0.43275	0.58655	0.13642	0.78041	-0.81833
RAB	-0.29378	0.78270	1.04580	-0.68817	0.25952
RBC	0.85104	-0.16821	0.42495	-0.02608	-0.38414
RCD	0.69090	0.29461	-0.59891	-0.18700	0.91344

Table 7.69 - Males - Variables: LAB - RCD

STRUCTURE MATRIX:

POOLED WITHIN-GROUPS CORRELATIONS BETWEEN DISCRIMINATING VARIABLES
AND CANONICAL DISCRIMINANT FUNCTIONS
(VARIABLES ORDERED BY SIZE OF CORRELATION WITHIN FUNCTION)

	FUNC 1	FUNC 2	FUNC 3	FUNC 4	FUNC 5
RBC	0.81700*	-0.09105	0.48247	0.19311	-0.23272
LBC	0.57585*	-0.06813	0.35173	0.21841	-0.04300
RCD	0.45506	0.58967*	-0.19023	0.38102	0.51366
RAB	-0.08824	0.22466	0.77215*	0.21917	0.54543
LCD	0.08500	0.64059	0.06132	0.75692*	-0.07574
LAB	-0.02121	-0.24373	0.47275	0.65331*	0.53837

Table 7.70 - Males - Variables: LAB - RCD

Code Group
 0 Control
 1 Psoriasis
 2 Atopic Eczema
 3 BCC
 5 Alopecia areata
 6 Actinic Keratosis
 7 Vitiligo

F² STATISTICS AND SIGNIFICANCES BETWEEN PAIRS OF GROUPS

GROUP	GROUP	0	1	2	3	5	6
1		2.2668 0.0458					
2		6.8578 0.0000	1.6620 0.1408				
3		2.2010 0.0519	1.2124 0.3009	3.0195 0.0102			
5		2.1867 0.0534	0.74336 0.5910	2.5829 0.0247	1.3107 0.2568		
6		2.6779 0.0204	1.3070 0.2583	4.0894 0.0011	2.7955 0.0161	1.9594 0.0820	
7		1.2235 0.2956	0.77663 0.5665	2.7609 0.0173	0.71263 0.6140	1.4907 0.1898	2.5841 0.0246

Figure 7.25 - Males - Variables: LAB - RCD

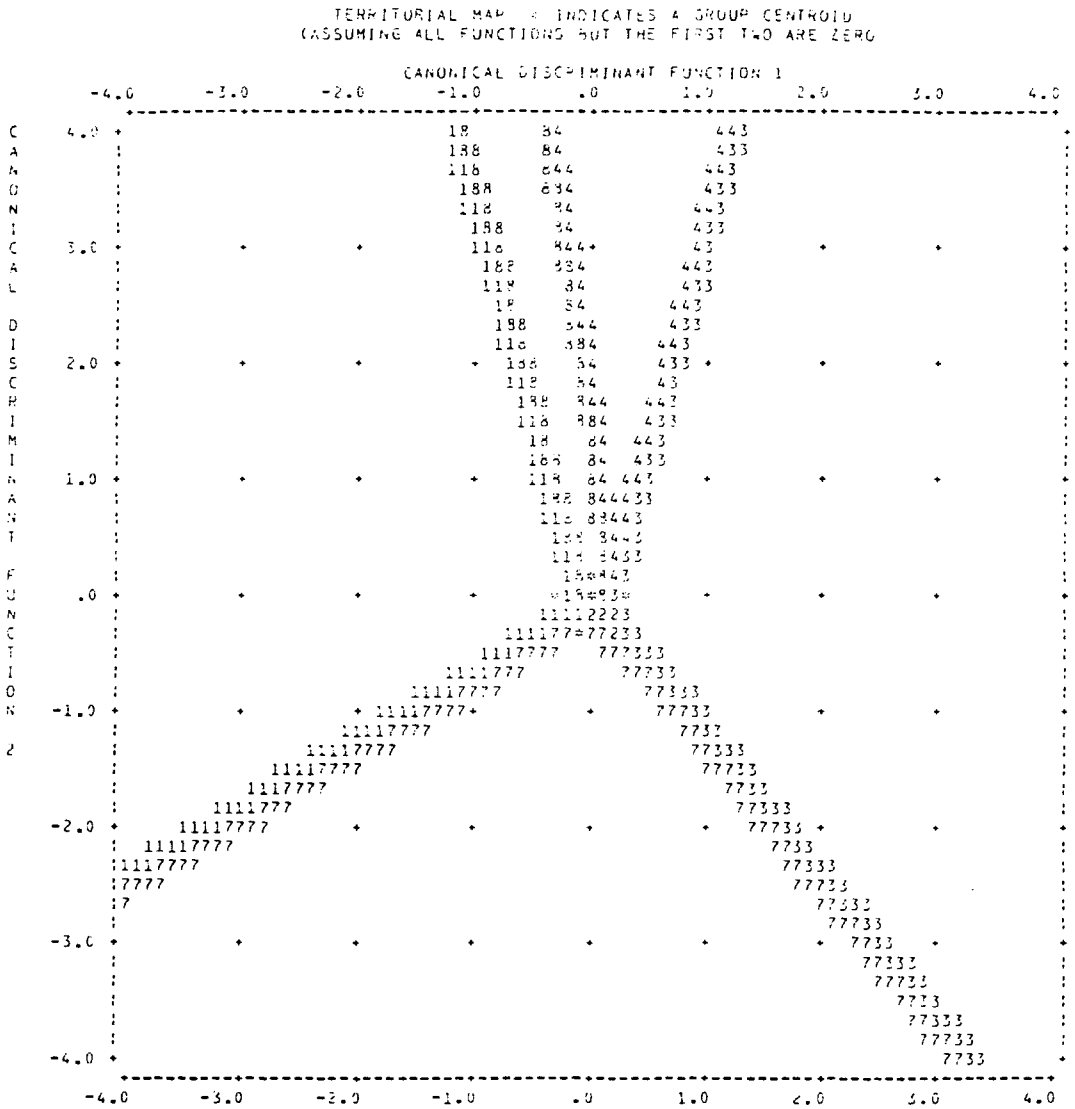

Code Group

- 1 - Controls
- 2 - Psoriasis
- 3 - Atopic Eczema
- 4 - BCU
- 6 - Alopecia areata
- 7 - Actinic Keratosis
- 9 - Vitiligo

Figure 7.26 - Males - Variables: LAB - RCD

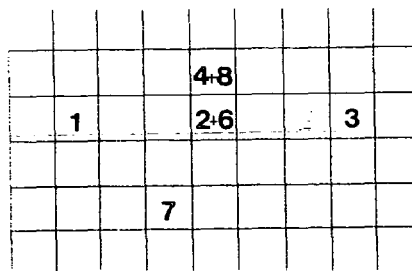
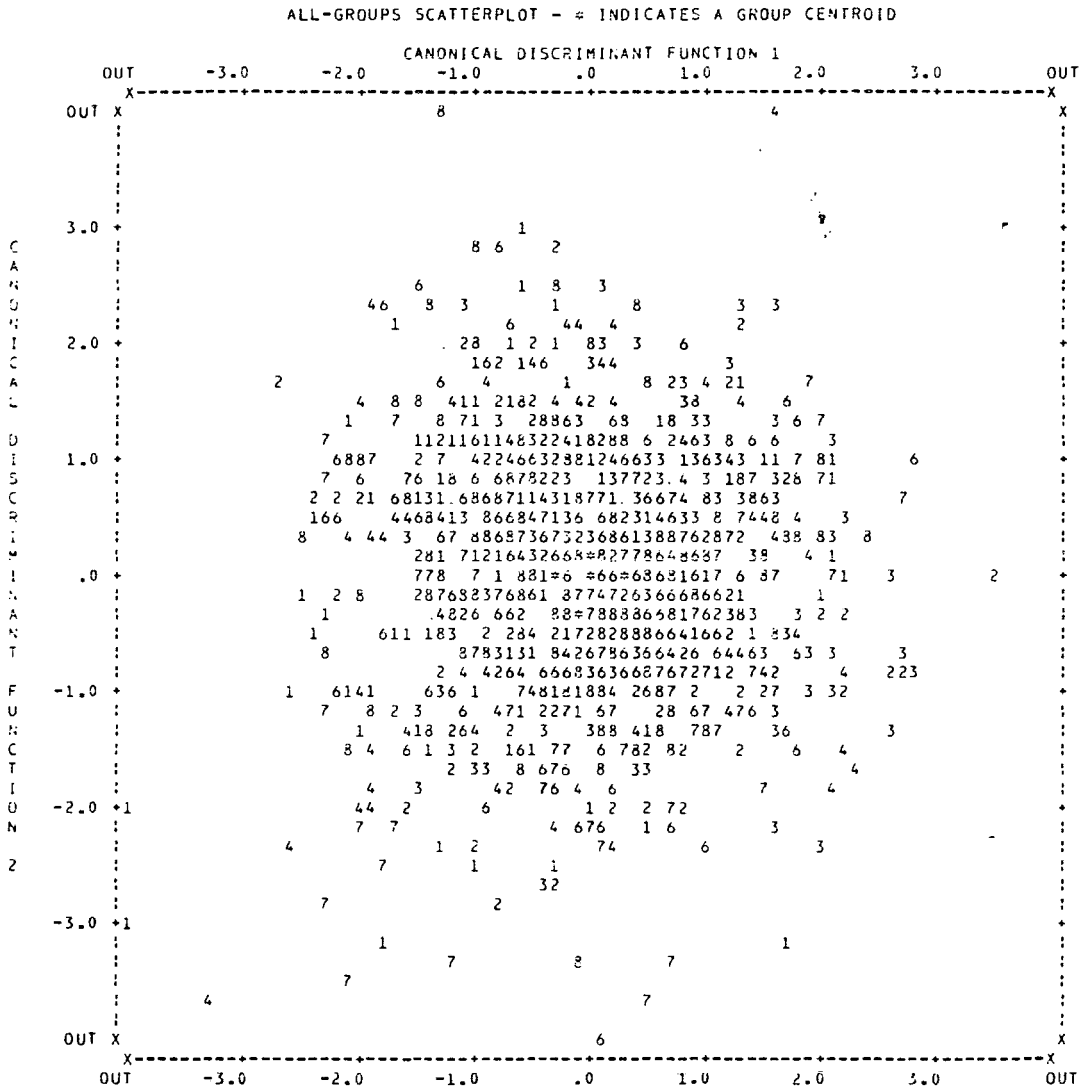

- Code Group
- 1 - Controls
 - 2 - Psoriasis
 - 3 - Atopic Eczema
 - 4 - BCC
 - 6 - Alopecia areata
 - 7 - Actinic Keratosis
 - 8 - Vitiligo

Figure 7.27 - Group Centroids

Table 7.71 - Males - Variables: LAB - RCD

CLASSIFICATION RESULTS -

ACTUAL GROUP		NO. OF CASES	PREDICTED GROUP MEMBERSHIP						
			0	1	2	3	5	6	7
GROUP	0	199	53 26.6%	4 2.0%	42 21.1%	25 12.6%	21 10.6%	40 20.1%	14 7.0%
GROUP	1	202	34 16.8%	5 2.5%	57 28.2%	25 12.4%	23 11.4%	45 22.3%	13 6.4%
GROUP	2	202	34 16.8%	6 3.0%	77 38.1%	20 9.9%	21 10.4%	33 16.3%	11 5.4%
GROUP	3	209	40 19.1%	2 1.0%	56 26.8%	34 16.3%	23 11.0%	39 18.7%	15 7.2%
GROUP	5	207	44 21.3%	3 1.4%	59 28.5%	32 15.5%	27 13.0%	35 16.9%	7 3.4%
GROUP	6	129	31 24.0%	3 2.3%	33 25.6%	7 5.4%	11 8.5%	38 29.5%	6 4.7%
GROUP	7	197	46 23.4%	2 1.0%	48 24.4%	25 12.7%	19 9.6%	38 19.3%	19 9.6%

PERCENT OF "GROUPED" CASES CORRECTLY CLASSIFIED: 18.81%

Table 7.72 - Females - Variables: LAB - RCD

CANONICAL DISCRIMINANT FUNCTIONS

FUNCTION	EIGENVALUE	PERCENT OF VARIANCE	CUMULATIVE PERCENT	CANONICAL CORRELATION
1*	0.05585	62.26	62.26	0.2299935
2*	0.01936	21.58	83.84	0.1378175
3*	0.01005	11.20	95.04	0.0997410
4*	0.00417	4.65	99.70	0.0644660
5*	0.00027	0.30	100.00	0.0165338

* MARKS THE 5 CANONICAL DISCRIMINANT FUNCTIONS REMAINING

Table 7.73 - Females - Variables: LAB - RCD

STANDARDIZED CANONICAL DISCRIMINANT FUNCTION COEFFICIENTS

	FUNC 1	FUNC 2	FUNC 3	FUNC 4	FUNC 5
LAB	0.91083	0.38358	0.87249	0.03620	-0.60549
LBC	-0.65857	0.06952	0.61690	0.52571	0.01734
LCD	-0.18458	-0.44147	0.40205	-1.04485	0.54727
RAB	-0.00642	-0.52145	-0.59453	0.54431	1.03201
RCD	-0.05299	1.15027	-0.52807	0.23752	0.03852

Table 7.74 - Females - Variables: LAB - RCD

STRUCTURE MATRIX:

POOLED WITHIN-GROUPS CORRELATIONS BETWEEN DISCRIMINATING VARIABLES
AND CANONICAL DISCRIMINANT FUNCTIONS
(VARIABLES ORDERED BY SIZE OF CORRELATION WITHIN FUNCTION)

	FUNC 1	FUNC 2	FUNC 3	FUNC 4	FUNC 5
LAB	0.69339*	0.23871	0.55462	0.17461	0.35234
RCD	-0.01345	0.86565*	-0.02460	-0.11848	0.48563
LBC	-0.55369	0.18360	0.65643*	0.40563	0.25354
RBC	-0.34833	0.13839	0.46053*	0.27163	0.26812
RAB	0.43348	-0.04158	0.10415	0.39995	0.79972*
LCD	-0.03179	0.27576	0.39816	-0.56552	0.66679*

Table 7.75 - Females - Variables: LAB -- RCD

		Code Group					
		0	1	2	3	5	6
F STATISTICS AND SIGNIFICANCES BETWEEN PAIRS OF GROUPS		0 Controls 1 Psoriasis 2 Alopecia Areata 3 BCC 5 Alopecia areata 6 Actinic Keratosis 7 Vitiligo					
GROUP	GROUP	0	1	2	3	5	6
1		4.1241 0.0010					
2		5.6700 0.0000	1.6510 0.1435				
3		11.639 0.0000	6.2106 0.0000	3.6781 0.0026			
5		6.9481 0.0000	1.8973 0.0919	0.14982 0.9801	3.1293 0.0082		
6		9.9140 0.0000	5.0156 0.0001	1.4575 0.2009	1.8635 0.0978	1.3365 0.2461	
7		7.6441 0.0000	1.2109 0.3016	1.6454 0.1450	4.8028 0.0002	1.9015 0.0912	3.1048 0.0086

Figure 7.28 - Females - Variables: LAB - RCD

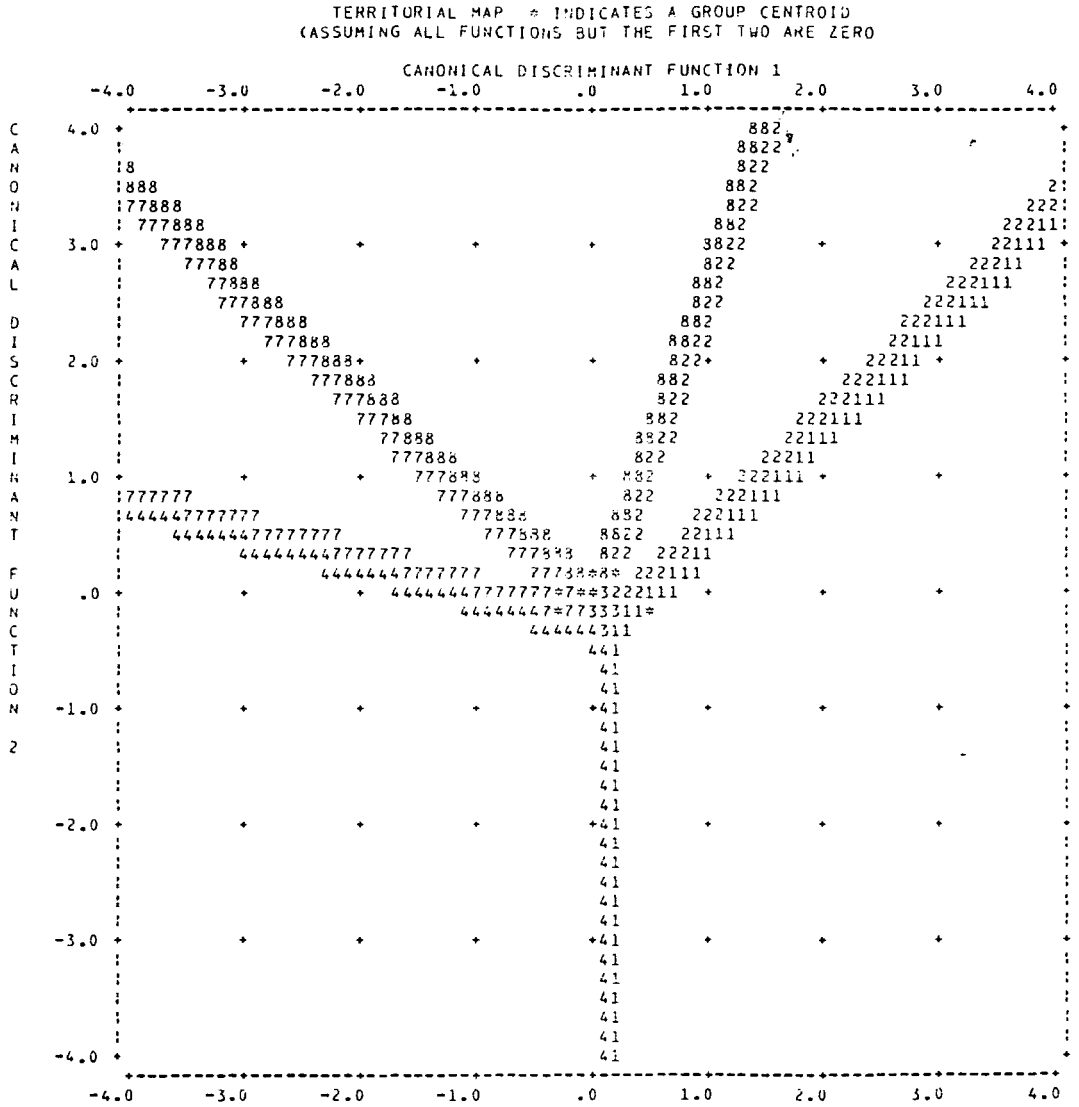

Code	Group
1	- Controls
2	- Psoriasis
3	- Atopic Eczema
4	- HCC
6	- Alopecia areata
7	- Actinic Keratosis
8	- Vitiligo

Figure 7.29 - Females - Variables: LAB - RCD

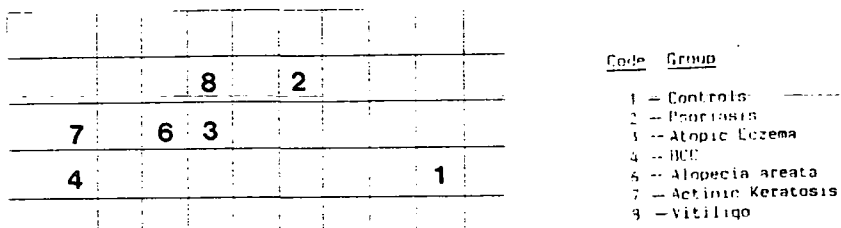
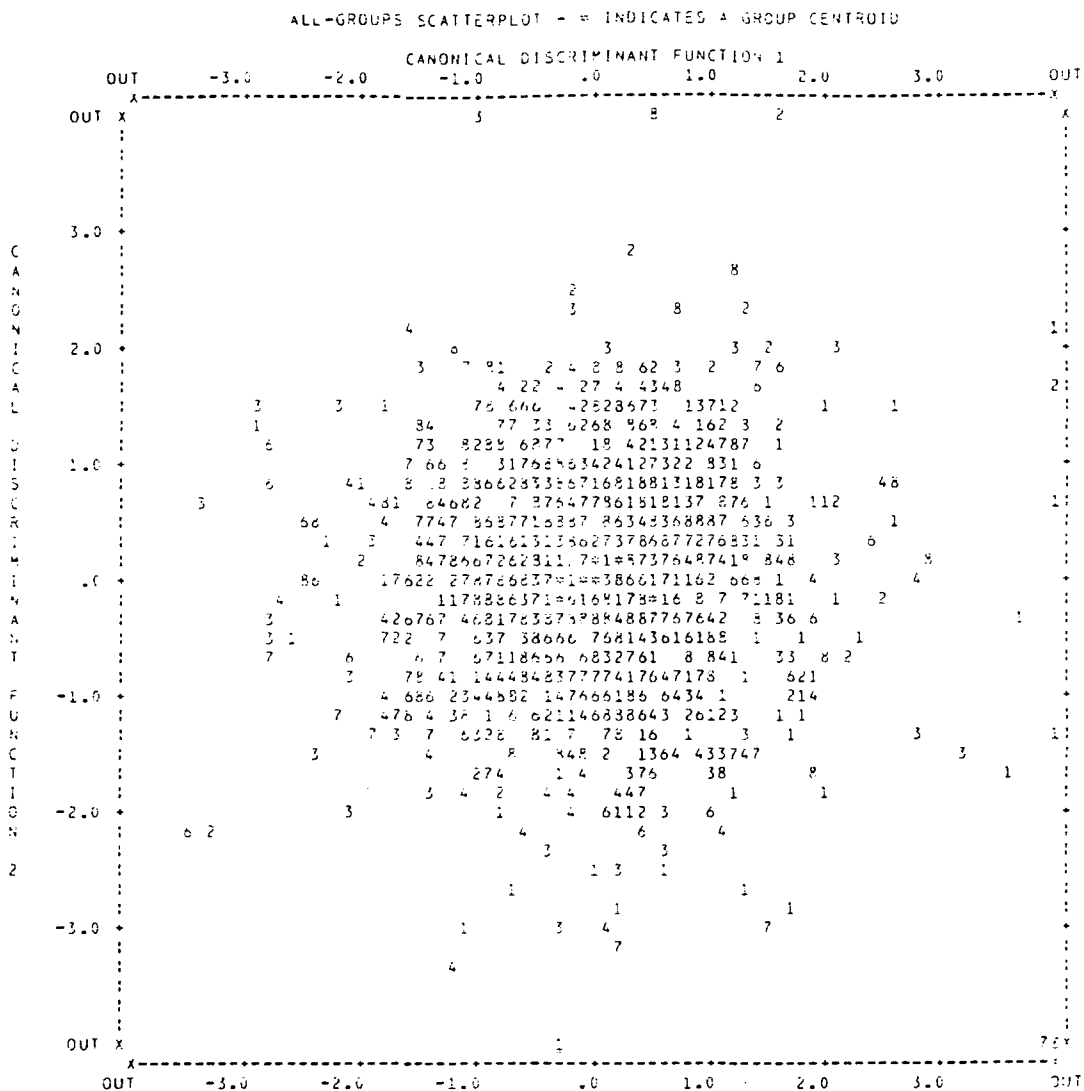

Figure 7.30 - Group Centroids

Table 7.76 - Females - Variables: LAB - RCD

CLASSIFICATION RESULTS -

ACTUAL GROUP		NO. OF CASES	PREDICTED GROUP MEMBERSHIP						
			0	1	2	3	5	6	7
GROUP	0	198	83 41.9%	25 12.6%	12 6.1%	29 14.6%	12 6.1%	17 8.6%	20 10.1%
GROUP	1	197	55 27.9%	23 11.7%	5 2.5%	41 20.8%	15 7.6%	23 11.7%	35 17.8%
GROUP	2	200	55 27.5%	20 10.0%	8 4.0%	37 18.5%	18 9.0%	27 13.5%	35 17.5%
GROUP	3	200	45 22.5%	12 6.0%	5 2.5%	67 33.5%	15 7.5%	27 13.5%	29 14.5%
GROUP	5	201	51 25.4%	17 8.5%	9 4.5%	40 19.9%	18 9.0%	34 16.9%	32 15.9%
GROUP	6	170	36 21.2%	13 7.6%	8 4.7%	38 22.4%	16 9.4%	42 24.7%	17 10.0%
GROUP	7	199	44 22.1%	25 12.6%	5 2.5%	39 19.6%	13 6.5%	35 17.6%	38 19.1%

PERCENT OF "GROUPED" CASES CORRECTLY CLASSIFIED: 20.44%

Table 7.77 - Means and Standard Deviations: Variables: LAB to RCD - Grouped by Disorder Type

		LAB		LBC		LCD		RAB		RBC		RCD	
Gp.	Sex	Mean	± SD	Mean	± SD	Mean	± SD	Mean	± SD	Mean	± SD	Mean	± SD
Cont	M	41.112	5.133	27.137	5.592	35.716	5.963	40.337	5.360	27.132	5.752	34.624	6.216
GD	M	41.020	5.052	28.407	5.144	35.638	5.556	40.055	5.198	28.645	5.149	35.340	5.157
ND	M	40.685	5.716	28.209	5.278	34.811	5.774	39.985	5.628	28.103	5.396	34.599	5.525
Cont	F	41.928	5.603	26.271	6.661	34.663	7.331	40.793	5.873	26.465	6.055	33.585	6.315
GD	F	40.946	5.133	28.075	5.214	35.009	5.916	39.962	5.244	27.833	5.153	34.894	5.640
ND	F	39.479	4.732	28.429	5.414	34.712	5.594	39.219	4.835	28.365	5.382	33.863	5.791

Table 7.78 - Mann-Whitney U Test Probabilities - Variables: LAB - RCD

			PROBABILITY					
Sex	Gp1	Gp2	LAB	LBC	LCD	RAB	RBC	RCD
M	Cont	GD	0.8614	0.0060**	0.8109	0.3311	0.0009**	0.3015
M	Cont	ND	0.4738	0.0330*	0.2877	0.3583	0.0958	0.7649
M	GD	ND	0.4297	0.7162	0.0618	0.8432	0.1055	0.1127
F	Cont	GD	0.0146*	0.0004**	0.7378	0.1173	0.0182*	0.0281*
F	Cont	ND	0.0000**	0.0000**	0.9228	0.0043**	0.0005**	0.8918
F	GD	ND	0.0000**	0.1957	0.8319	0.0356*	0.0456*	0.0198*

(b) Summed Palmar Ridge Counts - Variables: TAB, TBC and TCD

From Tables 7.79 and 7.80 it can be seen that for summed b-c counts in male subjects, controls had a highly significantly larger mean count in comparison to psoriasis, atopic eczema, vitiligo and actinic keratosis (Sig.). Also for TBC, atopic eczema males had a highly significantly greater value when compared to BCC and alopecia areata. Atopic eczema males had a significantly higher summed c-d palmar ridge count in comparison to actinic keratosis. For female subjects, controls were found to have a highly significantly greater value for summed a-b ridge counts in comparison to BCC, actinic keratosis and vitiligo (Sig.). Female controls were also found to have a highly significantly lower summed b-c count in comparison to atopic eczema, alopecia areata, BCC, actinic keratosis and vitiligo (Sig.). Psoriasis females were found to have a significantly higher a-b summed count in comparison to BCC and actinic keratosis and a significantly lower summed b-c ridge count in comparison to alopecia areata and actinic keratosis. Atopic eczema females had a significantly higher summed a-b ridge count compared to BCC and actinic keratosis. Vitiligo females were found to have a significantly higher TCD count in comparison to controls and BCC and a significantly lower TBC count in comparison to actinic keratosis. Alopecia areata females were also found to have a significantly higher summed a-b palmar ridge count in comparison to BCC.

When Discriminant Analysis was carried out for males using variables TAB to TCD three discriminant functions were produced with TBC, followed by TCD and TAB, being the most important (see Table 7.81). Function 1 (TBC) accounted for 59.72% of the variance (Table 7.81(a)). The Table of F-Statistics shows the most widely separated groups to be atopic eczema and controls ($F = 8.3165$) followed by actinic keratosis and atopic eczema ($F = 5.4956$) as shown in Table 7.82.

The territorial map (Figure 7.31) shows atopic eczema, controls and actinic keratosis to be the most widely separated using the first two functions. The scatterplot and group centroids show the same separation between groups with the other four clustered on a single group centroid (Figure 7.33). Classification results show 17.55% correct classification of grouped cases (Table 7.83) with the best result being for atopic eczema (43.6%), actinic keratosis (34.9%)

and controls (31.7%).

Table 7.84 shows the results of Discriminant Analysis for females. Again 3 canonical discriminant functions were produced. Function 1 accounts for 78.66% of the variance with the most important variable being TCD. The Table of F Statistics (Table 7.85) shows the most widely separated groups to be controls and actinic keratosis ($F = 16.199$), controls and BCC ($F = 15.698$), controls and alopecia areata ($F = 10.535$) and controls and vitiligo ($F = 10.513$).

The territorial map (Figure 7.34) shows the most widely separated groups to be controls, BCC actinic keratosis and vitiligo. The group centroids and scatterplot (Figures 7.35 and 7.36) show controls to be widely separated from the other groups with actinic keratosis and BCC to be the furthest removed. The other four groups are clustered in the centre. Table 7.86 shows classification results to be 19.49% correct. Controls with 44.9% were found to be the group with most correctly classified cases followed by actinic keratosis (24.1%) and BCC (24%).

When groups were reclassified according to aetiology of disorder, a significantly lower summed b-c count was found for controls compared to GD and ND in both males and females. In addition control females were found to have a significantly higher summed a-b count compared to GD and ND. GD females had a significantly higher summed a-b count compared to ND (see Tables 7.87 and 7.88).

Table 7.79

Means and Standard Deviations : Summed Palmar Ridge Counts

(a) Sex = Male

Group	Cases	Variables					
		TAB		TBC		TCD	
		Mean	Std. Dev.	Mean	Std. Dev.	Mean	Std. Dev.
Control	206	81.449 +/-	9.571	54.275 +/-	10.453	70.353 +/-	10.926
Psoriasis	202	81.639 +/-	10.765	56.995 +/-	9.056	70.525 +/-	8.449
Atop Ecz	203	81.099 +/-	8.777	58.941 +/-	8.892	71.782 +/-	10.187
Vitiligo	201	81.498 +/-	9.339	56.640 +/-	9.892	71.147 +/-	9.689
Alop Are	210	80.105 +/-	9.575	55.831 +/-	9.795	70.570 +/-	10.312
BCC	211	80.393 +/-	11.013	56.134 +/-	9.503	70.378 +/-	9.549
Act Ker	129	81.124 +/-	9.796	56.651 +/-	10.325	67.837 +/-	11.709

(b) Sex = Female

Group	Cases	Variables					
		TAB		TBC		TCD	
		Mean	Std. Dev.	Mean	Std. Dev.	Mean	Std. Dev.
Control	203	82.719 +/-	10.671	52.789 +/-	11.595	68.231 +/-	11.959
Psoriasis	205	81.434 +/-	9.294	54.904 +/-	8.975	69.685 +/-	11.613
Atop Ecz	203	81.202 +/-	10.202	56.450 +/-	9.931	69.870 +/-	11.122
Vitiligo	205	80.220 +/-	9.774	55.357 +/-	9.569	71.000 +/-	9.569
Alop Are	2026	80.782 +/-	9.045	57.104 +/-	9.216	69.448 +/-	9.098
BCC	202	78.416 +/-	9.083	56.380 +/-	10.238	67.820 +/-	10.581
Act Ker	174	79.103 +/-	8.268	57.198 +/-	9.939	69.331 +/-	10.172

Table 7.80 - Mann-Whitney U Test Results - Summed Palmar Ridge Counts

(a) Males

Group 1	Group 2	Probability		
		TAB	TBC	TCD
Control	Psoriasis	0.7620	0.0062**	0.7816
Control	Atop Ecz	0.7072	0.0000**	0.1587
Control	Vitiligo	0.8572	0.0087**	0.3681
Control	Alop Are	0.2238	0.2051	0.7339
Control	BCC	0.3132	0.0713	0.9740
Control	Act Ker	0.8990	0.0408*	0.1816
Psoriasis	Atop Ecz	0.5342	0.1195	0.0835
Psoriasis	Vitiligo	0.9478	0.9910	0.2223
Psoriasis	Alop Are	0.1530	0.1571	0.4868
Psoriasis	BCC	0.2399	0.3241	0.7584
Psoriasis	Act Ker	0.8380	0.9361	0.2514
Atop Ecz	Vitiligo	0.5825	0.1308	0.5824
Atop Ecz	Alop Are	0.3520	0.0021**	0.2860
Atop Ecz	BCC	0.5041	0.0092**	0.1573
Atop Ecz	Act Ker	0.7036	0.1640	0.0111*
Vitiligo	Alop Are	0.1460	0.1835	0.6235
Vitiligo	BCC	0.2338	0.3408	0.3901
Vitiligo	Act Ker	0.9646	0.9981	0.0391
Alop Are	BCC	0.8268	0.6253	0.7116
Alop Are	Act Ker	0.2734	0.3385	0.1006
BCC	Act Ker	0.3835	0.5039	0.1591

(b) Females

Group 1	Group 2	Probability		
		TAB	TBC	TCD
Control	Psoriasis	0.1564	0.0977	0.4182
Control	Atop Ecz	0.2413	0.0040**	0.2465
Control	Vitiligo	0.0163*	0.0384*	0.0213*
Control	Alop Are	0.0758	0.0005**	0.5864
Control	BCC	0.0001**	0.0033**	0.5311
Control	Act Ker	0.0008**	0.0000**	0.2567
Psoriasis	Atop Ecz	0.8520	0.1613	0.7942
Psoriasis	Vitiligo	0.2719	0.6103	0.1822
Psoriasis	Alop Are	0.7115	0.0476*	0.7845
Psoriasis	BCC	0.0068**	0.1401	0.1641
Psoriasis	Act Ker	0.0438*	0.0048**	0.8268
Atop Ecz	Vitiligo	0.2135	0.3658	0.3205
Atop Ecz	Alop Are	0.5892	0.5749	0.4911
Atop Ecz	BCC	0.0050**	0.9834	0.0781
Atop Ecz	Act Ker	0.0291*	0.3308	0.8857
Vitiligo	Alop Are	0.4900	0.1385	0.0596
Vitiligo	BCC	0.1120	0.3565	0.0041**
Vitiligo	Act Ker	0.3353	0.0345*	0.2380
Alop Are	BCC	0.0190*	0.6311	0.2094
Alop Are	Act Ker	0.1015	0.4744	0.4932
BCC	Act Ker	0.5086	0.2479	0.0779

Table 7.81 - Males - Variables: TAB - TCD

CANONICAL DISCRIMINANT FUNCTIONS

(a) FUNCTION	EIGENVALUE	PERCENT OF VARIANCE	CUMULATIVE PERCENT	CANONICAL CORRELATION
1*	0.01938	59.72	59.72	0.1378793
2*	0.00979	30.17	89.89	0.0984610
3*	0.00328	10.11	100.00	0.0571969

* MARKS THE 3 CANONICAL DISCRIMINANT FUNCTIONS REMAINING

(b) STANDARDIZED CANONICAL DISCRIMINANT FUNCTION COEFFICIENTS

	FUNC 1	FUNC 2	FUNC 3
TAB	-0.39258	-0.34772	0.96263
TBC	0.95907	-0.43383	-0.01633
TCD	0.28869	1.04072	0.10353

(c) STRUCTURE MATRIX:

POOLED WITHIN-GROUPS CORRELATIONS BETWEEN DISCRIMINATING VARIABLES AND CANONICAL DISCRIMINANT FUNCTIONS (VARIABLES ORDERED BY SIZE OF CORRELATION WITHIN FUNCTION)

	FUNC 1	FUNC 2	FUNC 3
TBC	0.91965*	-0.28227	0.27309
TCD	0.37509	0.81241*	0.44643
TAB	-0.02474	-0.09217	0.99544*

Table 7.82 - Males - Variables: TAB - TCD

Code Group
 0 Controls
 1 Psoriasis
 2 Atopic Eczema
 3 BCC
 5 Alopecia areata
 6 Actinic Keratosis
 7 Vitiligo

F STATISTICS AND SIGNIFICANCES BETWEEN PAIRS OF GROUPS

GROUP	GROUP	0	1	2	3	5	6
1		2.4073 0.0656					
2		8.3165 0.0000	2.2601 0.0798				
3		1.9690 0.1168	0.72407 0.5376	3.0840 0.0265			
5		1.8192 0.1418	1.1581 0.3245	3.5862 0.0133	0.74582E-01 0.9737		
6		3.9472 0.0081	1.9357 0.1219	5.4956 0.0009	2.7082 0.0459	3.4099 0.0170	
7		1.7583 0.1533	0.22418 0.8796	2.4559 0.0615	0.60138 0.6142	0.80424 0.4915	3.0522 0.0276

Figure 7.31 - Males - Variables: TAB - TCD

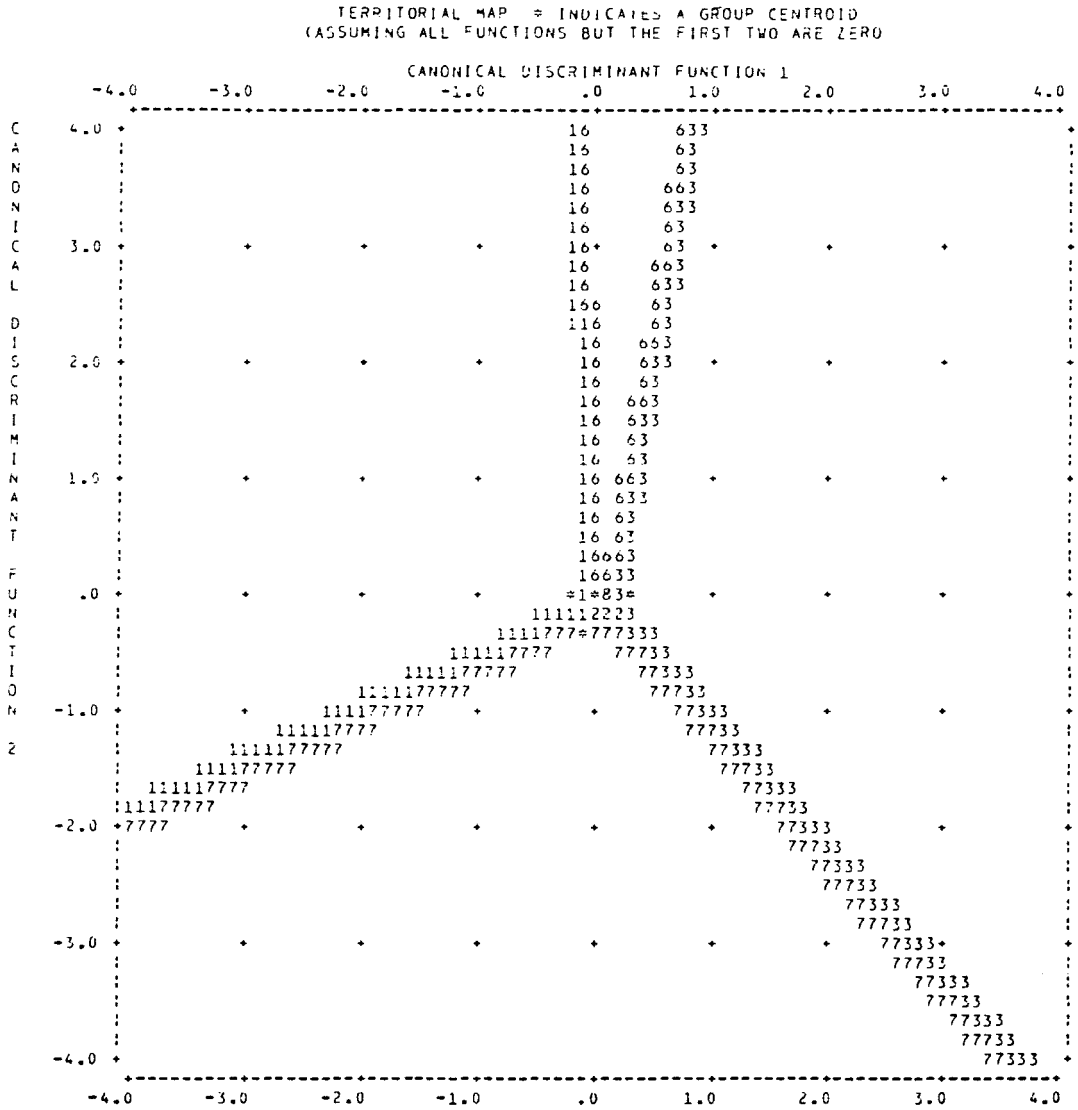

Code Group

1 - Controls
 2 - Psoriasis
 3 - Atopic Eczema
 4 - BCC
 6 - Alopecia areata
 7 - Actinic Keratosis
 8 - Vitiligo

Figure 7.32 - Males - Variables: TAB - TCD

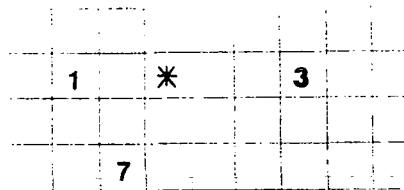
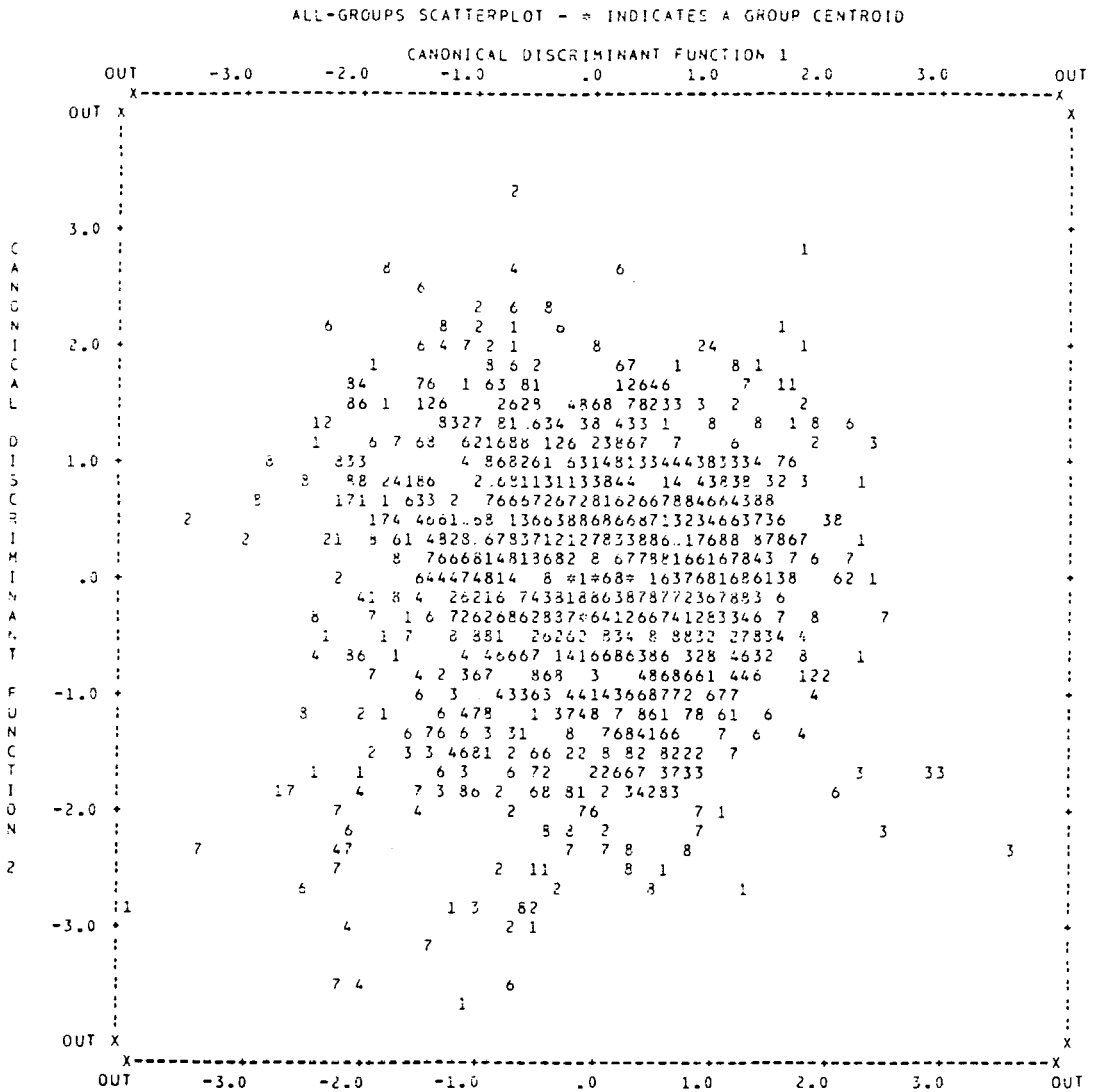

- Code Group
- 1 - Controls
 - 2 - Psoriasis
 - 3 - Atopic Eczema
 - 4 - BCC
 - 5 - Alopecia areata
 - 7 - Actinic Keratosis
 - 9 - Vitiligo

(* = 2+4+6+8)

Figure 7.33 - Group Centroids

Table 7.83 - Males - Variables: TAB - TCD

CLASSIFICATION RESULTS -

ACTUAL GROUP		NO. OF CASES	PREDICTED GROUP MEMBERSHIP						
			0	1	2	3	5	6	7
GROUP	0	199	63 31.7%	2 1.0%	50 25.1%	0 0.0%	23 11.6%	51 25.6%	10 5.0%
GROUP	1	202	52 25.7%	3 1.5%	66 32.7%	0 0.0%	24 11.9%	49 24.3%	8 4.0%
GROUP	2	202	34 16.8%	4 2.0%	88 43.6%	0 0.0%	21 10.4%	47 23.3%	8 4.0%
GROUP	3	209	55 26.3%	4 1.9%	67 32.1%	0 0.0%	32 15.3%	41 19.6%	10 4.8%
GROUP	5	207	51 24.6%	2 1.0%	67 32.4%	1 0.5%	28 13.5%	48 23.2%	10 4.8%
GROUP	6	129	30 23.3%	1 0.8%	42 32.6%	1 0.8%	5 3.9%	45 34.9%	5 3.9%
GROUP	7	197	51 25.9%	3 1.5%	66 33.5%	1 0.5%	19 9.6%	48 24.4%	9 4.6%

PERCENT OF "GROUPED" CASES CORRECTLY CLASSIFIED: 17.55%

Table 7.84 - Females - Variables: TAB - TCD

(a) CANONICAL DISCRIMINANT FUNCTIONS

FUNCTION	EIGENVALUE	PERCENT OF VARIANCE	CUMULATIVE PERCENT	CANONICAL CORRELATION
1*	0.05112	78.66	78.66	0.2205266
2*	0.00927	14.27	92.92	0.0958453
3*	0.00460	7.08	100.00	0.0676627

* MARKS THE 3 CANONICAL DISCRIMINANT FUNCTIONS REMAINING

(b) STANDARDIZED CANONICAL DISCRIMINANT FUNCTION COEFFICIENTS

	FUNC 1	FUNC 2	FUNC 3
TAB	-0.87365	-0.19315	0.64670
TBC	0.73893	-0.32045	0.67898
TCD	0.20747	1.10029	-0.09534

(c) STRUCTURE MATRIX:

POOLED WITHIN-GROUPS CORRELATIONS BETWEEN DISCRIMINATING VARIABLES
AND CANONICAL DISCRIMINANT FUNCTIONS
(VARIABLES ORDERED BY SIZE OF CORRELATION WITHIN FUNCTION)

	FUNC 1	FUNC 2	FUNC 3
TCD	0.06594	0.92816*	0.36629
TBC	0.60066	-0.04409	0.79829*
TAB	-0.62093	0.18312	0.76218*

Table 7.85 - Females - Variables: TAB - TCD

Code: Group
 0 Controls
 1 Psoriasis
 2 Atopic Eczema
 3 BCC
 5 Alopecia areata
 6 Actinic Keratosis
 7 Vitiligo

F STATISTICS AND SIGNIFICANCES BETWEEN PAIRS OF GROUPS

GROUP	0	1	2	3	5	6
1	3.8706 0.0090					
2	8.1199 0.0000	0.98743 0.3978				
3	15.698 0.0000	5.6457 0.0008	3.2427 0.0213			
5	10.535 0.0000	2.2364 0.0823	0.30491 0.8219	2.2450 0.0813		
6	16.199 0.0000	5.0454 0.0018	2.1387 0.0936	0.83302 0.4757	1.3246 0.2648	
7	10.513 0.0000	1.8840 0.1304	1.6784 0.1698	4.6550 0.0030	2.7658 0.0407	2.9404 0.0321

Figure 7.34 - Females - Variables: TAB - TCD

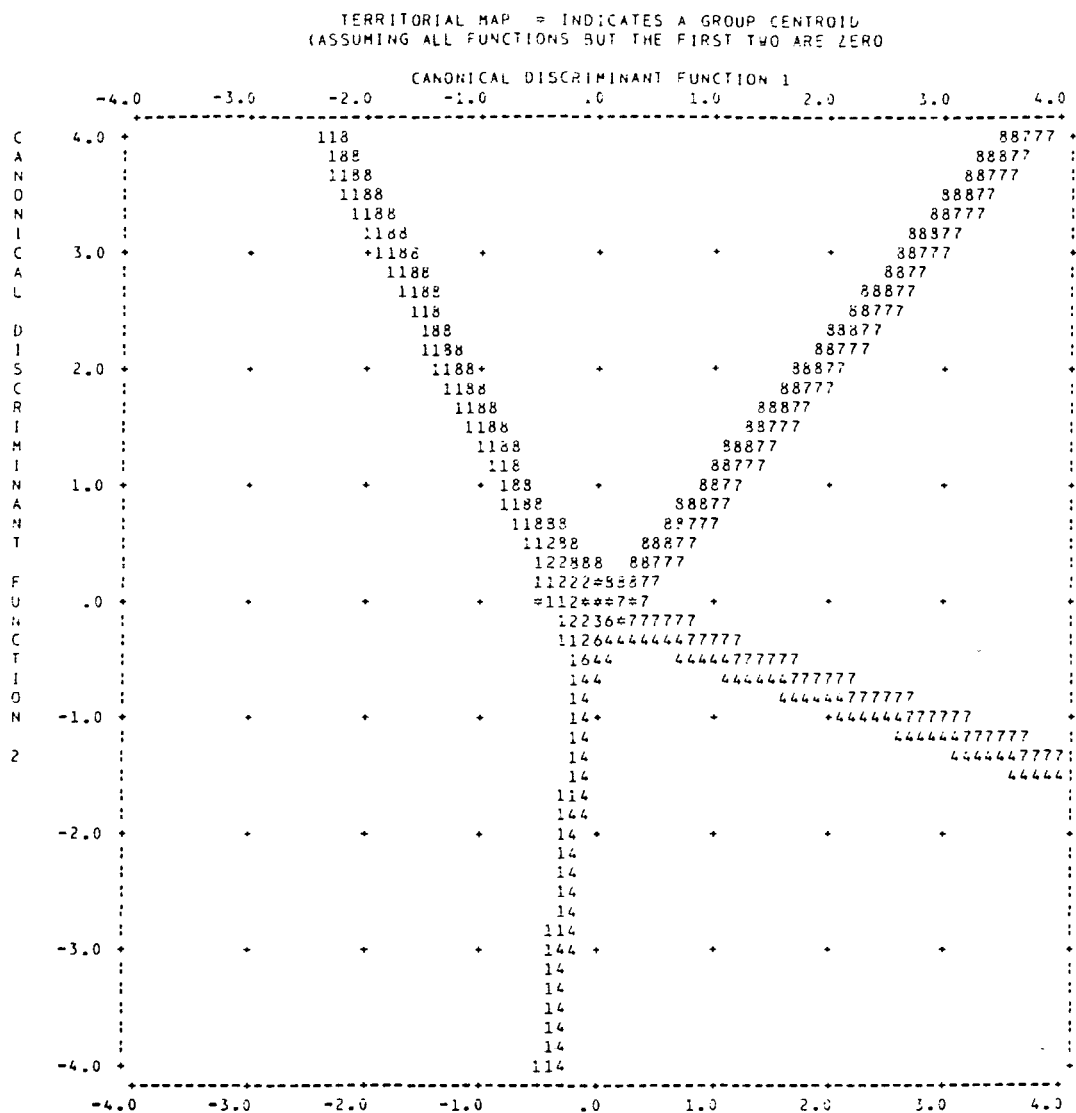

Code	Group
1	- Controls
2	- Psoriasis
3	- Atopic Eczema
4	- SCC
6	- Alopecia areata
7	- Actinic Keratosis
9	- Vitiligo

Figure 7.35 - Females - Variables: TAB TCD

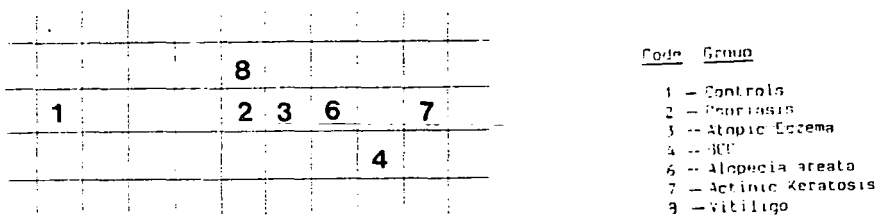
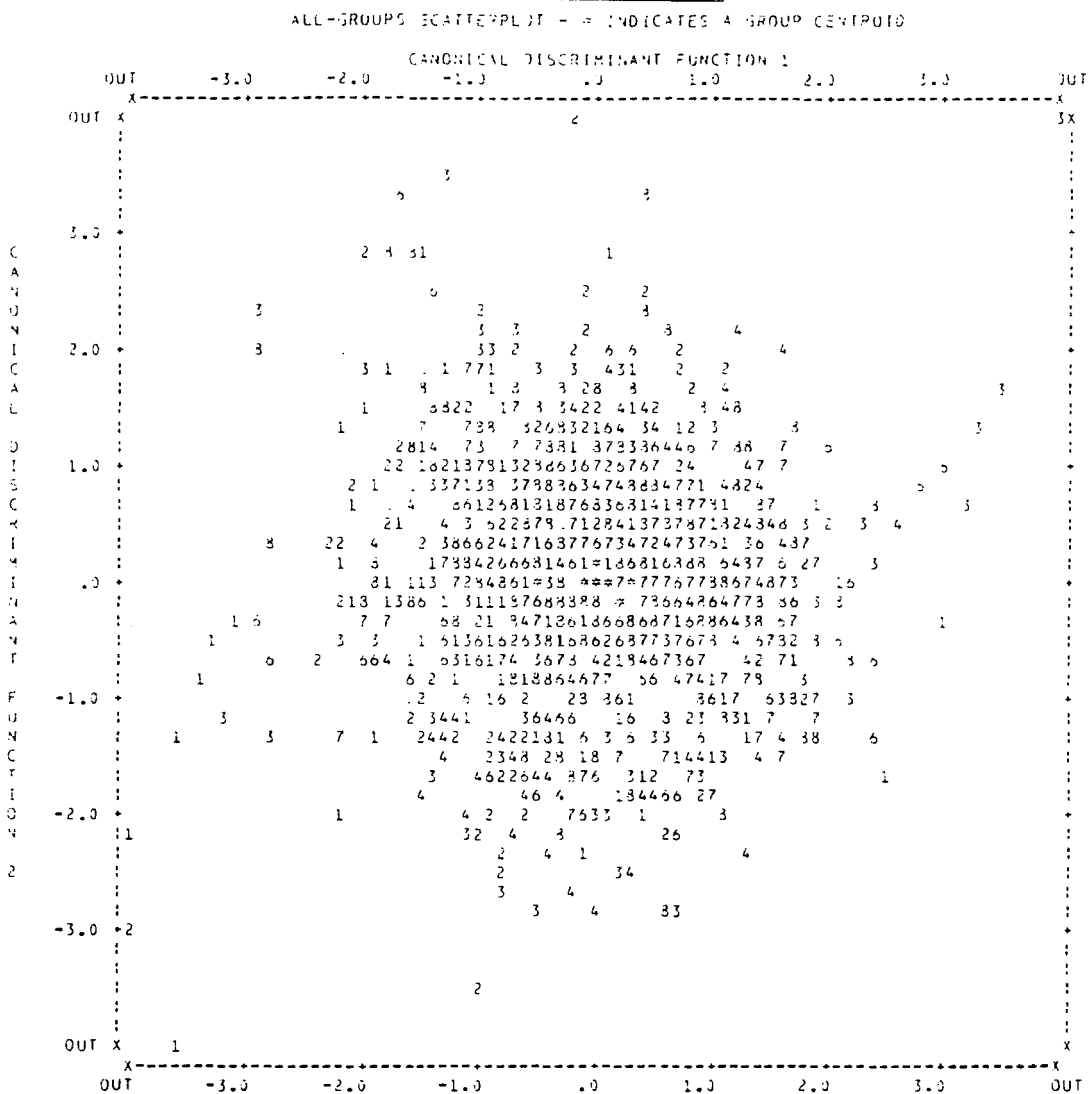

Figure 7.36 - Group Centroids

Table 7.86 - Females - Variables: TAB -TCD

CLASSIFICATION RESULTS -

ACTUAL GROUP	NO. OF CASES	PREDICTED GROUP MEMBERSHIP							
		0	1	2	3	5	6	7	
GROUP 0	198	89 44.9%	11 5.6%	5 2.5%	35 17.7%	13 6.6%	14 7.1%	31 15.7%	
GROUP 1	197	68 34.5%	4 2.0%	7 3.6%	42 21.3%	20 10.2%	15 7.6%	41 20.8%	
GROUP 2	200	64 32.0%	3 1.5%	12 6.0%	35 17.5%	21 10.5%	27 13.5%	38 19.0%	
GROUP 3	200	49 24.5%	4 2.0%	4 2.0%	48 24.0%	28 14.0%	30 15.0%	37 18.5%	
GROUP 5	201	58 28.9%	4 2.0%	4 2.0%	40 19.9%	31 15.4%	31 15.4%	33 16.4%	
GROUP 6	170	26 15.3%	2 1.2%	8 4.7%	39 22.9%	23 13.5%	41 24.1%	31 18.2%	
GROUP 7	199	58 29.1%	4 2.0%	5 2.5%	43 21.6%	18 9.0%	30 15.1%	41 20.6%	

PERCENT OF "GROUPED" CASES CORRECTLY CLASSIFIED: 19.49%

Table 7.87 - Means and SDs : Variables: TAB - TCD - Subjects by Disorder Type

Gp.	Sex	TAB		TBC		TCD	
		Mean	± SD	Mean	± SD	Mean	± SD
Cont	M	81.449	9.571	54.275	10.453	70.353	10.926
GD	M	81.075	9.639	55.000	9.470	74.000	9.689
ND	M	80.671	10.559	56.331	9.813	69.408	10.483
Cont	F	82.719	10.671	52.789	11.595	68.231	11.959
GD	F	80.908	9.580	55.960	9.522	70.000	10.398
ND	F	78.698	8.710	56.832	10.065	68.578	10.363

Table 7.88 - Mann-Whitney U Test Results - Variables: TAB - TCD - Grouped by Disorder Type

Sex	Gp1	Gp2	PROBABILITY		
			TAB	TBC	TCD
M	Cont	GD	0.6269	0.0016**	0.4849
M	Cont	ND	0.4613	0.0483*	0.5103
M	GD	ND	0.6523	0.3023	0.0758
F	Cont	GD	0.0329*	0.0015**	0.1150
F	Cont	ND	0.0000**	0.0000**	0.7325
F	GD	ND	0.0007**	0.0734	0.1158

(c) Summed Total Palmar Ridge Counts - Variables: RPRC, LPRC and TPRC

Atopic eczema males were found to have significantly higher summed total counts; on both hands individually and combined in comparison to controls; on right hand and for both hands combined in comparison to actinic keratosis, psoriasis and alopecia areata; on left and right hand in comparison to BCC; and on right hand only compared to vitiligo (see Tables 7.89(a) and 7.90(a)).

For female subjects, actinic keratosis sufferers were found to have significantly higher RPRC and TPRC in comparison to controls and significantly higher LPRC when compared to BCC female patients (see Tables 7.89(b) and 7.90(b)).

When the groups were regrouped according to aetiology type significantly higher values were found for RPRC and TPRC in GD males when compared to control males. For females, a significantly higher value was found in GD subjects in comparison to controls (see Tables 7.91 and 7.92).

Table 7.89

Means and Standard Deviations : Total Palmar Ridge Counts

(a) Sex = Male

Group	Cases	Variables					
		RPRC		LPRC		TPRC	
		Mean	Std. Dev.	Mean	Std. Dev.	Mean	Std. Dev.
Control	206	163.917 +/- 20.637		166.819 +/- 20.060		330.775 +/- 38.564	
Psoriasis	202	167.832 +/- 16.115		168.693 +/- 15.232		236.525 +/- 28.847	
Atop Ecz	203	171.300 +/- 18.238		171.094 +/- 18.396		342.431 +/- 34.695	
Vitiligo	201	167.226 +/- 18.159		169.482 +/- 19.491		337.173 +/- 34.969	
Alop Are	210	165.606 +/- 18.943		167.188 +/- 21.714		332.995 +/- 38.081	
BCC	211	166.343 +/- 19.049		167.048 +/- 20.329		333.440 +/- 36.876	
Act Ker	129	163.884 +/- 20.991		166.217 +/- 22.054		330.101 +/- 41.698	

(b) Sex = Female

Group	Cases	Variables					
		RPRC		LPRC		TPRC	
		Mean	Std. Dev.	Mean	Std. Dev.	Mean	Std. Dev.
Control	203	161.270 +/- 21.136		164.392 +/- 23.309		325.799 +/- 41.600	
Psoriasis	205	165.125 +/- 18.728		165.551 +/- 19.933		330.817 +/- 36.280	
Atop Ecz	203	165.249 +/- 18.798		168.363 +/- 19.528		333.795 +/- 36.011	
Vitiligo	205	165.507 +/- 18.389		166.835 +/- 19.304		332.960 +/- 35.121	
Alop Are	206	165.554 +/- 18.426		168.090 +/- 18.392		333.930 +/- 34.586	
BCC	202	162.980 +/- 20.305		163.677 +/- 21.462		326.875 +/- 39.594	
Act Ker	174	164.420 +/- 19.536		168.209 +/- 18.832		332.610 +/- 36.775	

Table 7.90 Mann-Whitney U Test Results – Total Palmar Ridge Counts

(a) Males

Group 1	Group 2	Probability		
		RPRC	LPRC	TPRC
Control	Psoriasis	0.0685	0.3218	0.1589
Control	Atop Ecz	0.0002**	0.0122*	0.0014**
Control	Vitiligo	0.1579	0.1271	0.0613
Control	Alop Are	0.5129	0.5082	0.4443
Control	BCC	0.1892	0.9577	0.4585
Control	Act Ker	0.9912	0.5808	0.6646
Psoriasis	Atop Ecz	0.0418*	0.0622	0.0263*
Psoriasis	Vitiligo	0.7708	0.5042	0.5987
Psoriasis	Alop Are	0.2476	0.8764	0.5281
Psoriasis	BCC	0.7287	0.3603	0.5539
Psoriasis	Act Ker	0.1421	0.9882	0.5286
Atop Ecz	Vitiligo	0.0269*	0.3771	0.1637
Atop Ecz	Alop Are	0.0034**	0.0782	0.0152*
Atop Ecz	BCC	0.0195*	0.0144*	0.0126
Atop Ecz	Act Ker	0.0022**	0.1190	0.0225*
Vitiligo	Alop Are	0.3905	0.3940	0.3067
Vitiligo	BCC	0.9285	0.1484	0.2759
Vitiligo	Act Ker	0.2113	0.4262	0.2679
Alop Are	BCC	0.5113	0.5793	0.9967
Alop Are	Act Ker	0.6147	0.9175	0.8227
BCC	Act Ker	0.2876	0.5900	0.8789

(b) Females

Group 1	Group 2	Probability		
		RPRC	LPRC	TPRC
Control	Psoriasis	0.1692	0.8614	0.4851
Control	Atop Ecz	0.2022	0.1430	0.1218
Control	Vitiligo	0.0647	0.4317	0.1167
Control	Alop Are	0.0552	0.1897	0.0787
Control	BCC	0.6655	0.7338	0.9163
Control	Act Ker	0.0466*	0.0984	0.0430*
Psoriasis	Atop Ecz	0.9026	0.1528	0.3549
Psoriasis	Vitiligo	0.6854	0.4456	0.3579
Psoriasis	Alop Are	0.6292	0.2242	0.2783
Psoriasis	BCC	0.3326	0.6212	0.5160
Psoriasis	Act Ker	0.6622	0.0947	0.1776
Atop Ecz	Vitiligo	0.6289	0.4989	0.9536
Atop Ecz	Alop Are	0.5772	0.8650	0.7768
Atop Ecz	BCC	0.3668	0.0799	0.1447
Atop Ecz	Act Ker	0.5428	0.7840	0.5271
Vitiligo	Alop Are	0.9987	0.5960	0.8671
Vitiligo	BCC	0.1786	0.2141	0.1295
Vitiligo	Act Ker	0.9675	0.3719	0.6647
Alop Are	BCC	0.1581	0.0794	0.0940
Alop Are	Act Ker	0.9857	0.6899	0.7527
BCC	Act Ker	0.1588	0.0465*	0.0666

Table 7.91 - Means and Standard Deviations - Subjects Grouped by Disorder Type

Gp.	Sex	RPRC		LPRC		TPRC	
		Mean	± SD	Mean	± SD	Mean	± SD
Cont	M	163.917	20.637	166.819	20.060	330.775	38.564
GD	M	167.980	17.990	169.098	18.891	337.255	34.435
ND	M	165.407	19.816	166.732	20.973	332.166	38.760
Cont	F	161.270	21.136	164.392	23.309	325.799	41.600
GD	F	165.360	18.551	167.216	19.291	332.885	35.457
ND	F	163.777	19.787	165.868	20.386	329.759	38.228

Table 7.92 - Mann-Whitney U Test Results - Subjects Grouped by Disorder Type

Sex	Gp1	Gp2	PROBABILITY		
			RPRC	LPRC	TPRC
M	Cont	GD	0.0286*	0.1211	0.0398*
M	Cont	ND	0.4655	0.9183	0.5958
M	GD	ND	0.1250	0.0962	0.0925
F	Cont	GD	0.0428*	0.2199	0.0736
F	Cont	ND	0.1641	0.4276	0.2124
F	GD	ND	0.4679	0.6794	0.5908

(d) Factor Analysis - Palmar Ridge Counts - Variables: LAB to TPRC(i) All Subjects - Variables: LAB to RAC

The results of Principal Components Analysis showed that 3 factors were extracted and that Factor 1 accounted for 56% of the variance (see Table 7.93). The rotated factor matrix shows that the most important variables were found to be b-c and a-c ridge counts on both hands (Table 7.94) and the relationships of the variables forming the factors are shown in Figure 7.37.

(ii) All Subjects - Variables: TAB to TCD

For these variables only one factor was extracted which accounted for 52.9% of the variance (see Table 7.95). Tables 7.96(a) and (b) show that within the extracted Factor 1 the importance of variables was found to be TCD, TAB and TBC in order of descending importance.

(iii) Males - Variables: LAB to TPRC

Table 7.97 shows the results of Principal Components Analysis for each of the groups of males. As can be seen 3 factors were extracted for each of the groups apart from psoriasis males where 4 factors were produced. In the groups with 3 factors Factor 1 accounted for between 62.1 and 67.8% of the variance. The importance of the different variables in each of the extracted functions is shown in Table 7.98. In five out of the seven groups Factor 1 contained all of the three b-c ridge counts. In Factor 2 four groups contain all of the c-d ridge counts. The other two c-d ridge counts are contained in Factor 1 for atopic eczema and actinic keratosis and currently these two groups have all of the b-c ridge counts in Factor 2. Figure 7.38 shows the variable plots for each of the seven groups of male subjects. The variables making up each factor are grouped together within the plots.

(iv) Females - Variables: LAB to TPRC

Table 7.99 shows the factors extracted by Principal Components Analysis. As for males, 3 factors were extracted for all groups with the exception of psoriasis, for which 4 factors were extracted. Factor 1 accounted for between 57.2 and 68.6% of the variance. In all groups b-c ridge counts were important in Factor 1, except for in psoriasis

(see Table 7.100). Similarly a-c ridge counts were the next most important in Factor 1 and c-d counts along with summed palmar ridge counts (LPRC - TPRC) were the most important variables contributing to Factor 2. The variables in Factors 1 and 2 were reversed in psoriatic females in comparison to the other groups. Figure 7.38 shows how the variables in the different factors are related in space for each of the groups.

Table 7.93 - Factor Analysis - Variables: LAB to RAC

1. PRINCIPAL COMPONENTS ANALYSIS (PC)

FACTOR	EIGENVALUE	PCT OF VAP	CUM PCT
1	5.60163	56.0	56.0
2	1.45999	14.6	70.6
3	1.30989	13.1	83.7
4	.70523	7.1	90.8
5	.42267	4.2	95.0
6	.29852	3.0	98.0
7	.12911	1.3	99.3
8	.05065	.5	99.8
9	.01426	.1	99.9
10	.00806	.1	100.0

PC EXTRACTED 3 FACTORS.

Table 7.94 - Variables: LAB to RAC

ROTATED FACTOR MATRIX:

	FACTOR 1	FACTOR 2	FACTOR 3
RBC	.91258	.13478	.05069
LBC	.89954	.13987	.09218
RAC	.67490	.23022	.55603
LAC	.67388	.23931	.56109
RCD	.10911	.88778	.14138
LCD	.13137	.86438	.20648
RBD	.63133	.66670	.13547
LBD	.61295	.65997	.20128
RAB	.10445	.15164	.90250
LAB	.11260	.17312	.89752

Figure 7.37 - Factor Analysis - Variables Plot: LAB to RAC

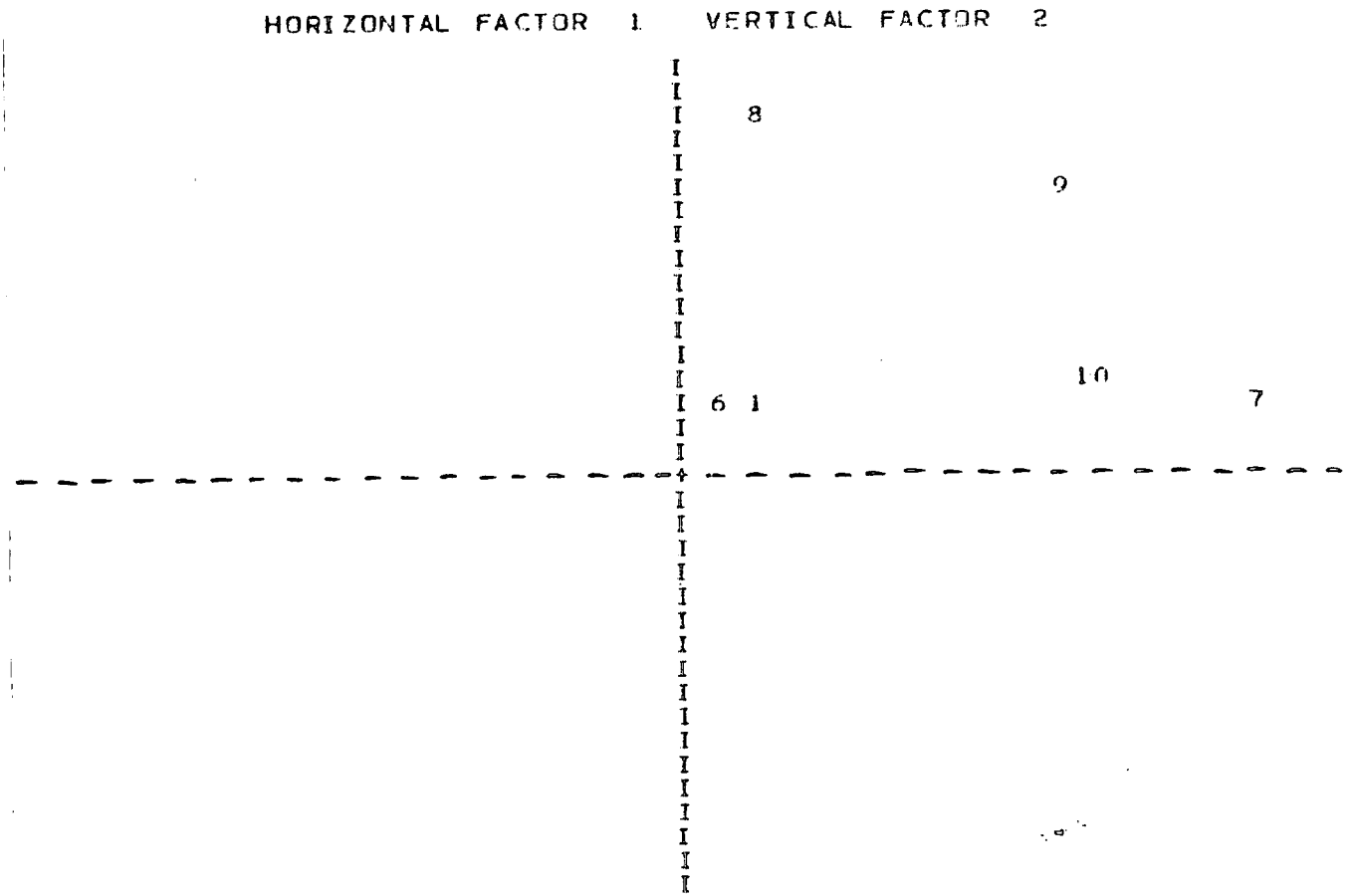

SYMBOL	VARIABLE	COORDINATES	SYMBOL	VARIABLE	COORDINATES	SYMBOL	VARIABLE	COORDINATES
1	LAB	(.11260, .17312)	2	LBC	(.89954, .13987)	3	LCD	(.13137, .86438)
4	LBD	(.61295, .65997)	5	LAC	(.67388, .23931)	6	RAB	(.10445, .15164)
7	RBC	(.91258, .13478)	8	RCD	(.10911, .88778)	9	RBD	(.63133, .66670)
10	RAC	(.67490, .23022)						

Table 7.95 - Factor Analysis - Variables: TAB to TCD1. PRINCIPAL COMPONENTS ANALYSIS (PC)

FACTOR	EIGENVALUE	PCT OF VAR	CUM PCT
1	1.58577	52.9	52.9
2	.78853	26.3	79.1
3	.62571	20.9	100.0

PC EXTRACTED 1 FACTORS.

Table 7.96 - Variables: TAB - TCD(a) FACTOR MATRIX:

	FACTOR 1
TCD	.78052
TAB	.73402
TBC	.66165

(b) FINAL STATISTICS:

VARIABLE	COMMUNALITY
TAB	.53878
TBC	.43778
TCD	.60921

Table 7.97 - Principal Components Analysis Results

Males - LAB to TPRC

	FACTOR	EIGENVALUE	PCT OF VAR	CUM PCT
Cont	1	10.03917	62.7	62.7
	2	2.47007	15.4	78.2
	3	1.86620	11.7	89.8
Psor	1	8.42012	52.6	52.6
	2	3.13304	19.6	72.2
	3	2.62742	15.4	88.6
	4	1.05950	6.6	95.3
A.Ecz	1	10.02724	62.7	62.7
	2	2.62865	16.4	79.1
	3	1.67225	10.5	89.6
BCC	1	10.05184	52.8	52.8
	2	2.23480	14.0	76.8
	3	1.91286	12.0	88.7
Alop	1	10.71424	67.0	67.0
	2	2.25179	14.1	81.0
	3	1.59443	10.0	91.0
A.Ker	1	10.84024	67.8	67.8
	2	2.22809	13.9	81.7
	3	1.97104	12.3	94.0
Vit	1	9.92999	62.1	62.1
	2	2.49558	15.6	77.7
	3	1.99944	12.5	90.2

Table 7.98 - Extracted Factors with Component Variables -
 Males - Variables: LAB to TPRC

	Cont	Psor	A.Ecz	BCC	Alop	A.Ker	Vit
FACTOR 1	TBC LBC RBC LAC RAC	TBC LBC RBC TPRC	TCD LCD RCD LBD LPRC TPRC RPRC	TBC RBC LBC LBD RAC LPRC	TBC RBC LBC RAC RBD LAC RPRC	TCD LCD RCD LBD LPRC TPRC RPRC	TBC LBC RBC LAC RBD
FACTOR 2	TCD LCD RCD RBD TPRC LBD RPRC LPRC	TAB RAB LAB RAC LAC	TBC RBC LBC RAC RBD	TCD RCD LCD RBD RPRC TPRC	TCD LCD RCD LBD LPRC TPRC	TBC RBC LBC RBD RAC	TCD RCD LCD LBD TPRC LPRC RPRC
FACTOR 3	TAB RAB LAB	RCD RBD RPRC TCD	TAB LAB RAB LAC	TAB LAB RAB LAC	TAB RAB LAB	TAB LAB RAB LAC	TAB RAB LAB RAC
FACTOR 4		LCD LBD LPRC					

Table 7.99 - Principal Components Analysis - Females -
Variables: LAB to TPRC

	FACTOR	EIGENVALUE	PCT OF VAR	CUM PCT
Cont	1	9.97307	62.3	62.3
	2	2.48796	15.5	77.9
	3	1.43621	9.0	86.9
Psor	1	9.34680	58.4	58.4
	2	2.34645	14.7	73.1
	3	1.91022	11.9	85.0
	4	1.18288	7.4	92.4
A.Ecz	1	9.14686	57.2	57.2
	2	2.66327	16.6	73.8
	3	2.37532	14.8	88.7
BCC	1	10.58160	66.1	66.1
	2	2.13454	13.3	79.5
	3	1.72030	10.8	90.2
Alop	1	10.19370	63.7	63.7
	2	2.25891	14.1	77.8
	3	1.83164	11.4	89.3
A.Ker	1	10.98330	68.6	68.6
	2	2.15306	13.5	82.1
	3	1.26079	7.9	90.0
Vit	1	9.99683	62.5	62.5
	2	2.63623	16.5	79.0
	3	1.73747	10.9	89.8

Table 7.100 - Extracted Factors with Component Variables

	Cont	Psor	A.Ecz	BCC	Alop	A.Ker	Vit
FACTOR 1	TBC RBC LBC RBD RAC LAC	TCD RCD LCD TPRC LBD RBD LPRC RPRC	TBC RBC LBC RAC LAC	TBC RBC LBC RAC LBD	TBC LBC RBC LBD RAC LPRC	TBC RBC LBC RAC LAC RBD RPRC TPRC	TBC LBC RBC LAC RAC LBD LPRC
FACTOR 2	TCD LCD RCD LBD TPRC RPRC LPRC	LBC TBC LAC	TCD RCD LCD TPRC LBD RBD LPRC RPRC	TCD RCD LCD RBD RPRC TPRC LPRC	TCD RCD LCD RBD TPRC RPRC	TCD LCD RCD LPRC LBD	TCD RCD LCD RPRC RBD TPRC
FACTOR 3	TAB RAB LAB	TAB RAB LAB	TAB RAB LAB	TAB LAB RAB LAC	TAB LAB RAB LAC	TAB RAB LAB	TAB LAB RAB
FACTOR 4		RBC RAC					

Figure 7.38 - Males - Variables: LAB to TPRC

(a) controls

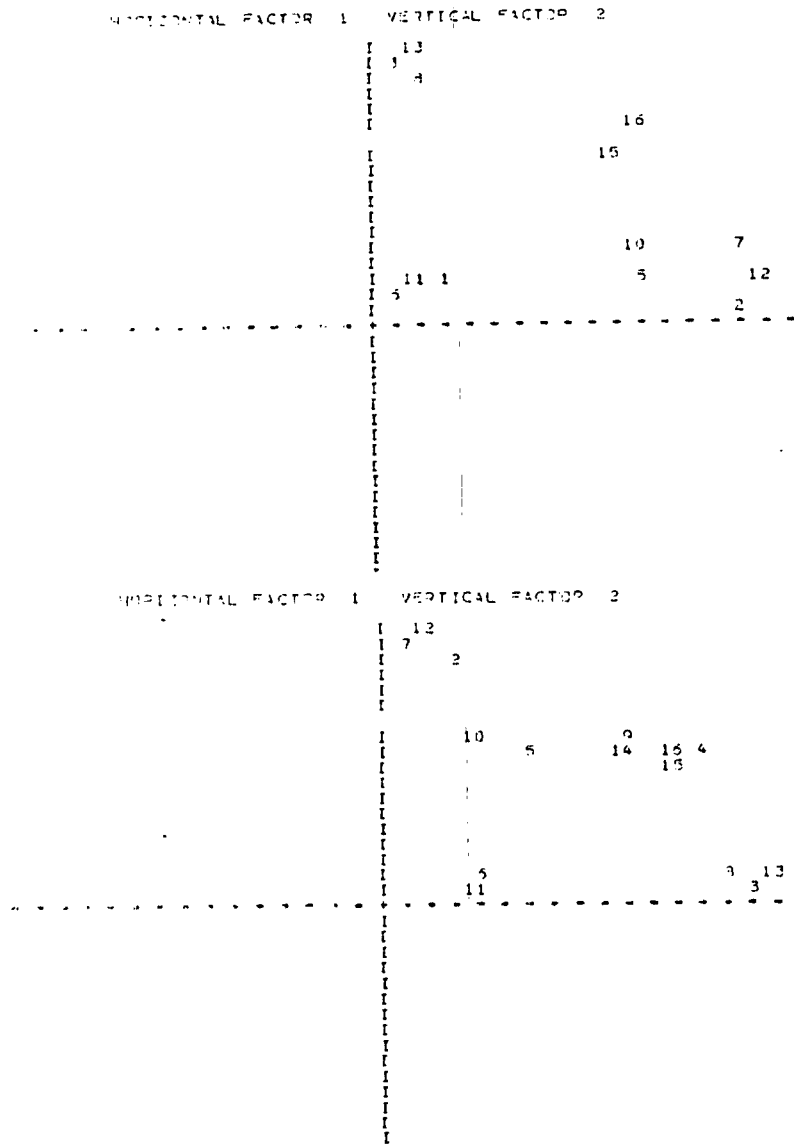

(c) A. Eczema

(b) psoriasis

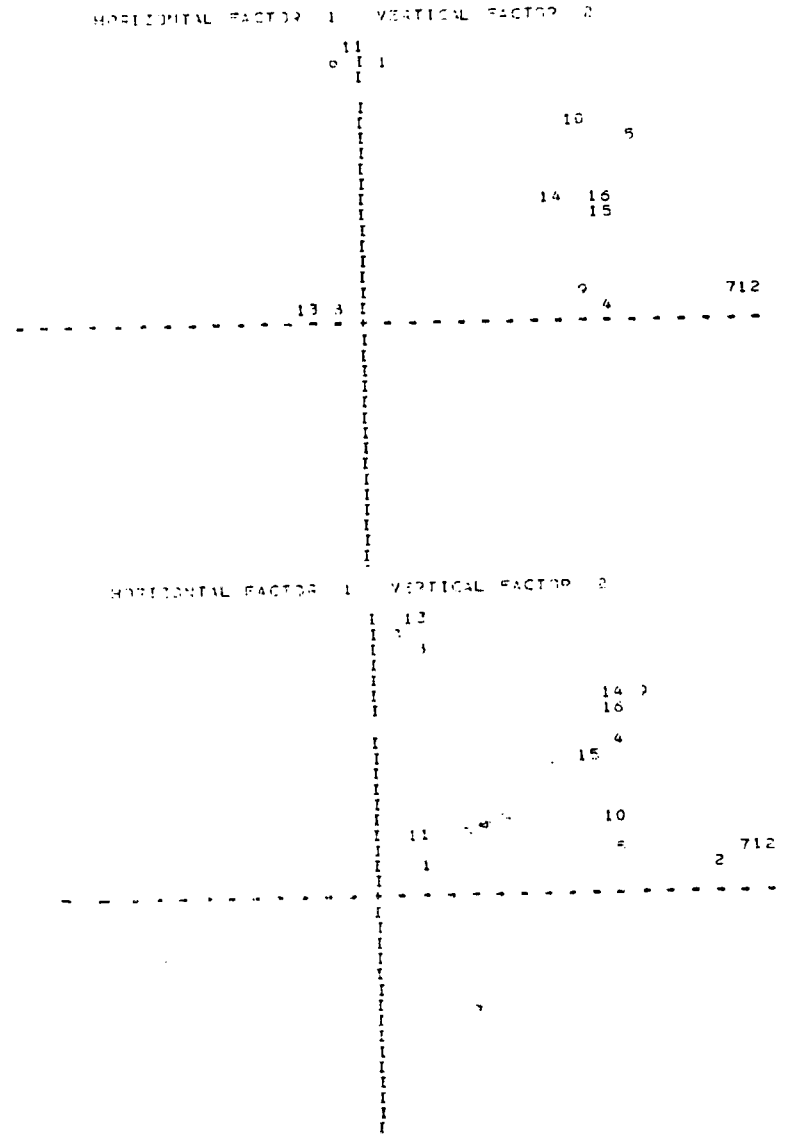

(d) BCC

Figure 7.38 continued

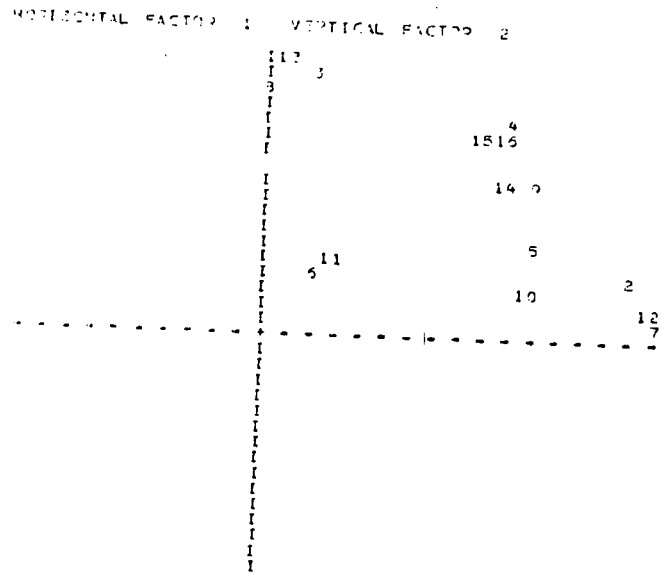

(e) Alop

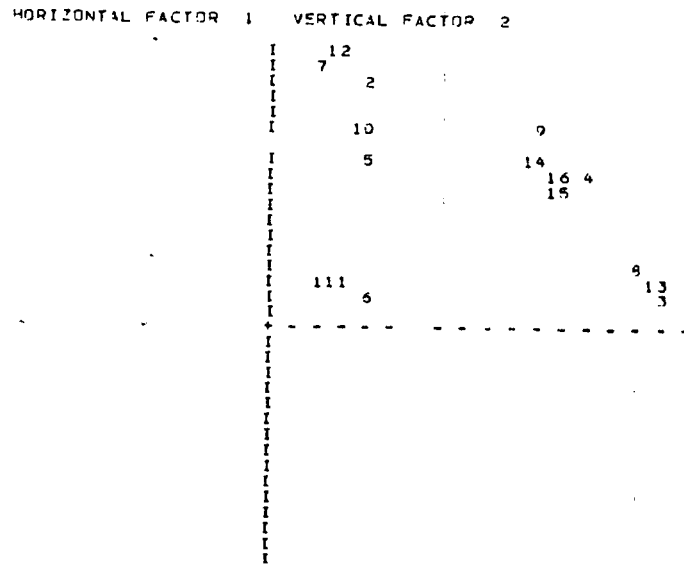

(g) Vitiligo

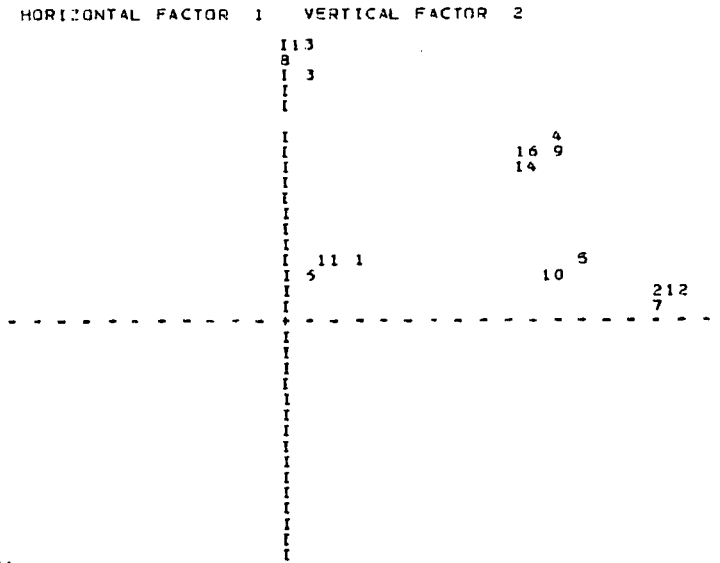

(f) A.Ker

SYMBOL VARIABLE

- 1 LAB
- 2 LBC
- 3 LCD
- 4 LBD
- 5 LAC
- 6 RAB
- 7 RBC
- 8 RCD
- 9 RBD
- 10 RAC
- 11 TAB
- 12 TBC
- 13 TCD
- 14 RPRC
- 15 LPRC
- 16 TPRC

Figure 7.39 - Females - Variables: LAB to TPRC

(a) Controls

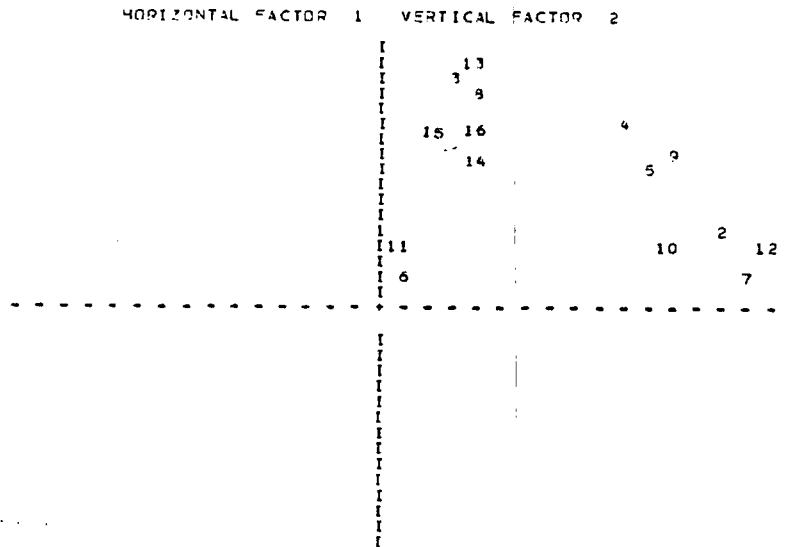

(b) Psoriasis

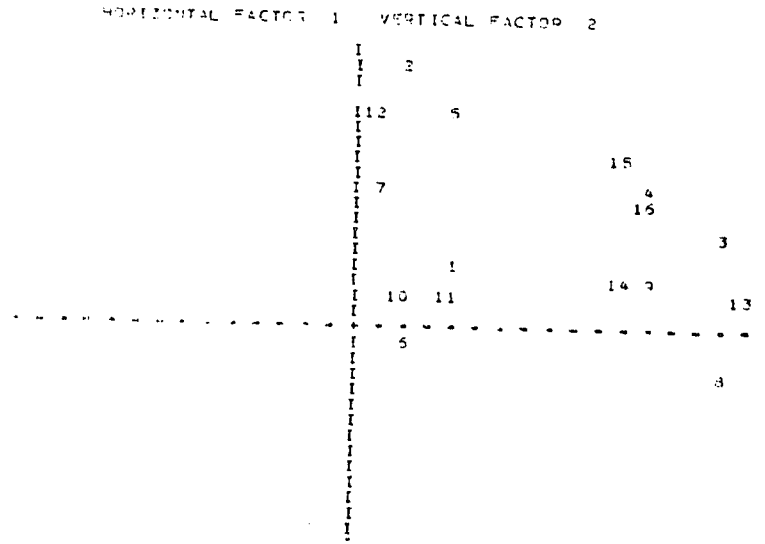

HORIZONTAL FACTOR 1 VERTICAL FACTOR 2

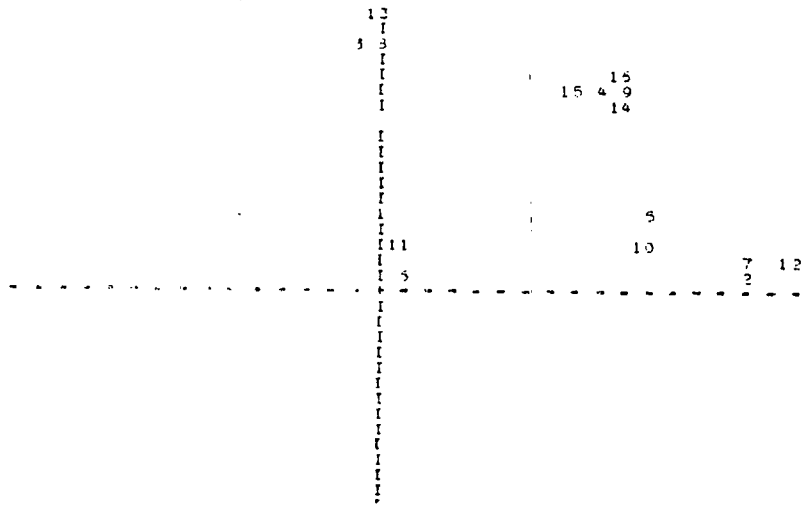

HORIZONTAL FACTOR 1 VERTICAL FACTOR 2

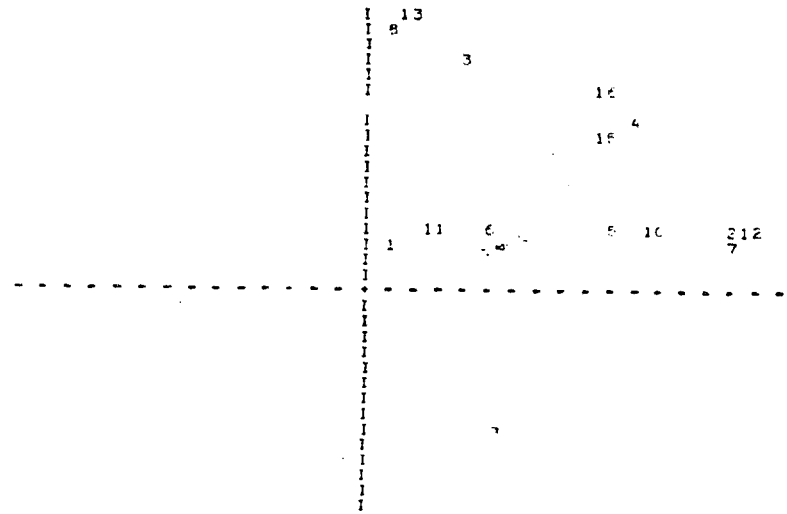

(c) Atopic Eczema

(d) BCC

Figure 7.39 continued

(e) Alop

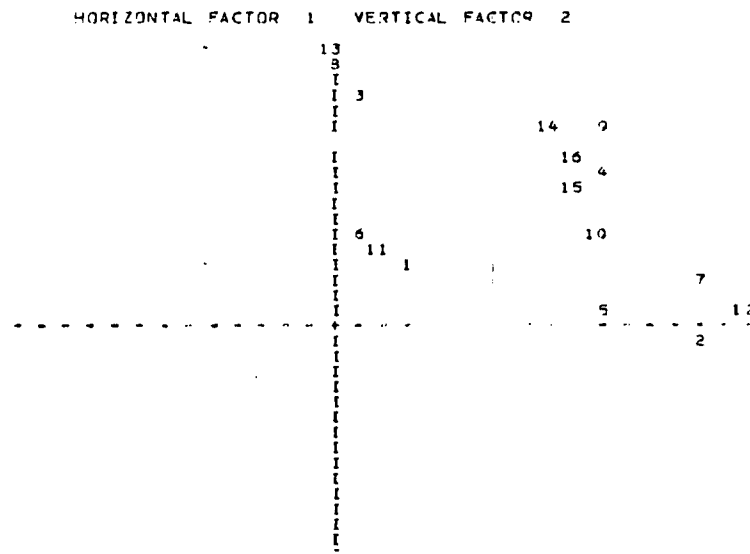
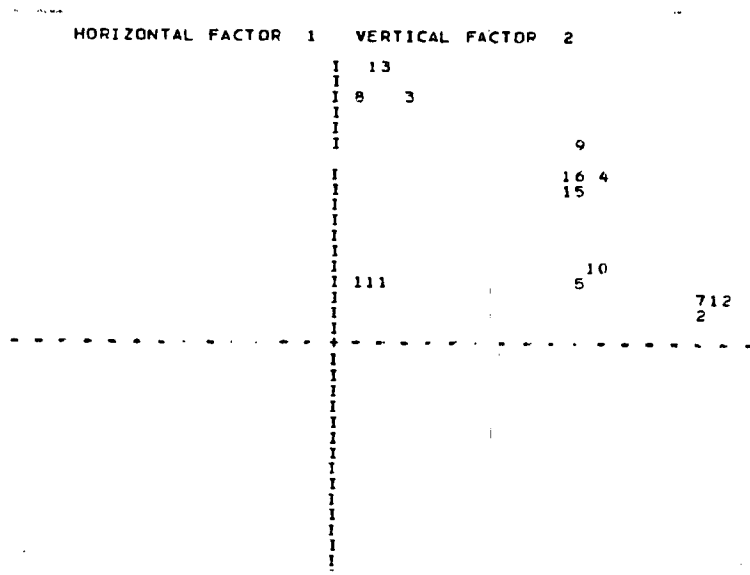

(g) Vitiligo

(f) A.Ker

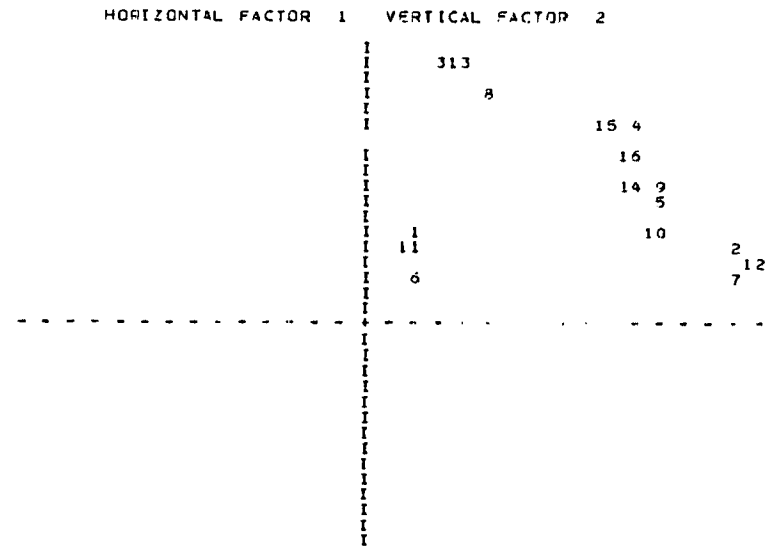

SYMBOL VARIABLE

- 1 LAB
- 2 LBC
- 3 LCD
- 4 LBD
- 5 LAC
- 6 RAB
- 7 RBC
- 8 RCD
- 9 RRD
- 10 RAC
- 11 TAB
- 12 TBC
- 13 TCD
- 14 RPRC
- 15 LPRC
- 16 TPRC

7.4 Palmar Mainline Directions - Variables: ARL to DUR

For male subjects the only significant differences between groups were found for the c triradius. Actinic keratosis males were found to have a significantly higher frequency of occurrence C line turning radially, and significantly lower frequency of C turning ulnarly, in comparison to controls, atopic eczema, vitiligo, alopecia areata and BCC, on both hands, and psoriasis on the left hand only (see Tables 7.101(a) and 7.102). Psoriasis males had a significantly higher occurrence of C turning ulnarly in comparison to vitiligo and alopecia areata on both hands. Vitiligo and atopic eczema males were found to have significantly higher occurrence of line C turning ulnarly in comparison to BCC and actinic keratosis.

For females controls had a significantly lower occurrence of C line turning radially on the left hand in comparison to both BCC and actinic keratosis (Tables 7.101(b) and 7.103). On the right hand actinic keratosis females had a significantly higher occurrence of C line turning radially in comparison to vitiligo and also a significantly lower occurrence of C line turning ulnarly in the same comparison.

* Table 7.101(a)

Percentage Frequencies :

Directions of Mainlines

Males

Group	Cases	Percentage Frequencies															
		ARL		AUL		BRL		BUL		CRL		CUL		DRL		DUL	
		0	1	0	1	0	1	0	1	0	1	0	1	0	1	0	1
Controls	205	100.0	0.0	0.0	100.0	100.0	0.0	0.0	100.0	47.1	52.9	53.2	46.8	0.5	99.5	99.5	0.5
Psoriasis	201	100.0	0.0	0.0	100.0	100.0	0.0	0.0	100.0	36.6	63.4	63.4	36.6	0.0	100.0	100.0	0.0
Atop Ecz	203	100.0	0.0	0.0	100.0	100.0	0.0	0.0	100.0	52.7	47.3	47.8	52.2	0.0	100.0	100.0	0.0
Vitiligo	201	100.0	0.0	0.0	100.0	100.0	0.0	0.0	100.0	53.7	46.3	48.3	51.7	0.5	99.5	99.5	0.5
Alop Are	210.	100.0	0.0	0.0	100.0	100.0	0.0	0.0	100.0	50.0	50.0	51.0	49.0	0.0	100.0	100.0	0.0
BCC	211	100.0	0.0	0.0	100.0	99.5	0.5	0.5	99.5	38.4	61.6	62.1	37.9	0.0	100.0	100.0	0.0
ActKer	129	100.0	0.0	0.0	100.0	100.0	0.0	0.0	100.0	24.0	76.0	76.0	24.0	0.0	100.0	100.0	0.0

Group	Cases	Percentage Frequencies															
		ARR		AUR		BRR		BUR		CRR		CUR		DRR		DUR	
		0	1	0	1	0	1	0	1	0	1	0	1	0	1	0	1
Controls	205	100.0	0.0	0.0	100.0	100.0	0.0	0.0	100.0	38.0	62.0	62.0	38.0	0.5	99.5	99.5	0.5
Psoriasis	202	100.0	0.0	0.0	100.0	100.0	0.0	0.0	100.0	34.2	65.8	65.8	34.2	0.0	100.0	100.0	0.0
Atop Ecz	203	100.0	0.0	0.0	100.0	100.0	0.0	0.0	100.0	43.1	56.9	57.1	42.9	0.5	99.5	99.5	0.0
Vitiligo	201	100.0	0.0	0.0	100.0	100.0	0.0	0.0	100.0	46.8	53.2	54.2	45.8	0.0	100.0	100.0	0.0
Alop Are	210.	100.0	0.0	0.0	100.0	100.0	0.0	0.0	100.0	45.2	54.8	55.7	44.3	0.0	100.0	100.0	0.0
BCC	211	100.0	0.0	0.0	100.0	99.5	0.5	0.5	99.5	38.9	61.1	61.6	38.4	0.0	100.0	100.0	0.0
ActKer	129	100.0	0.0	0.0	100.0	100.0	0.0	0.0	100.0	26.4	73.6	73.6	26.4	0.0	100.0	100.0	0.0

Table 7.101(b)

Percentage Frequencies

Directions of Mainlines

Females

Group	Cases	Percentage Frequencies															
		ARL		AUL		BRL		BUL		CRL		CUL		DRL		DUL	
		0	1	0	1	0	1	0	1	0	1	0	1	0	1	0	1
Controls	203	100.0	0.0	0.0	100.0	100.0	0.0	0.0	100.0	52.7	47.3	51.0	49.0	0.5	99.5	99.5	0.5
Psoriasis	205	100.0	0.0	0.0	100.0	100.0	0.0	0.0	100.0	47.3	52.7	56.6	43.4	1.0	99.0	99.0	1.0
Atop Ecz	203	100.0	0.0	0.0	100.0	99.5	0.5	0.5	99.5	45.0	54.7	55.7	44.3	0.0	100.0	100.0	0.0
Vitiligo	202	100.0	0.0	0.0	100.0	100.0	0.0	0.0	100.0	44.9	55.1	57.6	42.4	0.0	100.0	100.0	0.0
Alop Are	206	100.0	0.0	0.0	100.0	100.0	0.0	0.0	100.0	45.6	54.4	56.8	43.2	0.0	100.0	100.0	0.0
BCC	202	100.0	0.0	0.0	100.0	100.0	0.0	0.0	100.0	41.6	58.4	58.9	41.1	0.0	100.0	100.0	0.0
ActKer	174	100.0	0.0	0.0	100.0	100.0	0.0	0.0	100.0	40.8	59.2	60.9	39.1	0.0	100.0	100.0	0.0

Group	Cases	Percentage Frequencies															
		ARR		AUR		BRR		BUR		CRR		CUR		DRR		DUR	
		0	1	0	1	0	1	0	1	0	1	0	1	0	1	0	1
Controls	203	100.0	0.0	0.0	100.0	100.0	0.0	0.0	100.0	42.9	57.1	60.1	39.9	0.5	99.5	99.5	0.5
Psoriasis	205	100.0	0.0	0.0	100.0	100.0	0.0	0.0	99.5	43.4	56.6	59.5	40.5	0.5	99.5	99.5	0.5
Atop Ecz	203	100.0	0.0	0.0	100.0	99.9	1.0	1.0	99.0	37.4	62.6	63.5	36.5	0.0	100.0	100.0	0.0
Vitiligo	202	100.0	0.0	0.0	100.0	100.0	0.0	0.0	100.0	44.4	55.6	56.6	43.4	0.0	100.0	100.0	0.0
Alop Are	206	100.0	0.0	0.0	100.0	100.0	0.0	0.0	100.0	41.7	58.3	59.2	40.8	0.0	100.0	100.0	0.0
BCC	202	100.0	0.0	0.0	100.0	100.0	0.0	0.0	100.0	41.6	58.4	58.9	41.1	0.0	100.0	100.0	0.0
ActKer	174	100.0	0.0	0.0	100.0	100.0	0.0	0.0	100.0	33.9	66.1	66.7	33.3	0.0	100.0	100.0	0.0

Table 7.102(a)

Mann-Whitney U Test

Mainline Directions - Left Hand

Males

Group 1	Group 2	Probability (* = Significant* = Highly significant)							
		ARL	AUL	BRL	BUL	CRL	CUL	DRL	DUL
Control	Psoriasis	1.0000	1.0000	1.0000	1.0000	0.0335*	0.0373*	0.3209	0.3209
Control	Atop Ecz	1.0000	1.0000	1.0000	1.0000	0.2549	0.2771	0.3197	0.3197
Control	Vitiligo	1.0000	1.0000	1.0000	1.0000	0.1799	0.3229	0.9889	0.3221
Control	Alop Are	1.0000	1.0000	1.0000	1.0000	0.5499	0.6515	0.3115	0.3115
Control	BCC	1.0000	1.0000	0.3243	0.3243	0.0745	0.0661	0.3103	0.3103
Control	Act Ker	1.0000	1.0000	1.0000	1.0000	0.0000**	0.0000**	0.4276	0.4276
Psoriasis	Atop Ecz	1.0000	1.0000	1.0000	1.0000	0.0012**	0.0016**	1.0000	1.0000
Psoriasis	Vitiligo	1.0000	1.0000	1.0000	1.0000	0.0006**	0.0023**	0.3161	1.0000
Psoriasis	Alop Are	1.0000	1.0000	1.0000	1.0000	0.0063**	0.0110*	1.0000	1.0000
Psoriasis	BCC	1.0000	1.0000	0.3279	0.3279	0.7131	0.7881	1.0000	1.0000
Psoriasis	Act Ker	1.0000	1.0000	1.0000	1.0000	0.0164*	0.0164*	1.0000	1.0000
Atop Ecz	Vitiligo	1.0000	1.0000	1.0000	1.0000	0.8371	0.9239	0.3149	1.0000
Atop Ecz	Alop Are	1.0000	1.0000	1.0000	1.0000	0.5823	0.5201	1.0000	1.0000
Atop Ecz	BCC	1.0000	1.0000	0.3267	0.3267	0.0035**	0.0035**	1.0000	1.0000
Atop Ecz	Act Ker	1.0000	1.0000	1.0000	1.0000	0.0000**	0.0000**	1.0000	1.0000
Vitiligo	Alop Are	1.0000	1.0000	1.0000	1.0000	0.4497	0.5855	0.3067	1.0000
Vitiligo	BCC	1.0000	1.0000	0.3291	0.3291	0.0018**	0.0048**	0.3056	1.0000
Vitiligo	Act Ker	1.0000	1.0000	1.0000	1.0000	0.0000**	0.0000**	0.4231	1.0000
Alop Are	BCC	1.0000	1.0000	0.3185	0.3185	0.0166*	0.0214*	1.0000	1.0000
Alop Are	Act Ker	1.0000	1.0000	1.0000	1.0000	0.0000**	0.0000**	1.0000	1.0000
BCC	Act Ker	1.0000	1.0000	0.4343	0.4343	0.0063**	0.0088**	1.0000	1.0000

Table 7.102(b)

		Probability (* = Significant* = Highly significant)							
Group 1	Group 2	ARR	AUR	BRR	BUR	CRR	CUR	DRR	DUR
Control	Psoriasis	1.0000	1.0000	1.0000	1.0000	0.4145	0.4748	0.3209	0.3209
Control	Atop Ecz	1.0000	1.0000	1.0000	1.0000	0.3029	0.2759	0.9945	0.9945
Control	Vitiligo	1.0000	1.0000	1.0000	1.0000	0.0759	0.0938	0.3221	0.3221
Control	Alop Are	1.0000	1.0000	1.0000	1.0000	0.1380	0.1642	0.3115	0.3115
Control	BCC	1.0000	1.0000	0.3243	0.3243	0.8647	0.8621	0.3103	0.3103
Control	Act Ker	1.0000	1.0000	1.0000	1.0000	0.0278*	0.0346*	0.4276	0.4276
Psoriasis	Atop Ecz	1.0000	1.0000	1.0000	1.0000	0.0662	0.0724	0.3185	0.3185
Psoriasis	Vitiligo	1.0000	1.0000	1.0000	1.0000	0.0100*	0.0175*	1.0000	1.0000
Psoriasis	Alop Are	1.0000	1.0000	1.0000	1.0000	0.0218*	0.0356*	1.0000	1.0000
Psoriasis	BCC	1.0000	1.0000	0.3279	0.3279	0.3216	0.3721	1.0000	1.0000
Psoriasis	Act Ker	1.0000	1.0000	1.0000	1.0000	0.1355	0.1355	1.0000	1.0000
Atop Ecz	Vitiligo	1.0000	1.0000	1.0000	1.0000	0.4562	0.5560	0.3197	0.3197
Atop Ecz	Alop Are	1.0000	1.0000	1.0000	1.0000	0.6580	0.7700	0.3091	0.3091
Atop Ecz	BCC	1.0000	1.0000	0.3267	0.3267	0.3853	0.3552	0.3080	0.3080
Atop Ecz	Act Ker	1.0000	1.0000	1.0000	1.0000	0.0021**	0.0024**	0.4254	0.4254
Vitiligo	Alop Are	1.0000	1.0000	1.0000	1.0000	0.7563	0.7625	1.0000	1.0000
Vitiligo	BCC	1.0000	1.0000	0.3291	1.0000	0.1054	0.1296	1.0000	1.0000
Vitiligo	Act Ker	1.0000	1.0000	1.0000	1.0000	0.0002**	0.0004**	1.0000	1.0000
Alop Are	BCC	1.0000	1.0000	0.3185	0.3185	0.1856	0.2198	1.0000	1.0000
Alop Are	Act Ker	1.0000	1.0000	1.0000	1.0000	0.0005**	0.0009**	1.0000	1.0000
BCC	Act Ker	1.0000	1.0000	0.4343	0.4343	0.0184*	0.0231*	1.0000	1.0000

Table 7.103(a)

Mann-Whitney U Test Results

Mainline Directions - Left Hand

Females

		Probability (* = Significant* = Highly significant)							
Group 1	Group 2	ARL	AUL	BRL	BUL	CRL	CUL	DRL	DUL
Control	Psoriasis	1.0000	1.0000	1.0000	1.0000	0.2767	0.2582	0.5685	0.5685
Control	Atop Ecz	1.0000	1.0000	0.3173	0.3173	0.1369	0.3463	0.3173	0.3173
Control	Vitiligo	1.0000	1.0000	1.0000	1.0000	0.1140	0.1839	0.3149	0.3149
Control	Alop Are	1.0000	1.0000	1.0000	1.0000	0.1527	0.2400	0.3138	0.3138
Control	BCC	1.0000	1.0000	1.0000	1.0000	0.0251*	0.1101	0.3185	0.3185
Control	Act Ker	1.0000	1.0000	1.0000	1.0000	0.0212*	0.0537	0.3545	0.3492
Psoriasis	Atop Ecz	1.0000	1.0000	1.0000	0.3142	0.6863	0.8516	0.1588	0.1588
Psoriasis	Vitiligo	1.0000	1.0000	1.0000	1.0000	0.6208	0.8420	0.1568	0.1568
Psoriasis	Alop Are	1.0000	1.0000	1.0000	1.0000	0.7322	0.9657	0.1558	0.1558
Psoriasis	BCC	1.0000	1.0000	1.0000	1.0000	0.2451	0.6853	0.1599	0.1599
Psoriasis	Act Ker	1.0000	1.0000	1.0000	1.0000	0.2040	0.3940	0.1920	0.1920
Atop Ecz	Vitiligo	1.0000	1.0000	0.3149	0.3149	0.9286	0.6996	1.0000	1.0000
Atop Ecz	Alop Are	1.0000	1.0000	0.3138	0.3138	0.9497	0.8176	1.0000	1.0000
Atop Ecz	BCC	1.0000	1.0000	0.3185	0.3185	0.4488	0.5096	1.0000	1.0000
Atop Ecz	Act Ker	1.0000	1.0000	0.3545	0.3545	0.3783	0.3033	1.0000	1.0000
Vitiligo	Alop Are	1.0000	1.0000	1.0000	1.0000	0.8783	0.8756	1.0000	1.0000
Vitiligo	BCC	1.0000	1.0000	1.0000	1.0000	0.5030	0.7827	1.0000	1.0000
Vitiligo	Act Ker	1.0000	1.0000	1.0000	1.0000	0.4254	0.5081	1.0000	1.0000
Alop Are	BCC	1.0000	1.0000	1.0000	1.0000	0.4104	0.6658	1.0000	1.0000
Alop Are	Act Ker	1.0000	1.0000	1.0000	1.0000	0.3449	0.4167	1.0000	1.0000
BCC	Act Ker	1.0000	1.0000	1.0000	1.0000	0.8785	0.6924	1.0000	1.0000

Table 7.103(b)

Mann-Whitney U Test Results

Palmar Mainline Directions - Rights hand

Females

		Probability (* = Significant* = Highly significant)							
Group 1	Group 2	ARR	AUR	BRR	BUR	CRR	CUR	DRR	DUR
Control	Psoriasis	1.0000	1.0000	1.0000	0.3197	0.9545	0.9040	0.9945	0.9945
Control	Atop Ecz	1.0000	1.0000	0.1568	0.1568	0.2660	0.4751	0.3173	0.3173
Control	Vitiligo	1.0000	1.0000	1.0000	1.0000	0.7552	0.4723	0.3149	0.3149
Control	Alop Are	1.0000	1.0000	1.0000	1.0000	0.8206	0.8570	0.3138	0.3138
Control	BCC	1.0000	1.0000	1.0000	1.0000	0.7956	0.8079	0.3185	0.3185
Control	Act Ker	1.0000	1.0000	1.0000	1.0000	0.0758	0.1882	0.3545	0.3545
Psoriasis	Atop Ecz	1.0000	1.0000	0.1548	0.5570	0.2418	0.4029	0.3197	0.3197
Psoriasis	Vitiligo	1.0000	1.0000	1.0000	0.3173	0.7987	0.5487	0.3173	0.3173
Psoriasis	Alop Are	1.0000	1.0000	1.0000	0.3161	0.7762	0.9525	0.3161	0.3161
Psoriasis	BCC	1.0000	1.0000	1.0000	0.3209	0.7518	0.9019	0.3209	0.3209
Psoriasis	Act Ker	1.0000	1.0000	1.0000	0.3569	0.0669	0.1515	0.3569	0.3569
Atop Ecz	Vitiligo	1.0000	1.0000	0.1548	0.1548	0.1538	0.1517	1.0000	1.0000
Atop Ecz	Alop Are	1.0000	1.0000	0.1538	0.1538	0.3736	0.3698	1.0000	1.0000
Atop Ecz	BCC	1.0000	1.0000	0.1578	0.1578	0.3941	0.3389	1.0000	1.0000
Atop Ecz	Act Ker	1.0000	1.0000	0.1898	0.1898	0.4706	0.5272	1.0000	1.0000
Vitiligo	Alop Are	1.0000	1.0000	1.0000	1.0000	0.5890	0.5885	1.0000	1.0000
Vitiligo	BCC	1.0000	1.0000	1.0000	1.0000	0.5680	0.6353	1.0000	1.0000
Vitiligo	Act Ker	1.0000	1.0000	1.0000	1.0000	0.0378*	0.0456*	1.0000	1.0000
Alop Are	BCC	1.0000	1.0000	1.0000	1.0000	0.9733	0.9489	1.0000	1.0000
Alop Are	Act Ker	1.0000	1.0000	1.0000	1.0000	0.1175	0.1356	1.0000	1.0000
BCC	Act Ker	1.0000	1.0000	1.0000	1.0000	0.1268	0.1219	1.0000	1.0000

7.5 Palmar Flexion Creases

(a) Transverse Flexion Crease - Variables: FCL and FCR

The percentage frequency of occurrence of each of the variants of transverse flexion crease is shown for each of the groups of subjects in Table 7.104. For male subjects, atopic eczema patients were found to have a significantly lower occurrence of variants of the normal transverse flexion crease in comparison to BCC on both hands and in comparison to controls on the left hand only (Table 7.105(a)). For female subjects, psoriatics were found to have a greater occurrence of transverse flexion crease variants, particularly 'close lines' in comparison to alopecia areata (both hands) and to atopic eczema and actinic keratosis on the right hand only (Table 7.105(b)).

(b) Thenar Flexion Crease - Variables: TCVL to TCTR

(i) Thenar Flexion Crease Variant - Variables: TCVL and TCVR

The frequencies of occurrence of the variants of the thenar flexion crease are shown in Table 7.106. For male subjects, BCC patients had a significantly smaller frequency of occurrence of variants other than the normal in comparison to actinic keratosis and vitiligo, on both hands and to alopecia areata and atopic eczema, on the left hand only (see Table 7.107(a)). Male psoriatics were found to have smaller occurrence of normal variant in comparison to vitiligo on both hands and to atopic eczema and alopecia areata on the left hand only. Male controls had a significantly different occurrence of thenar crease variants in comparison to vitiligo (both hands) and to atopic eczema and actinic keratosis (left hands only).

There were no significant differences found for thenar flexion crease variants in female subjects (see Tables 7.106 and 7.107).

(ii) Thenar Flexion Crease Terminus - Variables: TCTL and TCTR

For male subjects, atopic eczema patients were found to have a significantly higher occurrence of separate radial terminus (variant 2) in comparison to controls (both hands) and to psoriasis (left hand only). For females, BCC subjects were found to have a significantly higher occurrence of separate radial terminus of thenar flexion crease in comparison to alopecia areata female patients (see Tables 7.106 and 7.107).

Table 7.104

Percentage Frequencies

Flexion Creases

(a) Sex = Male

Group	Cases	Percentage Frequencies													
		FCL							FCR						
		0	1	2	3	4	5	6	0	1	2	3	4	5	6
Controls	205	97.5	0.0	0.0	1.5	1.0	0.0	0.0	98.5	0.0	0.0	1.0	0.5	0.0	0.0
Psoriasis	201	98.5	0.0	0.0	1.0	0.5	0.0	0.0	98.5	0.5	0.0	1.0	0.0	0.0	0.0
Atop Ecz	203	100.0	0.0	0.0	0.0	0.0	0.0	0.0	100.0	0.0	0.0	0.0	0.0	0.0	0.0
Vitiligo	201	99.5	0.0	0.0	0.5	0.0	0.0	0.0	99.5	0.0	0.0	0.5	0.0	0.0	0.0
Alop Are	210.	99.0	0.0	0.0	0.5	0.0	0.5	0.0	99.0	0.0	0.0	0.0	0.0	1.0	0.0
BCC	211	97.2	0.0	0.5	1.9	0.5	0.0	0.0	97.2	0.0	0.5	1.4	0.5	0.6	0.0
Act Ker	129	100.0	0.0	0.0	0.0	0.0	0.0	0.0	99.2	0.0	0.8	0.0	0.0	0.0	0.0

(b) Sex = Female

Group	Cases	Percentage Frequencies													
		FCL							FCR						
		0	1	2	3	4	5	6	0	1	2	3	4	5	6
Controls	203	98.0	0.0	0.0	1.0	1.0	0.0	0.0	98.5	0.0	0.0	1.0	0.0	0.5	0.0
Psoriasis	205	96.6	0.0	0.0	2.0	1.0	0.5	0.0	95.1	0.0	0.0	3.9	0.5	0.5	0.0
Atop Ecz	203	98.0	0.0	0.0	1.5	0.5	0.0	0.0	99.0	0.0	0.0	0.5	0.0	0.5	0.0
Vitiligo	205	98.5	0.0	0.0	0.0	0.0	1.5	0.0	98.0	0.0	0.0	0.0	0.0	2.0	0.0
Alop Are	206	99.5	0.0	0.0	0.5	0.0	0.0	0.0	99.5	0.0	0.0	0.5	0.0	0.0	0.0
BCC	202	97.5	0.0	0.0	2.0	0.0	0.0	0.5	98.0	0.0	0.0	1.0	0.0	0.5	0.5
Act Ker	174	99.4	0.0	0.0	0.0	0.6	0.0	0.0	100.0	0.0	0.0	0.0	0.0	0.0	0.0

Table 7.105(a)

Mann-Whitney U test Results

Palmar Flexion Creases

Males

Group 1	Group 2	Probability	
		FCL	FCR
Control	Psoriasis	0.04833	0.9984
Control	Atop Ecz	0.0250*	0.0840
Control	Vitiligo	0.1033	0.3215
Control	Alop Are	0.2398	0.6430
Control	BCC	0.8151	0.3385
Control	Act Ker	0.0736	0.5689
Psoriasis	Atop Ecz	0.0817	0.0825
Psoriasis	Vitiligo	0.3167	0.3191
Psoriasis	Alop Are	0.6250	0.6351
Psoriasis	BCC	0.3494	0.3384
Psoriasis	Act Ker	0.1650	0.5670
Atop Ecz	Vitiligo	0.3149	0.3161
Atop Ecz	Alop Are	0.1639	0.1639
Atop Ecz	BCC	0.0156*	0.0159*
Atop Ecz	Act Ker	1.0000	0.2108
Vitiligo	Alop Are	0.5867	0.5819
Vitiligo	BCC	0.0658	0.0656
Vitiligo	Act Ker	0.4231	0.7515
Alop Are	BCC	0.1588	0.1629
Alop Are	Act Ker	0.2670	0.8573
BCC	Act Ker	0.0537	0.1924

Table 7.105(b)

Mann-Whitney U test Results

Palmar Flexion Creases

Females

Group 1	Group 2	Probability	
		FCL	FCR
Control	Psoriasis	0.3641	0.0528
Control	Atop Ecz	0.9944	0.6628
Control	Vitiligo	0.7152	0.7020
Control	Alop Are	0.1710	0.3049
Control	BCC	0.7357	0.6943
Control	Act Ker	0.2402	0.1070
Psoriasis	Atop Ecz	0.3594	0.0221*
Psoriasis	Vitiligo	0.2110	0.1159
Psoriasis	Alop Are	0.0309*	0.0058*
Psoriasis	BCC	0.5652	0.1159
Psoriasis	Act Ker	0.0555	0.0032*
Atop Ecz	Vitiligo	0.7152	0.4206
Atop Ecz	Alop Are	0.1716	0.5436
Atop Ecz	BCC	0.7307	0.4136
Atop Ecz	Act Ker	0.2411	0.1865
Vitiligo	Alop Are	0.3073	0.1713
Vitiligo	BCC	0.4768	0.9888
Vitiligo	Act Ker	0.3924	0.0637
Alop Are	BCC	0.0951	0.1675
Alop Are	Act Ker	0.9018	0.3581
BCC	Act Ker	0.1449	0.0617

Table 7.106

Percentage Frequencies : Thenar Creases

(a) Males

Group	Cases	Percentage Frequencies															
		TCVL						TCVR						TCTL		TCTR	
		0	1	2	3	4	5	0	1	2	3	4	5	1	2	1	2
Controls	206	35.4	0.0	49.5	4.4	5.3	5.3	38.3	0.5	42.7	3.9	7.8	6.8	91.3	8.7	91.3	8.7
Psoriasis	202	40.1	0.5	46.5	5.4	1.0	6.4	37.1	1.0	47.5	6.4	4.5	3.5	90.5	9.5	89.6	10.4
Atop Ecz	203	25.6	0.0	54.2	3.0	3.0	14.3	34.0	0.0	46.8	2.5	2.0	14.8	82.2	17.8	83.7	16.3
Vitiligo	201	21.4	1.0	61.5	5.5	2.0	9.0	21.5	1.0	54.0	9.5	7.0	7.0	87.4	12.5	87.0	13.0
Alop Are	210	27.1	0.5	57.1	3.3	4.8	7.1	31.4	0.0	49.0	7.1	6.2	6.2	88.1	11.9	88.5	11.5
BCC	211	44.5	0.5	41.2	3.3	2.8	7.6	33.6	0.0	54.5	7.1	1.9	2.8	87.7	12.3	88.2	11.8
Act Ker	129	17.8	0.0	66.7	5.4	2.3	7.8	21.7	0.0	62.8	7.8	2.3	5.4	89.1	10.9	86.8	13.2

Percentage Frequencies : Thenar Creases

(b) Females

Group	Cases	Percentage Frequencies															
		TCVL						TCVR						TCTL		TCTR	
		0	1	2	3	4	5	0	1	2	3	4	5	1	2	1	2
Controls	203	27.6	0.0	48.3	5.9	9.9	8.4	27.6	0.0	48.8	3.9	11.3	8.4	82.8	17.2	82.3	17.7
Psoriasis	205	33.7	0.0	46.3	6.3	4.4	9.3	32.7	1.5	46.8	4.9	5.9	8.3	82.8	17.2	83.4	16.6
Atop Ecz	203	27.1	0.0	49.3	3.4	7.9	12.3	32.2	0.0	45.5	4.0	6.4	11.9	82.8	17.2	84.2	15.8
Vitiligo	205	24.4	0.5	55.6	8.3	3.4	7.8	26.8	0.0	55.1	5.4	4.9	7.8	82.8	17.2	82.9	17.1
Alop Are	206	30.1	0.0	52.9	5.8	3.9	7.3	34.5	0.5	47.1	6.8	5.3	5.8	87.7	12.3	87.7	12.3
BCC	202	31.7	0.5	48.5	5.0	4.5	9.9	33.2	0.0	44.6	8.4	7.4	6.4	79.2	20.8	78.7	21.3
Act Ker	174	31.0	0.0	53.4	3.4	5.7	6.3	30.5	0.0	50.0	9.8	1.7	8.0	83.9	16.1	83.8	16.2

Table 7.107(a)

Mann-Whitney U test Results

Palmar Flexion Creases

Males

Group 1	Group 2	Probability			
		TCVL	TCTL	TCVR	TCTR
Control	Psoriasis	0.2806	0.8022	0.6525	0.5695
Control	Atop Ecz	0.0147*	0.0069*	0.2948	0.0215*
Control	Vitiligo	0.0145*	0.2058	0.0028**	0.1677
Control	Alop Are	0.1586	0.2894	0.2500	0.3544
Control	BCC	0.1033	0.2341	0.8881	0.2970
Control	Act Ker	0.0080**	0.5073	0.0530	0.1967
Psoriasis	Atop Ecz	0.0006**	0.0145*	0.1470	0.0832
Psoriasis	Vitiligo	0.0004**	0.3122	0.0002**	0.4171
Psoriasis	Alop Are	0.0123*	0.4221	0.0892	0.7245
Psoriasis	BCC	0.5447	0.3512	0.7351	0.6395
Psoriasis	Act Ker	0.0003**	0.6625	0.0132*	0.4394
Atop Ecz	Vitiligo	0.9037	0.1489	0.0520	0.3558
Atop Ecz	Alop Are	0.2520	0.0913	0.9105	0.1612
Atop Ecz	BCC	0.0001**	0.1182	0.2558	0.1970
Atop Ecz	Act Ker	0.7305	0.0897	0.2996	0.4454
Vitiligo	Alop Are	0.2785	0.8244	0.0554	0.6401
Vitiligo	BCC	0.0000**	0.9260	0.0004**	0.7237
Vitiligo	Act Ker	0.6137	0.6469	0.3091	0.9627
Alop Are	BCC	0.0021**	0.8957	0.1413	0.9073
Alop Are	Act Ker	0.1416	0.7875	0.4067	0.6434
BCC	Act Ker	0.0000**	0.7020	0.0212*	0.7180

Table 7.107(b)

Mann-Whitney U test Results

Palmar Flexion Creases

Females

Group 1	Group 2	Probability			
		TCVL	TCTL	TCVR	TCTR
Control	Psoriasis	0.1639	0.9820	0.1369	0.7586
Control	Atop Ecz	0.8311	1.0000	0.4834	0.5388
Control	Vitiligo	0.7713	1.0000	0.4974	0.8604
Control	Alop Are	0.1774	0.1565	0.0521	0.1220
Control	BCC	0.2371	0.3631	0.2426	0.3675
Control	Act Ker	0.1157	0.7658	0.2820	0.6908
Psoriasis	Atop Ecz	0.1186	0.9820	0.4808	0.7534
Psoriasis	Vitiligo	0.2169	0.9820	0.3589	0.8951
Psoriasis	Alop Are	0.8900	0.1627	0.6748	0.2132
Psoriasis	BCC	0.8289	0.3508	0.7508	0.2265
Psoriasis	Act Ker	0.8786	0.7821	0.6761	0.9167
Atop Ecz	Vitiligo	0.6629	1.0000	0.8896	0.6575
Atop Ecz	Alop Are	0.1350	0.1565	0.2599	0.3648
Atop Ecz	BCC	0.1765	0.3631	0.6781	0.1341
Atop Ecz	Act Ker	0.0852	0.7658	0.7715	0.8430
Vitiligo	Alop Are	0.2432	0.1565	0.1806	0.1690
Vitiligo	BCC	0.2992	0.3631	0.6102	0.2808
Vitiligo	Act Ker	0.1511	0.7658	0.6661	0.8177
Alop Are	BCC	0.9415	0.0207*	0.4496	0.0149*
Alop Are	Act Ker	0.7578	0.2848	0.4159	0.2746
BCC	Act Ker	0.7166	0.2437	0.9669	0.2093

7.6 Palmar Ridge Disturbances

(a) Palmar Ridge Atrophy - Variables: ATRL and ATRR

From Table 7.109(a) it can be seen that there were 17, out of a possible 21, statistically significant differences for male intergroup comparisons using ridge atrophy as the variable. Controls had the least atrophy followed by vitiligo and alopecia areata, in order of increasing atrophy (see Table 7.108). Actinic keratosis males had the greatest atrophy followed by BCC, atopic eczema and psoriasis in order of decreasing atrophy.

For female subjects, again 17 out of 21 comparisons proved to be statistically significantly different (Table 7.109(b)). Controls had the least atrophy followed by vitiligo and alopecia areata as for males (Table 7.108(b)). BCC had the greatest atrophy followed by actinic keratosis, atopic eczema, psoriasis and alopecia areata.

When the groups were regrouped by aetiology highly significant differences were found for all intergroup comparisons (see Table 7.111). For both males and females the highest atrophy was in ND subjects followed by GD and controls had the least atrophy (Table 7.110).

(b) Palmar Hyperlinearity - Variables: HYLP and HYRP

For males, Table 7.113(a) shows that, out of 21 possible differences, there were 17 highly significant statistical differences shown. Table 7.112(a) shows that the greatest amount of hyperlinearity was shown by actinic keratosis followed by BCC and atopic eczema in descending order of hyperlinearity. Control males had the least hyperlinearity and this was highly significantly lower than that for all other groups for both hands.

For females, 19 out of 21 intergroup comparisons showed highly significant differences (Table 7.113(b)). BCC females showed the highest hyperlinearity followed by actinic keratosis and atopic eczema in that order of decreasing hyperlinearity. Control subjects had the least hyperlinearity followed by vitiligo, alopecia areata and psoriasis, in order of increasing hyperlinearity (Table 7.112).

When groups were reclassified according to aetiology of disorder statistically significant differences were found for all of

the intergroup comparisons (Table 7.115). ND subjects had the greatest amount of hyperlinearity (for both males and females) followed by GD and then controls with the smallest degree of hyperlinearity (Table 7.114).

Table 7.108

Percentage Frequencies

Palmar Ridge Atrophy

(a) Males

Group	Cases	Percentage Frequencies							
		ATRL				ATRR			
		0	1	2	3	0	1	2	3
Controls	206	87.9	11.2	1.0	0.0	89.3	8.3	2.4	0.0
Psoriasis	202	69.8	22.3	6.9	1.0	66.8	22.8	8.9	1.5
Atop Ecz	203	48.8	31.0	20.2	0.0	48.3	31.5	20.2	0.0
Vitiligo	201	85.6	12.9	1.5	0.0	85.1	11.4	3.5	0.0
Alop Are	210	84.3	13.3	2.4	0.0	82.4	14.8	2.9	0.0
BCC	211	37.0	37.9	19.9	5.2	35.5	36.0	23.2	5.2
Act Ker	129	36.4	45.7	13.2	4.7	33.3	51.2	11.6	3.9

(b) Females

Group	Cases	Percentage Frequencies							
		ATRL				ATRR			
		0	1	2	3	0	1	2	3
Controls	203	79.8	17.7	2.0	0.5	79.3	18.2	2.5	0.0
Psoriasis	205	48.8	22.0	21.5	7.8	51.7	27.3	12.2	8.8
Atop Ecz	203	46.3	31.0	18.7	3.9	43.8	30.8	21.4	4.0
Vitiligo	205	80.0	17.1	2.4	0.5	77.1	18.5	3.9	0.5
Alop Are	206	61.2	32.5	6.3	0.0	60.2	32.0	7.3	0.5
BCC	202	21.8	37.6	34.2	6.4	21.3	45.5	25.7	7.4
Act Ker	174	42.0	37.9	14.9	5.2	40.8	36.8	17.8	4.6

Table 7.109(a)

Mann-Whitney U Test Results

Palmar Ridge Disturbances

Males

Group 1	Group 2	Probability	
		ATRL	ATRR
Control	Psoriasis	0.0000**	0.0000**
Control	Atop Ecz	0.0000**	0.0000**
Control	Vitiligo	0.4888	0.1998
Control	Alop Are	0.2753	0.0470*
Control	BCC	0.0000**	0.0000**
Control	Act Ker	0.0000**	0.0000**
Psoriasis	Atop Ecz	0.0000**	0.0001**
Psoriasis	Vitiligo	0.0001**	0.0000**
Psoriasis	Alop Are	0.0003**	0.0000**
Psoriasis	BCC	0.0000**	0.0000**
Psoriasis	Act Ker	0.0000**	0.0000**
Atop Ecz	Vitiligo	0.0000**	0.0000**
Atop Ecz	Alop Are	0.0000**	0.0000**
Atop Ecz	BCC	0.0144*	0.0037**
Atop Ecz	Act Ker	0.1130	0.0884
Vitiligo	Alop Are	0.6936	0.4933
Vitiligo	BCC	0.0000**	0.0000**
Vitiligo	Act Ker	0.0000**	0.0000**
Alop Are	BCC	0.0000**	0.0000**
Alop Are	Act Ker	0.0000**	0.0000**
BCC	Act Ker	0.5131	0.2863

Table 7.109(b)

Mann-Whitney U Test Results

Palmar Ridge Disturbances

Females

Group 1	Group 2	Probability	
		ATRL	ATRR
Control	Psoriasis	0.0000**	0.0000**
Control	Atop Ecz	0.0000**	0.0000**
Control	Vitiligo	0.9798	0.5282
Control	Alop Are	0.0000**	0.0000**
Control	BCC	0.0000**	0.0000**
Control	Act Ker	0.0000**	0.0000**
Psoriasis	Atop Ecz	0.6728	0.1891
Psoriasis	Vitiligo	0.0000**	0.0000**
Psoriasis	Alop Are	0.0000**	0.0073**
Psoriasis	BCC	0.0000**	0.0000**
Psoriasis	Act Ker	0.9879	0.1334
Atop Ecz	Vitiligo	0.0000**	0.0000**
Atop Ecz	Alop Are	0.0001**	0.0000**
Atop Ecz	BCC	0.0000**	0.0001**
Atop Ecz	Act Ker	0.6691	0.8821
Vitiligo	Alop Are	0.0000**	0.0003**
Vitiligo	BCC	0.0000**	0.0000**
Vitiligo	Act Ker	0.0000**	0.0000**
Alop Are	BCC	0.0000**	0.0000**
Alop Are	Act Ker	0.0000**	0.0000**
BCC	Act Ker	0.0000**	0.0001**

Table 7.110 - Percentage Frequencies - Palmar Atrophy

Gp	Sex	ATRL				ATRR			
		0	1	2	3	0	1	2	3
Cont	M	87.9	11.2	1.0	0.0	89.3	8.3	2.4	0.0
GD	M	72.2	19.9	7.7	0.2	70.7	20.1	8.8	0.4
ND	M	36.8	40.9	17.4	5.0	34.7	41.8	18.8	4.7
Cont	F	79.8	17.7	2.0	0.5	79.3	18.2	2.5	0.0
GD	F	59.1	25.6	12.2	3.1	58.3	27.1	11.1	3.4
ND	F	31.0	28.0	25.4	5.6	30.2	41.4	22.2	6.1

Table 7.111 - Mann-Whitney U Test Results - Palmar Atrophy

Group 1	Group 2	PROBABILITY	
		ATRL	ATRR
Cont M	GD M	0.0000**	0.0000**
Cont M	ND M	0.0000**	0.0000**
GD M	ND M	0.0000**	0.0000**
Cont F	GD F	0.0000**	0.0000**
Cont F	ND F	0.0000**	0.0000**
GD F	ND F	0.0000**	0.0000**

Table 7.112

Percentage Frequencies

Palmar Hyperlinearity

(a) Males

Group	Cases	Percentage Frequencies							
		HYLP				HYRP			
		0	1	2	3	0	1	2	3
Controls	206	57.3	21.4	16.5	4.9	59.7	21.8	15.0	3.4
Psoriasis	202	25.7	32.2	31.2	10.9	29.7	28.7	29.2	12.4
Atop Ecz	203	18.2	10.8	41.4	29.6	16.7	12.3	40.9	30.0
Vitiligo	201	34.8	45.3	14.9	5.0	35.8	39.3	19.4	5.5
Alop Are	210	32.4	46.7	20.5	0.5	31.9	42.9	23.8	1.4
BCC	211	10.4	17.1	42.7	29.9	12.3	15.6	41.7	30.3
Act Ker	129	1.6	27.1	54.3	17.1	0.8	29.5	49.6	20.2

(b) Females

Group	Cases	Percentage Frequencies							
		HYLP				HYRP			
		0	1	2	3	0	1	2	3
Controls	203	31.5	32.0	27.1	9.4	33.2	29.2	31.2	6.4
Psoriasis	205	9.8	18.0	44.4	27.8	11.7	19.0	41.0	28.3
Atop Ecz	203	9.9	10.8	41.4	37.9	10.3	13.3	39.9	36.5
Vitiligo	205	23.9	45.9	26.3	3.9	22.9	43.4	30.7	2.9
Alop Are	206	18.4	36.9	32.5	12.1	18.4	31.6	40.8	9.2
BCC	202	1.0	12.9	31.2	55.0	2.0	12.4	30.7	55.0
Act Ker	174	2.9	25.9	44.3	27.0	2.9	24.1	44.8	28.2

Table 7.113(a)

Mann-Whitney U Test Results

Palmar Ridge Disturbances

Males

Group 1	Group 2	Probability	
		HYLP	HYRP
Control	Psoriasis	0.0000**	0.0000**
Control	Atop Ecz	0.0000**	0.0000**
Control	Vitiligo	0.0013**	0.0000**
Control	Alop Are	0.0005**	0.0000**
Control	BCC	0.0000**	0.0000**
Control	Act Ker	0.0000**	0.0000**
Psoriasis	Atop Ecz	0.0000**	0.0000**
Psoriasis	Vitiligo	0.0001**	0.0033**
Psoriasis	Alop Are	0.0001**	0.0047**
Psoriasis	BCC	0.0000**	0.0000**
Psoriasis	Act Ker	0.0000**	0.0000**
Atop Ecz	Vitiligo	0.0000**	0.0000**
Atop Ecz	Alop Are	0.0000**	0.0000**
Atop Ecz	BCC	0.5387	0.7000
Atop Ecz	Act Ker	0.5310	0.650
Vitiligo	Alop Are	0.7484	0.6883
Vitiligo	BCC	0.0000**	0.0000**
Vitiligo	Act Ker	0.0000**	0.0000**
Alop Are	BCC	0.0000**	0.0000**
Alop Are	Act Ker	0.0000**	0.0000**
BCC	Act Ker	0.2101	0.3733

Table 7.113(b)

Mann-Whitney U Test Results

Palmar Ridge Disturbances

Females

Group 1	Group 2	Probability	
		HYLP	HYRP
Control	Psoriasis	0.0000**	0.0000**
Control	Atop Ecz	0.0000**	0.0000**
Control	Vitiligo	0.8808	0.6230
Control	Alop Are	0.0096**	0.0012**
Control	BCC	0.0000**	0.0000**
Control	Act Ker	0.0000**	0.0000**
Psoriasis	Atop Ecz	0.0291*	0.0565*
Psoriasis	Vitiligo	0.0000**	0.0000**
Psoriasis	Alop Are	0.0000**	0.0000**
Psoriasis	BCC	0.0000**	0.0000**
Psoriasis	Act Ker	0.8920	0.3875
Atop Ecz	Vitiligo	0.0000**	0.0000**
Atop Ecz	Alop Are	0.0000**	0.0000**
Atop Ecz	BCC	0.0004**	0.0001**
Atop Ecz	Act Ker	0.0416*	0.2577
Vitiligo	Alop Are	0.0019**	0.0014**
Vitiligo	BCC	0.0000**	0.0000**
Vitiligo	Act Ker	0.0000**	0.0000**
Alop Are	BCC	0.0000**	0.0000**
Alop Are	Act Ker	0.0000**	0.0000**
BCC	Act Ker	0.0000**	0.0000**

Table 7.114 - Percentage Frequencies - Palmar Hyperlinearity

Gp	Sex	HYLP				HYRP			
		0	1	2	3	0	1	2	3
Cont	M	57.5	21.4	16.5	4.9	59.7	21.8	15.0	3.4
GD	M	27.8	33.8	27.0	11.4	28.6	30.9	28.3	12.3
ND	M	7.1	20.9	47.1	25.0	7.9	20.9	44.7	26.5
Cont	F	31.5	32.0	27.1	9.4	33.2	29.2	31.2	6.4
GD	F	15.5	28.0	36.1	20.4	15.9	26.9	38.1	19.2
ND	F	1.9	19.0	37.2	42.0	2.4	17.6	37.2	42.8

Table 7.115 - Mann-Whitney U Test Results - Palmar Hyperlinearity

Group 1	Group 2	PROBABILITY	
		HYLP	HYRP
Cont M	GD M	0.0000**	0.0000**
Cont M	ND M	0.0000**	0.0000**
GD M	ND M	0.0000**	0.0000**
Cont F	GD F	0.0000**	0.0000**
Cont F	ND F	0.0000**	0.0000**
GD F	ND F	0.0000**	0.0000**

CHAPTER EIGHT - RESULTS: PART THREE - SMALLER STUDIES OF RARE DISORDERS

8.1 Introduction

In this chapter the results of the three smaller studies, with sample groups containing smaller numbers because of the relative rarity of the disorders, are reported. The three studies are: Dermatitis Herpetiformis (DH) and Coeliac Disease; Incontinentia Pigmenti (IP) and Anhidrotic Ectodermal Dysplasia (AED); and Darriers Disease. The last two are family studies.

For each study the results are presented in the same format as for the last two chapters with the results for the various groups of variables for the fingers shown first followed by those for the palms.

8.2 Dermatitis Herpetiformis and Coeliac Disease

(a) Finger Patterns

(i) Finger Pattern Types: Variables: LP1 to RP5

From Table 8.3 it can be seen that there are no statistically significant differences between Dermatitis Herpetiformis patients and controls of either sex for percentage frequency of occurrence of finger pattern types.

When controls and Coeliac patients were compared statistically significant differences were found for finger III on the right hand in both sexes and finger III on both hands in females. A highly significant difference was also found for finger V of the right hand in male controls compared to male Coeliacs. Male controls had a higher frequency of occurrence of whorls and ulnar central pocket loops (Table 8.1b). When male DH patients were compared to Coeliacs significant differences were discovered for fingers III, IV and V of the right hand. A highly significant difference was found for finger V of the left hand for female DH patients compared to Coeliac probands.

Discriminant analysis was carried out using these variables and the results are shown in Tables 8.4 to 8.7 for male subjects. The groups used in the analysis were controls (group 1), DH subjects (group 2), Coeliacs (group 3) and Coeliac unaffected relatives (group 4). Three canonical discriminant functions were produced with Function 1 accounting for 64.38% of the variance (Table 8.4). The structure matrix shows that patterns on fingers II and IV of the right hand are

the most important in Function 1 (Table 8.5). The Table of F statistics shows that the best separated groups were found to be DH and Coeliacs ($F = 2.878$, significance = 0.0066). The territorial map (Figure 8.1) and the scatterplots (Figure 8.2) shows that using Functions 1 and 2 the Coeliac patients were removed from the other groups with controls and unaffected relatives being adjacent in a horizontal direction and Coeliac relatives and DH being next to each other in a vertical direction. The Table of Classification results (Table 8.7) shows 46.21% correct grouping. The best classified groups were found to be Coeliacs (77.8%) and controls 48% correct.

Discriminant analysis for females using variables LP1 to RP5 produced three canonical discriminant functions (Table 8.8) with Function 1 accounting for 57.08% of the variance. LP2 was found to be the most important variable in Function 1 with LP5, RP5, RP4 and LP4 being the most important variables in Function 2 (Table 8.9). The Table of F statistics shows the most separated groups to be controls (1) and DH (2) with F statistics = 2.6781 and significance = 0.0222 (see Table 8.10). The territorial map (Figure 8.3) and the scatterplots (Figure 8.4) show that Coeliac relatives are separated from the other three groups with Coeliacs being closest. Controls and DH are below with DH being removed to the right. Classification results (Table 8.11) show that 47.31% of grouped cases were correctly classified. The best groups were found to be controls (53% correct) and unaffected Coeliac relatives (50% correct).

Table 8.1(a)
Percentage Frequencies

Finger Patterns

Males : Left Hand

		Percentage Frequencies for Categories									
Var	Group	0	1	2	3	4	5	6	7	8	9
	DH	0.0	0.0	72.9	0.0	12.5	14.6	0.0	0.0	0.0	0.0
LP1	Coel	0.0	0.0	55.6	0.0	44.4	0.0	0.0	0.0	0.0	0.0
	Cont	1.9	0.0	59.2	0.0	21.8	16.0	0.0	0.0	1.0	0.0
	DH	6.3	0.0	35.4	37.5	16.7	2.1	0.0	0.0	2.1	0.0
LP2	Coel	22.2	0.0	22.2	11.1	44.4	0.0	0.0	0.0	0.0	0.0
	Cont	3.9	1.5	44.7	19.4	22.8	3.9	0.0	0.0	1.9	1.9
	DH	2.1	0.0	81.3	0.0	12.5	2.1	0.0	0.0	2.1	0.0
LP3	Coel	11.1	0.0	77.8	11.1	0.0	0.0	0.0	0.0	0.0	0.0
	Cont	2.9	1.0	79.6	1.5	12.1	1.9	0.0	0.0	0.5	0.5
	DH	0.0	0.0	64.6	0.0	27.1	2.1	0.0	0.0	6.3	0.0
LP4	Coel	11.1	0.0	77.8	0.0	0.0	0.0	0.0	0.0	11.1	0.0
	Cont	2.4	0.0	56.3	0.5	26.7	1.5	0.0	0.5	11.7	0.5
	DH	0.0	0.0	93.8	0.0	6.3	0.0	0.0	0.0	0.0	0.0
LP5	Coel	0.0	0.0	88.9	0.0	0.0	11.1	0.0	0.0	0.0	0.0
	Cont	1.0	0.0	83.0	0.5	8.7	1.0	0.0	0.0	5.8	0.0

Group	n
DH	48
Coeliacs	10
Controls	206

Table 8.1(b)

Percentage Frequencies

Finger Patterns

Males : Right Hand

		Percentage Frequencies for Categories									
Var	Group	0	1	2	3	4	5	6	7	8	9
	DH	0.0	0.0	66.7	0.0	16.7	16.7	0.0	0.0	0.0	0.0
RP1	Coel	0.0	0.0	33.3	0.0	33.3	33.3	0.0	0.0	0.0	0.0
	Cont	0.5	0.0	52.9	0.0	27.2	18.4	0.0	0.0	1.0	0.0
	DH	4.2	2.1	33.3	29.2	25.0	4.2	0.0	0.0	0.0	2.1
RP2	Coel	22.2	0.0	11.1	11.1	33.3	0.0	0.0	0.0	11.1	11.1
	Cont	4.4	1.5	38.8	18.4	26.7	3.4	0.0	0.0	1.0	5.8
	DH	2.1	0.0	81.3	0.0	14.6	0.0	0.0	0.0	2.1	0.0
RP3	Coel	22.2	0.0	77.8	0.0	0.0	0.0	0.0	0.0	0.0	0.0
	Cont	2.4	1.0	75.7	1.5	15.5	1.5	0.0	0.0	2.4	0.0
	DH	0.0	0.0	43.8	0.0	31.3	4.2	0.0	0.0	20.8	0.0
RP4	Coel	22.2	0.0	44.4	0.0	33.3	0.0	0.0	0.0	0.0	0.0
	Cont	0.5	0.0	51.5	0.5	37.4	1.5	0.0	0.0	8.3	0.5
	DH	0.0	0.0	81.3	0.0	6.3	0.0	0.0	0.0	12.5	0.0
RP5	Coel	22.2	0.0	77.8	0.0	0.0	0.0	0.0	0.0	0.0	0.0
	Cont	1.0	0.0	77.7	0.0	10.7	0.5	0.0	0.0	10.2	0.0

Group	n
DH	48
Coeliacs	10
Controls	206

Table 8.2(a)

Percentage Frequencies

Finger Patterns

Females : Left Hand

		Percentage Frequencies for Categories									
Var	Group	0	1	2	3	4	5	6	7	8	9
	DH	3.6	0.0	71.4	0.0	7.1	17.9	0.0	0.0	0.0	0.0
LPL1	Coel	0.0	0.0	76.9	3.8	19.2	0.0	0.0	0.0	0.0	0.0
	Cont	4.9	0.0	65.0	0.0	14.3	13.3	0.0	0.0	2.5	0.0
	DH	0.0	0.0	53.6	14.3	14.3	3.6	0.0	0.0	0.0	10.7
LP2	Coel	7.7	3.8	38.5	15.4	23.1	3.8	0.0	0.0	0.0	7.7
	Cont	8.4	0.0	48.8	19.2	5.3	3.0	0.0	0.0	3.0	2.5
	DH	3.6	0.0	96.4	0.0	0.0	0.0	0.0	0.0	0.0	0.0
LP3	Coel	7.7	0.0	61.5	3.8	26.9	0.0	0.0	0.0	0.0	0.0
	Cont	3.9	0.5	84.7	1.0	8.9	0.5	0.0	0.0	0.5	0.0
	DH	0.0	0.0	71.4	0.0	14.3	0.0	0.0	0.0	14.3	0.0
LP4	Coel	3.8	0.0	50.0	0.0	46.2	0.0	0.0	0.0	0.0	0.0
	Cont	2.0	0.0	68.5	0.5	17.2	1.5	0.0	0.0	10.3	0.0
	DH	0.0	0.0	85.7	0.0	7.1	0.0	0.0	0.0	7.1	0.0
LP5	Coel	0.0	0.0	69.2	0.0	26.9	3.8	0.0	0.0	0.0	0.0
	Cont	1.5	0.0	89.7	0.0	5.4	2.0	0.0	0.0	1.5	0.0

Group	n
DH	28
Coeliacs	26
Controls	203

Table 8.2(b)

Percentage Frequencies

Finger Patterns

Females : Right Hand

Var	Group	Percentage Frequencies for Categories									
		0	1	2	3	4	5	6	7	8	9
	DH	3.6	0.0	67.9	0.0	3.6	25.0	0.0	0.0	0.0	0.0
RP1	Coel	0.0	0.0	73.1	3.8	15.4	7.7	0.0	0.0	0.0	0.0
	Cont	3.0	0.0	65.5	0.0	12.8	14.8	0.0	0.0	3.9	0.0
	DH	3.6	0.0	35.7	39.3	14.3	3.6	0.0	0.0	0.0	3.6
RP2	Coel	3.8	0.0	38.5	19.2	23.1	3.8	0.0	0.0	7.7	3.8
	Cont	4.4	2.0	48.8	16.3	17.7	3.0	0.0	0.0	4.9	1.0
	DH	7.1	0.0	92.9	0.0	0.0	0.0	0.0	0.0	0.0	0.0
RP3	Coel	3.8	0.0	76.9	3.8	7.7	0.0	0.0	0.0	7.7	0.0
	Cont	5.9	0.0	84.2	0.5	7.4	1.0	0.0	0.0	0.5	0.0
	DH	0.0	0.0	78.6	0.0	14.3	0.0	0.0	0.0	7.1	0.0
RP4	Coel	0.0	0.0	50.0	0.0	42.3	0.0	0.0	0.0	7.7	0.0
	Cont	3.0	0.5	65.0	0.5	22.2	1.0	0.5	0.0	6.4	0.0
	DH	0.0	0.0	85.7	0.0	10.7	0.0	0.0	0.0	3.6	0.0
RP5	Coel	0.0	0.0	76.9	0.0	19.2	0.0	0.0	0.0	3.8	0.0
	Cont	3.9	0.0	85.2	0.0	4.4	0.5	0.0	0.0	5.4	0.0

Group	n
DH	28
Coeliacs	26
Controls	203

Table 8.4 - Canonical Discriminant Functions - Males LP1 to RP5

FUNCTION	EIGENVALUE	PERCENT OF VARIANCE	CUMULATIVE PERCENT	CANONICAL CORRELATION
1*	0.09332	64.38	64.38	0.2928764
2*	0.03531	24.23	88.60	0.1846639
3*	0.01661	11.40	100.00	0.1278333

Table 8.5 - Structure Matrix - Males LP1 to RP5

	FUNC 1	FUNC 2	FUNC 3
RP4	0.50996*	0.04701	0.05574
RP2	-0.26521*	0.05764	-0.02102
RP3	0.16106	0.53679*	0.15318
LP4	0.03053	0.51478*	0.45239
LP5	-0.22594	0.50398*	0.18682
RP5	0.15561	0.36901*	0.03278
RP1	-0.34066	0.05716	0.51763*
LP1	-0.13345	0.15057	0.43924*
LP3	0.27593	0.18809	0.31425*
LP2	-0.02950	0.13143	0.14822*

Table 8.6 - F Statistics and significances between groups

GROUP	GROUP	1	2	3
2		2.3438 0.0246		
3		2.0207 0.0530	2.8780 0.0066	
4		0.79216 0.5945	0.64984 0.7144	1.7986 0.0879
Code	Group			
1	Controls			
2	DI			
3	Coeliacs			
4	Coeliac unaffected relatives			

Figure 8.1 - Territorial Map - Males: LP1 to RP5

Code	Group
1	Controls
2	DII
3	Coelias
4	Coeliac unaffected relatives

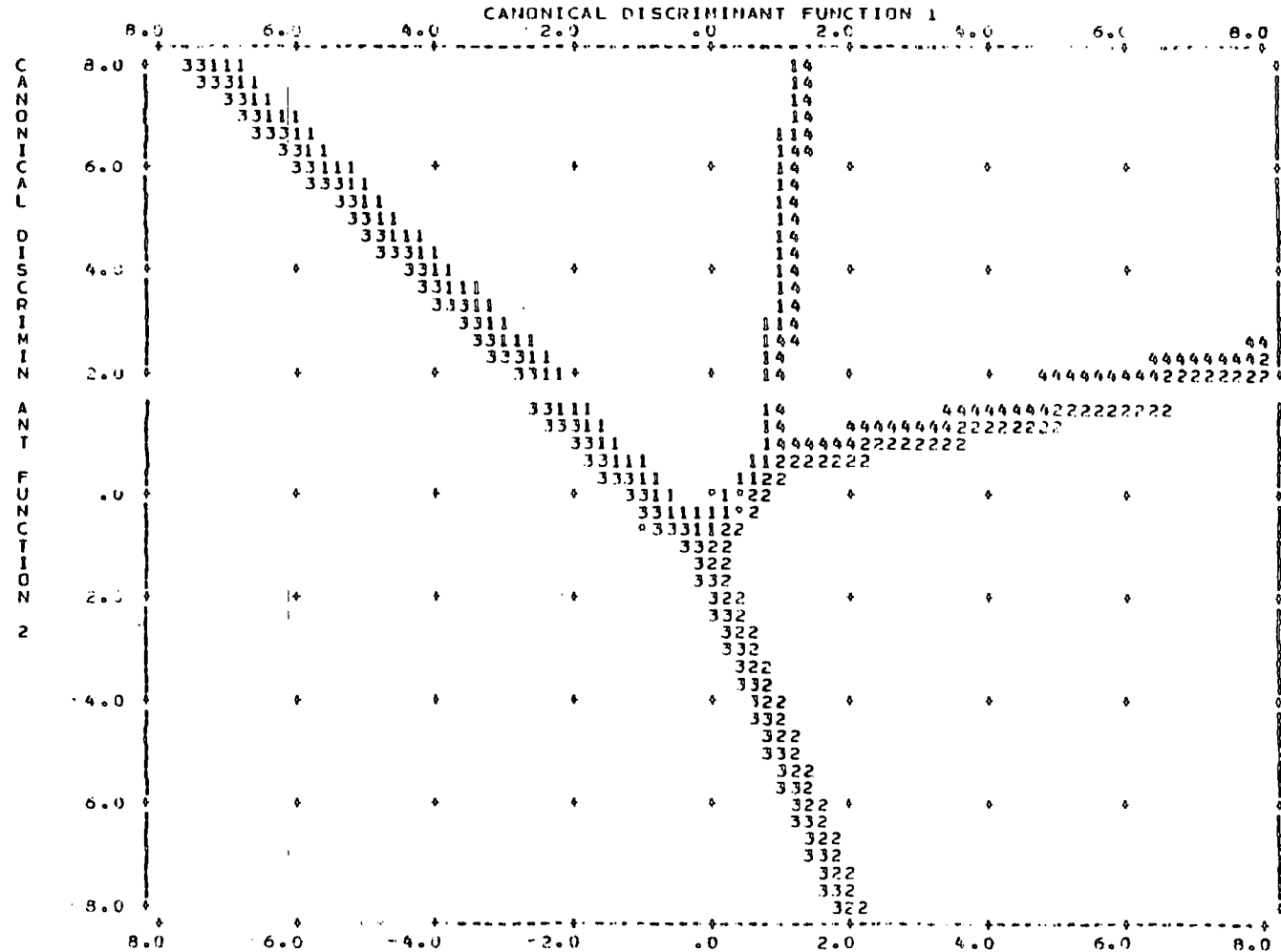

Figure 8.2 - Individual Group - Scatterplots - Males: LP1 to RP5

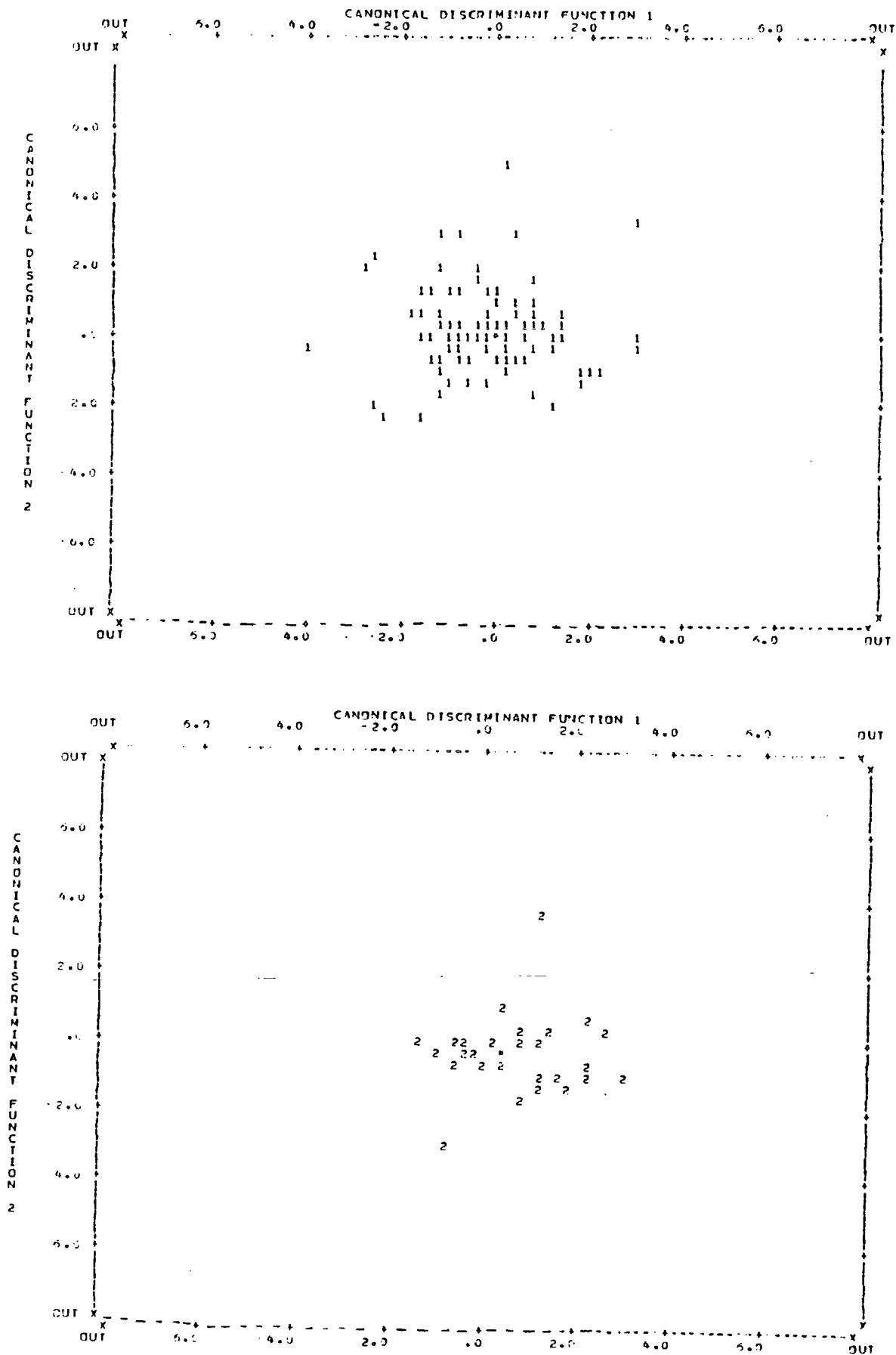

Figure 8.2 continued

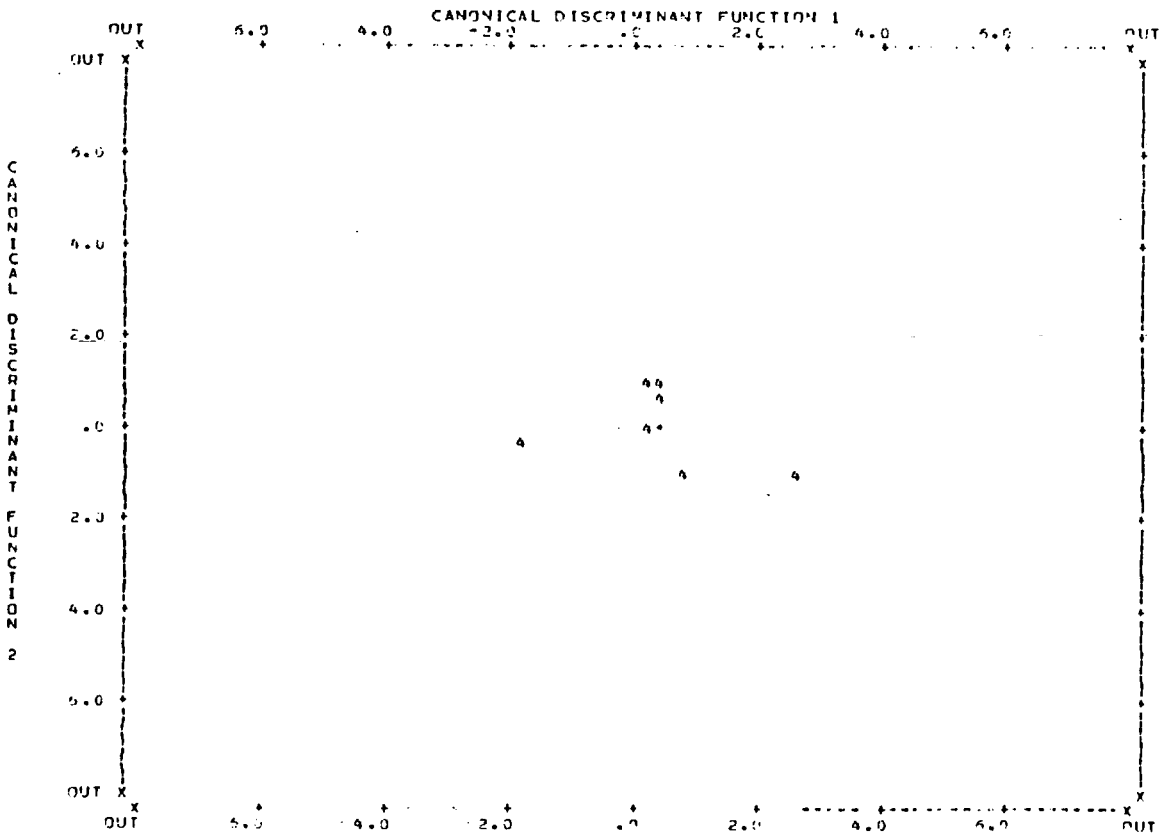
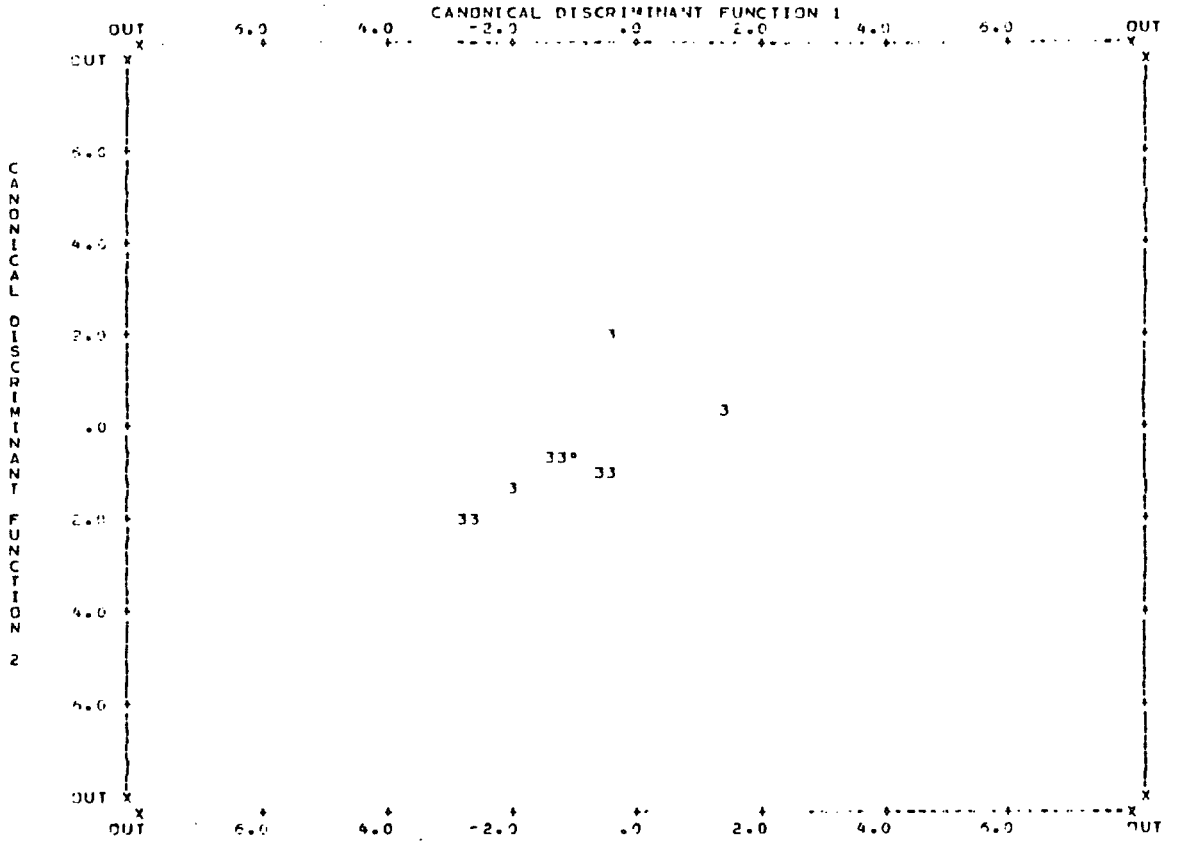

Table 8.7 - Males: LP1 to RP5

Code	Group
1	Controls
2	DI
3	Coeliac
4	Coeliac unaffected relatives

CLASSIFICATION RESULTS

ACTUAL GROUP	NO. OF CASES	PREDICTED GROUP MEMBERSHIP			
		1	2	3	4
GROUP 1	200	96 48.0%	27 13.5%	35 17.5%	42 21.0%
GROUP 2	48	15 31.3%	17 35.4%	4 8.3%	12 25.0%
GROUP 3	9	1 11.1%	0 0.0%	7 77.8%	1 11.1%
GROUP 4	7	2 28.6%	2 28.6%	1 14.3%	2 28.6%

PERCENT OF "GROUPED" CASES CORRECTLY CLASSIFIED: 46.21%

Table 8.8 - Canonical Discriminant Functions - Females: LP1 to RP5

FUNCTION	EIGENVALUE	PERCENT OF VARIANCE	CUMULATIVE PERCENT	CANONICAL CORRELATION
1*	0.05725	57.08	57.08	0.2327103
2*	0.02996	29.87	86.95	0.1705619
3*	0.01309	13.05	100.00	0.1136605

Table 8.9 - Structure Matrix - Females: LP1 to RP5

	FUNC 1	FUNC 2	FUNC 3
LP2	0.70192*	0.05789	0.10566
LP5	0.48225	0.52938*	0.37041
RP5	-0.01718	0.43399*	0.07844
RP4	-0.20714	0.35391*	-0.16458
LP4	-0.01772	0.28811*	0.17913
RP3	0.12767	0.26291*	0.12559
LP3	-0.25655	0.50468	0.73733*
LP1	0.00651	-0.54999	0.54695*
RP1	0.05743	-0.13303	0.36116*
RP2	-0.12472	0.11198	0.20621*

Table 8.10 - F Statistics and significances - Females: LP1 to RP5

GROUP	GROUP	1	2	3
2		2.6781 0.0222		
3		1.4638 0.2022	1.7402 0.1259	
4		0.94514 0.4523	1.5620 0.1714	0.86823 0.5030

Code	Group
1	Controls
2	DII
3	Coelinas
4	Coelina unaffected relatives

Figure 8.3 - Territorial Map - Females: LP1 to RP5

Code	Group
1	Controls
2	DH
3	Coelinas
4	Coelina unaffected relatives

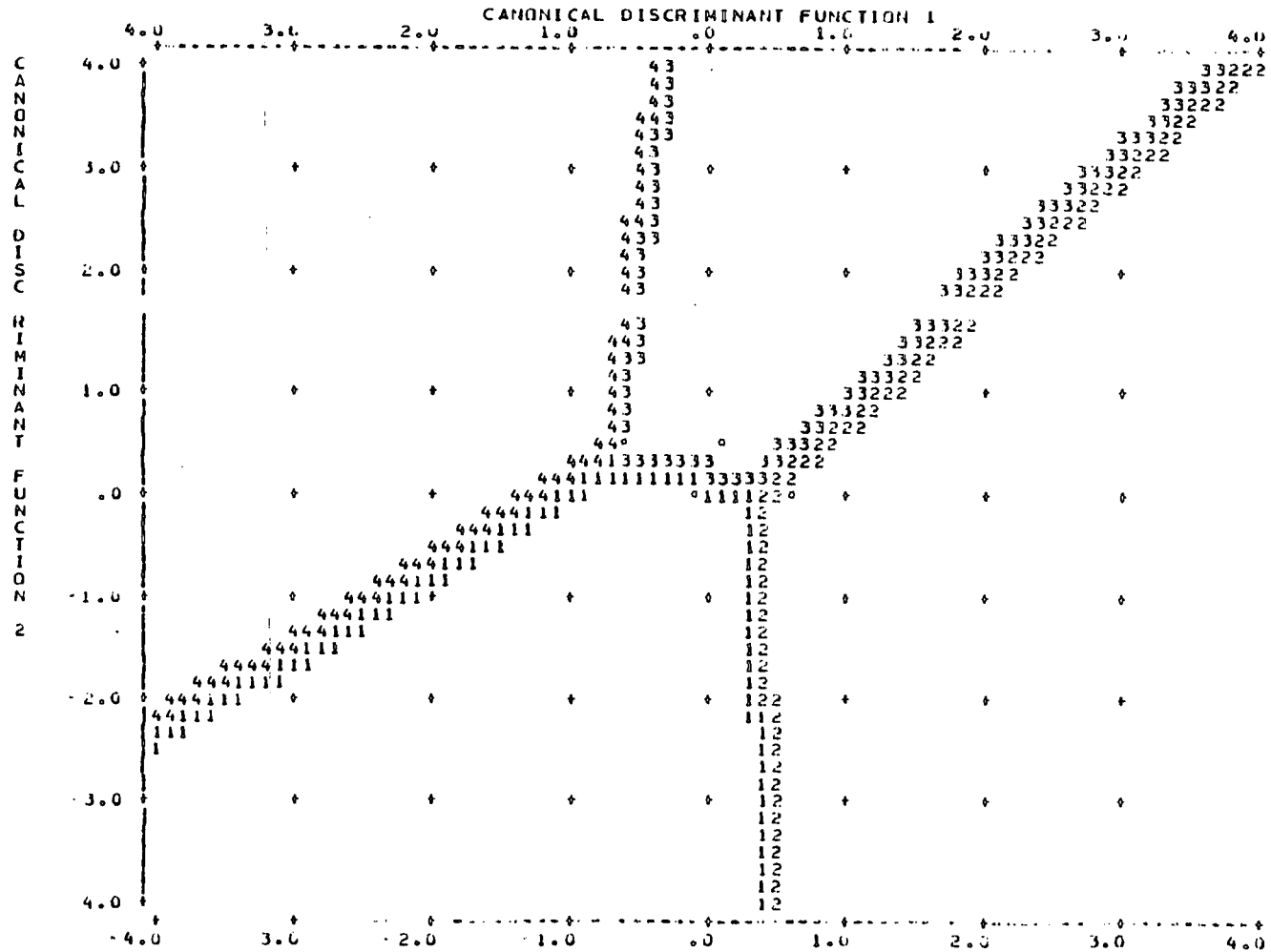

Figure 8.4 - Individual Group Scatterplots - Females: LP1 to RP5

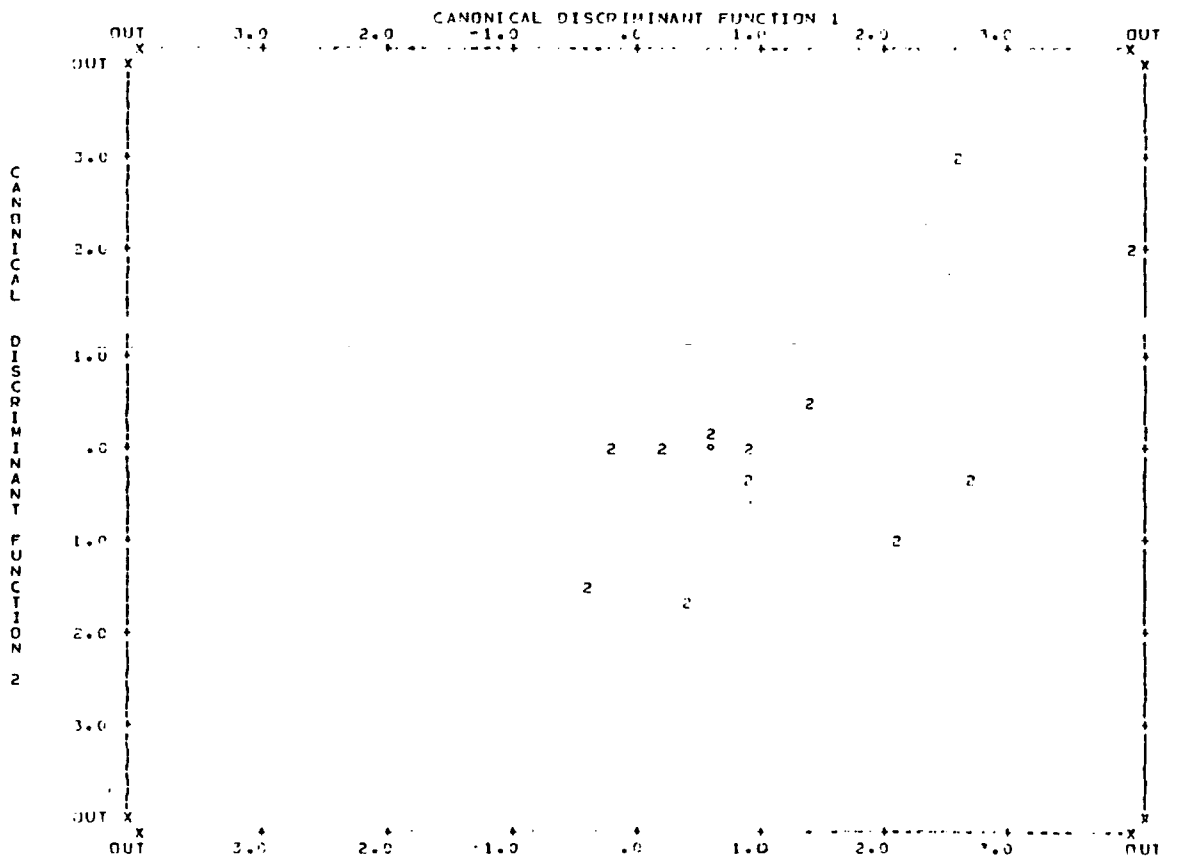
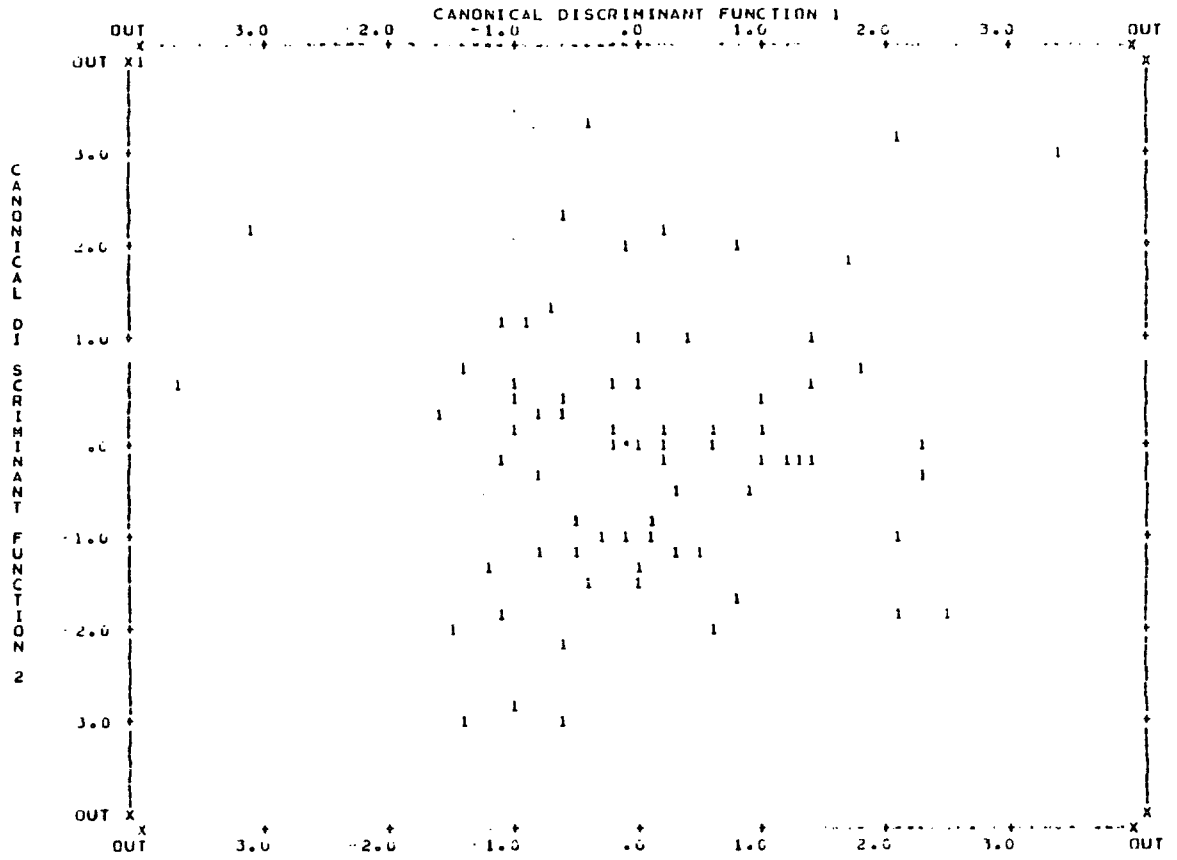

Figure 8.4 continued

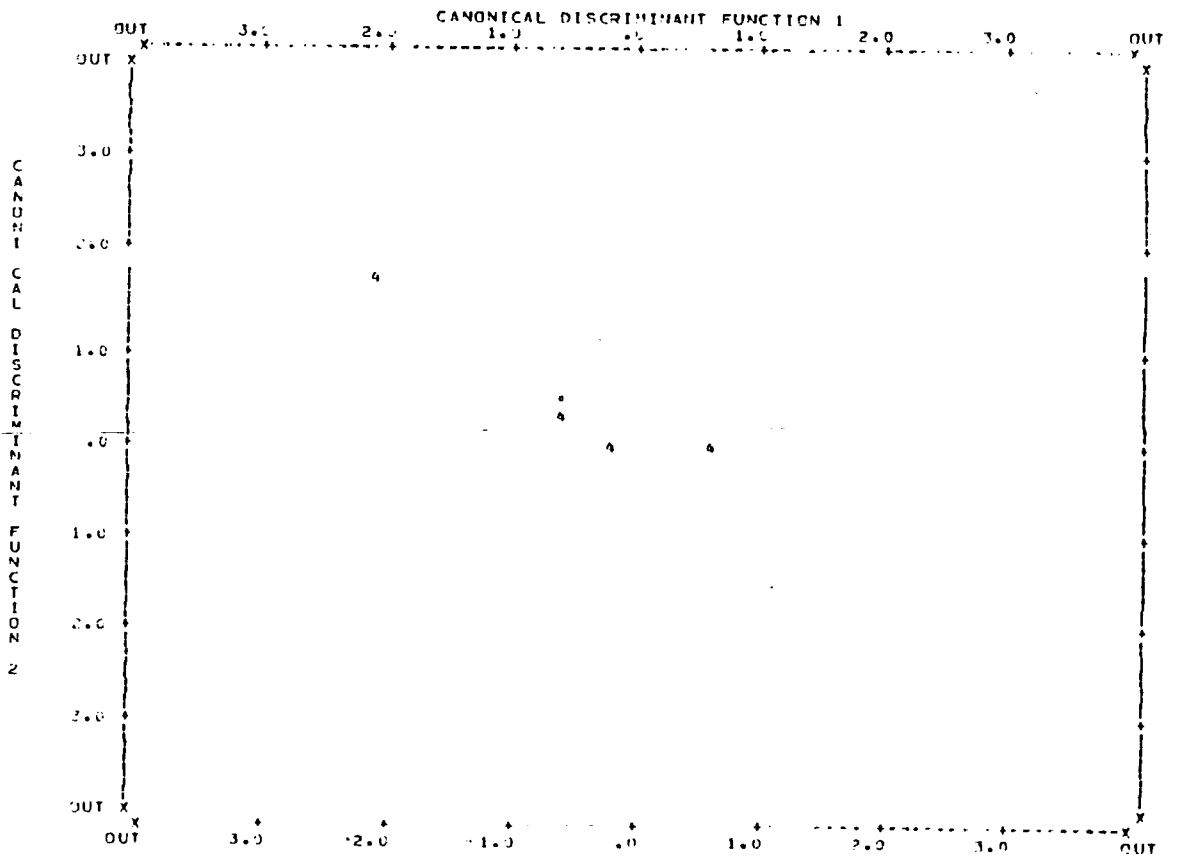
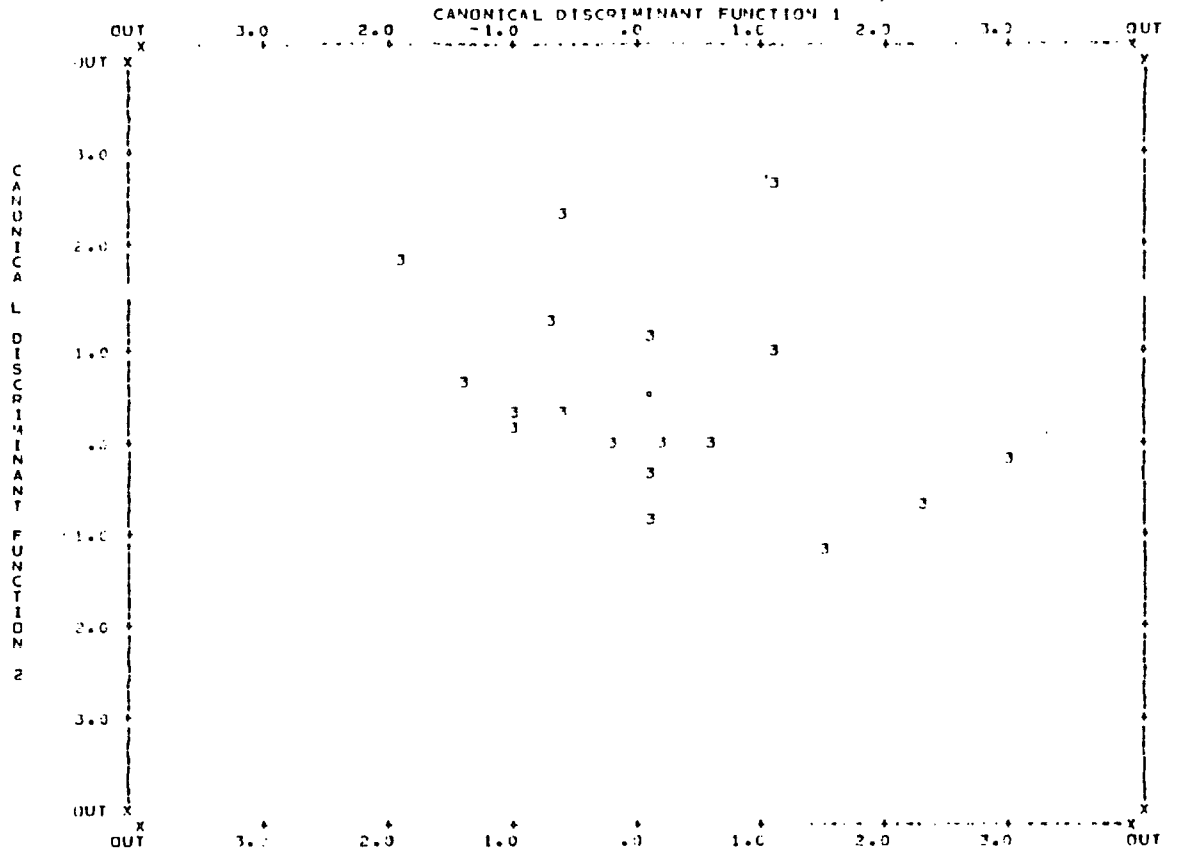

Table 8.11 - Females: LP1 to RP5

Code	Group
1	Controls
2	DM
3	Celiac
4	Celiac unaffected relatives

CLASSIFICATION RESULTS

ACTUAL GROUP	NO. OF CASES	PREDICTED GROUP MEMBERSHIP			
		1	2	3	4
GROUP 1	202	107 53.0%	34 16.8%	20 9.9%	41 20.3%
GROUP 2	28	19 67.9%	7 25.0%	1 3.6%	1 3.6%
GROUP 3	26	10 38.5%	5 19.2%	7 26.9%	4 15.4%
GROUP 4	4	1 25.0%	1 25.0%	0 0.0%	2 50.0%

PERCENT OF "GROUPED" CASES CORRECTLY CLASSIFIED: 47.31%

Table 8.3 - Mann-Whitney U Test Results: Individual Finger Patterns

(a) MALES

PROBABILITY			
VARIABLE	CONT : DH	CONT : COELS	DH : COELS
LP1	0.2415	0.9402	0.5227
LP2	0.9578	0.9186	0.8728
LP3	0.7536	0.3577	0.3087
LP4	0.4754	0.0723	0.1085
LP5	0.1074	0.7668	0.5531
RP1	0.1561	0.2204	0.0696
RP2	0.8051	0.5708	0.4354
RP3	0.6039	0.0164*	0.0228*
RP4	0.0993	0.0968	0.0388*
RP5	0.8037	0.0083**	0.0114*

(b) FEMALES

PROBABILITY			
VARIABLE	CONT : DH	CONT : COELS	DH : COELS
LP1	0.7704	0.7697	0.4657
LP2	0.2275	0.7069	0.4713
LP3	0.1700	0.0218*	0.0506
LP4	0.8710	0.5475	0.3345
LP5	0.2679	0.2054	0.0015**
RP1	0.8593	0.7713	0.5622
RP2	0.4505	0.5752	0.2067
RP3	0.1485	0.0310*	0.1641
RP4	0.4756	0.0457*	0.0737
RP5	0.3807	0.4267	0.0626

(ii) Ulnar and Radial Loop Scores: Variables: RPR1 to LPU5

Male control subjects were found to have a highly significantly larger frequency of occurrence of ulnar loops in comparison to male DH patients on finger II of the left hand (see Tables 8.12 and 8.14). Female Coeliacs were found to have a significantly higher occurrence of ulnar loops on right hand finger II (Tables 8.13 and 8.14).

Male control subjects were found to have a significantly higher occurrence of ulnar loops in comparison to Coeliac males on R1, RIII and LIII, RIV and RV (Tables 8.12 and 8.14). DH male subjects were found to have a significantly higher ulnar loop occurrence compared to Coeliac males on RIII, and LIII, RIV and LIV and RV.

Female Coeliacs were found to have significantly higher radial loop occurrence on LIII, RIV and LV in comparison to controls (Tables 8.13 and 8.14). Female Coeliacs were also found to have significantly higher radial loop occurrence on LIII and RIII, and on RIV in comparison to DH female patients.

When discriminant analysis was carried out for males three canonical discriminant functions were produced with Function 1 accounting for 53.27% of the variance and Function 2 accounting for a further 25.38% (Table 8.15). The most important variables in Function 1 were RPU5, RPU4, RPR1 and LPU1 in that order (Table 8.16). The Table of F statistics showed that DH and Coeliacs ($F = 4.3152$) followed by controls and Coeliacs ($F = 3.8218$) were the most widely separated pairs of groups (Table 8.17). This is shown in the territorial map (Figure 8.5) and in the individual group scatterplots (Figure 8.6). The centroids for controls and unaffected relatives are adjacent to one another with DH males to the right and Coeliacs to the left in the scatterplots. Classification results (Table 8.18) show 53.23% correctly grouped cases. DH males were the best correctly classified (64.6%) followed by Coeliac relatives (57.1%), Coeliac patients (55.6%) and controls (50.3%) in that order.

Discriminant analysis for female subjects showed that three canonical discriminant functions were produced (Table 8.19).

Table 8.12

Percentage Frequencies

Ulnar & Radial Loop Scores

Males

(a) Right Hand

		Percentage Frequencies													
		RPR1		RPU1		RPR2			RPU2			RPR3		RPU3	
Group	n	0	1	0	1	0	1	2	0	1	2	0	1	0	1
DH	48	66.7	33.3	4.2	95.8	39.6	60.4	0.0	32.6	67.4	0.0	83.3	16.7	2.1	97.9
Coeliacs	10	33.3	66.7	22.2	77.8	33.3	66.7	0.0	14.3	85.7	0.0	100.0	0.0	22.2	77.8
Controls	206	53.4	46.6	4.4	95.6	44.4	55.6	0.0	20.9	79.1	0.0	79.0	21.0	4.9	95.1

		Percentage Frequencies							
		RPR4		RPU4		RPR5		RPU5	
Group	n	0	1	0	1	0	1	0	1
DH	48	43.8	56.3	0.0	100.0	81.3	18.8	0.0	100.0
Coeliacs	10	66.7	33.3	22.2	77.8	100.0	0.0	22.2	77.8
Controls	206	51.7	48.3	1.0	99.0	78.5	21.5	1.0	99.0

Table 8.12 continued

(b) Left Hand

		Percentage Frequencies													
		LPR1		LPU1		LPR2			LPU2			LPR3		LPU3	
Group	n	0	1	0	1	0	1	2	0	1	2	0	1	0	1
DH	48	72.9	27.1	0.0	100.0	41.7	58.3	0.0	43.8	56.3	0.0	83.3	16.7	2.1	97.9
Coeliacs	10	55.6	44.4	0.0	100.0	44.4	55.6	0.0	33.3	66.7	0.0	88.9	11.1	22.2	77.8
Controls	206	61.2	38.8	1.9	98.1	50.0	50.0	0.0	24.8	75.2	0.0	83.5	16.5	5.3	94.7

		Percentage Frequencies									
		LPR4		LPU4		LPR5		LPU5		LPU5	
Group	n	0	1	2	0	1	0	1	0	1	
DH	48	64.6	35.4	0.0	0.0	100.0	93.8	6.3	0.0	100.0	
Coeliacs	10	88.9	11.1	0.0	11.1	88.9	88.9	11.1	0.0	100.0	
Controls	206	58.7	40.8	0.5	3.4	96.6	84.0	16.0	1.5	98.5	

Table 8.13

Percentage Frequencies

Ulnar & Radial Loop Scores

Females

(a) Right Hand

		Percentage Frequencies													
		RPR1		RPU1		RPR2			RPU2			RPR3		RPU3	
Group	n	0	1	0	1	0	1	2	0	1	2	0	1	0	1
DH	28	71.4	28.6	7.1	92.9	39.3	60.7	0.0	40.7	59.3	0.0	100.0	0.0	7.1	92.9
Coeliacs	25	73.1	26.9	7.7	92.3	42.3	57.7	0.0	20.0	80.0	0.0	80.8	19.2	7.7	92.3
Controls	203	68.5	31.5	6.4	93.6	55.7	43.8	0.5	19.3	80.2	0.5	90.6	9.4	6.4	93.6

		Percentage Frequencies									
		RPR4		RPU4			RPR5		RPU5		
Group	n	0	1	0	1	2	0	1	0	1	
DH	28	78.6	21.4	0.0	100.0	0.0	85.7	14.3	0.0	100.0	
Coeliacs	26	50.0	50.0	0.0	100.0	0.0	76.9	23.1	0.0	100.0	
Controls	203	69.7	30.3	4.0	95.5	0.5	89.6	10.4	4.0	96.0	

Table 8.13 continued

(b) Left Hand

		Percentage Frequencies													
		LPR1		LPU1		LPR2			LPR2			LPR3		LPU3	
Group	n	0	1	0	1	0	1	2	0	1	2	0	1	0	1
DH	28	75.0	25.0	3.6	96.4	53.6	42.9	3.6	14.3	85.7	0.0	100.0	0.0	3.6	96.4
Coeliacs	25	76.9	23.1	3.8	96.2	50.0	50.0	0.0	26.9	73.1	0.0	69.2	30.8	11.5	88.5
Controls	203	70.0	30.0	4.9	95.1	57.1	42.9	0.0	27.6	72.4	0.0	89.2	10.8	5.4	94.6

		Percentage Frequencies							
		LPR4		LPU4		LPR5		LPU5	
Group	n	0	1	0	1	0	1	0	1
DH	28	71.4	28.6	0.0	100.0	85.7	14.3	0.0	100.0
Coeliacs	26	53.8	46.2	3.8	96.2	69.2	30.8	0.0	100.0
Controls	203	70.4	29.6	2.5	97.5	91.1	8.9	1.5	98.5

Table 8.14 - Mann-Whitney U Test Results: Ulnar and Radial Loop Scores

(a) MALES

PROBABILITY			
VARIABLE	CONT : DH	CONT:COEL	DH : COEL
RPR1	0.0961	0.2503	0.0617
RPU1	0.9507	0.0113*	0.0538
RPR2	0.5402	0.5346	0.7261
RPU2	0.0913	0.6667	0.3298
RPR3	0.5038	0.1229	0.1904
RPU3	0.3937	0.0234*	0.0139*
RPR4	0.3219	0.3809	0.2104
RPU4	0.4929	0.0000**	0.0010**
RPR5	0.6781	0.1229	0.1606
RPU5	0.4929	0.0000**	0.0010**
LPR1	0.1288	0.7540	0.3004
LPU1	0.3315	0.6722	1.0000
LPR2	0.2991	0.7448	0.8780
LPU2	0.0089**	0.5500	0.5648
LPR3	0.9784	0.6854	0.6776
LPU3	0.3392	0.0278*	0.8139*
LPR4	0.4452	0.0681	0.1536
LPU4	0.1962	0.2368	0.0209*
LPR5	0.0811	0.6854	0.6036
LPU5	0.4012	0.7147	1.0000

(b) FEMALES

PROBABILITY			
VARIABLE	CONT : DH	CONT:COEL	DH : COEL
RPR1	0.7521	0.6335	0.8935
RPU1	0.8820	0.8030	0.9392
RPR2	0.1101	0.2080	0.8230
RPU2	0.0112*	0.8928	0.1088
RPR3	0.0909	0.1252	0.0158*
RPU3	0.8873	0.8082	0.9392
RPR4	0.3321	0.0447*	0.0295*
RPU4	0.3753	0.3929	1.0000
RPR5	0.5363	0.0602	0.4104
RPU5	0.2843	0.3027	1.0000
LPR1	0.5834	0.4629	0.8700
LPU1	0.7529	0.8088	0.9578
LPR2	0.6109	0.4903	0.8974
LPU2	0.1333	0.9433	0.2537
LPR3	0.0676	0.0046**	0.0016**
LPU3	0.6803	0.2211	0.2685
LPR4	0.9148	0.0868	0.1854
LPU4	0.4022	0.6783	0.2994
LPR5	0.3609	0.0009**	0.1492
LPU5	0.5182	0.5335	1.0000

Table 8.15 - Canonical Discriminant Functions - Males: RPR1 to LPU5

FUNCTION	EIGENVALUE	PERCENT OF VARIANCE	CUMULATIVE PERCENT	CANONICAL CORRELATION
1*	0.20048	53.27	53.27	0.4086574
2*	0.09553	25.38	78.65	0.2953014
3*	0.08037	21.35	100.00	0.2727457

Table 8.16 - Structure Matrix - Males: RPR1 to LPU5

	FUNC 1	FUNC 2	FUNC 3
RPU5	0.57139*	0.02631	0.26963
RPU4	0.37663*	0.16481	0.11490
RPR1	-0.36429*	0.07589	0.17729
LPU1	0.05906*	-0.01991	0.00707
RPU3	0.27056	0.68384*	0.22438
LPR2	0.02848	-0.53042*	-0.16910
LPU2	-0.22600	0.44822*	0.42657
RPR3	0.13930	0.44782*	0.32465
LPR3	0.15715	-0.36729*	0.13080
LPU3	-0.04105	0.15907*	0.05059
RPR2	-0.04005	-0.12827*	-0.04659
LPR5	-0.08665	-0.15671	0.39408*
LPR1	-0.23121	0.11462	0.24834*
LPR4	0.15331	0.16376	0.24633*
RPR5	0.01974	-0.09316	0.23596*
LPU4	0.05871	0.09014	-0.22859*
RPU2	-0.06197	0.12519	0.22191*
LPU5	0.00463	-0.08642	-0.19630*
RPR4	0.09807	-0.08604	-0.12529*

Table 8.17 - F Statistics and significances between groups

GROUP	GROUP	1	2	3
2		2.0781 0.0226		
3		3.8218 0.0000	4.3152 0.0000	
4		2.0576 0.0242	2.0540 0.0245	2.9459 0.0011
Code	Group			
1	Controls			
2	DH			
3	Coelias			
4	Coelias unaffected relatives			

Figure 8.5 - Territorial Map - Males: RPR1 to LPU5

Code	Group
1	Controls
2	DI
3	Coelinas
4	Coelina unaffected relatives

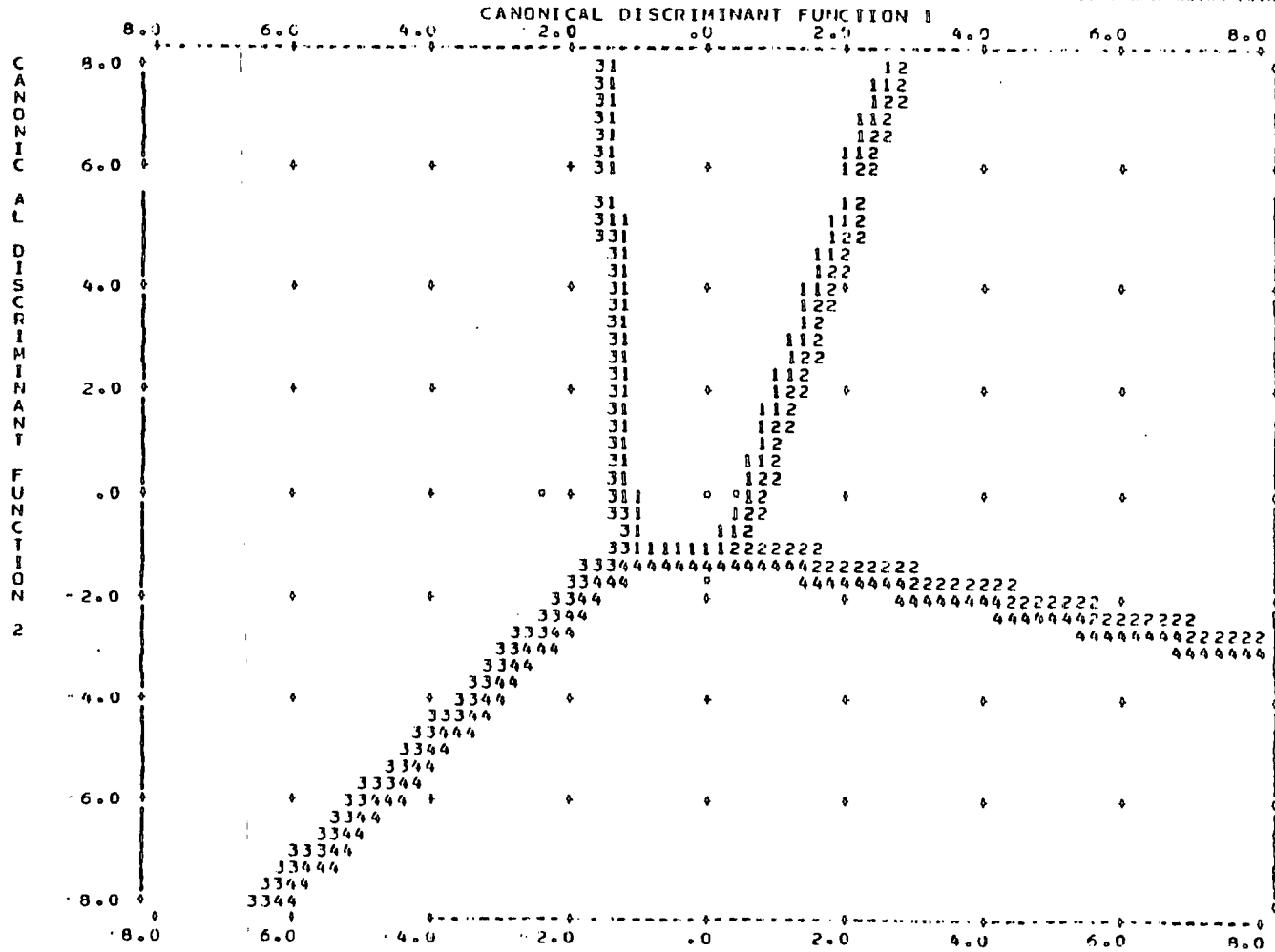

Table 8.18 - Males: LPR1 to LPU5

Code Group
 1 Controls
 2 DU
 3 Coeliac
 4 Coeliac unaffected relatives

CLASSIFICATION RESULTS

ACTUAL GROUP	NO. OF CASES	PREDICTED GROUP MEMBERSHIP			
		1	2	3	4
GROUP 1	199	100 50.3%	57 28.6%	13 6.5%	29 14.6%
GROUP 2	48	13 27.1%	31 64.6%	0 0.0%	4 8.3%
GROUP 3	9	3 33.3%	1 11.1%	5 55.6%	0 0.0%
GROUP 4	7	0 0.0%	3 42.9%	0 0.0%	4 57.1%

PERCENT OF "GROUPED" CASES CORRECTLY CLASSIFIED: 53.23%

Function 1 accounted for 48.76% of the variance with Function 2 taking out a further 34.31%. Ulnar loop scores were the most important variables contributing to Function 1 with those on finger II of both hands being the most important along with RPU4 (Table 8.20). Radial scores on all fingers except the thumbs were the most important in Function 2.

Table 8.21 showed that DH and controls ($F = 2.7215$) followed by DH and Coeliacs were the most widely separated pairs of groups. The territorial map (Figure 8.7) and individual group scatterplots (Figure 8.8) show the relationships between the various groups. DH subjects have their group centroid to the left removed from controls and Coeliac relatives which lie adjacent to one another with Coeliacs removed upwards and to the right. Classification results show 48.18% correct grouping of cases (Table 8.22). DH females with 59.3% correctly classified were the group with the best results followed in order by Coeliac unaffected relatives (50%), controls (48.2%) and Coeliac patients (36%).

Table 8.19 - Canonical Discriminant Functions - Females: RPR1 to LPU5

FUNCTION	EIGENVALUE	PERCENT OF VARIANCE	CUMULATIVE PERCENT	CANONICAL CORRELATION
1*	0.13064	48.76	48.76	0.3399175
2*	0.09192	34.31	83.07	0.2901446
3*	0.04534	16.93	100.00	0.2082736

Table 8.20 - Structure Matrix - Females: RPR1 to LPU5

	FUNC 1	FUNC 2	FUNC 3
RPU2	0.44373*	0.00372	0.16356
LPU2	-0.20642*	0.01433	-0.03777
RPU4	0.03772*	-0.00264	-0.00923
LPR5	-0.11669	0.70375*	0.11630
LPR3	0.33230	0.67036*	0.23469
LPR4	0.23631	0.44912*	-0.01199
RPR4	0.28809	0.44233*	-0.21570
RPR5	-0.09261	0.39875*	0.16093
RPR3	0.29571	0.36983*	0.23198
RPU3	0.15243	-0.20653*	-0.06853
RPR2	-0.15909	0.16663*	0.01963
LPU1	0.03705	0.00244	0.69542*
LPR1	0.10433	-0.09758	0.42094*
RPU1	0.09683	-0.05401	0.29896*
RPR1	0.01792	-0.03038	0.25568*
LPR2	0.08044	0.16709	0.20085*
LPU4	0.02693	-0.09506	0.10666*
LPU3	0.00088	-0.07113	0.08349*
RPU5	-0.01523	0.04844	-0.06385*

Table 8.21 - F Statistics and significances between groups

GROUP	GROUP 1	GROUP 2	GROUP 3
2	2.7215 0.0025		
3	1.9399 0.0354	2.3479 0.0092	
4	0.97996 0.4653	1.3676 0.1892	1.1641 0.3131

Code	Group
1	Controls
2	DH
3	Coelinae
4	Coelinae unaffected relatives

Figure 8.7 - Territorial Map - Females:RPR1 to LPU5

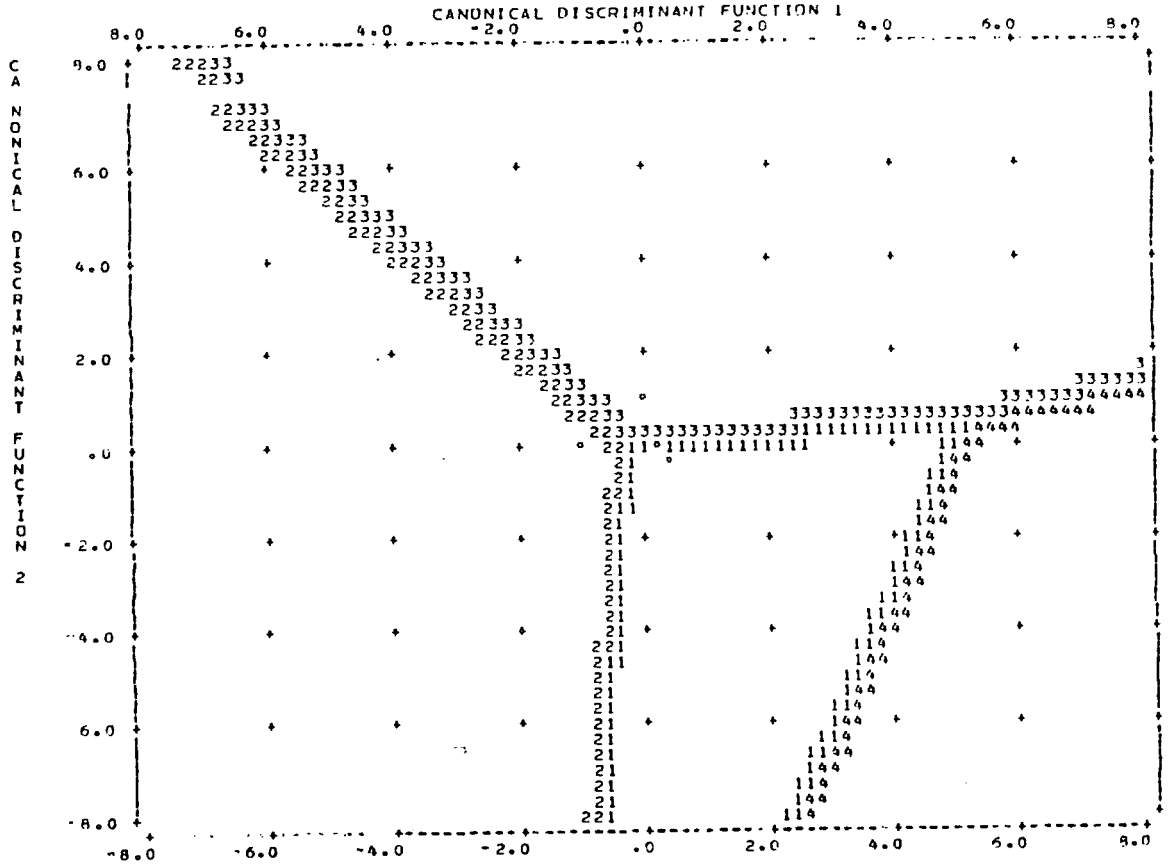

Code	Group
1	Controls
2	DH
3	Coelins
4	Coelins unaffected relatives

Figure 8.8 - Individual Group Plots - Females: RPR1 to LPU5

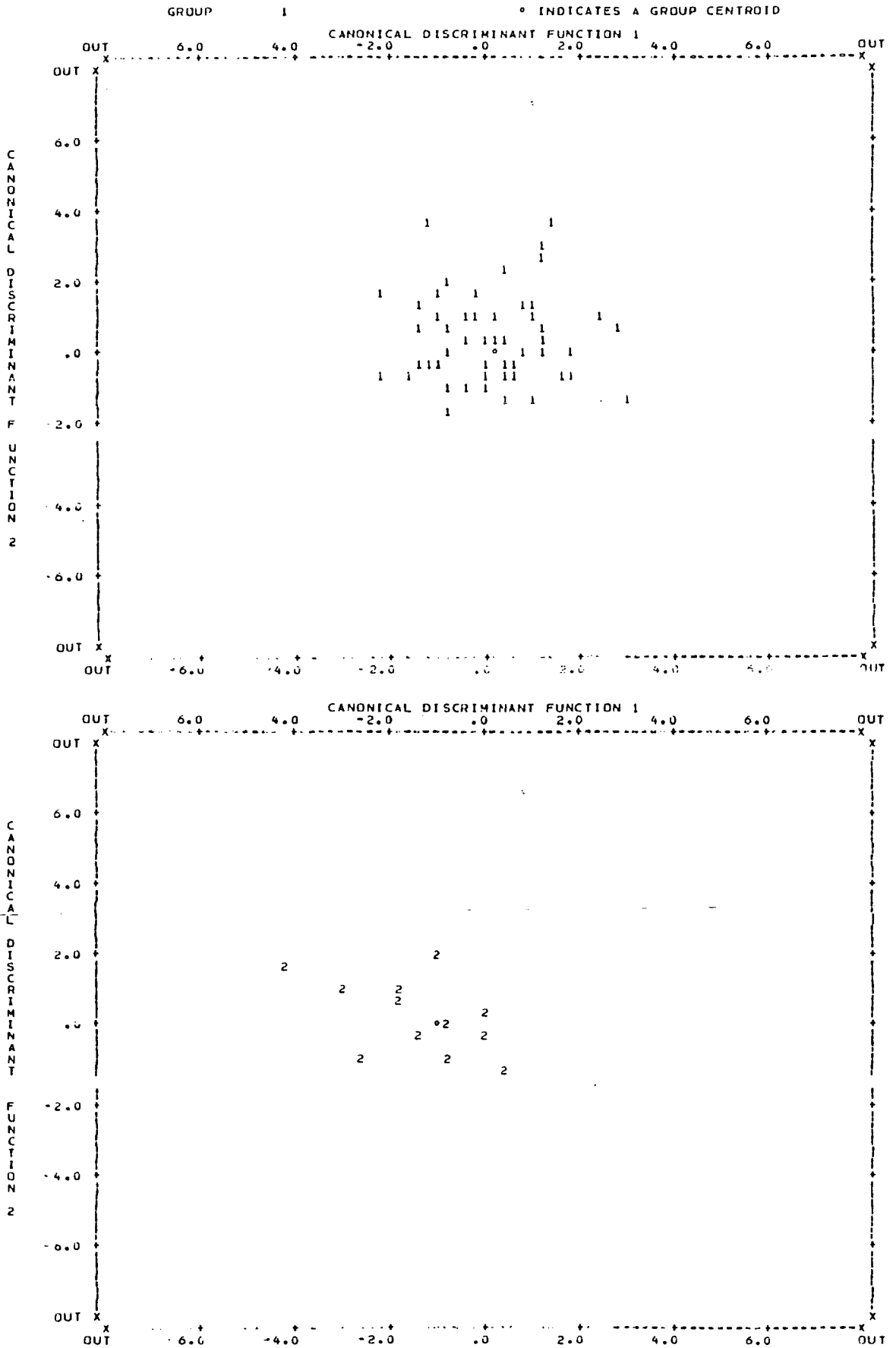

Figure 8.8 continued

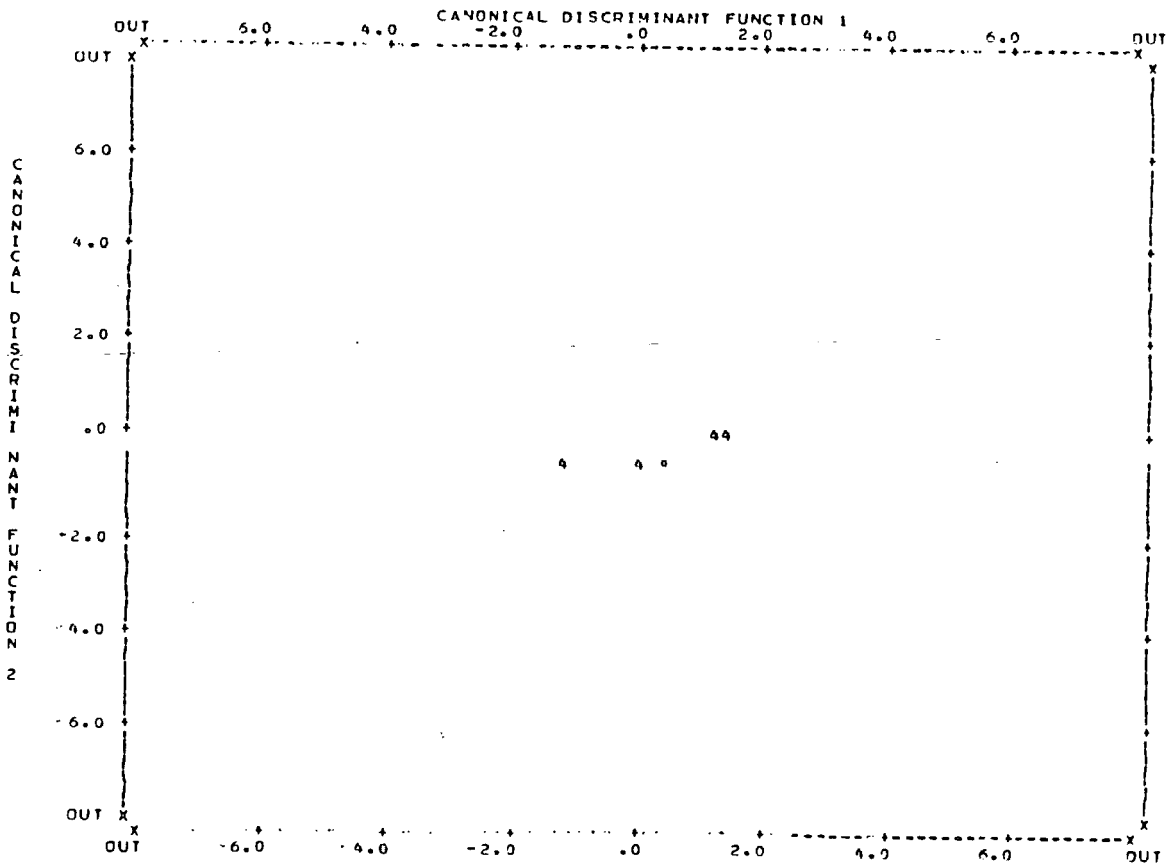
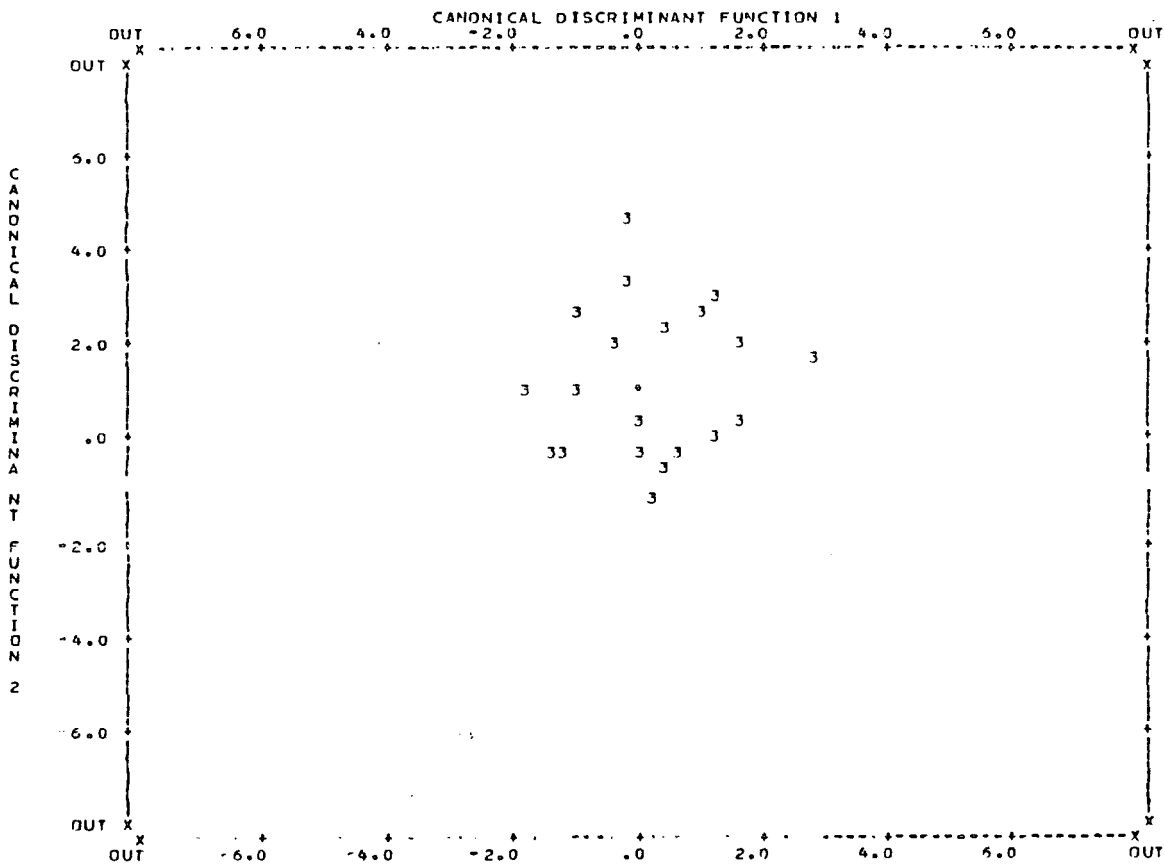

Table 8.22 - Females: RPR1 to LPU5

Code	Group
1	Controls
2	DH
3	Celiacs
4	Celiac unaffected relatives

CLASSIFICATION RESULTS

ACTUAL GROUP	NO. OF CASES	PREDICTED GROUP MEMBERSHIP			
		1	2	3	4
GROUP 1	191	92 48.2%	40 20.9%	31 16.2%	28 14.7%
GROUP 2	27	7 25.9%	16 59.3%	1 3.7%	3 11.1%
GROUP 3	25	6 24.0%	6 24.0%	9 36.0%	4 16.0%
GROUP 4	4	1 25.0%	1 25.0%	0 0.0%	2 50.0%

PERCENT OF "GROUPED" CASES CORRECTLY CLASSIFIED: 48.18%

(iii) Finger Delta Scores - Variables: RD1 to LD5

No statistically significant differences were found for comparisons between control subjects and DH patients of either sex for finger delta scores (Table 8.25). When male controls were compared to male Coeliac patients it was found that controls had a highly significantly larger count for RD5 and a significantly larger count for RD3 in comparison to Coeliacs (Tables 8.23 and 8.25). Female Coeliacs were found to have a statistically highly significantly greater LD5 score than that for female controls (Tables 8.24 and 8.25b).

Male DH patients were found to have significantly higher scores for RD3, RD4 and RD5 compared to Coeliac males (Tables 8.23 and 8.25). Female Coeliacs were found to have significantly higher scores for both RD3 and LD3 and for RD4 in comparison to female DH patients (Tables 8.24 and 8.25).

When discriminant analysis was carried out for males, three canonical discriminant functions were extracted (Table 8.26) with Function 1 accounting for 64.38% of the variance and Function 2 taking out a further 24.23%. Table 8.27 shows that RD4 and RD2 are the most important variables in Function 1. The Table of F statistics (Table 8.28) shows that the most widely separated groups are DH and Coeliacs ($F = 2.8780$) followed by DH and controls ($F = 2.3438$) the differences in each case are significant the first at the 1% level and the second at the 5% level. Figure 8.9 shows that Coeliacs centroid is separated from the other three groups centroid which are grouped closely together. The scatterplots (Figure 8.10) shows much overlap of cases within the groups with controls encompassing the other groups. Classification results, shown in Table 8.29, show 46.21% of correct grouping. The best groups are Coeliacs (77.8% correct) and controls (48% correct).

Discriminant analysis for females using the variables RD1 to LD5 yielded three canonical discriminant functions with Function 1 accounting for 57.05% of the variance and Function 2 taking out another 29.87% (Table 8.30). Table 8.31 shows that LD2 is the most important variable in Function 1 with Function 2 being composed of delta scores on both hands for fingers V and IV and RIII also. The Table of F statistics shows that controls and DH are the widest separated groups ($F = 2.6781$) and the only ones where a statistical significance at the 5% level was found (Table 8.32).

Table 8.23

Means and Standard Deviations

Finger Delta Scores

Males

(a) Right Hand

Group	n	RD1		RD2		RD3		RD4		RD5	
		Mean	Std Dev	Mean	Std. Dev.	Mean	Std. Dev.	Mean	Std. Dev.	Mean	Std. Dev.
DH	48	2.833 +/- 1.226		2.958 +/- 1.414		2.375 +/- 1.142		4.000 +/- 2.288		2.875 +/- 2.017	
Coeliac	10	3.667 +/- 1.323		3.778 +/- 3.114		1.556 +/- 0.882		2.222 +/- 1.563		1.556 +/- 0.882	
Controls	206	3.146 +/- 1.346		3.272 +/- 2.220		2.544 +/- 1.743		3.403 +/- 2.118		2.908 +/- 2.225	

(b) Left Hand

Group	n	LD1		L D2		L D3		L D4		L D5	
		Mean	Std Dev	Mean	Std. Dev.	Mean	Std. Dev.	Mean	Std. Dev.	Mean	Std. Dev.
DH	48	2.688 +/- 1.170		2.771 +/- 1.292		2.396 +/- 1.180		2.979 +/- 1.618		2.125 +/- 0.489	
Coeliac	10	2.889 +/- 1.054		2.556 +/- 1.667		1.889 +/- 0.782		2.444 +/- 2.186		2.333 +/- 1.000	
Controls	206	2.937 +/- 1.558		2.927 +/- 1.558		2.311 +/- 1.059		3.291 +/- 2.051		2.539 +/- 1.516	

Table 8.26 - Canonical Discriminant Functions - Males: RD1 to LD5

FUNCTION	EIGENVALUE	PERCENT OF VARIANCE	CUMULATIVE PERCENT	CANONICAL CORRELATION
1*	0.09382	64.38	64.38	0.2928764
2*	0.03531	24.23	88.60	0.1845689
3*	0.01661	11.40	100.00	0.1278333

Table 8.27 - Structure Matrix - Males: RD1 to LD5

	FUNC 1	FUNC 2	FUNC 3
RD4	0.50996*	0.04701	-0.05574
RD2	-0.26521*	0.05764	-0.02102
RD3	0.16106	0.58679*	0.15318
LD4	-0.03053	0.51478*	-0.45239
LD5	-0.22594	0.50398*	0.18682
RD5	0.15561	0.36901*	0.03278
RD1	-0.34066	0.05716	0.61763*
LD1	-0.13845	0.15057	0.43924*
LD3	0.27593	0.18809	0.31426*
LD2	-0.02950	0.13143	0.14822*

Table 8.28 - F Statistics and intergroup significances

GROUP	GROUP 1	2	3
2	2.3438 0.0245		
3	2.0207 0.0530	2.8780 0.0066	
4	0.79216 0.5945	0.64984 0.7144	1.7986 0.0879

Code	Group
1	Controls
2	DH
3	Coeliacs
4	Coeliac unaffected relatives

Figure 8.9 - Territorial Map - Males: RD1 to LD5

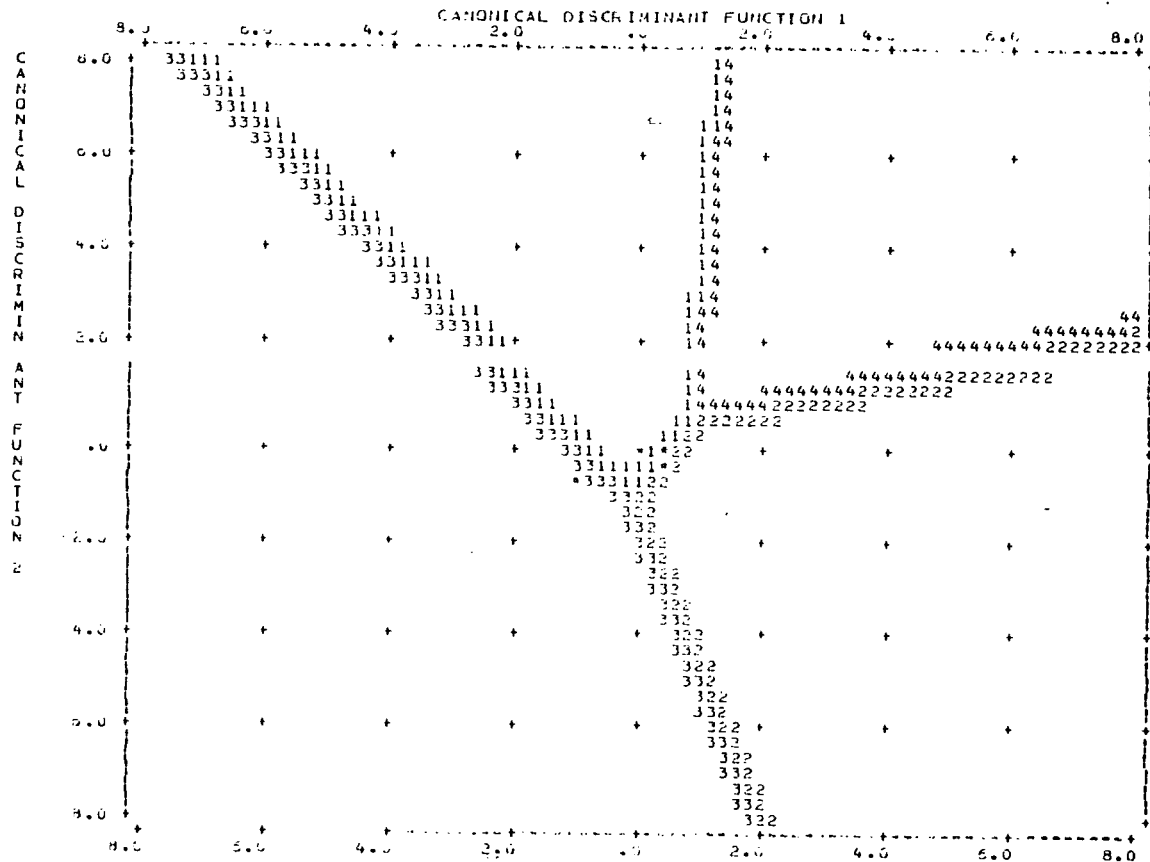

Code	Group
1	Controls
2	DH
3	Coeliacs
4	Coeliac unaffected relatives

Figure 8.10 - Individual Group Plots - Males: RD1 to LD5

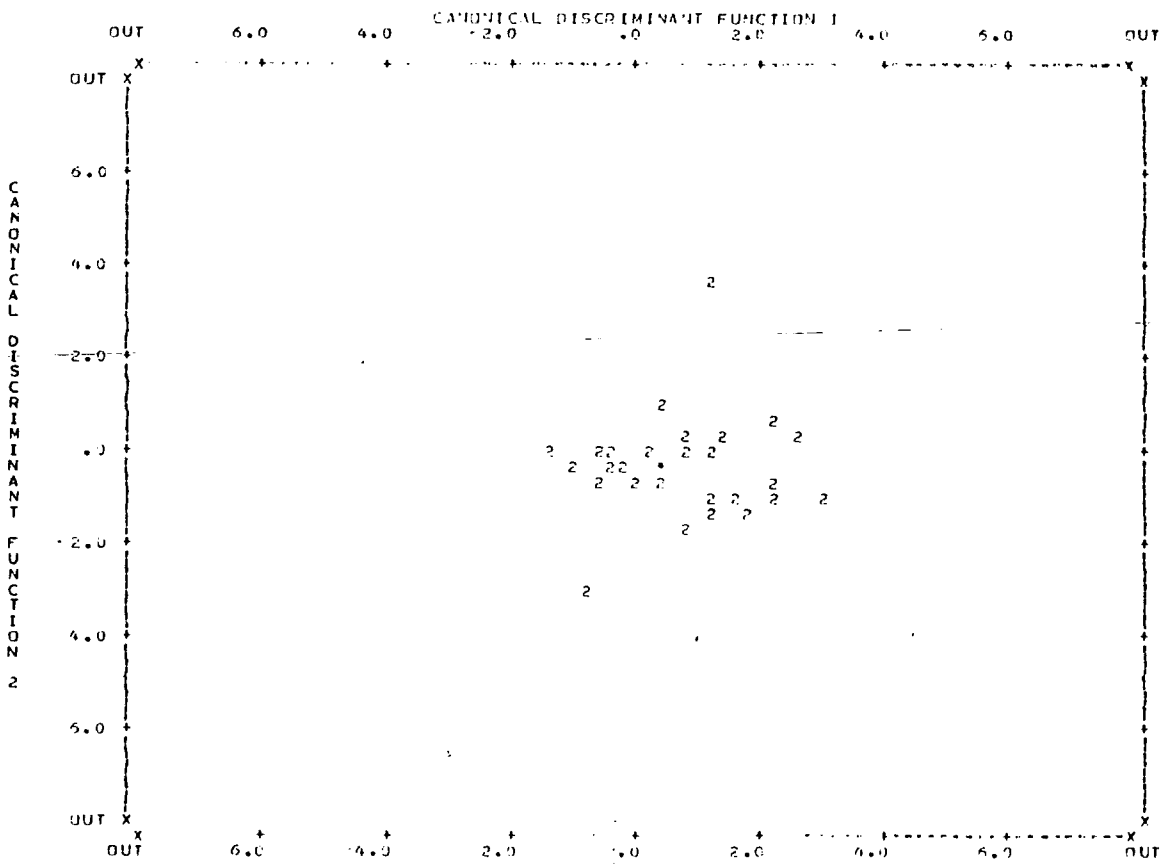
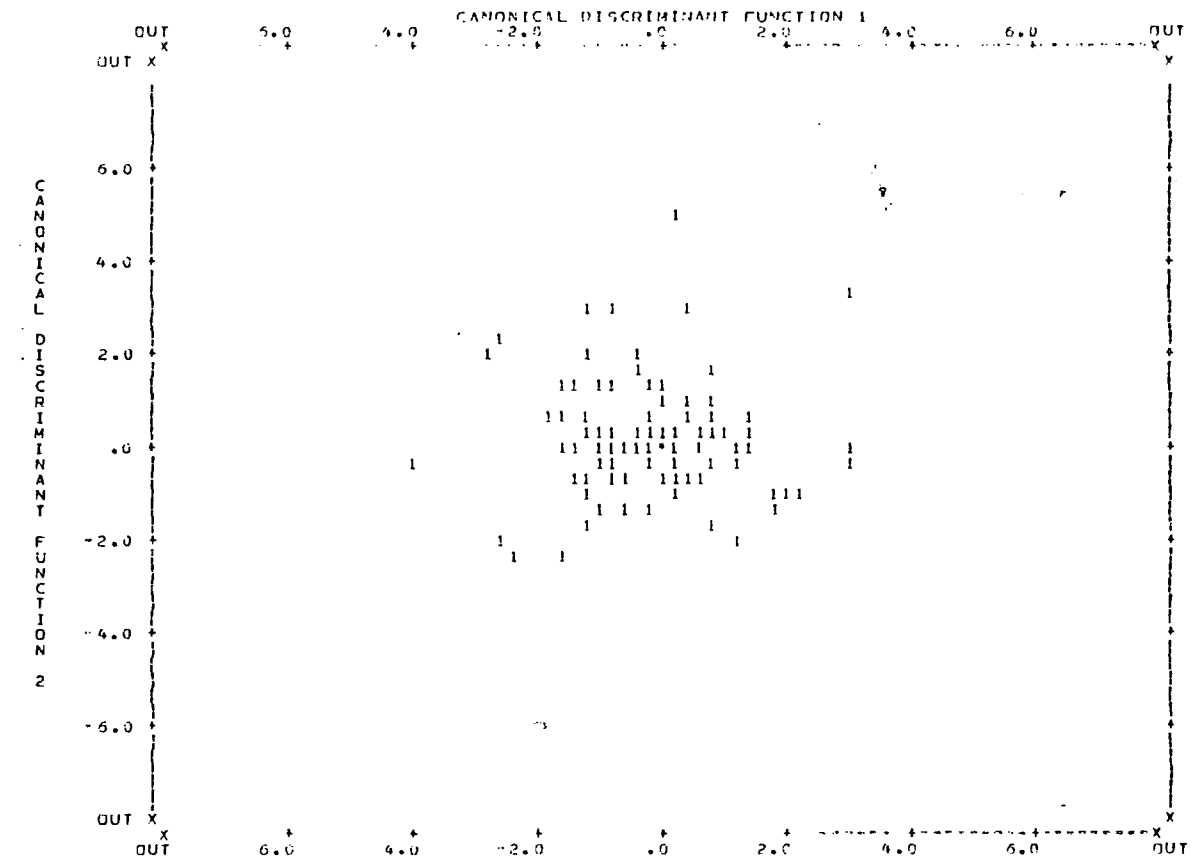

Figure 8.10 continued

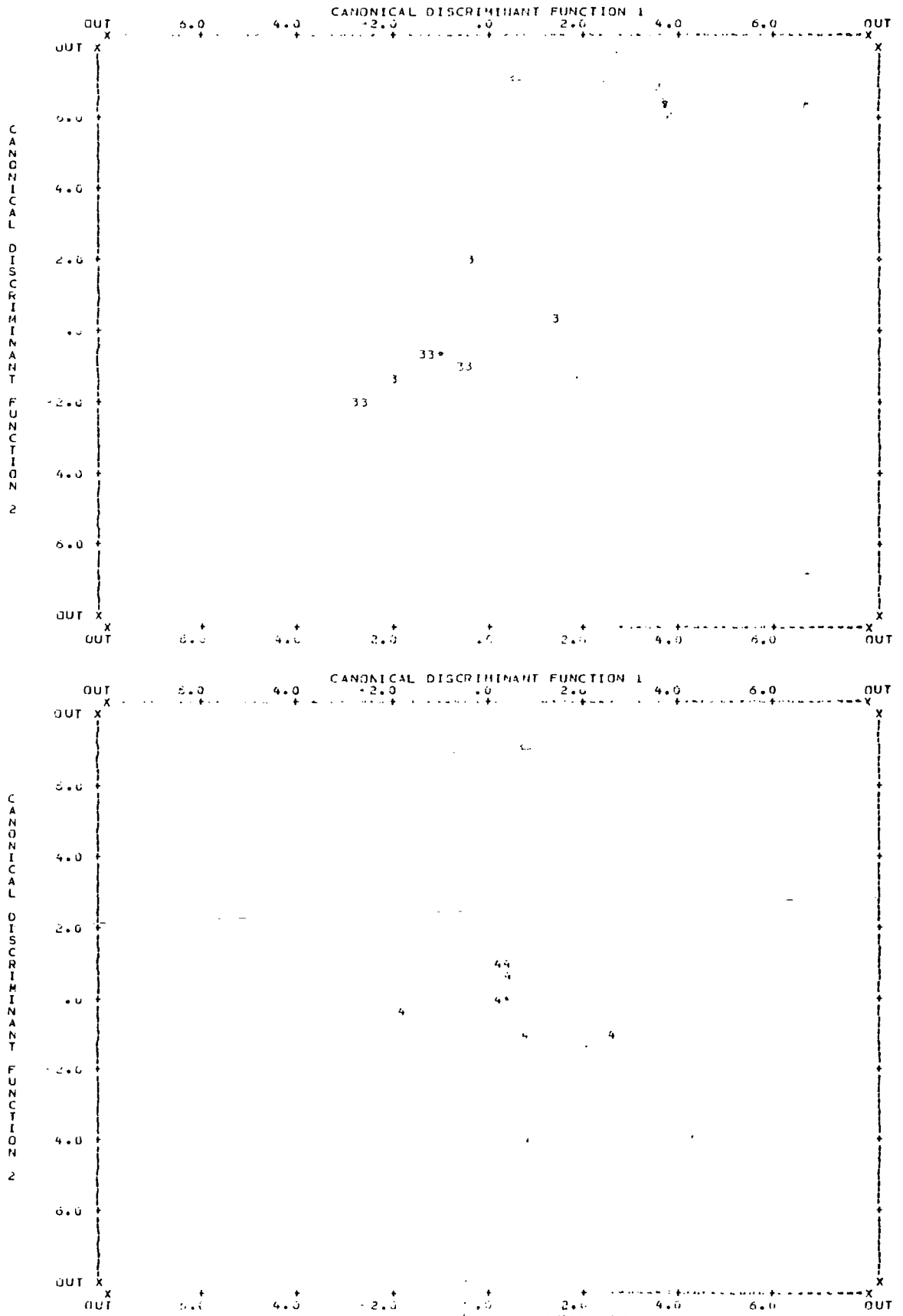

Table 8.29 - Males: RD1 to LD5

<u>Code</u>	<u>Group</u>
1	Controls
2	DH
3	Celiacs
4	Celiac unaffected relatives

CLASSIFICATION RESULTS

ACTUAL GROUP	NO. OF CASES	PREDICTED GROUP MEMBERSHIP			
		1	2	3	4
GROUP 1	200	96 48.0%	27 13.5%	35 17.5%	42 21.0%
GROUP 2	48	15 31.3%	17 35.4%	4 8.3%	12 25.0%
GROUP 3	9	1 11.1%	0 0.0%	7 77.8%	1 11.1%
GROUP 4	7	2 28.6%	2 28.6%	1 14.3%	2 28.6%

PERCENT OF "GROUPED" CASES CORRECTLY CLASSIFIED: 46.21%

The territorial map (Figure 8.11) shows that controls and Coeliacs are close together in the centre with DH subjects removed to the right. Unaffected relatives are found to be situated to the left of the other group centroids. The classification results show 47.31% correct grouping with the best results being for controls (53%) and unaffected Coeliac relatives (50% correct) see Table 8.33.

Table 8.30 - Canonical Discriminant Functions - Females: RD1 to LD5

FUNCTION	EIGENVALUE	PERCENT OF VARIANCE	CUMULATIVE PERCENT	CANONICAL CORRELATION
1	0.05725	57.08	57.08	0.2327103
2	0.02996	29.87	86.95	0.1705619
3	0.01309	13.05	100.00	0.1136605

Table 8.31 - Structure Matrix - Females: RD1 to LD5

	FUNC 1	FUNC 2	FUNC 3
LD2	0.70192*	0.05789	0.10666
LD5	0.48225	0.52938*	0.37041
RD5	-0.01718	0.43399*	0.07844
RD4	-0.20714	0.35391*	0.16458
LD4	-0.01772	0.28811*	0.17913
RD3	-0.12767	0.26291*	0.12559
LD3	0.25655	0.50468	0.73733*
LD1	0.00651	-0.54999	0.64695*
RD1	0.05743	-0.13303	0.36116*
RD2	0.12472	0.11198	0.20621*

Table 8.32 - F Statistics - Females: RD1 to LD5

GROUP	GROUP	1	2	3
2		2.6781		
		0.0222		
3		1.4638	1.7402	
		0.2022	0.1259	
4		0.94514	1.5620	0.86623
		0.4523	0.1714	0.5030

Code	Group
1	Controls
2	DH
3	Coeliacs
4	Coeliac unaffected relatives

Figure 8.11 - Females: RD1 to LD5

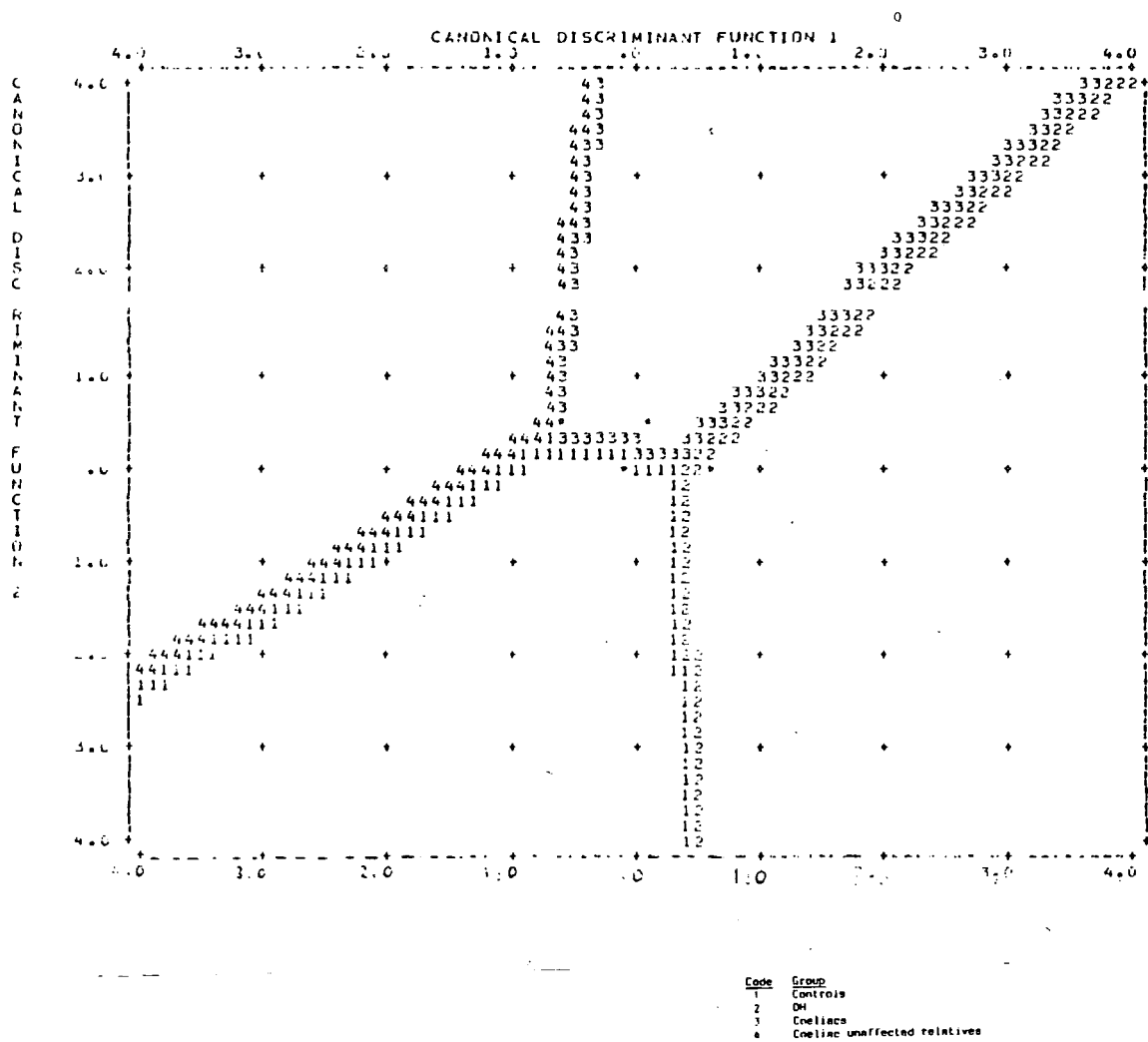

Figure 8.12 continued

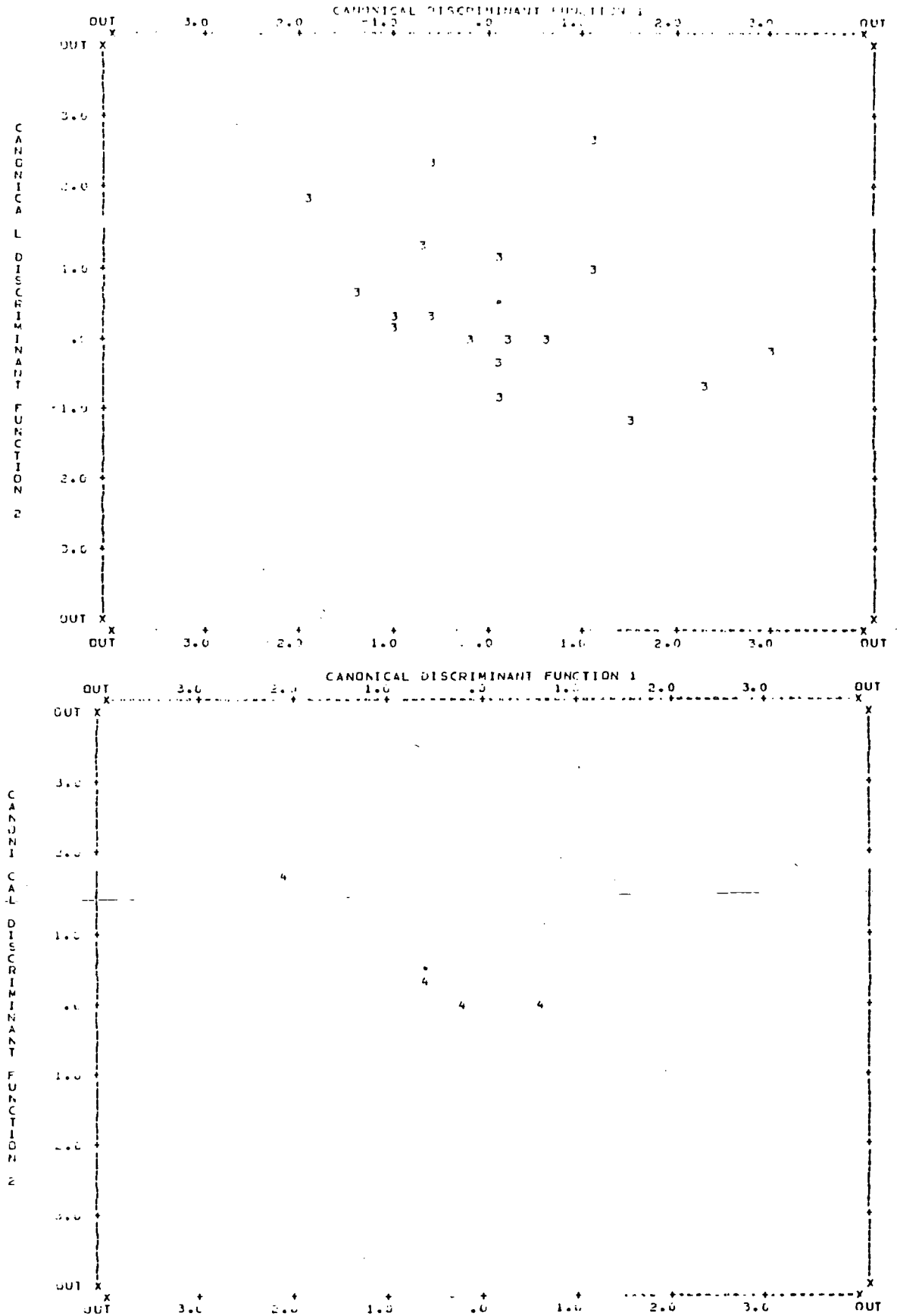

Table 8.33 - Females: RD1 to LD5

Code Group
 1 Controls
 2 OI
 3 One-lives
 4 One-lives unaffected relatives

CLASSIFICATION RESULTS

ACTUAL GROUP	NO. OF CASES	PREDICTED GROUP MEMBERSHIP			
		1	2	3	4
GROUP 1	232	137 59.0%	34 16.8%	21 9.0%	41 20.3%
GROUP 2	28	19 67.9%	7 25.0%	1 3.6%	1 3.6%
GROUP 3	26	10 38.5%	5 19.2%	7 26.9%	4 15.4%
GROUP 4	4	1 25.0%	1 25.0%	0 0.0%	2 50.0%

PERCENT OF "GROUPED" CASES CORRECTLY CLASSIFIED: 47.31%

(iv) Finger Pattern Intensity Indices - Variables: RFPII, LFPII, TFPII

Coeliac males were found to have lower pattern intensity indices for all three variables in comparison to DH and controls but the differences were not found to be statistically significant (see Tables 8.33 and 8.34). The same differences were not found for females.

Table 8.33

Means and Standard Deviations

Finger Pattern

Intensity Indices

(a) Males

Group	n	RFPII		LFPII		TFPII	
		Mean	Std Dev.	Mean	Std. Dev.	Mean	Std. Dev.
DH	48	15.042	+/- 5.227	12.958	+/- 3.707	28.000	+/- 7.960
Coeliac	10	12.778	+/- 5.718	12.111	+/- 4.595	24.889	+/- 9.144
Controls	206	15.272	+/- 7.022	14.005	+/- 7.022	29.277	+/- 10.127

(b) Females

Group	n	RFPII		LFPII		TFPII	
		Mean	Std Dev.	Mean	Std. Dev.	Mean	Std. Dev.
DH	28	12.714	+/- 3.905	14.036	+/- 5.621	26.750	+/- 8.523
Coeliac	26	14.500	+/- 4.658	13.423	+/- 4.216	27.923	+/- 8.192
Controls	203	13.813	+/- 8.670	12.852	+/- 4.254	26.665	+/- 11.148

Table 8.34 - Mann-Whitney U Test Results - Finger Pattern Intensity

Indices(a) MALES

PROBABILITY			
VARIABLE	CONT : DH	CONT:COEL	DH : COEL
RFPII	0.7773	0.4126	0.4959
LFPII	0.2415	0.4746	0.9912
TFPII	0.7746	0.3380	0.5762

(b) FEMALES

PROBABILITY			
VARIABLE	CONT : DH	CONT:COEL	DH : COEL
RFPII	0.5808	0.1813	0.1311
LFPII	0.5146	0.6022	0.9088
TFPII	0.7948	0.3271	0.5488

(b) Finger Ridge Counts

(i) Individual Finger Ridge Counts - Variables: LFU1 to RFR5

Control males were found to have a significantly higher radial count on finger II of the left hand in comparison to DH and Coeliac males. Coeliac males were found to have significantly lower radial counts on finger III of the left hand in comparison to both controls and to DH males. On the right hand, Coeliacs had a significantly lower radial count on finger IV compared to DH males (Tables 8.35 and 8.37). For female subjects, DH patients had a significantly lower radial count in comparison to control females on finger RII. Coeliac females were found to have a statistically significantly higher ulnar count on RII compared to control females. On finger III of the left hand, Coeliacs had a significantly higher ulnar count compared to the other two groups and a significantly higher ulnar count on RIII compared to DH females. On finger RIII, Coeliac females were found to have a significantly higher radial count in comparison to controls. On finger IV of the right hand, Coeliac females were found to have significantly higher ulnar counts compared to DH and to control subjects. On the left hand finger IV, Coeliacs had a higher radial count in comparison to DH. For ulnar counts on finger V of both hands, Coeliacs were found to have a significantly higher value than controls (see Tables 8.36 and 8.37).

When discriminant analysis was carried out three canonical discriminant functions were produced with Function 1 accounting for 79.19% of the variance and Function 2 taking out another 30.14% (Table 8.38). Table 8.39 shows that the most important variable in Function 1 are LFR3, LFU2, LFR4 and RFU2. The Table of F statistics shows that the most widely separated groups are controls and DH in comparison to Coeliac relatives. Classification results show 48.86% correct grouping with the best results for Coeliac unaffected relatives (85.7% correct) followed by Coeliacs (66.7% correct) see Table 8.41.

Discriminant analysis produced three canonical discriminant functions (Table 8.42) with Function 1 accounting for 63.37% of the variance and Function 2 for another 24.19%. Table 8.43 shows that seven variables are most important in Function 1 and all but one are ulnar counts on fingers V, IV and II of both hands. The Table of F statistics shows controls and Coeliacs ($F = 5.2758$), Coeliacs and DH

($F = 2.9616$) and controls and DH ($F = 2.4033$) being most widely separated with all being significant at the 1% level (see Table 8.44). Table 8.45 shows that these variables classified the female grouped cases 53.08% correctly. Best grouped cases were in unaffected Coeliac relatives (75%) followed by controls (53.5%).

Table 8.35(a)

Means and Standard Deviations

Finger Ridge Counts

Males : Left Hand

		Variables									
		LFU1		LFR1		LFU2		LFR2		LFU3	
Groups	n	Mean	Std Dev	Mean	Std Dev	Mean	Std Dev	Mean	Std Dev	Mean	Std Dev
D.H.	48	5.000 +/-	8.402	18.917 +/-	5.035	6.167 +/-	6.411	7.833 +/-	7.639	2.313 +/-	5.509
Coeliacs	10	8.556 +/-	10.236	18.000 +/-	8.216	6.222 +/-	7.759	7.111 +/-	6.772	0.222 +/-	0.667
Controls	206	6.350 +/-	8.554	17.927 +/-	5.410	6.519 +/-	8.264	10.335 +/-	7.370	2.296 +/-	5.793

		Variables									
		LFR3		LFU4		LFR4		LFU5		LFR5	
Groups	n	Mean	Std Dev	Mean	Std Dev	Mean	Std Dev	Mean	Std Dev	Mean	Std Dev
D.H.	48	14.833 +/-	5.016	4.250 +/-	6.837	16.000 +/-	5.169	0.958 +/-	3.764	12.729 +/-	4.404
Coeliacs	10	9.667 +/-	6.205	2.222 +/-	4.842	12.778 +/-	8.273	0.667 +/-	2.000	13.111 +/-	3.723
Controls	206	13.587 +/-	6.179	5.320 +/-	7.497	15.922 +/-	6.597	1.505 +/-	4.073	13.825 +/-	5.047

Table 8.35(b)

Means and Standard Deviations

Finger Ridge Counts

Males Right Hand

		Variables									
Groups	n	RFR1		RFU1		RFR2		RFU2		RFR3	
		Mean	Std Dev	Mean	Std Dev	Mean	Std Dev	Mean	Std Dev	Mean	Std Dev
D.H.	48	20.208 +/- 5.157		6.479 +/- 9.347		8.271 +/- 7.590		8.271 +/- 8.005		14.125 +/- 5.851	
Coeliacs	10	19.444 +/- 8.487		9.444 +/- 9.029		6.889 +/- 7.026		9.889 +/- 8.992		9.556 +/- 6.654	
Controls	206	19.796 +/- 5.101		7.393 +/- 8.676		9.767 +/- 7.417		7.568 +/- 8.365		13.277 +/- 5.780	

		Variables									
Groups	n	RFU3		RFR4		RFU4		RFR5		RFU5	
		Mean	Std Dev	Mean	Std Dev	Mean	Std Dev	Mean	Std Dev	Mean	Std Dev
D.H.	48	2.271 +/- 5.727		16.229 +/- 5.020		5.563 +/- 6.630		13.292 +/- 3.820		1.396 +/- 3.689	
Coeliacs	10	0.000 +/- 0.000		12.000 +/- 7.211		3.333 +/- 5.099		11.222 +/- 7.085		0.000 +/- 0.000	
Controls	206	3.199 +/- 6.708		15.942 +/- 6.056		6.864 +/- 8.264		14.058 +/- 5.018		1.825 +/- 4.336	

Table 8.36(a)

Means and Standard Deviations

Finger Ridge Counts

Females : Left Hand

		Variables									
		LFU1		LFR1		LFU2		LFR2		LFU3	
Groups	n	Mean	Std Dev	Mean	Std Dev	Mean	Std Dev	Mean	Std Dev	Mean	Std Dev
D.H.	28	3.929	+/- 6.949	16.107	+/- 4.924	5.536	+/- 7.510	9.000	+/- 5.963	0.000	+/- 0.000
Coeliacs	26	4.654	+/- 8.841	14.654	+/- 5.091	7.577	+/- 8.846	9.231	+/- 7.005	4.692	+/- 7.903
Controls	203	4.300	+/- 7.211	15.616	+/- 5.663	4.719	+/- 6.936	8.813	+/- 6.561	1.493	+/- 4.558

		Variables									
		LFU3		LFR4		LFU4		LFR5		LFU5	
Groups	n	Mean	Std Dev	Mean	Std Dev	Mean	Std Dev	Mean	Std Dev	Mean	Std Dev
D.H.	28	11.929	+/- 5.011	2.536	+/- 5.260	12.500	+/- 4.718	1.286	+/- 4.072	11.107	+/- 4.306
Coeliacs	26	11.615	+/- 6.888	7.385	+/- 9.411	14.346	+/- 6.145	4.538	+/- 7.067	14.038	+/- 4.754
Controls	203	11.591	+/- 5.405	3.300	+/- 6.224	14.567	+/- 5.339	0.818	+/- 2.940	12.182	+/- 4.438

Table 8.36(b)

Means and Standard Deviations

Finger Ridge Counts

Females : Right Hand

		Variables									
		RFR1		RFU1		RFR2		RFU2		RFR3	
Groups	n	Mean	Std Dev	Mean	Std Dev	Mean	Std Dev	Mean	Std Dev	Mean	Std Dev
D.H.	28	17.357 +/- 5.851		4.893 +/- 8.098		6.679 +/- 7.273		6.857 +/- 7.064		11.179 +/- 5.863	
Coeliacs	26	15.808 +/- 5.185		4.615 +/- 8.050		9.731 +/- 7.181		7.885 +/- 8.325		13.538 +/- 6.617	
Controls	203	16.877 +/- 5.425		4.409 +/- 7.123		9.690 +/- 6.965		4.631 +/- 6.411		11.315 +/- 5.538	

		Variables									
		RFU3		RFR4		RFU4		RFR5		RFU5	
Groups	n	Mean	Std Dev	Mean	Std Dev	Mean	Std Dev	Mean	Std Dev	Mean	Std Dev
D.H.	28	0.000 +/- 0.000		14.107 +/- 4.605		2.250 +/- 4.820		11.536 +/- 4.087		1.179 +/- 3.278	
Coeliacs	26	1.769 +/- 5.046		14.654 +/- 5.027		7.500 +/- 8.571		12.885 +/- 4.786		3.538 +/- 6.901	
Controls	203	1.227 +/- 4.068		14.650 +/- 5.760		3.660 +/- 6.336		12.532 +/- 4.475		0.714 +/- 2.505	

Table 8.37 - Mann-Whitney U Test Results - Individual Finger Ridge

Counts(a) MALES

PROBABILITY			
VARIABLE	CONT : DH	CONT:COEL	DH : COEL
LFU1	0.3286	0.4333	0.2791
LFR1	0.2167	0.9492	0.7335
LFU2	0.7934	0.9906	0.9728
LFR2	0.0248*	0.0107*	0.8554
LFU3	0.7727	0.5940	0.4881
LFR3	0.1706	0.0375*	0.0062**
LFU4	0.3045	0.2021	0.4413
LFR4	0.8033	0.2565	0.3231
LFU5	0.1374	0.6858	0.6565
LFR5	0.2662	0.6103	0.8951
RFR1	0.8192	0.9580	0.8606
RFU1	0.4686	0.3493	0.2258
RFR2	0.2135	0.2202	0.6383
RFU2	0.5859	0.4206	0.5202
RFR3	0.4383	0.0730	0.0639
RFU3	0.5113	0.1327	0.1921
RFR4	0.9451	0.0632	0.0480*
RFU4	0.6582	0.1944	0.2781
RFR5	0.2805	0.3107	0.8174
RFU5	0.6672	0.1272	0.1625

(b) FEMALES

LFU1	0.6707	0.7588	0.7465
LFR1	0.8476	0.2266	0.2586
LFU2	0.6294	0.1925	0.5017
LFR2	0.8681	0.6504	0.8686
LFU3	0.0681	0.0036**	0.0017**
LFR3	0.9049	0.8636	0.9033
LFU4	0.7730	0.0273*	0.0720
LFR4	0.0146*	0.8203	0.1649
LFU5	0.3679	0.0003**	0.1081
LFR5	0.2672	0.1227	0.0503
RFR1	0.6896	0.1955	0.2410
RFU1	0.9854	0.8321	0.8866
RFR2	0.0381*	0.8742	0.1474
RFU2	0.0507	0.0484*	0.7547
RFR3	0.9988	0.0171*	0.0903
RFU3	0.0921	0.1385	0.0160*
RFR4	0.3453	0.4116	0.9515
RFU4	0.2900	0.0156*	0.0125*
RFR5	0.2543	0.8984	0.3711
RFU5	0.5146	0.0290*	0.2948

Table 8.38 - Canonical Discriminant Functions - Males: LFU1 to RFU5

FUNCTION	EIGENVALUE	PERCENT OF VARIANCE	CUMULATIVE PERCENT	CANONICAL CORRELATION
1*	0.13986	49.19	49.19	0.3502833
2*	0.08563	30.14	79.33	0.2809259
3*	0.05878	20.67	100.00	0.2356196

Table 8.39 - Structure Matrix

	FUNC 1	FUNC 2	FUNC 3
LFR3	-0.40748*	-0.21991	0.34079
LFU2	0.33703*	0.10735	0.24850
LFR4	-0.24096*	0.01818	0.12854
RFU2	0.19251*	-0.07545	-0.06748
LFR2	-0.15731	0.47272*	0.18104
LFR5	0.18955	0.31910*	0.04394
RFR2	-0.26802	0.29763*	0.10450
LFR1	0.14134	-0.21300*	0.12819
LFU1	0.10088	0.17741*	0.16664
RFU1	0.02581	0.15995*	0.11917
LFU3	0.27131	0.04000	0.46759*
RFR5	0.16669	0.26124	0.34977*
LFU5	0.07948	0.14459	0.32460*
RFU4	-0.02570	0.26475	0.32018*
RFR3	0.17881	0.04263	0.29594*
RFU3	0.19412	0.04420	0.29099*
LFU4	-0.03202	0.19976	0.25876*
RFR4	-0.19075	0.04016	0.20903*
RFU5	0.02508	0.12047	0.17172*
RFR1	-0.01070	-0.05898	0.08864*

Table 8.40 - F Statistics - Males: LFU1 to RFU5

GROUP	GROUP	1	2	3
2		2.1487		
		0.0215		
3		1.7937	1.7950	
		0.0621	0.0619	
4		3.2446*	3.1285	1.9992
		0.0006	0.0009	0.0471

Group
1
2
3
4

Table 8.41 - Males: LFU1 to RFU5

Code	Group
1	Controls
2	OH
3	Coelinae
4	Coelinae unaffected relatives

CLASSIFICATION RESULTS

ACTUAL GROUP	NO. OF CASES	PREDICTED GROUP MEMBERSHIP			
		1	2	3	4
GROUP 1	200	92 46.0%	58 29.0%	33 16.5%	17 8.5%
GROUP 2	48	11 22.9%	25 52.1%	8 16.7%	4 8.3%
GROUP 3	9	2 22.2%	0 0.0%	6 66.7%	1 11.1%
GROUP 4	7	0 0.0%	0 0.0%	1 14.3%	5 85.7%

PERCENT OF "GROUPED" CASES CORRECTLY CLASSIFIED: 48.86%

Table 8.42 - Canonical Discriminant Functions - Females: LFU1 to RFU5

FUNCTION	EIGENVALUE	PERCENT OF VARIANCE	CUMULATIVE PERCENT	CANONICAL CORRELATION
1*	0.24297	63.37	63.37	0.4421243
2*	0.09276	24.19	87.56	0.2913512
3*	0.04770	12.44	100.00	0.2133719

Table 8.43 - Structure Matrix - Females: LFU1 to RFU5

	FUNC 1	FUNC 2	FUNC 3
LFU5	0.61342*	0.19165	0.08077
RFU5	0.40841*	0.17993	0.01813
LFU4	0.36746*	0.34533	0.04926
RFU2	0.31931*	0.18405	0.10620
RFU4	0.29816*	0.23936	-0.07187
LFU2	0.23229*	0.03195	-0.07457
RFR3	0.22825*	0.14872	0.10441
LFU3	0.35708	0.53147*	0.10454
RFR2	0.04643	0.43429*	0.08815
LFR4	0.07730	0.36407*	0.24649
RFU3	0.04485	0.36148*	0.13452
LFR5	0.21171	0.35759*	-0.32141
LFU1	0.10203	0.16365*	0.07172
LFR2	0.04996	0.15604*	0.13558
RFU1	0.03600	0.11120*	0.00211
LFR1	0.07612	0.12803	0.41143*
RFR5	0.12024	0.22369	-0.31890*
RFR1	-0.10777	-0.16114	0.22776*
RFR4	0.11409	0.12161	0.17530*
LFR3	0.01278	-0.05628	0.09261*

Table 8.44 - F Statistics - Females: LFU1 to RFU5

GROUP	GROUP	1	2	3
2		2.4033		
		0.0075		
3		5.2758	2.9616	
		0.0000	0.0010	
4		1.0749	1.2259	1.7749
		0.3821	0.2701	0.0598
Code	Group			
1	Controls			
2	DH			
3	Coeliacs			
4	Coeliac unaffected relatives			

Table 8.45 - Females: LFU1 to RFU5

Code	Group
1	Controls
2	DII
3	Celiac
4	Celiac unaffected relatives

CLASSIFICATION RESULTS

ACTUAL GROUP	NO. OF CASES	PREDICTED GROUP MEMBERSHIP			
		1	2	3	4
GROUP 1	202	108 53.5%	46 22.8%	20 9.9%	28 13.9%
GROUP 2	28	9 32.1%	14 50.0%	4 14.3%	1 3.6%
GROUP 3	26	6 23.1%	5 19.2%	13 50.0%	2 7.7%
GROUP 4	4	0 0.0%	1 25.0%	0 0.0%	3 75.0%

PERCENT OF "GROUPED" CASES CORRECTLY CLASSIFIED: 53.08%

Table 8.46

Means and Standard Deviations

Finger Ridge Counts

Males

(a) Right Hand

		Variables									
		RF1		RF2		RF3		RF4		RF5	
Groups	Cases	Mean	Std Dev	Mean	Std Dev	Mean	Std Dev	Mean	Std Dev	Mean	Std Dev
D.H.	48	20.354 +/- 5.147		12.229 +/- 6.366		14.146 +/- 5.856		16.229 +/- 5.020		13.292 +/- 3.820	
Coeliacs	10	19.444 +/- 8.487		11.222 +/- 8.105		9.556 +/- 6.654		12.000 +/- 7.211		11.222 +/- 7.085	
Controls	206	19.951 +/- 5.065		12.709 +/- 6.951		13.602 +/- 5.762		16.374 +/- 5.958		14.083 +/- 5.018	

(b) Left Hand

		Variables									
		LF1		LF2		LF3		LF4		LF5	
Groups	n	Mean	Std Dev	Mean	Std Dev	Mean	Std Dev	Mean	Std Dev	Mean	Std Dev
D.H.	48	19.063 +/- 5.021		11.396 +/- 5.866		14.917 +/- 5.069		16.042 +/- 5.206		12.729 +/- 4.404	
Coeliacs	10	18.222 +/- 8.303		8.778 +/- 7.855		9.889 +/- 5.840		14.333 +/- 6.745		13.111 +/- 3.723	
Controls	206	18.257 +/- 5.506		12.709 +/- 6.871		13.854 +/- 6.225		16.184 +/- 6.386		13.883 +/- 5.068	

Table 8.47

Means and Standard Deviations

Finger Ridge Counts

Females

(a) Right Hand

		Variables									
		RF 1		RF 2		RF 3		RF4		RF5	
Groups	Cases	Mean	Std Dev	Mean	Std Dev	Mean	Std Dev	Mean	Std Dev	Mean	Std Dev
D.H.	28	17.643	+/- 5.908	10.679	+/- 5.957	11.179	+/- 5.863	14.107	+/- 4.605	11.536	+/- 4.087
Coeliacs	26	17.077	+/- 4.279	13.346	+/- 6.118	13.692	+/- 6.529	15.000	+/- 5.122	13.038	+/- 4.754
Controls	203	17.143	+/- 5.335	11.177	+/- 6.231	11.458	+/- 5.522	14.921	+/- 5.663	12.542	+/- 4.467

		Variables									
		LF1		LF2		LF3		LF4		LF5	
Groups	Cases	Mean	Std Dev	Mean	Std Dev	Mean	Std Dev	Mean	Std Dev	Mean	Std Dev
D.H.	28	16.107	+/- 4.924	11.571	+/- 5.439	11.929	+/- 5.011	12.500	+/- 4.718	11.107	+/- 4.306
Coeliacs	26	16.269	+/- 4.747	12.615	+/- 7.245	11.923	+/- 6.957	14.615	+/- 6.407	14.462	+/- 4.785
Controls	203	15.961	+/- 5.715	10.847	+/- 6.251	11.700	+/- 5.376	14.897	+/- 5.320	12.251	+/- 4.478

Table 8.48 - Mann-Whitney U Test Probabilities

(a) MALES

VARIABLE	CONT : DH	CONT:COEL	DH : COEL
RF1	0.8006	0.9757	0.9475
RF2	0.6223	0.6243	0.7924
RF3	0.6157	0.0527	0.0593
RF4	0.6604	0.0416*	0.0480*
RF5	0.2509	0.3055	0.8174
LF1	0.2588	0.9492	0.8006
LF2	0.1276	0.1140	0.4296
LF3	0.2781	0.0314*	0.0065**
LF4	0.6463	0.3610	0.4754
LF5	0.2262	0.5797	0.8951

(b) FEMALES

RF1	0.5943	0.6407	0.4190
RF2	0.6602	0.0739	0.0976
RF3	0.8822	0.0191*	0.0750
RF4	0.2461	0.5921	0.7544
RF5	0.2524	0.7275	0.2702
LF1	0.8005	0.6981	0.9238
LF2	0.6812	0.1824	0.4558
LF3	0.9662	0.8426	0.9723
LF4	0.0066**	0.8314	0.1401
LF5	0.2270	0.0419*	0.0153*

(ii) Unilateral Finger Ridge Counts - Variables: RF1 to LF5

Coeliac male subjects were found to have significantly lower individual finger ridge counts in comparison to both of the other groups on fingers LIII and RIV (Tables 8.46 and 8.48). Coeliac female subjects were found to have significantly higher ridge counts on RIII in comparison to controls and on RV in comparison to controls and to DH female subjects. DH female subjects were found to have a highly significantly lower count on LIV in comparison to controls (Tables 8.47 and 8.48).

The results of discriminant analysis for males are shown in Tables 8.49 to 8.52. Three canonical discriminant functions were produced with Function 1 accounting for 49.26% of the variance and Function 2 another 35.75% (Table 8.49). The structure matrix (Table 8.50) shows that the main variance in Function 1 was LF3 and those in Function 2 were the counts on fingers IV and V of both hands plus LI. The most widely separated groups were controls and DH ($F = 3.3396$) (Table 8.51). Figures 8.13 and 8.14 show the group members distributed in space using Functions 1 and 2. Good differences are shown between the group centroids with DH being furthest right, next to it are controls followed by Coeliacs and Coeliac relatives to the left.

Classification results show 37.88% correctness. Coeliac unaffected relatives (57.1%) followed by DH subjects (54.2%) show the best classification (Table 8.52).

Table 8.53 to 8.56 show the results of discriminant analysis for female subjects using variables RF1 to LF5. Three canonical discriminant functions were produced with Function 1 accounting for 51.82% of the variance and Function 2 taking out another 29.25% (Table 8.53). The structure matrix shows RF3, RF2 and LF2 to be the most important variables in Function 1 (Table 8.54). The Table of F statistics and significances between groups shows controls and Coeliacs to be the most widely separated ($F = 3.4454$) followed by DH and Coeliacs ($F = 2.8587$) (Table 8.55). Figures 8.15 and 8.16 show that controls and DH are close together with Coeliacs removed to the right and unaffected relatives furthest away to the left.

Classification results show 40% correctness with best groups being Coeliac unaffected relatives (75%) followed by Coeliacs (53.8%) and DH (53.6%) see Table 8.56.

Table 8.49 - Canonical Discriminant Functions - Males: RF1 to LF5

FUNCTION	EIGENVALUE	PERCENT OF VARIANCE	CUMULATIVE PERCENT	CANONICAL CORRELATION
1*	0.06096	49.25	49.25	0.2396997
2*	0.04423	35.75	85.01	0.2058163
3*	0.01855	14.99	100.00	0.1349635

Table 8.50 - Structure Matrix

	FUNC 1	FUNC 2	FUNC 3
LF3	0.55563*	0.23467	0.43505
LF5	-0.11031	0.54306*	-0.01439
RF5	0.07647	0.39856*	0.18379
LF1	-0.00009	-0.37646*	0.30932
RF4	0.21452	0.30621*	0.29942
LF4	0.23503	0.29840*	0.25140
LF2	-0.09873	0.37805	0.79929*
RF3	0.30034	0.16334	0.51174*
RF2	0.14205	0.28945	0.47670*
RF1	0.00767	-0.08326	0.32571*

Table 8.51 - F Statistics and significances

GROUP	GROUP	1	2	3
2		3.3396 0.0109		
3		1.9176 0.1079	2.5091 0.0424	
4		2.6305 0.0349	2.9321 0.0214	1.3232 0.2617

Code Group
 1 Controls
 2 DM
 3 Coeliacs
 4 Coeliac unaffected relatives

Figure 8.13 - Males: RF1 to LF5

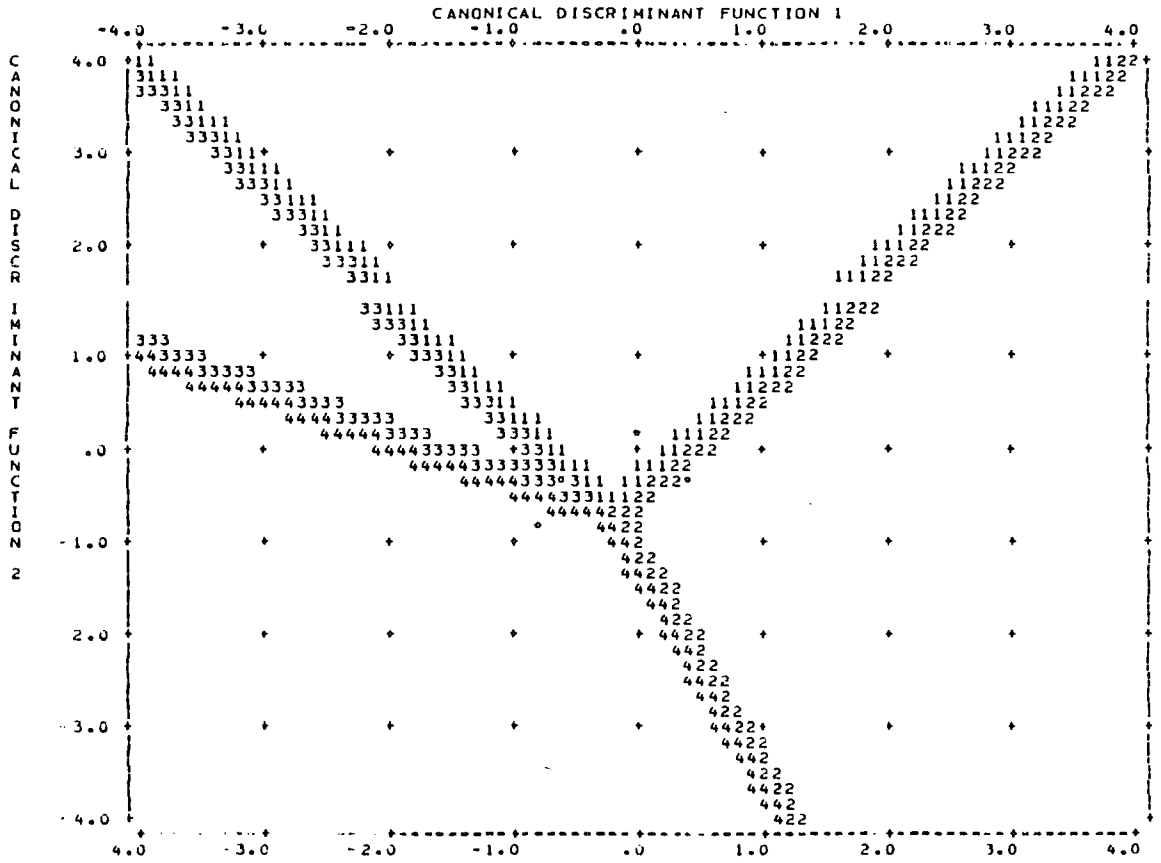

Code	Group
1	Controls
2	DM
3	Coeliacs
4	Coeliac unaffected relatives

Figure 8.14 - Males: RF1 to LF5

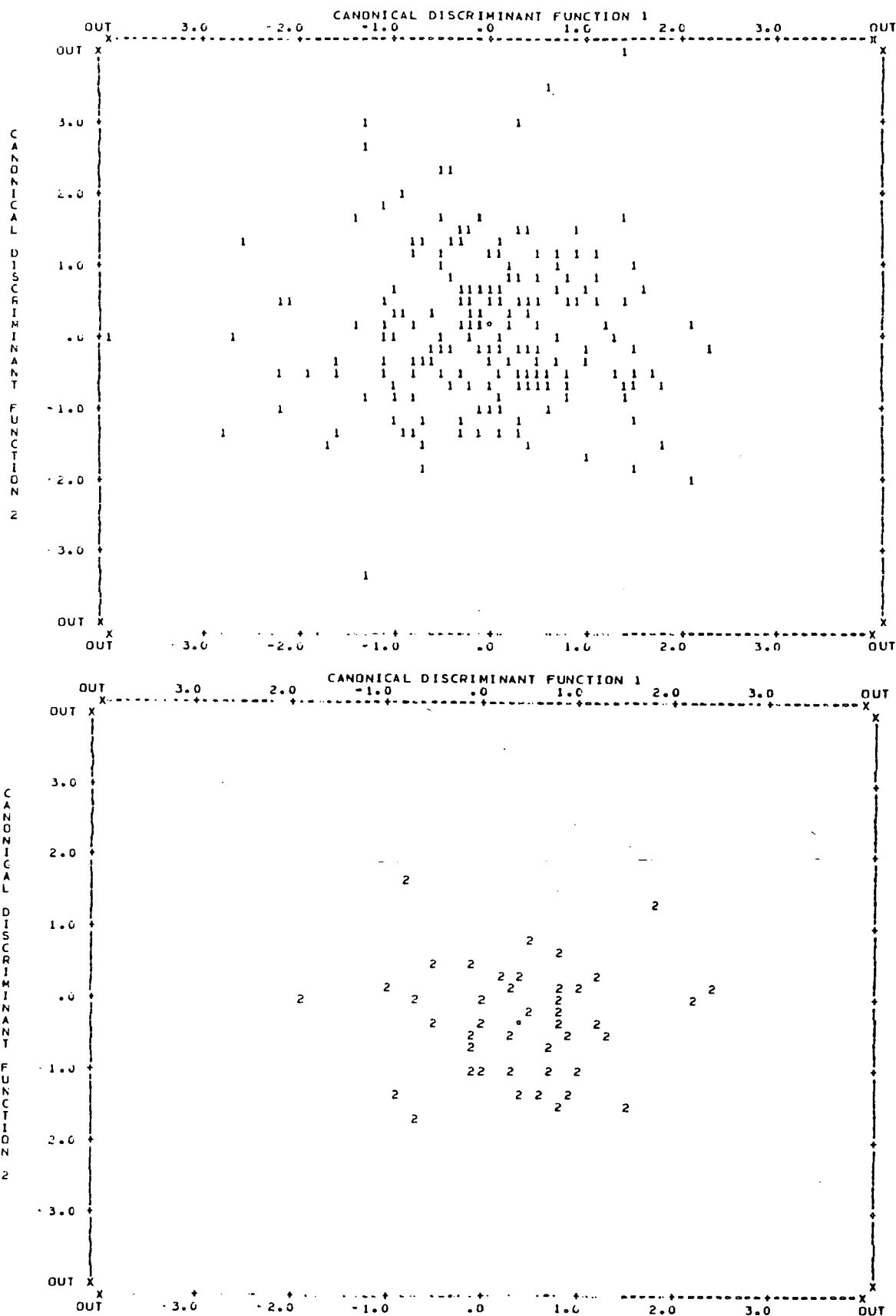

Figure 8.14 continued

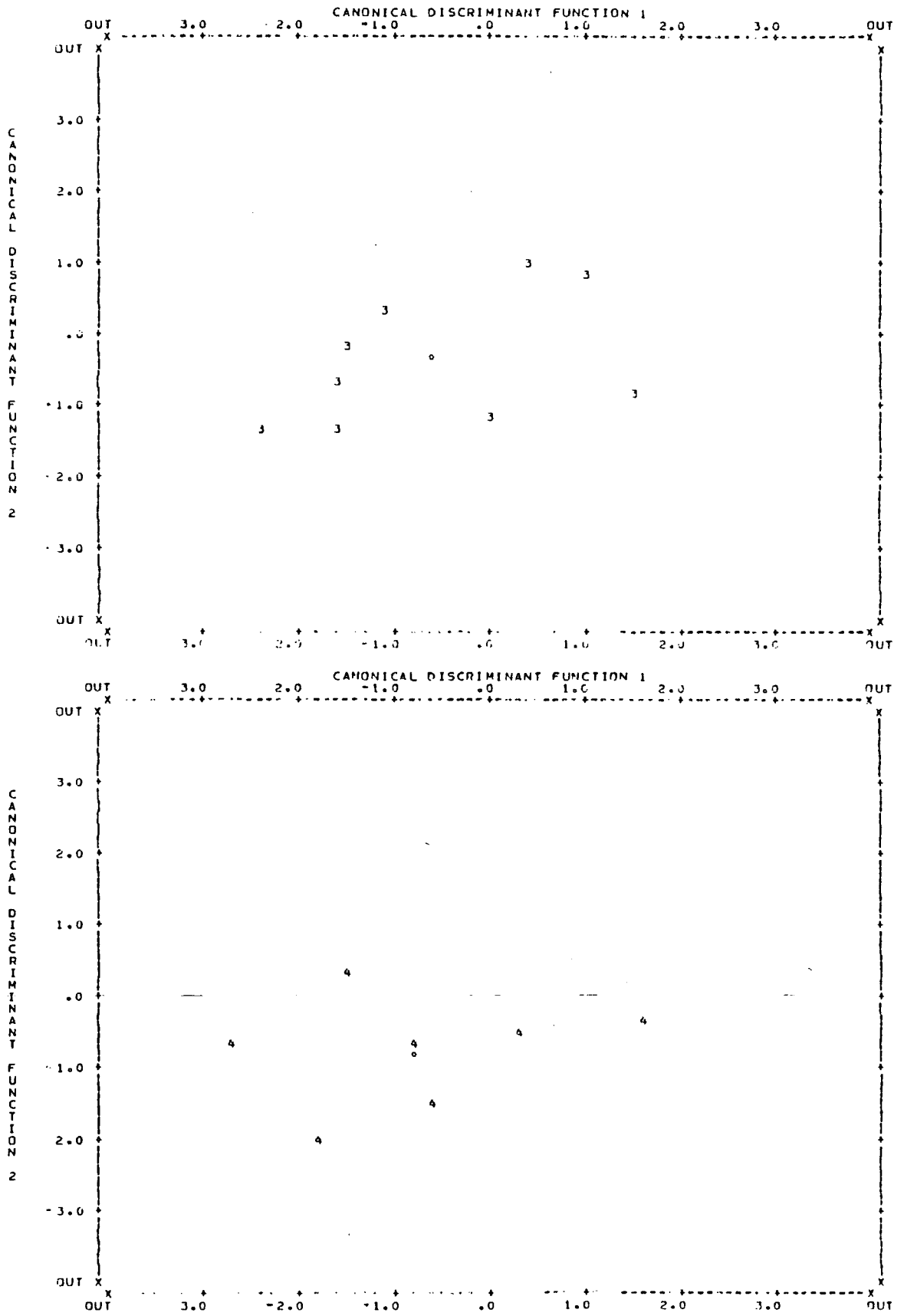

Table 8.52 - Males: RF1 to LF5

Code	Group
1	Controls
2	DH
3	Coeliacs
4	Coeliac unaffected relatives

CLASSIFICATION RESULTS

ACTUAL GROUP	NO. OF CASES	PREDICTED GROUP MEMBERSHIP			
		1	2	3	4
GROUP 1	200	68 34.0%	60 30.0%	36 18.0%	36 18.0%
GROUP 2	48	9 18.8%	26 54.2%	6 12.5%	7 14.6%
GROUP 3	9	2 22.2%	2 22.2%	2 22.2%	3 33.3%
GROUP 4	7	0 0.0%	1 14.3%	2 28.6%	4 57.1%

PERCENT OF "GROUPED" CASES CORRECTLY CLASSIFIED: 37.88%

Table 8.53 - Canonical Discriminant Functions - Females: RF1 to LF1

FUNCTION	EIGENVALUE	PERCENT OF VARIANCE	CUMULATIVE PERCENT	CANONICAL CORRELATION
1*	0.08675	51.82	51.82	0.2825273
2*	0.04896	29.25	81.07	0.2160361
3*	0.03169	18.93	100.00	0.1752741

Table 8.54 - Structure Matrix

	FUNC 1	FUNC 2	FUNC 3
RF3	0.42819*	0.02342	0.06740
RF2	0.25058*	0.05711	0.10468
LF2	0.17968*	0.00870	0.12899
LF4	-0.02205	0.56921*	0.39297
LF5	0.49191	0.53294*	0.06050
RF5	0.24624	0.44196*	0.03181
LF1	0.13168	-0.31444*	0.30143
RF4	0.11685	0.28585*	0.16584
LF3	0.05283	-0.10300*	0.02081
RF1	-0.06366	0.05515	-0.29918*

Table 8.55 - F Statistics and significances between groups

GROUP	GROUP 1	GROUP 2	GROUP 3
2	1.6693 0.1290		
3	3.4454 0.0027	2.8587 0.0104	
4	1.7611 0.1076	1.9954 0.0669	2.3404 0.0323

Code	Group
1	Controls
2	DII
3	Coeliacs
4	Coeliac unaffected relatives

Figure 8.15 - Females: RF1 to LF5

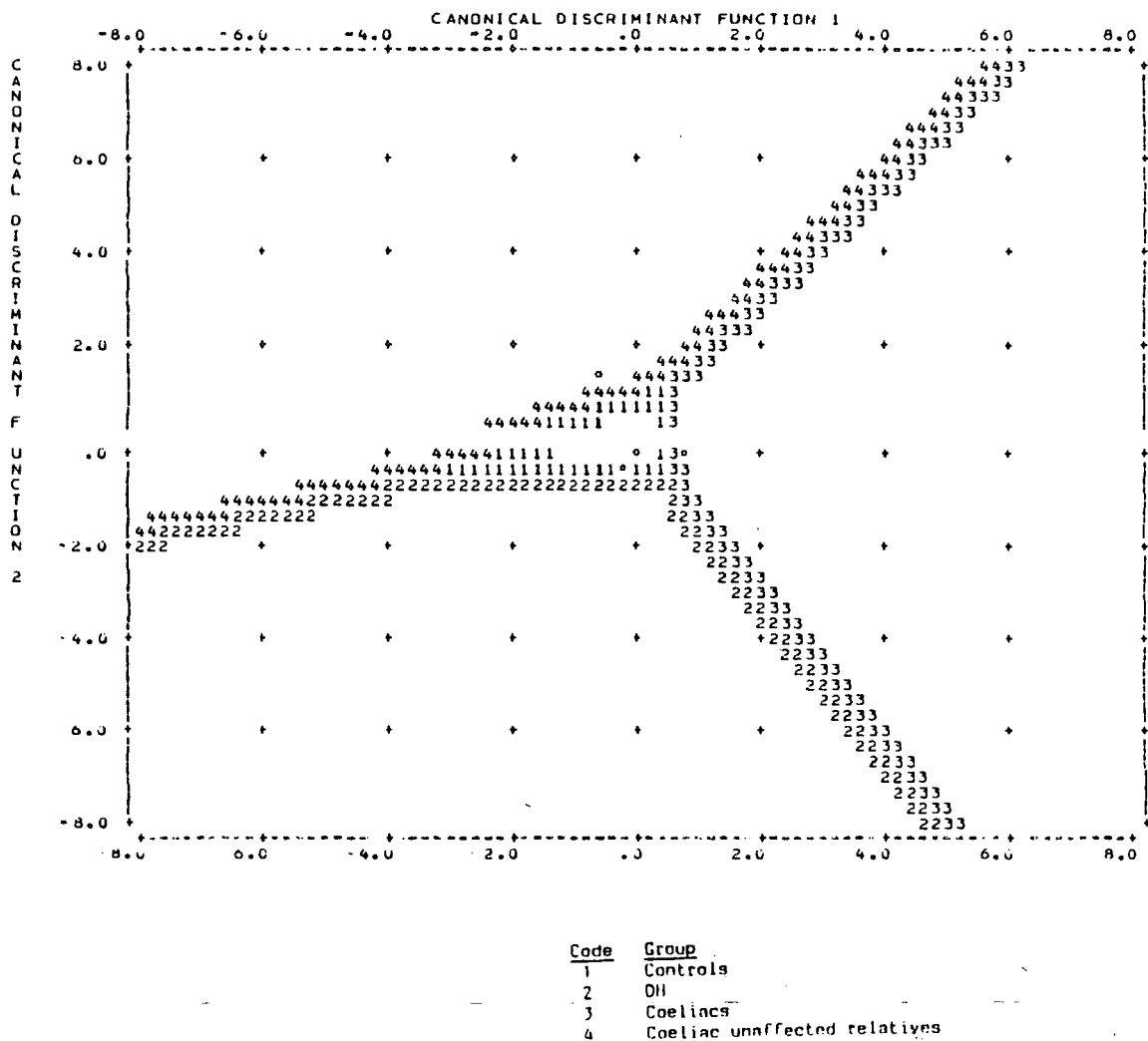

Figure 8.16 - Females: RF1 to LF5

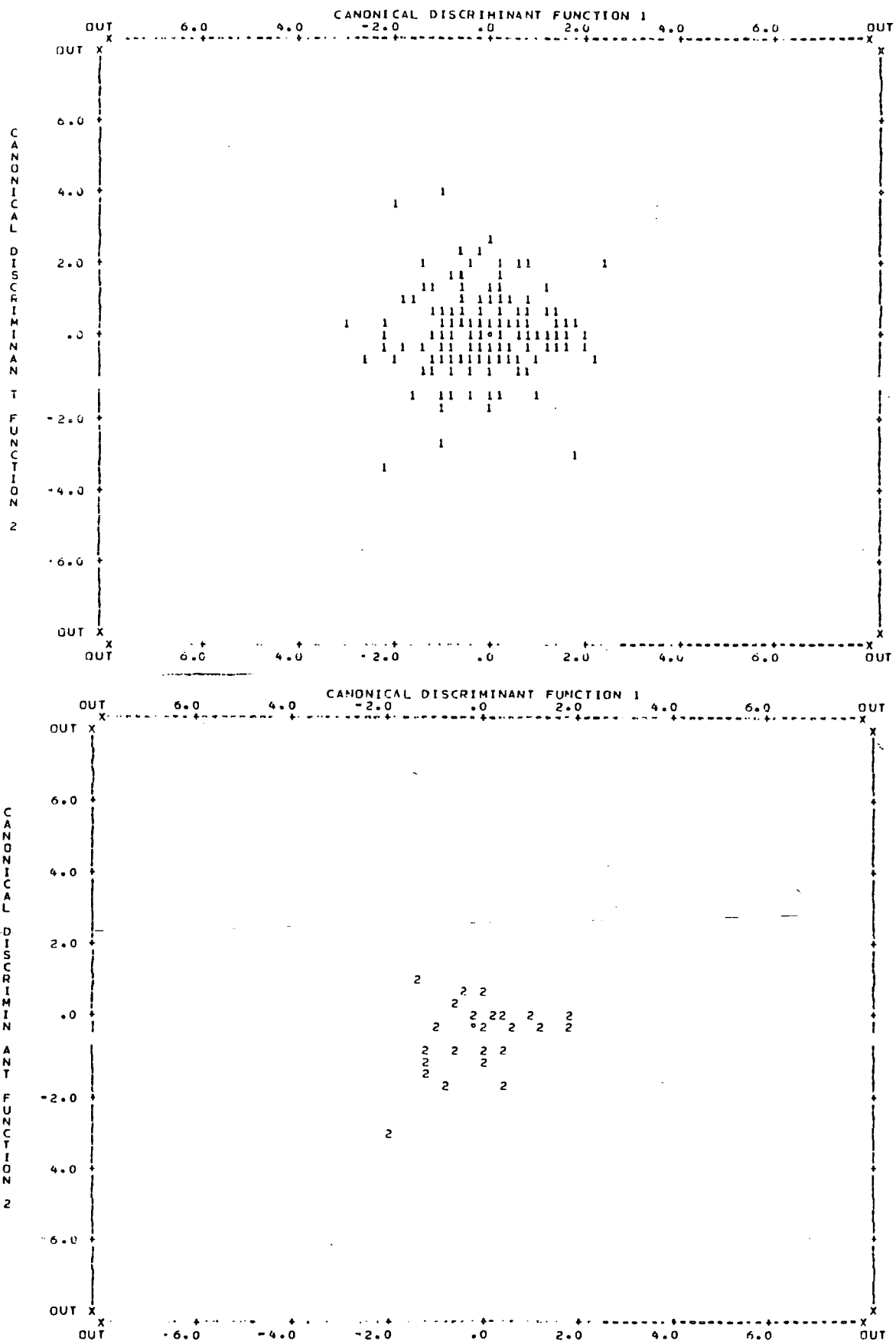

Figure 8.16 continued

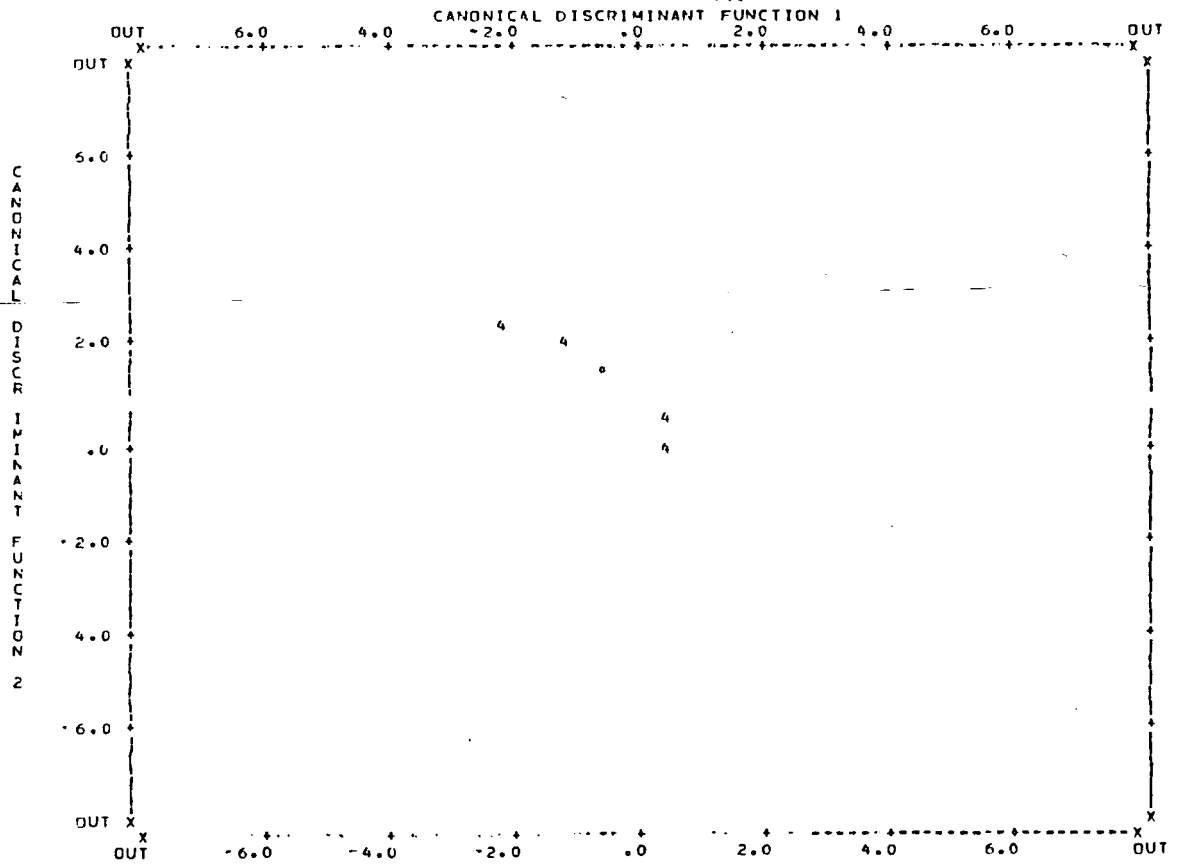
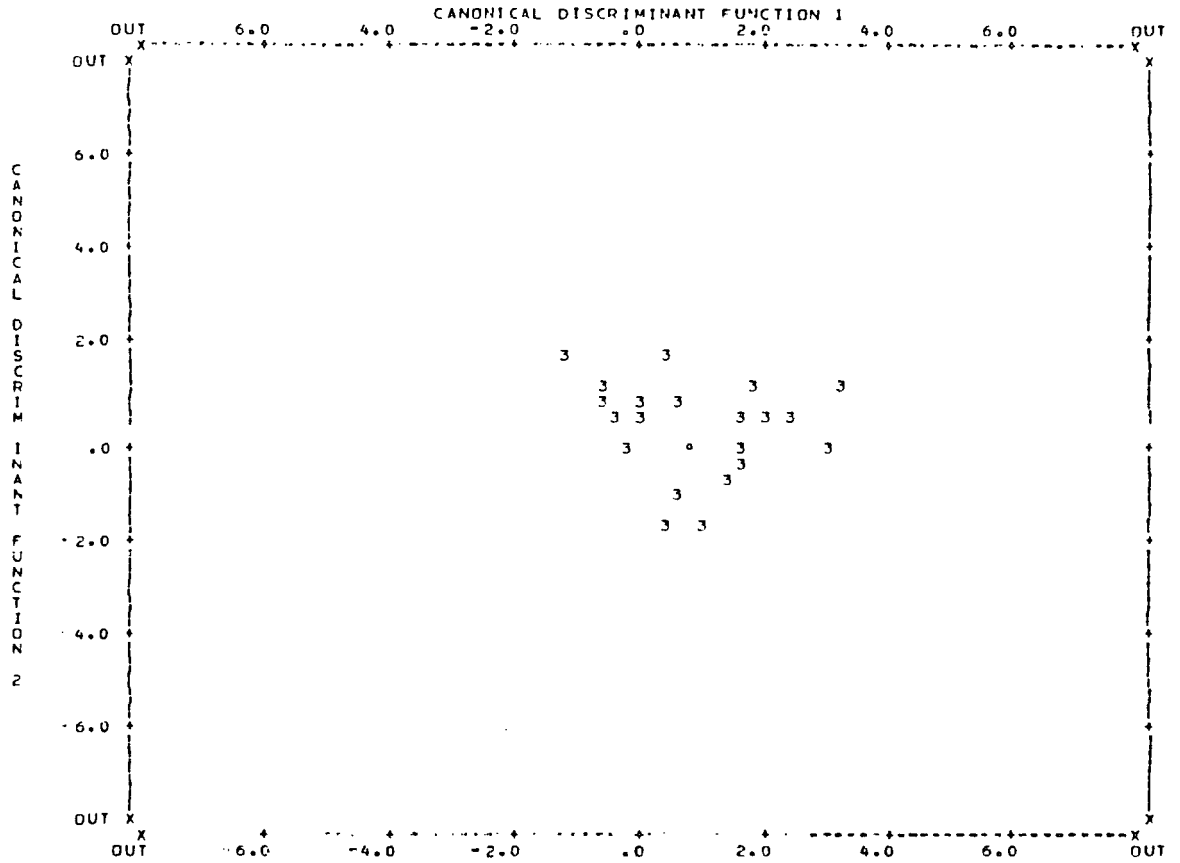

Table 8.56 - Classification Results - Females: RF1 to LF5

Code Group
 1 Controls
 2 DH
 3 Coeliacs
 4 Coeliac unaffected relatives

CLASSIFICATION RESULTS

ACTUAL GROUP	NO. OF CASES	PREDICTED GROUP MEMBERSHIP			
		1	2	3	4
GROUP 1	202	72 35.6%	48 23.9%	50 24.8%	32 15.9%
GROUP 2	28	5 17.9%	15 53.6%	6 21.4%	2 7.1%
GROUP 3	26	5 19.2%	5 19.2%	14 53.8%	2 7.7%
GROUP 4	4	0 0.0%	0 0.0%	1 25.0%	3 75.0%

PERCENT OF "GROUPED" CASES CORRECTLY CLASSIFIED: 40.00%

(iii) Absolute Ridge Counts - Variables: RFA1 to LFA5

Male Coeliac subjects were found to have statistically significantly lower absolute ridge counts on finger III of both hands in comparison to the other two groups (Table 8.57a and 8.58a).

Female Coeliacs were found to have a statistically significantly higher ridge count in comparison to DH females and a significantly lower count compared to controls on finger LV (Tables 8.57b and 8.58b).

The results of discriminant function analysis for males show that Function 1 accounts for 50.15% of the variance and Function 2 for a further 40.4%. Function 1 is made up of the absolute ridge counts of finger III of both hands (Tables 8.59 and 8.60). The most widely separated groups according to Table 8.61 are DH and Coeliacs ($F = 2.8713$), Coeliacs and controls ($F = 2.4492$) and controls and DH ($F = 2.2276$) in all cases the differences are significant at the 5% level. The territorial map (Figure 8.17) and the scatterplots (Figure 8.18) show that controls and unaffected relatives be close together with DH and Coeliacs separated from them in opposite directions. Classification results show 34.47% correct grouping with Coeliacs (66.7%) and DH (56.3%) being the best grouped (Table 8.62).

Discriminant analysis for females shows Function 1 to account for 75.36% of the variance. Seven of the variables are important in Function 1 (Tables 8.63 and 8.64). The F Statistics Table shows that controls and Coeliacs ($F = 6.45$) and DH and Coeliacs ($F = 5.1477$) are the most widely spread groups and both differences are highly significant (Table 8.65). Figures 8.19 and 8.20 show controls and DH to be closest with Coeliacs and unaffected relatives removed from them. Classification results show 39.23% correct grouping with best results being for Coeliacs unaffected relatives (75%) followed by DH (64.3%) and Coeliacs (46.2%) see Table 8.66.

Table 8.57(a)

Means and Standard Deviations

Absolute Ridge Counts

Males

		Variables									
Groups	Cases	RFA1		RFA2		RFA3		RFA4		RFA5	
		Mean	Std Dev	Mean	Std Dev	Mean	Std Dev	Mean	Std Dev	Mean	Std Dev
D.H.	48	26.688	+/- 12.685	16.542	+/- 12.097	16.396	+/- 9.635	21.792	+/- 9.565	14.688	+/- 5.904
Coeliacs	10	28.889	+/- 16.275	16.778	+/- 14.351	9.556	+/- 6.654	15.333	+/- 10.536	11.222	+/- 7.085
Controls	206	27.189	+/- 11.526	17.335	+/- 12.317	16.476	+/- 10.232	22.806	+/- 12.187	15.883	+/- 7.712

		Variables									
Groups	Cases	LFA1		LFA2		LFA3		LFA4		LFA5	
		Mean	Std Dev	Mean	Std Dev	Mean	Std Dev	Mean	Std Dev	Mean	Std Dev
D.H.	48	23.917	+/- 11.259	14.000	+/- 10.112	17.146	+/- 8.192	20.250	+/- 10.012	13.688	+/- 6.595
Coeliacs	10	26.556	+/- 16.957	13.333	+/- 12.718	9.889	+/- 5.840	15.000	+/- 6.892	13.778	+/- 3.632
Controls	206	24.277	+/- 11.532	16.854	+/- 12.074	15.883	+/- 9.308	21.243	+/- 11.864	15.330	+/- 7.249

Table 8.57(b)

Means and Standard Deviations

Absolute Ridge Counts

Females

		Variables									
		RFA1		RFA2		RFA3		RFA4		RFA5	
Groups	Cases	Mean	Std Dev	Mean	Std Dev	Mean	Std Dev	Mean	Std Dev	Mean	Std Dev
D.H.	28	22.250 +/- 11.024		13.536 +/- 10.823		11.179 +/- 5.863		16.357 +/- 7.851		12.714 +/- 6.235	
Coeliacs	26	20.423 +/- 9.261		17.615 +/- 10.696		15.308 +/- 9.290		22.154 +/- 12.620		16.423 +/- 10.458	
Controls	203	21.286 +/- 9.933		14.320 +/- 10.470		12.542 +/- 7.452		18.310 +/- 9.555		13.246 +/- 5.401	

		Variables									
		LFA1		LFA2		LFA3		LFA4		LFA5	
Groups	Cases	Mean	Std Dev	Mean	Std Dev	Mean	Std Dev	Mean	Std Dev	Mean	Std Dev
D.H.	28	20.036 +/- 10.203		14.536 +/- 9.939		11.929 +/- 5.011		15.036 +/- 8.830		12.393 +/- 6.962	
Coeliacs	26	19.308 +/- 10.007		16.808 +/- 11.812		16.308 +/- 13.392		21.731 +/- 14.543		18.577 +/- 10.037	
Controls	203	19.916 +/- 10.383		13.532 +/- 10.258		13.084 +/- 8.005		17.867 +/- 9.145		13.000 +/- 5.637	

Table 8.58 - Probabilities from Mann-Whitney U Test Comparisons

(a) MALES

VARIABLE	CONT : DH	CONT:COEL	DH : COEL
RFA1	0.5461	0.7864	0.7842
RFA2	0.6944	0.7338	0.9041
RFA3	0.7112	0.0379*	0.0363*
RFA4	0.7909	0.0961	0.1251
RFA5	0.4523	0.1690	0.4685
LFA1	0.8742	0.8035	0.8265
LFA2	0.1594	0.3290	0.7096
LFA3	0.1996	0.0268*	0.0050*
LFA4	0.7392	0.1720	0.2367
LFA5	0.1358	0.6902	0.5531

(b) FEMALES

RFA1	0.7951	0.4016	0.4825
RFA2	0.5785	0.0684	0.0757
RFA3	0.6159	0.0606	0.0737
RFA4	0.1689	0.4500	0.2024
RFA5	0.3218	0.6454	0.3142
LFA1	0.7788	0.4935	0.7947
LFA2	0.5036	0.1915	0.4937
LFA3	0.8172	0.7720	0.8351
LFA4	0.0324*	0.4332	0.1032
LFA5	0.3167	0.0180*	0.0195*

Table 8.59 - Canonical Discriminant Functions - Males: RFA1 to LFA5

FUNCTION	EIGENVALUE	PERCENT OF VARIANCE	CUMULATIVE PERCENT	CANONICAL CORRELATION
1*	0.06955	50.15	50.15	0.2550015
2*	0.05602	40.45	90.55	0.2303275
3*	0.01310	9.45	100.00	0.1137177

Table 8.60 - Structure Matrix

	FUNC 1	FUNC 2	FUNC 3
LFA3	0.47190*	0.19828	-0.08781
RFA3	0.27590*	0.22715	-0.02934
LFA2	0.09356	0.56413*	0.00729
RFA5	0.16855	0.54178*	-0.26313
LFA5	-0.11816	0.37784*	-0.33158
RFA4	0.13328	0.31564*	0.11950
LFA4	0.09951	0.23603*	-0.14419
LFA1	-0.14338	0.12400	0.54616*
RFA1	0.11404	0.10760	0.22989*
RFA2	-0.05124	0.10267	-0.22371*

Table 8.61 - F Statistics and significances between groups

GROUP	GROUP 1	GROUP 2	GROUP 3
2	2.2276 0.0410		
3	2.4492 0.0255	2.8713 0.0100	
4	0.98056 0.4383	1.6316 0.1387	2.1989 0.0436

Code	Group
1	Controls
2	DM
3	Celiac
4	Celiac unaffected relatives

Figure 8.17 - Males: RFA1 to LFA5

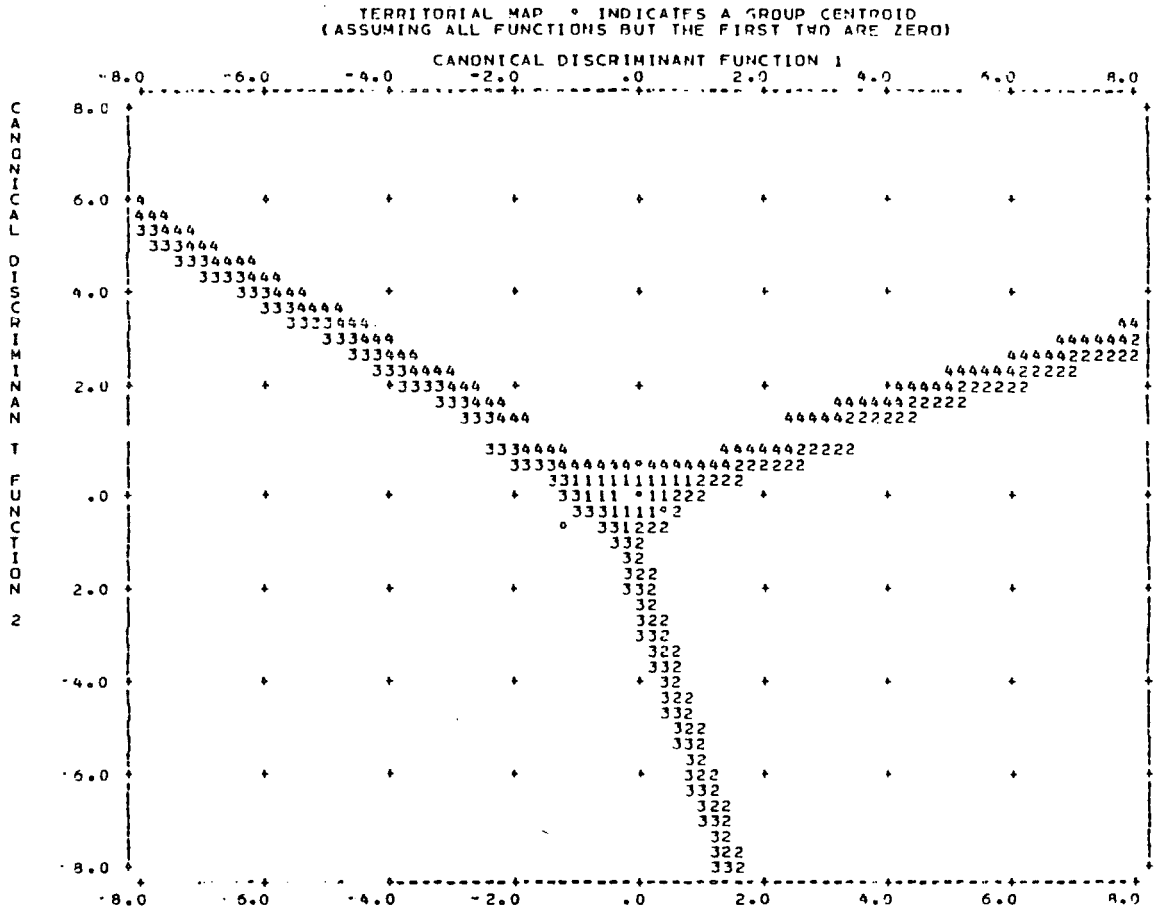

Code	Group
1	Control
2	DH
3	Coeliac
4	Coeliac unaffected relatives

Figure 8.18 - Males: RFA1 to LFA5

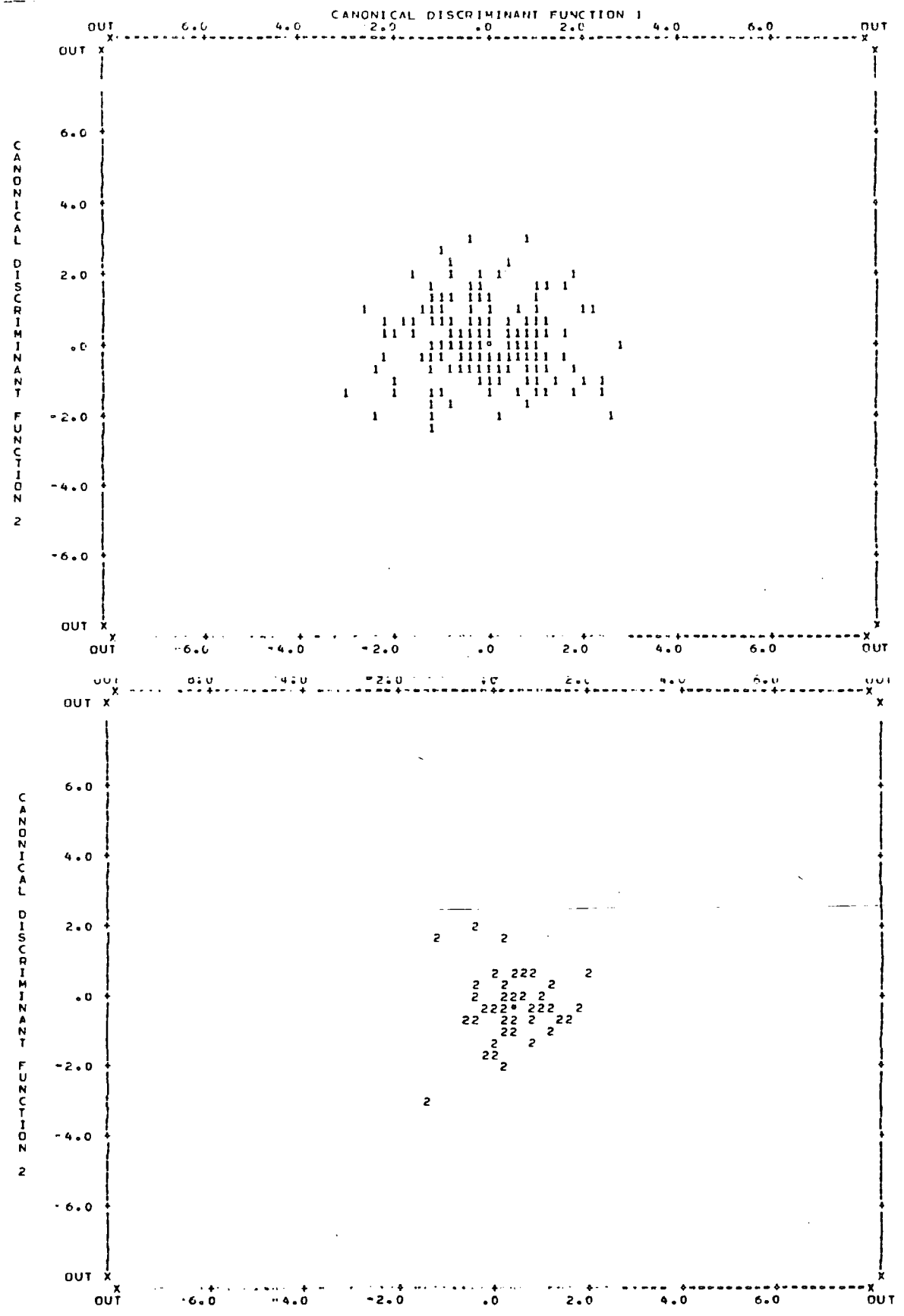

Figure 8.18 continued

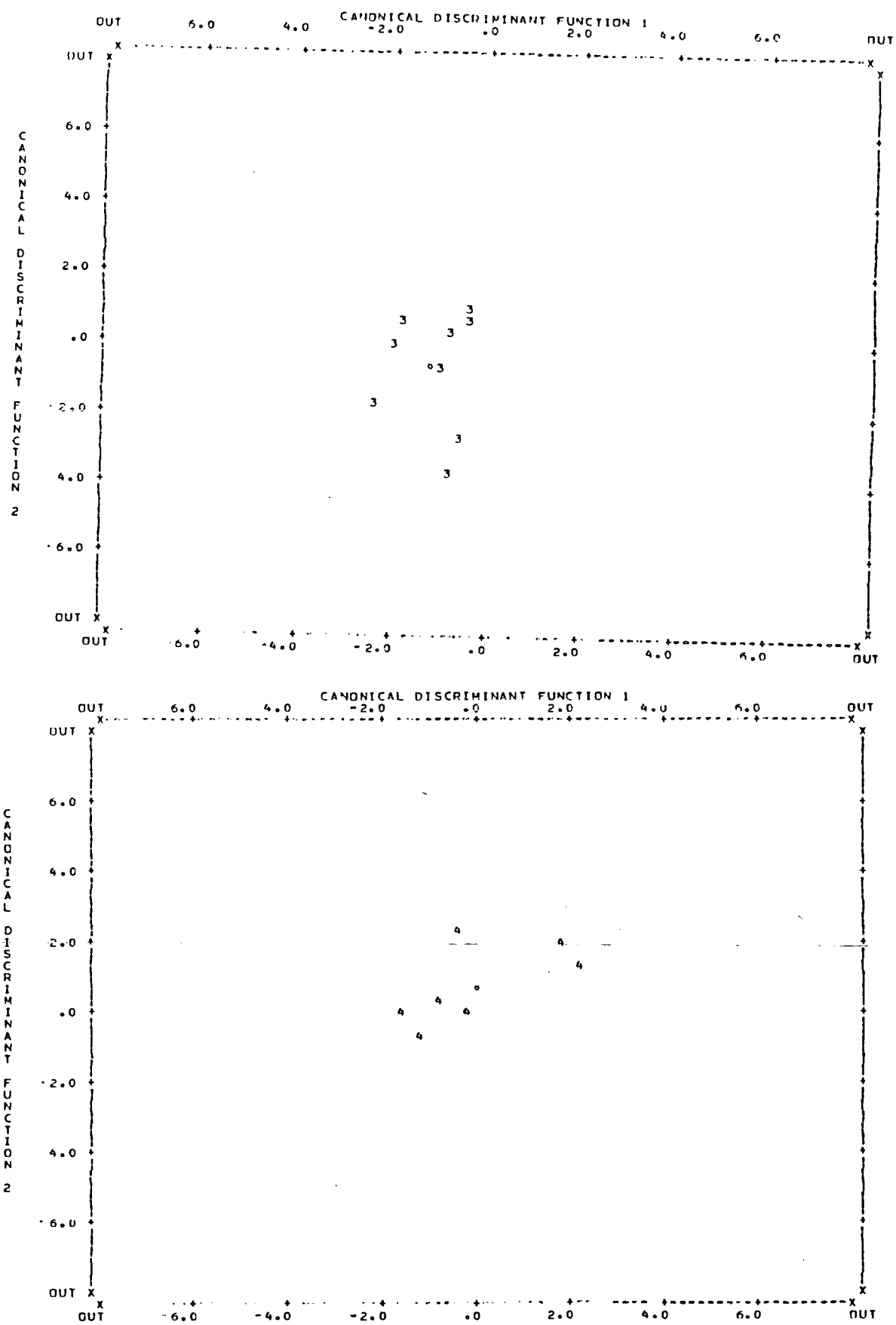

Table 8.62 - Males: RFA1 to LFA5

CLASSIFICATION RESULTS

ACTUAL GROUP		NO. OF CASES	PREDICTED GROUP MEMBERSHIP			
			1	2	3	4
GROUP	1	200	55 27.5%	65 32.5%	36 18.0%	44 22.0%
GROUP	2	48	7 14.6%	27 56.3%	5 10.4%	9 18.8%
GROUP	3	9	1 11.1%	0 0.0%	6 66.7%	2 22.2%
GROUP	4	7	2 28.6%	0 0.0%	2 28.6%	3 42.9%

PERCENT OF "GROUPED" CASES CORRECTLY CLASSIFIED: 34.47%

Table 8.63 - Canonical Discriminant Functions - Females: RFA1 to LFA5

FUNCTION	EIGENVALUE	PERCENT OF VARIANCE	CUMULATIVE PERCENT	CANON. CORRELAT.
1*	0.11075	75.36	75.36	0.3157601
2*	0.02409	16.38	91.75	0.1533347
3*	0.01213	9.25	100.00	0.1094550

Table 8.64 - Structure Matrix

	FUNC 1	FUNC 2	FUNC 3
LFA5	0.81753*	0.15900	0.16636
RFA5	0.51139*	0.07346	0.07907
RFA4	0.40354*	0.23856	-0.28309
LFA3	0.30631*	0.15831	-0.29323
RFA3	0.27953*	0.10541	0.11747
RFA2	0.26807*	0.20662	-0.10673
LFA2	0.24861*	0.22293	-0.03138
LFA1	0.09882	0.56920*	0.26958
RFA1	-0.09285	-0.23466*	0.16354
LFA4	0.41629	0.32694	-0.53135*

Table 8.65 - F Statistics and significances between groups

GROUP	GROUP 1	GROUP 2	GROUP 3
2	0.95757 0.4314		
3	6.4500 0.0001	5.1477 0.0005	
4	1.6907 0.1526	1.5796 0.1802	1.5317 0.1667

Code	Group
1	Controls
2	DM
3	Coeliac
4	Coeliac unaffected relatives

Figure 8.19 - Females: RFA1 to LFA5

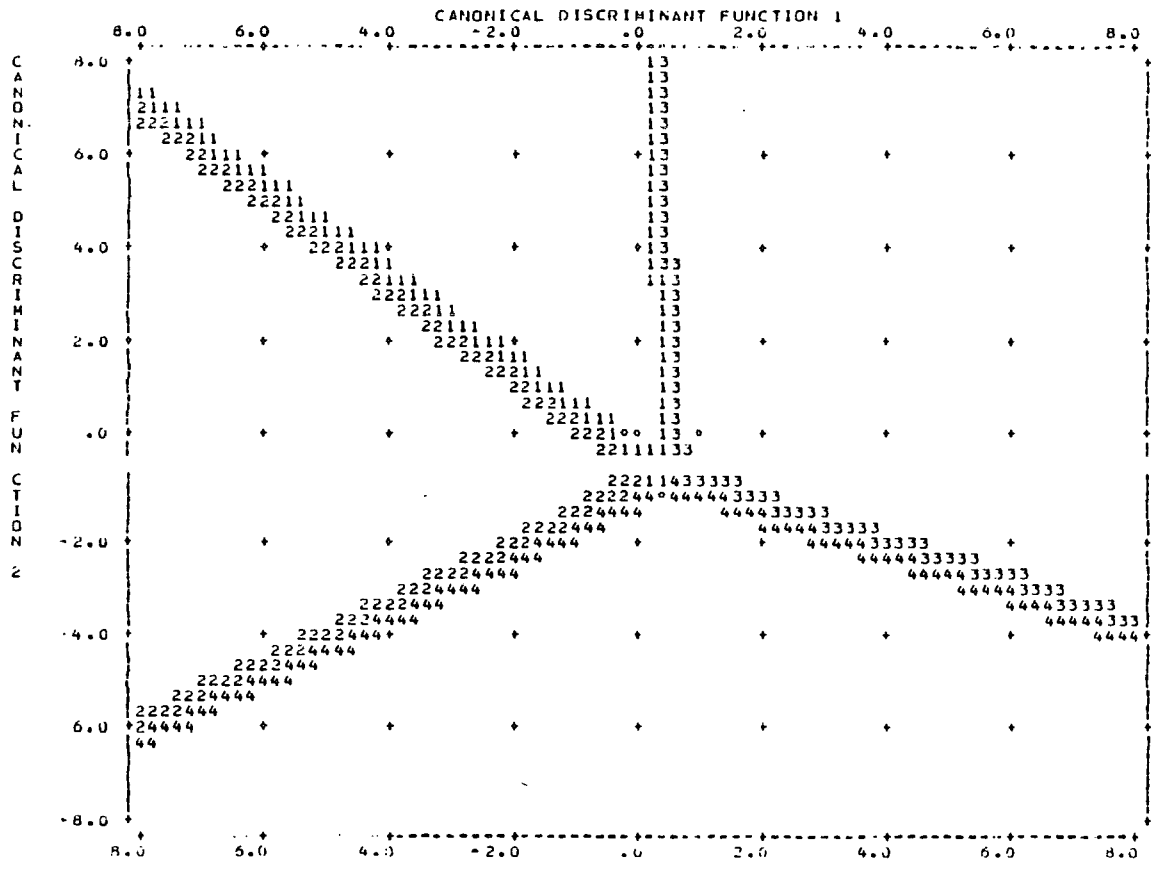

Code	Group
1	Controls
2	DM
3	Coeliacs
4	Coeliac unaffected relatives

Figure 8.20 - Females: RFA1 to LFA5

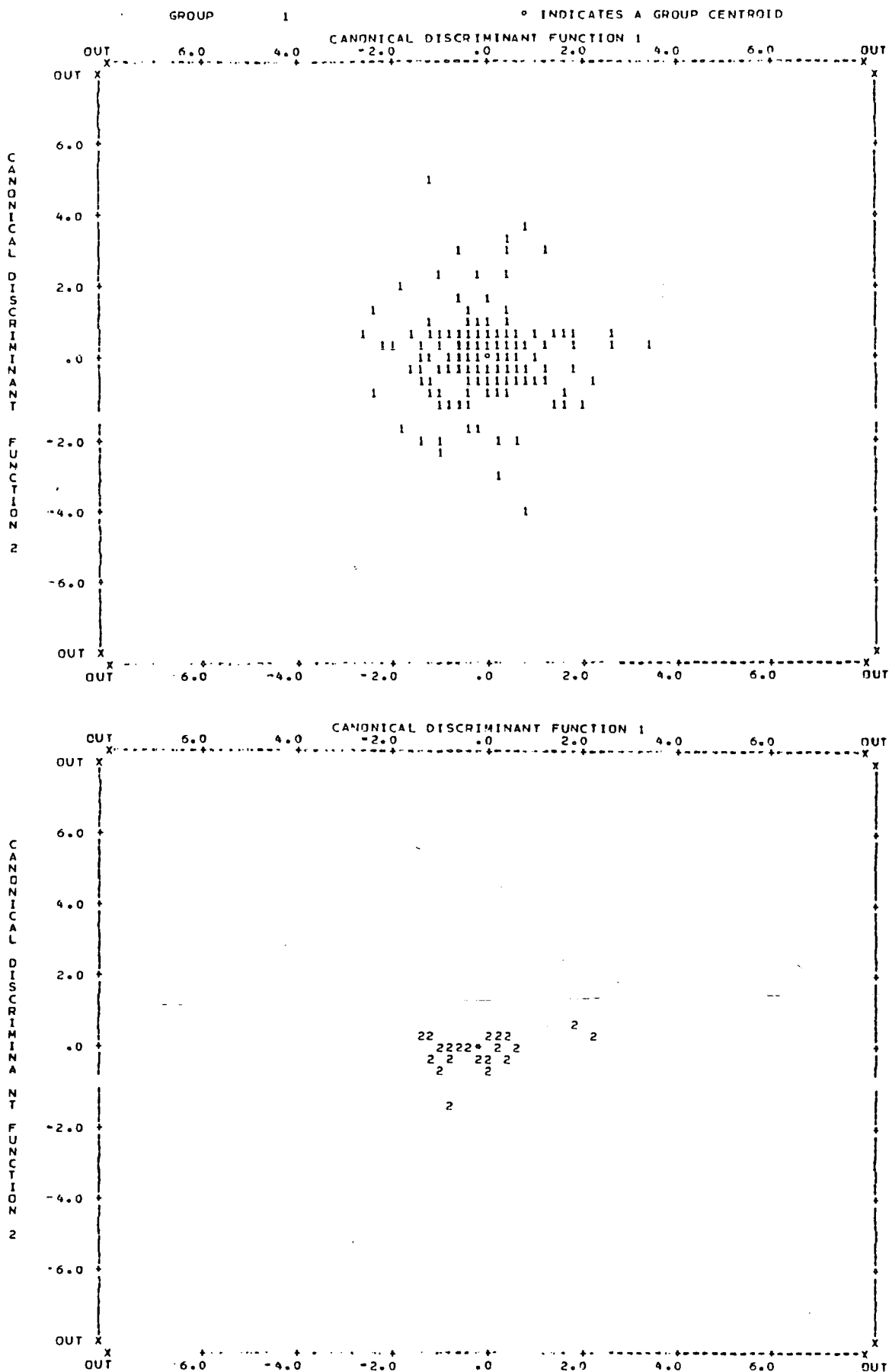

Table 8.66 - Females: RFA1 to LFA5

CLASSIFICATION RESULTS		NO. OF CASES	PREDICTED GROUP MEMBERSHIP			
ACTUAL GROUP	1		2	3	4	
GROUP 1	202	69 34.2%	62 30.7%	40 19.8%	31 15.3%	
GROUP 2	28	6 21.4%	18 64.3%	3 10.7%	1 3.6%	
GROUP 3	26	5 19.2%	6 23.1%	12 46.2%	3 11.5%	
GROUP 4	4	0 0.0%	0 0.0%	1 25.0%	3 75.0%	

PERCENT OF "GROUPED" CASES CORRECTLY CLASSIFIED: 39.23%

(iv) Summed Ulnar and Radial Counts - Variables: R1 to U5

As can be seen from Table 8.69 the only significant differences found between the groups of male subjects for variables R1 to U5 were found on finger III. Male Coeliacs were found to have a statistically significantly lower summed radial count for fingers III compared to both controls and DH males (Table 8.67).

For female subjects, controls were found to have significantly lower summed ulnar counts in comparison to Coeliacs on fingers II and V and in comparison to Coeliacs and DH subjects on fingers III (Tables 8.67 and 8.69). DH subjects were also found to have a highly significantly lower summed ulnar count on fingers III.

When discriminant analysis was carried out for male subjects, three canonical discriminant functions were produced with Function 1 accounting for 53.24% of the variance and Function 2 for another 33.33% (Table 8.70). Function 1 was composed of R3 and R4 and Function 2 of R2, R5 and R1, i.e. radial counts were the most important (Table 8.71). The Table of F statistics show the most widely separated groups to be DH and Coeliac relatives ($F = 3.2871$) followed by controls and Coeliac relatives ($F = 3.2382$). The territorial map shows the distribution in space of the groups and the group centroids with controls and DH subjects being close together on the left and Coeliacs and their unaffected relatives on the right (Figure 8.21).

Classification results showed 42.05% correct classification with the best groupings being for Coeliacs (66.7%) and DH (54.2%) see Table 8.73.

Discriminant analysis for females shows that canonical discriminant Function 1 accounted for 67.76% of the variance and Function 2 accounted for another 26.19% (Table 8.74). Function 1 contained variables, U1, U2, U4 and U5 (Table 8.75). For females, therefore, summed ulnar counts appeared to be the most important. The Table of F statics (Table 8.76) shows the most separated groups to be controls and Coeliacs ($F = 4.6795$) followed by DH and Coeliacs ($F = 2.4864$) and controls and DH ($F = 2.3525$) all being significantly different the first pair at the 1% level and the other two pairs at the 5% level.

Table 8.67

Summed Radial and Ulnar Counts

Males

		Variables									
		R1		R2		R3		R4		R5	
Groups	Cases	Mean	Std Dev	Mean	Std Dev	Mean	Std Dev	Mean	Std Dev	Mean	Std Dev
D.H.	48	39.125 +/-	9.673	16.104 +/-	13.000	28.958 +/-	10.429	32.229 +/-	9.809	26.021 +/-	7.856
Coeliacs	10	37.444 +/-	16.486	14.000 +/-	12.460	19.222 +/-	11.745	24.778 +/-	13.636	24.333 +/-	9.552
Controls	206	37.723 +/-	9.633	20.102 +/-	12.979	26.864 +/-	11.065	31.864 +/-	12.095	27.883 +/-	9.330

		Variables									
		U1		U2		U3		U4		U5	
Groups	Cases	Mean	Std Dev	Mean	Std Dev	Mean	Std Dev	Mean	Std Dev	Mean	Std Dev
D.H.	48	11.479 +/-	16.646	14.438 +/-	11.905	4.583 +/-	9.426	9.813 +/-	12.081	2.354 +/-	7.277
Coeliacs	10	18.000 +/-	17.328	16.111 +/-	14.777	0.222 +/-	0.667	5.556 +/-	8.932	0.667 +/-	2.000
Controls	206	13.743 +/-	16.028	14.087 +/-	15.304	5.495 +/-	11.356	12.14 +/-	14.694	3.330 +/-	7.596

Table 8.68

Summed Radial and Ulnar Counts

Females

		Variables									
		R1		R2		R3		R4		R5	
Groups	Cases	Mean	Std Dev	Mean	Std Dev	Mean	Std Dev	Mean	Std Dev	Mean	Std Dev
D.H.	28	33.464 +/-	10.454	15.679 +/-	11.997	23.107 +/-	9.964	26.607 +/-	8.288	22.643 +/-	8.180
Coeliacs	26	30.462 +/-	9.933	18.962 +/-	12.817	25.154 +/-	12.787	29.000 +/-	10.361	26.923 +/-	8.357
Controls	203	32.493 +/-	10.073	18.502 +/-	11.991	22.906 +/-	10.000	29.217 +/-	10.055	24.714 +/-	8.212

		Variables									
		U1		U2		U3		U4		U5	
Groups	Cases	Mean	Std Dev	Mean	Std Dev	Mean	Std Dev	Mean	Std Dev	Mean	Std Dev
D.H.	28	8.821 +/-	14.857	12.393 +/-	13.701	0.000 +/-	0.000	4.786 +/-	9.473	2.464 +/-	7.115
Coeliacs	26	9.269 +/-	16.622	15.462 +/-	13.989	6.462 +/-	11.904	14.885 +/-	17.514	8.077 +/-	13.218
Controls	203	8.709 +/-	12.217	9.350 +/-	11.748	2.719 +/-	7.360	6.961 +/-	11.230	1.532 +/-	4.776

Table 8.69 - Probabilities from Mann-Whitney U Test - Variables: R1 to U5

(a) MALES

VARIABLE	CONT : DH	CONT:COEL	DH : COEL
R1	0.4312	0.9890	0.8867
R2	0.0566	0.1597	0.6431
R3	0.2224	0.0383*	0.0191*
R4	0.9226	0.1041	0.1305
R5	0.2428	0.3208	0.7175
U1	0.2825	0.3590	0.1996
U2	0.3433	0.4545	0.7669
U3	0.8645	0.2545	0.2837
U4	0.6116	0.1600	0.2331
U5	0.3538	0.3224	0.6088

(b) FEMALES

R1	0.6836	0.1755	0.1936
R2	0.2467	0.7939	0.4297
R3	0.9531	0.1648	0.3107
R4	0.0727	0.6837	0.4406
R5	0.2715	0.3003	0.0996
U1	0.4933	0.4345	0.9650
U2	0.2747	0.0440*	0.4816
U3	0.0301*	0.0130*	0.0008**
U4	0.4685	0.0551	0.0738
U5	0.5486	0.0075**	0.1660

Table 8.70 - Canonical Discriminant Functions - Males: R1 to U5

FUNCTION	EIGENVALUE	PERCENT OF VARIANCE	CUMULATIVE PERCENT	CANONICAL CORRELATION
1*	0.10443	53.24	53.24	0.3074931
2*	0.06536	33.33	86.57	0.2476960
3*	0.02634	13.43	100.00	0.1602146

Table 8.71 - Structure Matrix

	FUNC 1	FUNC 2	FUNC 3
R3	0.51730*	0.15269	0.23271
R4	-0.24079*	0.07422	0.15973
R2	0.24222	0.53707*	0.19767
R5	0.20270	0.33695*	0.19363
R1	-0.01969	-0.19522*	0.07531
U3	0.18667	0.06664	0.94313*
U5	0.01670	0.17331	0.51434*
U4	0.06712	0.10467	0.46603*
U2	0.30216	-0.06742	0.31305*
U1	0.03363	0.12913	0.30295*

Table 8.72 - F Statistics and significances

GROUP	GROUP	1	2	3
2		2.3039		
		0.0117		
3		2.3267	2.5347	
		0.0331	0.0190	
4		3.2332	3.2371	1.2533
		0.0044	0.0039	0.2772

Code	Group
1	Controls
2	DH
3	Coeliacs
4	Coeliac unaffected relatives

Figure 8.21 - Territorial Map - Males: R1 to U5

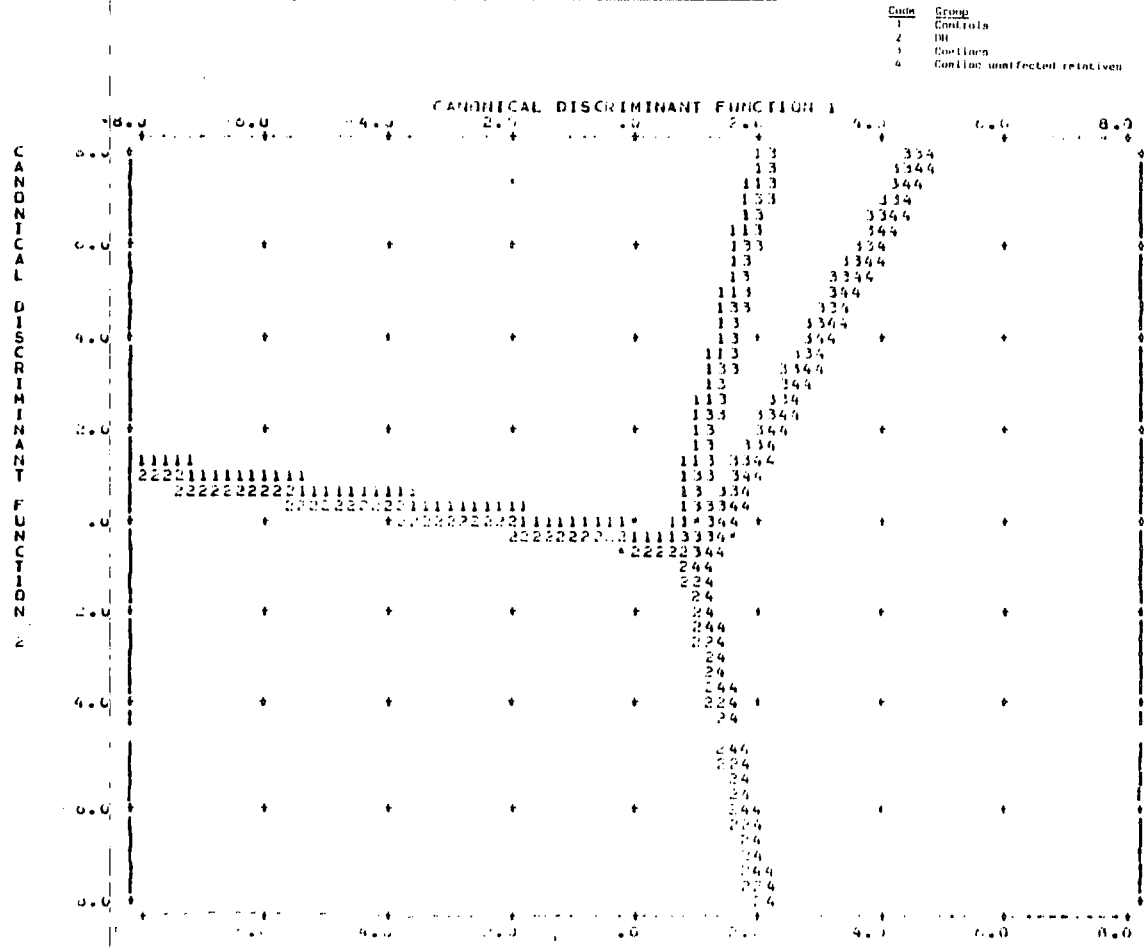

Table 8.73 - Males: R1 to U5

CLASSIFICATION RESULTS -

ACTUAL GROUP	NO. OF CASES	PREDICTED GROUP MEMBERSHIP			
		1	2	3	4
GROUP 1	200	76 38.0%	60 30.0%	41 20.5%	23 11.5%
GROUP 2	48	11 22.9%	26 54.2%	5 10.4%	6 12.5%
GROUP 3	9	1 11.1%	1 11.1%	6 66.7%	1 11.1%
GROUP 4	7	0 0.0%	0 0.0%	4 57.1%	3 42.9%

PERCENT OF "GROUPED" CASES CORRECTLY CLASSIFIED: 42.05%

The territorial map (Figure 8.22) shows that controls and unaffected Coeliac relatives to be close together with DH and Coeliacs separated to the right.

Classification results show 38.85% correct grouping with the best results being for unaffected relatives (75%) followed by DH (50%) see Table 8.77.

Table 8.74 - Canonical Discriminant Functions - Females: R1 to U5

FUNCTION	EIGENVALUE	PERCENT OF VARIANCE	CUMULATIVE PERCENT	CANONICAL CORRELATION
1*	0.16034	67.76	67.76	0.3717321
2*	0.06197	26.19	93.94	0.2415599
3*	0.01433	6.06	100.00	0.1183761

Table 8.75 - Structure Matrix

	FUNC 1	FUNC 2	FUNC 3
U5	0.75201*	0.31693	0.15643
U4	0.40394*	0.35624	0.11583
U2	0.39464*	-0.03907	0.17794
U1	0.24346*	0.11817	0.03200
U3	0.27317	0.64625*	0.50200
R4	0.08896	0.33307*	-0.31221
R2	-0.02146	0.28560*	0.26352
R1	0.10796	0.22619*	0.11146
R5	0.11393	0.47346	-0.47938*
R3	0.16257	0.06752	0.19906*

Table 8.76 - F Statistics and significances

GROUP	GROUP	1	2	3
2		2.3525		
		0.0187		
3		4.6795	2.4864	
		0.0000	0.0130	
4		0.49642	0.98245	1.3029
		0.8583	0.4502	0.2424

Code	Group
1	Controls
2	DH
3	Coeliacs
4	Coeliac unaffected relatives

Figure 8.22 - Territorial Map - Females: R1 to U5

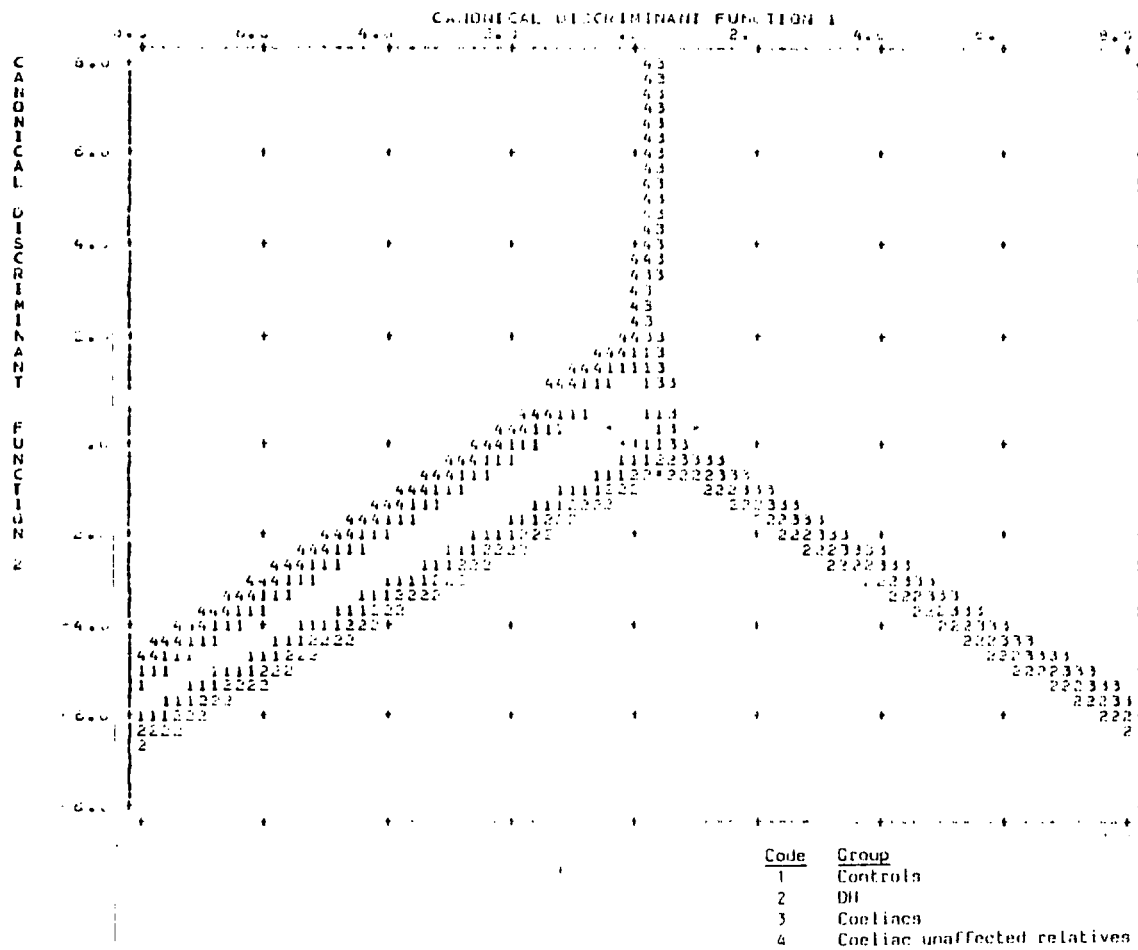

Table 8.77 - Females: R1 to U5

CLASSIFICATION RESULTS

ACTUAL GROUP	NO. OF CASES	PREDICTED GROUP MEMBERSHIP			
		1	2	3	4
GROUP 1	202	74 35.6%	54 26.7%	26 9.9%	54 26.7%
GROUP 2	28	8 28.6%	14 50.0%	3 10.7%	3 10.7%
GROUP 3	26	3 11.5%	9 34.6%	10 38.5%	4 15.4%
GROUP 4	4	0 0.0%	1 25.0%	0 0.0%	3 75.0%

PERCENT OF "GROUPED" CASES CORRECTLY CLASSIFIED: 38.85%

(v) Summed Radial and Ulnar Counts - Variables: RFR to TFU

No statistically significant differences were found for intergroup comparisons for either males or females for these variables Tables 8.78 and 8.79.

Table 8.78

(a) Summed Radial and Ulnar Counts : Males

		Variables					
		RFR		LFR		TFR	
	Cases	Mean	Std Dev	Mean	Std Dev	Mean	Std Dev
D.H.	48	72.125 +/-	23.036	70.313 +/-	21.037	142.438 +/-	42.960
Coeliacs	10	59.111 +/-	30.522	60.667 +/-	26.220	119.778 +/-	53.511
Controls	206	72.840 +/-	22.120	71.597 +/-	23.663	144.437 +/-	44.375

		Variables					
		RFU		LFU		TFU	
	Cases	Mean	Std Dev	Mean	Std Dev	Mean	Std Dev
D.H.	48	23.979 +/-	24.767	18.688 +/-	23.592	42.667 +/-	45.412
Coeliacs	10	22.667 +/-	18.439	17.889 +/-	17.316	40.556 +/-	32.100
Controls	205	26.850 +/-	28.121	21.990 +/-	25.020	48.840 +/-	51.066

(b) Summed Radial and Ulnar Counts : Females

		Variables					
		RFR		LFR		TFR	
	Cases	Mean	Std Dev	Mean	Std Dev	Mean	Std Dev
D.H.	28	60.857 +/-	21.759	60.643 +/-	20.163	121.500 +/-	41.240
Coeliacs	26	66.615 +/-	20.475	63.885 +/-	21.007	130.500 +/-	40.557
Controls	203	65.064 +/-	20.733	62.768 +/-	20.098	127.833 +/-	38.994

		Variables					
		RFU		LFU		TFU	
	Cases	Mean	Std Dev	Mean	Std Dev	Mean	Std Dev
D.H.	28	15.179 +/-	18.211	13.286 +/-	37.950	28.464 +/-	37.950
Coeliacs	26	25.308 +/-	17.988	28.846 +/-	32.920	54.154 +/-	59.186
Controls	203	14.640 +/-	17.118	14.631 +/-	19.024	29.271 +/-	33.496

Table 8.79 - Probabilities from Mann-Whitney U Tests

(a) MALES

VARIABLE	CONT : DH	CONT:COEL	DH : COEL
RFR	0.9461	0.1828	0.2082
LFR	0.7148	0.1739	0.2641
TFR	0.7717	0.1740	0.2505
RFU	0.9904	0.9667	0.8092
LFU	0.4112	0.9290	0.7150
TFU	0.8220	0.9691	0.8181

(b) FEMALES

VARIABLE	CONT : DH	CONT:COEL	DH : COEL
RFR	0.3457	0.9712	0.4408
LFR	0.4924	0.8466	0.6777
TFR	0.3638	0.8111	0.5795
RFU	0.9316	0.0654	0.1992
LFU	0.4664	0.0824	0.0691
TFU	0.6343	0.0702	0.0841

(vi) Summed Unilateral Ridge Counts - Variables:F1 to F5

Male Coeliac patients were found to have a significantly lower summed unilateral ridge count on fingers III in comparison to both controls and DH males.

Female DH patients were found to have a significantly lower summed unilateral ridge count on fingers IV in comparison to controls (Tables 8.80 and 8.81).

Table 8.80

Summed Unilateral Ridge Counts

(a) Males

Groups	Cases	F .1		F .2		F .3		F .4		RF .5	
		Mean	Std Dev	Mean	Std Dev	Mean	Std Dev	Mean	Std Dev	Mean	Std Dev
D.H.	48	39.417 +/-	9.721	23.625 +/-	11.182	29.063 +/-	10.475	32.271 +/-	9.841	26.021 +/-	7.856
Coeliacs	10	37.667 +/-	16.568	20.000 +/-	13.675	19.444 +/-	11.523	26.333 +/-	13.038	24.333 +/-	9.552
Controls	206	38.209 +/-	9.77	25.417 +/-	12.718	27.456 +/-	11.221	32.558 +/-	11.879	27.966 +/-	9.409

(b) Females

Groups	Cases	F .1		F .2		F .3		F .4		F .5	
		Mean	Std Dev	Mean	Std Dev	Mean	Std Dev	Mean	Std Dev	Mean	Std Dev
D.H.	28	33.750 +/-	10.561	22.250 +/-	11.184	23.107 +/-	9.964	26.607 +/-	2.888	22.643 +/-	8.180
Coeliacs	26	33.346 +/-	8.597	25.962 +/-	12.498	25.615 +/-	12.794	29.615 +/-	10.914	27.500 +/-	8.603
Controls	203	33.103 +/-	10.058	22.025 +/-	11.415	23.158 +/-	10.106	29.818 +/-	10.094	24.793 +/-	8.259

Table 8.81 - Probabilities from Mann-Whitney U Tests

(a) MALES

VARIABLE	CONT : DH	CONT:COEL	DH : COEL
F1	0.4853	0.9779	0.8868
F2	0.3175	0.2271	0.5111
F3	0.3490	0.0317*	0.0191*
F4	0.6632	0.1157	0.1779
F5	0.2299	0.3195	0.7175

(b) FEMALES

VARIABLE	CONT : DH	CONT:COEL	DH : COEL
F1	0.7731	0.6213	0.5851
F2	0.9892	0.0653	0.1766
F3	0.9099	0.1832	0.2866
F4	0.0356*	0.7602	0.3361
F5	0.2523	0.1840	0.0533

(vii) Summed Absolute Ridge Counts - Variables: AF1 to AF5

Male Coeliac sufferers were found to have a significantly smaller summed absolute ridge count on fingers III in comparison to both DH and control male subjects. No significant differences were found for females (Tables 8.82 and 8.83).

Discriminant analysis for male subjects showed that AF2, AF4 and AF5 were the most important variable (Table 8.85). The F statistics table showed DH and Coeliacs ($F = 3.6505$) and Coeliac and controls ($F = 3.2050$) to be the most widely separated groups (see Table 8.86). The territorial map separates out Coeliacs, DH and controls with Coeliacs having their group centroid to the left of the other three (Figure 8.23). Classification results show only 27.27% correctness. Best classified groups were Coeliacs (66.7%) and DH (52.1%) see Table 8.87.

Table 8.82

(a) Summed Absolute Ridge Counts

Males

Groups	Cases	AF1		AF2		AF3		AF4		AF5	
		Mean	Std Dev	Mean	Std Dev	Mean	Std Dev	Mean	Std Dev	Mean	Std Dev
D.H.	48	50.604	+/- 22.896	30.542	+/- 20.434	33.542	+/- 16.134	42.042	+/- 18.295	28.375	+/- 12.170
Coeliacs	10	55.444	+/- 31.871	30.111	+/- 24.472	19.444	+/- 11.524	30.333	+/- 15.953	25.000	+/- 9.734
Controls	206	51.466	+/- 21.512	34.189	+/- 22.960	32.359	+/- 18.395	44.049	+/- 23.204	31.214	+/- 14.009

(b) Females

Groups	Cases	AF1		AF2		AF3		AF4		AF5	
		Mean	Std Dev	Mean	Std Dev	Mean	Std Dev	Mean	Std Dev	Mean	Std Dev
D.H.	28	42.286	+/- 20.951	28.071	+/- 20.649	23.107	+/- 9.964	31.393	+/- 15.375	25.107	+/- 12.948
Coeliacs	26	39.731	+/- 18.871	34.423	+/- 21.164	31.615	+/- 21.836	43.885	+/- 26.518	35.000	+/- 19.018
Controls	203	41.202	+/- 18.100	27.852	+/- 18.928	25.626	+/- 14.247	36.177	+/- 17.551	26.246	+/- 10.062

Table 8.83 - Probabilities from Mann-Whitney U Tests

(a) MALES

VARIABLE	CONT : DH	CONT:COEL	DH : COEL
AF1	0.6219	0.7527	0.7675
AF2	0.3997	0.5691	0.8782
AF3	0.4026	0.0229*	0.0114*
AF4	0.8044	0.0978	0.1394
AF5	0.2325	0.2490	0.7590

(b) FEMALES

VARIABLE	CONT : DH	CONT:COEL	DH : COEL
AF1	0.9363	0.3242	0.6032
AF2	0.8433	0.0865	0.1632
AF3	0.6163	0.2941	0.2565
AF4	0.0902	0.4763	0.1907
AF5	0.2311	0.0922	0.0566

Table 8.84 - Canonical Discriminant Functions - Males: AF1 to AF5

FUNCTION	EIGENVALUE	PERCENT OF VARIANCE	CUMULATIVE PERCENT	CANONICAL CORRELATION
1 ^o	0.05727	75.24	75.24	0.2327477
2 ^o	0.01462	19.21	94.45	0.1200367
3 ^o	0.00423	5.55	100.00	0.0648671

Table 8.85 - Structure Matrix

	FUNC 1	FUNC 2	FUNC 3
AF2	0.01342	0.63423*	0.61866
AF4	0.38588	0.63354*	0.04899
AF5	0.26991	0.42254*	0.25368
AF3	0.53677	0.23031	0.60708*
AF1	0.16052	0.05765	0.31261*

Table 8.86 - F Statistics and significances

GROUP	GROUP 1	GROUP 2	GROUP 3
2	1.2179 0.3036		
3	3.2050 0.0136	3.6505 0.0065	
4	0.31304 0.8691	0.46238 0.7633	1.3097 0.2668

Code Group
 1 Controls
 2 DH
 3 Coeliac
 4 Coeliac unaffected relatives

Figure 8.23 - Territorial Map - Males: AF1 to AF5

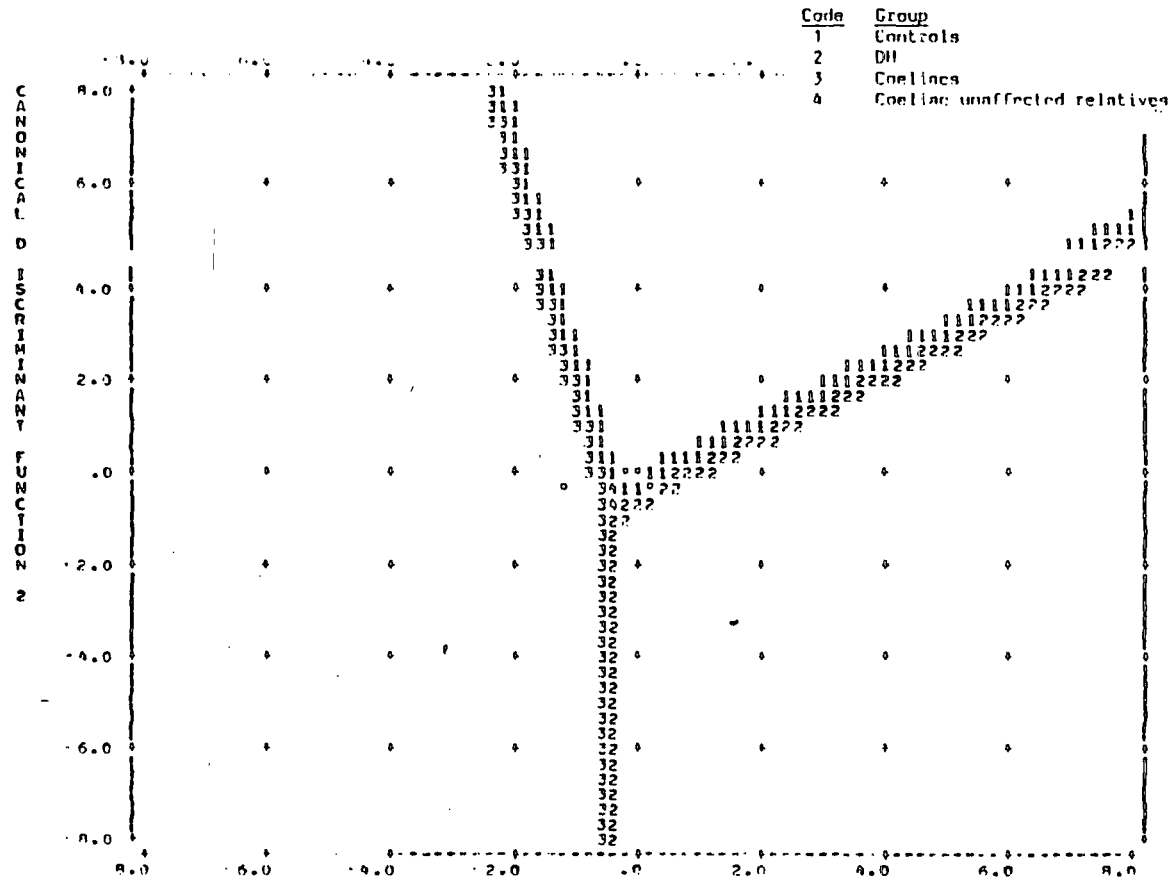

Table 8.87 - Males: AF1 to AF5

ACTUAL GROUP	NO. OF CASES	PREDICTED GROUP MEMBERSHIP			
		1	2	3	4
GROUP 1	200	38 19.0%	72 36.0%	48 24.0%	42 21.0%
GROUP 2	48	8 16.7%	25 52.1%	6 12.5%	9 18.8%
GROUP 3	9	2 22.2%	1 11.1%	6 66.7%	0 0.0%
GROUP 4	7	2 28.6%	0 0.0%	2 28.6%	3 42.9%

PERCENT OF "GROUPED" CASES CORRECTLY CLASSIFIED: 27.27%

(viii) Summed Unilateral Counts - Variables: RFRC to TFRC

No significant differences were found for males or females intergroup comparisons (see Tables 8.88 and 8.89).

Table 8.88

(a) Summed Unilateral Counts : Males

		Variables					
		RFRC		LFRC		TFRC	
Group	Cases	Mean	Std Dev	Mean	Std Dev	Mean	Std Dev
D.H.	28	76.250 +/- 23.374		74.146 +/- 21.696		150.396 +/- 44.266	
Coeliacs	26	63.444 +/- 29.787		64.333 +/- 26.786		127.778 +/- 54.667	
Controls	203	76.718 +/- 23.405		74.888 +/- 24.759		151.607 +/- 47.056	

(b) Summed Unilateral Counts : Females

		Variables					
		RFRC		LFRC		TFRC	
Group	Cases	Mean	Std Dev	Mean	Std Dev	Mean	Std Dev
D.H.	28	65.143 +/- 22.669		63.214 +/- 20.899		128.357 +/- 42.890	
Coeliacs	26	72.154 +/- 21.760		69.885 +/- 23.225		142.038 +/- 44.198	
Controls	203	67.241 +/- 21.036		65.655 +/- 20.857		132.897 +/- 40.446	

Table 8.89 - Probabilities from Mann-Whitney U Tests

(a) MALES

VARIABLE	CONT : DH	CONT:COEL	DH : COEL
RFRC	0.9635	0.1810	0.2596
LFRC	0.9002	0.2250	0.3299
TFRC	0.9088	0.2147	0.2550

(b) FEMALES

VARIABLE	CONT : DH	CONT:COEL	DH : COEL
RFRC	0.6860	0.4154	0.3408
LFRC	0.4498	0.4647	0.3365
TFRC	0.5737	0.3761	0.3409

(ix) Summed Absolute Counts - Variables: RFAC to TFAC

No significant differences were found for males or females (see Tables 8.90 and 8.91).

Table 8.90

(a) Summed Absolute Counts : Males

		Variables					
		RFAC		LFAC		TFAC	
Group	Cases	Mean	Std Dev	Mean	Std Dev	Mean	Std Dev
D.H.	28	96.104 +/-	42.370	89.000 +/-	39.494	185.104 +/-	79.871
Coeliacs	26	81.778 +/-	45.439	78.556 +/-	37.108	160.333 +/-	79.773
Controls	203	99.689 +/-	45.206	93.587 +/-	42.894	193.277 +/-	86.167

(b) Summed Absolute Counts : Females

		Variables					
		RFAC		LFAC		TFAC	
Group	Cases	Mean	Std Dev	Mean	Std Dev	Mean	Std Dev
D.H.	28	76.036 +/-	36.108	73.929 +/-	36.194	149.964 +/-	71.452
Coeliacs	26	91.923 +/-	45.396	92.731 +/-	48.979	184.654 +/-	93.147
Controls	203	79.704 +/-	32.259	77.399 +/-	33.722	157.103 +/-	63.626

Table 8.91 - Probabilities from Mann-Whitney U Tests

(a) MALES

VARIABLE	CONT : DH	CONT:COEL	DH : COEL
RFAC	0.8409	0.3131	0.4701
LFAC	0.6873	0.3560	0.7344
TFAC	0.7960	0.3239	0.6855

(b) FEMALES

VARIABLE	CONT : DH	CONT:COEL	DH : COEL
RFAC	0.4896	0.4327	0.2792
LFAC	0.4145	0.3512	0.2603
TFAC	0.4008	0.4038	0.2255

(c) Finger Ridge Disturbances

(i) White Lines - Variables: LW1 to RW5

Male DH patients were found to have statistically significantly greater frequency of occurrence of white lines on all fingers in comparison to controls. The differences were all significant at the 1% with the exception of RW2 which was significant at the 5% level (Tables 8.92 and 8.94a). Female Coeliac patients had statistically significantly greater occurrence of white lines in comparison to controls on all fingers (highly significant on all except RW5 significant). DH females had significantly greater occurrence of white lines on fingers III and IV of the left hand in comparison to controls (Tables 8.93 and 8.94b).

The results of discriminant analysis are given in section c (iii).

Table 8.92

Percentage Frequencies

White Lines

(a) Males : Left Hand

Group	n	LW1				LW2				LW3				LW4				LW5			
		0	1	2	3	0	1	2	3	0	1	2	3	0	1	2	3	0	1	2	3
DH	48	41.7	10.4	27.1	20.8	41.7	16.7	27.1	14.6	41.7	14.6	29.2	14.6	39.6	12.5	33.3	14.6	39.6	18.8	27.1	14.6
Coeliacs	10	44.4	22.2	33.3	0.0	44.2	22.2	33.3	0.0	44.4	22.2	33.3	0.0	44.4	22.2	33.3	0.0	44.4	33.3	22.2	0.0
Contrds	206	54.9	25.7	13.6	5.8	62.6	25.7	6.3	5.3	58.5	26.3	8.8	6.3	53.4	30.6	10.2	5.8	56.8	27.2	9.7	6.3

(b) Males : Right Hand

Group	n	RW1				RW2				RW3				RW4				RW5			
		0	1	2	3	0	1	2	3	0	1	2	3	0	1	2	3	0	1	2	3
DH	48	31.3	16.7	33.3	18.8	47.9	18.8	27.1	6.3	37.5	27.1	20.8	14.6	35.4	18.8	33.3	12.5	39.6	22.9	29.2	8.3
Coeliacs	10	55.6	11.1	33.3	0.0	55.6	22.2	22.2	0.0	55.6	11.1	33.3	0.0	66.7	11.1	22.2	0.0	66.7	11.1	22.2	0.0
Contrds	206	53.4	30.1	10.2	6.3	62.6	25.7	7.8	3.9	58.3	28.2	9.7	3.9	58.3	28.6	9.2	3.9	55.8	31.6	8.3	4.4

Table 8.93

Percentage Frequencies

White Lines

(a) Females : Left Hand

Group	n	LW1				LW2				LW3				LW4				LW5			
		0	1	2	3	0	1	2	3	0	1	2	3	0	1	2	3	0	1	2	3
DH	28	32.1	39.3	3.6	25.0	39.3	28.6	10.7	21.4	25.0	42.9	7.1	25.0	25.0	42.9	10.7	21.4	35.7	32.1	10.7	21.4
Coeliacs	26	23.1	19.2	7.7	50.0	26.9	19.2	30.8	23.1	26.9	15.4	26.9	30.8	26.9	19.2	23.1	30.8	30.8	11.5	26.9	30.8
Contr ds	203	36.9	36.5	19.7	6.9	48.8	33.0	13.3	4.9	45.3	35.0	15.3	4.4	41.4	35.0	18.2	5.4	41.4	35.0	18.2	5.4

(b) Females : Right Hand

Group	n	RW1				RW2				RW3				RW4				RW5			
		0	1	2	3	0	1	2	3	0	1	2	3	0	1	2	3	0	1	2	3
DH	28	35.7	32.1	7.1	25.0	42.9	28.6	7.1	21.4	35.7	32.1	10.7	21.4	32.1	28.6	14.3	25.0	32.1	28.6	17.9	21.4
Coeliacs	26	26.9	15.4	15.4	42.3	26.9	19.2	34.6	19.2	30.8	15.4	30.8	23.1	26.9	23.1	26.9	23.1	30.8	23.1	15.4	30.8
Contr ds	203	36.9	32.5	21.7	8.9	48.8	33.0	12.3	5.9	48.0	29.7	16.8	5.4	43.6	34.2	15.3	6.9	39.9	39.4	14.3	6.4

Table 8.94 - Probabilities from Mann-Whitney U Tests

(a) MALES

VARIABLE	CONT : DH	CONT:COEL	DH : COEL
LW1	0.0036**	0.4570	0.3988
LW2	0.0004**	0.1752	0.5712
LW3	0.0022**	0.3029	0.5319
LW4	0.0023**	0.4479	0.4176
LW5	0.0028**	0.5104	0.3758
RW1	0.0000**	0.8189	0.1276
RW2	0.0116*	0.5971	0.5308
RW3	0.0010**	0.5862	0.3761
RW4	0.0001**	0.8090	0.0810
RW5	0.0035**	0.7234	0.1591

(b) FEMALES

VARIABLE	CONT : DH	CONT:COEL	COEL : DH
LW1	0.3921	0.0007**	0.0833
LW2	0.1107	0.0008**	0.2543
LW3	0.0145*	0.0005**	0.3842
LW4	0.0431*	0.0026**	0.3839
LW5	0.2498	0.0047**	0.2577
RW1	0.5499	0.0057**	0.1588
RW2	0.2515	0.0012**	0.1952
RW3	0.1031	0.0045**	0.3888
RW4	0.0518	0.0077**	0.6479
RW5	0.0789	0.0220*	0.6151

(ii) Finger Ridge Hyperlinearity - Variables: LH1 to RH5

DH male subjects were found to have highly significantly greater frequency of occurrence of ridge hyperlinearity on all fingers in comparison to controls. Male Coeliacs were found to have significantly higher occurrence of hyperlinearity on right hand fingers III and IV in comparison to controls (Tables 8.95 and 8.97a).

Female Coeliac patients were found to have highly significantly greater hyperlinearity on all fingers in comparison to controls. DH females were found to have significantly greater hyperlinearity on all fingers apart from LI and V in comparison to controls. Coeliacs were found to have significantly greater hyperlinearity on left hand fingers I, IV and V in comparison to DH (Tables 8.96 and 8.97b).

Results of discriminant analysis are given in next section.

Table 8.95

Percentage Frequencies

Hyperlinearity

(a) Males : Left Hand

Group	n	LH1				LH2				LH3				LH4				LH5			
		0	1	2	3	0	1	2	3	0	1	2	3	0	1	2	3	0	1	2	3
DH	48	41.7	27.1	12.5	18.8	47.9	22.9	14.6	14.6	47.9	25.0	12.5	14.6	45.8	25.0	20.8	12.5	41.7	25.0	20.8	12.5
Coeliacs	10	55.6	22.2	22.2	0.0	55.6	33.3	11.1	0.0	55.6	22.2	22.2	0.0	55.6	22.2	22.2	0.0	55.6	22.2	22.2	0.0
Contr ds	206	71.4	16.0	8.3	4.4	80.1	11.7	4.9	3.4	77.7	12.1	5.8	4.4	74.8	15.0	7.3	2.9	74.8	15.0	5.8	4.4

(b) Males : Right Hand

Group	n	RH1				RH2				RH3				RH4				RH5			
		0	1	2	3	0	1	2	3	0	1	2	3	0	1	2	3	0	1	2	3
DH	48	37.5	27.1	22.9	12.5	56.3	22.9	10.4	10.4	47.9	22.9	16.7	12.5	37.5	29.2	20.8	12.5	37.5	25.0	20.8	16.7
Coeliacs	10	55.6	11.1	22.2	11.1	55.6	22.2	22.2	0.0	44.4	33.3	22.2	0.0	44.4	33.3	22.2	0.0	44.4	33.3	22.2	0.0
Contr ds	206	70.4	16.0	8.7	4.9	79.1	12.1	5.3	3.4	78.6	11.7	6.3	3.4	76.2	14.6	5.8	3.4	74.3	15.0	6.8	3.9

Table 8.96

Percentage Frequencies

Hyperlinearity

(a) Females : Left Hand

Group	n	LH1				LH2				LH3				LH4				LH5			
		0	1	2	3	0	1	2	3	0	1	2	3	0	1	2	3	0	1	2	3
DH	28	51.9	22.2	14.8	11.1	50.0	25.0	14.3	10.7	50.0	25.0	14.3	10.7	50.0	25.0	14.3	10.7	50.0	25.0	14.3	10.7
Coeliacs	26	32.0	16.0	12.0	40.0	30.8	19.2	19.2	30.8	30.8	23.1	11.5	34.6	26.9	11.5	23.1	38.5	26.9	15.4	23.1	34.6
Contr ds	203	64.0	22.7	8.9	4.4	70.9	20.7	5.9	2.5	70.9	18.7	8.9	1.5	68.0	19.7	10.3	2.0	64.5	22.2	9.9	3.4

(b) Males : Right Hand

Group	n	RH1				RH2				RH3				RH4				RH5			
		0	1	2	3	0	1	2	3	0	1	2	3	0	1	2	3	0	1	2	3
DH	28	46.4	25.0	10.7	17.9	46.4	25.0	17.9	10.7	42.9	25.0	14.3	17.9	42.9	21.4	21.4	14.3	39.3	21.4	28.6	10.7
Coeliacs	26	30.8	11.5	30.8	26.9	30.8	19.2	26.9	23.1	30.8	15.4	26.9	26.9	26.9	19.2	26.9	26.9	26.9	11.5	26.9	34.6
Contr ds	203	64.0	18.7	11.8	5.4	73.4	14.3	8.9	3.4	70.4	17.7	8.4	3.4	67.5	18.2	9.9	4.4	64.0	19.2	12.3	4.4

Table 8.97 - Probabilities from Mann-Whitney U Tests

(a) MALES

VARIABLE	CONT : DH	CONT:COEL	DH : COEL
LH1	0.0000**	0.3052	0.3418
LH2	0.0000**	0.0873	0.4028
LH3	0.0000**	0.1189	0.5637
LH4	0.0000**	0.1749	0.4824
LH5	0.0000**	0.1868	0.3536
RH1	0.0000**	0.2422	0.5123
RH2	0.0008**	0.1016	0.9515
RH3	0.0000**	0.0196*	0.8422
RH4	0.0000**	0.0324*	0.4759
RH5	0.0000**	0.0569	0.3840

(b) FEMALES

VARIABLE	CONT : DH	CONT:COEL	DH : COEL
LH1	0.1306	0.0000**	0.0379*
LH2	0.0109*	0.0000**	0.0531
LH3	0.0129*	0.0000**	0.0573
LH4	0.0350*	0.0000**	0.0110*
LH5	0.0845	0.0000**	0.0174*
RH1	0.0463*	0.0000**	0.1114
RH2	0.0026**	0.0000**	0.1153
RH3	0.0012**	0.0000**	0.1973
RH4	0.0040**	0.0000**	0.1401
RH5	0.0047**	0.0000**	0.0665

(iii) Discriminant Analysis - Variables: LW1 to RH5

Three canonical discriminant functions were produced for male subjects using this set of variables. Function 1 accounted for 60.56% of the variance and all of the variables contributed to it (see Table 8.98 and 8.99). The groups which were significantly different were, in order of decreasing F statistics, controls and DH ($F = 6.3045$), controls and Coeliac relatives ($F = 4.0465$), Coeliacs and Coeliac relatives ($F = 3.3857$) and DH and Coeliac relatives ($F = 3.2756$) see Table 8.100. The territorial map and individual group scatterplots (Figures 8.24 and 8.25) show that the four group centroids are separated with Coeliac unaffected relatives being furthest away from the other groups. DH males are furthest to the right with Coeliacs being between them and controls. The Table of classification results (Table 8.101) shows 68.18% correct classification. The best groups were found to be controls (75%), Coeliac relatives (57.1%) and DH (47.9%).

For female subjects, canonical function 1 accounted for 53.4% of the variance and contained 18 out of 20 of the variables. Function 2 took out a further 35.06% of the variance and LW5 and RW4 were the important variable in it. In Function 1 nine of the first ten variables were hyperlinearity variables for all fingers except right hand finger I which was fourteenth in the list (see Table 8.102 and 8.103). The Table of F statistics shows that Coeliac relatives were the most separated from all the other three groups. All intergroup separations were statistically significant at the 5% level with four out of six being significant at the 1% level (Table 8.104). The territorial map (Figure 8.26) and the individual scatterplots (Figure 8.27) show that the group centroid for Coeliac relatives is furthest separated from the other three groups. Controls are to the left with DH next and then Coeliac females all evenly spaced. The classification results shown in Table 8.105 show 66.15% correctness. The best groups are Coeliac relatives (75%), controls (69.7%) and Coeliacs (64%).

Table 8.98 - Canonical Discriminant Functions - Males: LW1 to RH5

FUNCTION	EIGENVALUE	PERCENT OF VARIANCE	CUMULATIVE PERCENT	CANONICAL CORRELATION
1*	0.33240	60.56	60.56	0.4994725
2*	0.17128	31.21	91.77	0.3824077
3*	0.04518	8.23	100.00	0.2079112

Table 8.99- Structure Matrix

	FUNC 1	FUNC 2	FUNC 3
RH5	0.61112*	0.10861	0.14039
RW4	0.58551*	0.21701	-0.04627
RH4	0.57243*	-0.20068	0.14604
RW1	0.56825*	0.12466	0.00131
LW2	0.56367*	0.19306	0.32906
LH2	0.55766*	0.05913	0.07144
LH5	0.54803*	0.04633	0.10529
LH4	0.52304*	-0.01290	0.15370
LH3	0.51558*	-0.08825	0.10674
LH1	0.50410*	0.12484	0.10740
LW1	0.49280*	0.14404	0.17552
LW3	0.48724*	0.15100	0.22079
RH3	0.46590*	-0.16622	0.22051
LW4	0.46560*	0.15365	0.14537
RW3	0.45947*	0.05983	0.10596
LW5	0.43891*	0.15607	0.10023
RH1	0.43644*	0.18252	0.14080
RW5	0.41329*	0.18754	-0.05486
RW2	0.38443*	0.14142	0.14027
RH2	0.36318*	-0.03415	0.23395

Table 8.100 - F Statistics and significances

GROUP	GROUP	1	2	3
2		6.3045		
		0.0000		
3		1.2877	1.5838	
		0.2260	0.0966	
4		4.0465	3.2756	3.3857
		0.0000	0.0002	0.0001
Code	Group			
1	Controls			
2	DH			
3	Coeliacs			
4	Coeliac unaffected relatives			

Figure 8.24 - Males: LW1 to RH5

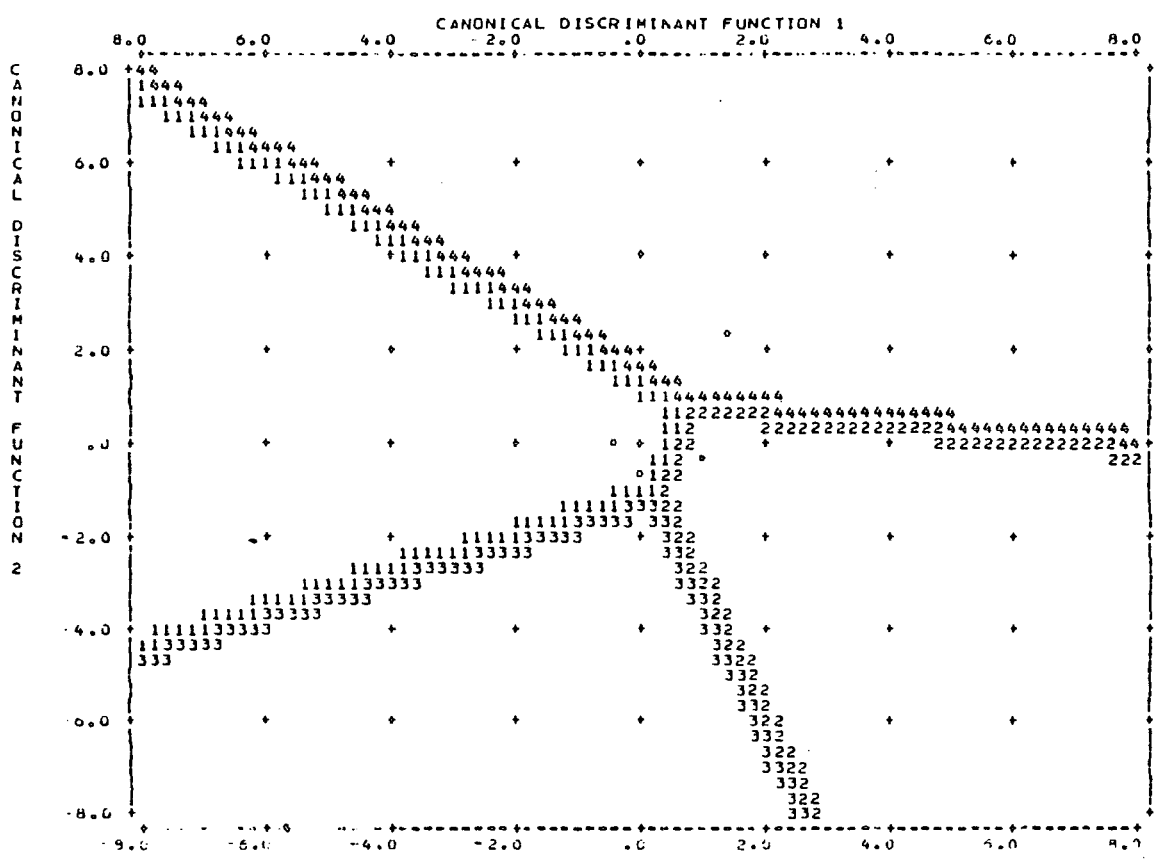

Code	Group
1	Controls
2	DH
3	Coelics
4	Coeliac unaffected relatives

Figure 8.25 - Males: LW1 to RH5

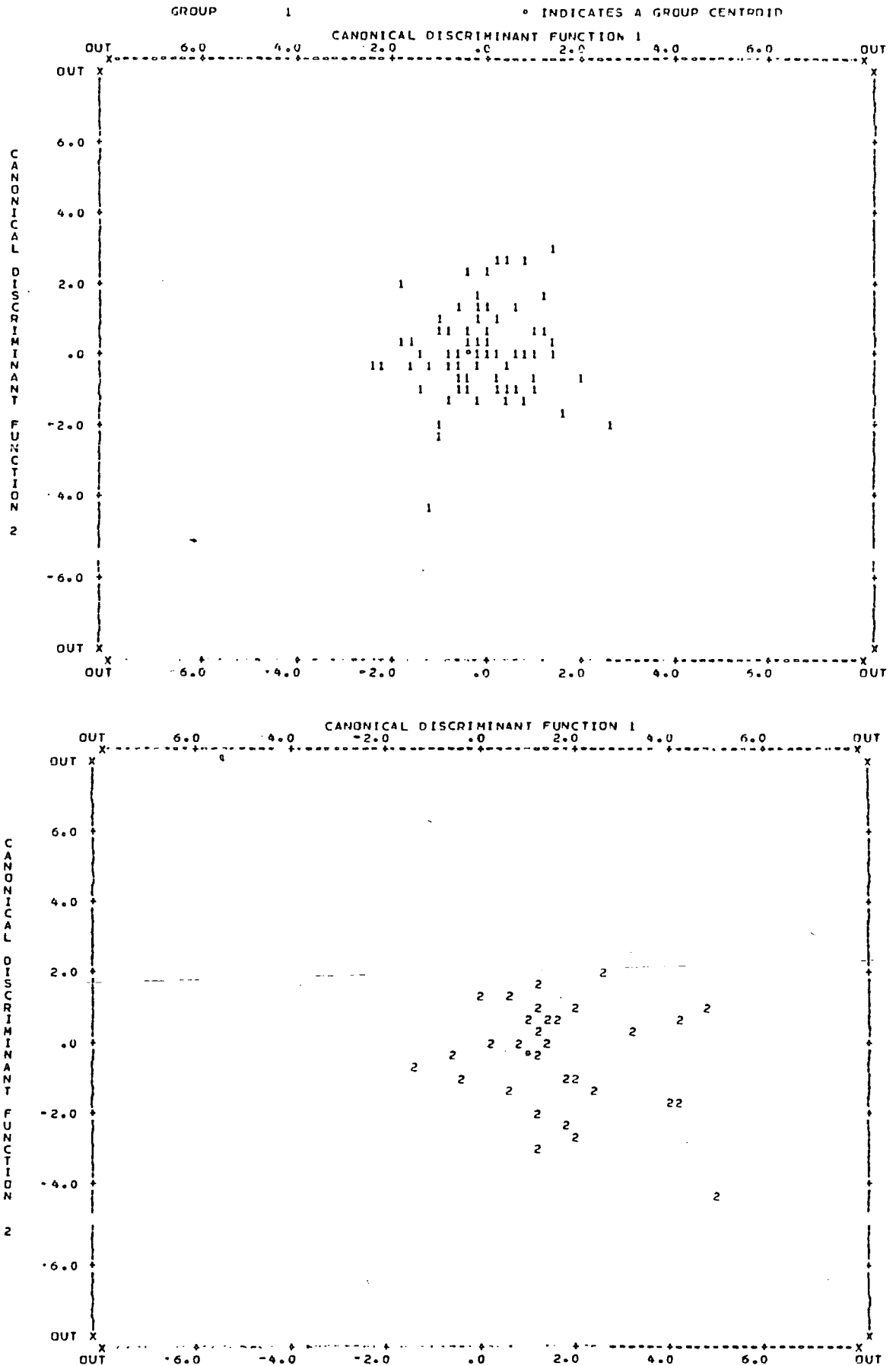

Figure 8.25 continued

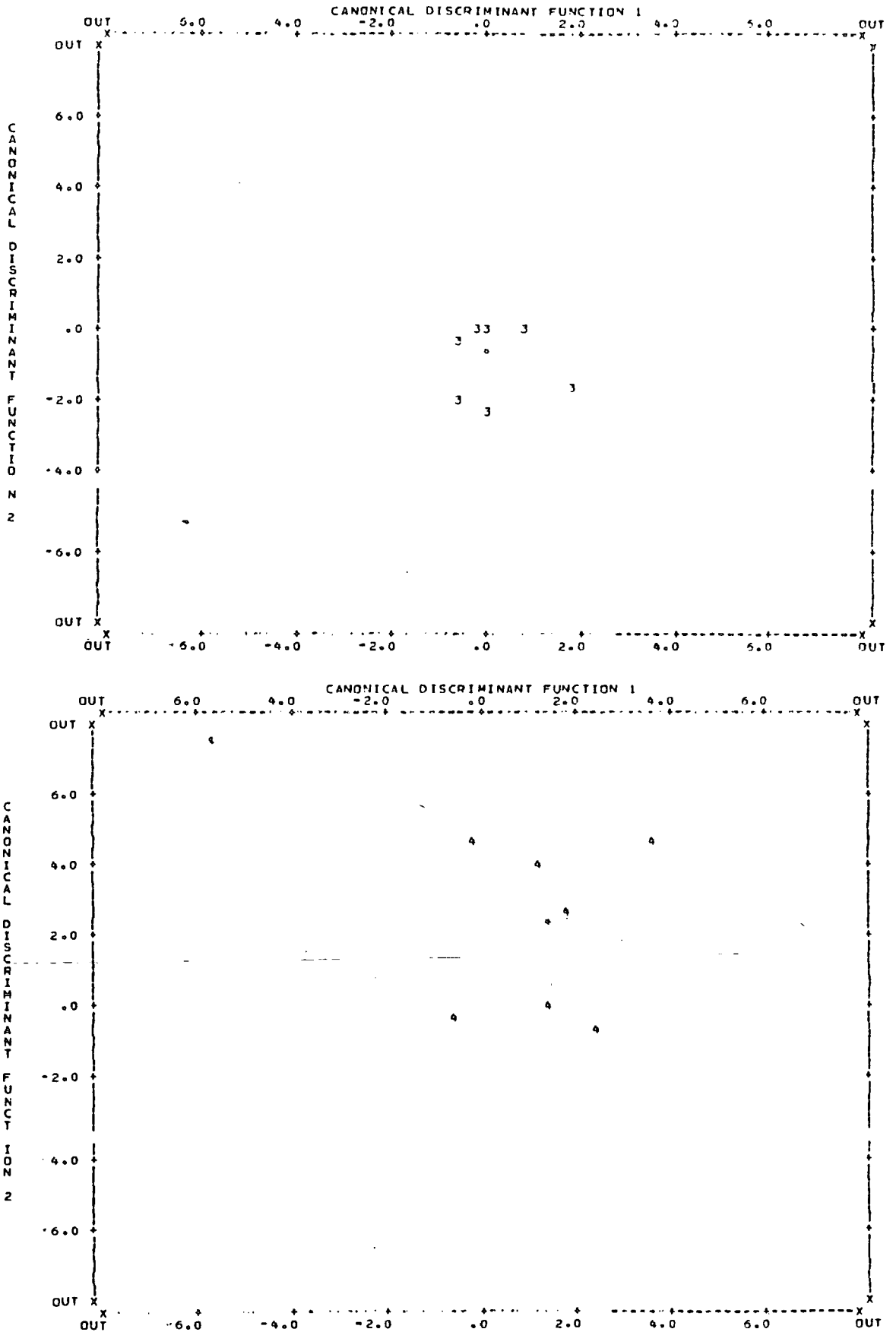

Table 8.101 - Males: LW1 to RH5

CLASSIFICATION RESULTS

ACTUAL GROUP	NO. OF CASES	PREDICTED GROUP MEMBERSHIP			
		1	2	3	4
GROUP 1	200	150 75.0%	25 12.5%	15 7.5%	10 5.0%
GROUP 2	48	17 35.4%	23 47.9%	3 6.3%	5 10.4%
GROUP 3	9	5 55.6%	1 11.1%	3 33.3%	0 0.0%
GROUP 4	7	1 14.3%	2 28.6%	0 0.0%	4 57.1%

PERCENT OF "GROUPED" CASES CORRECTLY CLASSIFIED: 68.18%

Table 8.102 - Canonical Discriminant Functions - Females: LW1 to RH5

FUNCTION	EIGENVALUE	PERCENT OF VARIANCE	CUMULATIVE PERCENT	CANONICAL CORRELATION
1*	0.33324	53.40	53.40	0.4999487
2*	0.21877	35.06	88.46	0.4236742
3*	0.07203	11.54	100.00	0.2592171

Table 8.103 - Structure Matrix

	FUNC 1	FUNC 2	FUNC 3
LH3	0.65485*	0.44442	-0.07229
LH4	0.62497*	0.57813	-0.23513
RH3	0.60799*	0.42767	0.17550
LH5	0.59107*	0.44313	-0.22560
RH2	0.58601*	0.37912	0.05910
LH2	0.57127*	0.56317	0.04235
LW3	0.54293*	0.26638	0.19410
RH4	0.53248*	0.45871	0.12547
RH5	0.50214*	0.43610	0.01725
LH1	0.49501*	0.43896	-0.23660
LW2	0.48284*	0.29195	0.14967
LW4	0.44945*	0.31932	0.09408
LW1	0.44779*	0.24490	0.13831
RH1	0.43770*	0.38841	-0.01113
RH3	0.40724*	0.19793	0.10819
RW2	0.40428*	0.22898	0.01581
RW5	0.31078*	0.25946	0.09725
RW1	0.23421*	0.24241	-0.08824
LW5	0.26678	0.35315*	0.02452
RW4	0.26707	0.33224*	0.26421

Table 8.104 - F Statistics and significances

GROUP	GROUP	1	2	3
2		2.1954		
		0.0108		
3		4.5072	1.8213	
		0.0000	0.0406	
4		5.3329	4.4090	4.5397
		0.0000	0.0000	0.0000
Code	Group			
1	Controls			
2	DN			
3	Coeliacs			
4	Coeliac unaffected relatives			

Figure 8.26 - Females: LW1 to RHS

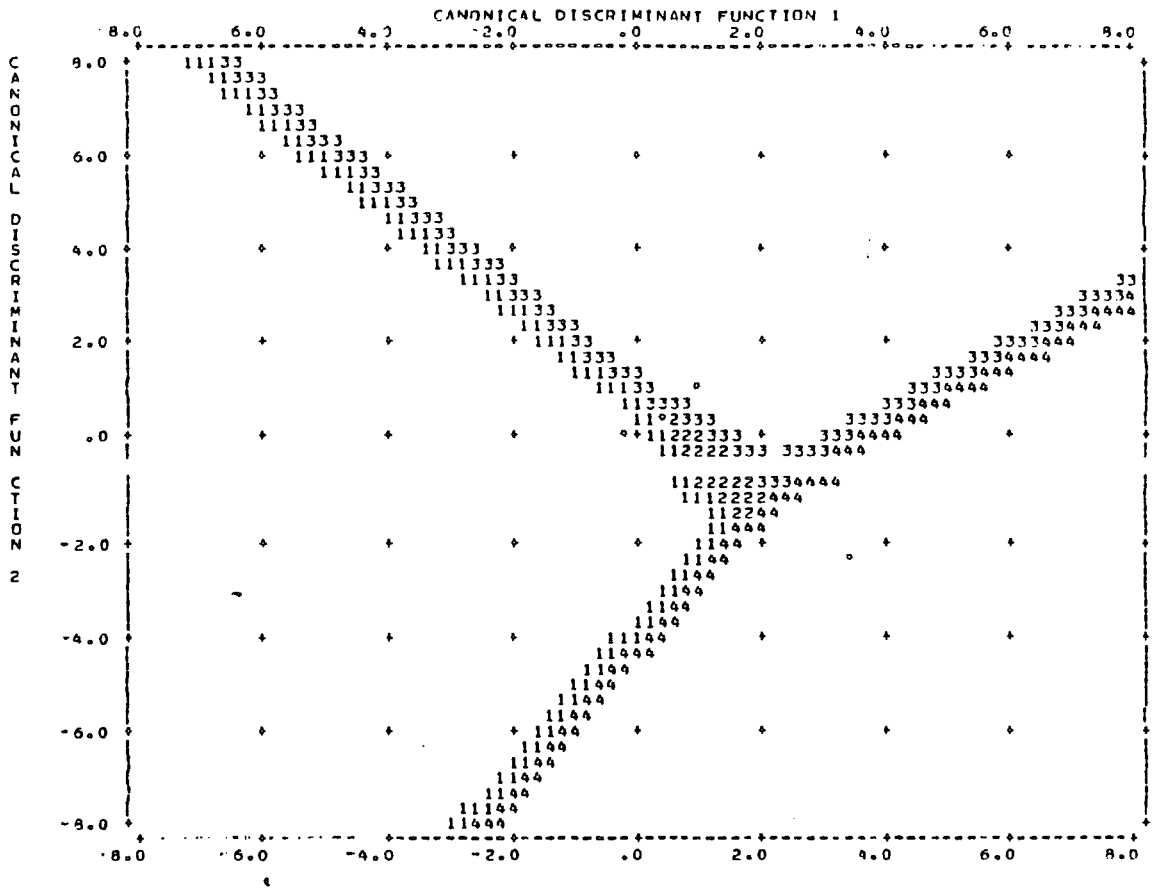

Code	Group
1	Controls
2	DH
3	Coeliacs
4	Coeliac unaffected relatives

Figure 8.27 - Females: LW1 to RH5

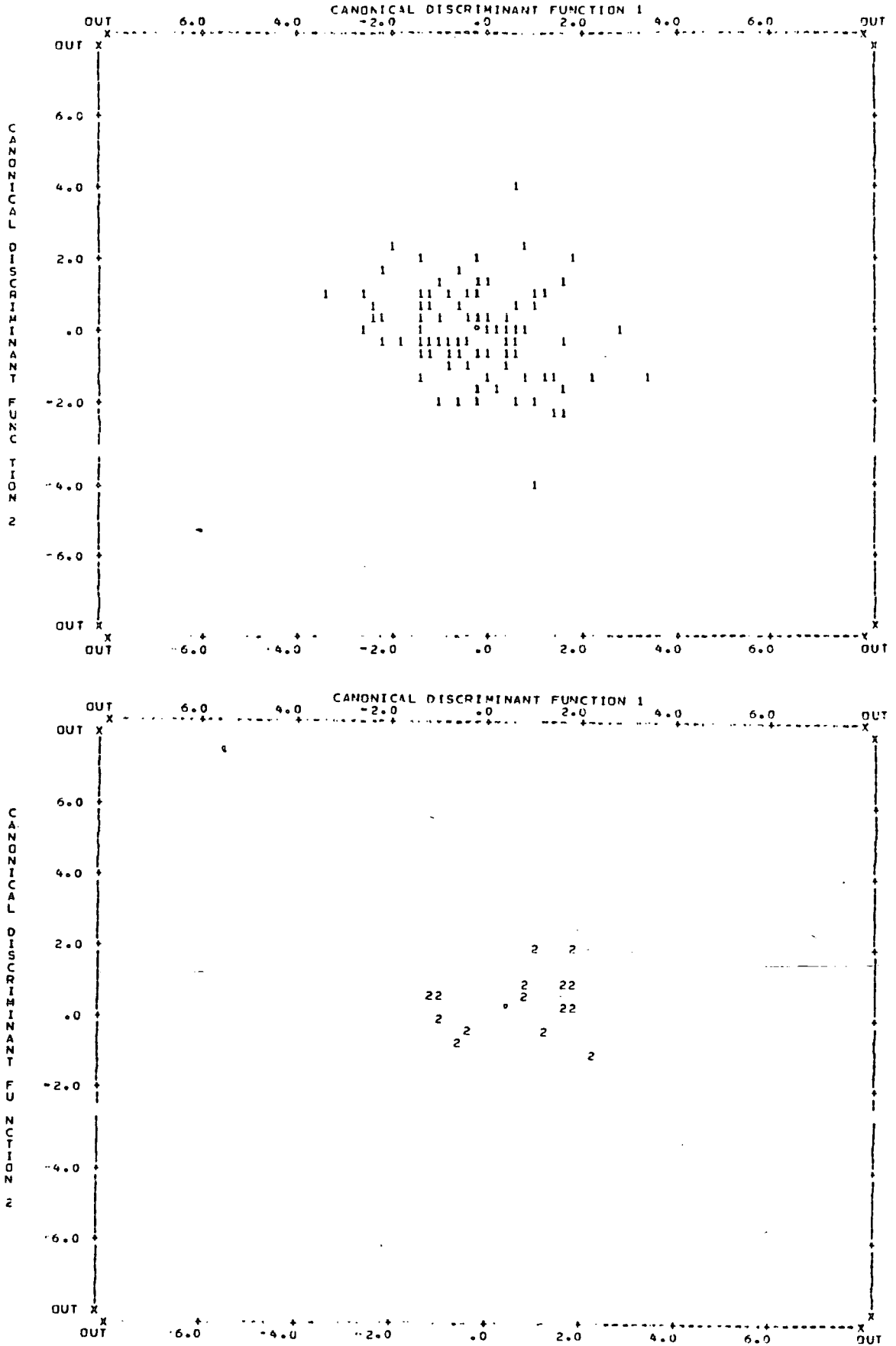

Table 8.105 - Females: LW1 to RH5

CLASSIFICATION RESULTS

ACTUAL GROUP	NO. OF CASES	PREDICTED GROUP MEMBERSHIP			
		1	2	3	4
GROUP 1	201	140 69.7%	34 16.9%	22 10.9%	5 2.5%
GROUP 2	27	11 40.7%	11 40.7%	4 14.8%	1 3.7%
GROUP 3	25	7 28.0%	2 8.0%	16 64.0%	0 0.0%
GROUP 4	4	0 0.0%	1 25.0%	0 0.0%	3 75.0%

PERCENT OF "GROUPED" CASES CORRECTLY CLASSIFIED: 66.15%

(iv) Ridge Atrophy - Variables: LA and RA

DH subjects , both males and females, were found to have significantly greater occurrence of finger ridge atrophy in comparison to controls (Tables 8.106 and 8.107). The differences between DH and controls were all statistically highly significant at the 1% level apart from female RA which was significant at the 5% level.

Table 8.106

Percentage Frequencies

Finger Ridge Atrophy

(a) Males

Group	n	LA				RA			
		0	1	2	3	0	1	2	3
DH	48	66.7	16.7	12.5	4.2	60.4	20.8	12.5	6.3
Coeliacs	10	88.9	11.1	0.0	0.0	77.8	11.1	11.1	0.0
Controls	206	87.4	7.3	5.3	0.0	83.9	9.8	5.9	0.0

(b) Females

Group	n	LA				RA			
		0	1	2	3	0	1	2	3
DH	28	50.0	35.7	3.6	10.7	66.7	22.2	0.0	11.1
Coeliacs	26	73.1	3.8	19.2	3.8	76.9	3.8	15.4	3.8
Controls	203	84.2	10.8	4.4	0.5	85.7	8.4	5.9	0.0

Table 8.107 - Probabilities from Mann-Whitney U Tests

(a) MALES

VARIABLE	CONT : DH	CONT:COEL	DH : COEL
LA	0.0004**	0.8445	0.1579
RA	0.0002**	0.6209	0.3271

(b) FEMALES

VARIABLE	CONT : DH	CONT:COEL	DH : COEL
LA	0.0000**	0.0856	0.2115
RA	0.0116*	0.1676	0.5224

(d) Palmar Patterns

(i) Palmar Pattern Occurrence - Variables: PTL to PARR

For palmar pattern occurrence in male subjects, DH patients were found to have a statistically significantly higher occurrence of central patterns on I_2 of the left hand and a significantly lower occurrence of peripheral patterns on I_4 of both hands in comparison to control males. Male Coeliac patients were found to have a highly significantly lower occurrence of central pattern on I_4 of the left hand and a significantly lower occurrence of peripheral hypothenar pattern on the same hand when compared to both DH and control subjects. On the right hand I_4 area, Coeliacs were found to have highly significantly greater occurrence of ulnar pattern in comparison to both other groups (see Tables 8.108 and 8.110a).

For female subjects, DH patients had a significantly higher occurrence of central hypothenar patterns on the left hand, peripheral hypothenar patterns and radial hypothenar patterns on the right hands. Female Coeliacs were found to have significantly lower occurrence of peripheral pattern on I_4 of the right hand in comparison to both DH and controls (Tables 8.109 and 8.110b).

When discriminant analysis was carried out for male subjects using this set of variables three canonical discriminant functions were obtained. Function 1 accounted for 70.13% of the variance and was composed of three variables (C4L, U4R and PHL (see Tables 8.111 and 8.112). The Table of F statistics and significances between groups (Table 8.113) shows the most widely separated groups to be Coeliacs and controls ($F = 10.196$) both with highly significant differences.

The territorial map (Figure 8.28) shows controls and DH patients to be close together with Coeliac relatives close to controls. Coeliacs however are removed considerably to the right. Classification results show 58.14% correct grouping with DH patients being the best grouped (60.4%) followed by controls (58.8%) see Table 8.114.

Discriminant analysis for females shows discriminant Function 1 to account for 57.48% of the variance with Function 2 taking out another 25.28% (Table 8.115). Seven variables contribute to Function 1 with five being from the left hand (Table 8.116).

Table 8.117 shows the greatest differences to be between controls and DH females ($F = 3.0213$) followed by DH and Coeliacs ($F = 2.6248$). The territorial map (Figure 8.29) shows good separation between the groups with DH and Coeliacs equally removed from controls and Coeliac relatives to the left in the same direction as the Coeliacs. Classification results show 54.03% correctness with best groups being Coeliacs (57.1%) and controls (56.4%) see Table 8.118.

Table 8.108(a)

Percentage Frequencies

Palmar Patterns

Males : Left Hand

Group	n	PTL		RTL		P2L		C2L		P3L		C3L		P4L		
		0	1	0	1	0	1	0	1	0	1	0	1	0	1	1
DH	48	91.7	8.3	100.0	0.0	100.0	0.0	97.9	2.1	37.5	62.5	100.0	0.0	58.3	41.7	0.0
Codians	10	100.0	0.0	100.0	0.0	100.0	0.0	100.0	0.0	75.0	25.0	100.0	0.0	50.0	50.0	0.0
Contr ds	206	92.7	7.3	93.6	6.4	97.6	2.4	100.0	0.0	46.3	53.7	99.5	0.5	39.0	60.0	1.0

Group	n	C4L		U4L		PHL			CHL		RHL		UHTL		HARL		PARL	
		0	1	0	1	0	1	2	0	1	0	1	0	1	0	1	0	1
DH	48	100.0	0.0	97.9	2.1	89.6	10.4	0.0	68.8	31.3	97.9	2.1	100.0	0.0	100.0	0.0	100.0	0.0
Codians	10	75.0	25.0	100.0	0.0	50.0	50.0	0.0	100.0	0.0	100.0	0.0	100.0	0.0	100.0	0.0	100.0	0.0
0.0	206	100.0	0.0	98.0	2.0	87.8	12.2	0.0	71.2	28.8	99.0	1.0	100.0	0.0	98.5	1.5	100.0	0.0

Table 8.108(b)

Percentage Frequencies

Palmar Patterns

Males : Right Hand

		PTR		RTR		P2R		C2R		P3R			C3R		P4R		
		0	1	0	1	0	1	0	1	0	1	2	0	1	0	1	2
DH	48	95.8	4.2	97.9	6.3	93.8	6.3	100.0	0.0	22.9	77.1	0.0	100.0	0.0	66.7	33.3	0.0
Controls	10	100.0	0.0	100.0	0.0	100.0	0.0	100.0	0.0	50.0	50.0	0.0	100.0	0.0	100.0	0.0	0.0
Controls	206	95.6	4.4	96.6	3.4	94.6	5.4	100.0	0.0	37.6	62.4	0.0	99.5	0.5	51.2	47.8	1.0

Group	n	C4R		U4R		PHR			CHR			RHR		UHTR		HRAR		PARR	
		0	1	0	1	0	1	2	0	1	2	0	1	0	1	0	1	0	1
DH	48	100.0	0.0	100.0	0.0	95.8	4.2	0.0	66.7	33.3	0.0	100.0	0.0	100.0	0.0	100.0	0.0	100.0	0.0
Controls	10	100.0	0.0	75.0	25.0	75.0	25.0	0.0	100.0	0.0	0.0	100.0	0.0	100.0	0.0	100.0	0.0	100.0	0.0
Controls	206	99.0	1.0	99.5	0.5	87.3	12.7	0.0	76.6	23.4	0.0	94.6	5.4	100.0	0.0	99.0	1.0	100.0	0.0

Table 8.109(a)

Percentage Frequencies

Palmar Patterns

Females : Left Hand

		PTL		RTL		P2L		C2L		P3L			C3L		P4L		
		0	1	0	1	0	1	0	1	0	1	2	0	1	0	1	2
DH	28	92.9	7.1	92.9	7.1	96.4	3.6	100.0	0.0	32.1	67.9	0.0	100.0	0.0	46.4	53.6	0.0
Codiacs	26	85.7	14.3	92.9	7.1	100.0	0.0	100.0	0.0	57.1	42.9	0.0	100.0	0.0	42.9	57.1	0.0
Contrds	203	92.1	7.9	94.6	5.4	98.5	1.5	100.0	0.0	51.2	48.3	0.5	99.5	0.5	36.9	62.1	1.0

Group	n	C4L		U4L		PHL			CHL			RHL		UHTL		HARL		PARL	
		0	1	0	1	0	1	2	0	1	2	0	1	0	1	0	1	0	1
DH	28	100.0	0.0	100.0	0.0	78.6	21.4	0.0	57.1	39.3	3.6	96.4	3.6	100.0	0.0	100.0	0.0	100.0	0.0
Codiacs	26	100.0	0.0	100.0	0.0	85.7	14.3	0.0	85.7	14.3	0.0	100.0	0.0	100.0	0.0	100.0	0.0	100.0	0.0
Contrds	203	99.0	1.0	97.5	2.5	85.7	13.8	0.5	76.4	23.6	0.0	99.0	1.0	100.0	0.0	100.0	0.0	100.0	0.0

Table 8.109(a)

Percentage Frequencies

Palmar Patterns

Females : Left Hand

		PTL		RTL		P2L		C2L		P3L			C3L		P4L		
		0	1	0	1	0	1	0	1	0	1	2	0	1	0	1	2
DH	28	92.9	7.1	92.9	7.1	96.4	3.6	100.0	0.0	32.1	67.9	0.0	100.0	0.0	46.4	53.6	0.0
Coeliacs	26	85.7	14.3	92.9	7.1	100.0	0.0	100.0	0.0	57.1	42.9	0.0	100.0	0.0	42.9	57.1	0.0
Contr ds	203	92.1	7.9	94.6	5.4	98.5	1.5	100.0	0.0	51.2	48.3	0.5	99.5	0.5	36.9	62.1	1.0

Group	n	C4L		U4L		PHL			CHL			RHL		UHTL		HARL		PARL	
		0	1	0	1	0	1	2	0	1	2	0	1	0	1	0	1	0	1
DH	28	100.0	0.0	100.0	0.0	78.6	21.4	0.0	57.1	39.3	3.6	96.4	3.6	100.0	0.0	100.0	0.0	100.0	0.0
Coeliacs	26	100.0	0.0	100.0	0.0	85.7	14.3	0.0	85.7	14.3	0.0	100.0	0.0	100.0	0.0	100.0	0.0	100.0	0.0
Contr ds	203	99.0	1.0	97.5	2.5	85.7	13.8	0.5	76.4	23.6	0.0	99.0	1.0	100.0	0.0	100.0	0.0	100.0	0.0

Table 8.109(b)

Percentage Frequencies

Palmar Patterns

Females : Right Hand

		PTR		RTR		P2R		C2R		P3R			C3R		P4R		
		0	1	0	1	0	1	0	1	0	1	2	0	1	0	1	2
DH	28	92.9	7.1	92.9	7.1	96.4	3.6	100.0	0.0	46.4	53.6	0.0	100.0	0.0	39.3	60.7	0.0
Coelacs	26	85.7	14.3	85.7	14.3	100.0	0.0	100.0	0.0	21.4	78.6	0.0	100.0	0.0	78.6	21.4	0.0
Conrds	203	94.1	5.9	94.1	5.9	98.0	2.0	100.0	0.0	38.9	61.1	0.0	100.0	0.0	46.8	53.2	0.0

Group	n	C4R		U4R		PHR			CHR			RHR		UHTR		HRAR		PARR	
		0	1	0	1	0	1	2	0	1	2	0	1	0	1	0	1	0	1
DH	28	100.0	0.0	100.0	0.0	78.6	21.4	0.0	67.9	32.1	0.0	89.3	10.7	100.0	0.0	96.4	3.6	100.0	0.0
Coelacs	26	100.0	0.0	100.0	0.0	78.6	21.4	0.0	71.4	28.6	0.0	100.0	0.0	100.0	0.0	100.0	0.0	100.0	0.0
Conrds	203	99.5	0.5	99.5	0.5	92.6	6.9	0.5	74.4	25.1	0.5	98.5	1.5	100.0	0.0	99.0	1.0	100.0	0.0

Table 8.110 - Probabilities from Mann-Whitney U Tests

(a) MALES

VARIABLE	CONT : DH	CONT:COEL	DH : COEL
PTL	0.8103	0.5744	0.5518
RTL	0.0731	0.6020	1.0000
P2L	0.2754	0.7519	1.0000
C2L	0.0388*	1.0000	0.7728
P3L	0.2683	0.2520	0.1458
C3L	0.6285	0.8886	1.0000
P4L	0.0136*	0.6508	0.7482
C4L	1.0000	0.0000**	0.0005**
U4L	0.9529	0.7779	0.7728
PHL	0.7321	0.0265*	0.0273*
CHL	0.7355	0.2103	0.1893
RHL	0.5242	0.8426	0.7728
UHTL	1.0000	1.0000	1.0000
HARL	0.4001	0.8075	1.0000
PARL	1.0000	1.0000	1.0000
PTR	0.9456	0.6683	0.6801
RTR	0.6358	0.7069	0.7728
P2R	0.8098	0.6340	0.6100
C2R	1.0000	1.0000	1.0000
P3R	0.0557	0.6029	0.2340
C3R	0.6285	0.8886	1.0000
P4R	0.0496*	0.3492	0.7353
C4R	0.4929	0.8426	1.0000
U4R	0.6285	0.0000**	0.0005**
PHR	0.0911	0.4712	0.0891
CHR	0.1556	0.2764	0.1693
RHR	0.1015	0.6340	1.0000
UHTR	1.0000	1.0000	1.0000
HRAR	0.4929	0.8426	1.0000
PARR	1.0000	1.0000	1.0000

Table 8.110 continued

(b) FEMALES

VARIABLE	CONT : DH	CONT:COEL	DH : COEL
PTL	0.8915	0.4018	0.4627
RTL	0.7112	0.7853	1.0000
P2L	0.4270	0.6477	0.4795
C2L	1.0000	1.0000	1.0000
P3L	0.0639	0.6589	0.1242
C3L	0.7103	0.7928	1.0000
P4L	0.3109	0.6315	0.8285
C4L	0.5986	0.7097	1.0000
U4L	0.4022	0.5534	1.0000
PHL	0.3315	0.9942	0.5830
CHL	0.0237*	0.4223	0.0640
RHL	0.2582	0.7097	0.4795
UHTL	1.0000	1.0000	1.0000
HARL	1.0000	1.0000	1.0000
PARL	1.0000	1.0000	1.0000
PTR	0.7984	0.2184	0.4627
RTR	0.7984	0.2184	0.4627
P2R	0.5861	0.5969	0.4795
C2R	1.0000	1.0000	1.0000
P3R	0.4475	0.1928	0.1202
C3R	1.0000	1.0000	1.0000
P4R	0.4555	0.0217*	0.0176*
C4R	0.7103	0.7928	1.0000
U4R	0.7103	0.7928	1.0000
PHR	0.0165*	0.0682	1.0000
CHR	0.4749	0.8165	0.8156
RHR	0.0040**	0.6477	0.2092
UHTR	0.5986	0.7097	1.0000
HRAR	0.2582	0.7097	0.4795
PARR	1.0000	1.0000	1.0000

Table 8.111 - Canonical Discriminant Functions - Males: PTL to PARR

FUNCTION	EIGENVALUE	PERCENT OF VARIANCE	CUMULATIVE PERCENT	CANONICAL CORRELATION
1*	0.40452	70.13	70.13	0.5366679
2*	0.10495	18.19	88.32	0.3081905
3*	0.06738	11.68	100.00	0.2512481

Table 8.112 - Structure Matrix

	FUNC 1	FUNC 2	FUNC 3
C4L	0.89792*	0.13776	0.02062
U4R	0.89792*	0.13776	0.02062
PHL	0.24007*	-0.02171	0.22426
P4L	-0.05971	0.56704*	0.04580
RTL	-0.07080	0.54896*	0.31635
P3L	-0.10076	-0.41895*	0.30237
C2L	0.00281	-0.36117*	0.23196
P3R	0.07314	-0.19925*	0.00796
RTR	-0.02790	0.16583*	-0.15499
RHL	0.02046	0.06895*	0.06808
PTL	-0.06226	0.15413	-0.46667*
PHR	0.07726	0.20491	0.41854*
P4R	-0.04002	0.16982	0.21369*
PTR	-0.04044	-0.04691	0.13016*
RHR	-0.02758	0.07248	0.10942*
CHL	-0.05272	-0.06490	0.10850*
C3L	0.01383	-0.06337	-0.09863*
C3R	0.01383	-0.06337	-0.09863*
U4L	0.01351	-0.03659	-0.09584*
P2R	-0.03795	0.03468	0.07565*
CHR	-0.02292	0.04173	0.05173*
P2L	0.01593	0.03609	0.04625*
C4R	0.00509	0.01517	-0.03251*
HARL	-0.00919	-0.02007	0.02305*
HRAR	0.00359	0.01070	-0.02293*

Table 8.113 - F Statistics and intergroup significances

GROUP	GROUP	1	2	3
2		2.6231 0.0065		
3		11.030 0.0000	10.196 0.0000	
4		2.0631 0.0334	2.4788 0.0100	8.1222 0.0030

Code	Group
1	Controls
2	DH
3	Coeliacs
4	Coeliac unaffected relatives

Figure 8.28 - Territorial Map - Males: PTL to PARR

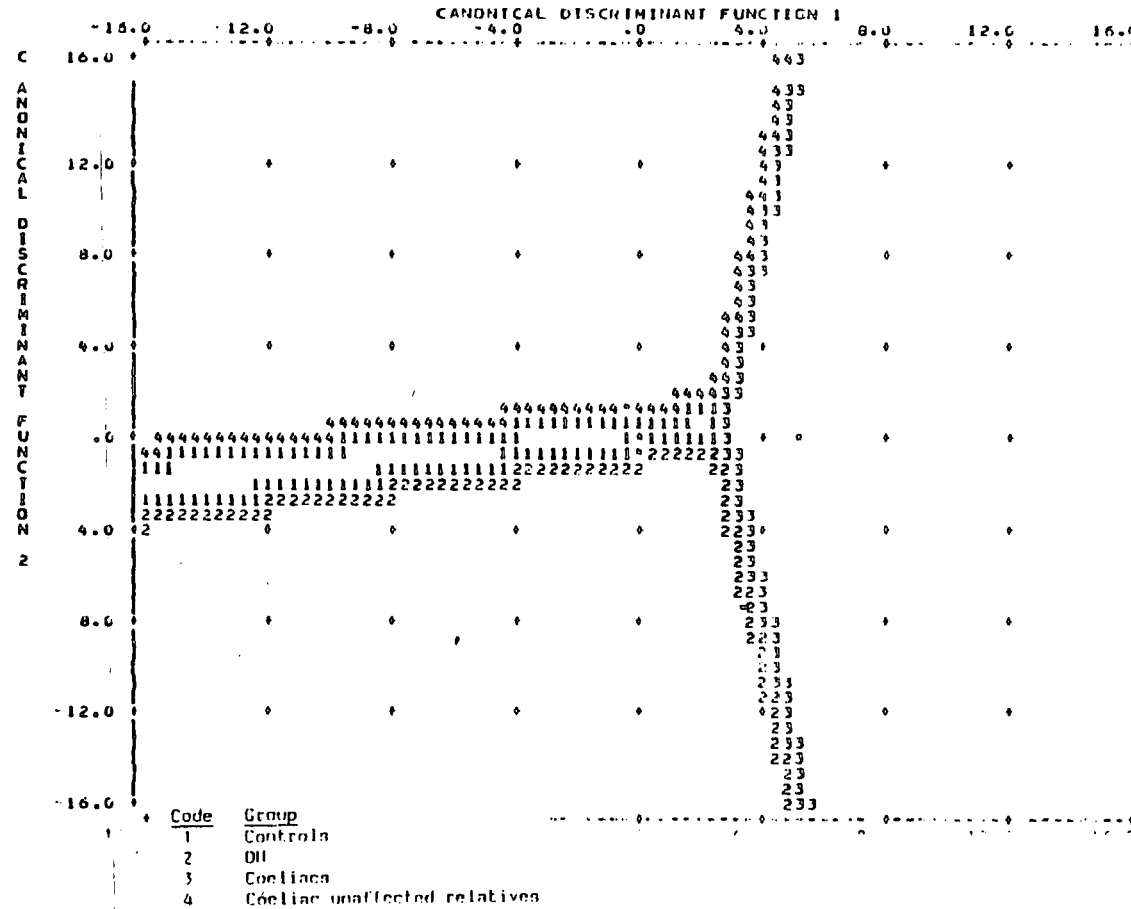

Figure 8.28 - Territorial Map

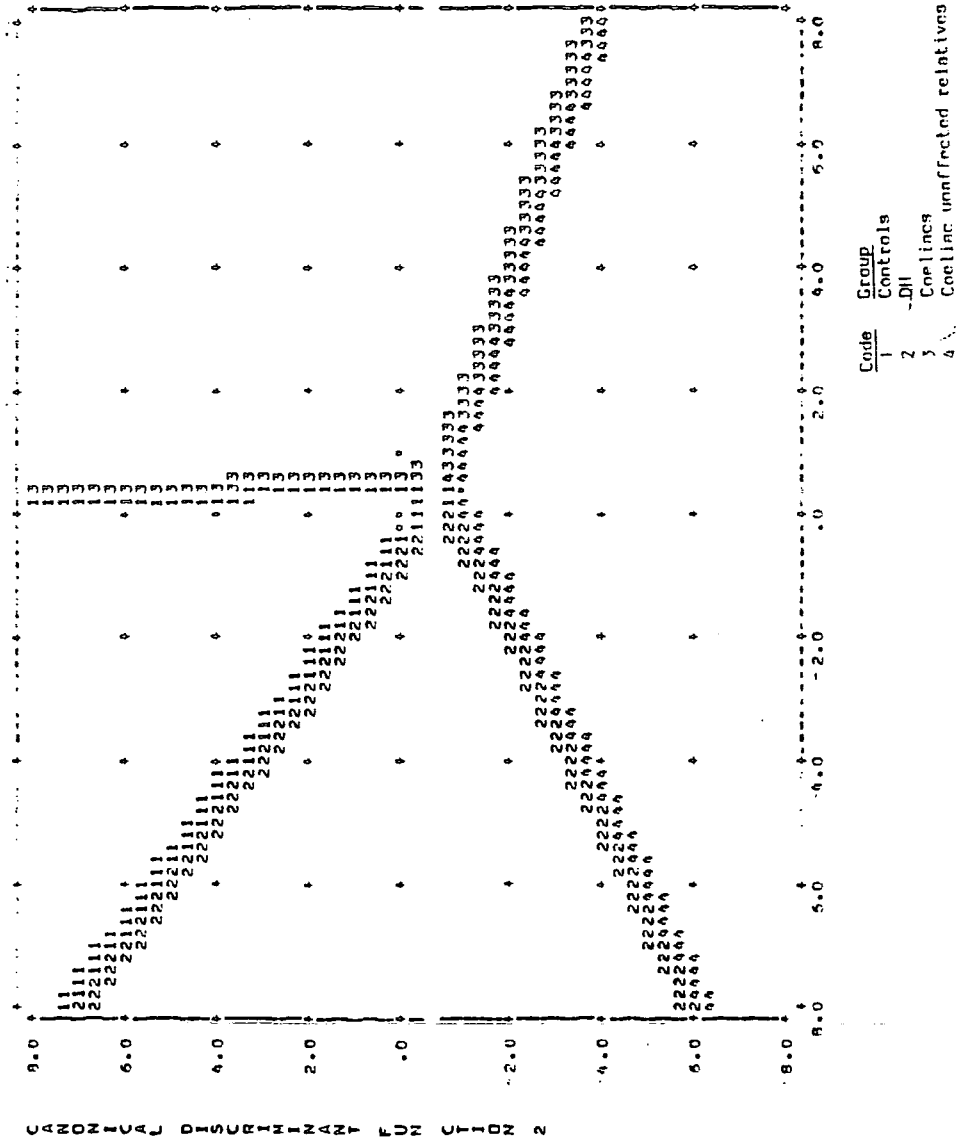

Table 8.114 - Males: PTL to PARR

CLASSIFICATION RESULTS

ACTUAL GROUP	NO. OF CASES	PREDICTED GROUP MEMBERSHIP			
		1	2	3	4
GROUP 1	199	117 58.8%	65 32.7%	0 0.0%	17 8.5%
GROUP 2	48	17 35.4%	29 60.4%	0 0.0%	2 4.2%
GROUP 3	4	2 50.0%	1 25.0%	1 25.0%	0 0.0%
GROUP 4	7	3 42.9%	1 14.3%	0 0.0%	3 42.9%

PERCENT OF "GROUPED" CASES CORRECTLY CLASSIFIED: 58.14%

Table 8.115 - Canonical Discriminant Functions - Females: PTL to PARR

FUNCTION	EIGENVALUE	PERCENT OF VARIANCE	CUMULATIVE PERCENT	CANONICAL CORRELATION
1*	0.11063	57.48	57.48	0.3156123
2*	0.04866	25.28	82.76	0.2154146
3*	0.03319	17.24	100.00	0.1792185

Table 8.116 - Structure Matrix

	FUNC 1	FUNC 2	FUNC 3
RHR	0.54503*	0.22861	0.33782
P3L	0.51035*	-0.02213	-0.30830
CHL	0.46809*	0.08654	0.41891
C4L	0.11552*	0.02012	0.09032
C3L	-0.07581*	0.04376	0.00570
C4R	-0.07581*	0.04376	0.00570
P2L	0.06344*	0.05370	0.05847
PHR	0.30954	0.59470*	-0.13188
P4R	0.36607	0.57165*	0.07474
P3R	-0.04929	0.36934*	-0.16190
PHL	0.16093	0.30768*	0.00910
PTR	0.00834	0.30357*	-0.29337
PTL	-0.18161	0.26236*	0.23299
RTR	0.00136	0.11477*	0.02350
RTL	0.08646	0.11415*	0.04760
P2R	-0.06780	0.07384*	0.05076
HRAR	0.03559	-0.05457*	0.01009
U4L	0.01542	0.05051*	0.00268
P4L	0.15925	-0.09066	0.23851*
RHL	-0.00316	0.00167	-0.22813*
CHR	0.07277	0.09591	0.19127*
UHTR	0.03159	-0.04924	0.09232*
U4R	0.00390	0.01849	0.03197*

Table 8.117 - F Statistics and intergroup significances

GROUP	GROUP 1	GROUP 2	GROUP 3
2	3.0213 0.0046		
3	1.7286 0.1030	2.5248 0.0125	
4	1.6544 0.1211	2.4909 0.0174	1.3305 0.2365

Code Group
1 Controls
2 DH
3 Coeliac
4 Coeliac unaffected relatives

Figure 8.29 - Territorial Map - Females: PTL to PARR

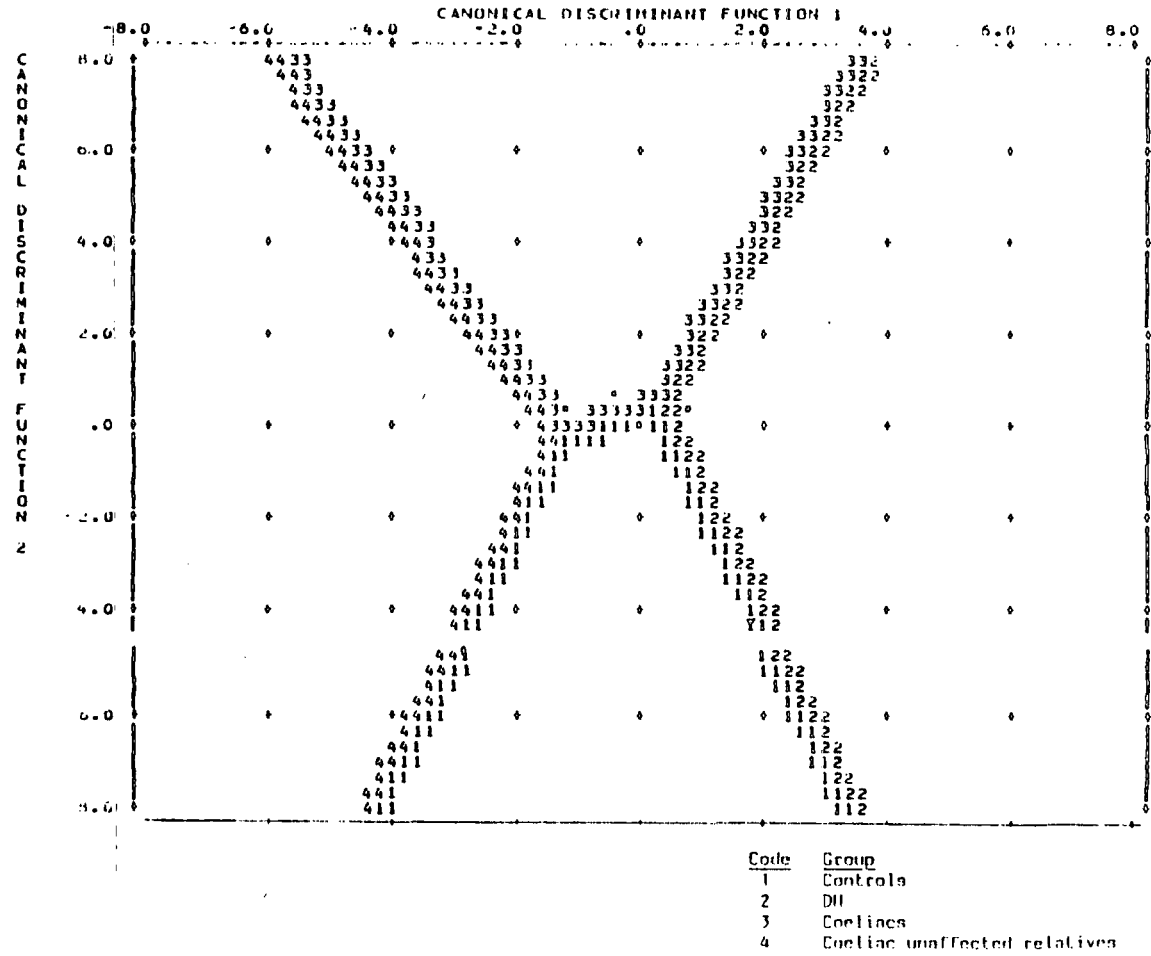

Table 8.118 - Females: PTL to PARR

CLASSIFICATION RESULTS

ACTUAL GROUP	NO. OF CASES	PREDICTED GROUP MEMBERSHIP			
		1	2	3	4
GROUP 1	202	114 56.4%	31 15.3%	43 21.3%	14 6.9%
GROUP 2	28	14 50.0%	11 39.3%	3 10.7%	0 0.0%
GROUP 3	14	4 28.6%	2 14.3%	8 57.1%	0 0.0%
GROUP 4	4	1 25.0%	0 0.0%	2 50.0%	1 25.0%

PERCENT OF "GROUPED" CASES CORRECTLY CLASSIFIED: 54.03%

(ii) Hypothenar Pattern Intensity Indices - Variables: HYPOR to HYPBH

No significant differences were found for intergroup comparisons for males using these variables. Female DH patients were found to have highly significantly greater occurrence of all three hypothenar pattern intensity indices in comparison to controls. They were also found to have a significantly greater occurrence of HYPOL in comparison to Coeliac females (see Tables 8.119 and 8.120).

Table 8.119

Percentage Frequencies

Hypothenar Pattern Intensity Indices

(a) Males

Group	n	HYPOR				HYPOL				HYPBH					
		0	1	2	3	0	1	2	3	0	1	2	3	4	5
DH	48	62.5	37.5	0.0	0.0	56.3	43.8	0.0	0.0	50.0	18.8	31.3	0.0	0.0	0.0
Coeliacs	10	75.0	25.0	0.0	0.0	50.0	50.0	0.0	0.0	50.0	25.0	25.0	0.0	0.0	0.0
Controls	206	61.0	36.6	2.4	0.0	60.5	37.6	1.5	0.5	53.7	13.7	29.3	2.9	0.0	0.5

(b) Females

Group	n	HYPOR				HYPOL				HYPBH					
		0	1	2	3	0	1	2	3	0	1	2	3	4	5
DH	48	39.3	57.1	3.6	0.0	39.3	50.0	10.7	0.0	28.6	21.4	35.7	14.3	0.0	0.0
Coeliacs	10	50.0	50.0	0.0	0.0	71.4	28.6	0.0	0.0	42.9	35.7	21.4	0.0	0.0	0.0
Controls	206	66.5	30.5	3.0	0.0	63.1	34.5	2.5	0.0	54.2	20.7	20.7	3.9	0.5	0.0

Table 8.120 - Probabilities from Mann-Whitney U Test Results

(a) MALES

VARIABLE	CONT : DH	CONT:COEL	DH : COEL
HYPOR	0.7567	0.5631	0.6213
HYPOL	0.6692	0.6935	0.8107
HYPBH	0.9307	0.9519	0.9105

(b) FEMALES

VARIABLE	CONT : DH	CONT:COEL	DH : COEL
HYPOR	0.0067**	0.2572	0.4526
HYPOL	0.0087**	0.4984	0.0391*
HYPBH	0.0030**	0.6881	0.0942

(iii) Interdigital Pattern Intensity Indices - Variables: INTOR to INTBT

No statistically significant differences were found for either male or female subjects for this set of variable (Tables 8.121 and 8.122).

Table 8.121

Percentage Frequencies : Interdigital Pattern Intensity Indices

(a) Males

Group	n	INTOR					INTOL					
		0	1	2	3	4	0	1	2	3	4	5
DH	48	0.0	81.3	14.6	4.2	0.0	0.0	83.3	16.7	0.0	0.0	0.0
Coeliacs	10	0.0	100.0	0.0	0.0	0.0	0.0	100.0	0.0	0.0	0.0	0.0
Controls	206	0.5	76.1	19.0	4.4	0.0	0.0	70.6	25.0	3.9	0.5	0.0

Group	n	INTBT									
		0	1	2	3	4	5	6	7	8	9
DH	48	0.0	0.0	75.0	14.6	6.3	4.2	0.0	0.0	0.0	0.0
Coeliacs	10	0.0	0.0	100.0	0.0	0.0	0.0	0.0	0.0	0.0	0.0
Controls	206	0.0	0.0	64.7	15.7	14.7	2.9	2.0	0.0	0.0	0.0

(b) Females

Group	n	INTOR					INTOL					
		0	1	2	3	4	0	1	2	3	4	5
DH	28	3.6	67.9	25.0	0.0	3.6	3.6	60.7	32.1	0.0	3.6	0.0
Coeliacs	26	7.1	64.3	21.4	7.1	0.0	7.1	71.4	14.3	7.1	0.0	0.0
Controls	203	2.5	71.9	20.7	3.9	1.0	3.0	68.0	24.1	4.4	0.0	0.5

Group	n	INTBT									
		0	1	2	3	4	5	6	7	8	9
DH	28	3.6	0.0	53.6	21.4	17.9	0.0	0.0	0.0	3.6	0.0
Coeliacs	26	7.1	0.0	57.1	21.4	7.1	0.0	7.1	0.0	0.0	0.0
Controls	203	2.0	1.5	60.1	17.2	13.3	2.5	3.0	0.0	0.0	0.5

Table 8.122 - Probabilities from Mann-Whitney U Test Results

(a) MALES

VARIABLE	CONT : DH	CONT:COEL	DH : COEL
INTOR	0.5445	0.2862	0.3471
INTOL	0.0603	0.2014	0.3794
INTBT	0.1451	0.1514	0.2631

(b) FEMALES

VARIABLE	CONT : DH	CONT:COEL	DH : COEL
INTOR	0.8533	0.9845	0.9105
INTOL	0.5725	0.4728	0.3690
INTBT	0.6127	0.7684	0.5764

(e) Palmar Triradii

(i) Accessory Triradii - Variables: LX2 to RX4

Only one statistically significant difference was found for this set of variables and that was for accessory triradii on I_4 of the left hand. Here control males were found to have a significantly higher occurrence of accessory triradii in comparison to DH males (Tables 8.123 and 8.124).

Table 8.123

Percentage Frequencies : Accessory Triradii

(a) Males

Group	n	LX2			LX3			LX4			RX2			RX3			RX4		
		0	1	2	0	1	2	0	1	2	0	1	2	0	1	2	0	1	2
DH	48	97.9	2.1	0.0	100.0	0.0	0.0	93.8	6.3	0.0	93.8	6.3	0.0	100.0	0.0	0.0	89.6	10.4	0.0
Coeliacs	10	100.0	0.0	0.0	100.0	0.0	0.0	100.0	0.0	0.0	100.0	0.0	0.0	100.0	0.0	0.0	100.0	0.0	0.0
Controls	206	97.6	2.4	0.0	99.5	0.5	0.0	82.0	18.0	0.0	94.6	5.4	0.0	100.0	0.0	0.0	85.4	14.6	0.0

(b) Females

Group	n	LX2			LX3			LX4			RX2			RX3			RX4		
		0	1	2	0	1	2	0	1	2	0	1	2	0	1	2	0	1	2
DH	28	96.4	3.6	0.0	100.0	0.0	0.0	75.0	25.0	0.0	96.4	3.6	0.0	100.0	0.0	0.0	82.1	17.9	0.0
Coeliacs	26	100.0	0.0	0.0	100.0	0.0	0.0	85.7	14.3	0.0	100.0	0.0	0.0	100.0	0.0	0.0	92.9	7.1	0.0
Controls	203	98.5	1.5	0.0	99.0	1.0	0.0	81.3	17.7	0.0	98.0	2.0	0.0	99.5	0.5	0.0	83.3	16.7	0.0

Table 8.124 - Probabilities from Mann-Whitney U Test Results

(a) MALES

VARIABLE	CONT : DH	CONT:COEL	DH : COEL
LX2	0.8843	0.7519	0.7728
LX3	0.6285	0.8886	1.0000
LX4	0.0441*	0.3487	0.6100
RX2	0.8098	0.6340	0.6100
RX3	1.0000	1.0000	1.0000
RX4	0.4471	0.4082	0.5013

(b) FEMALES

VARIABLE	CONT : DH	CONT:COEL	DH : COEL
LX2	0.4270	0.6477	0.4795
LX3	0.5986	0.7097	1.0000
LX4	0.4512	0.6705	0.4306
RX2	0.5861	0.5969	0.4795
RX3	0.7103	0.7928	1.0000
RX4	0.8836	0.3457	0.3554

(ii) Axial Triradii - Variables: LTO to TBR

Male Coeliacs were found to have a significantly higher occurrence of t on the left hand and a significantly lower occurrence of t on the right hand in comparison to controls. Female DH subjects were found to have a significantly higher occurrence of border triradius on the left hand in comparison to controls (Tables 8.125 and 8.126).

Table 8.125

Percentage Frequencies : Axial Triradi

(a) Males

Group	n	LTO			LTI			LTII			TBL		
		0	1	2	0	1	2	0	1	2	0	1	2
DH	48	14.6	85.4	0.0	77.1	22.9	0.0	97.9	2.1	0.0	68.3	31.3	0.0
Coeliacs	10	0.0	75.0	25.0	75.0	25.0	0.0	100.0	0.0	0.0	100.0	0.0	0.0
Controls	206	24.9	75.1	0.0	70.2	29.8	0.0	92.2	7.8	0.0	71.3	28.7	0.0

Group	n	RT			RTI			RTII			TBR		
		0	1	2	0	1	2	0	1	2	0	1	2
DH	48	14.6	85.4	0.0	83.3	16.7	0.0	97.9	2.1	0.0	68.8	31.3	0.0
Coeliacs	10	75.0	25.0	0.0	100.0	0.0	0.0	100.0	0.0	0.0	100.0	0.0	0.0
CONTROLS	206	19.5	80.5	0.0	76.6	22.9	0.5	90.7	9.3	0.0	72.1	27.9	0.0

(b) Females

Group	n	LTO			LTI			LTII			TBL		
		0	1	2	0	1	2	0	1	2	0	1	2
DH	28	17.9	82.1	0.0	71.4	28.6	0.0	85.7	14.3	0.0	53.6	46.4	0.0
Coeliacs	26	7.1	92.9	0.0	78.6	21.4	0.0	100.0	0.0	0.0	78.6	21.4	0.0
Controls	203	29.6	70.4	0.0	63.1	36.5	0.5	92.6	7.4	0.0	75.4	24.6	0.0

Group	n	RT			RTI			RTII			TBR		
		0	1	2	0	1	2	0	1	2	0	1	2
DH	28	25.0	75.0	0.0	60.7	39.3	0.0	92.9	7.1	0.0	57.1	42.9	0.0
Coeliacs	26	7.1	92.9	0.0	78.6	21.4	0.0	92.9	7.1	0.0	71.4	28.6	0.0
Controls	203	27.6	72.4	0.0	69.0	31.0	0.0	95.1	4.9	0.0	72.4	27.6	0.0

Table 8.126 - Probabilities from Mann-Whitney U Tests

(a) MALES

VARIABLE	CONT : DH	CONT:COEL	DH : COEL
LTO	0.1274	0.0465*	0.0584
LTI	0.3455	0.8482	0.9250
LTII	0.1549	0.5608	0.7728
TBL	0.7287	0.2111	0.1893
RT	0.4302	0.0487*	0.0584
RTI	0.3062	0.2767	0.3794
RTII	0.0974	0.5230	0.7728
TBR	0.6486	0.2198	0.1893

(b) FEMALES

VARIABLES	CONT :DH	CONT:COEL	DH : COEL
LTO	0.1978	0.0718	0.3554
LTI	0.3803	0.2404	0.6239
LTII	0.2141	0.2929	0.1418
TBL	0.0154*	0.7879	0.1202
RT	0.7738	0.0935	0.1699
RTI	0.3814	0.4509	0.2529
RTII	0.6210	0.7152	1.0000
TBR	0.0972	0.9366	0.3746

(iii) Axial Triradial Counts - Variables: AXR, AXL and TTAX

DH females were found to have higher values for each of the three axial triradial counts in comparison to controls. The differences were found to be statistically highly significant. No statistically significant results were found for comparisons of male subjects (Tables 8.127 and 8.128).

Table 8.127

Means and Standard Deviations : Axial Triradii Counts

(a) Males

Group	n	AXR		AXL		TTAX	
		Mean	Std. Dev.	Mean	Std. Dev.	Mean	Std. Dev.
DH	48	1.354 +/- 0.483		1.417 +/- 0.498		2.771 +/- 0.881	
Coeliacs	10	1.250 +/- 0.500		1.500 +/- 0.577		2.750 +/- 0.957	
Controls	206	1.417 +/- 0.551		1.411 +/- 0.550		2.822 +/- 1.006	

(b) Females

Group	n	AXR		AXL		TTAX	
		Mean	Std. Dev.	Mean	Std. Dev.	Mean	Std. Dev.
DH	28	1.643 +/- 0.559		1.714 +/- 0.659		3.357 +/- 1.062	
Coeliacs	26	1.500 +/- 0.519		1.357 +/- 0.497		2.857 +/- 0.864	
Controls	203	1.360 +/- 0.530		1.399 +/- 0.539		2.759 +/- 0.942	

Table 8.128 - Probabilities from Mann-Whitney U Tests

(a) MALES

VARIABLE	CONT : DH	CONT:COEL	DH : COEL
AXR	0.5799	0.5678	0.6769
AXL	0.7778	0.6660	0.7482
TTAX	0.9354	0.9812	0.9850

(b) FEMALES

VARIABLE	CONT : DH	CONT:COEL	DH : COEL
AXR	0.0061**	0.2490	0.4526
AXL	0.0100**	0.8469	0.0918
TTAX	0.0030**	0.5518	0.1463

(iv) Palmar Pattern Intensity Indices - Variables: LPPII, RPPII and
IPPII

The only significant difference for this set of variables was for Total Palmar Pattern Intensity Indices where female DH patients were found to have a significantly higher value in comparison to controls (Tables 8.129 and 8.130).

Table 8.129

Means and Standard Deviations : Palmar Pattern Intensity Indices

(a) Males

		Variables					
Groups	Cases	LPPII		RPPII		TPPII	
		Mean	Std Dev	Mean	Std Dev	Mean	Std Dev
D.H.	48	5.604 +/- 0.676		5.604 +/- 0.765		11.208 +/- 1.304	
Coeliacs	10	5.500 +/- 0.577		5.250 +/- 0.500		10.750 +/- 9.957	
Controls	206	5.878 +/- 2.419		5.688 +/- 0.804		11.566 +/- 2.659	

(b) Females

		Variables					
Groups	Cases	LPPII		RPPII		TPPII	
		Mean	Std Dev	Mean	Std Dev	Mean	Std Dev
D.H.	28	6.107 +/- 1.166		5.929 +/- 0.900		12.036 +/- 1.915	
Coeliacs	26	5.571 +/- 0.646		5.786 +/- 0.802		11.357 +/- 1.277	
Controls	203	5.719 +/- 0.882		5.643 +/- 0.852		11.365 +/- 1.572	

Table 8.130 - Probabilities from Mann-Whitney U Tests

(a) MALES

VARIABLE	CONT : DH	CONT:COEL	DH : COEL
LPPII	0.3125	0.6038	0.8486
RPPII	0.5252	0.2795	0.3745
TPPII	0.3548	0.3777	0.5517

(b) FEMALES

VARIABLE	CONT : DH	CONT:COEL	DH : COEL
LPPII	0.0583	0.6465	0.1020
RPPII	0.0507	0.4204	0.5904
TPPII	0.0289*	0.8006	0.2000

(v) Maximal atd angles - Variables: LATD, RATD and SATD

As can be seen from Tables 8.131 and 8.132 no significant differences were found for atd angle for any of the intergroup comparisons for males or females.

Table 8.131

Means and Standard Deviations : atd Angles

(a) Males

		Variables					
		LATD		RATD		SATD	
Groups	Cases	Mean	Std Dev	Mean	Std Dev	Mean	Std Dev
D.H.	48	40.792	+/- 7.316	39.833	+/- 5.810	80.625	+/- 12.486
Coeliacs	10	44.000	+/- 6.976	38.250	+/- 1.893	82.250	+/- 6.602
Controls	206	41.493	+/- 7.114	41.444	+/- 8.532	82.617	+/- 14.948

(b) Females

		Variables					
		LATD		RATD		SATD	
Groups	Cases	Mean	Std Dev	Mean	Std Dev	Mean	Std Dev
D.H.	28	43.750	+/- 8.691	43.429	+/- 9.414	87.179	+/- 15.367
Coeliacs	26	39.500	+/- 5.095	41.500	+/- 8.046	81.000	+/- 9.356
Controls	203	42.103	+/- 7.884	40.512	+/- 6.132	82.616	+/- 12.751

Table 8.132 - Probabilities from Mann-Whitney U Tests

(a) MALES

VARIABLE	CONT : DH	CONT:COEL	DH : COEL
LATD	0.3164	0.2392	0.1280
RATD	0.7333	0.7207	0.8357
SATD	0.5129	0.4233	0.2418

(b) FEMALES

VARIABLE	CONT : DH	CONT:COEL	DH : COEL
LATD	0.2995	0.5964	0.1020
RATD	0.0942	0.7539	0.3840
SATD	0.1076	0.9684	0.2618

(f) Palmar Ridge Counts(i) Individual and Summed Ridge Counts - Variables: LAB to TCD

Male DH patients were found to have highly significantly lower b-c counts on both left and right hands and for both hands combined in comparison to controls. DH males were also found to have a significantly higher c-d ridge count on the right hand in comparison to Coeliac males. Male Coeliacs were found to have significantly higher values for total a-b and total b-c ridge counts in comparison to male control subjects (Tables 8.133 to 8.135).

Female DH patients were found to have highly significantly greater b-c counts on both left and right hands and both hands combined in comparison to controls. Coeliac females had significantly higher a-b and b-c counts on the left hand as well as total a-b and b-c counts in comparison to DH females.

When discriminant analysis was carried out for males canonical discriminant function 1 accounted for 64.53% of the variance and was composed of the three b-c ridge counts along with the b-d count for the left hand (Table 8.136 and 8.137). The best separation between groups was found for controls and DH males ($F = 8.1335$) see Table 8.138. The territorial map shows that controls and DH are separated the same distance as controls and Coeliac relatives with Coeliacs being furthest away from the rest (see Figure 8.30). Classification results show 49.61% correct grouping of cases with the best groups being Coeliac relatives (57.1%), DH (54.2%) and Coeliacs (50%) see Table 8.139.

For female subjects, three canonical discriminant functions were produced the first accounting for 56.23% and being composed of eight out of the total thirteen variables (see Tables 8.140 and 8.141). The best separated groups were found to be DH and Coeliacs ($F = 4.5589$) followed by Coeliacs and controls ($F = 4.4765$) see Table 8.142. The territorial map shows controls and DH subjects to be closest together with Coeliacs and Coeliac relatives removed from them (Figure 8.31). 100% correct classification was shown for Coeliac relatives followed by DH subjects (70.4% correct). Overall cases correctly classified were found to be 46.91% (Table 8.143).

Table 8.133

Means and Standard Deviations : Palmar Ridge Counts

(a) Males

Group	n	LAB		LBC		LCD		RAB		RBC	
		Mean	Std. Dev.	Mean	Std. Dev.	Mean	Std. Dev.	Mean	Std. Dev.	Mean	Std. Dev.
DH	48	42.000	+/- 5.732	23.354	+/- 4.378	35.542	+/- 5.720	40.500	+/- 5.344	23.333	+/- 4.402
Coeliacs	10	44.250	+/- 1.500	23.750	+/- 1.708	33.500	+/- 6.245	42.500	+/- 3.000	25.750	+/- 1.500
Controls	206	41.112	+/- 5.133	27.137	+/- 5.592	35.716	+/- 5.963	40.337	+/- 5.360	27.132	+/- 5.752

Group	n	RCD		TAB		TBC		TCD	
		Mean	Std. Dev.	Mean	Std. Dev.	Mean	Std. Dev.	Mean	Std. Dev.
DH	48	36.375	+/- 4.743	82.500	+/- 10.219	46.688	+/- 7.675	71.917	+/- 9.027
Coeliacs	10	28.000	+/- 8.602	86.750	+/- 3.862	49.500	+/- 1.732	61.500	+/- 14.434
Controls	206	34.624	+/- 6.216	81.449	+/- 9.571	54.275	+/- 10.453	70.353	+/- 10.926

(b) Females

Group	n	LAB		LBC		LCD		RAB		RBC	
		Mean	Std. Dev.	Mean	Std. Dev.	Mean	Std. Dev.	Mean	Std. Dev.	Mean	Std. Dev.
DH	28	42.571	+/- 4.158	30.593	+/- 4.750	35.481	+/- 4.619	41.536	+/- 4.032	29.815	+/- 5.643
Coeliacs	26	39.714	+/- 3.173	21.214	+/- 9.994	29.143	+/- 13.375	37.786	+/- 6.129	25.143	+/- 8.787
Controls	203	41.926	+/- 5.603	26.271	+/- 6.661	34.663	+/- 7.331	40.793	+/- 5.873	26.465	+/- 6.055

Group	n	RCD		TAB		TBC		TCD	
		Mean	Std. Dev.	Mean	Std. Dev.	Mean	Std. Dev.	Mean	Std. Dev.
DH	28	35.074	+/- 6.201	84.107	+/- 7.871	60.407	+/- 9.565	70.556	+/- 9.300
Coeliacs	26	31.500	+/- 10.718	77.500	+/- 8.654	46.357	+/- 17.145	60.643	+/- 21.936
Controls	203	33.585	+/- 6.315	82.719	+/- 10.671	52.789	+/- 11.595	68.231	+/- 11.959

Table 8.134 - Probabilities from Mann-Whitney U Tests

(a) MALES

VARIABLE	CONT : DH	CONT:COEL	DH : COEL
LAB	0.1070	0.0970	0.5579
LBC	0.0000**	0.1486	0.7046
LCD	0.6274	0.4596	0.5131
RAB	0.4925	0.3528	0.6044
RBC	0.0000**	0.4148	0.1960
RCD	0.0498*	0.0773	0.0389*

(b) FEMALES

VARIABLE	CONT : DH	CONT:COEL	DH : COEL
LAB	0.4532	0.0664	0.0310*
LBC	0.0001*	0.0445*	0.0004**
LCD	0.5987	0.1200	0.0848
RAB	0.3220	0.1498	0.0604
RBC	0.0110*	0.7087	0.0778
RCD	0.3741	0.7438	0.4005

Table 8.135 - Probabilities from Mann-Whitney U Tests

(a) MALES

VARIABLE	CONT : DH	CONT:COEL	DH : COEL
TAB	0.2801	0.1634	0.4189
TBC	0.0000**	0.2197	0.2210
TCD	0.2661	0.1640	0.1219

(b) FEMALES

VARIABLE	CONT : DH	CONT:COEL	DH : COEL
TAB	0.3140	0.0752	0.0274*
TBC	0.0005*	0.2137	0.0019**
TCD	0.5785	0.2298	0.1479

Table 8.136 - Canonical Discriminant Functions - Males: LAB to TCD

FUNCTION	EIGENVALUE	PERCENT OF VARIANCE	CUMULATIVE PERCENT	CANONICAL CORRELATION
1*	0.16489	64.53	64.53	0.3762343
2*	0.07756	30.35	94.98	0.2682902
3*	0.01307	5.12	100.00	0.1136021

Table 8.137 - Structure Matrix

	FUNC 1	FUNC 2	FUNC 3
TBC	0.75013*	0.16570	0.53407
RBC	0.69123*	0.02687	0.63357
LBC	0.67801*	0.33380	0.33776
LBD	0.43606*	0.40136	0.15828
TCD	-0.16569	0.43866*	0.24895
LAB	-0.12053	-0.42512*	0.23324
TAB	-0.09147	0.33803*	0.22394
LCD	0.01073	0.27089*	0.07712
RAB	-0.04846	-0.19909*	0.17956
RBD	0.25108	0.29597	0.69511*
RAC	0.38821	0.08925	0.59188*
RCD	-0.32195	0.53013	0.54942*
LAC	0.34164	0.08159	0.37404*

Table 8.138 - F Statistics and significances between groups

GROUP	GROUP 1	GROUP 2	GROUP 3
2	8.1335 0.0000		
3	2.2972 0.0458	2.9219 0.0139	
4	2.3099 0.0447	3.1309 0.0093	0.71544 0.6124

Code Group
 1 Controls
 2 DM
 3 Coeliac
 4 Coeliac unaffected relative

Figure 8.30 - Territorial Map - Males: LAB to TCD

Code	Group
1	Controls
2	DH
3	Coelinae
4	Coeliac unaffected relative

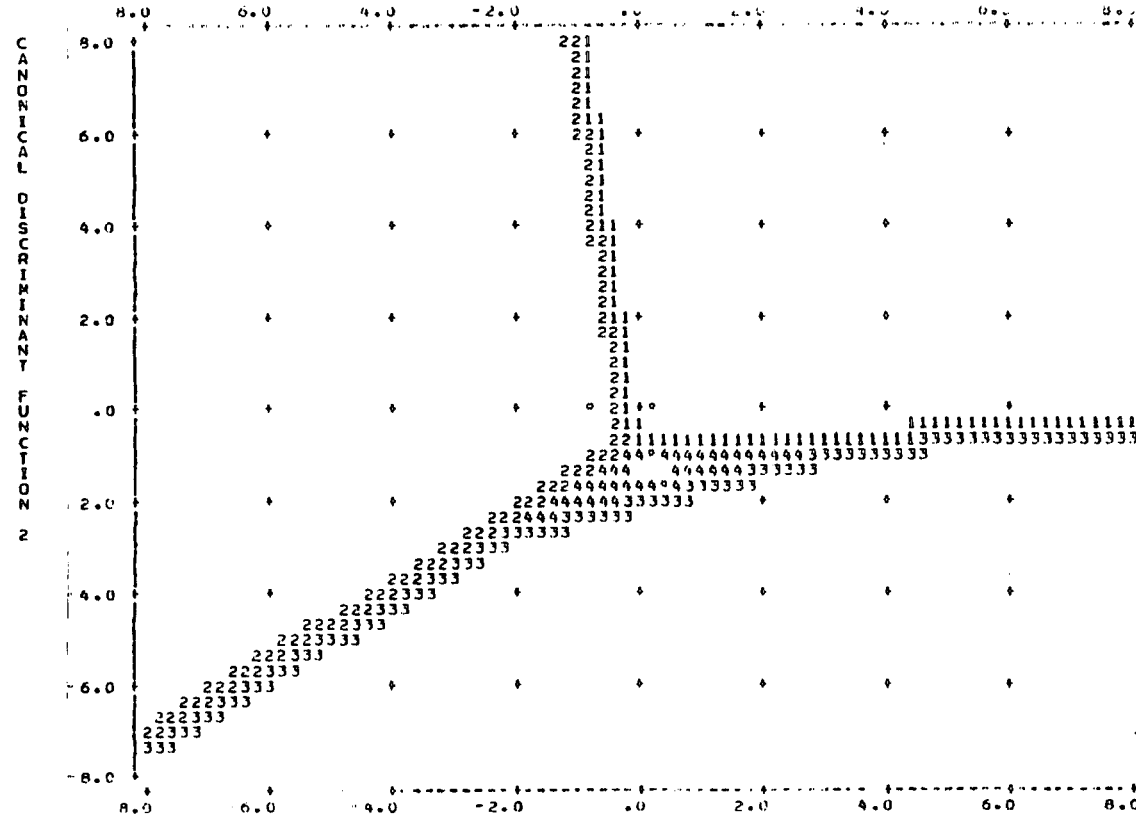

Table 8.139 - Males: LAB to TCD

CLASSIFICATION RESULTS

ACTUAL GROUP	NO. OF CASES	PREDICTED GROUP MEMBERSHIP			
		1	2	3	4
GROUP 1	199	96 48.2%	52 26.1%	14 7.0%	37 18.6%
GROUP 2	48	10 20.8%	26 54.2%	5 10.4%	7 14.6%
GROUP 3	4	0 0.0%	1 25.0%	2 50.0%	1 25.0%
GROUP 4	7	0 0.0%	1 14.3%	2 28.6%	4 57.1%

PERCENT OF "GROUPED" CASES CORRECTLY CLASSIFIED: 49.61%

Table 8.140 - Canonical Discriminant Functions - Females: LAB to TCD

FUNCTION	EIGENVALUE	PERCENT OF VARIANCE	CUMULATIVE PERCENT	CANONICAL CORRELATION
1*	0.12429	56.23	56.23	0.3324898
2*	0.05700	25.79	82.01	0.2322146
3*	0.03976	17.99	100.00	0.1955386

Table 8.141 - Structure Matrix

	FUNC 1	FUNC 2	FUNC 3
LAC	0.81732*	0.41798	0.02705
LBC	0.68039*	0.53762	0.41522
TBC	0.55360*	0.51678	0.49417
LCD	0.49118*	0.30738	-0.38703
RAC	0.46492*	0.25301	0.30935
RAB	0.39299*	0.00796	0.00553
TAB	0.38343*	0.19921	-0.17954
TCD	0.37341*	0.35465	-0.16432
LBD	0.49994	0.69809*	0.04937
RBD	0.27819	0.50878*	0.41105
LAB	0.31540	0.37697*	-0.35355
RCD	0.14090	0.31633*	0.13402
RBC	0.31628	0.40152	0.49170*

Table 8.142 - F Statistics and significances between groups

GROUP	GROUP 1	GROUP 2	GROUP 3
2	2.0388 0.0614		
3	4.4765 0.0003	4.5589 0.0002	
4	1.9090 0.0802	2.1536 0.0483	2.6545 0.0165

Code	Group
1	Controls
2	DM
3	Celiac
4	Celiac unaffected relatives

Figure 8.31 - Territorial Map - Females: LAB to ICD

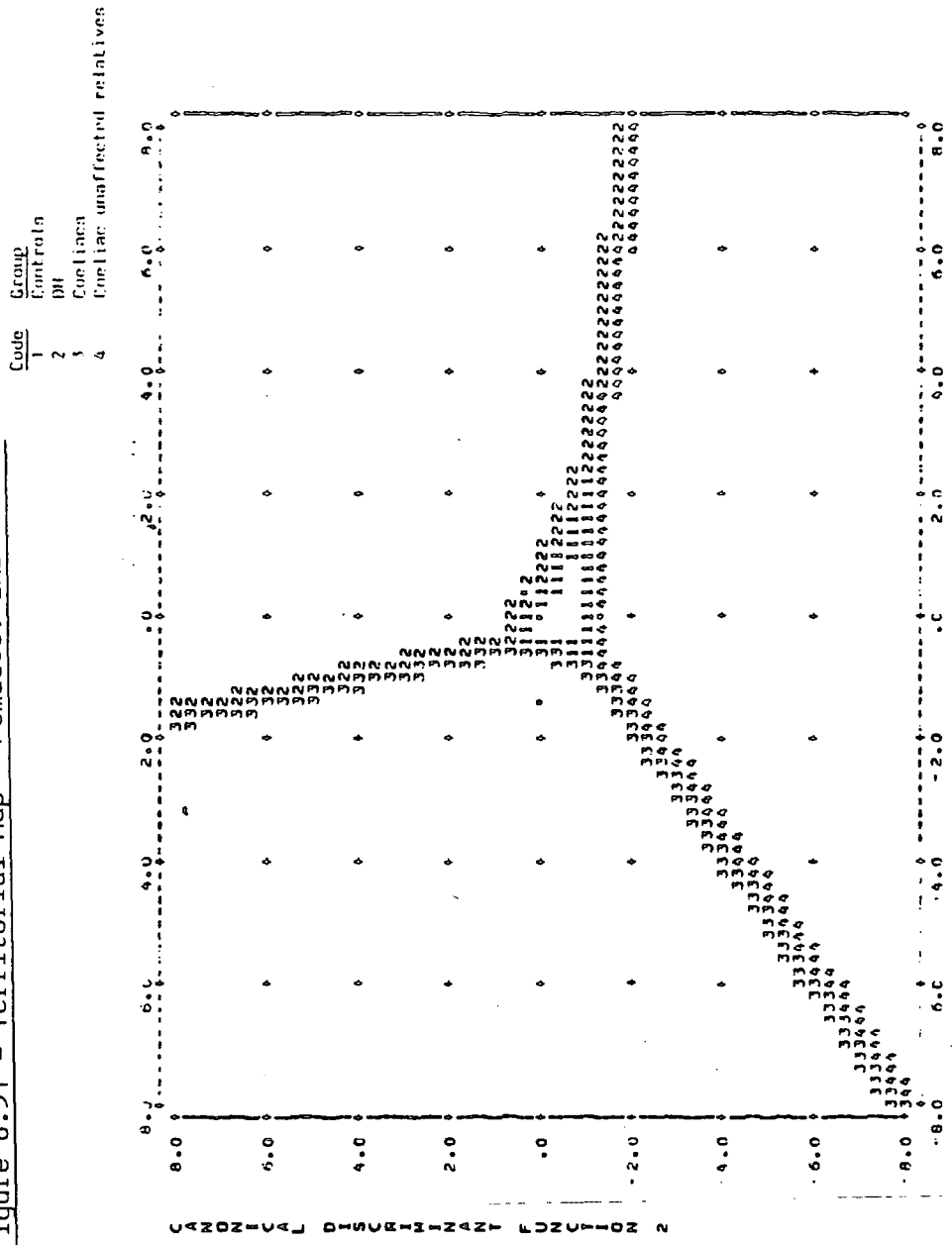

Table 8.143 - Females: LAB to TCD

CLASSIFICATION RESULTS

ACTUAL GROUP	NO. OF CASES	PREDICTED GROUP MEMBERSHIP			
		1	2	3	4
GROUP 1	198	85 42.9%	57 28.8%	18 9.1%	38 19.2%
GROUP 2	27	6 22.2%	19 70.4%	2 7.4%	0 0.0%
GROUP 3	14	4 28.6%	3 21.4%	6 42.9%	1 7.1%
GROUP 4	4	0 0.0%	0 0.0%	0 0.0%	4 100.0%

PERCENT OF "GROUPED" CASES CORRECTLY CLASSIFIED: 46.91%

(ii) Summed Total Palmar Ridge Counts - Variables: RPRC, LPRC and TPRC

Female DH subjects were found to have highly significantly higher summed total counts on both hands individually and combined in comparison to controls. Female Coeliac subjects were found to have a significantly lower LPRC in comparison to control females. Male DH patients were found to have a significantly higher LPRC count when compared to controls (Tables 8.144 and 8.145).

Table 8.144

Means and Standard Deviations

Summed Total Counts

(a) Males

Group	n	RPRC		LPRC		TPRC	
		Mean	Std. Dev.	Mean	Std. Dev.	Mean	Std. Dev.
DH	48	159.896	+/- 16.250	159.792	+/- 17.498	319.688	+/- 30.413
Coeliacs	10	150.000	+/- 18.037	158.750	+/- 12.816	308.750	+/- 29.398
Controls	206	163.917	+/- 20.637	166.819	+/- 20.060	330.775	+/- 38.564

(b) Females

Group	n	RPRC		LPRC		TPRC	
		Mean	Std. Dev.	Mean	Std. Dev.	Mean	Std. Dev.
DH	28	171.407	+/- 13.340	174.825	+/- 11.519	346.222	+/- 22.483
Coeliacs	26	153.143	+/- 26.317	146.143	+/- 32.153	299.286	+/- 54.183
Controls	203	161.270	+/- 21.136	164.392	+/- 23.309	325.799	+/- 41.600

Table 8.145 - Probabilities from Mann-Whitney U Tests

(a) MALES

VARIABLE	CONT : DH	CONT:COEL	DH : COEL
RPRC	0.1079	0.1397	0.2224
LPRC	0.0148*	0.3472	0.8367
TPRC	0.0522	0.1971	0.4097

(b) FEMALES

VARIABLE	CONT : DH	CONT:COEL	DH : COEL
RPRC	0.0052**	0.3347	0.0093**
LPRC	0.0053**	0.0176*	0.0004**
TPRC	0.0028**	0.0580	0.0005**

(iii) Factor Analysis using variables: LAB to TPRC

Male DH patients were subjected to Factor Analysis for the palmar ridge count variables. Four factors were produced with Factor 1 accounting for 55.4% of the variance and Factor 2 for another 19.1% (Table 8.146). The Rotated Factor Matrix shows that the three a-b ridge counts along with LAC make up Factor 1. Factor 2 is composed of the three c-d ridge counts plus TPRC and LPRC (Table 8.147). The variable plot (Figure 8.32) shows the relationships of the variables with the Factors.

Three factors were extracted for DH females using principal components analysis with Factor 1 accounting for 41.4% of the variance and Factor 2 for 27.0% (Table 8.148). The rotated factor matrix (Table 8.149) shows seven variables making up Factor 1 and six composing Factor 2. The b-c ridge counts and a-c counts are prominent in Factor 1.

Table 8.146 - Principal Components Analysis - DH Males: LAB to TPRC

FACTOR	EIGENVALUE	PCT OF VAR	CUM PCT
1	8.86337	55.4	55.4
2	3.06014	19.1	74.5
3	2.05992	12.9	87.4
4	1.13404	7.1	94.5

Table 8.147

ROTATED FACTOR MATRIX:

	FACTOR 1	FACTOR 2	FACTOR 3	FACTOR 4
TAB	.97658	.18909	.06963	.00343
LAB	.93144	.14393	-.15726	-.03002
RAB	.86851	.20723	.30184	.03876
LAC	.78072	.11540	.16932	.48872
TCD	.24334	.96093	.07396	.10073
RCD	-.04346	.87908	.28198	-.07974
LCD	.42003	.78750	-.11708	.22507
TPRC	.47278	.64940	.46980	.36555
LPRC	.56846	.59275	.10970	.55208
RBC	.01883	.01202	.91345	.22924
TBC	-.00204	.02812	.79496	.60429
RBD	-.01243	.60201	.78209	.08972
RPRC	.27274	.57714	.76114	.08967
RAC	.61490	.13337	.73409	.16113
LBC	-.02251	.06137	.47511	.82877
LBD	.30940	.64099	.18940	.66015

Figure 8.32 - Variable Plot - DH Males: LAB to TPRC

HORIZONTAL FACTOR 1 VERTICAL FACTOR 2

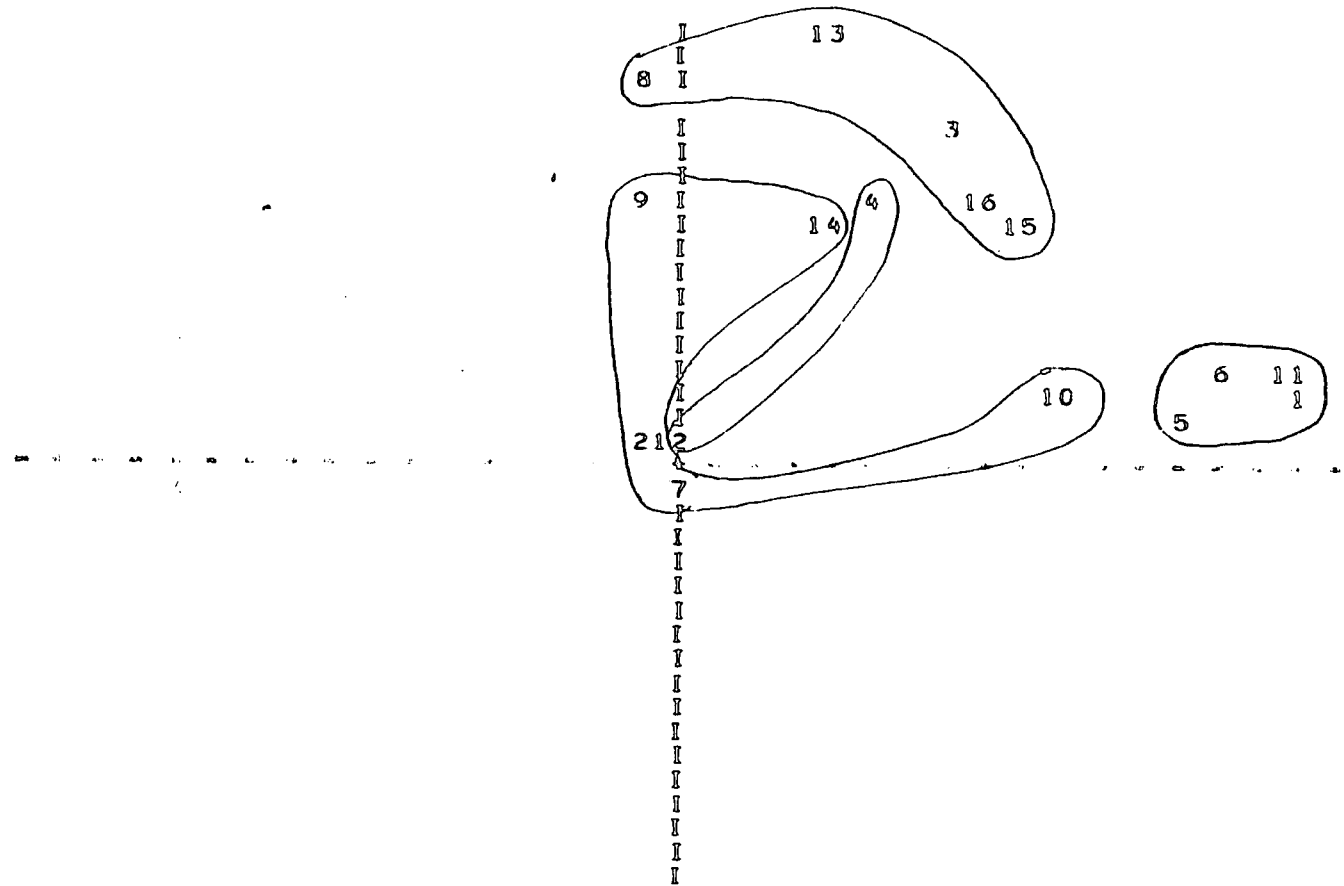

SYMBOL	VARIABLE	COORDINATES	SYMBOL	VARIABLE	COORDINATES	SYMBOL	VARIABLE	COORDINATES
1	LAB	(.93144, .14393)	2	LBC	(-.02251, .06137)	3	LCD	(.42003, .78750)
4	LBD	(.30940, .64099)	5	LAC	(.78072, .11540)	6	RAB	(.86851, .20723)
7	RBC	(.01883, -.01202)	8	RCD	(.04346, .87908)	9	RBD	(.01243, .60201)
10	RAC	(.61490, .13337)	11	TAB	(.97658, .18909)	12	TBC	(.00204, .02812)
13	TCD	(.24334, .96093)	14	RPRC	(.27274, .57714)	15	LPRC	(.56846, .59275)
16	TPRC	(.47278, .64940)						

Table 8.148 - Principal Components Analysis - DH Females: LAB to TPRC

FACTOR	EIGENVALUE	PCT OF VAR	CUM PCT
1	6.62622	41.4	41.4
2	4.31761	27.0	68.4
3	3.39790	21.2	89.6

Table 8.149

ROTATED FACTOR MATRIX:

	FACTOR 1	FACTOR 2	FACTOR 3
TBC	.99101	.03391	.07853
RBC	.91515	.04707	-.14370
LBC	.90827	.12422	.01260
RAC	.77854	.04438	.50018
LPRC	.75431	.52546	.11624
LBD	.72816	.52355	.23375
LAC	.67607	.12030	.66528
TCD	-.25775	.95831	-.09846
RCD	-.37861	.84753	.08275
RPRC	.38733	.82799	.24240
RBD	.42015	.82356	-.04442
LCD	-.01066	.79156	.30934
TPRC	.61628	.76048	.20338
TAB	.03860	.00977	.99377
LAB	.03798	.01897	.96930
RAB	-.11450	.00052	.93906

Figure 8.33 - Variable Plot - DH Females

HORIZONTAL FACTOR 1 VERTICAL FACTOR 2

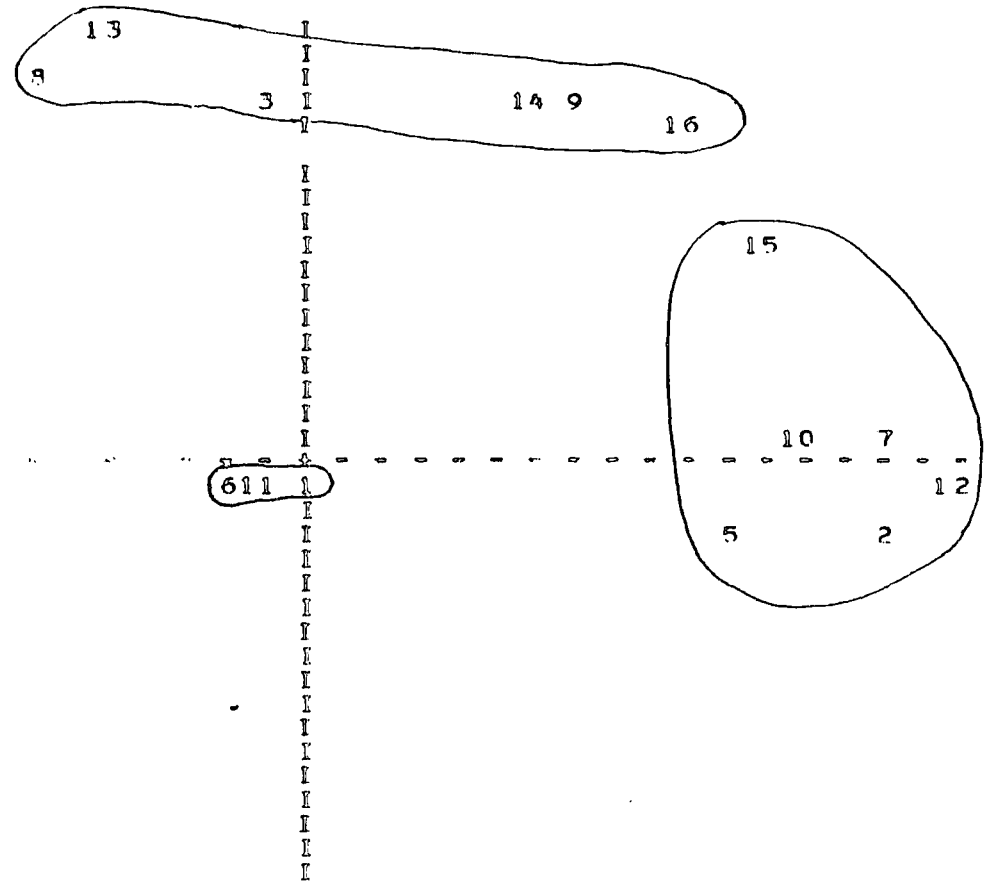

SYMBOL	VARIABLE	COORDINATES	SYMBOL	VARIABLE	COORDINATES	SYMBOL	VARIABLE	COORDINATES
1	LAB	(.03798, -.01897)	2	LBC	(.90827, .12422)	3	LCD	(.01066, .79156)
4	LBD	(.72816, .52355)	5	LAC	(.67607, .12030)	6	RAB	(.11450, .00052)
7	RBC	(.91515, .04707)	8	RCD	(.37861, .84753)	9	RBD	(.42015, .82356)
10	RAC	(.77854, .04438)	11	TAB	(.03860, .00977)	12	TBC	(.99101, .03391)
13	TCD	(.25775, .95831)	14	RPRC	(.38733, .82799)	15	LPRC	(.75431, .52546)
16	TPRC	(.61628, .76048)						

(g) Palmar Mainline Directions - Variables: ARL to DUR

No significant differences were found for intergroup comparisons for either male or female subjects for this set of variable (Tables 8.150 to 8.152).

Table 8.150

Percentage Frequencies

Mainlines : Males

(a) Left Hand

Group	n	ARL		AUL		BRL		BUL		CRL		CUL		DRL		DUL	
		0	1	0	1	0	1	0	1	0	1	0	1	0	1	0	1
DH	48	100.0	0.0	0.0	100.0	100.0	0.0	0.0	100.0	39.6	60.4	60.4	39.6	0.0	100.0	100.0	0.0
Codiacs	10	100.0	0.0	0.0	100.0	100.0	0.0	0.0	100.0	75.0	25.0	25.0	75.0	0.0	100.0	100.0	0.0
Contrds	206	100.0	0.0	0.0	100.0	100.0	0.0	0.0	100.0	47.1	52.9	53.2	46.8	0.5	99.5	99.5	0.5

(B) Right Hand

Group	n	ARR		AUR		BRR		BUR		CRR		CUR		DRR		DUR	
		0	1	0	1	0	1	0	1	0	1	0	1	0	1	0	1
DH	48	100.0	0.0	0.0	100.0	100.0	0.0	0.0	100.0	25.0	75.0	75.0	25.0	0.0	100.0	100.0	0.0
Codiacs	10	100.0	0.0	0.0	100.0	100.0	0.0	0.0	100.0	50.0	50.0	50.0	50.0	0.0	100.0	100.0	0.0
Contrds	206	100.0	0.0	0.0	100.0	100.0	0.0	0.0	100.0	38.0	62.0	62.1	37.9	0.5	99.5	99.5	0.5

Table 8.151

Percentage Frequencies

Mainlines : Females

(a) Left Hand

Group	n	ARL		AUL		BRL		BUL		CRL		CUL		DRL		DUL	
		0	1	0	1	0	1	0	1	0	1	0	1	0	1	0	1
DH	28	100.0	0.0	0.0	100.0	100.0	0.0	0.0	100.0	35.7	64.3	67.9	32.1	0.0	100.0	100.0	0.0
Codiacs	26	100.0	0.0	0.0	100.0	100.0	0.0	0.0	100.0	57.1	42.9	57.1	42.9	0.0	100.0	100.0	0.0
Contr ds	203	100.0	0.0	0.0	100.0	100.0	0.0	0.0	100.0	52.7	47.3	51.0	49.0	0.5	99.5	99.5	0.5

(B) Right Hand

Group	n	ARR		AUR		BRR		BUR		CRR		CUR		DRR		DUR	
		0	1	0	1	0	1	0	1	0	1	0	1	0	1	0	1
DH	28	100.0	0.0	0.0	100.0	100.0	0.0	0.0	100.0	46.4	53.6	57.1	42.9	0.0	100.0	100.0	0.0
Codiacs	26	100.0	0.0	0.0	100.0	100.0	0.0	0.0	100.0	35.7	64.3	71.4	28.6	0.0	100.0	100.0	0.0
Contr ds	203	100.0	0.0	0.0	100.0	100.0	0.0	0.0	100.0	42.9	57.1	60.1	39.9	0.5	99.5	99.5	0.5

Table 8.152 - Probabilities from Mann-Whitney U Tests

(a) MALES

VARIABLE	CONT : DH	CONT:COEL	DH : COEL
ARL	1.0000	1.0000	1.0000
AUL	1.0000	1.0000	1.0000
BRL	1.0000	1.0000	1.0000
BUL	1.0000	1.0000	1.0000
CRL	0.3505	0.2644	0.1725
CUL	0.3651	0.2604	0.1725
DRL	0.6285	0.8886	1.0000
DUL	0.6285	0.8886	1.0000
ARR	1.0000	1.0000	1.0000
AUR	1.0000	1.0000	1.0000
BRR	1.0000	1.0000	1.0000
BUR	1.0000	1.0000	1.0000
CRR	0.0898	0.6178	0.2835
CUR	0.1016	0.6029	0.2835
DRR	0.6285	0.8886	1.0000
DUR	0.6285	0.8886	1.0000

(b) FEMALES

ARL	1.0000	1.0000	1.0000
AUL	1.0000	1.0000	1.0000
BRL	1.0000	1.0000	1.0000
BUL	1.0000	1.0000	1.0000
CRL	0.0925	0.7484	0.1912
CUL	0.0945	0.6568	0.4997
DRL	0.7103	0.7928	1.0000
DUL	0.7103	0.7928	1.0000
ARR	1.0000	1.0000	1.0000
AUR	1.0000	1.0000	1.0000
BRR	1.0000	1.0000	1.0000
BUR	1.0000	1.0000	1.0000
CRR	0.7213	0.6018	0.5134
CUR	0.7655	0.4020	0.3746
DRR	0.7103	0.7928	1.0000
DUR	0.7103	0.7928	1.0000

(h) Palmar Flexion Creases

(i) Transverse Flexion Crease - Variables: FCL and FCR

From Tables 8.153 and 8.154 it can be seen that Coeliac male subjects were found to have a highly significantly greater occurrence of Transverse Flexion Crease Variant 5, i.e. Sydney Lines, in comparison to both control and DH male subjects on both hands. No other statistically significant differences were found for these variables.

Table 8.153

Percentage Frequencies

Flexion Creases

(a) Males

Group	n	FCL							FCR						
		0	1	2	3	4	5	6	0	1	2	3	4	5	6
CH	48	100.0	0.0	0.0	0.0	0.0	0.0	0.0	100.0	0.0	0.0	0.0	0.0	0.0	0.0
Coeliacs	206	75.0	0.0	0.0	0.0	0.0	25.0	0.0	75.0	0.0	0.0	0.0	0.0	25.0	0.0
Controls	206	100.0	0.0	0.0	0.0	0.0	0.0	0.0	98.5	0.0	0.0	1.0	0.5	0.0	0.0

(b) Females

Group	n	FCL							FCR						
		0	1	2	3	4	5	6	0	1	2	3	4	5	6
DH	28	100.0	0.0	0.0	0.0	0.0	0.0	0.0	100.0	0.0	0.0	0.0	0.0	0.0	0.0
Coeliacs	26	100.0	0.0	0.0	0.0	0.0	0.0	0.0	92.9	0.0	0.0	7.1	0.0	0.0	0.0
Controls	203	98.0	0.0	0.0	1.0	1.0	0.0	0.0	98.5	0.0	0.0	1.0	0.0	0.5	0.0

Table 8.154 - Probabilities from Mann-Whitney U Tests

(a) MALES

VARIBLAE	CONT : DH	CONT:COEL	DH : COEL
FCL	0.2742	0.0064**	0.0005**
FCR	0.3989	0.0006**	0.0005**

(b) FEMALES

FCL	0.4547	0.5969	1.0000
FCR	0.5172	0.1322	0.1573

(ii) Thenar Flexion Creases - Variables: TCVL to TCTR

DH male subjects were found to have a significantly higher frequency of occurrence of Thenar Flexion Crease variants 2, 3, 4 and 5 in comparison to control males on the left hand. These variants are forked, broken, short and cascade lines. The first two i.e. forked and broken show the greatest differences (see Tables 8.155 and 8.156). No other significant differences were found for intergroup comparisons of male subjects.

Female Coeliacs were found to have a significantly greater occurrence of forked and cascade creases and significantly lower occurrence of broken and short lines in comparison to controls on the right hand. DH females were found to have a significantly greater occurrence of Thenar Crease Terminus 2, i.e radial terminus, in comparison to both controls and Coeliacs on the left hand (Tables 8.155b and 8.156b).

Table 8.155

Percentage Frequencies

Thenar Flexion Creases

(a) Males : Left Hand

Group	n	TCVL						TCTL	
		0	1	2	3	4	5	1	2
DH	48	16.7	0.0	62.5	6.3	6.3	6.3	91.7	8.3
Coeliacs	10	25.0	0.0	75.0	0.0	0.0	0.0	100.0	0.0
Controls	206	35.4	0.0	49.5	4.4	5.3	5.3	91.3	8.7

(b) Males : Right Hand

Group	n	TCVR						TCTR	
		0	1	2	3	4	5	1	2
DH	48	22.9	0.0	56.3	4.2	4.2	12.5	93.8	6.3
Coeliacs	10	25.0	0.0	50.0	0.0	0.0	25.0	75.0	25.0
Controls	206	38.3	0.5	42.7	3.9	7.8	6.8	91.3	8.7

(c) Females : Left Hand

Group	n	TCVL						TCTL	
		0	1	2	3	4	5	1	2
DH	28	10.7	0.0	67.9	3.6	3.6	14.3	64.3	35.7
Coeliacs	26	14.3	0.0	42.4	7.1	7.1	28.0	92.9	7.1
Controls	203	27.6	0.0	48.3	5.9	9.9	8.4	82.8	17.2

(d) Females : Right Hand

Group	n	TCVR						TCTR	
		0	1	2	3	4	5	1	2
DH	28	7.1	0.0	71.4	3.6	3.6	14.3	67.9	32.1
Coeliacs	26	7.1	0.0	50.0	0.0	7.1	35.7	92.9	7.1
Controls	203	27.6	0.0	48.8	3.9	11.3	8.4	82.3	17.7

Table 8.156 - Probabilities from Mann-Whitney U Tests

(a) MALES

VARIABLE	CONT : DH	CONT:COEL	DH : COEL
TCVL	0.0191*	0.9927	0.3581
TCTL	0.9286	0.5352	0.5518
TCVR	0.0802	0.4928	0.8939
TCTR	0.5737	0.2672	0.1806

(b) FEMALES

TCVL	0.2513	0.0735	0.3339
TCTL	0.0210*	0.3270	0.0498*
TCVR	0.1531	0.0196*	0.1828
TCTR	0.0717	0.3092	0.0764

(i) Palmar Ridge Disturbances

(i) Ridge Atrophy - Variables: ATRL and ATRR

DH subjects of both sexes were found to have a highly significantly greater occurrence of palmar ridge atrophy on both hands in comparison to controls. Coeliac subjects of both sexes were found to have a significantly greater occurrence of ridge atrophy on both hands when compared to controls (Tables 8.157 and 8.158).

Table 8.157

Percentage frequencies

Palmar Ridge Disturbances

(a) Males

Group	n	HYLP				HYRP				ATRL				ATTR			
		0	1	2	3	0	1	2	3	0	1	2	3	0	1	2	3
DH	48	22.9	27.1	31.3	18.8	16.7	39.6	22.9	20.8	60.4	25.0	12.5	2.1	54.2	31.3	12.5	2.1
Coeliacs	10	0.0	25.0	50.0	25.0	25.0	0.0	25.0	50.0	50.0	25.0	25.0	0.0	50.0	50.0	0.0	0.0
Controls	206	57.3	21.4	16.5	4.9	59.7	21.8	15.0	3.4	87.9	11.2	1.0	0.0	89.3	8.3	2.4	0.0

(b) Females

Group	n	HYLP				HYRP				ATRL				ATTR			
		0	1	2	3	0	1	2	3	0	1	2	3	0	1	2	3
DH	28	10.7	25.0	35.7	28.6	10.7	21.4	42.9	25.0	46.4	21.4	25.0	7.1	39.3	32.1	21.4	7.1
Coeliacs	26	21.4	14.3	21.4	42.9	21.4	14.3	14.3	50.0	64.3	7.1	14.3	14.3	57.1	21.4	7.1	14.3
Controls	203	31.5	32.0	27.1	9.4	33.2	29.2	31.2	6.4	79.8	17.7	2.0	0.5	79.3	18.2	2.5	0.0

Table 8.158 - Probabilities from Mann-Whitney U Tests

(a) MALES

VARIABLE	CONT : DH	CONT:COEL	DH : COEL
ATRL	0.0000**	0.0179*	0.6387
ATTR	0.0000**	0.0189*	0.9087

(b) FEMALES

ATRL	0.0000**	0.0498*	0.5128
ATTR	0.0000**	0.0249*	0.4173

(ii) Hyperlinearity - Variables: HYLP and HYRP

DH subjects, both male and females, were found to have highly significantly greater occurrence of hyperlinearity in comparison to controls. Coeliac subjects of both sexes were found to have a significantly greater occurrence of hyperlinearity in comparison to controls (Highly significant for HYP in males and HYRP in females)-see Tables 8.157 and 81.59.

Table 8.159 - Probabilities from Mann-Whitney U Tests

(a) MALES

VARIABLE	CONT : DH	CONT:COEL	DH : COEL
HYLP	0.0000**	0.0078**	0.3186
HYRP	0.0000**	0.0253*	0.3432

(b) FEMALES

HYLP	0.0011**	0.0222*	0.7704
HYRP	0.0004**	0.0093**	0.5398

8.3 Incontinentia pigmenti

Twelve female subjects, drawn from five unrelated families, were printed and their prints were examined. Ten of the subjects were Incontinentia pigmenti sufferers. The other two were an unaffected daughter (Patient 4) and mother (Patient 8) from different families. The relationships between the subjects printed are shown in Figure 8.34.

Figure 8.34 - Relationships of subjects in Incontinentia Pigmenti (IP) study

(Age of subjects in brackets)

Family A

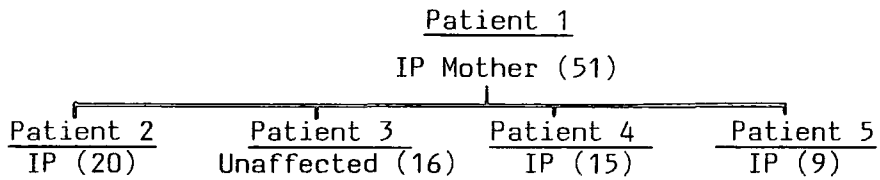

Family B

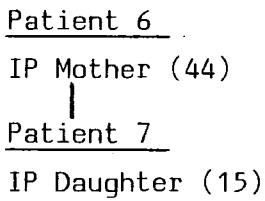

Family C

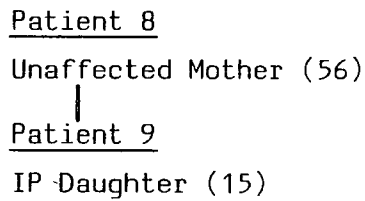

Family D

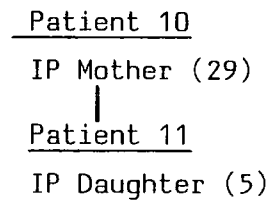

Family E: Patient 12 - IP Female (22)

In addition a male subject (Patient 13) who suffered from Incontinentia Pigmenti Achromians (Hypomelanosis of Ito) was printed. This is a rare genodermatosis which may be related to IP.

When the prints were analysed significant differences were found between IP patients and control females for only the variables shown in Tables 8.160 to 8.168. None of the values for the other variables were found to be statistically significantly different. IP females were found to have significantly smaller values in comparison to control females for each of the finger ridge counts shown in Table 8.160. Note that fingers II, III and IV were the most

important in these variables. Table 8.161 shows that 2 ulnar loop scores showed significant differences, both were on the left hand on fingers II and III.

Atrophy of the epidermal ridges on the fingers of both hands was found to be significantly greater in IP females in comparison to control females (Table 8.162). IP females were found to have significantly greater values for hypothenar pattern indices in comparison to controls on both hands individually and combined. Control females were found to have significantly greater values for interdigital pattern intensity indices, on both hands and combined, in comparison to IP females (Table 8.163).

On the hypothenar area, IP subjects were found to have a highly significantly smaller occurrence of peripheral patterns on both hands in comparison to controls (Table 8.164).

Axial triradii counts on both hands individually and combined were found to be significantly greater in IP females compared to controls. The mean maximal atd angle was found to be significantly greater on the right hand and for both hands combined in IP females (Table 8.165). A significantly smaller occurrence of axial triradius in position t" of the right hand was found in controls compared to IP females (Table 8.166).

IP females were found to have significantly higher occurrence of Thenar Crease variants, other than normal, in comparison to controls on both hands. In IP females the only variants found were forked and cascade (Table 8.167).

Palmar hyperlinearity and atrophy were found to be highly significantly greater in IP subjects compared to controls (Table 8.168).

When IP female sufferers were compared to unaffected relatives four significant differences were found. The variables showing these differences were all concerned with finger III of the right hand (see Tables 8.169 and 8.170).

The male subjects with IP achromians showed increased hyperlinearity of the palms, plus white lines and atrophy of the epidermal ridges of the fingers.

Sweat pore counts were carried out on the IP sufferers using the method of O'Leary et al (1986). It was found that IP sufferers had a mean sweat pore count on the fingers of 5.6 ± 3.4 and

on the palms of 7.8 ± 6.5 . The two unaffected females (carriers) had a mean finger sweat pore count of 10.3 ± 6.2 and palmar count of 14.3 ± 6.8 . A group of twenty control subjects selected to match for age range were found to have finger sweat pore counts of 21.6 ± 4.8 and palmar sweat pore count of 23.1 ± 5.2 pores per cm.

Table 8.160 - Finger Ridge Counts

VARIABLE	IP Females Mean \pm Std.Dev. (n = 10)		Control Females Mean \pm Std.Dev. (n = 203)		M.W. U Tests Probability
		\pm		\pm	
LFR2	2.200	4.367	8.813	6.561	0.0051**
LFR3	4.400	4.993	11.591	5.405	0.0003**
RFR2	3.500	6.115	9.690	6.965	0.0154*
RFR3	8.000	4.899	11.315	5.538	0.0420*
RFR4	10.800	5.329	14.560	5.760	0.0134*
RF2	5.500	6.621	11.177	6.231	0.0094**
RF3	8.000	4.899	11.458	5.522	0.0338*
RF4	12.000	3.742	14.921	5.663	0.0172*
LF3	5.000	4.761	11.700	5.376	0.0005**
RFA3	8.000	4.899	12.542	7.452	0.0293*
LFA3	5.600	5.739	13.084	8.005	0.0022**
R2	5.700	9.298	18.502	11.791	0.0014**
R3	12.400	9.548	22.906	10.000	0.0021**
R4	23.100	9.134	29.217	10.055	0.0294*
RFR	49.900	21.445	65.064	20.733	0.0260*
LFR	43.900	18.752	62.768	20.098	0.0049**
TFR	93.800	37.806	127.833	38.994	0.0071**
F2	12.500	11.158	22.025	11.415	0.0147*
F3	13.000	9.499	23.158	10.106	0.0024**
AF2	15.900	18.009	27.852	18.928	0.0227*
AF3	13.600	10.352	25.626	14.247	0.0050**
LFRC	49.400	19.929	65.655	20.857	0.0153*
TFRC	102.500	42.477	132.897	40.446	0.0232*

Table 8.161 - Finger Ulnar Loop Scores

VARIABLE	Cat.	Percentage Frequencies		M.W. U Test Results
		IP FEM.	Cont.FEM	
LPU2	0	60.0	27.6	0.0280*
	1	40.0	72.4	
LPU3	0	50.0	5.4	0.0000**
	1	50.0	94.6	

Table 8.162 - Finger Ridge Atrophy

VARIABLE	Cat	Percentage Frequencies		M.W. U Test Probability
		IP FEM.	Cont.FEM.	
LA	0	50.0	84.2	0.0048**
	1	30.0	10.8	
	2	20.0	4.4	
	3	0.0	0.5	
RA	0	50.0	85.7	0.0042**
	1	40.0	8.4	
	2	10.0	5.9	
	3	0.0	0.0	

Table 8.163 - Palmar Pattern Intensity Indices

VARIABLE	Cat.	Percentage Frequencies		M.W. U Test Probability
		IP FEM.	Cont.FEM.	
HYPOR	0	20.0	66.5	0.0006**
	1	50.0	30.5	
	2	30.0	3.0	
HYPOL	0	20.0	66.6	0.0050**
	1	70.0	30.5	
	2	10.0	3.0	
HYPBH	0	20.0	54.2	0.0013**
	1	0.0	20.7	
	2	50.0	20.7	
	3	20.0	3.9	
	4	10.0	0.5	
INTOR	0	20.0	2.5	0.0096**
	1	80.0	71.9	
	2	0.0	20.7	
	3	0.0	3.9	
	4	0.0	1.0	
INTOL	0	30.0	3.0	0.0134*
	1	60.0	68.0	
	2	10.0	24.1	
	3	0.0	4.4	
	5	0.0	0.5	
INTBT	0	20.0	2.0	0.0071**
	1	10.0	1.5	
	2	60.0	60.1	
	3	10.0	17.2	
	4	0.0	13.3	
	5	0.0	2.5	
	6	0.0	3.0	
	7	0.0	0.5	
	9	0.0	0.5	

Table 8.164 - Peripheral Hypothenar Patterns

VARIABLE	Cat	Percentage Frequencies		M.W. U Test Probability
		IP FEM.	Cont.FEM.	
PHL	0	40.0	85.7	0.0002**
	1	60.0	13.8	
	2	0.0	0.5	
PHR	0	30.0	92.6	0.0000**
	1	70.0	6.9	
	2	0.0	0.5	

Table 8.165 - Palmar Triradii

VARIABLE	IP Females		Control Females		M.W. U Test Probability
	Mean \pm	S.D.	Mean \pm	S.D.	
AXR	2.100	0.738	1.360	0.530	0.0005**
AXL	1.900	0.568	1.399	0.539	0.0056**
TTAX	4.000	1.247	2.759	0.942	0.0013**
RATD	53.800	12.656	40.512	6.132	0.0002**
SATD	105.600	21.598	82.616	12.751	0.0002**

Table 8.166 - Axial Triradius

VARIABLE	Cat	Percentage Frequencies		M.W. U Test Probability
		IP FEM.	Cont.FEM.	
RTII	0	95.1	60.0	0.0000**
	1	4.9	40.0	

Table 8.167 - Thenar Flexion Crease Variants

VARIABLE	Cat	Percentage Frequencies		M.W. U Test Probability
		IP FEM.	Cont.FEM.	
TCVL	0	0.0	27.6	0.0262*
	2	60.0	48.3	
	3	0.0	5.9	
	4	0.0	9.9	
	5	40.0	8.4	
TCVR	0	0.0	27.6	0.0248*
	2	60.0	48.8	
	3	0.0	3.9	
	4	0.0	11.3	
	5	40.0	8.4	

Table 8.168 - Palmar Ridge Disturbances

VARIABLE	Cat	Percentage Frequencies		M.W. U Test Probability
		IP FEM.	Cont.FEM.	
HYLP	0	0.0	31.5	0.0002**
	1	10.0	32.0	
	2	40.0	27.1	
	3	50.0	9.4	
HYRP	0	0.0	33.2	0.0001**
	1	10.0	29.2	
	2	40.0	31.2	
	3	50.0	6.4	
ATRL	0	0.0	79.8	0.0000**
	1	60.0	17.7	
	2	30.0	2.0	
	3	10.0	0.5	
ATRR	0	30.0	79.3	0.0000**
	1	10.0	18.2	
	2	60.0	2.5	
	3	0.0	0.0	

Table 8.169

VARIABLE	Cat	Percentage Frequencies		M.W. U Test Probability
		IP FEM.	IP Rel.F.	
RP3	0	10.0	0.0	0.0303*
	2	90.0	0.0	
	5	0.0	50.0	
	8	0.0	50.0	
RPR3	0	100.0	0.0	0.0303*
	2	0.0	100.0	

Table 8.170

VARIABLE	IP Females		IP Rels. F.		M.W. U Test Probability
	Mean	± S.D.	Mean	± S.D.	
RFU3	0.000	0.000	5.500	4.950	0.0303*
RD3	1.800	1.265	6.500	2.121	0.0303*

8.4 Anhidrotic Ectodermal Dysplasia

A mother and son with AED were printed along with another unrelated child with AED. The most notable features in the mother and son were found to be intense hyperlinearity and atrophy of the ridges. The sweat pore counts were reduced and were zero on the hypothenar areas of both palms of both mother and son. On the fingers the mean sweat pore counts were very low 2.2 in the son and 3.6 in the mother and overall on the palms the scores were 1.7 and 2.8 respectively.

The other child's print showed extreme hyperlinearity and atrophy with low palms and finger count. 5.6 per cm on palms 6.2 on fingers. The occurrence of sweat pores was very patchy particularly on the palmar areas. No other significant differences in dermatoglyphic variables were found compared to controls or to IP subjects.

8.5 Darier's Disease

(i) Introduction

Seventy subjects with Darier's disease (32 males and 38 females), along with 31 first degree unaffected relatives of Darier's patients (18 males and 13 females), plus 19 Dariers undiagnosed children (11 males and 8 females) and 10 spouses of Dariers patients (7 males and 3 females) were printed and the data obtained was analysed. The majority of subjects were drawn from seven unrelated families. The family trees (Figure 8.35 a - g) show the subjects and their relationships within the specific family. Forty six subjects were printed from family A (Figure 8.35a). The subjects were obtained from four generations of the family.

Figure 8.35b shows the 22 subjects from four generations printed from family B. Family D consists of a Dariers mother and her husband plus their children, one Darier's male, two Darier's females and another daughter, one year of age as yet undiagnosed (Figure 8.35c). Only one male Dariers patient was printed from family E but his family relationships can be seen in Figure 8.35d. Family F had 16 of its members printed from these generations (Figure 8.35e). Sixteen members of family H were also printed. Again they came from three generations (Figure 8.35f). From family M seven members were printed from three generations. In addition to these two Dariers patients were printed from family G who were a second cousin and a son of a second cousin. Four other patients with proven history, from different unrelated families were printed. An unaffected mother and her Darier's daughter were printed from family X and eight other patients with Dariers disease but with no family history were printed.

In the family trees the following keys were used:-

- unaffected male
 - Darier's male
 - unaffected female
 - Darier's female
- 1-16 reference number of subject printed

In the sections following the results are presented only for comparisons where significant differences were found using Mann-Whitney U Test analysis. Discriminant analysis and Factor Analysis was carried out using sets of variables where significant intergroup differences were found. The codes for the groups in the tables and figures in the remainder of this chapter are:-

<u>GROUPS</u>	<u>CODES</u>
	<u>Charts</u>
Control subjects	= 1
Darriers subjects	= 2
Darier's unaffected 1st degree relative	= 3
Darier's children (undiagnosed)	= 4
Darriers spouse	= 5

Figure 8.35a - Darier's Family A: Gateshead

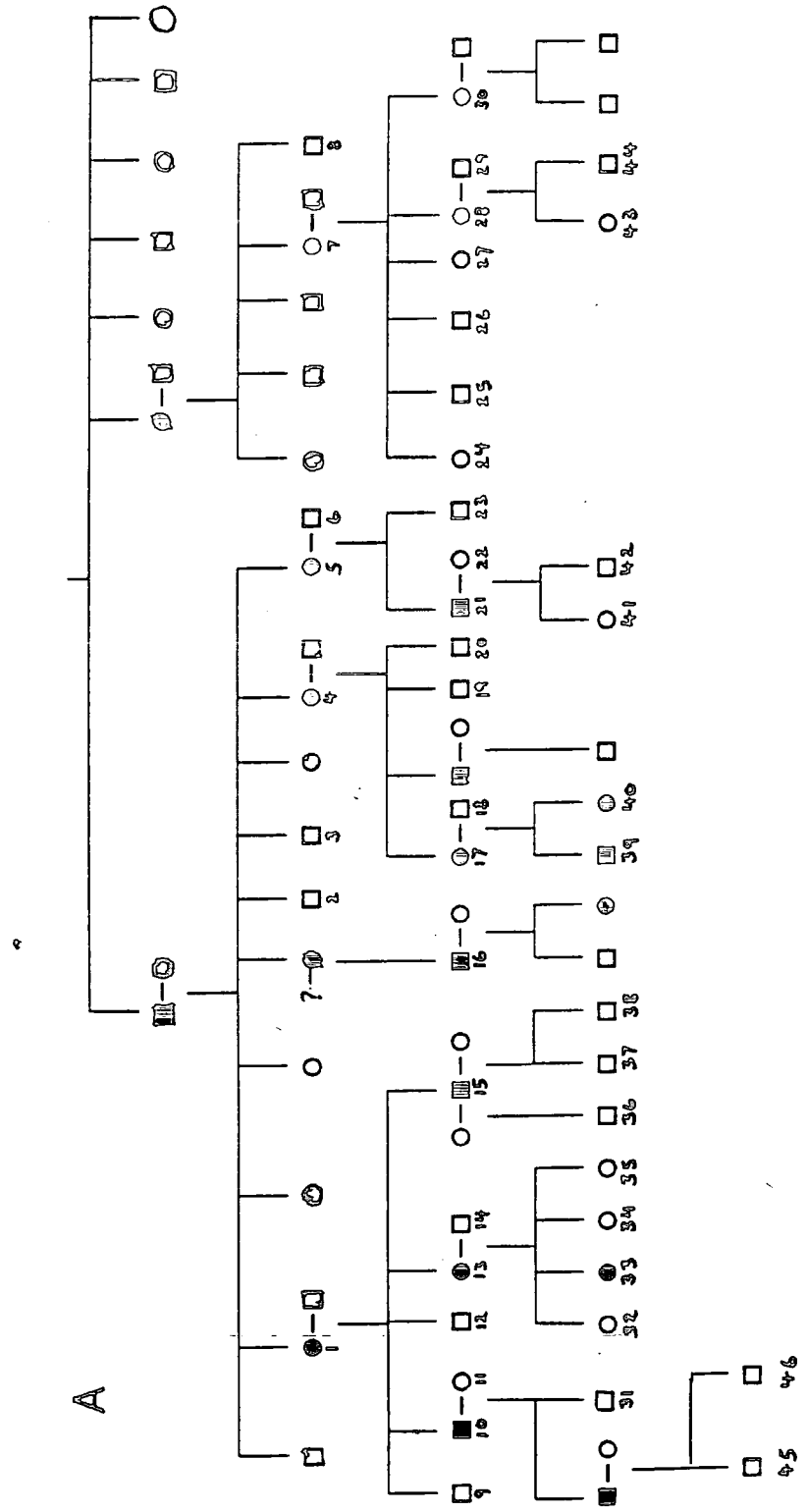

Figure 8.35e - Darriers family F: Middlesbrough

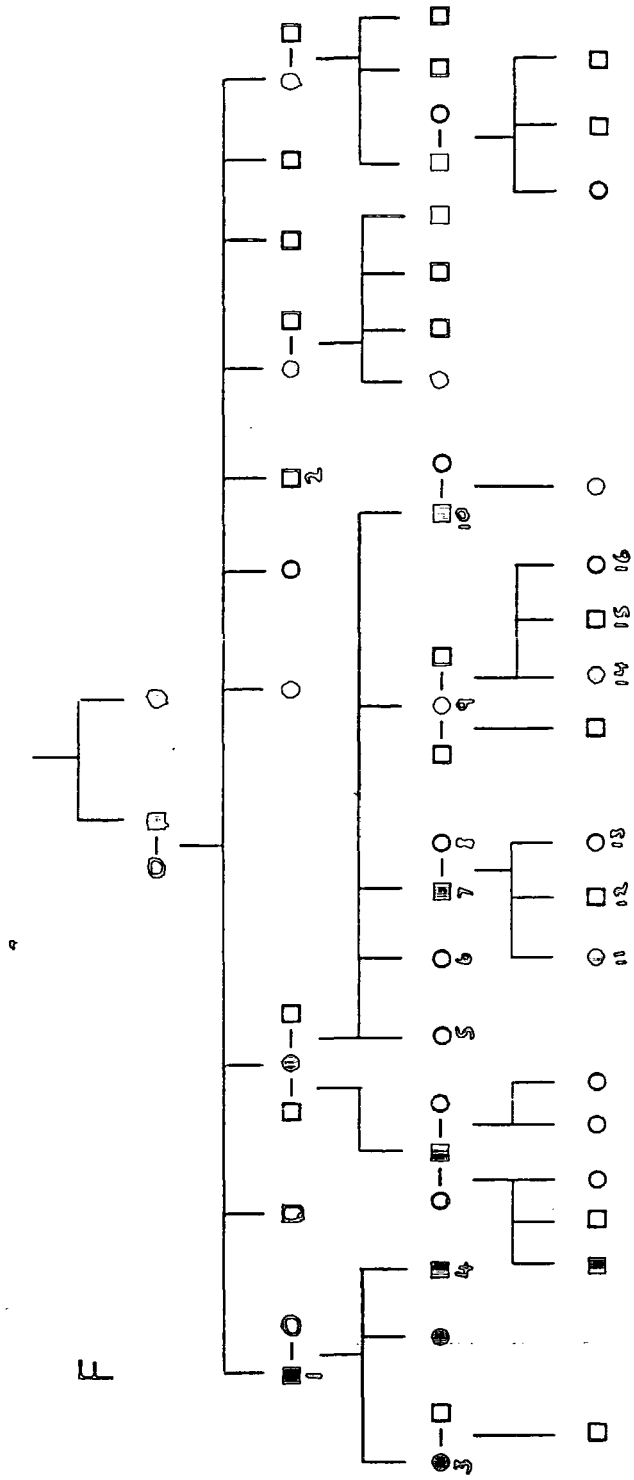

Figure 8.35f - Darriers family H: Darlington

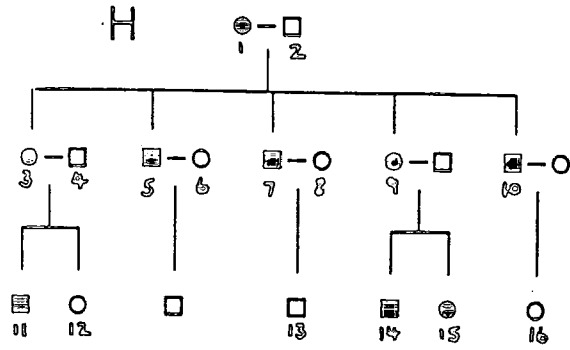
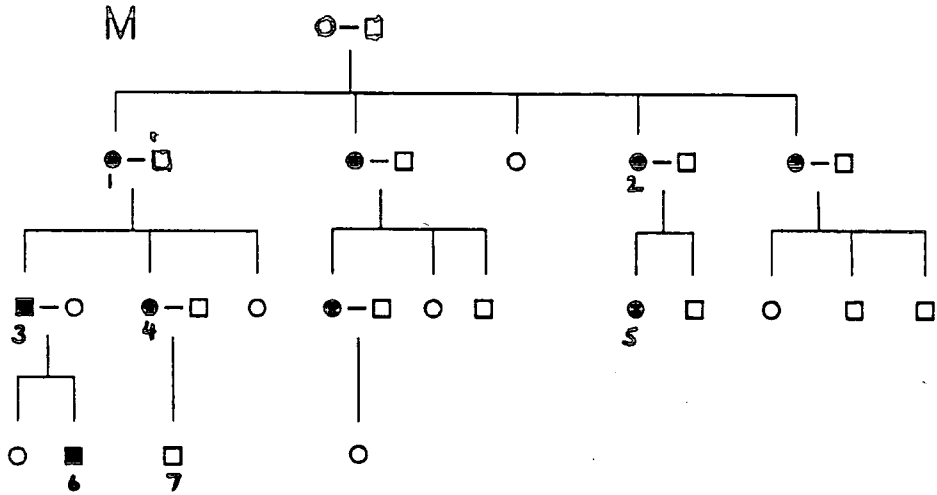

Figure 8.35g - Darriers family M: Eyemouth, Morpeth, Sunderland



(ii) Finger Ridge Counts

When male subjects with Darier's disease were compared to male controls five statistically significant differences were found for finger ridge count variables, as shown in Table 8.171a. Significantly lower radial counts were found on finger I of the left hand and fingers II and III of the right hand in Darier's male subjects in comparison to control males. Ulnar counts on finger III of the left hand and summed ulnar count for finger III of both hands combined were found to be significantly higher in Darier's males compared to control males. When compared to unaffected first degree male relatives, Darier's males were found to have significantly higher counts for four variable on the left hand i.e. LF3, LF4, LFA3 and LFAC (Table 8.172a).

Female Darier's patients were found to have a significantly higher radial count on finger III of the left hand in comparison to both control female subjects and unaffected first degree female relatives. Darier's females were also found to have significantly higher ulnar counts on fingers II and V of the left hand and finger IV of both hands when compared with female controls. Higher values for LFU were found in Darier's females in comparison to control and for TFU in comparison to both controls and first degree female relatives were also found (Tables 8.171b and 8.172b). Nine other finger ridge count variables showed higher counts in Darier's females in comparison to first degree unaffected relatives (see Table 8.172b). All of the nine variables involved fingers II and III.

Discriminant analysis was carried out using the variable sets; LFU1 to RFR5 (individual finger ridge counts) and RF1 to LF5 (unilateral ridge counts) for both male and female subjects; and RPRC to TFU (summed counts) for female subjects. These variable sets were chosen because the greatest number of significant differences were found in Mann-Whitney U Test intergroup comparisons for variables within these sets.

When discriminant analysis was carried out on male subjects using variables LFU1 to RPR5 four canonical discriminant functions were produced. Function 1 was found to account for 63.27% of the variance with Function 2 taking out another 17.73% (Table 8.173a). The variables in Function 1 are radial counts on fingers II and III of

both hands (Table 8.173c). Function 2 is composed of radial counts on finger IV of both hands along with ulnar count on finger L III. The table of F Statistics and significances between groups (Table 8.173b) shows the greatest differences to be between controls and Darier's ($F = 4.212$) and controls and Darier's unaffected relatives ($F = 2.6954$). Both of these intergroup differences were significant at the 1% level. The territorial map (Figure 8.36) shows that controls are separated from the other groups with Dariers equidistant from controls and normal spouses. Dariers unaffected first relatives and children have their group centroids side by side. The table of Classification Results shows 52.47% of grouped cases to be correctly classified (Table 8.174). Controls (57%) and Dariers unaffected 1st degree relatives (44.4%) show the best classification results. Dariers males show 32.3% correct classification.

Discriminant analysis for female subjects using the same set of variables produced four canonical discriminant functions (Table 8.175a). Function 1 accounts for 57.81% of the variance with Function 2 taking out another 27.71%. Table 8.175c shows that radial count on finger V of both hands along with ulnar count on R II are the most important discriminating variables. The Table of F Statistics show that controls and Dariers females ($F = 6.3615$) and controls and Dariers unaffected relatives ($F = 5.6533$) are the best separated groups both being highly significantly different at the 1% level of probability (see Table 8.175b). The territorial map (Figure 8.37) shows the relationships of the various groups with Dariers and their unaffected relatives to be at one side and controls and spouses at the other side, with children in the centre. Table 8.176 shows 62.11% correct classification of group cases. Dariers female patients show 51.4% correct classification using this set of variables.

When males were subjected to discriminant analysis using RF1 to LF5 as the set of variables Function 1 of the four canonical discriminant functions produced accounted for 60.05% of the variance with another 19.07% being extracted by Function 2 (Table 8.177a). Function 1 was composed of RF3 and LF3 i.e. unilateral counts on finger III of both hands. Function 2 contained unilateral counts on both hands for fingers I and V and for finger II of the left hand (Table 8.177c). The territorial map shows controls and spouses to be

on one side with Dariers males in the middle and unaffected relatives and children at the other side (Figure 8.38). Classification was found to be 46.39% correct with Darier's males having 25.8% correct classification (Table 8.178).

The same set of variables were used for discriminant analysis with female subjects. Table 8.179 shows that four canonical discriminant functions were produced with Function 1 accounting for 57.26% of the variance and Function 2 accounting for another 30.80%. Function 1 was composed of LF3 and RF5 and Function 2 of LF5. The territorial map shows controls and Darier's females to be adjacent and spouses and children also to be alongside one another. The Dariers 1st degree unaffected relatives were apart from the other groups (Figure 8.39). Table 8.180 shows that 51.94% correct classification occurred using variables RF1 to LF5 with Dariers females being 40.5% correctly classified.

Female subjects were also subjected to discriminant analysis using variables RFRC to TFU. Function 1 accounted for 69.49% of the variance and contained eight of the variables (see Tables 8.181a and c). F Statistics show again that controls and Dariers females ($F = 6.2592$) and controls and Darier's unaffected female first degree relatives were the groups most widely separated. F value for the first pair was 6.2592 and for the second, 3.4410. Both pairs of groups were significantly different at the 1% level of probability (Table 8.181b). The territorial map shows Dariers and their relatives to be to the left. Controls and spouses are adjacent and children are in the centre (Figure 8.40).

Classification results show 31.64% correctness. Dariers females are 42.9% correctly grouped (Table 8.182).

Factor analysis was carried out for male and female subjects separately using variables RF1 to TFU ie. all the computed finger ridge counts. For males six factors were extracted using principal component analysis with Factor 1 accounting for 67% of the variance (Table 8.183a). The rotated factor matrix shows that fifteen variables constitute Factor 1 with radial counts on the right hand and finger III being the most common constituents of the variables shown. Seven of the fifteen, for example are from finger III (see Table 8.183b).

For females, seven factors were extracted with Factor 1 accounting for 69.5% of the total variance (Table 8.184a). Factor 1 was composed of 17 variables seven of which involved finger IV and radial counts were the most prominent (Table 8.184b).

Table 8.171 - Finger Ridge Counts : Darier's v Controls

(a) Males

VARIABLE	DARIERS M		CONT. M.		M-W U TEST Probability
	Mean	± S.D.	Mean	± S.D.	
LFR1	16.250	5.924	17.927	5.410	0.0407*
LFU3	6.594	8.791	2.296	5.793	0.0007**
RFR2	6.406	6.942	9.767	7.417	0.0115*
RFR3	10.719	6.402	13.277	5.780	0.0132*
U3	11.375	15.752	5.495	11.356	0.0219*

Table 8.171b - Females

VARIABLE	DARIERS M		CONT. M.		M-W U TEST Probability
	Mean	± S.D.	Mean	± S.D.	
LFU2	8.514	8.543	4.719	6.936	0.0214*
LFR3	9.000	6.234	11.591	5.405	0.0212*
LFU4	5.784	7.413	3.300	6.224	0.0350*
LFU5	1.459	3.501	0.818	2.940	0.0311*
RFU4	5.947	7.006	3.660	6.336	0.0210*
LFU	24.543	23.683	14.631	19.024	0.0155*
TFU	46.371	42.509	29.271	33.496	0.0315*

Table 8.172 - Finger Ridge Counts: Darier's v Unaffected Relatives

VARIABLE	DARIERS M		UN. REL. M.		M-W U TEST Probability
	Mean	± S.D.	Mean	± S.D.	
LF3	12.875	6.568	7.944	7.557	0.0328*
LF4	17.452	5.409	12.444	8.046	0.0364*
LFA3	18.094	13.081	10.333	11.178	0.0395*
LFRC	74.871	24.374	55.944	33.502	0.0476*

(b) Females

VARIABLE	DARIERS M		UN. REL. M.		M-W U TEST Probability
	Mean	± S.D.	Mean	± S.D.	
LFR3	9.000	6.234	4.923	5.041	0.0404*
RF2	12.184	7.285	8.077	5.499	0.0475*
LF3	10.053	6.928	4.923	5.041	0.0161*
RFA2	16.079	11.642	8.385	5.781	0.0181*
LFA2	15.541	11.167	7.462	7.785	0.0189*
LFA3	11.474	9.882	5.385	5.767	0.0294*
U2	16.216	16.092	4.538	8.303	0.0176*
F2	23.811	13.689	15.538	11.155	0.0417*
AF2	31.892	22.055	15.846	11.488	0.0168*
RFU	20.974	21.804	7.154	7.046	0.0389*
TFU	46.371	42.509	19.000	22.379	0.0447*

Table 8.173 - Males: LFU1 to RFR5

(a) Canonical Discriminant Functions

FUNCTION	EIGENVALUE	PERCENT OF VARIANCE	CUMULATIVE PERCENT
1*	0.25190	63.27	63.27
2*	0.07034	17.73	81.01
3*	0.04644	11.71	92.71
4*	0.02891	7.29	100.00

(b) F Statistics and significances between groups

GROUP	1	2	3	4
2	4.2412 0.0000			
3	2.6954 0.0027	1.4701 0.1431		
4	1.5806 0.1048	1.2939 0.2340	0.98311 0.4623	
5	1.1922 0.2927	0.32280 0.6173	0.78567 0.6543	1.0409 0.4103

(c) Structure matrix

	FUNC 1	FUNC 2	FUNC 3	FUNC 4
LFR3	0.53976*	0.53381	0.32910	0.44065
RFR3	0.51501*	0.36264	0.04740	0.23024
RFR2	0.42063*	0.13449	0.02162	0.22115
LFR2	0.30225*	0.26258	0.10492	0.27901
LFU3	0.34258	0.60220*	0.07965	0.17552
LFR4	0.13224	0.59042*	0.16903	0.17400
RFR4	0.23095	0.53659*	0.16946	0.27860
RFU3	0.14730	0.34735*	0.02129	0.23143
RFR5	0.12295	0.33886*	0.24931	0.29584
RFR1	0.10725	0.24211	0.58832*	0.29675
LFR1	0.35493	0.19764	0.54717*	0.10882
LFU2	0.11479	0.10967	0.50531*	0.25002
LFU1	0.06757	0.14220	0.47636*	0.02112
RFU1	0.06764	0.13572	0.34111*	0.19695
LFR5	0.10232	0.30651	0.33776*	0.27217
RFU2	0.05877	0.19799	0.12624	0.58842*
RFU4	0.05639	0.27216	0.22277	0.34427*
LFU4	0.02958	0.26877	0.09181	0.32991*
RFU5	0.13159	0.02502	0.09227	0.26290*
LFU5	0.21783	0.05662	0.04510	0.23776*

Figure 8.36 - Territorial Map - Males: LFU1 to RPR5

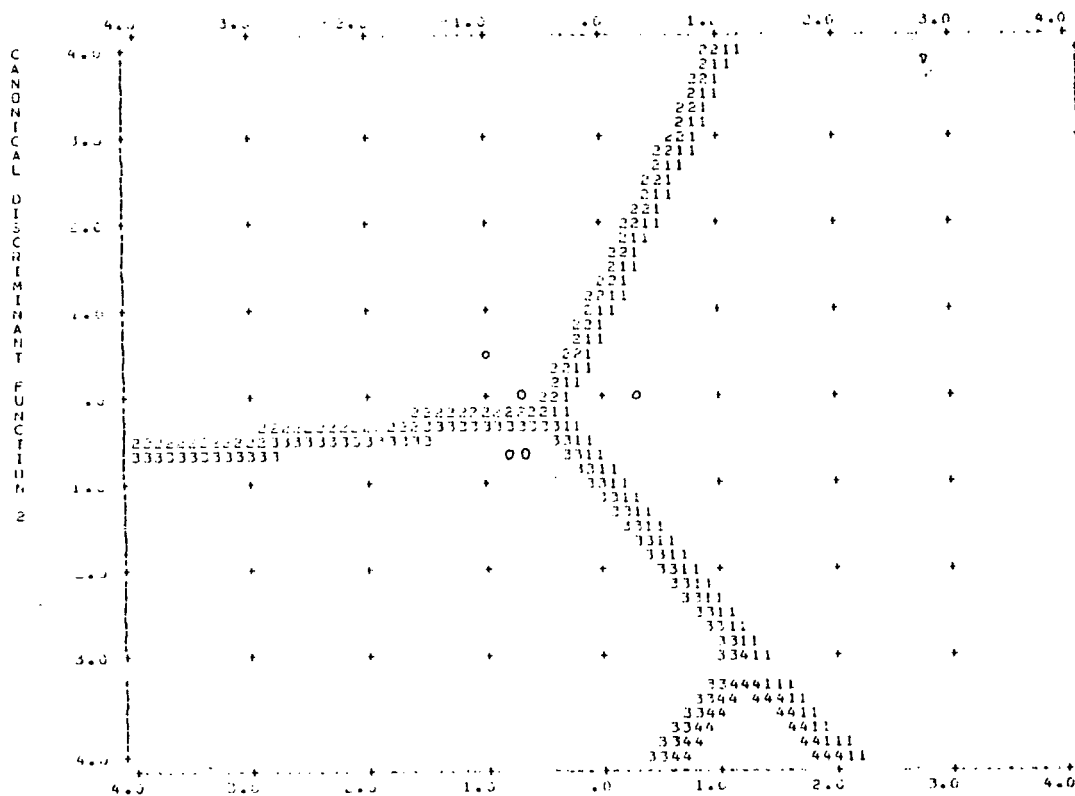

Code	Group
1	Controls
2	Darier's Subjects
3	Darier's 1 ^o Relatives
4	Darier's Children
5	Darier's Spouses

Table 8.174 - Males: LFU1 to RFR5

CLASSIFICATION RESULTS -

ACTUAL GROUP	NO. OF CASES	PREDICTED GROUP MEMBERSHIP				
		1	2	3	4	5
GROUP 1	200	114 57.0%	23 11.5%	26 13.0%	19 9.5%	18 9.0%
GROUP 2	31	7 22.6%	10 32.3%	6 19.4%	4 12.9%	4 12.9%
GROUP 3	18	2 11.1%	2 11.1%	8 44.4%	3 16.7%	3 16.7%
GROUP 4	7	2 28.6%	0 0.0%	1 14.3%	3 42.9%	1 14.3%
GROUP 5	7	1 14.3%	1 14.3%	1 14.3%	1 14.3%	3 42.9%

PERCENT OF "GROUPED" CASES CORRECTLY CLASSIFIED: 52.47%

Table 8.175 - Females: LFU1 to RPR5

(a) Canonical Discriminant Functions

FUNCTION	EIGENVALUE	PERCENT OF VARIANCE	CUMULATIVE PERCENT
1*	0.25625	57.81	57.81
2*	0.12764	27.71	85.52
3*	0.05291	11.49	97.01
4#	0.01378	2.99	100.00

(b) F Statistics and significances between groups

GROUP	1	2	3	4
2	6.3615 0.0000			
3	5.6533 0.0000	2.7053 0.0102		
4	2.5561 0.0147	3.3225 0.0021	2.9095 0.0061	
5	2.0025 0.0554	3.1916 0.0030	2.3692 0.0233	1.0305 0.4103

Code	Group
1	Controls
2	Darier's Subjects
3	Darier's 1 ^o Relatives
4	Darier's Children
5	Darier's Spouses

(c) Structure matrix

	FUNC 1	FUNC 2	FUNC 3	FUNC 4
RFU2	0.11837	0.38697	0.67279*	0.37123
RFR5	-0.38968	0.08759	0.48697*	0.47317
LFR5	-0.40179	-0.31784	0.29645	0.79077*
RFR1	0.14174	-0.03388	-0.19428	0.73434*
LFR3	-0.47646	0.51096	-0.16791	0.68084*
LFR4	-0.27432	0.10781	0.17060	0.65565*
RFR3	-0.20716	0.32456	-0.01792	0.59744*
RFR4	-0.23937	0.18382	0.21712	0.58604*
LFR1	0.00260	0.12595	-0.17447	0.57463*
RFU4	0.08596	0.22447	0.10953	0.55094*
LFU2	0.26480	0.41507	0.20191	0.54237*
LFU4	0.20314	0.38104	0.19549	0.53037*
RFR2	-0.16472	0.20606	0.03224	0.45865*
LFU1	0.08400	0.17564	0.05895	0.36584*
LFR2	-0.23140	0.26276	0.06043	0.34901*
LFU3	0.12954	0.25060	0.25696	0.34342*
RFU1	-0.02964	0.08731	-0.01850	0.31614*
LFU5	0.11069	0.20184	0.06528	0.30323*
RFU3	0.01448	0.23434	0.20169	0.26974*
RFU5	0.02756	0.16091	0.08797	0.25859*

Figure 8.37 - Territorial Map - Females: LFU1 to RPR5

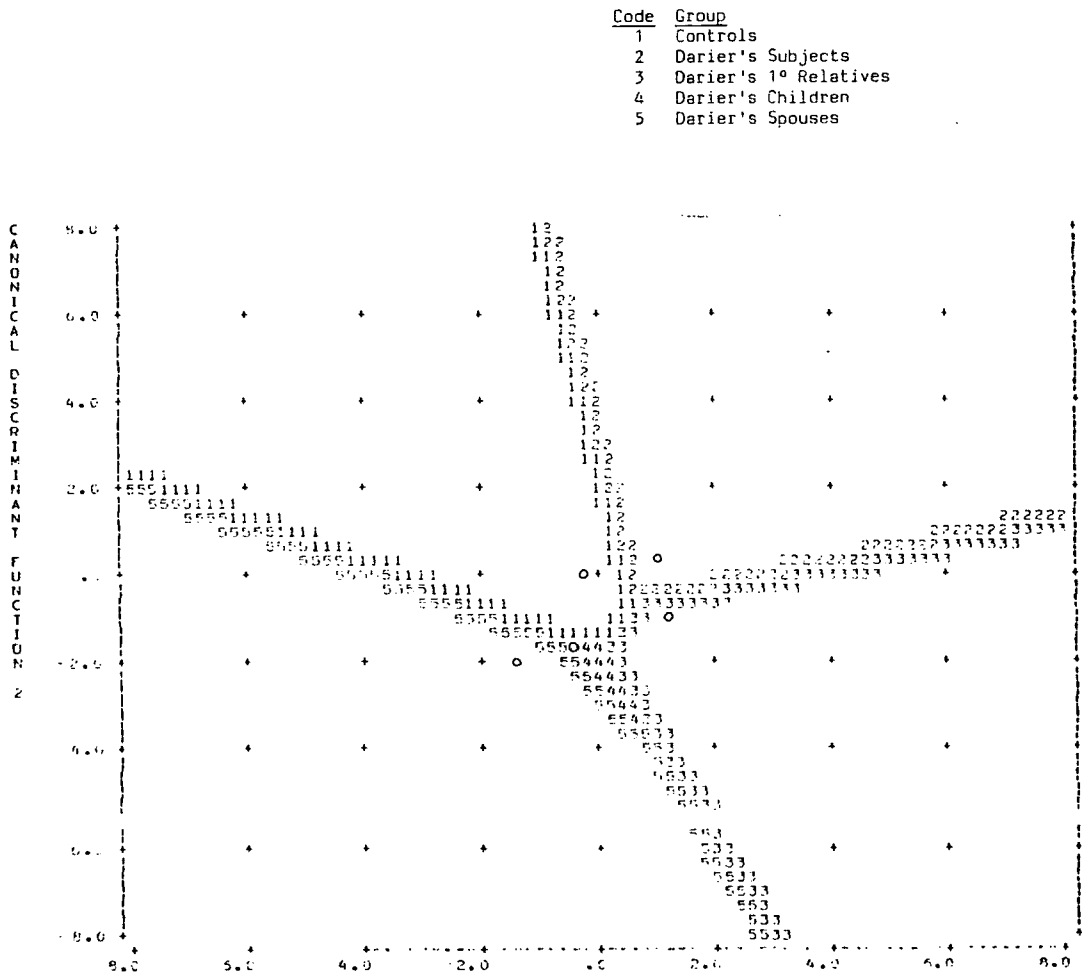

Table 8.176 - Females: LFU1 to RFR5

CLASSIFICATION RESULTS		NO. OF CASES	PREDICTED GROUP MEMBERSHIP				
ACTUAL GROUP	1		2	3	4	5	
GROUP 1	202	125 61.9%	34 16.8%	19 9.4%	15 7.4%	9 4.5%	
GROUP 2	35	8 22.9%	18 51.4%	7 20.0%	1 2.9%	1 2.9%	
GROUP 3	13	1 7.7%	0 0.0%	11 84.6%	0 0.0%	1 7.7%	
GROUP 4	4	0 0.0%	0 0.0%	0 0.0%	3 75.0%	1 25.0%	
GROUP 5	2	0 0.0%	0 0.0%	0 0.0%	0 0.0%	2 100.0%	

PERCENT OF "GROUPED" CASES CORRECTLY CLASSIFIED: 62.11%

Table 8.177 - Males: RF1 To LF5

FUNCTION	EIGENVALUE	PERCENT OF VARIANCE	CUMULATIVE PERCENT	CANONICAL CORRELATION
1*	0.11963	60.05	60.05	0.3269725
2*	0.03799	19.07	79.12	0.1912985
3*	0.03443	17.29	96.41	0.1824501
4*	0.00715	3.59	100.00	0.0842621

(b) F Statistics and significances between groups

GROUP	1	2	3	4
2	3.1537 0.0088			
3	3.7513 0.0027	1.8386 0.1058		
4	2.8960 0.0146	1.9516 0.0864	1.7316 0.1278	
5	1.1600 0.3294	0.92701 0.4640	0.45461 0.8097	1.5253 0.1823

Code	Group
1	Controls
2	Darier's Subjects
3	Darier's 1 st Relatives
4	Darier's Children
5	Darier's Spouses

(c) Structure Matrix

	FUNC 1	FUNC 2	FUNC 3	FUNC 4
RF3	0.78904*	0.15450	0.18889	0.35277
LF3	0.76166*	0.41939	0.46840	0.13981
LF1	0.47149	0.79913*	0.20042	0.25879
RF1	0.35199	0.65493*	0.00474	0.02920
LF5	0.26567	0.50091*	0.36235	0.00841
RF5	0.31819	0.47221*	0.32928	0.10308
LF2	0.42113	0.46443*	0.25121	0.33348
LF4	0.32187	0.45622	0.68173*	0.06886
RF4	0.43283	0.39546	0.54895*	0.07992
RF2	0.29610	0.56990	0.31427	0.66077*

Figure 8.38 - Territorial Map - Males: RF1 to LF5

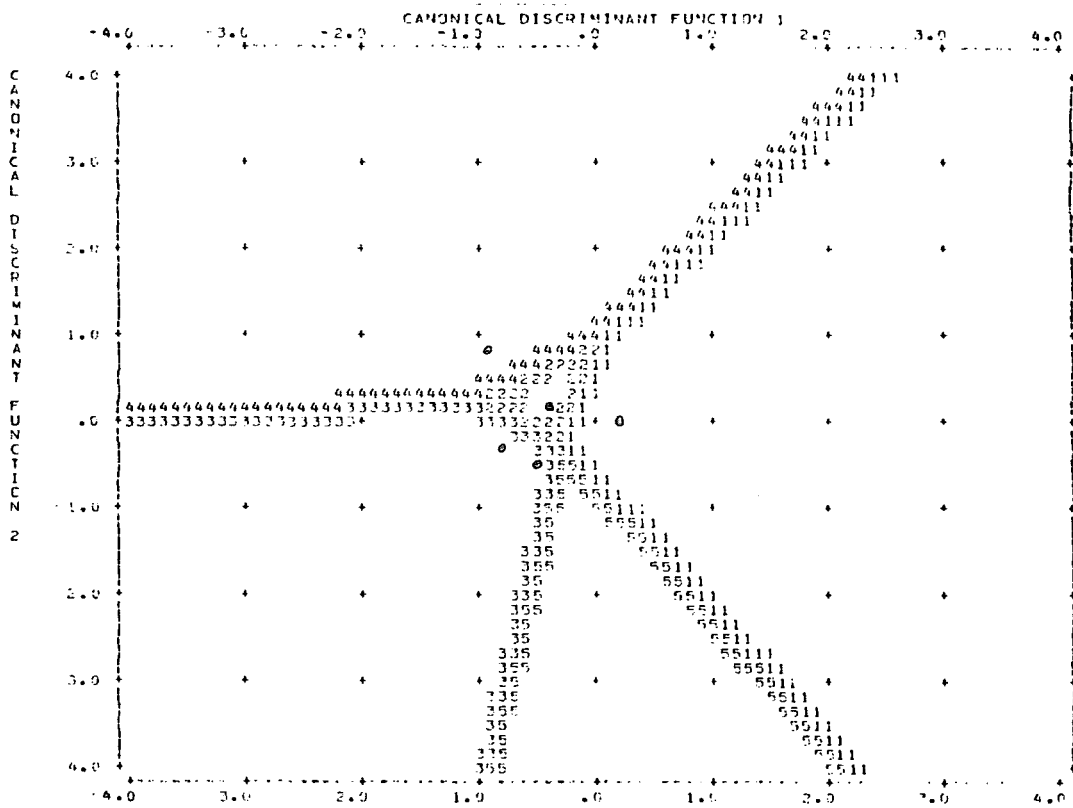

Code	Group
1	Controls
2	Darier's Subjects
3	Darier's 1 st Relatives
4	Darier's Children
5	Darier's Spouses

Table 8.178 - Males: RF1 to LF5

CLASSIFICATION RESULTS

ACTUAL GROUP	NO. OF CASES	PREDICTED GROUP MEMBERSHIP				
		1	2	3	4	5
GROUP 1	200	105 52.5%	30 15.0%	21 10.5%	17 8.5%	27 13.5%
GROUP 2	31	10 32.3%	8 25.8%	6 19.4%	5 16.1%	2 6.5%
GROUP 3	18	4 22.2%	3 16.7%	4 22.2%	4 22.2%	3 16.7%
GROUP 4	7	1 14.3%	2 28.6%	1 14.3%	3 42.9%	0 0.0%
GROUP 5	7	1 14.3%	2 28.6%	1 14.3%	1 14.3%	2 28.6%

PERCENT OF "GROUPED" CASES CORRECTLY CLASSIFIED: 46.39%

Table 8.179 - Females: RF1 to LF5

(a) Canonical Discriminant Functions

FUNCTION	EIGENVALUE	PERCENT OF VARIANCE	CUMULATIVE PERCENT	CANONICAL CORRELATION
1*	0.17094	57.26	57.26	0.3820843
2*	0.09195	30.30	88.06	0.2901895
3*	0.02327	7.80	95.86	0.1508059
4*	0.01237	4.14	100.00	0.1105367

(b) F Statistics and significances between groups

GROUP	1	2	3	4
2	2.6410 0.0239			
3	7.3679 0.0000	3.6613 0.0033		
4	3.1609 0.0037	3.3263 0.0063	2.8396 0.0148	
5	2.0974 0.0663	2.4901 0.0319	2.2511 0.0499	0.98329 0.4285

Code Group
 1 Controls
 2 Darier's Subjects
 3 Darier's 1st Relatives
 4 Darier's Children
 5 Darier's Spouses

(c) Structure Matrix

	FUNC 1	FUNC 2	FUNC 3	FUNC 4
LF3	0.69512*	-0.11131	0.37254	-0.59074
RF5	0.43449*	0.43016	-0.25218	0.40395
LF5	0.24801	0.75971*	0.23779	0.52342
RF2	0.18589	-0.06166	-0.23060	0.94890*
RF3	0.38210	-0.07759	0.11304	0.68529*
LF2	0.34179	-0.05431	0.02798	0.66634*
RF1	-0.11063	-0.11763	0.38672	0.64118*
LF4	0.38411	0.26311	0.13046	0.57237*
RF4	0.38458	0.17427	0.04695	0.53225*
LF1	0.11464	-0.11693	0.30270	0.50150*

Figure 8.39 - Territorial Map - Females: RF1 to LF5

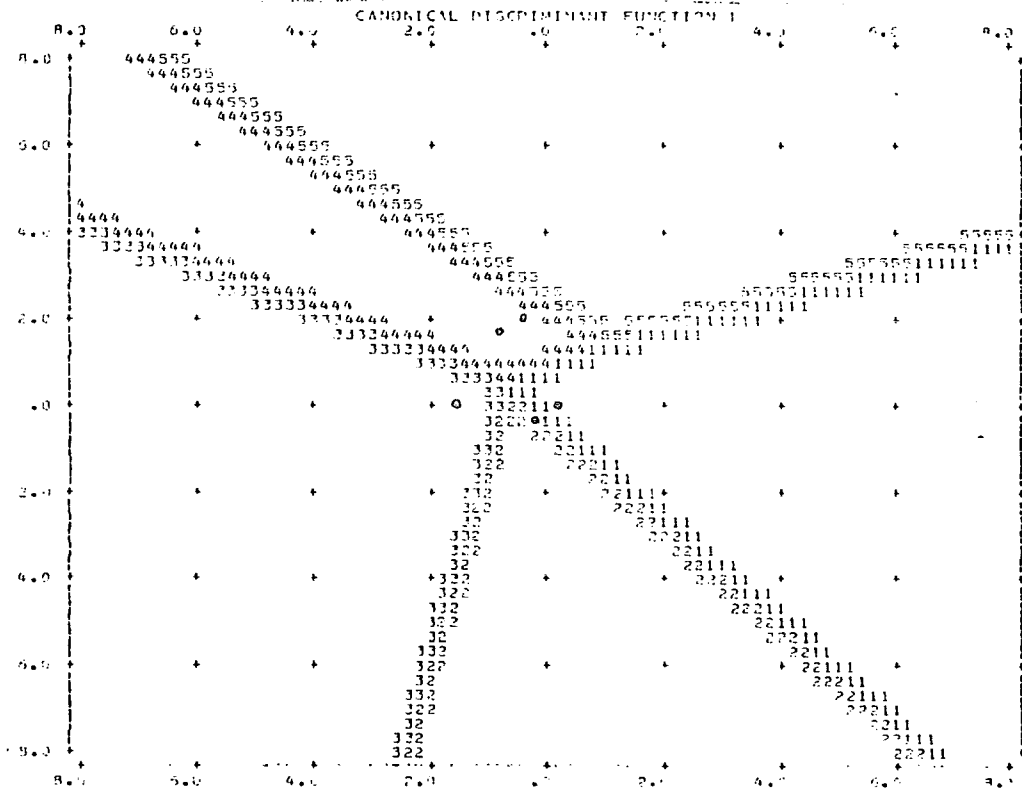

Code	Group
1	Controls
2	Darier's Subjects
3	Darier's 1 st Relatives
4	Darier's Children
5	Darier's Spouses

Table 8.180 - Females: RF1 to LF5

CLASSIFICATION RESULTS

ACTUAL GROUP	NO. OF CASES	PREDICTED GROUP MEMBERSHIP				
		1	2	3	4	5
GROUP 1	202	103 51.0%	51 25.2%	16 7.9%	19 9.4%	13 6.4%
GROUP 2	37	10 27.0%	15 40.5%	8 21.6%	1 2.7%	3 8.1%
GROUP 3	13	0 0.0%	1 7.7%	10 76.9%	0 0.0%	2 15.4%
GROUP 4	4	0 0.0%	0 0.0%	0 0.0%	4 100.0%	0 0.0%
GROUP 5	2	0 0.0%	0 0.0%	0 0.0%	0 0.0%	2 100.0%

PERCENT OF "GROUPED" CASES CORRECTLY CLASSIFIED: 51.94%

Table 8.181 - Females: RPRC to TFU

(a) Canonical Discriminant Functions

FUNCTION	EIGENVALUE	PERCENT OF VARIANCE	CUMULATIVE PERCENT	CANONICAL CORRELATION
1*	0.16095	69.49	69.49	0.3723367
2*	0.04532	19.57	89.06	0.2082243
3*	0.02153	9.32	98.38	0.1453479
4*	0.00376	1.62	100.00	0.0611777

(b) F Statistics and significances between groups

GROUP	1	2	3	4
2	6.2592 0.0000			
3	3.4410 0.0050	2.1193 0.0639		
4	1.2379 0.2919	1.6458 0.1485	1.2846 0.2710	
5	0.75940 0.5799	2.0340 0.0745	1.7709 0.1194	1.0543 0.3864

Code Group
 1 Controls
 2 Darier's Subjects
 3 Darier's 1^o Relatives
 4 Darier's Children
 5 Darier's Spouses

(c) Structure Matrix

	FUNC 1	FUNC 2	FUNC 3	FUNC 4
LFAC	0.11658	0.76060*	0.24304	0.43029
TFU	-0.31326	0.74431*	0.04841	0.18078
LERC	0.34906	-0.73796*	0.08599	0.53838
TFAC	0.07530	0.70709*	0.01069	0.52117
RFU	-0.22155	0.70351*	0.34167	0.07514
LFU	-0.34936	0.67201*	0.38948	0.24865
LFR	0.52613	0.64794*	0.04216	0.49066
RFAC	0.02713	0.59909*	0.22965	0.57592
RFR	0.22033	0.36933	-0.08374	0.83806*
RFRC	0.17857	0.48084	-0.12503	0.80479*
TFR	0.38505	0.52643	-0.02319	0.69629*
TFRC	0.27247	0.62964	-0.02057	0.69489*

Figure 8.40 - Territorial Map - Females: RPRC to TFU

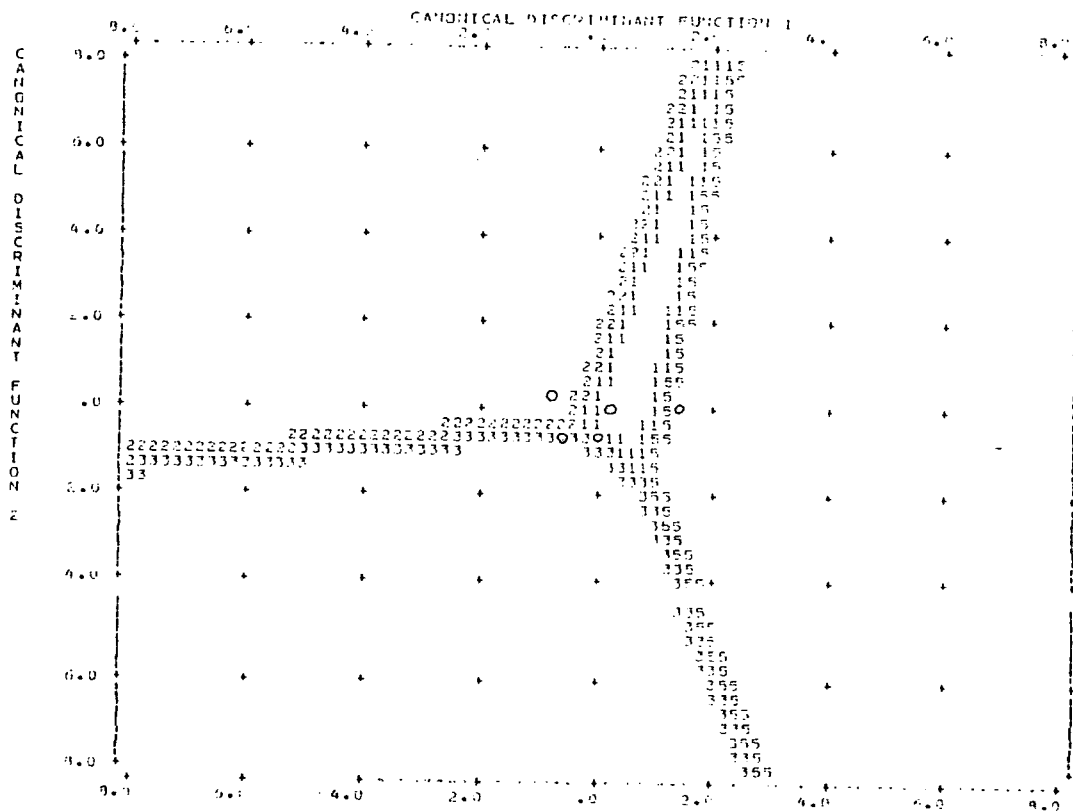

Code	Group
1	Controls
2	Darier's Subjects
3	Darier's 1° Relatives
4	Darier's Children
5	Darier's Spouses

Table 8.182 - Females: RFRC to TFU

CLASSIFICATION RESULTS

ACTUAL GROUP	NO. OF CASES	PREDICTED GROUP MEMBERSHIP				
		1	2	3	4	5
GROUP 1	202	57 28.2%	34 16.8%	41 20.3%	23 11.4%	47 23.3%
GROUP 2	35	4 11.4%	15 42.9%	10 28.6%	4 11.4%	2 5.7%
GROUP 3	13	1 7.7%	2 15.4%	5 38.5%	3 23.1%	2 15.4%
GROUP 4	4	1 25.0%	0 0.0%	0 0.0%	2 50.0%	1 25.0%
GROUP 5	2	0 0.0%	0 0.0%	0 0.0%	0 0.0%	2 100.0%

PERCENT OF "GROUPED" CASES CORRECTLY CLASSIFIED: 31.64%

Table 8.183 - Darriers Males - Factor RF1 to TFU

(a)

FACTOR	EIGENVALUE	PCT OF VAR	CUM PCT
1	34.84969	67.0	67.0
2	3.72784	7.2	74.2
3	3.20871	6.2	80.4
4	2.60401	5.0	85.4
5	2.18356	4.2	89.6
6	1.23140	2.4	91.9

(b)

ROTATED FACTOR MATRIX:

	FACTOR 1	FACTOR 2	FACTOR 3	FACTOR 4	FACTOR 5	FACTOR 6
RF3	.97934	.22435	.09816	.17973	.17596	-.10497
F3	.86930	.26564	.20154	.26401	.19176	-.03447
R3	.83642	.13047	.19655	.37890	.14932	.07692
RFA3	.78674	.34226	.17480	.37213	.33506	.08542
LF3	.75976	.27777	.28484	.32953	.18611	.17316
AF3	.75275	.34399	.27528	.16936	.37359	.22223
RFR	.65974	.26614	.42089	.41307	.14984	-.28017
LFA3	.64812	.30544	.33999	.24051	.37174	.32404
RF4	.61499	.37484	.52213	.21449	.15601	-.12399
RFR4	.60856	.49816	.43102	.37381	.15601	-.12399
TFR	.54429	.30919	.51664	.50359	.20788	-.14785
RFA4	.53098	.49384	.31821	.41423	.41427	.30433
TFRC	.52061	.47449	.50071	.44049	.21895	-.04898
R2	.51554	.38763	.14723	.26076	.20664	-.50387
U3	.50379	.42049	.26886	.03022	.45091	.40853
U2	.10393	.86831	.19134	.19169	.19752	.23510
F2	.35364	.83970	.24254	.20295	.16052	-.09721
AF2	.33316	.82921	.21354	.27040	.24037	.37903
LFA2	.20829	.82775	.28368	.29847	.17611	.06839
LF2	.22963	.80071	.27355	.25434	.19587	.02147
RF2	.44235	.79463	.18722	.13112	.10906	-.20527
RFA2	.43781	.69939	.09115	.19190	.28328	-.25249
RFU	.33535	.58150	.18117	.34061	.54590	.21048
R5	.13683	.14832	.82479	.26764	.36185	.14450
F5	.13801	.15200	.81734	.27792	.38021	.12725
LF4	.26666	.25985	.76657	.22264	.05768	-.11387
RF5	.21340	.19098	.73731	.17305	.25331	.24739
R4	.44999	.31561	.72754	.24267	.03190	-.11171
LF5	.01568	.06836	.70367	.32936	.41976	-.05821
F4	.49629	.38185	.69538	.33884	.07399	-.17711
AF4	.46592	.39428	.57154	.24390	.43506	-.01346
LFR	.39019	.32654	.56863	.55154	.24764	-.08400
LFA4	.36962	.32902	.56439	.10302	.56793	.10543
LFRC	.40216	.42574	.54852	.48817	.27997	.03231
RFA4	.49157	.40413	.51662	.32775	.30117	.05991
FI	.21721	.19378	.30789	.86916	.14501	.05442
R1	.15923	.23852	.27556	.46346	.13929	-.11743
AF1	.24850	.22308	.19202	.82430	.37664	.06599
RF1	.17729	.27073	.26840	.42173	.01927	-.16064
RFA1	.20878	.34364	.12277	.79703	.19699	.06940
LF1	.22581	.09306	.30362	.72544	.28328	.05537
LFA1	.25044	.07613	.21216	.73132	.49331	.11034
U1	.27119	.17692	.08802	.66620	.44209	.18320
U5	.13698	.10836	.03719	.16970	.90731	-.16009
LFA5	.10924	.09424	.35752	.26921	.83556	.13901
AF5	.16912	.15559	.42301	.26290	.82399	-.03294
RFA5	.21586	.20524	.45044	.23004	.72969	.08472
LFU	.34366	.43401	.22038	.25806	.70256	.21692
U4	.35010	.35678	.26651	.17667	.64738	.08124
TFU	.34951	.52218	.20691	.30795	.64310	.22000
LFAC	.39609	.42026	.40716	.42177	.54516	.29114
TFAC	.47038	.46450	.37032	.42575	.49032	.04571

Table 8.184 - Dairies Females - Factor - RF1 to TFU

(b)

ROTATED FACTOR MATRIX:

	FACTOR 1	FACTOR 2	FACTOR 3	FACTOR 4	FACTOR 5	FACTOR 6	FACTOR 7
R1	.89267	.21336	.13729	.16754	.04186	.20930	.00855
F1	.88784	.20165	.18025	.20658	.04765	.23944	.03133
RF1	.94887	.29365	-.01779	.24646	.07871	.18824	-.00815
LF1	.75155	.04791	.38408	.11528	-.00004	.25223	.07292
RF4	.69676	.40994	.13386	.42219	.19126	-.01110	.15461
F4	.69473	.35191	.28065	.43579	.20378	-.01610	.15991
R4	.68864	.34284	.26561	.46552	.17272	.00838	.17541
LF4	.65765	.27737	-.01260	.42731	.20595	.02027	.15711
TFRC	.61883	.47584	.39615	.41025	.15740	.14352	.12745
TFR	.61510	.50735	.24543	.47775	.16856	.19248	.07480
LFR	.61388	.39165	.34501	.49777	.15447	.17756	.04121
RFRC	.60909	.55336	.25859	.42000	.14444	.15904	.11456
LFRC	.59736	.36954	.52112	.37889	.16702	.12093	.13532
RFR	.58924	.58815	.14602	.43899	.17371	.19733	.08731
RFA4	.54943	.41966	.22984	.36332	.49860	.13493	.03177
AF4	.53965	.36942	.36899	.36507	.51185	.00896	.07754
LFA4	.49668	.29791	.47297	.34437	.49288	.11346	.11697
RF3	.30687	.80603	.30744	.20353	.14403	.09618	.09259
R3	.42150	.75807	.15600	.23389	.08743	.05703	.05703
RF43	.20507	.74190	.30070	.18245	.12123	.16726	.42478
F3	.41027	.73954	.37430	.16804	.18151	.09343	.18440
AF3	.27454	.63690	.40920	.16544	.17638	.14211	.50713
R2	.18368	.61593	.10754	.53042	.15277	.35996	.02422
LF3	.47480	.61012	.00646	.11877	.18257	.06370	.26723
RF2	.38179	.58123	.46940	.32342	.14564	.20091	.05669
RFAC	.46122	.51328	.28249	.37093	.29485	.40475	.19541
U2	.16876	.20448	.84444	.08789	.06376	.18805	.19320
LFU	.09843	.20126	.78021	.19614	.37252	.15876	.29071
LFA2	.17299	.38253	.75106	.37920	.11349	.19966	.16772
LF2	.33291	.41747	.72450	.26028	.10385	.12525	.06752
AF2	.21776	.47122	.66181	.34260	.12622	.32651	.12568
TFU	.16265	.27714	.64381	.21923	.41162	.39599	.31546
LFAC	.40816	.33558	.62299	.39417	.27153	.18990	.19295
F2	.37099	.52011	.61375	.30341	.12980	.17025	.06391
LFA1	.43877	.06082	.57904	.17092	.07271	.57391	.09730
RFA2	.24559	.52363	.53113	.28412	.12973	.42152	.13421
TFAC	.45061	.44178	.46366	.30554	.30344	.31072	.20099
R5	.38835	.21303	.24645	.81224	.10380	.20553	.11642
F5	.38700	.21513	.25429	.80894	.12430	.20683	.11701
LF5	.34719	.14209	.25659	.78445	.21502	.14289	-.03216
AF5	.26930	.20703	.19753	.72419	.47455	.22382	-.14747
LFA5	.21674	.12366	.21808	.71784	.49513	.05028	-.11149
RF5	.36888	.25584	.21408	.71247	.01523	.23971	.24929
RFA5	.26428	.24600	.13492	.47610	.35285	.34210	.37241
U5	-.04623	.10310	.02834	.25189	.85961	.15161	.12853
U4	.25358	.31100	.38542	.17192	.75399	.00729	-.04549
U1	.09021	.09379	.32241	.21901	.05484	.94227	.09265
AF1	.59033	.18900	.29158	.24205	.06174	.67167	.05962
RFA1	.61536	.26351	-.00617	.25999	.16586	.63631	.01479
RFU	.20635	.31580	.40023	.21044	.39059	.58859	.29431
U3	.01506	.22981	.30094	.10897	.03481	.14272	.84035
LFA3	.31597	.48004	.47566	.13459	.21298	.10562	.51902

(a)

FACTOR	EIGENVALUE	PCT OF VAR
1	36.13039	69.5
2	3.70421	7.1
3	2.57354	4.9
4	2.33585	4.5
5	1.51588	2.9
6	1.30177	2.5
7	1.01569	2.0

(iii) Finger Patterns

When male Darier's patients were compared to control male subjects, a significantly greater frequency of occurrence of whorls (cat. 4), double loops (cat. 5), ulnar central pocket loops (cat. 8) and

finger IV of the right hand. A significantly lower occurrence of ulnar loops (cat. 2) was also found in Darier's patients compared to control males on the same finger (Table 8.185a). A significantly higher occurrence of radial loop scores was found in Darier's males on R IV and L III in comparison to control males. Significantly higher occurrences of ulnar loop scores were found on finger R IV and L III of Darier's males when compared to the scores for their first degree relatives (Table 8.186a). Higher values were found in male Darier's subjects for finger delta scores on R IV and L III when compared to control males. A higher value was also found for total finger pattern intensity index (TFPII) in Darier's males compared to controls (Table 8.187a).

Darier's females were found to have a significantly higher frequency of occurrence of radial loops (cat. 3), whorls, arches and ulnar central pocket loops and a significantly lower occurrence of ulnar loops (cat. 2) and double loops when compared to control females (Table 8.185). Female Darier's patients also had a significantly higher occurrence of radial loops, arches, whorls, double loops and radial c.p. loops (cat. 9) along with significantly lower occurrence of tented arch (cat. 1) and ulnar loops when compared to their unaffected first degree relatives (Table 8.186). Female Darier's probands had significantly higher occurrence of radial loop score on finger R IV and lower occurrence of ulnar loop scores on fingers L III and L IV compared to controls. They were also found to have a significantly higher occurrence of radial loop score on finger R II when compared to unaffected female relatives (Table 8.186b). Darier's females were also found to have higher delta scores on finger L V in comparison to controls and on finger L II when compared to unaffected female first degree relatives (Tables 8.187b and 8.188).

Discriminant analysis was carried out for male subjects using the variable set RPR1 to LPU5. Four canonical discriminant functions were produced (Table 8.189a) with Function 1 accounting for

59.56% of the total variance and Function 2 responsible for another 27.54%. Function 1 was composed of ulnar and radial counts on L III along with ulnar counts on R III and L I (Table 8.189b). Function 2 was made up of ulnar counts on fingers IV and V of both hands. Seven out of the first eight most important discriminating variables were found to be ulnar counts. Table 8.189c shows that the best separated groups were controls and unaffected Darriers relatives ($F = 5.1216$) and controls and Darriers subjects ($F = 4.6574$) both differences being significant statistically at the 1% level. The territorial map shows Darriers to be separated to the right of controls. Unaffected relatives and spouses are closest to controls with Darrier's children removed vertically upwards (Figure 8.41). The classification results table shows that 59.2% of the cases to be correctly classified. Darriers males were 34.5% correctly classified using this set of variables (Table 8.190).

Four canonical discriminant functions were produced for female subjects by discriminant analysis of variables RPR1 to LPU5 (Table 8.191a). Function 1 accounted for 49.31% of the variance with Function 2 accounting for a further 31.48%. Eight variables composed Function 1 all from Finger III, IV and V with six of the eight being radial counts and five being on the left hand (Table 8.191c). The groups furthest apart were found to be controls and Darriers females ($F = 3.9707$) followed by Darriers and their unaffected relatives ($F = 2.6639$) see Table 8.191b. Figure 8.42 shows controls to be separated from a group of Darriers patients, their spouses and children with unaffected female relatives removed vertically downwards from the cluster of three centroids. Classification results show 50.2% correctly classified cases. Darriers females were found to be 34.3% correctly classified (Table 8.192).

Table 8.185 - Finger Pattern Occurrence : Darriers v Controls

(a) Males

VARIABLE	Cat. Percentage Frequencies		M-W U Test Probability	
	Dars.M.	Cont.M.		
RP4	0	0.0	0.5	0.0185*
	2	28.1	51.0	
	3	3.1	0.5	
	4	50.0	37.4	
	5	3.1	1.5	
	8	9.4	8.3	
	9	0.0	0.5	
	15	6.3	0.0	
20	0.0	0.5		
RPR4	0	28.1	51.7	0.0176*
	1	71.9	48.3	
LPR3	0	59.4	83.5	0.0011**
	1	40.6	16.5	

(b) Females

	Dars.F.		Cont. F.	
LP5	0	2.7	1.5	0.0495*
	2	75.7	89.7	
	3	2.7	0.0	
	4	8.1	5.4	
	5	0.0	2.0	
	8	10.8	0.0	
RPR4	0	50.0	69.7	0.0199*
	1	50.0	30.3	
LPU3	0	15.8	5.4	0.0229*
	1	84.2	94.6	
LPU4	0	13.5	2.5	0.0021**
	1	86.5	97.5	

Table 8.186 - Finger Patterns : Darriers v Unaffected Relatives

(a) Males

VARIABLE	Cat.	Percentage Frequencies		M-W U Test Probability
		Dars.M.	Un.Rels.M	
RPU4	0	3.1	22.2	0.0206*
	1	90.6	77.8	
	2	6.3	0.0	
LPU3	0	12.5	38.9	0.0323*
	1	87.5	61.1	

(b) Females

		Dars.F.	Un.Rel.F.	
LP2	0	10.8	7.7	0.0144*
	1	0.0	7.7	
	2	32.4	69.2	
	3	18.9	15.4	
	4	29.7	0.0	
	5	5.4	0.0	
	9	2.7	0.0	
RPR2	0	50.0	84.6	0.0302*
	1	50.0	15.4	

Table 8.187 - Finger Pattern Scores : Darriers v Controls

(a) Males

Variables	Dars. M.		Cont. M.		M-W U Test Probability
	Mean	± S.D.	Mean	± S.D.	
RD4	4.500	3.213	3.403	2.118	0.0185*
LD3	2.781	1.385	2.311	1.059	0.0069**
TFPII	32.355	9.214	29.277	10.127	0.0344*

(b) Females

LD5	Dars.F.		Cont. F.		M-W U Test Probability
	Mean	± S.D.	Mean	± S.D.	
	2.784	1.960	2.227	0.969	0.0495*

Table 8.188

Variable	Dars.F.		Un.Rel.F.		M-W U Test Probability
	Mean	± S.D.	Mean	± S.D.	
LD2	2.919	1.689	1.923	0.760	0.0144*

Table 8.189 - Males: RPR1 to LPU5

(a) Canonical Discriminant Function

FUNCTION	EIGENVALUE	PERCENT OF VARIANCE	CUMULATIVE PERCENT	CANONICAL CORRELATION
1*	0.22893	59.56	59.56	0.4316095
2*	0.10586	27.54	87.10	0.3093927
3*	0.03200	8.35	95.45	0.1763340
4*	0.01750	4.55	100.00	0.1311490

(b) Structure Matrix

	FUNC 1	FUNC 2	FUNC 3	FUNC 4
LPU3	0.71983*	0.36331	0.27493	0.33267
LPR3	0.41215*	0.23977	0.39293	0.05866
RPU3	0.20771*	0.12973	0.05924	0.15586
LPU1	-0.04948*	0.00879	0.01250	0.04865
RPU4	0.12128	0.57478*	0.24953	0.04419
LPU4	0.11731	0.32200*	0.10259	0.04752
LPU5	0.06859	0.30974*	0.05752	0.10344
RPU5	0.04351	0.30615*	0.09427	0.01284
RPR3	0.11987	0.22322	0.57408*	0.43844
RPU2	0.31151	0.02469	0.43950*	0.23763
LPR5	-0.05512	0.11007	0.21372*	0.13766
LPU2	0.17499	0.04939	0.17532*	0.05224
RPR2	-0.20601	-0.18794	0.10966	0.76300*
RPR4	-0.33413	0.27425	-0.01120	0.71790*
LPR4	-0.07577	0.15552	0.10839	0.40843*
LPR2	-0.21459	0.03724	0.15057	0.36857*
RPR5	-0.13216	0.11186	0.19542	0.28264*
RPR1	-0.09091	-0.02579	0.17924	0.25029*
LPR1	-0.08076	-0.00595	0.14692	0.14362*

(c) F Statistics and significances between groups

GROUP	1	2	3	4
2	4.6574 0.0000			
3	5.1216 0.0000	2.9911 0.0033		
4	1.3910 0.2011	1.0500 0.3993	2.1706 0.0305	
5	0.78283 0.6182	0.72137 0.5726	1.4074 0.1940	0.83246 0.5743

- Code Group
 1 Controls
 2 Darier's Subjects
 3 Darier's 1st Relatives
 4 Darier's Children
 5 Darier's Spouses

Figure 8.41 - Territorial Map - Males: RPR1 to LPU5

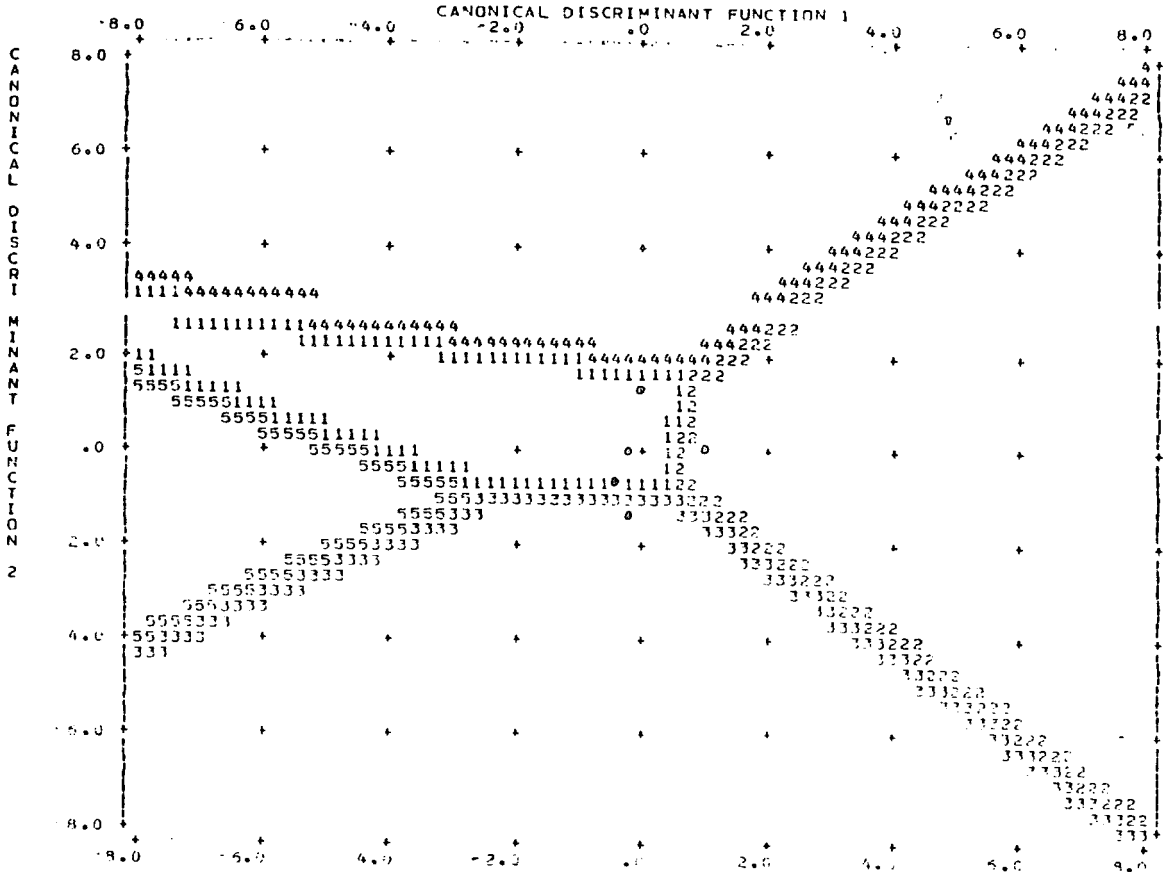

Code	Group
1	Controls
2	Darier's Subjects
3	Darier's 1 ^o Relatives
4	Darier's Children
5	Darier's Spouses

Table 8.190 - Males: RPR1 to LPU5

CLASSIFICATION RESULTS -

ACTUAL GROUP	NG. OF CASES	PREDICTED GROUP MEMBERSHIP				
		1	2	3	4	5
GROUP 1	191	128 67.0%	32 16.8%	4 2.1%	24 12.6%	3 1.6%
GROUP 2	29	7 24.1%	10 34.5%	4 13.8%	8 27.6%	0 0.0%
GROUP 3	16	5 31.3%	2 12.5%	5 31.3%	3 18.8%	1 6.3%
GROUP 4	8	4 50.0%	0 0.0%	0 0.0%	4 50.0%	0 0.0%
GROUP 5	6	3 50.0%	1 16.7%	0 0.0%	1 16.7%	1 16.7%

PERCENT OF "GROUPED" CASES CORRECTLY CLASSIFIED: 59.20%

Table 8.191 - Females:RPR1 to LPU5

(a) Canonical Discriminant Functions

FUNCTION	EIGENVALUE	PERCENT OF VARIANCE	CUMULATIVE PERCENT	CANONICAL CORRELATION
1*	0.17911	49.31	49.31	0.3897449
2*	0.11435	31.48	80.79	0.3203381
3*	0.05831	16.05	96.84	0.2347237
4*	0.01149	3.16	100.00	0.1065777

(b) F Statistics and significances between groups

GROUP	1	2	3	4
2	3.9707 0.0001			
3	2.1684 0.0207	2.5539 0.0043		
4	1.4463 0.1513	1.6405 0.0965	2.0513 0.0286	
5	0.53552 0.8639	0.89586 0.5369	0.40007 0.9457	0.74298 0.6335

Code	Group
1	Controls
2	Darier's Subjects
3	Darier's 1 st Relatives
4	Darier's Children
5	Darier's Spouses

(c) Structure Matrix

	FUNC 1	FUNC 2	FUNC 3	FUNC 4
LPU5	-0.58786*	0.01157	-0.02475	-0.20380
LPU4	-0.57337*	0.27235	0.06893	0.13701
LPR4	0.41840*	0.01221	0.39977	0.09037
RPR4	0.40319*	-0.14562	-0.11895	0.28357
LPR5	0.30792*	-0.04236	0.07711	0.18767
RPR3	0.24374*	0.18984	-0.05358	0.06470
RPR5	0.22072*	0.01386	-0.08325	0.08060
LPR3	0.21832*	-0.05435	0.18382	-0.10233
RPR2	0.11087	0.20048*	0.10939	-0.08201
RPU5	0.06583	0.13563*	0.05244	0.03076
RPU3	-0.25370	-0.31673	0.47638*	0.36132
LPR2	0.34961	0.32527	0.39253*	-0.12672
RPR1	0.14320	0.06022	-0.36392*	0.09934
RPU1	-0.01890	0.12420	0.27381*	0.20674
LPU3	-0.17090	0.53806	0.15367	0.64643*
LPU2	0.01847	-0.05811	-0.01042	0.51239*
LPR1	0.20785	-0.26636	0.12507	0.42860*
RPU2	0.15520	0.02751	0.05019	0.17892*
RPU4	-0.10630	0.06187	0.10556	0.14253*
LPU1	-0.04627	0.03127	-0.03025	0.12615*

Figure 8.42 - Territorial Map - Females: RPR1 to LPU5

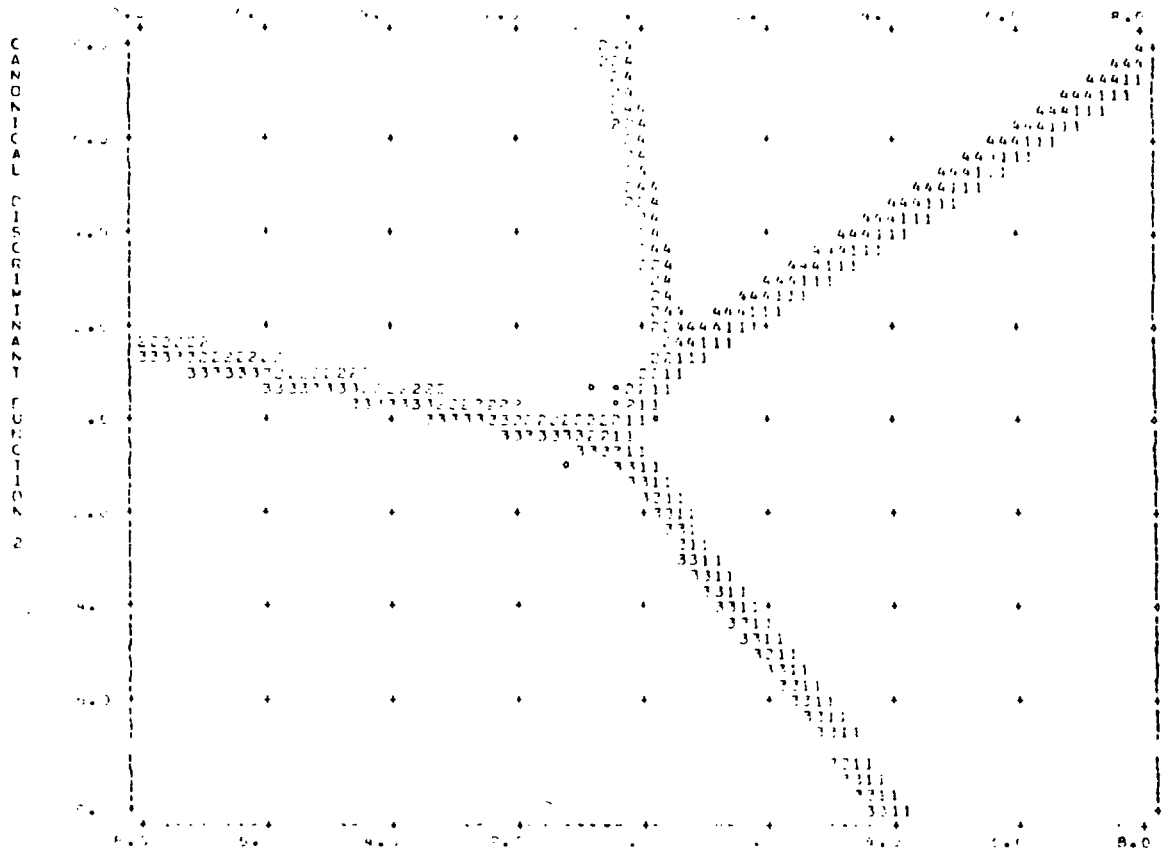

Code	Group
000	Controls
111	Darter's Subjects
222	Darter's Relatives
333	Darter's Children
444	Darter's Siblings

Table 8.192 - Females: RPR1 to LPU5

CLASSIFICATION RESULTS

ACTUAL GROUP	NO. OF CASES	PREDICTED GROUP MEMBERSHIP				
		1	2	3	4	5
GROUP 1	200	106 53.0%	27 13.5%	21 10.5%	20 10.0%	26 13.0%
GROUP 2	35	9 25.7%	12 34.3%	7 20.0%	3 8.6%	4 11.4%
GROUP 3	12	3 25.0%	0 0.0%	5 41.7%	1 8.3%	3 25.0%
GROUP 4	4	1 25.0%	0 0.0%	0 0.0%	2 50.0%	1 25.0%
GROUP 5	2	0 0.0%	0 0.0%	0 0.0%	0 0.0%	2 100.0%

PERCENT OF "GROUPED" CASES CORRECTLY CLASSIFIED: 50.20%

(iv) Finger Ridge Disturbances(a) Hyperlinearity

Darriers male subjects were found to have statistically significantly less hyperlinearity on finger I of both hands along with fingers III and V of the right hand in comparison to controls (Table 8.193a). Significantly lower hyperlinearity was also found on all fingers of the right hand as well as finger I of the left hand when compared to their unaffected relatives (Table 8.194).

Female Darier's patients, conversely, were found to have statistically significantly greater amounts of hyperlinearity on all ten fingers when compared to female controls (Table 8.193b).

(b) White Lines

Darriers males were found to have significantly less white lines on fingers I, III and V of the right hand in comparison to controls (Table 8.195a). They were also found to have significantly reduced occurrence of white lines in comparison to unaffected relatives on finger I of both hands and fingers III, IV and V of the right hand (Table 8.196).

Female Darriers patients were found to have significantly higher occurrence of white lines on all fingers of the left hand when compared to female controls (Table 8.195b).

(c) Ridge Atrophy

Highly significantly greater amounts of atrophy were found for both males and females Darriers patients on both hands in comparison to control subjects (Table 8.197). Statistically significantly higher amounts of atrophy were found for male patients on the left hand and female patients on the right hand when compared to their unaffected relatives (Table 8.198)

Discriminant function analysis was carried out for males using variables LW1 to RH5 and four canonical discriminant functions were produced (Table 8.199a). Function 1 accounted for 41.78% of the total variance and was composed solely of hyperlinearity on finger II of the right hand. Function 2 was composed of hyperlinearity on fingers III and IV of both hands and white line occurrence on L II (Table 8.199c). The territorial map (Figure 8.43) shows control males in the centre with the other groups arranged around them. Classification was found to be 42.48% (Table 8.200) with Darriers males being 62.5% correctly classified.

Four canonical discriminant functions were produced by discriminant analysis with Function 1 accounting for 65.15% of the variance and being composed of hyperlinearity on fingers I, II, III and IV of the left hand. Function 2 contains all of the rest of the hyperlinearity variables apart from RH2 (Table 8.201c). The best separated groups were found to be controls and Darriers females ($F = 8.1464$) as shown in Table 8.201b. The territorial map shows controls and Darriers females to be the furthest apart with unaffected relatives mid way between them. Darriers children and spouses are removed upwards and downwards respectively from the other groups (Figure 8.44). Classification was found to be 59.16% correct with Darier's females having 47.4% classification (Table 8.202).



Table 8.193 - Finger Ridge Disturbances - Hyperlinearity: Dars. v Conts.

(a) Males

Variable	Cat.	Percentage Frequencies		M-W U Test Probability
		Dars.M.	Cont.M.	
LH1	0	87.5	71.4	0.0382*
	1	12.5	16.0	
	2	0.0	8.3	
	3	0.0	4.4	
RH1	0	87.5	70.4	0.0260*
	1	12.5	16.0	
	2	0.0	8.7	
	3	0.0	4.9	
RH3	0	93.8	78.6	0.0410*
	1	6.3	11.7	
	2	0.0	6.3	
	3	0.0	3.4	
RH5	0	93.8	74.3	0.0154*
	1	3.1	15.0	
	2	3.1	6.8	
	3	0.0	3.9	

Table 8.193 continued - Hyperlinearity

(b) Females

Variable	Cat.	Percentage Frequencies		M-W U Test Probability
		Dars.F.	Cont.F.	
LH1	0	47.4	64.0	0.0018**
	1	10.5	22.7	
	2	7.9	8.9	
	3	34.2	4.4	
LH2	0	50.0	70.9	0.0004**
	1	10.5	20.7	
	2	13.2	5.9	
	3	26.3	2.5	
LH3	0	55.3	70.9	0.0023**
	1	26	18.7	
	2	15.8	8.9	
	3	26.3	1.5	
LH4	0	52.6	68.0	0.0040**
	1	7.9	19.7	
	2	13.2	10.3	
	3	26.3	2.0	
LH5	0	50.0	64.5	0.0029**
	1	5.3	22.2	
	2	15.8	9.9	
	3	28.9	3.4	
RH1	0	52.6	64.0	0.0209*
	1	7.9	18.7	
	2	10.5	11.8	
	3	28.9	5.4	
RH2	0	55.3	73.4	0.0055**
	1	13.2	14.3	
	2	10.5	8.9	
	3	21.1	3.4	
RH3	0	52.6	70.4	0.0033**
	1	10.6	17.7	
	2	13.2	8.4	
	3	23.7	3.4	
RH4	0	50.0	67.5	0.0025**
	1	7.9	18.2	
	2	15.8	9.9	
	3	26.3	4.4	
RH5	0	47.4	64.0	0.0052**
	1	13.2	19.2	
	2	13.2	12.3	
	3	26.3	4.4	

Table 8.194 - Finger Hyperlinearity : Darriers v Unaffected Relatives

Males

Variable	Cat.	Percentage Frequencies		M-W U Test Probability
		Dars.M.	Un.Rel.M.	
LH1	0	87.5	66.7	0.0487*
	1	12.5	11.1	
	2	0.0	5.6	
	3	0.0	16.7	
RH1	0	87.5	61.1	0.0189*
	1	12.5	16.7	
	2	0.0	5.6	
	3	0.0	16.7	
RH2	0	90.6	66.7	0.0263*
	1	9.4	16.7	
	2	0.0	11.1	
	3	0.0	5.6	
RH3	0	93.8	55.6	0.0010**
	1	6.3	27.8	
	2	0.0	11.1	
	3	0.0	5.6	
RH4	0	87.5	55.6	0.0070**
	1	9.4	16.7	
	2	3.1	22.2	
	3	0.0	5.6	
RH5	0	93.8	55.6	0.0013**
	1	3.1	16.7	
	2	3.1	27.8	
	3	0.0	0.0	

Table 8.195 - Finger Ridge Disturbances - White Lines: Dars. v Conts.

(a) Males

Variable	Cat.	Percentage Frequencies		M-W U Test Probability
		Dars. M.	Cont. M.	
RW1	0	78.1	53.4	0.0100*
	1	12.5	30.1	
	2	9.4	10.2	
	3	0.0	6.3	
RW3	0	71.9	58.3	0.0341*
	1	21.9	28.2	
	2	6.3	9.7	
	3	0.0	3.9	
RW5	0	75.0	55.8	0.0367*
	1	18.8	31.6	
	2	3.1	8.3	
	3	3.1	4.4	

(b) Females

Variable	Cat.	Dars. F.	Cont. F.	
LW1	0	28.9	36.9	0.0084**
	1	18.4	36.5	
	2	26.3	19.7	
	3	26.3	6.9	
LW2	0	31.6	48.8	0.0046**
	1	28.9	33.0	
	2	18.4	13.3	
	3	21.1	4.9	
LW3	0	31.6	45.3	0.0042**
	1	23.7	35.0	
	2	21.1	15.3	
	3	23.7	4.4	
LW4	0	31.6	41.4	0.0226*
	1	28.9	37.4	
	2	13.2	15.8	
	3	26.3	5.4	
LW5	0	31.6	41.4	0.0432*
	1	31.6	35.0	
	2	10.5	18.2	
	3	26.3	5.4	

Table 8.196 - Finger Ridge Disturbances : White Lines - Darriers
v Unaffected Relatives - Males

Variable	Cat.	Percentage Frequencies		M-W U Test Results
		Dars.M.	Cont.M.	
LW1	0	65.6	44.4	0.0279*
	1	31.1	16.7	
	2	3.1	16.7	
	3	0.0	22.2	
RW1	0	78.1	44.4	0.0088**
	1	12.5	22.2	
	2	9.4	11.1	
	3	0.0	22.2	
RW3	0	71.9	27.8	0.0005**
	1	21.9	44.4	
	2	6.3	16.7	
	3	0.0	11.1	
RW4	0	71.9	38.9	0.0125*
	1	18.8	27.8	
	2	9.4	22.2	
	3	0.0	11.1	
RW5	0	75.0	38.9	0.0114*
	1	18.8	38.9	
	2	3.1	16.7	
	3	3.1	5.6	

Table 8.197 - Finger Ridge Atrophy : Dars. v Conts.

(a) Males

Variable	Cat.	Percentage Frequencies		M-W U Test Probability
		Dars.M.	Cont.M.	
LA	0	46.9	87.4	0.0000**
	1	18.8	7.3	
	2	21.9	5.3	
	3	12.5	0.0	
RA	0	56.3	83.9	0.0001**
	1	18.8	9.8	
	2	15.6	5.9	
	3	9.4	0.5	

(b) Females

Variable	Cat.	Dars.F.	Cont.F.	M-W U Test Probability
		0	34.2	
LA	1	15.8	10.8	0.0000**
	2	18.4	4.4	
	3	31.6	0.5	
	0	26.3	85.7	
RA	1	23.7	8.4	0.0000**
	2	23.7	5.9	
	3	26.3	0.0	

Table 8.198 - Finger Ridge Atrophy : Darriers v Unaffected Relatives

(a) Males

Variable	Cat.	Percentage Frequencies		M-W U Test Probability
		Dars.M.	Un.Rel.M.	
LA	0	46.9	77.8	0.0379*
	1	18.8	5.6	
	2	21.9	16.7	
	3	12.5	0.0	

(b) Females

RA	0	Dars.F.	Un.Rel.F.	0.0449*
		1	23.7	
2	23.7	15.4		
3	26.3	15.4		

Table 8.199 - Males: LW1 to RH5

(a) Canonical Discriminant Function

FUNCTION	EIGENVALUE	PERCENT OF VARIANCE	CUMULATIVE PERCENT	CANONICAL CORRELATION
1*	0.18437	41.78	41.78	0.3945507
2*	0.14244	32.28	74.06	0.3531035
3*	0.03402	19.04	93.10	0.2784007
4*	0.03045	6.90	100.00	0.1719057

(b) F Statistics and significances

GROUP	1	2	3	4
2	1.3394 0.1965			
3	2.4584 0.0048	2.5832 0.0030		
4	3.2995 0.0002	2.8763 0.0010	2.6912 0.0020	
5	2.0399 0.0216	1.6084 0.0895	1.5323 0.1129	3.5226 0.0001

Code Group
 1 Controls
 2 Darier's Subjects
 3 Darier's 1st Relatives
 4 Darier's Children
 5 Darier's Spouses

(c) Structure Matrix

	FUNC 1	FUNC 2	FUNC 3	FUNC 4
RH2	0.39890*	0.22573	0.31347	0.18860
RH4	0.30911	0.41465*	0.21222	0.13758
RH3	0.21648	0.36734*	0.33122	0.27546
LH3	0.00023	0.31727*	0.27156	0.27056
LW2	-0.11070	0.31617*	0.21370	0.00242
LH4	0.03975	0.20664*	0.18598	0.17590
RW5	-0.10494	0.17427	0.53396*	-0.15293
RW3	-0.02821	0.46002	0.46848*	-0.02397
RW1	0.33531	0.32748	0.44591*	0.14685
RW4	0.07431	0.41249	0.42848*	-0.06421
RH5	0.13863	0.32997	0.41791*	0.20101
RH1	0.27612	0.23900	0.39242*	0.28776
LW5	0.04060	0.16192	0.37472*	-0.02186
LW1	0.14429	0.24373	0.37250*	0.07297
LW4	0.06661	0.38079	0.33304*	0.10011
LH1	0.21517	0.20566	0.31000*	0.27319
LW3	-0.06386	0.25158	0.30944*	0.03116
RW2	0.19218	0.12489	0.25124*	0.09814
LH5	0.10482	0.20890	0.21710*	0.15049
LH2	0.12776	0.32501	0.19271	0.34570*

Figure 8.43 - Males: LW1 to RH5

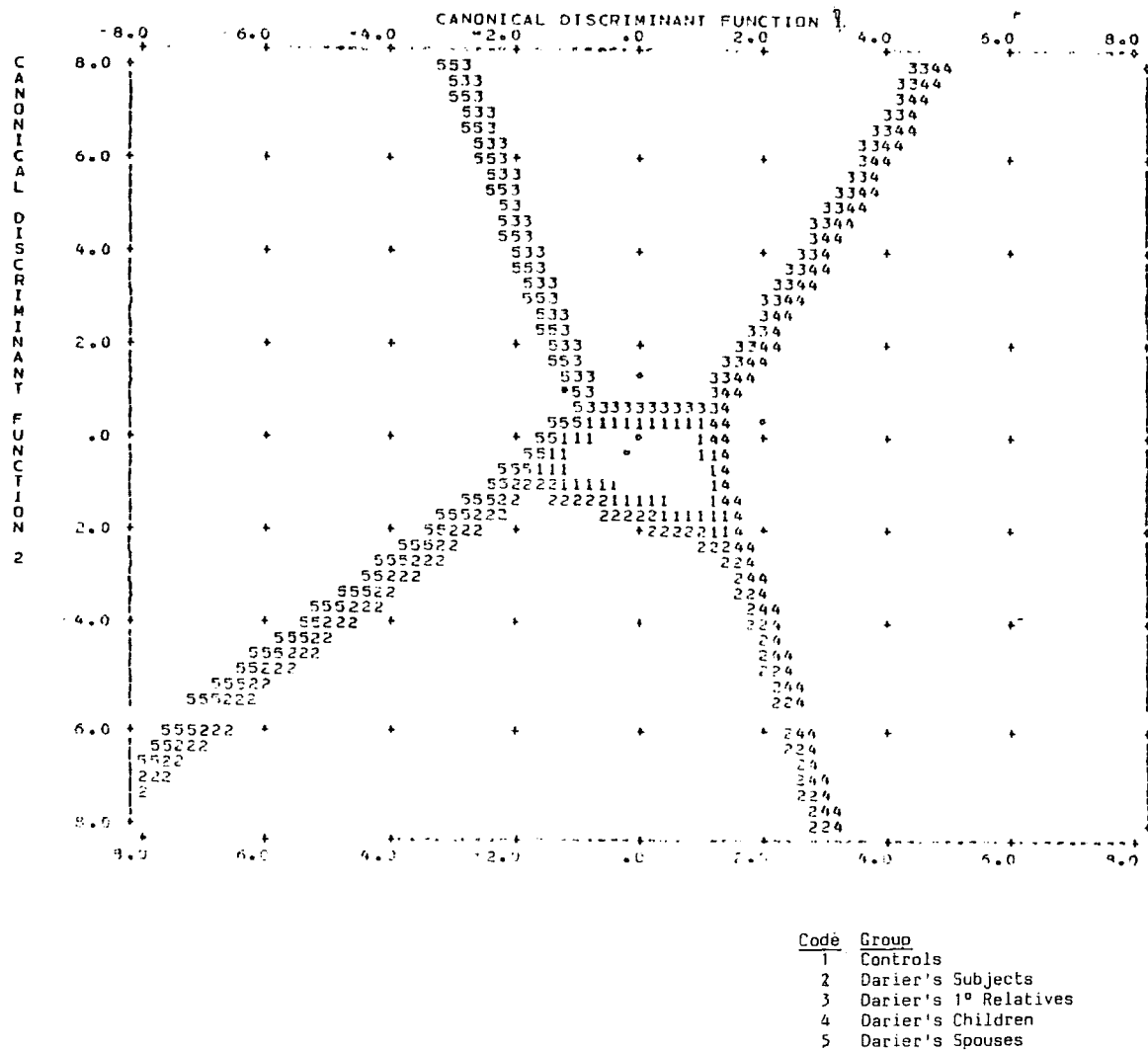

Table 8.200 - Malés: LW1 to RH5

CLASSIFICATION RESULTS

ACTUAL GROUP	NO. OF CASES	PREDICTED GROUP MEMBERSHIP				
		1	2	3	4	5
GROUP 1	200	78 39.0%	94 47.0%	19 9.5%	4 2.0%	5 2.5%
GROUP 2	32	4 12.5%	20 62.5%	2 6.3%	2 6.3%	4 12.5%
GROUP 3	18	2 11.1%	6 33.3%	8 44.4%	1 5.6%	1 5.6%
GROUP 4	9	1 11.1%	4 44.4%	1 11.1%	3 33.3%	0 0.0%
GROUP 5	7	0 0.0%	3 42.9%	0 0.0%	0 0.0%	4 57.1%

PERCENT OF "GROUPED" CASES CORRECTLY CLASSIFIED: 42.48%

(a) Canonical Discriminant Functions

FUNCTION	EIGENVALUE	PERCENT OF VARIANCE	CUMULATIVE PERCENT	CANONICAL CORRELATION
1*	0.24311	65.15	65.15	0.4458550
2*	0.08192	21.51	86.67	0.2751700
3*	0.03291	8.64	95.31	0.1784892
4*	0.01787	4.69	100.00	0.1324915

(b) F Statistics and significances

GROUP	1	2	3	4
2	3.1464 0.0000			
3	1.5428 0.1533	1.1983 0.3042		
4	2.6573 0.0114	3.0964 0.0038	2.5664 0.0143	
5	1.7729 0.0932	1.3867 0.2113	1.1318 0.3436	2.5286 0.0157

Code	Group
1	Controls
2	Darier's Subjects
3	Darier's 1 st Relatives
4	Darier's Children
5	Darier's Spouses

(c) Structure Matrix

	FUNC 1	FUNC 2	FUNC 3	FUNC 4
LH2	0.70679*	0.08477	0.03014	0.48421
LH3	0.64928*	0.11227	0.21525	0.40366
LH4	0.59921*	0.10220	0.23883	0.34847
LH1	0.59669*	0.03002	0.06793	0.37491
LH5	0.58964*	0.14978	0.16661	0.41679
RH4	0.53014*	0.05462	0.27744	0.23233
RH3	0.47458*	0.02322	0.18540	0.39282
RH5	0.45403*	0.05659	0.34386	0.26992
RH1	0.43275*	0.14056	0.11728	0.37309
LW3	0.46607	0.03889	0.60793*	0.58163
RW5	0.18744	0.27583	0.59025*	0.50729
LW4	0.40681	0.09824	0.55700*	0.54669
RW3	0.21941	0.22091	0.27333	0.74337*
RW2	0.10623	0.05996	0.32238	0.60878*
RW4	0.28317	0.18280	0.40508	0.59956*
LW5	0.34210	0.14549	0.48713	0.56265*
LW2	0.41526	0.09009	0.39575	0.56159*
RW1	0.15405	0.11268	0.34267	0.52372*
LW1	0.33940	0.15509	0.36371	0.52135*
RH2	0.44795	0.29913	0.16577	0.50642*

Figure 8.44 - Females: LW1 to RH5

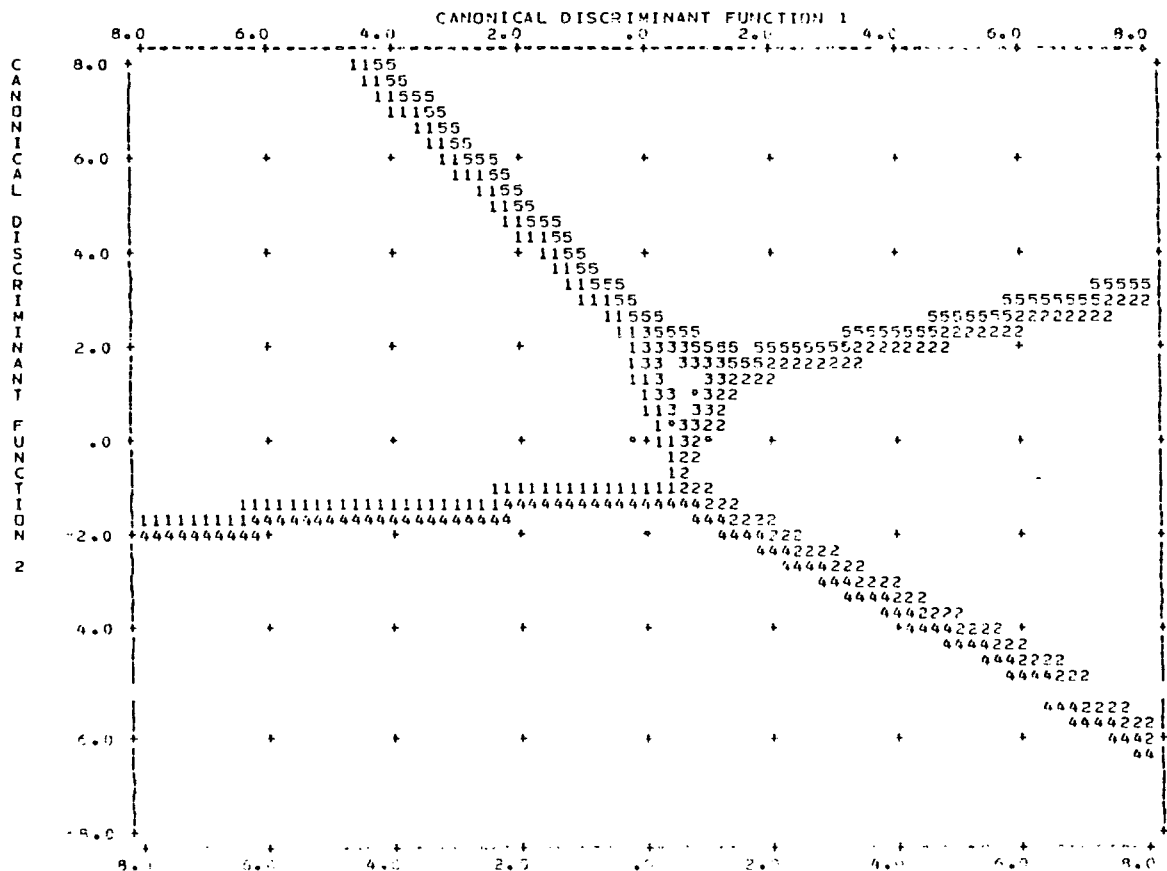

Code	Group
1	Controls
2	Darier's Subjects
3	Darier's 1° Relatives
4	Darier's Children
5	Darier's Spouses

Table 8.202 - Females: LW1 to RH5

CLASSIFICATION RESULTS

ACTUAL GROUP	NO. OF CASES	PREDICTED GROUP MEMBERSHIP				
		1	2	3	4	5
GROUP 1	201	131 65.2%	18 9.0%	34 16.9%	8 4.0%	10 5.0%
GROUP 2	38	14 36.8%	18 47.4%	3 7.9%	0 0.0%	3 7.9%
GROUP 3	13	4 30.8%	4 30.8%	2 15.4%	1 7.7%	2 15.4%
GROUP 4	7	4 57.1%	1 14.3%	0 0.0%	2 28.6%	0 0.0%
GROUP 5	3	1 33.3%	0 0.0%	0 0.0%	0 0.0%	2 66.7%

PERCENT OF "GROUPED" CASES CORRECTLY CLASSIFIED: 59.16%

(v) Palmar Patterns

Darier's males were found to have a statistically significantly lower occurrence of peripheral hypothenar patterns on the right hand when compared to both controls and to their unaffected relatives (Table 8.203a and 8.204).

Darier's females were found to have significantly higher frequency of occurrence of peripheral thenar, peripheral 2, radial hypothenar and parthenar patterns on the right hand and parathenar and hypothenar radial arches on the left hand when compared to control females (Table 8.203b).

Discriminant analysis using the palmar pattern variables was carried out for males and females. For male subjects, four canonical discriminant functions were produced with Function 1 accounting for 54.97% of the variance and Function 2 another 24.85%. Function 1 was composed of two variables both on the right hand, U4R and HRAR whilst Function 2 contained ten variables (Table 8.205). The territorial map shows Dariers and controls to be close together and spouses and unaffected relatives to be removed the most (Figure 8.44). This is also reflected in the Table of F Statistics and significances (Table 8.205C).

Classification results show 48.69% correct classification of cases with Dariers males being 59.4% correct (Table 8.206).

For female subjects, Canonical Discriminant Function 1 accounted for 44.45% of the variance and was composed of seven variables and Function 2 accounted for a further 32.99% of the variance and was composed of ten variables (Table 8.207a and b). The territorial map shows controls and spouses to be close together with Dariers their children and unaffected relatives removed to the right (Figure 8.45). Classification results show 68.82% correct classification with Dariers femaels being only 27% correct. (Table 8.208).

Table 8.203 - Palmar Patterns: Dars. V Conts.

(a) Males

Variable	Cat.	Percentage Frequencies		M-W U Test Probability
		Dars.M.	Cont.M.	
PHR	0	100.0	87.3	0.0308*
	1	0.0	12.7	

(b) Females

Variable	Cat.	Dars.F.	Cont.F.	M-W U Test Probability
		PTR	0	
	1	16.2	5.9	
P2R	0	91.9	98.0	0.0426*
	1	8.1	2.0	
RHR	0	91.9	98.5	0.0182*
	1	8.1	1.5	
PARR	0	97.3	100.0	0.0195*
	1	2.7	0.0	
PARL	0	97.3	100.0	0.0195*
	1	2.7	0.0	

Table 8.204 - Palmar Pattern Occurrence: Darriers v Unrelated Relatives

Males

Variable	Cat	Percentage Frequencies		M-W U Test Probability
		Dars.M.	Un.Rel.M.	
PHR	0	100.0	83.3	0.0184*
	1	0.0	16.7	

Table 8.205 - Males: PTL to HRAR

(a) Canonical Discriminant Function

FUNCTION	EIGENVALUE	PERCENT OF VARIANCE	CUMULATIVE PERCENT	CANONICAL CORRELATION
1*	0.43527	54.97	54.97	0.5506934
2*	0.19676	24.85	79.81	0.4054755
3*	0.10715	13.53	93.34	0.3113959
4*	0.05272	6.66	100.00	0.2237847

(b) Structure Matrix

	FUNC 1	FUNC 2	FUNC 3	FUNC 4
U4R	0.66006*	0.12560	0.05293	0.21529
HRAR	0.43722*	0.03946	0.08276	0.15494
U4L	0.14331	0.52882*	0.22212	0.00366
PTL	0.04880	0.31768*	0.13264	0.29191
C3R	-0.05365	0.29660*	0.20534	0.08885
C4L	-0.06975	0.26594*	0.07877	-0.00366
RTL	-0.02710	0.17314*	0.02177	-0.10890
RHR	0.08702	0.17004*	0.03449	0.10820
PTR	-0.06425	0.16500*	0.14437	-0.11112
P3R	-0.02589	0.07668*	0.06955	-0.05407
RHL	0.01873	0.06822*	0.02542	0.01325
C4R	0.03491	0.06067*	0.04152	0.05835
P2L	-0.06165	0.14340	-0.44828*	0.28442
CHR	-0.04123	0.05159	-0.43448*	-0.07153
P4L	0.06768	0.01238	0.32613*	0.17833
PHL	0.16540	-0.01794	0.27617*	0.01609
P3L	*0.07838	-0.16856	0.21715*	0.20980
CHL	0.03854	-0.12162	*0.14108*	0.09015
HARL	0.01983	0.10698	0.11096*	0.04622
C3L	*0.01139	-0.06145	0.06375*	0.02655
P2R	*0.11203	0.37957	-0.29755	0.38204*
PHR	*0.10338	0.02085	0.32768	0.36424*
P4R	*0.07481	-0.10537	*0.13814	0.20573*
RTR	*0.01981	0.13962	*0.02549	*0.13968*

(c) F Statistics and significances

Code	Group
1	Controls
2	Darier's Subjects
3	Darier's 1° Relatives
4	Darier's Children
5	Darier's Spouses

GROUP	1	2	3	4
2	1.3944 0.1496			
3	3.0256 0.0001	2.0656 0.0104		
4	1.3802 0.1513	0.94742 0.5156	1.7823 0.0340	
5	6.5093 0.0000	5.4496 0.0000	6.1852 0.0000	5.1096 0.0000

Figure 8.44 - Males: PTL to HRAR

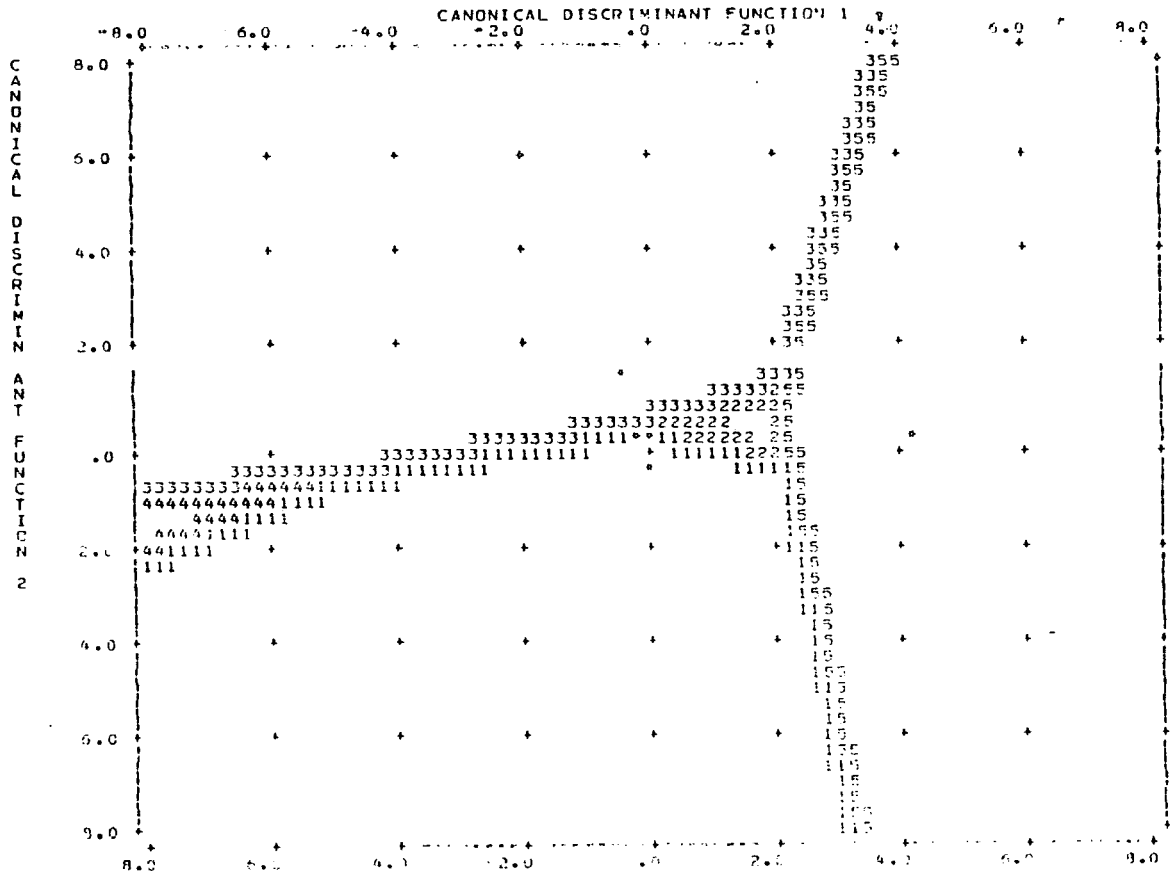

Code	Group
1	Controls
2	Darier's Subjects
3	Darier's 1 st Relatives
4	Darier's Children
5	Darier's Spouses

Table 8.206 - Males: PTL to HRAR

CLASSIFICATION		RESULTS					
ACTUAL	GROUP	NO. OF CASES	PREDICTED GROUP MEMBERSHIP				
			1	2	3	4	5
GROUP	1	200	98 49.0%	71 35.5%	9 4.5%	21 10.5%	1 0.5%
GROUP	2	32	7 21.9%	19 59.4%	3 9.4%	3 9.4%	0 0.0%
GROUP	3	18	4 22.2%	6 33.3%	7 38.9%	1 5.6%	0 0.0%
GROUP	4	11	0 0.0%	6 54.5%	1 9.1%	4 36.4%	0 0.0%
GROUP	5	6	1 16.7%	3 50.0%	0 0.0%	0 0.0%	2 33.3%

PERCENT OF "GROUPED" CASES CORRECTLY CLASSIFIED: 48.69%

Table 8.207 - Females: PTL to HRAR

(a) Canonical Discriminant Function

FUNCTION	EIGENVALUE	PERCENT OF VARIANCE	CUMULATIVE PERCENT	CANONICAL CORRELATION
1*	0.15350	44.45	44.45	0.3647917
2*	0.11394	32.99	77.44	0.3198259
3*	0.05462	15.82	93.26	0.2275735
4*	0.02328	6.74	100.00	0.1558266

(b) Structure Matrix

	FUNC 1	FUNC 2	FUNC 3	FUNC 4
HARL	0.84087*	0.06523	-0.24442	0.14116
HRAR	0.50462*	0.01872	-0.08511	0.12071
PHR	0.28852*	-0.17383	-0.01248	-0.13184
U4R	0.20971*	0.04291	0.15525	-0.03444
P2L	0.20176*	0.10236	0.18384	-0.01438
PHL	0.16855*	-0.06461	0.05658	-0.01659
C4L	0.10039*	-0.05412	0.04608	-0.03189
PARL	0.01171	0.73963*	0.45980	0.07588
PARR	0.01171	0.73963*	-0.45980	-0.07588
P3L	0.12531	-0.40620*	0.14484	-0.15629
P4L	-0.01807	0.27393*	-0.15381	0.06814
P3R	0.13516	0.21074*	0.10424	-0.00782
P4R	0.00600	0.13396*	-0.01466	0.00419
CHR	-0.04190	0.07566*	0.00389	-0.04420
UHTR	-0.01985	0.03418*	0.02811	0.00825
C3L	-0.01400	0.02411*	-0.01983	0.00582
RHR	0.09615	0.28721	0.53410*	0.02938
PTR	0.17750	0.18286	0.50505*	-0.04881
P2R	0.28739	0.15083	0.30981*	0.02564
PTL	0.08125	0.09512	0.30916*	-0.08871
U4L	0.25137	0.11870	0.28969*	0.00067
RHL	0.02636	0.05636	0.24904*	0.10417
C4R	0.02790	0.05821	0.11008*	0.08116
RTL	0.08825	0.04361	0.24935	0.86027*
RTR	0.06333	0.05787	0.22722	0.62532*
CHL	-0.06694	0.04501	0.10810	0.11744*

(c) F Statistics and significances

GROUP	1	2	3	4
2	2.7669 0.0042			
3	3.9108 0.0001	2.9254 0.0025		
4	2.3982 0.0127	1.8897 0.0539	3.4153 0.0006	
5	0.67961 0.7271	0.96149 0.4726	1.5257 0.1392	1.0980 0.3720

Figure 8.45 - Females: PTL to HRAR

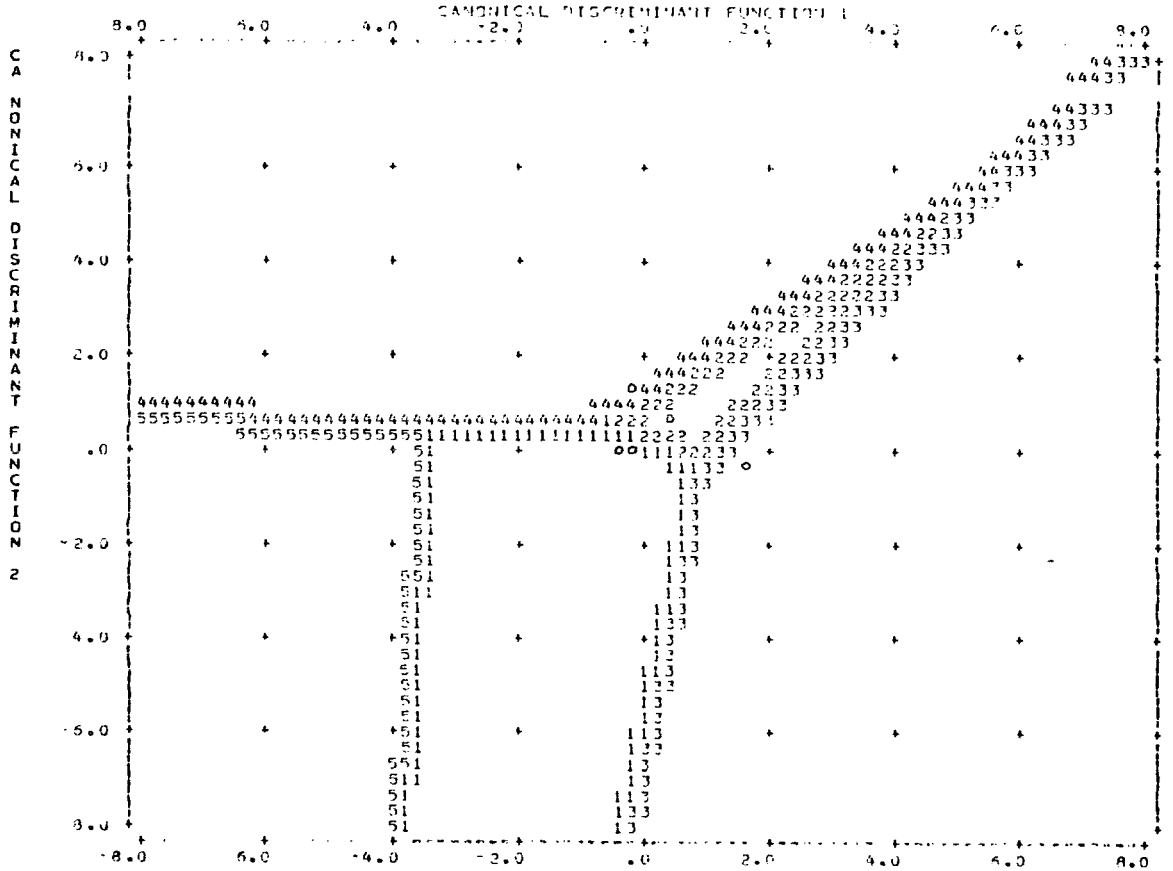

Code	Group
1	Controls
2	Darier's Subjects
3	Darier's 1 st Relatives
4	Darier's Children
5	Darier's Spouses

Table 8.208 - Females: PTL to HRAR

CLASSIFICATION RESULTS

ACTUAL GROUP	NO. OF CASES	PREDICTED GROUP MEMBERSHIP				
		1	2	3	4	5
GROUP 1	202	164 81.2%	18 8.9%	10 5.0%	0 0.0%	10 5.0%
GROUP 2	37	23 62.2%	10 27.0%	2 5.4%	1 2.7%	1 2.7%
GROUP 3	13	7 53.8%	0 0.0%	5 38.5%	0 0.0%	1 7.7%
GROUP 4	8	7 87.5%	0 0.0%	0 0.0%	1 12.5%	0 0.0%
GROUP 5	3	2 66.7%	0 0.0%	0 0.0%	0 0.0%	1 33.3%

PERCENT OF "GROUPED" CASES CORRECTLY CLASSIFIED: 68.82%

(vi) Palmar Triradii

Darier's females were found to have a significantly higher occurrence of accessory triradii in I_2 of the right hand in comparison to controls. They were found to have significantly lower occurrence of t and t' on the left hand and t on the right hand, along with a significantly higher occurrence of t' on the right hand when compared to controls.

Darier's males were found to have a significantly lower occurrence of t" in comparison to their unaffected relatives (Tables 8.209 and 8.210).

Female Darier's patients were found to have significantly higher maximal atd angles on the left hand and for both the angles on both hands summed when compared to controls (Table 8.211).

Table 8.209 - Palmar Triradii: Females - Dairiers v Controls

Variable	Cat.	Percentage Frequencies		M-W U Test Probability
		Dars.F.	Cont.F.	
RX2	0	91.9	98.0	0.0426*
	1	8.1	2.0	
LTO	0	52.8	29.6	0.0056**
	1	47.2	70.4	
LT1	0	38.9	63.1	0.0066**
	1	61.1	36.5	
	2	0.0	0.5	
RT	0	54.1	27.6	0.0013**
	1	45.9	72.4	
RT1	0	40.5	69.0	0.0008**
	1	59.5	31.0	

Table 8.210 - Axial Triradii Variants : Dairiers v Unrelated Relatives

Males

Variable	Cat.	Percentage Frequencies		M-W U Test Probability
		Dars.M.	Un.Rel.M.	
RTII	0	96.9	77.8	0.0324*
	1	3.1	22.2	

Table 8.211 - Maximal atd angles : Dairiers v Controls

Females

Variable	Dairiers F.		Controls F.		M-W U Test Probability
	Mean	± S.D.	Mean	± S.D.	
LATD	45.250	8.600	42.103	7.884	0.0111*
SATD	87.943	14.353	82.616	12.751	0.0120*

(vii) Palmar Ridge Disturbances

Male and female Darier's disease patients were found to have statistically highly significantly greater palmar atrophy on both hands when compared to both controls and to their unaffected first degree relatives (Tables 8.212 and 8.213). Female Darier's patients, in addition, were found to have highly significantly greater hyperlinearity of the palms compared to control subjects (Table 8.212b).

Table 8.212 - Palmar Ridge Disturbances

(a) Males

Variable	Cat.	Percentage Frequencies		M-W U Test Probability
		Dars.M.	Cont. M.	
ATRL	0	46.9	87.9	0.0000**
	1	15.6	11.2	
	2	18.8	1.0	
	3	18.8	0.0	
ATRR	0	43.8	89.3	0.0000**
	1	18.8	8.3	
	2	18.8	2.4	
	3	18.8	0.0	

(b) Females

Variable	Cat.	Dars.F.	Cont.F.	M-W U Test Probability
ATRL	0	26.3	79.8	0.0000**
	1	15.8	17.7	
	2	26.3	2.0	
	3	31.6	0.5	
ATRR	0	28.9	79.3	0.0000**
	1	21.1	18.2	
	2	21.1	2.5	
	3	28.9	0.0	
HYLP	0	21.1	31.5	0.0001**
	1	7.9	32.0	
	2	28.9	27.1	
	3	42.1	9.4	
HYRP	0	18.4	33.2	0.0000**
	1	15.8	29.2	
	2	18.4	31.2	
	3	47.4	6.4	

Table 8.213 - Palmar Ridge Atrophy - Darriers v Unrelated Relatives

(a) Males

Variable	Cat.	Percentage Frequencies		M-W U Test Probability
		Dars.M.	Un.Rel.M.	
ATRL	0	46.9	77.8	0.0215*
	1	15.6	16.7	
	2	18.8	0.0	
	3	18.8	5.7	
ATRR	0	43.8	72.2	0.0266*
	1	18.8	22.2	
	2	18.8	0.0	
	3	18.8	5.6	

(b) Females

Variable	Cat.	Dars.F.	Un.Rel.F.	
ATRL	0	26.3	61.5	0.0046**
	1	15.8	23.1	
	2	26.3	15.4	
	3	31.6	0.0	
ATRR	0	28.9	69.2	0.0111*
	1	21.1	15.4	
	2	21.1	7.7	
	3	28.9	7.7	

(viii) Pits and Plaques

A very common feature, found only in the affected Darier's patients was pitting of the epidermal ridges and their coalescence into plaques. The pits were such a noticeable feature that it was decided to quantify the pitting on various parts of the hand. A system of scoring for degree of severity of pits and plaques was therefore used for the various palmar areas and each fingertip. The methodology and data recording sheet are included in Appendix 5. It was found that Darier's patients, both males and females, had a statistically highly significantly greater occurrence of pits and plaques on all areas when compared to controls, unaffected first degree relatives and spouses. It appeared to be possible to distinguish Darier's patients from others by looking for the pitting of the ridges. Dr. C. Munro, therefore, printed a group of Darier's patients, some spouses, unaffected relatives, normal controls from hospital staff and a number of blinds. The last group consisted of patients with other common hyperkeratotic diseases i.e. lichen nitidus and punctate keratoderma. No identification was put on the prints yet it was possible to identify with certainty all of the Darier's patients. In fact using this method detection of patients with Darier's disease was found to be 100% correct. In addition four children, each with a Darier's parent, who at that time were undiagnosed, were recognised by looking only at pitting of the prints, as being Darier's sufferers. Subsequently Dr. Munro confirmed that these four had Darier's disease and another four who had no pitting were later diagnosed as being unaffected.

CHAPTER NINE : DISCUSSION AND CONCLUSIONS

9.1 Introduction

In this chapter a discussion of the results, which were presented in the previous three chapters, is carried out with the various trends being highlighted and conclusions formulated. In the first part of the chapter the traditional approach used in dermatoglyphic studies of medical disorders is adopted to examine the findings for each of the individual skin disorders studied. Comparisons are carried out with the appropriate groups of normal controls. The findings of this study for each of the disorders are also compared and contrasted with those of other researchers as presented in detail in Chapter Two.

The question as to whether or not the various groups of disorders can be regrouped into larger 'families of disorder' using the dermatoglyphic variables of the study is examined in the second part of this chapter. The results of discriminant analysis are used and also the most important discriminating factors overall are determined from the Factor Analysis results.

The third part of the chapter focuses attention on the physical effects which the disorders are producing on the epidermal ridges e.g. hyperlinearity, white lines, atrophy, pitting. Prominent ridge disturbances for some of the disorders are highlighted and analysed. Their value as a diagnostic aid for assessing a particular disorder or their use as a means of detecting carrier status is evaluated.

Next the findings and conclusions made are related to the original aims and objectives of the study as set out in the Introduction. General overall conclusions are stated in this section.

Finally, a critical appraisal of the overall study is carried out. Suggestions are made as to how the study, with the benefit of hindsight, could have been improved. Any apparent omissions and areas worthy of further investigation are also identified and discussed in this section.

9.2 Individual Skin Disorders

In this section the "Disease Approach" to analysis (David 1971) is used. The findings for individual disorders are compared to

CHAPTER NINE : DISCUSSION AND CONCLUSIONS

9.1 Introduction

In this chapter a discussion of the results, which were presented in the previous three chapters, is carried out with the various trends being highlighted and conclusions formulated. In the first part of the chapter the traditional approach used in dermatoglyphic studies of medical disorders is adopted to examine the findings for each of the individual skin disorders studied. Comparisons are carried out with the appropriate groups of normal controls. The findings of this study for each of the disorders are also compared and contrasted with those of other researchers as presented in detail in Chapter 2.

The question as to whether or not the various groups of disorders can be regrouped into larger 'families of disorder' using the dermatoglyphic variables of the study is examined in the second part of this chapter. The results of discriminant analysis are used and also the most important discriminating factors overall are determined from the Factor Analysis results.

The third part of the chapter focuses attention on the physical effects which the disorders are producing on the epidermal ridges e.g. hyperlinearity, white lines, atrophy, pitting. Prominent ridge disturbances for some of the disorders are highlighted and analysed. Their value as a diagnostic aid for assessing a particular disorder or their use as a means of detecting carrier status is evaluated.

Next the findings and conclusions made are related to the original aims and objectives of the study as set out in the Introduction. General overall conclusions are stated in this section.

Finally, a critical appraisal of the overall study is carried out. Suggestions are made as to how the study, with the benefit of hindsight, could have been improved. Any apparent omissions and areas worthy of further investigation are also identified and discussed in this section.

9.2 Individual Skin Disorders

In this section the "Disease Approach" to analysis (David 1971) is used. The findings for individual disorders are compared to

appropriate groups of control subjects. Comparisons are made to research work cited in Chapter 3.

(a) Psoriasis

(i) Finger Patterns

No statistically significant differences were found for either male or female psoriatic patients in comparison to control subjects for occurrence of the various types of digital patterns. Statistically significant increases in whorls in psoriatic patients of both sexes compared to controls were reported by Krieger (1934), Verbov (1968), Gibbs and Warburton (1968), Saha (1969), Jilek (1972), Sharma et al (1977), Lal (1977) and Kapur and Verma (1982). In this study male psoriatics were found to have an increased occurrence of whorls on all fingers, except finger V, of the left hand and on fingers IV and V of the right hand. The differences did not, however, reach the level of statistical significance. Female psoriatics showed an increased incidence of whorls on all fingers except finger I on the left hand and finger V of the right hand. Again, however, the results were not significant statistically. The highest occurrence of whorls was found in both sexes of psoriatics, to be on finger IV with the right hand having the greatest incidence. These findings agree with those of the above named researchers. Jilek (1972) and Sharma et al (1977) reported significant increases in loop occurrence and Banach (1977) reported an increase in arches. No significant increases of either were found in this study.

Significant differences were found in this study for ulnar and radial loop scores in psoriatics when compared to controls. Male psoriatics were found to have an increased ulnar loop score on finger I of the left hand and an increased radial loop score on finger II of the same hand. Female psoriasis patients were found to have increased radial loop scores on fingers I, II, III and IV of the right hand and an increase ulnar loop score on finger V of the same hand. A decreased ulnar loop score was also found in female psoriatics on finger II of the right hand.

(ii) Finger Ridge Counts

Male psoriatics were found to have no statistically significant difference in comparison to controls for any of the finger ridge counts.

A higher ulnar ridge count which was statistically significantly greater in female psoriatics than in female controls was found on finger II of the right hand. A significantly lower ulnar ridge count was found on finger IV and significantly lower radial counts were found on fingers V of both hands and finger II of the right hand in female psoriatics. Significantly lower unilateral ridge counts were found on fingers V of both hands and significantly lower absolute ridge count (left hand), summed unilateral and summed absolute ridge counts were found on finger V of both hands combined in psoriatic females.

Jilek (1972), Verma et al (1980) and Singh et al (1983) reported higher total ridge counts, in both sexes of psoriatics, which were found to be statistically significant. In this study higher total finger absolute counts were found in both sexes of psoriatics in comparison to controls but the differences were not found to be statistically significant.

(iii) Palmar Patterns

Male psoriatics were found to have significantly increased incidence of peripheral patterns on the hypothenar and I_3 areas of the left hand. A significantly increased occurrence of radial pattern on the hypothenar and decreased peripheral pattern incidence on I_4 of the left hand were also found in psoriatic males. Female psoriatics were found to have significantly increased occurrence of peripheral hypothenar and significantly decreased incidence of peripheral I_4 pattern also on the left hand.

Banach (1977) reported the same significant decrease on I_4 of both sexes. Singh et al (1983) reported an increase of hypothenar and I_3 patterns but Krieger (1934) found a decrease in hypothenar pattern occurrence on the left hand.

In this study male psoriatics showed a significant increase in Interdigital Pattern Intensity Index on the right hand. This variable was not studied by the other researchers.

(iv) Palmar Triradii

Male psoriatics were found to have a significant increase of extra triradii in I_3 of the right hand and female psoriatics had a significantly lower frequency of extra triradii in I_4 of the left hand.

A significant increase was found in occurrence of t' in psoriatic males on the right hand but not in females. Banach (1977) found decreases for both sexes and Singh et al (1983) found a decrease

for females only. A significant increase was found for palmar pattern intensity index on the right hand in male psoriatics in this study. No significant differences were found for maximal atd angle which agreed with the findings of Gibbs and Warburton (1968) but not with those of Banach (1977) or Singh et al (1983) who found significantly smaller atd angles in both sexes of psoriatics.

(v) Palmar Ridge Counts

Male psoriatics were found to have significantly increased b-c palmar ridge counts on both hands and for both hands combined (TBC) in comparison to controls. No significant difference was found in females.

(vi) Mainline Directions

A statistically significant increase in mainline C turning radially was found in male psoriatics when compared to controls.

(vii) Flexion Creases

Bettman (1932) reported a significant increase in simian line occurrence although both Gibbs and Warburton (1968) and Verbov (1968) found no difference. In this study no significant differences were found for simian line occurrence in either sex of psoriatics.

(b) Atopic Eczema

(i) Finger Patterns

Significant differences in the occurrence of various digital pattern types were found on finger II of the right hand in both sexes of atopic eczema patients in comparison to controls. In both sexes an increase in arches, radial loops and whorls and a decrease in radial loops and double loops was found. All were statistically significant.

Verbov (1972) reported a significant decrease in whorls on all fingers except RIV and a significant increase in arches for female atopics. No significant differences were reported for males. For this study an increase in whorls was found on all fingers in females although this was not statistically significant.

A significant increase in radial loop score and decrease in ulnar loop score was found in both sexes for finger II of the right hand. Female atopics also showed significant increases in radial score on RIV and ulnar loop score on RV. Male atopics were found to have significantly higher ulnar loop scores on LI and LV

and significantly lower ulnar loop score on LII. The radial loop score on LII was also found to be significantly higher compared to controls.

Significant increases in finger delta scores were found for finger RII in male atopics and fingers RIV and LII in females.

(ii) Finger Ridge Counts

Significantly increased values were found in male atopics for radial counts on fingers I and III of both hands and for ulnar counts on finger II of both hands. In addition a significantly lower radial count was found on RIV.

For female subjects, significantly increased ulnar counts were found on LII, LIII, RII and RIV and significantly increased radial counts were found on RI and RIII.

Significantly increased unilateral ridge counts were found in atopic eczema patients of both sexes for RF1 and RF3 and in males only for LF1. For summed ulnar and radial counts, atopic males were found to have significantly higher values for RI and RIII and significantly lower values for U2. Females had significantly higher values for U2, U3, U4 and R3. Male subjects were found to have significantly increased summed ulnar counts on both hands individually and combined. Increased summed unilateral counts were found on fingers I and III and absolute finger ridge count on finger RIII were found for male subjects, all were statistically significant. For females significantly increased summed unilateral count on finger III and significantly increased absolute finger ridge counts were found for RI and RIII in comparison to controls along with a significant increase in summed absolute counts on finger III.

(iii) Palmar Patterns

For male atopic eczema subjects, significant increases were found for the incidence of peripheral pattern in the thenar area and central pattern in the hypothenar both on the right hand. In females a significant increase in occurrence of peripheral patterns on the right palmar hypothenar area was found and a significant decrease in peripheral patterns in I_4 of the left hand was shown. Verbov (1972) noted a non-significant increase in hypothenar patterns in females but no other significant differences were shown. In this study male atopics showed significant increases in hypothenar palmar pattern intensity indices on both hands individually and for

both combined. Palmar pattern intensity indices were significantly increased in male atopic on right and both hands combined.

(iv) Palmar Triradii

In male atopics significant increases were found for axial triradii occurrence on both hands individually and for both combined and for occurrence of border triradii on both hands. In females a significantly greater occurrence of extra triradii in I_4 was found.

(v) Palmar Ridge Counts

Both male and female atopic eczema subjects were found to have significantly increased b-c ridge counts on both hands individually and combined. In addition males had a significantly higher c-d ridge count on the right palm.

(vi) Palmar Flexion Creases

Atopic eczema males were found to have significantly different transverse and thenar crease variant occurrence on the left hand along with thenar crease terminus on both hands. For the transverse flexion creases atopics were found to have higher occurrence of close lines and lower occurrence of close lines on the left hand. Higher occurrence of forked and cascade thenar crease variants were found on the left hand and higher occurrence of radial border terminus was found on both hands.

(vii) Ridge Disturbances

Significant differences were found between atopic eczema sufferers of both sexes and controls for the occurrence of white lines, hyperlinearity and ridge atrophy on both fingers and palms. White lines have been reported by Verbov (1972) and Cusamano et al (1983). Hyperlinearity has been reported by Smith (1984), Blaylock (1976), Hoyer et al (1981) and others. Further discussion of ridge disturbances is carried out in Section 9.4.

(c) Alopecia Areata

(i) Finger Patterns

Significant differences in finger pattern occurrence were found, in both sexes of alopeciatics when compared to controls, on finger V of the right hand. Significant decreases in arch and ulnar C.P. loop occurrence were found along with a significant increase in ulnar loop incidence. Whorl occurrence was found to be significantly decrease in males and significantly increased in female alopeciatics.

For male subjects other researchers reported a significant increase in whorls (Verbov 1968; Kapur and Verma 1982), a significant decrease in arches (Kapur and Verma 1982) and a significant decrease in ulnar loops on finger II (Verbov 1968). In this study whorls were found to be increased on fingers II, IV and V of the left hand and fingers I, II and III of the right hand. On the other fingers the incidence of whorls was decreased in comparison to controls. These differences were not found to be statistically significant. Arches were found to be decreased on fingers I, II and V of the left hand and fingers I and V of the right hand but again the differences were not significant. There was also a decrease in ulnar loop occurrence on finger II of both hands of male alopeciacs as reported by Verbov (1968).

Female alopeciacs were found to have a significant increase in arches (Verbov 1968, Selmanowitz et al 1974, Verma et al 1981). A significant decrease in loops was reported by Verma et al (1981) and Sharma et al (1977). Verbov (1968) reported significant ulnar loop decrease on digits II and III. In this study arch occurrence was reduced on all fingers in female alopeciacs except LIII, RII and RIII. Loops were found to be reduced on LII and III and on RII, III, IV and V. Ulnar loops were decreased on fingers II and III of both hands as reported by Verbov (1968). These results did not, however, reach the level of statistical significance.

Statistically significantly reduced ulnar loop scores and significantly increased radial loop scores were found for male alopeciacs on LII and for female patients on RII. A significantly decreased radial loop score was found for males on RV.

A statistically significant reduction in finger delta score was found for alopecia areata males on RV in comparison to control male subjects.

(ii) Finger Ridge Counts

For individual finger ridge counts, statistically significant increased radial counts were found for both sexes on finger RIII and also for finger LIII in female alopeciacs. Ulnar count on RII was also found to be significantly increased. For unilateral ridge counts significant increases were found for RIII (both sexes) and for LIII and RII (female alopeciacs). For summed ulnar count on finger V of male patients a significant decrease was found and for summed radial count on finger III of female patients a significant

increase was found. Significant increases in ridge counts were also found in female alopeciaks for variables RFA3, LFA3, LF3, RFRC and TFRC. The latter result corresponds to the findings of Verma et al (1981), although they did not find a statistically significant difference.

(iii) Palmar Patterns

Increased occurrence of central pattern in the hypothenar area of the right hand of males and the left hand of females plus increased incidence of peripheral hypothenar pattern on the right hand of females and decreased incidence of peripheral pattern on left hand I_4 were all found to be statistically significant for alopeciaks. Verbov (1968) reported an increase in I_4 patterns in male alopeciaks. In this study an increase in patterns was found for RI_4 but not LI_4 where the incidence was decreased. The differences were not found to be statistically significant.

In both sexes alopeciaks were found to have significantly different Interdigital Pattern Intensity Indices. It was found to be reduced in males and increased in females for the left hand and for both hands combined. This does not correspond to the findings of Verbov (1968) who found decreased patterns in the interdigital areas of female alopeciaks.

Female alopeciaks in this study were found to have increased hypothenar palmar pattern intensity indices on both hands when considered separately and for both hands combined.

(iv) Palmar Triradii

Both male and female alopecia areata patients were found to have significantly lower occurrence of extra triradii in I_4 in comparison to controls. Male alopeciaks had a significant decrease in "t" occurrence on the right hand and a significant increase in border triradius occurrence on the same hand. Female alopeciaks had the same results but for the left hand and axial triradii occurrence was significantly greater in female alopeciaks on both hands separately and for both combined.

(v) Palmar Ridge Counts

Female alopecia areata sufferers were discovered to have significantly higher counts for b-c on the left hand and c-d on the right hand along with a significantly lower count for a-b on the left hand compared to female controls. Total b-c count was also found to

be significantly higher in female alopeciacs.

(vi) Ridge Disturbances

On the palms both sexes of alopeciacs were found to have significantly higher occurrences of hyperlinearity and atrophy on both hands. On the fingers ridge atrophy was also found to be significantly higher in both sexes of alopeciacs in comparison to controls. Female alopeciacs were also found to have significantly greater hyperlinearity and white lines on all ten fingers. Males showed significantly higher hyperlinearity only on fingers I and V of both hands.

(d) Vitiligo

(i) Finger Patterns

Significant differences in finger pattern occurrence were found in both male and female vitiligo patients on fingers V of both hands in comparison to controls. There was a significant decrease in arches and a significant increase in ulnar loops. In male patients there was also a significant decrease in whorls and ulnar C.P. loops but in females these patterns were significantly increased.

Sahasrabuddhe et al (1975) and Iqbal et al (1985) reported a significant increase in arches in female vitiligo patients. In this study arches were found to occur less frequently on every finger. This, however, agrees with the findings of Singh et al (1983) and Oyhenart-Perera et al (1982) who found a significant decrease in arches. They also found significant increases in loops and whorls. An increase in whorls was found on every finger in this study but loop increase was found only on fingers I and II of the left hand. Note that the differences found for these variables did not reach the level of statistical significance. Verma and Jain (1981) reported a significantly increased occurrence of ulnar loops on finger III in female subjects. This was not found in this study and in fact ulnar loop incidence was decreased on both hands in comparison to controls.

For male vitiligo subjects Singh et al (1983), Oyhenart-Perera et al (1982) and Sahasrabuddhe et al (1975) reported a significant increase in whorl patterns. Iqbal et al (1985), however, reported a significant increase in whorls. In this study whorl patterns were found to be decreased on all fingers thus agreeing with

the first three groups of researchers, although the differences found were not statistically significant. Singh et al (1983), Verma and Jain (1981) and Oyhenart-Perera et al (1982) reported a significant increase in arches in male vitiligo patients. In this study increases in arches were found on both hands for fingers II and III only. Sahasrabuddhe et al (1975), Verma and Jain (1981) and Iqbal et al (1985) reported a significant increase in radial loops in male vitiligo patients. An increase was only found on finger II of each hand in this study.

Vitiligo males were found to have significantly decreased radial loop scores on finger V of both hands and finger I of the right hand along with a significantly increased ulnar loop score on finger IV of the left hand when compared with controls. Female vitiligo patients were found to have increased radial loop scores on fingers III and IV of the right hand and increased ulnar loop scores on fingers I and V of the same hand.

For finger delta scores vitiligo males had decreased value for finger V of both hands. Female vitiligo sufferers however had increased delta scores for fingers II and III of both hands and finger IV of the right hand.

Significantly decreased finger pattern intensity indices were found for male vitiligo subjects and significantly increased indices were found for female. The differences were for RFPII and TFPII in both sexes.

(iii) Finger Ridge Counts

Significantly higher finger ridge counts, both ulnar and radial, were found in female vitiligo patients for all fingers except finger V when compared to control female subjects.

Male vitiligo sufferers showed a significantly reduced ulnar count of finger V of the left hand and a significantly increased radial count for finger III of the right hand.

Significantly higher unilateral ridge counts were found on all fingers except V in female vitiligo patients and on finger RIII only in male patients. Female vitiligo sufferers were also found to have significantly increased summed radial counts on fingers I - IV and summed ulnar counts on fingers II - IV. Males showed a significantly decreased ulnar count for finger V. Female vitiligo patients were also found to have significantly increased summed

unilateral counts on both hands and for both combined. For the four types of absolute finger ridge counts females had significantly higher values for all fingers except finger V.

The significant increases in total and absolute finger ridge counts agree with that of Singh et al (1983) but conflicts with the findings of Iqbal et al (1985).

Male vitiligo sufferers were found to have significantly increased summed radial counts and significantly decreased summed ulnar counts on both hands.

(iv) Palmar Pattern Occurrence

Male vitiligo sufferers were found to have significantly greater frequency of radial patterns in the thenar area of the right hand and peripheral patterns in the same area of the left hand. A significant decrease of radial patterns on the hypothenar area of the right hand was also found for male vitiligo sufferers in comparison to controls. Female vitiligo patients had significantly decreased occurrence of ulnar and peripheral patterns on I_4 of the left hand along with significantly increased peripheral patterns on the hypothenar area of the right hand.

Overall there was a tendency for increased frequency of occurrence of palmar patterns in both sexes as reported by Iqbal et al (1985) and Singh et al (1983) but the differences were not statistically significant.

(v) Palmar Triradii

A significant decrease in occurrence of extra triradii in I_4 was found on the left hand in both sexes and also on the right hand in male vitiligo patients. Female vitiligo sufferers were found to have a significant increase in t triradius occurrence and a significant decrease in t' occurrence for the left hand only. A significant decrease was also found for female vitiligo subjects in comparison to controls for maximal atd angle for LATD and SATD.

(vi) Palmar Ridge Counts

Male and female vitiligo patients were found to have significantly increased palmar b-c ridge counts on both hands individually and combined (ie. LBC, RBC and TBC). In addition females had significantly reduced a-b counts on the left hand and c-d on the right hand along with the summed counts for both hands (TAB and TCD) when compared to controls. The findings for a-b ridge

counts differs from that found by Ibqal et al (1985) and Singh et al (1983) who found significant reductions in counts in vitiligo patients compared to controls.

(vii) Palmar Flexion Creases

Male vitiligo patients were found to have a significant difference in frequency of occurrence of thenar crease variants on both hands when compared to controls. Significant increases in double, forked, broken and cascade variants were found with a significant reduction in normal and short variants.

(e) BCC

(i) Finger Pattern Occurrence

Significant differences in frequency of occurrence of the various digital pattern types in both sexes of BCC sufferers for finger V of both hands when compared to controls. In the BCC patients arches and whorls were significantly reduced and ulnar loops were increased. For male BCC subjects significantly higher radial loop scores were found for finger V of both hands. For females significantly higher radial scores were found on the right hand for fingers I, II, III and IV. In addition a significantly greater ulnar score was found on finger V and a significantly reduced ulnar score was found on finger II of the right hand.

Significantly reduced finger delta scores were found for finger V of both hands in male BCC subjects and increased delta scores were found in BCC females for fingers I, III and IV of the right hand and finger I of the left hand. Finger pattern intensity indices were also increased in BCC females in comparison to controls for the right hand and both hands combined.

(ii) Finger Ridge Counts

Male BCC patients were found to have significantly reduced ridge counts on finger V. On the right hand both ulnar and radial counts were reduced but on the left hand only the ulnar count was decreased significantly.

Female BCC patients showed significant increases in the following counts; LFR2, LFU4, RFU1, RFU2, RFR3 and RFU4. LFU4 showed a significant decrease in comparison to control subjects

BCC males had significantly lower summed ulnar and radial counts on finger V. BCC females had increased summed ulnar counts

on fingers I, III and IV along with significantly increased summed radial count of finger III and significantly reduced radial count on finger V in comparison to control females.

In male BCC subjects significantly reduced right and total summed ulnar counts were found in comparison to controls. Significantly reduced unilateral ridge count was found on RV and significantly reduced absolute count was found on LV and for fingers V of both hands (F5 and AF5).

Female BCC subjects were found to have significantly increased unilateral ridge count of LIV and significantly decreased count on LV. For absolute finger ridge counts BCC females were found to have significantly increased values for finger I and III of the right hand and a significantly reduced count for finger V of the left hand. Female BCC subjects were also found to have a total absolute finger ridge count for both hands combined in comparison to controls which was significantly increased.

(iii) Palmar Pattern Occurrence

BCC male subjects were found to have a significantly lower occurrence of peripheral patterns in I_4 of the left hand in comparison to controls. Female BCC patients were found to have a significant increase in peripheral patterns on I_3 and significant decrease on I_4 on the left hand. On the right hand a significant increase in peripheral patterns on the hypothenar area was found in BCC females along with a significant decrease in radial thenar patterns. Hypothenar Palmar Pattern Intensity Index on the right hand in BCC females was found to be significantly increased.

(iv) Palmar Triradii

A significant increase in extra triradii in I_3 of the right hand was found in male BCC patients. Female BCC sufferers were found to have significant decreases in extra patterns in I_4 of both hands in comparison to controls. A significant increase in occurrence of axial triradius was found in BCC females on the right hand and an increased atd angle was found on the same hand.

(v) Palmar Ridge Counts

In female BCC subjects significantly increased b-c counts were found on both hands and for both combined. A significant decrease in left and total a-b ridge count was also found in BCC females in comparison to control females.

(vi) Mainline Direction

A significant increase in C line turning radially was found for BCC females on the left hand when compared to controls.

(vii) Ridge Disturbances

Statistically significantly greater occurrence of white lines, hyperlinearity and atrophy was found on all fingers for both sexes of BCC subjects in comparison to controls. Similarly on the palms BCC subjects of both sexes had significant increases in hyperlinearity and atrophy on both hands compared to controls.

(f) Actinic Keratosis(i) Finger Patterns

Significant differences were found for percentage frequency of occurrence of finger pattern types in both sexes for finger V of both hands. Arches were found to be decreased and whorls and ulnar C.P. loops were increased in actinic keratosis subjects of both sexes.

In male actinic keratosis patients, ulnar loop scores were significantly increased on fingers III and IV of the left hand and radial loop score was significantly reduced on finger V of the right hand. In female actinic keratosis subjects significantly increased radial counts were found on fingers II, III and IV of the right hand and a significant increase in ulnar count was found on finger V of the same hand.

Significant reductions in finger delta scores were found in male actinic keratosis subjects for finger V of both hands. Significant increases in finger delta scores were found for fingers II and III on both hands and finger IV of the right hand in actinic keratosis females compared to control females.

Finger pattern intensity indices were significantly increased in female actinic keratosis subjects on both hands individually and combined.

(ii) Finger Ridge Counts

Significantly higher radial counts were found in actinic keratosis males on finger III of both hands and significantly lower ulnar counts were found on finger V of both hands in comparison to male control subjects. In female actinic keratosis females significantly increased radial counts were found for fingers I and III

of both hands and finger II of the left hand. Significantly increased ulnar counts were also found in actinic keratosis female subjects on fingers II and IV of both hands and finger III of the left hand.

Actinic keratosis males had significantly increased summed radial counts on fingers II and III and significantly decreased ulnar count on finger V. Female patients had significantly increased summed radial counts on fingers I, II and III and significantly increased ulnar counts on fingers II, III and IV.

Increased summed radial counts were found on both hands individually and combined (RFR, LFR and TFR) for both sexes of actinic keratosis patients. Summed ulnar counts (RFU, LFU and TFU) were found also to be significantly reduced in male actinic keratosis patients.

Increased unilateral ridge counts were found in male actinic keratosis patients on finger III of both hands and in female patients on fingers I, II and III of both hands in comparison to controls. Significantly increased summed unilateral ridge counts were found on finger III for both sexes and a significantly reduced count was found for females on finger V.

For absolute counts in males actinic keratosis subjects increased counts were found on fingers II, III and IV of the left hand and finger III of the right hand. Significantly higher summed absolute counts were found on fingers II and III in male actinic keratosis patients and left finger absolute count was found to be significantly higher.

In females absolute finger ridge counts were found to be significantly higher on both hands for fingers I - IV. Summed absolute counts on both hands individually and combined (RFAC, LFAC and TFAC) were found to be significantly higher in actinic keratosis females than in control subjects.

(iii) Palmar Pattern Occurrence .. - - - - -

Male actinic keratosis patients were found to have a significantly higher occurrence of peripheral patterns on I_3 of both hands and a significantly lower occurrence on I_4 of the left hand in comparison to controls. Female actinic keratosis patients had significantly higher occurrence of central hypothenar pattern on both hands, peripheral hypothenar pattern on the right hand and peripheral pattern in I_3 of the left hand. Female patients also had a reduced occurrence of peripheral patterns on I_4 of the left hand in

comparison to control subjects. Hypothenar Palmar Pattern Intensity Indices were increased in female actinic keratosis patients for the right hand and for both hands combined.

(iv) Palmar Triradii

A significant decrease in t" occurrence on both hands of male actinic keratosis subjects was found along with a significant decrease in extra triradii in I₄ of the left hand.

Female actinic keratosis subjects were found to have a significant increase in axial triradii counts on the right hand and for both hands combined. The palmar pattern intensity index for the right hand was also increased significantly in female actinic keratosis patients in comparison to control females.

(v) Palmar Ridge Counts

Female actinic keratosis patients were found to have significantly increased left, right and total b-c ridge counts. Male patients had significantly increased total b-c counts. Female actinic keratosis patients had significantly decreased left and total a-b palmar ridge counts in comparison to control females.

(vi) Mainline Directions

Male actinic keratosis subjects were found to have significantly increased occurrence of C mainline turning radially on both hands with a corresponding significant decrease in C turning ulnarly on both hands. Female patients had a significant increase in C turning radially on the left hand only.

(vii) Ridge Disturbances

Actinic keratosis patients of both sexes showed significantly increased hyperlinearity and atrophy of the palmar ridges along with significantly increased hyperlinearity, white lines and atrophy of finger ridges.

(g) Dermatitis Herpetiformis

(i) Finger Patterns

No significant differences were found in the frequency of occurrence of digital pattern types on any fingers for either male or female DH patients. Roberts et al (1978) reported a significant increase in ulnar loops and a decrease in whorls in DH patients compared to controls. In this study ulnar loops were found to be increased in both males and females on eight out of ten fingers and

whorls were found to be decreased in eight out of ten fingers in male DH patients and seven out of ten fingers in female DH patients compared to controls. These results seem to support those of Roberts et al although they do not reach the level of statistical significance. Significant decreases in ulnar loop scores were found for DH males on fingers II of the left hand and on finger II of the right hand in female DH patients in comparison to control subjects.

(ii) Finger Ridge Counts

Significant decreases in ridge counts were found in male DH subjects for LFR2 and in female DH subjects for LFR4, RFR2, LF4, LFA4 and U3 in comparison to normal control subjects. Roberts et al found a significant decrease in TRC for male DH patients and a non significant decrease for female DH subjects. In this study non significant decreases were found for both sexes for both hands individually and combined.

(iii) Palmar Patterns

Significant decreases were found for frequency of occurrence of peripheral pattern on the I_4 area of both hands and central pattern in I_2 area of the left hand in male DH patients compared to male controls. For female DH patients significant increases were found to central pattern occurrence on the hypothenar area of the left hand and radial patterns on the hypothenar area of the right hand when compared to female control subjects. Significant increases were also found for hypothenar pattern intensity indices on both hands individually and combined in female DH patients.

(iv) Palmar Triradii

Male DH patients were found to have significantly decreased incidence of extra patterns in the I_4 area of the left hand in comparison to controls. Female DH patients were found to have significantly greater occurrence of axial triradii on both hands individually and combined, for border triradius on the left hand and for total palmar pattern intensity index.

(v) Palmar Ridge Counts

Male DH subjects were found to have significantly lower b-c ridge counts on both hands, and for both hands combined, when compared to male controls. A significantly lower summed total ridge count on the left hand was also found in male DH subjects. Roberts et al (1978) also found significantly lower a-b ridge counts in male

DH subjects.

Female DH patients were found to have significantly greater b-c counts (LBC, RBC and TBC) and summed total counts (RPRC, LPRC and TPRC) in comparison to controls. These findings conflict with those of Roberts et al (1978) who found significantly lower values.

(vi) Ridge Disturbances

In both male and female DH patients significantly increase occurrence of palmar hyperlinearity and hyperlinearity was found. Significant increases in both sexes of DH patients were also found for finger ridge atrophy. In male subjects significantly increased incidence of white lines and hyperlinearity was found on all fingers when compared to male controls. Female DH patients showed significantly increased hyperlinearity on all fingers of the right hand and fingers II, III and IV of the left hand along with significantly increased white lines on fingers III and IV of the left hand. These findings agree with David et al (1970) who found atrophy and white lines to be significantly increased in DH patients.

9.3 'Families' of Skin Disorders

The different sets of dermatoglyphics were used to investigate the similarities and differences between the subject groups with various skin disorders. It was already known that some disorders had a genetic component to their aetiology, i.e. atopic eczema, psoriasis, alopecia areata and vitiligo, whilst in others no genetic cause was known, i.e. BCC and actinic keratosis; and of course controls had no known skin disorders. One of the objectives of the investigation was to determine if these groups were produced using statistical analysis of the dermatoglyphic data set. It was also known that some disorders had similar physical manifestations and so could be regarded as more closely related than other disorders. Another objective was to investigate if these relationships would show up using dermatoglyphic discriminants. Discriminant and factor analysis were used for the investigation.

(i) Finger Patterns

(a) Males

Using finger pattern type (LP1 - RP5) and finger delta scores (RD1 - LD5) identical results were obtained. Psoriasis, alopecia areata and vitiligo were grouped together with BCC and actinic keratosis

also grouped. The first three disorders were closer to controls than BCC and actinic keratosis. Atopic eczema was removed from all of the others using these sets of variables. When the variable set for ulnar and radial loop scores was used (RFR1 - LPU5) controls were found to be distinctly separate from the other groups. The other six groups were arranged in the following pairs; atopic eczema and alopecia areata; psoriasis and vitiligo; actinic keratosis and BCC.

(b) Females

Using LP1 - RP5 and RD1 - LD5 identical results were obtained. Atopic eczema and alopecia areata were grouped together as were psoriasis and vitiligo. Actinic keratosis and BCC were the groups furthest removed from each other and from the rest of the groups which were closer to control subjects.

Using variables RPR1 - LPU5 (ulnar and radial loop scores) controls were removed from the other groups. Alopecia areata was closest to controls followed by BCC. Psoriasis, atopic eczema and vitiligo were grouped closely with actinic keratosis removed furthest from all of these groups and from controls.

(ii) Finger Ridge Counts

(a) Males

Using individual finger ridge counts (LFU1 - RFR5) two groupings of three groups were produced. Psoriasis, atopic eczema and alopecia areata formed one group removed from controls, BCC and actinic keratosis. Vitiligo was found to be separate but closer to the second group. Alopecia areata and atopic eczema were closest together in the first group and actinic keratosis and BCC were closest in the second.

When unilateral ridge counts were used as the variable set (RF1 - LF5) a similar but not identical pattern was produced. Controls were again separated from the other groups with vitiligo also being separated from controls and the rest of the groups. BCC and alopecia areata were grouped together and atopic eczema, psoriasis and actinic keratosis were also grouped together. Actinic keratosis was furthest from controls.

Absolute ridge counts (RFA1 - LFA5) showed controls, atopic eczema and alopecia areata to be grouped together with psoriasis close to this group. BCC and actinic keratosis were removed from this group and were grouped together. Vitiligo was removed from all of the

other groups.

Using summed ulnar and radial counts (R1 - U5) BCC and actinic keratosis were closest to controls. Next psoriasis and alopecia areata were grouped together. Atopic eczema was removed from them but was closest to the group of controls, BCC, actinic keratosis, alopecia areata and psoriasis. Vitiligo was alone and removed from the rest of the groups.

Summed absolute ridge counts (AF1 - AF5) produced a similar pattern. Controls were removed with atopic eczema, psoriasis and alopecia areata forming a central group. BCC and actinic keratosis were grouped together and removed from the three clustered groups and further from controls. Vitiligo was again separate but closer to controls.

Factor analysis showed that the most important discriminating variables were radial ridge counts.

(b) Females

Using individual finger ridge counts three groups were formed: controls, psoriasis and BCC; atopic eczema and alopecia areata; actinic keratosis and vitiligo. The third group was furthest away from the first.

Unilateral ridge counts (RF1 - LF5) produced four groups. Controls were separated from a group comprised of atopic eczema and psoriasis, next came a group of alopecia areata, BCC and vitiligo and finally actinic keratosis was removed from the rest.

Absolute ridge counts (RFA1 - LFA5) showed three groups: controls, atopic eczema and psoriasis, alopecia areata and BCC and vitiligo and finally actinic keratosis removed on its own.

Summed ulnar and radial counts (R1 - U5) showed atopic eczema, psoriasis, alopecia areata and BCC to be grouped together with controls, actinic keratosis and vitiligo to be removed from them in different directions and so furthest apart from each other.

Summed absolute ridge counts showed controls, atopic eczema, alopecia areata and BCC to be grouped with vitiligo and actinic keratosis removed from this group but in different directions.

Again factor analysis showed radial counts to be the best discriminating variables.

(iii) Finger Ridge Disturbances(a) Males

When white line occurrence was used as the discriminating set of variables (LW1 - RW5) three groups were produced. Controls, vitiligo, alopecia areata and psoriasis formed one group which was well separated from BCC and actinic keratosis which were close together. Atopic eczema was separate and removed equally from the other two groups.

Using hyperlinearity (LH1 - RH5), controls, vitiligo and alopecia areata were grouped with psoriasis close to them. Atopic eczema was removed from that group and also from BCC and actinic keratosis which were grouped together.

The atrophy variables (LA and RA) showed controls, psoriasis, vitiligo and alopecia areata to be closely grouped with another looser group of atopic eczema, BCC and actinic keratosis removed from the first group.

(b) Females

Using white lines (LW1 - RW5) as the variable set controls and vitiligo were loosely grouped together. Next were psoriasis and alopecia areata. Atopic eczema and actinic keratosis were grouped closely followed by BCC removed from them and furthest from vitiligo and controls.

Hyperlinearity produced the same groupings as for white lines. Psoriasis and alopecia areata were closer together and the members of the other groups were further apart.

Ridge atrophy showed controls to be removed with vitiligo closest to them. Alopecia areata, psoriasis and atopic eczema were grouped close together. Actinic keratosis and BCC were separated from these groups and from each other.

(iv) Palmar Patterns(a) Males

Using variables PTL to HRAR (Palmar Pattern Occurrence) four groups were produced; vitiligo alone; controls and BCC; atopic eczema and alopecia areata; psoriasis and actinic keratosis.

(b) Females

When the same set of variables was used three groups were produced; controls alone; psoriasis and atopic eczema; BCC, vitiligo, alopecia areata and actinic keratosis.

(v) Atd angles(a) Males

Using maximal atd angles (LATD to SATD) two groups were produced. Controls, BCC, alopecia areata and actinic keratosis were in one with psoriasis, atopic eczema and vitiligo in the second.

(b) Females

Maximal atd angles did not discriminate very well as all groups were closely clustered. Alopecia areata and vitiligo, controls, actinic keratosis and atopic eczema; psoriasis and BCC were the groups closest to one another but no real separation was found.

(vi) Palmar Ridge Counts(a) Males

Identical results were produced using the two sets of variables LAB to RCD and TAB to TCD. Controls were separated from the rest with psoriasis, BCC, alopecia areata and vitiligo grouped together. Atopic eczema and actinic keratosis were removed from the central cluster in different directions.

Factor analysis showed b-c ridge counts to be most important followed by a-b counts.

(b) Females

The same two sets of variables were used and again identical results were produced. Controls were removed from a central group of psoriasis, vitiligo, atopic eczema and alopecia areata. Actinic keratosis and BCC were removed in the opposite direction to controls and were close together.

Factor analysis again show b-c counts to be the most important discriminating variables followed by a-b ridge counts.

9.4 Physical Effects of Skin Disorders on Epidermal Ridges

In this section attention is shifted from the dermatoglyphic variables to the physical changes in the epidermal ridges caused by the disorders. The usefulness of studying these changes in specific disorders as diagnostic aids is also assessed.

(i) Atopic Eczema(a) White Lines

Verbov (1972) and Cusumano et al (1983) reported the appearance of linear grooves ('white lines') on the fingers of patients with atopic eczema. In this study atopic eczema patients of both

sexes were found to have white lines on all fingers, the occurrence of which was found to be highly significantly greater than that in control subjects. White line occurrence was also found to be significantly greater in BCC and actinic keratosis subjects of both sexes when compared to controls. The severity of lining, however, was much greater in atopic eczema patients than in actinic keratosis sufferers. BCC patients of both sexes showed a greater severity of white lineage. This may be because the group of BCC patients was of a much greater mean age than that of atopic eczema. When members of the groups were compared of the same age were compared atopic eczema patients showed greater severity of white lines. Also many BCC patients may also have had concomitant eczema or ichthyosis.

(b) Atrophy

Verbov (1972) reported atrophy of finger ridges in atopic eczema patients. In the present study highly significant increases in finger ridge atrophy on both hands were found in atopic eczema sufferers of both sexes when compared to controls. BCC, actinic keratosis and alopecia areata sufferers also showed highly significantly greater amounts of finger ridge atrophy. Only BCC was found to show greater amounts of atrophy than atopic eczema.

Palmar Ridge Atrophy was also found to be highly significantly greater in atopic eczema patients when they were compared to controls. This highly significant difference was found for both sexes on both hands. BCC patients were found to have an even greater degree of palmar epidermal ridge atrophy than atopic eczema patients both for frequency of occurrence and for degree of severity.

(c) Hyperlinearity

Hyperlinearity of the palms has been reported by Norins (1971), Maize (1976), Blaylock (1976) and Verbov (1979) and indeed Lobitz and Dobson (1956) and Hanifin and Lobitz (1977) consider hyperlinearity of the palms to be one diagnostic criterion of atopic eczema. In the present study the presence of hyperlinear palms was a striking characteristic of atopic eczema patients and was found to be highly significantly greater than in controls for both sexes on both hands. Indeed a trial was carried out whereby a group of prints was selected and I identified 97% correctly the subjects with atopic eczema. Again, however, BCC patients showed a highly significant increase in palmar hyperlinearity and the mistakes I made in the diagnosis described

was wrong classification of BCC patients. Similar arguments as for white lines could be made in this case (see Section a). For finger hyperlinearity atopic eczema patients also showed highly significant greater occurrence than controls for both sexes on both hands. Again BCC patients showed the same significant trend but the frequency of occurrence and degree of hyperlinearity was not as great in BCC patients as in atopic eczema sufferers.

(ii) Dermatitis Herpetiformis and Coeliac Disease

(a) White Lines

David et al (1971) reported the occurrence of white lines in DH patients. In the present study significantly greater increases in white line occurrence on all fingers in comparison to controls were found for male DH patients. In female DH patients significantly greater occurrence was found only on fingers III and IV of the left hand in comparison to controls.

In this study hyperlinearity was separated from white lines, the latter being defined as linear grooves running transversely over the finger tips. When hyperlinearity was analysed DH males, DH females and coeliac females were found to have a significantly greater amount of hyperlinearity on all fingers in comparison to control subjects. Coeliac males were only found to have highly significantly greater hyperlinearity, in comparison to control males, on fingers III and IV of the right hand.

(b) Ridge Atrophy

David et al (1970) reported ridge atrophy in DH patients. In the present study both sexes of DH patients were found to have significantly greater occurrence of finger ridge atrophy in comparison to controls. No significant differences in occurrence of atrophy were found when coeliacs were compared to controls.

The above findings support those of David et al (1970) and disagree with those of Verbov et al (1971) who found no significant atrophy or hyperlinearity. McRae et al (1970), Mylotte et al (1972) and De Sousa and Duarte (1974) reported no differences in ridges in coeliacs. In this study no differences were found for ridge atrophy but hyperlinearity was found to be greater in coeliacs than in controls.

(iii) Incontinentia Pigmenti and Anhidrotic Ectodermal Dysplasia(a) Sweat Pore Loss

In both I.P. and A.E.D. a highly significantly reduced occurrence of sweat pore was found. It was found on counting that the patients had the greatest loss of pores with carrier females having much smaller loss but both were significantly different from the sweat pore counts found in control subjects. These findings agree precisely with those of Rott (1984) for I.P. In the A.E.D. patients very low mean sweat pore counts were found which supports the findings of Passage and Fries (1973) and Priest (1967).

(b) Ridge Atrophy

Flattening and atrophy of the epidermal ridges was reported in A.E.D. by Verbov (1970), Lapiere and Dodinval (1967), Priest (1967) and Rodewald and Zahn-Messow (1982) and I.P. by Rott (1984). In the present study atrophy of the epidermal ridges on all fingers of both hands was found to be significantly greater in I.P. females in comparison to control females.

Extreme atrophy, along with hyperlinearity, were found in the patients with A.E.D. thus supporting the finding of the researchers.

(iv) Darier's Disease(a) Atrophy

Male and female Darier's patients were found to have highly significantly greater amounts of finger and palmar atrophy on both hands in comparison to controls to their unaffected first degree relatives.

(b) Hyperlinearity

Female Darier's patients were found to have highly significantly greater hyperlinearity of both palms and fingers but this was not found for male Darier's patients when both were compared to normal controls.

(c) Pits and Plaques

Darier's patients of both sexes showed a highly significantly greater amount of pitting of the ridges in comparison to control subjects. This pitting was such a noticeable feature that a further investigation was carried out to quantify more accurately the differences (see page 1028).

(v) Usefulness of physical changes of ridges in diagnosis

From sections i-iv above it appears that some of the physical effects of the various skin disorders may prove of some use as aids to diagnosis. Hyperlinearity is a very notable feature of atopic eczema but may also be found in ichthyosis vulgaris, BCC and actinic keratosis. It, therefore, although very prominent may be of limited use. Pitting in Darier's disease is a very prominent feature and certainly could act as a diagnostic aid. Sweat pore loss was found extensively in A.E.D. and I.P. and is a feature of disease. It also can be used to assess carrier status which cannot be diagnosed by external signs. Sweat pore loss occurs in carriers but not to so great a degree as in sufferers from the disorder.

9.5 Conclusions related to the original aims and objectives

Nine aims and objectives were set out at the beginning of the thesis. In this section an assessment is carried out to determine the degree to which each of the aims and objectives has been reached.

The aims are, therefore, restated and followed by conclusions which have been reached relating to each objective in turn.

(i) To determine if groups of patients with six common skin disorders and normal control subjects can be differentiated between using analysis of dermatoglyphic data.

In Chapters Six and Seven the results of analysis on the dermatoglyphic data are presented. Variables are grouped according to type, e.g. finger ridge counts, palmar pattern occurrence. For each set of variables, Mann-Whitney U Tests and Discriminant Analysis were used to attempt to discriminate between the groups. The degree of success differed according to the set of variables used but overall proved to be successful.

(ii) To determine affinities and differences between the six groups of patients with common skin disorders.

The formation of different 'families' of skin disorders was discussed in Section 9.3 drawing upon the results set out in Chapters Six and Seven. It was found to be possible to differentiate the groups with skin disorders which have a genetic component in their aetiology from those groups with disorders having no known genetic causation. Furthermore within the first group affinities were highlighted between subgroups e.g. psoriasis and alopecia areata.

(iii) To determine differences between the groups with skin disorders and normal control subjects.

A summary of this was set out in Section 9.2 using the 'Disease Approach' of analysis and working through each set of variables in turn for each disorder compared to controls.

(iv) To determine which variables or set of variables best differentiates between the various groups described above.

Using Factor Analysis and Discriminant Analysis variable sets were produced which were most effective at discriminating between the subject groups. The results of Discriminant and Factor Analysis are presented in Chapters Six and Seven at the end of each section of type of variables.

(v) To determine whether or not dermatoglyphic variables can be used to discriminate between groups of subjects with four rare skin disorders, their unaffected first degree relatives, relatives of proven carrier status and normal controls.

The results for this are presented in Chapter Eight. It was found that for Dermatitis Herpetiformis and Coeliac Disease discrimination could be carried out using dermatoglyphic variables. The same was found to be true for Darier's disease. For Incontinentia Pigmenti and Anhidrotic Ectodermal Dysplasia the sample set was very small and more valuable discriminators were physical manifestations of the disorder on the epidermal ridges (see vii below).

(vi) To determine which variables or set of variables best differentiate between the groups described in (v) above.

In Chapter Eight the results of Factor and Discriminant Analysis are presented which set out the best discriminating variables or sets of variables.

(vii) To determine the physical effects of the skin disorders on the epidermal ridges.

It was found that hyperlinearity, atrophy and white lines were prominent in various disorders e.g. hyperlinearity in atopic eczema. Pitting was also found to be a notable feature in Darier's disease and sweat pore loss was prominent in A.E.D. and I.P. The effects of the disease on the epidermal ridges are discussed in Chapter 6-8 at appropriate points and a summary is given in Section 9.4.

(viii) To determine if the findings of other research workers can be supported using the findings of this study.

In Sections 9.1 and 9.4 the findings of the present study for individual skin disorders are compared to those of other research workers in the field of dermatoglyphics and skin disorders. Many of the findings of the other studies were supported but some were rejected. Other studies quite often relied upon small subject numbers whereas this study had approximately 200 of each sex for each of the main disorders.

(ix) To determine the usefulness of dermatoglyphic variables and/or physical changes to the epidermal ridges as aids to diagnosis of various skin disorders.

The various notable dermatoglyphic variables which were most common in specific disorders are given in Chapters 6-8 and in Chapter 9 (Section 9.1). These were found to be many and varied and the most important ones were those which support the findings of other researchers as described in (viii). More reliable and easier to use were the physical changes specific to particular disorders e.g. pits and plaques in Darier's disease, hyperlinearity in atopic eczema and sweat pore loss in I.P. and A.E.D. In particular the ability to detect carrier status in I.P. and A.E.D. using sweat pore counts or to detect Darier's disease using pitting in children before other manifestations become apparent were most promising.

9.6 Critical Appraisal and Concluding Remarks

The association of an abnormal prevalence of genetically transmitted attributes with specific disease groupings has widely been used for the definition of genetic disease and its chromosomal localisation. Since certain aspects of dermatoglyphic patterns are also genetically determined, many diseases have likewise been studied for pattern characteristics. The problem has been, however, that although many disease associations have been found, with few exceptions, such as Down's syndrome, most of the dermatoglyphic changes have been minor in degree and prevalence. In addition, although the reported deviations appear to be statistically significant, they can rarely be confirmed. It has generally been assumed that this is because of small size of sample or lack of homogeneity of disease classification.

Schaumann and Opitz (1991) summarised the problematic areas in clinical dermatoglyphic studies and identified the following five most commonly encountered shortcomings:

- (i) problematic diagnosis
- (ii) small sample size
- (iii) limited number of dermatoglyphic traits included
- (iv) inappropriate control sample
- (v) inappropriate statistical analysis and/or flawed interpretation of results

In the design, implementation and analysis phases of this investigation all of the five problem areas were addressed successfully. It would appear, however, that in overcoming these problems, the solutions adopted themselves generated other problematic factors which were not foreseen. In addition, it seems that in this study, and indeed in all dermatoglyphic studies related to clinical disorders, there exists a range of systematic methodological errors which remain undetected.

In carrying out this review I, therefore, decided that a useful format was to focus upon each of the problematic areas in turn, explain the methods used to overcome them and discuss their impact on the results of the investigation. This approach will produce a critical summation of the findings of the investigation and lead to the highlighting of some fundamental questions which perhaps need to be addressed using follow-up investigations but which also may help to clarify the effectiveness of the dermatoglyphic approach in this type of study.

(i) To overcome the problems associated with diagnosis, i.e. lack of diagnostic information and/or heterogeneous aetiology of the investigated disorder, which could lead to erroneous interpretation of results, only individuals with a confirmed diagnosis using the most precise diagnostic criteria were included in the study. Well defined skin disorders were chosen, some in which there was a clear genetic component, and some in which such a mechanism is not suspected. In addition, each patient suffered exclusively from only one of the specific selected disorders and from no other diagnosed skin disorders. No cases of questionable diagnosis were included in the sample groups which constituted the main study. In the smaller family studies of

rarer skin disorders, however, some questionable cases were deliberately selected since these were shown to be useful in the process of refining some of the diagnostic potentialities of the investigation. The procedure and criteria for case selection were fully explained in Chapter 4, Section 4.5.

Despite the rigorous selection procedure adopted, the problem of only selecting patients with sepecific diagnoses was not totally overcome. In truth, this problem, which exists in all clinical dermatoglyphic studies, is insurmountable. To illustrate this problem, for example, a patient could be genetically predisposed to a particular skin disorder in addition to the one for which the subject has been included in the study. This additional disorder may not yet have manifested itself at the time of selection of the subjects, but if an association between the genetic causation of specific skin disorders and certain aspects of epidermal pattern formation does exist then the phenotypic effects on the dermatoglyphics will already have occurred. In addition, subjects could be suffering from disorders other than those which affect the skin but nevertheless which have proven genetic causation factors. There may be an association between dermatoglyphics and these other diseases but this could go undetected in the investigation since it would not normally be recorded in the patients' notes in the Dermatology Department. A subject could also be predisposed for a disorder which had not presented since it has an age related onset or the necessary provoking stimulus had not yet been encountered.

When these points are taken into consideration, it can be seen that it is impossible to produce samples of patients where the only additional factors affecting the dermatoglyphics are those produced by one particular selected skin disorder.

(ii) In previous investigations on dermatoglyphics and skin disorders sample sizes were in the main small some consisting of individual case studies. The majority of reports were based upon fewer than twenty subjects of each sex. Yet from these studies quite often sweeping generalised statements were made concerning associations between abnormal dermatoglyphic characteristics and specific skin disorders (Saha1969, Sharma et.al.1977, Kapur and Verma 1982, Singh et. al. 1984, O'Leary et.al. 1986). In this investigation,

therefore, target numbers were set for each of the groups of patients with selected skin disorders. The aim was to print 200 individuals of each sex for each of the main disorders chosen. This was not an arbitrary target number but was chosen after consultations with statisticians and others with expertise in the area of experimental design. Once this threshold value had been exceeded further increases in numbers would make no significant difference to the validity of the results obtained within the parameters of this type of investigation. The figure of 200-250 subjects per sex for each of the disorders could, therefore, be regarded as the optimum number for this type of study. Moreover the collection of more than 3,000 subjects in this study produced by far the largest set of data in the area of dermatoglyphic investigations of skin disorders. Therefore as well as producing a viable set of data for this study, the results could be justifiably compared with the findings of other researchers. It was found, however, that the smaller studies suggested results which this larger investigation has shown not to be sustainable (see Section 9.5).

(iii) Authors of previously published studies on dermatoglyphics and skin disorders have frequently reported only a limited number of dermatoglyphic traits without providing reasons for their selection. Moreover, different traits were selected by different research workers and the definitions of the parameters measured, where stated, quite often varied between authors. Different labels were often given to the same variable when used by different workers and a variable name was often used by different researchers to denote different measurements. In this investigation an exhaustive range of precisely defined variables was used.

The argument has been put forward by Loesch (1983) and Schaumann and Opitz (1991) that too limited a number of variables means that the reporter is likely to miss significant associations between the disorder and the dermatoglyphic characteristics. It has been stressed repeatedly (Holt 1968, Schaumann and Alter 1976, Loesch 1983, Chakraborty 1991) that almost none of the dermatoglyphic variants is specific to a particular disorder but rather that each is a combination of various dermatoglyphic anomalies that together produce the abnormal dermatoglyphics which the research workers are looking for.

In this study, therefore, the number of variables measured and computed was considerable, with the specific objectives of permitting direct comparisons with any of the variables used by other researchers and also of producing a substantial data set capable of sustaining original research work in its own right.

In this investigation a total of 116 variables, 58 on each hand, were measured directly, and another 103 variables were computed from them; i.e. 219 variables were collected for each subject. The rationale for the measurement of such a wide range of variables and the accumulation of a very large set of data in this study was, as stated above, to clarify any associations which existed in the data. The trends and correlations that were sought, however, tended to become obscured beneath the vast mass of data and they became difficult to discern, i.e. it was difficult 'to tell the wood from the trees'. With so many variables and the large sample sizes it is inevitable that some association would be found but there was no overall consistency to the findings. This therefore raises the question as to whether or not there are any underlying factors and if there are any key discriminating factors. One of the aims of the study was to produce a set of key variables which would best discriminate between subgroups and indeed between individuals and the measurement of the wide range of variables, as described above, would enable these key factors to be identified.

There appears to be a certain degree of reducibility involved in the selection of key variables with some becoming redundant. Many of the directly measured variables become subsumed by others which may be computed from them. A hierarchical system of variables, therefore, appears to exist within those measured or computed. For example, individual ulnar and radial finger ridge counts were measured in the first instance but these were then added to produce summed total counts which were in turn summed for each hand, then the two counts, one for each hand, were totalled as shown in Table 9.1 below. Similarly, the variables for finger ridge scores also follow a hierarchical system as shown in Table 9.2. Indeed systems like these exist for each of the sets of variables, i.e. palmar ridge counts, atd angles etc.

Table 9.1 Finger Ridge Counts: to show hierarchy of variables

Finger Ridge Counts Summed Total Finger Ridge Counts

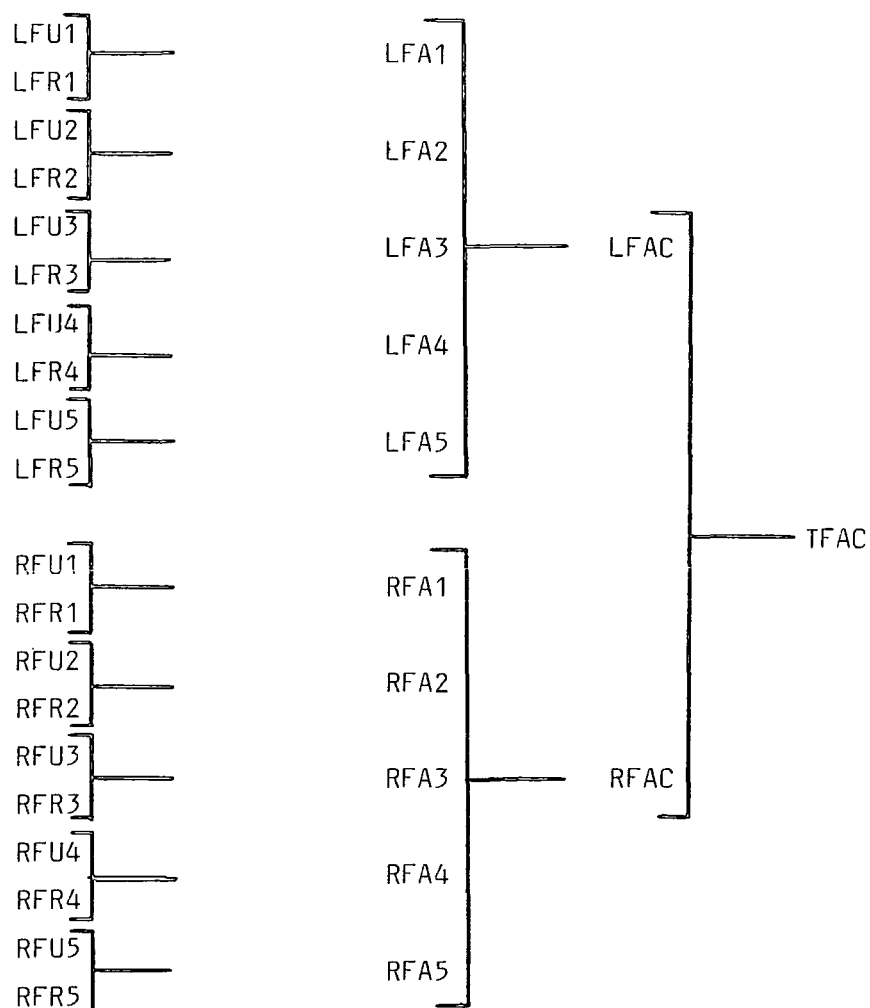
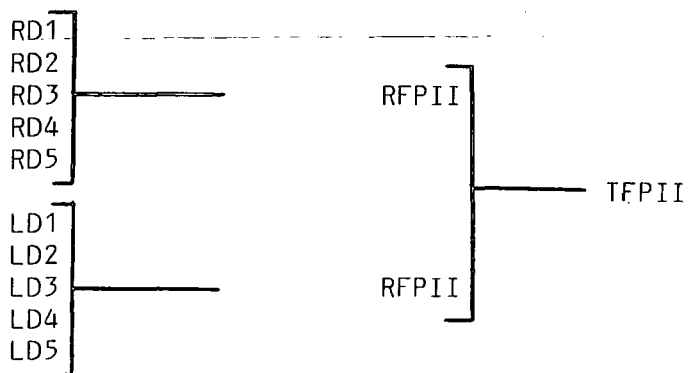

Table 9.2 Finger Delta Scores: to show hierarchy of variables

Finger Delta Scores Finger Pattern Intensity Indices



When analysing the data, therefore, it may be of value to begin with the higher level variables and to determine which of these are the best discriminators and then to move from these into the more specific lower level variables in the area selected by the initial test. The best discriminatory variables which were determined by factor analysis and discriminant function analysis are to be found in Chapters 6 and 7 for the main sample for fingers and palms respectively, while the results for the smaller family studies are shown in Chapter 8. In addition, all of these results are summarised in Sections 9.2 and 9.3 of this chapter. Therefore, although the majority of the directly measured variables are necessary in the first instance since they provide the base from which other derived variables are calculated, there may be some which prove to have little or no discriminatory value and thus can be eliminated.

Two major points appear to stand out in the area of selection of key variables. Firstly, quantitative variables were found to be consistently better for discriminatory purposes than were qualitative variables. This is not surprising since it has been well reported in the work done on the calculation of distance coefficients using dermatoglyphic measurements (e.g. Constandse-Westermann 1972, Chai 1972, Rudan 1978). The work has subsequently been refined with distance coefficients being estimated for nineteen selected variables believed to have high heritability (Loesch 1983).

Recent analyses of quantitative dermatoglyphic variables have successfully linked population structure models with population genetics theory. Biangero (1988) showed that dermatoglyphic differentiation between a set of Nepalese villages could be explained by patterns of inter-village migration. This has been followed up by the work of Relethford and Blangero (1989) on the detection of differential gene flow from patterns of dermatoglyphic and other forms of anthropometric variation.

A more thorough analysis of the different facets of dermatoglyphic characteristics on fingers and palms as well as on toes and soles is needed. In this study it was decided that the dermatoglyphic characteristics which are to be found on feet were not to be investigated because of the practical problems of printing patients' feet in the Skin Outpatients Department.

Secondly, computed variables including indices, whilst not being biological features in themselves, were found to be of greater discriminatory value than individual variables in general.

(iv) Inappropriate control samples have raised doubts concerning the validity of some of the published results on dermatoglyphics and skin disorders, if not on clinical dermatoglyphic studies in general. Although differences in dermatoglyphic characteristics resulting from ethnic, racial, sexual and other factors have been well documented (e.g. Cummins and Midlo 1943, Holt 1968, Loesch 1983), the selection of a representative control sample has been a problem in many of the published studies. Many researchers have simply relied upon the published data of other authors regardless of the origin of the subjects. For example in the research work reviewed on dermatoglyphics and skin disorders in Chapter 2, Jilek (1972) used the Czechoslovakian sample of Nemeč (1968), Oyhenhart-Perera (1982) used the Uruguayan sample of Kolski and Scozzochio (1961). In other studies any subjects which happened to be available were used without any attempt at matching for the factors mentioned above (e.g. Verma and Jain 1981, Singh et.al. 1984). It has been noted, however, that striking differences in the interpretation of results can be obtained by using different samples of phenotypically normal, healthy control subjects of the same race from different, quite often very close or overlapping, areas of the same country (e.g. Meier 1978, Loesch 1979, Jantz et.al. 1982, Rudan et.al. 1988). The only reliable method of obtaining a representative control sample is to obtain data from a group of first-degree relatives of the patients in the study. Since there is an enormous natural variability of dermatoglyphic traits this may be the only objective method of distinguishing between the effects of a given defect and of the genetically determined dermatoglyphic traits. What may appear to be unusual dermatoglyphics may be shared by unaffected relatives, while seemingly unremarkable dermatoglyphics of a patient may differ from those of healthy relatives.

In this investigation first-degree relatives were printed in the smaller family studies of rarer skin disorders (i.e. Darier's disease, Anhidrotic Ectodermal Dysplasia and Incontinentia pigmenti) and they proved to be extremely useful, particularly with respect

to the changes in the epidermal ridge characteristics caused by the skin disorders themselves (i.e. secondary changes). The pitting of the ridges in Darier's disease and the loss of sweat pores in A.E.D. are examples where comparisons between healthy and affected family members have proven to be of great value for diagnostic purposes (see Chapter 8, Sections 8.3 - 8.5).

In the major part of the study, however, the printing of first-degree relatives of the patients was purposely not carried out. There were two reasons for this: firstly, the subject sample was so large that it was impossible in practical terms, to print all of the first degree relatives, since most of the printing was carried out in the Dermatology Out-Patients Department and only rarely did the relatives of the patients attend with them. Secondly; since the method of analysis for the main part of the study was the comparison of various populations of subjects having selected skin disorders with one another and with a group of normal control subjects, the inclusion of first degree relatives in the control group would invalidate the comparisons due to the familial resemblances which exist in terms of dermatoglyphic characteristics. The printing of first-degree relatives in this type of study was, therefore, thought not to be appropriate. The control sample which was printed was matched with the 'disease' sample for sex, age, race and place of birth (i.e. N.E. England) using the criteria set out in Chapter 4, Section 4.5. Wherever possible the spouses of the subjects or family friends, who often attended with the patients, were printed providing that they fulfilled the desired criteria because they usually matched for age, sex, birthplace etc.

(v) The problem of inappropriate statistical analysis was overcome in this study by the use of a proven methodological model for classifying and analysing the dermatoglyphic data (i.e. Dennis 1977) based on the 'traditional scheme' of Cummins and Midlo (1943) and Penrose (1968) and the 'topological scheme' of Penrose (1965) and Penrose and Loesch (1979). This methodology has been used extensively in the University of Durham and elsewhere and therefore can be regarded as being tried and tested. The statistical package used in the study was again a proven one which had been used extensively (i.e. SPSS). In addition, advice was obtained from advisors in the Computer Centre

at the University of Durham and from statisticians at the Medical School in the University of Newcastle-upon-Tyne as to the appropriateness of the analytical methods used.

In the past, significant changes in the prevalence of dermatoglyphic characteristics have been reported in various skin diseases. Many of these changes, however, differ in detail with the significant differences sometimes in the prevalence of one particular trait and sometimes of another e.g. pattern type occurrence, ridge counts, and angles etc. To take psoriasis for example, Verbov (1968) reported a significant increase in whorls whereas Banach (1977) reported a significant increase in arches in both sexes of probands when compared with controls. Jilek (1972) reported a significant increase in Total Ridge Counts for both sexes of psoriatics, whilst Singh et.al. (1983) reported significant increases in patterns in the third and hypothenar interdigital areas along with significant decreases in displacement of the axial triradius. Bettmann (1932) however, reported a significant increase in Simian line occurrence which was not found. What is more it has been impossible for many of these reported abnormalities to be confirmed. These inconsistencies have mostly been attributed to small size of sample studied but this clearly cannot be the case in this study because of the large number of subjects printed. However, whilst the findings of significant quantitative differences in dermatoglyphic characteristics found in this study were similar to those of other workers in these disorders, the interesting thing was that the nature of the findings differed. Thus for example, in alopecia areata a significant decrease in the occurrence of whorl patterns on fingers was found in this study whereas Verbov (1968) and Kapur and Verma (1982) found a significant increase. In vitiligo, a significant decrease in the frequency of arch patterns was found, whereas Sahasrabudde et.al. (1975 and Iqbal et.al. (1985) reported a significant increase. What is more, in several of the skin disorders studied, the apparently abnormal prevalence of dermatoglyphic characteristics occurred in only one sex, suggesting that the 'abnormality' is as much affected by sex as by the underlying disease. For example in vitiligo male subjects showed a significant decrease in ulnar and radial finger ridge counts whereas females were found to have a significant increase. Similarly in psoriasis, males were found to

have a significantly higher number of palmar triradii whereas females showed a significantly lower occurrence. An explanation for this is that, if there is a link between the disorder with a genetic component in its aetiology and the genetically influenced dermatoglyphic characteristics, the genes for both must be carried exclusively on the Y chromosome, unless sex limitation as in male pattern baldness is the reason. This explanation seems extremely unlikely and is not supported by any of the research findings on dermatoglyphics and chromosome abnormalities.

In this study large numbers of significant differences were found. It was expected that some would occur by chance alone but this was corrected for using Hotelling's multivariate T^2 test (Norusis 1990) and the number found was significantly higher. There appears to be no consistent pattern to the occurrence of these differences. Loesch (1983) warns against the pitfalls of accepting too readily significant differences which are found in dermatoglyphic studies where there are no consistent patterns.

It appears in this study that the only consistent findings has been the detection of a difference between the diseased and normal populations used as controls, but not in relation to any specific dermatoglyphic difference. This finding implies that the possibility of variation of dermatoglyphic pattern is so great that the findings of small but significant differences is inevitable, regardless even of groups studied. To test this conclusion several strategies could be employed.

Firstly, if there was a particular dermatoglyphic pattern which truly characterised any disease group, then on subdivision of the group the same discrete characteristics should still be found, although the magnitude and significance level of the findings might well differ with the smaller number. If on the other hand the explanation suggested above is correct, instead of demonstrating consistency, subdivision would reveal new differences between different aspects and attributes of the dermatoglyphic characteristics. Similarly, if the control group were randomly split into halves it would be interesting to see the number of significant differences for the prevalence of dermatoglyphic traits that would be found.

Secondly, the argument could be taken further by making the assumption that there were no real differences between the various groups and examining whether further analyses were consistent with that view. All patients and normal subjects could be combined and then divided randomly into a number of equal groups. If the findings were that in each of the groups dermatoglyphic characteristics were significantly different from one another then this suggests that there are no fundamental and therefore consistent dermatoglyphic differences between the diseased groups studied. There must therefore be an underlying error which is conceptual as well as methodological and this must arise from the comparison of patients in any particular disease group studied with a group of 'normal' controls. It appears, however that all groups will inevitably differ whether or not they suffer from a particular disease. The comparison of the 'disease' with the 'normal' will, as in the past, inevitably but erroneously be attributed to a difference of the disease from the normal, i.e. a difference inherent in the disease. In this study individuals with atopic eczema, psoriasis and skin cancer comprise an appreciable part of the normal population and furthermore the many differences in dermatoglyphic prevalences found between them would tend to mask one another and conceal any defect specific to each clinical group. The question must be asked as to whether or not this 'mixed disease group' could be considered as representatives of a normal population. When the various sub-groups in this study were regrouped using the criterion of whether or not there was a known genetic component in their aetiology they could not be successfully separated using the dermatoglyphic parameters as might have been expected. Also the various groups with disorders which were closely related in dermatological terms did not align themselves with each other in canonical analysis as would have been expected. When the subjects were reclassified using the dermatoglyphic variables in discriminant function analysis the level of correct classification into their original groupings was very low.

It can, therefore be concluded that the findings in this study and that of previous workers, of significant changes in dermatoglyphic patterns in disease, is the inevitable consequence of the enormous range of variation of those dermatoglyphic

characteristics and not a feature of the disease. At first it is very difficult to accept the explanation of the simple statistical artefact of finding a 5% significance in 1 in 20 of a random series, since in the calculation, it was believed that such a possibility had been corrected for. It is now apparent that the error that has been made in this study and indeed in those of other investigators was in the assumptions about the number of correlations made. Thus although the statistics were corrected for the number of different dermatoglyphic characteristics studied, the number of different correlations of those characteristics that were found and actually used, was in fact very greatly in excess of that number. Thus in psoriasis, for example, a significantly increased occurrence of loops was found only on the little finger of female probands. The significance arises because the number of pattern variations studied, and corrected for, is far less than the possible number of pattern correlations that arise from them. If, instead of correcting statistically for the number of different patterns studied the more appropriate figure of the number of different correlations arising from them was used, none of the findings would have been found to be significant. When the statistically significant findings of other researchers are re-examined using this method they can be explained by the same statistical artefact. The problem can be controlled but never overcome by use of a more appropriate statistic because the number of correlations requiring a correction only becomes apparent in retrospect. The immense variety of correlations of pattern distribution cannot be managed statistically because the number of different patterns is as many as the number of individuals who possess them. This would explain the great number of different dermatoglyphic characteristics which have in the past been associated with specific disease, the low prevalence of the 'abnormalities', their arbitrary variety of form and their overriding characteristic that they cannot be confirmed. By contrast all the well established and reproducible disorder-dermatoglyphic associations have a high prevalence (>80%) of the abnormal pattern (e.g. Total Finger Ridge Count in Down's Syndrome etc.). It is scarcely surprising that these clear cut associations are few since

the dermatoglyphic pattern represents the fortuitous jostling of a host of moving tissues during early development. This local determination of dermatoglyphic pattern, which is at least partially haphazard, with its unreproducibility and, with few exceptions unpredictability, should always have been apparent and expected from the simple observation of the differences in dermatoglyphic pattern found between monozygotic twins.

On the other hand if the changes found in epidermal ridges as a result of the skin disorder itself are compared with empirical results of the study then these results are much more encouraging. As described in Section 9.4, the changes found in Darier's disease and in AED and Incontinentia Pigmenti seem capable of helping the clinician in a number of ways. The occurrence of pits and plaques in Darier's disease and the reduction in the number of sweat pores in AED and IP can be used as a non-invasive aid to diagnosis. They also allow predictions to be made before the other disease symptoms emerge e.g. in young children. They allow carrier detection to be carried out which could be used as an aid for genetic counselling, e.g. in Incontinentia Pigmenti females. They give information about the severity and course of the disease, e.g. severity of pitting in Darier's diminishes when patient is in remission. Also being a heritable trait it can be used as a convenient genetic marker for the study of the inheritance of the disorder within families.

One of the objectives of the investigation was to evaluate the possibility of constructing a diagnostic chart which would allow the clinician to diagnose various skin disorders simply by scoring the occurrence of specific dermatoglyphic traits in the patient, along the lines of the diagnostic indices produced by Ford-Walker (1957) and Preus (1977). This has proven to be an impossible task for the reasons explained above. In Darier's disease, AED and IP, however, the production of some form of diagnostic questionnaire with a scoring system to produce a diagnostic index capable of aiding in clinical diagnosis does appear to be a feasible proposition. The basis for this would be the methodology for pit and plaque estimation and for sweat pore counting which are described in Appendices 4 and 5 respectively.

Two major positive findings therefore emerge from this study, firstly; it provides the resolution of many years of small-sample investigations with inconclusive results, i.e. most of the cited earlier studies, and secondly; it identifies the potential for the positive use of the non-dermatoglyphic characteristics as an aid to early clinical diagnosis in some of the rare skin disorders studied.

BIBLIOGRAPHY

- Aase, J.M. and Smith, D.W. (1969): Congenital anaemia and triphalangeal thumbs: a new syndrome. J. Pediatr., 74:471.
- Abele, D., Dobson, R. and Graham, J. (1963): Heredity and psoriasis. Arch. Derm., 88:38.
- Abraham, J.M. and Snodgrass, G.J.A. (1969): Soto's syndrome of cerebral gigantism. Arch. Dis. Child., 44:203.
- Achs, R. and Harper, R.G. (1968): Dermatoglyphics. Am. J. Obstet. Gynecol., 101(7):1006.
- Achs, R., Harper, R.G. and Siegel, M. (1966): Unusual dermatoglyphic findings associated with rubella embryopathy. New. Eng. J. Med., 274:148.
- Aguilar, R., de Vargas, P. and Villaescusa, G. (1966): Familial dixoid lupus erythematosus. Actas Derm. (Madrid)., 57:357.
- Aleksandrowicz, J., Schiffer, Z. and Debski, T. (1966): Dermatoglyphics in leukaemia. Lancet, 2:1364
- Alexander, J.O. (1975): Dermatitis Herpetiformis. London: W.B. Saunders Co. Ltd.
- Almeida De Cabral, J.C., Kayth, H., Barcinski, M.A., Abreu, M.C., Mello, R.S., Santos, J., Cardoso, M.H. and Rodrigues, J. (1967): Dermatoglyphic studies in Turner's syndrome. Arq. Bras. Endocrinol. Metab. 16:149.
- Alter, M. (1967): Dermatoglyphics in phenylketonuria. Humangenetik. 4:23.
- Alter, M. (1970): Variation in palmar creases. Am. J. Dis. Child., 120:424.
- Alter, M., Gorlin, R., Yunis, J., Peagler, F. and Bruhl, H. (1966): Dermatoglyphics in XYY Klinefelter's syndrome. Am. J. Hum. Genet., 18:507.
- Alter, M. and Schulenberg, R. (1966): Dermatoglyphics in the rubella syndrome. J.A.M.A., 197:685.
- Alter, M. and Schulenberg, R. (1967): Dysplasia of epidermal ridges in a trisomy 18/normal mosaic. Dev. Med. Child. Neurol., 9:582
- Anderson, T.F. and Voorhees, J.S. (1984): Psoriasis; in Mackie, R.(ed): Current Perspectives in Immunodermatology. Edinburgh: Churchill Livingstone. pp. 161:179.
- Atkins, L., Holmes, L.B. and Riccardi, V.M. (1974): Trisomy 8. J. Pediatr., 84:302

- Ayraud, N., Darcourt, G., D'Oelsnitz, M., Poujol, J., Lavagna, J. and Capdeville, C. (1969): Syndrome 18p- : une nouvelle observation. Ann. Genet. (Paris), 12:122.
- Baker, H. and Wilkinson, D.S. (1972): Psoriasis. in: Rook, A., Wilkinson, D.S. and Ebling, F.J.G. (eds) Textbook of Dermatology. Oxford: Blackwell Scientific Pubs. pp. 1192:1244.
- Banach, K. (1977): Dermatoglyphics of patients with psoriasis and their family members. Przeegl. Dermatol., 64(4):423.
- Barbeau, A., Trudeau, J.G. and Coiteux, C. (1965): Fingerprint patterns in Huntington's Chorea and Parkinson's Disease. Can. Med. Assoc. J., 92:514
- Basan, M. (1965). Ectodermal dysplasia. Missing papillary pattern, nail disorders and furrows on four fingers. Arch. Klin. Exp. Derm., 222:546.
- Battle, H.I., Walker, N.F. and Thompson, N.W. (1973): Mackinder's hereditary brachydactyly: phenotypic, radiological, dermatoglyphic and genetic observations in an Ontario family. Ann. Hum. Genet., 36:415.
- Beck, J.S. and Rowell, N.R. (1966): Discoid lupus erythematosus. A study of the clinical features and biochemical and serological abnormalities. Quart. J. Med., 35:119
- Bellelli, F. (1939a): Un nuovo caso di pollice a tre falangi bilaterale. Riforma Med., 17:3.
- Bellelli, F. (1939b): Le linee papillari nelle sindattilce. Arch. Hal. Anat. Embriol., 42:423
- Berka, L., Mc Clure, P.D., Sonley, M.J. and Thompson, M.W. (1971): Dermatoglyphics in childhood leukaemia. Can. Med. Assoc. J., 105:476.
- Bettmann, S.Z. (1932a): Psoriasis und Haukonstitution. Arch. Dermatol. Syphil., 165:694
- Bettman, S.Z. (1932b): Ueber die Vierfingerfurche. Ztschr. Anat. Entwgesch., 98:487.
- Bidloo, G. (1685): Anatomia Humani Corporis. Amsterdam.
- Blackith, R.E. and Reyment, R.A. (1971): Multivariate Morphometrics. London: Academic Press.
- Blaylock, W.K. (1976): Atopic dermatitis: diagnosis and pathology. J. Allergy Clin. Immunol., 57:62.
- Bloch, B. (1926): Eigentumlicher bisher nicht beschriebene Pigmentaffektion (Incontinentia pigmenti). Schweiz Med. Wochenscheri, 56:404.

- Bonnevie, K. (1924): Studies on the papillary patterns of human fingers. J. Genet., 15:1.
- Bonnevie, K. (1929): Zur Mechanik der Papillarmusterbildung. Arch. I. Entwicklungsmechn. Organ. 177:384.
- Book, J.A. (1970): Epidermal ridge configurations in a boy with triploid/diploid mosaicism. Acta Genet. Med. Gemellol. (Roma), 19:417.
- Borgaonkar, D.S. and Leger, H. (1969): The triple-X syndrome. Birth Defects, 5(5):138.
- Borgaonkar, D.S. and Mules, E. (1970): Comments on patients with sex chromosome aneuploidy: dermatoglyphics, parental ages, Xga blood group. J. Med. Genet., 7:345.
- Borgaonkar, D.S. and Scott, C.I. (1969): Ring chromosome 18. Birth Defects, 5(5):158.
- Broholm, K.A., Edg-Olofsson, O. and Hall, B. (1968): An inherited chromosome aberration in a girl with signs of de Lange Syndrome. Acta Paediatr. Scand., 57:547.
- Burch, R.R.J. and Rowell, N.R. (1965a): Psoriasis: aetiological aspects. Acta Derm. Vener., 45:366.
- Burch, P.R.J. and Rowell, N.R. (1965b): Systemic lupus erythematosus: aetiological aspects. Amer. J. Med., 38:793.
- Burton, J.L. (1985): Essentials of Dermatology Edinburgh: Churchill Livingstone.
- Butler, J.M. and Hanifin, J.M. (1984): Immunology of atopic dermatitis; in Mackie, R. (ed): Current Perspectives in Immunodermatology. Edinburgh: Churchill Livingstone pp. 60-74.
- Butterworth, T. and Sterean, L.P. (1962): Clinical Genodermatology Baltimore: Williams and Wilkins Co.
- Cantwell, R.J. (1975): Congenital sensori-neural deafness associated with onycho-osteo dystrophy and mental retardation (D.O.O.R. Syndrome). Humangenetik, 26:261.
- Carney, R.G. (1976): Incontinentia pigmenti: a world statistical analysis. Arch. Dermatol., 112:535
- Cenani, A., Pfeiffer, R.A. and Simon, H.A. (1969): Ring chromosome 18 (46,XX,18r). Humangenetik, 7:351
- Champion, R.M. and Parish, W.E. (1972) Atopic Dermatitis in Rook et al (eds). Textbook of Dermatology. Oxford: Blackwell Scientific Pubs. pp. 419-434.
- Chang, C.H. (1967): Holt-Oram Syndrome. Radiology, 88:479.

- Cheah, J.S. and Tan, B.Y. (1969): Turner's syndrome (gonadal dysgenesis): clinical, dermatoglyphic and chromosomal features. Med. J. Malaya, 23:181.
- Colombo, A., Gasparoni, M.C., Biscatti, G. and Severi, F. (1973): Dermatoglifi e leucemia linfatica acuta nell' infanzia. Minerva Pediatr, 25:355.
- Conen, P.E., Erkman, B. and Metaxotou, C. (1966): The D Syndrome. Am. J. Dis. Child., 111:236.
- Crump, I.A. and Danks, D.M. (1971): Hypohidrotic ectodermal dysplasia: a study of sweatpores in the X-linked form and in a family with probable autosomal recessive inheritance. J. Pediatr., 78:466.
- Cummins, H. (1926): Epidermal ridge configurations in developmental defects, with particular reference to the ontogenetic factors which condition ridge direction. Am. J. Anat., 38:89.
- Cummins, H. (1939): Dermatoglyphic stigmata in mongoloid imbeciles. Anat. Rec., 73:407.
- Cummins, H. and Midlo, C. (1943): Finger Prints, Palms and Soles: An Introduction to Dermatoglyphics. New York: Dover Publications Inc.
- Cummins, H. and Sicomo, J. (1923): Plantar epidermal configurations in low grade syndactylism (Zygodactyly) of the second and third toes. Anat. Rec., 25:355.
- Cushman, C.J. and Soltan, H.C. (1969): Dermatoglyphics in Klinefelter's syndrome (47,XXY). Hum. Hered., 19:641.
- Cusumano, D., Berman, B. and Bershad, S. (1983): Dermatoglyphic patterns in patients with atopic dermatitis. J. Am. Acad. Dermatol., 2:207.
- Dahl, M.V. (1981): Clinical Immunodermatology. Chicago: Yearbook Medical Pubs.
- Dankmeijer, J. and Waltman, J.M. (1947): Lignes papillaires en cas de syndactylie. Acta Anat. (Basel), 4:108.
- Darier, J. (1889): Psorospermo folliculaire vegetante. Ann. Derm. Syph. (Paris), 10:59.
- David, T.J. (1969): Fingerprints in congenital heart disease. Bristol Medico-Chirurgica. Journal, 84:167.
- David, T.J. (1971) Dermatoglyphics in medicine. Bristol Medico-Chirurgica Journal, 86:19.
- David, T.J. and Ajdukiewicz, A.B. (1977). Palmar dermatoglyphics in celiac sprue.in: Mavalwala, J. (ed): Dermatoglyphics: an international perspective. The Hague: Mouton.
- David, T.J.; Ajdukiewicz, A.B. and Read, A.E. (1970): Fingerprint changes in Coeliac Disease. Br. Med. J., 4:594

- David, T.J., Ajdukiewicz, A.B. and Read, A.E. (1973): Dermal and epidermal ridge atrophy in coeliac sprue. Gastroenterology, 64:539.
- Davies, P.A. and Smallpiece, V. (1963): The single transverse crease in infants and children. Dev. Med. Child. Neurol., 5:491.
- Davison, B.C.C., Ellis, H.L., Kuzemko, J.A. and Roberts, D.F. (1967): Mental retardation with facial abnormalities, broad thumbs and toes and unusual dermatoglyphics. Dev. Med. Child. Neurol., 9:588.
- De Bie, S. and Malton, M.T. (1973): Dermatoglyphic analysis of primary and secondary cleft palate patients. Penrose Memorial Colloquium: Berlin.
- De Grouchy, J., Herrault, A. and Cohen-Solal, J. (1968): Une observation de chromosome 18 en anneau (18r). Ann. Genet. (Paris), 7:17.
- De Grouchy, J., Royer, P., Salmon, C. and Lamy, M. (1964): Deletion partielle des bras long du chromosome 18. Pathol. Biol. (Paris), 12:579.
- Dennis, R.L.H. (1977): Dermatoglyphic Studies. DYN, 4:1.
- Der Kaloustain, V.M. and Kurban, A.K. (1979): Genetic Diseases of the Skin. Berlin: Springer Verlag.
- Dineen, L.C. and Blakesley, B.C. (1973): Algorithm AS62: a generator for the sampling distribution of the Mann-Whitney U Statistic. Applied Statistics, 22:269.
- Dodinval, P., Leblanc, P., Delree, C. and Deslypere, P. (1971): Dysplasie des cretes epidermiques a heredite dominante autosomique: etude des dermatoglyphics d'une famille. Humangenetik, 11:230.
- Dubois, R.W., Weiner, J.M. and Dubois, E.L. (1976): Dermatoglyphic study of systemic lupus erythematosus. Arthritis Rheum., 19(1):83.
- Dziuba, P. (1972): Badania nad dermatoglifami dłoni i stop u pacjentów z rozszczepami wargi górnej, Wzrostka zębodołowego i podniebienia. Czas. Stomatol., 25:1195.
- Dziuba, P., Rubisz-Brzezinska, J. and Seferowicz, E. (1973). Dermatoglyphics in alopecia areata. Przeegl. Dermatol., 60(4):491
- Elbualy, M.S. and Schindler, J.D. (1970): Handbook of Clinical Dermatoglyphics. Coral Gables: Univ. of Miami Press..
- Esterly, N.B., Pashayan, H.M. and West, C.E. (1973): Concurrent hypohidrotic ectodermal dysplasia and X-linked ichthyosis. Am. J. Dis. Child., 126 (4):539.
- Fang, T.C. (1949): A comparative study of the a-b ridge count on the palms of mental defectives and the general population. J. Ment. Sci. 95:945.

- Fang, T.C. (1950): The third interdigital patterns on the palms of the general British population, mongoloid and non-mongoloid mental defectives. J. Ment. Sci., 96:780.
- Faulds, H. (1880): On the skin furrows of the hand. Nature, 22:65.
- Faulds, H. (1905): Guide to Finger-Print Identification. London: Hanley, Wood, Mitchell.
- Forbes, A.P. (1964): Fingerprints and palm prints (dermatoglyphics) and palmar-flexion creases in gonadal dysgenesis, pseudohypoparathyroidism and klinefelter's syndrome. N.Engl. J. Med., 270:1268.
- Fraga, A., Armendares, S. and Mintz, G. (1974): Dermatoglyphic patterns in systemic lupus erythematosus (S.L.E.) changes in patients with increased fetal wastage. Rheumatol., 1:35.
- Frias, J.L. and Smith, D.W. (1968): Diminished sweat pores in hypohydrotic ectodermal dysplasia: a new method for assessment. J. Pediatr., 72:606.
- Fried, K. and Fraser, W.I. (1972): Smith-Lemli-Opitz syndrome in an adult. J. Ment. Defic. Res., 16:30.
- Frost, P. and Van Scott, E.J. (1966): Ichthyosiform dermatoses: classification based on anatomic and biometric observations. Arch. Derm., 94:113.
- Fry, L., Seah, P.P., Riches, D.J. and Hoffbrand, A.V. (1973): Clearance of skin lesions in dermatitis herpetiformis after gluten withdrawal. Lancet, 1:258.
- Fry, L., Wognarowska, F.T. and Shahrads, P. (1981): Illustrated Encyclopaedia of Dermatology. Lancaster: MTP Press.
- Frydman, M. (1988): Familial simple hypohidrosis with abnormal palmar dermal ridges. Am. J. Med. Genet., 31(3):591.
- Galton, F. (1892): Finger Prints. London: Macmillan.
- Galton, F. (1895): Fingerprint Directories. London: Macmillan.
- Garina, T.A. (1978): Characteristics of dermatoglyphics in patients with atopic dermatitis. Vestn. Dermatol. Venerol., 7:19.
- Gellis, S.S. and Feingold, M. (1968): Sjögren-Larsson syndrome (congenital ichthyosis with spastic paralysis and oligophrenia). Am. J. Dis. Child., 116:653.
- Gibbs, R.C. (1967): Fundamentals of dermatoglyphics. Arch. Dermatol., 96:721.
- Gibb, R.C. and Warburton, D. (1968): Studies of dermatoglyphics in psoriasis. Fingerprints and palm prints in patients with psoriasis. J. invest. Derm., 51(4):259.

- Giroux, J. and Miller, J.R. (1967): Dermatoglyphics of the broad thumb and great toe syndrome. Am. J. Dis. Child., 113:207.
- Gladkova, T.D. and Lalaeva, A.M. (1972): Dermatoglyphics in patients with psoriasis disease. Voprosy Antropologii, 40:160.
- Goltz, R.W., Henderson, R.R. and Hitch, J.M. (1970): Focal dermal hypoplasia syndrome: a review of literature and report of two cases. Arch. Dermatol., 101:1.
- Goodman, R.M., Bat-Miriam Katznelson, M. and Manor, E. (1972): Campodactyly: occurrence of two new genetic syndromes and its relationship to other syndromes. J. Med. Genet., 9:203.
- Gorlin, R.J. and Chaudry, A.P. (1959): Oral manifestations of keratosis follicularis. Oral Surg., 12:1468.
- Gortat-zalewska, W. (1976): Studies of psoriatic families by means of the complex index of consistency of dermatoglyphic features. Przeql. Dermatol., 63(6):791.
- Grasse, F.R. and Opitz, J.M. (1971): The Brachmann-de Lange Syndrome. in: Gellis, S.S. (ed): Yearbook of Paediatrics Series. Chicago: Yearbook Pubs. pp. 485-492.
- Grumet, F.C. (1976): Tissue antigens in Psoriasis, in: Farber, E.M. and Cox, A.J. (eds). Psoriasis: Proceedings of 2nd International Symposium. Stamford Univ. Press pp. 134-139.
- Guanti, G., Petrinelli, P. and Schettini, F. (1971): Cytogenetical and clinical investigations in aplastic anaemia (Fanconi's type). Humangenetik, 13:222.
- Gustavson, K.H. and Jagell, S. (1980): Dermatoglyphic patterns in the Sjögren-Larsson syndrome. Clin. Genet. 17(2):120.
- Hale, A.R. (1952): Morphogenesis of volar skin in the human foetus. Am. J. Anat., 91:147.
- Hall, J.G., Levin, J., Kuhn, J.P., Ottenheimer, E.J., Van Berkim, K.A.P. and Mc Kusick, V.A. (1969): Thrombocytopenia with absent radius (TAR). Medicine (Baltimore), 48:411.
- Hanifin, J.M. and Lobitz, W.C. (1977): Newer concepts of atopic dermatitis. Arch. Dermatol., 113:663.
- Harper, P.S. (1978): Genetic heterogeneity in the ichthyoses. in: Marks, R. and Dykes, P.J. (eds): The Ichthyoses. Colchester: MTP Press Ltd. pp.127-136.
- Heet, H.L. and Keita, B. (1979): Dermatoglyphic divergence of the main racial branches of mankind. Birth Defects: Orig. Art. Series, 15(6):249.
- Henry, E.R. (1900): The Classification and Uses of Fingerprints. London: Routledge.

- Hermann, J. and Opitz, J.M. (1969): Dermatoglyphic studies in a Rubinstein-Taybi patient, her unaffected dizygous twin sister and other relatives. Birth Defects, 5(2):22.
- Herschel, W. (1880): Skin furrows of the hand. *Nature*, 23:76.
- Herschel, W. (1894): Fingerprints. *Nature*, 51:77.
- Heyl, T. (1971): Sunlight and Darier's disease. Brit. J. Derm., 85(7):57.
- Hirsch, W. and Schweichel, J.V. (1973): Morphological evidence concerning the problem of skin ridge formation. J. Ment. Defic. Res., 17:58.
- Hirth, L., Schopf, E., Benkmann, H.G., and Goedde, H. (1971): Dermatoglyphics in patients with endogenous eczema and a contribution to the technique of dactyloscopy. Anthropol. Anz., 33:26.
- Hoefnagel, D. and Gerald, P.S. (1966): Hereditary brachydactyly. Ann. Hum. Genet., 29:377.
- Holt, S.B. (1951): A comparative quantitative study of the finger-prints of mongoloid imbeciles and normal individuals. Ann. Eugen., 15:355.
- Holt, S.B. (1961): Quantitative genetics of fingerprint patterns. Brit. Med. Bull., 17:247.
- Holt, S.B. (1968): The Genetics of Dermal Ridges. Springfield, Illinois: Charles C. Thomas Pubs.
- Holt, S.B. (1969): Dermatoglyphics and sex chromosomes. in: Selected Topics on Genital anomalies and Related Subjects. pp. 375-395.
- Holt, S.B. (1970): The morphogenesis of volar skin. Dev. Med. Child. Neurol. 12:369.
- Holt, S.B. (1972): The effect of absence of thumb on palmar dermatoglyphics. J. Med. Genet., 9:448.
- Holt, S.B. and Lindsten, J. (1964): Dermatoglyphic anomalies in Turner's syndrome. Ann. Hum. Genet., 28:87.
- Hooft, C., Schotte, H. and Van Hooren, G. (1968): Gigantisme cerebral familial. Ann. Pediatr. Belg., 22:172.
- Hook, E.B., Achs, R.S. and Harper, R. (1971): An investigation of dermatoglyphic asymmetry in rubella embryopathy. Teratology, 4:405.
- Hoyer, H., Agdal, N. and Munkvad (1982): Palmar hyperlinearity in atopic dermatitis. Acta. Derm. Venereol. (Stockh.), 62(4):346.
- Hubbell, H.R., Borgaonkar, D.S. and Bolling, D.R. (1973): Dermatoglyphic studies of the 47,XXX male. Clin. Genet., 4:145.
- Hunter, J.A.A. and Savin, J.A. (1984): Common Diseases of the skin: an illustrated guide for general practice. Oxford: Blackwell Scientific Pubs.

- Hunter, J.A.A., Savin, J.A. and Dahl, M.V. (1989): Clinical Dermatology. Oxford: Blackwell Scientific Pubs.
- Iqbal, S., Premalatha, S. and Zahra, A. (1985). Dermatoglyphics in vitiligo. Int. J. Dermatol., 8(24):510.
- Jaju, M., Reddy, P.S., Rajeshivari, I.R., Sunder, S., Murthy, K.J.R., Rao, P.V.R. and Jain, S.N. (1986): Dermatoglyphic studies in allergic disorder. J. Assoc. Phys. India, 34(7):494.
- Jancar, J. (1965): Rubinstein-Taybi's syndrome. J. Ment. Defics. Res., 9:265.
- Jilek, M. (1972): Comparative study of finger dermatoglyphics in psoriatic patients. Cesk. Dermatol., 47:154.
- Jones, B. and Thompson, H. (1973): Triphalangeal thumbs associated with hypoplastic anaemia. Pediatrics, 52:609.
- Jongbloet, P.H. and Van Kempen, C. (1968): Dermatoglyphics in partial C trisomies. Lancet, 1:1428.
- Jordon, R.E. (1984): The major immunobullous diseases. in: Mackie, R.M. (ed): Current Perspectives in Immunodermatology. Edinburgh: Churchill Livingstone. pp. 3-21.
- Kapur, T.R. and Verma, R.D. (1982): Study of dermatoglyphics in dermatoses. Ind. J. Derm. Vener. Leprol., 48:193.
- Katz, S.I. and Strober, R.W. (1978): The pathogenesis of dermatitis herpetiformis. J. invest Derm., 48:193.
- Kendall, M. (1980): Multivariate Analysis. 2nd Ed. London: Charles Griffin and Co. Ltd.
- Kimura, S. and Kitagawa, T. (1986): Embryological development of human palmar, plantar and digital flexion creases. Anat. Rec., 216(2):191.
- Kleinebrecht, J., Degenhardt, K.H., Grubisic, A., Gunther, E. and Suycar, J. (1981): Sweat pore counts in ectodermal dysplasia. Hum Genet. 57:437.
- Kobyliamsky, E. and Livshits, G. (1986): Anthropometric multivariate structure and dermatoglyphic peculiarities in biochemically and morphologically different heterozygous groups. Am. J. Phys. Anthrop., 70(2):251.
- Koerner, D.M. (1933): Ein Beitrag zur Syndaktylie und deren Vererbung. Mitt. Anthropol. Ges. Wien., 63:84.
- Koukkanen, K. (1969): Ichthyosis vulgaris. Acta Derm. Venereol (Stockh)., 49(62):14.
- Krieger, T.Z. (1934): Die Papillarleistenzeichnungen am Handen von Psoriatikern: Z. Anat. Entwicklungsgesch, 102:389.

- Laha, N.N., Nagar, K.S., Sepaha, G.C. and Sethi, N.C. (1976): Dermatoglyphic patterns in psoriasis. International Symposium on Psoriasis: Stanford Univ. pp. 342-344.
- Lal, S. (1977): Finger ridge patterns in psoriasis. Indian J. Dermatol., 22(4):149.
- Lapiere, S. and Dodinval, P. (1967): Ectodermal anhidrotic dysplasia in 3 brothers and their first cousin. Ann. Derm. et Symp. (Paris)., 94:477.
- Laurent, C., Michel, M., Philippe, N. and Pincon, J.A. (1970): Deletion die bras court du chromonsome 18 et mosaique paternelle. Ann. Genet. (Paris)., 13:56.
- Lee, C.S.N., Boyer, S.H., Bowen, P., Weatherall, D.J., Rosenblum, H., Clark, D.B., Duke, J.R., Liboro, C., Bias, N. and Borgaon, D.S. (1966): The Di trisomy syndrome: three subjects with unequally advancing development. Bull. Hopkins. Hosp., 118:374.
- Leueune, J., Berger, R., Lafourcade, J. and Rethore, M.-O. (1966): La deletion partielle du bras long du chromosome 18. Individualisation d'un nouvel etat morbide. Ann. Genet. (Paris)., 9:32.
- Lejeune, J., Gautier, M., Lafourcade, J., Berger, R. and Turpin, R. (1964): Deletion partielle du bras court du chromosome 5 cinquieme cas de syndrome du cri du chat. Ann. Genet. (Paris)., 7:7.
- Lerner, A.B. (1959): Vitiligo. J. invest. Derm., 32:285.
- Leutgeb, C., Bandmann, H.J. and Breit, R. (1972): Dermatoglyphics, ichthyosis vulgaris and atopic dermatitis. Arch. Dermatol. Forsch., 244:354.
- Linss, G. (1983): Dermatoglyphics and basal cell naevus syndrome (Gorlin-Goltz Syndrome). Dermatol. Monatsschr., 169(10):652.
- Lobitz, W.C. and Dobson, R.L. (1956): Physical and physiological clues for diagnosing eczema. J.A.M.A., 161:1226.
- Loesch, D.Z. (1971): Genetics of dermatoglyphic patterns on palms. Ann. Hum. Genet. 34:277.
- Loesch, D.Z. (1986): Bivariate and multivariate analysis of skin ridge pattern intensities. Am. J. Phys. Anthropol., 69(3):287.
- Loesch, D.Z. and Smith, C.A.B. (1975): Discriminant functions and 21 - trisomy mosaicism. Ann. Hum. Genet., 39:127.
- Mackie, R.M. (1986): Clinical Dermatology: An Illustrated Textbook. (2nd ed.). Oxford: Oxford Med. Pubs.
- McKenzie, H.J. and Penrose, L.S. (1952): Two pedigrees of ectrodactyly. Ann. Eugen., 16:88.

- McRae, W.M., Sandor, G., Sangani, A.P. and Stalker, R. (1971): Fingerprint changes in coeliac disease. Br. Med. J., 3:109.
- Mahalanobis, P.C. (1936): On the generalised distance in statistics. Proc. Nat. Inst. Sci. India., 2:49.
- Maize, J.C. (1976): Atopic dermatitis. Int. J. Dermatol., 15:555.
- Malpighi, M. (1686): De Externo Tactus Organo. London.
- Malpuech, G., Raynaud, E.J., Berlin, J., Godeneche, P. and De Grouchy, J. (1971): Deletion du bras court du 18 par translocation t (G-; 18;+). Une etude en fluorescence par la moutarde de quinacrine. Ann. Genet. (Paris)., 14:213.
- Majumder, P.P., Das, S.K. and Li, C.C. (1988): A genetic model for vitiligo. Am. J. Hum. Genet., 43:119.
- Mann, P.R. and Haye, K.R. (1970): An electron microscope study on the acantholytic and dyskeratotic processes in Darier's disease. Brit. J. Derm. 82:561
- Marks, J. (1977): Dogma and dermatitis herpetiformis. Clin. Exp. Dermatol., 2:189.
- Marks, J., Shuster, S. and Watson, A.J. (1966): Small bowel changes in dermatitis herpetiformis. Lancet, 2:1280.
- Marks, J., Birkett, D., Shuster, S. and Roberts, D.F. (1970): Small intestinal mucosal abnormalities in relatives of patients with dermatitis herpetiformis. Gut, 11:493.
- Massumi, R.A. and Nutter, D.O. (1966): The syndrome of familial defects of heart and upper extremities (Holt-Oram Syndrome). Circulation, 34:65.
- Mayer, J.C.A. (1788): Anatomische kupfertafeln nebst dazu gehorigen Erklarungen 1783-88: Berlin.
- Meier, R. J. (1980): Anthropological dermatoglyphics: a review. Yrbk. Phys. Anthropol., 23:147.
- Menser, M.A. and Purvis-Smith, S.G. (1969): Dermatoglyphic defects in children with leukaemia. Lancet, 1:1076.
- Mier, P.D. and Van der Kerkhof, P.C.M. (1986): Textbook of Psoriasis. Edinburgh. Churchill. Livingstone.
- Miller, J.R. (1973): Dermatoglyphics. J. invest. Derm. 60(6):435.
- Miller, J.R. and Giroux, J. (1966): Dermatoglyphics in paediatric practice. J. Pediatr., 69:302.
- Miller, O.J., Breg, W.R., Warburton, D., Miller, D.A., Decapoa, A., Allerdice, P., Davis, J., Klinger, H., McGilvray, E. and Allen, F.H. (1970): Partial deletion of the short arm of chromosome No.4 (4p-): clinical studies in five unrelated patients. J. Pediatr., 77:792.

- Minkov, D. (1982): Dermatoglyphics in psoriasis patients. Folia. Med. (Plovdiv), 24(3):43.
- Moss, C. and Ince, P. (1987): Anhidrotic and achromians lesions in incontinentia pigmenti. Br. J. Derm., 116:839.
- Muller, S.A. and Wirkelmann, R.K. (1963): Alopecia areata: an evaluation of 736 patients. Arch. Derm. 88:290.
- Mulvihill, J.J. and Smith, D.W. (1969): The genesis of dermatoglyphics. J. Pediatr., 75:579.
- Mylotte, M., Egan-Mitchell, B., Fottrell, P.F., Mc Nichol, B. and Mc Carthy, C.F. (1972): Fingerprints in patients with coeliac disease and their relatives. Br. Med. J., 4(5833): 144.
- Nagar, K.S., Laha, N.N. and Sethi, N.C. (1981): Palmar dermatoglyphics in psoriasis: a pilot study. Indian J. Dermatol. Venereol. Leprol., 47(4):197.
- Nevo, S., Benderly, A., Levy, J. and Bat-Miriam Katznelson, M. (1972): Smith-Lemli-Opitz syndrome in an inbred family. Am. J. Dis. Child., 124:431.
- Nie, N.H., Hull, C.H., Jenkins, J.C., Steinbrenner, K. and Bent, D.H. (1975): Statistical Package for the Social Sciences. New York: McGraw Hill.
- Nora, A.H., Nora, Y.Y. and Fernbach, D.J. (1969): Dermatoglyphics and leukaemia. Lancet, 2:905.
- Norins, A.L. (1971): Atopic dermatitis. Pediatr. Clin. North Am., 18:801.
- Norusis, M.J./SPSS (1990): SPSS Advanced Statistics Users Guide . Chicago: SPSS Inc.
- Novotny, F. and Pribikova, M. (1981): Dermatoglyphic tests in psoriatics and members of their families. Cesk. Dermatol. 56(1):25.
- Ohler, E.A. and Cummins, H. (1942): Sexual differences in breadths of epidermal ridges on the fingertips and palms. Am. J. Phys. Anthrop., 29:341.
- Okajuna, M. (1975): Development of dermal ridges in the fetus. J. Med. Genet., 12:243.
- O'Leary, E., Slaney, J., Bryant, D.G. and Fraser, F.C. (1986): A simple technique for recording and counting sweat pores on the dermal ridges. Clin. Genet., 29(2):122.
- Omulecki, A. and Banach, K. (1975): Dermatoglyphics in hereditary ichthyosis vulgaris. Przeql. Dermatol. 62(4):505.

- Oyhenart-Perera, M., Kolski, R. and Salvat, G. (1982): Dermatoglyphics in vitiligo. Prog. Clin. Biol. Res. 84:427.
- Parker, C.E., Mavalwala, J., Koch, R., Hatashita, A. and Derencsenyi, A. (1972): The syndrome associated with the partial deletion of the long arm of chromosome 18 (18q-). Calif. Med., 117:65.
- Passarge, E. and Frias, E. (1973): X chromosome inactivation in x-linked hypohidrotic ectodermal dysplasia. Nature New Biol., 245:1.
- Penrose, L.S. (1954): The distal triradius t on the hands of parents and sibs of mongol imbeciles. Ann. Hum. Genet., 19:10
- Penrose, L.S. (1963): Fingerprints, palms and chromosomes. Nature, 197:933.
- Penrose, L.S. (1965): Dermatoglyphic topology. Nature, 205:544.
- Penrose, L.S. (1967): Finger print pattern and the sex chromosomes. Lancet, 1:298.
- Penrose, L.S. (1968a): Medical significance of fingerprints and related phenomena. Br. Med. J., 2:321.
- Penrose, L.S. (1968b): Memorandum on dermatoglyphic nomenclature. Birth Defects: Orig. Art. Series., 4:1.
- Penrose, L.S. (1969a): Dermatoglyphics in trisomy 17 or 18. J. Ment. Defic. Res., 13:44.
- Penrose, L.S. (1969b): Dermatoglyphics. Sci. Am., 221:72.
- Penrose, L.S. (1972): Dermatoglyphic patterns in a case of trisomy 8. Lancet, 1:957.
- Penrose, L.S. and Holt, S.B. (1966): Note on dermatoglyphic data in a brachydactylous family. Ann. Hum. Genet., 29:383.
- Penrose, L.S. and Loesch, D. (1967): A study of dermal ridge width in the second (palmar) interdigital area with special reference to aneuploid states. J. Ment. Defic. Res., 11:36.
- Penrose, L.S. and Loesch, D. (1970): Topological classification of palmar dermatoglyphics. J. Ment. Defic. Res., 14:111.
- Penrose, L.S. and Loesch, D. (1971a): Dermatoglyphic patterns and clinical diagnosis by discriminant function. Ann. Hum. Genet., 35:51.
- Penrose, L.S. and Loesch, D. (1971b): Diagnosis with dermatoglyphic discriminant. J. Ment. Defic. Res., 15:185.
- Penrose, L.S. and O'Hara, P.T. (1973): The development of the epidermal ridges. J. Med. Genet., 10:201.
- Pfeiffer, R. A. and Kumbhani, H.K. (1967): Dermatoglyphics in de Lange's syndrome. in: Hirsch, W. (ed): Hautleisten und Krankheiten. Grosse Verlag: Berlin. pp. 137-140.

- Pfeiffer, R.A. and Schultze zu Berge, V. (1964): Untersuchungen zur Frage der Hautleisten und Furchen bei Extremitätenmissbildungen. Z. Menschl. Vererb. Konstitutionsl., 37:677.
- Piatkowska, E. and Sokolowski, J. (1973): Dermatoglyphics in primary and secondary cleft palate. Am. J. Hum. Genet., 25:575.
- Pilsbury, D.M. and Heaton, C.L. (1980): A Manual of Dermatology. 2nd ed. Philadelphia: W.B. Saunders Co.
- Plato, C.C. and Garruto, R.M. (1990): Historical notes on dermatoglyphics: from Purkinje to Cummins. in: Durham, N.M. and Plato, C.C. (eds): Trends in Dermatoglyphic Research. Dordrecht, Netherlands: Kluwer Academic Press. pp. 2-9.
- Polani, P.E. and Polani, N. (1969): Chromosome anomalies, mosaicism and dermatoglyphic asymmetry. Ann. Hum. Genet., 32:391.
- Pollitzer, W.S. and Plato, C.C. (1979): Anthropology and dermatoglyphics. Birth Defects: Orig. Art. Series., 15(6):211.
- Premalatha, S. (1984): Palmar dermatoglyphics in genodermatoses studied in a skin clinic. Indian J. Dermatol., 29(1):21.
- Preus, M. and Clarke Fraser, F.C. (1972): Dermatoglyphics and syndromes. Am. J. Dis. Child., 124:933.
- Priest, J.H. (1967): Dermatoglyphics in ectodermal dysplasia. Lancet, 2:1093.
- Purkinje, J.E. (1823): Commentatio de Examine Physiologico Organi Visus et Systematis Cutanei. Breslau: Vratislaviae Typis Universitat.
- Purvis-Smith, S.G., Howard, P.R. and Menser, M.A. (1969): Dermatoglyphic defects and rubella teratogenesis. J.A.M.A., 209:1865.
- Purvis-Smith, S.G. and Menser, M. (1968): Dermatoglyphics in adults with congenital rubella. Lancet, 2:141.
- Purvis-Smith, S.G. and Menser, M. (1969): Dermatoglyphic defects in children with leukaemia. Lancet, 5:1076.
- Purvis-Smith S.G. and Menser, M.A. (1973a): Genetic and environmental influences on digital dermatoglyphics in congenital rubella. Pediatr. Res., 7:215.
- Purvis-Smith, S.G. and Menser, M.A. (1973b): Dermatoglyphics in children with acute leukaemia. Br. Med. J., 4:648:
- Qazi, Q.H., Fikrig, S.M. and Smithwick, E.M. (1974): Dermatoglyphics and systemic lupus erythematosus (SLE). Pediatr. Res., 8:394.
- Qazi, Q.H. and Smithwick, E.M. (1970): Triphalangy of thumbs and great toes. Am. J. Dis. Child., 120:255.

- Raff, M. and Szilvassy, J. (1989): Specific dermatoglyphic patterns: a characteristic manifestation of acantholytic dyskeratotic dermatoses. J. Am. Acad. Dermatol., 21:958.
- Rajka, G. (1975): Atopic Dermatitis. Philadelphia: W.B. Saunders Co.
- Rao, C.R. (1952): Advanced Statistical Methods in Biological Research. New York: J. Wiley and Sons.
- Reinwein, H., Gorman, L.Z. and Wolf, U. (1967): Defizienz am langen Arm eines chromosoms Nr. 18 (46XX,18q-). Z. Kinderheilkd., 101:152.
- Ricci, N., Dallapiccola, B., Ventiniglia, B. and Preto, G. (1970): Chromosoma 18 and anell. Acta Genet. Med. Gemellol. (Roma), 19:439.
- Roberts, D.F. (1979): Dermatoglyphics and human genetics. Birth Defects: Orig. Art. Series, 15(6):475.
- Roberts, D.F. (1982): Population variation in dermatoglyphics: field theory. Prog. Clin. Biol. Res., 84:79.
- Roberts, D.F., Abdullah, N., Marks, J. and Shuster, S. (1978): Dermatoglyphics in dermatitis herpetiformis. Br. J. Derm., 99:627.
- Roberts, D.F. and Coope, E. (1975): Components of variation in a multifactorial character: a dermatoglyphic analysis. Hum. Biol., 47:169.
- Robinow, M. and Johnson, G.F. (1972): Dermatoglyphics in distal phalangeal hypoplasia. Am. J. Dis. Child., 124:860.
- Rodewald, A. and Zahn-Messow, K. (1982): Dermatoglyphic findings in families with x-linked hypohydrotic (or anhidrotic) ectodermal dysplasia (HED). Clin. Biol. Res., 84:451.
- Rook, A., Wilkinson, D.S., Ebling, F.J.G., Champion, R.H. and Burton, J.L. (1986): Textbook of Dermatology. 4th ed. vols. 1-3. Oxford: Blackwell Scientific Pubs.
- Rosner, F. (1969): Dermatoglyphics in leukaemic children. Lancet, 2:272.
- Rosner, F. (1970): Dermatoglyphics in leukaemia. Lancet, 2:882.
- Rosner, F. and Aberfeld, D.C. (1970): Dermatoglyphics in Holt-Oram Syndrome. Arch. Intern. Med., 126:100.
- Rott, H. D. (1984): Partial sweat gland aplasia in incontinentia pigmenti Bloch-Sulzberger: implications for nosologic classifications. Clin. Genet., 26:36.
- Saha, K.C. (1969): Preliminary observation on dermatoglyphics in genodermatosis. Indian J. Dermatol, 14:118.
- Sahasrabudde, R.G., Singh, G. and Agarwal, S.P. (1975): Dermatoglyphics in vitiligo. Indian J. Dermatol., 21:201.

- Sanchez Cascos, A. (1964): Finger-print patterns in congenital heart disease. British Heart Journal, 26:524.
- Sanchez Cascos, A. (1967): Holt-Oram Syndrome. Acta Paediatr. Scand., 56:313.
- Sanderson, K.V. (1986): Vitiligo. in: Rook, A. et al (eds): Textbook of Dermatology. Oxford: Blackwell Scientific Pubs. pp. 1952-59.
- Sarojini, P.A., Gopala Krishnan Nair, T.V. and Khaleel, S. (1977): Dermatoglyphics in Darier's disease: Indian J. Dermatol., 43:95.
- Schaumann, B. and Alter, M. (1973): Dermatoglyphics in cerebral gigantism. Int. Dermatoglyphics Conf.: Peterborough Canada.
- Schaumann, B. and Alter, M. (1976): Dermatoglyphics in Medical Disorders. New York: Springer Verlag.
- Schaumann, B., Cervenka, J. and Gorlin, R.J. (1974): Dermatoglyphics in trisomy 8 mosaicism. Humangenetik, 24:201.
- Schlegal, R.J., Neu, R.L., Carneiro, L.J., Reiss, J.A., Nolan, T.B. and Gardner, L.I. (1967): Cri-du-chat syndrome in a 10 year old girl with deletion of the short arms of chromosome number 5. Observations on dermatoglyphics, maxillo-mandibular measurements and sound spectrograms. Helv. Pediatr. Acta., 22:2.
- Schroter, J.F. (1814): Das merischliche Gefuhl oder Organ des Getastes: Leipzig.
- Schumacher, H. (1969): Das Smith-Lemli-Opitz Syndrome. Z. Kinderheilkd., 105:88.
- Schur, P.H. (1990): Fingerprint analysis of patients with systemic lupus erythematosus and their relatives. J. Rheumatol., 17(4):482.
- Selmanowitz, V.J. and Porter, M.J. (1967): Sjogren-Larsson Syndrome. Amer. J. Med., 42:412.
- Selmanowitz, V.J., Victor, S., Warburton, D. and Orentreich, N. (1974): Fingerprint arches in alopecia areata. Arch. Dermatol., 110(4):570.
- Sharma, N.K., Sarin, R.C. and Prabhakar, B.R. (1977): Study of dermatoglyphics in dermatoses. Ind. J. Dermatol., 43:262.
- Shions, H. (1969): Dermatoglyphics of XYY Klinefelter's syndrome. Tohoku J. Exp. Med., 98:1.
- Shiono, H. and Kadowaki, J.I. (1978): Dermatologic uses of dermatoglyphics. Int. J. Dermatol., 17(2):134.
- Shiono, H., Kadowaki, J.I. and Kasahara, S. (1969): Dermatoglyphics of Down's Syndrome in Japan. Tohoku J. Exp. Med., 99:107.

- Shiono, H., Minami, R., Shinoda, M. and Nakao, T. (1971): Dermatoglyphics in Rubinstein-Tayki Syndrome in Japan. Tohoku. J. Exp. Med., 104:19.
- Shuster, S. (1987): Understanding skin disease. 'Triangle': Sandoz Jour of Med. Sci., 26:125.
- Silver, W.E. (1968): Dermatoglyphics and cleft lip and palate. Cleft Palate J., 3:368.
- Simpson, N.E and Brissenden, J.E. (1973): The Rubinstein-Tayki syndrome: familial and dermatoglyphic data. Am. J. Hum. Genet., 25:225.
- Singh, P.K., Pandey, S.S. and Singh, G. (1983a): Dermatoglyphics in psoriasis. Indian J. Dermatol., 28(2):47.
- Singh, P.K., Pandey, S.S. and Singh, G. (1983b): Palmar patterns in vitiligo. Indian J. Dermatol., 28(3):91.
- Singh, P.K., Pandey, S.S. and Singh, G. (1984a): Dermatoglyphics in pemphigus. Indian. J. Dermatol., 24(2):9.
- Singh, P.K., Pandey, S.S. and Singh, G. (1984b): Dermatoglyphics in discoid lupus erythematosus. Indian J. Dermatol., 29(3):1.
- Singh, P.K., Pandey, S.S. and Singh, G. (1985a): Dermatoglyphics in ichthyosis vulgaris. Indian J. Dermatol., 30(2):25.
- Singh, P.K., Pandey, S.S. and Singh, G. (1985b): Dermatoglyphics in alopecia areata. Indian J. Dermatol., 30(3):3.
- Singh, P.K., and Pandey, S.S and Singh, G. (1987): Dermatoglyphics in auto-immune dermatoses. Indian J. Dermatol., 32(1):15.
- Singh, P.K., Pandey, S.S., Singh, G. and Girgla, H.S. (1983): Digital patterns in vitiligo. Indian J. Dermatol., 49:68.
- Sjogren, T. and Larsson, T. (1957): Oligophrenia in combination with congenital ichthyosis and spastic disorders: a clinical and genetic study. Acta psychiat. Scand., 32(113):1.
- Smith, D.A. (1984): Hyperlinear patterns in atopic dermatitis: a manifestation of ichthyosis vulgaris? Cutis, 34(1):49.
- Smith, D.W., Lemli, L. and Opitz, J.M. (1964): A newly recognised syndrome of multiple congenital anomalies. J. Pediatr., 64:210.
- Smith, E.B. and Jetton, R.L. (1970): Punctate pits and keratosis of the palmar creases. Southern Med. Journal., 63(11)1291.
- Smith, G.F. (1966): A study of the dermatoglyphs in the de Lange syndrome. J. Ment. Defic. Res., 10:241.
- Sokolowski, J., Knaus, A. and Kleczkowska, A.A. (1969): Dermatoglyphics of two cases of x tetrasomy. Am. J. Hum. Genet., 21:559.

- Solomon, L. and Keuer, E.J. (1980): The ectodermal dysplasias. Arch. Dermatol., 116:1295.
- Sousa, J.S. de and Duarte, J.P. (1974): Fingerprints in childhood coeliac disease. Arch. Dis. Child., 49:80.
- SPSS (1988): SPSS-X Users Guide (3rd Ed.). Chicago: SPSS Inc.
- Stukovsky, R., Karasova, M., Pagacova, E., Durikova, M. and Derer, M. (1979): Quantitative evaluation of digital dermatoglyphs in atopic eczema. Bratisl. Lek. Listy. (Czech)., 72(5):558.
- Sulzberger, M.B. (1927): Uber eine bisher nicht beschriebene congenitale pigmentanomalie (Incontinentia pigmenti). Arch. Derm. Syph. (Berlin)., 154:19.
- Sutarman, A. and Thomson, M.L. (1952): A new technique for enumerating active sweat glands in man. J. Physiol., 117:51.
- Suvorova, K.N. (1989): Dermatoglyphic characteristics in hereditary ichthyosis. Vestn. Dermatol. Venerol., 1:18.
- Szilvassy, J., Raff, M. and Wagenbichler, P. (1975): Das Hautleistensystem bei 10 patienten mit morbus darier. Anthropologische Gesellschaft (Wein), 1:25.
- Temtamy, S. and Mckusick, V.A. (1969): Synopsis of hand malformations with particular emphasis on genetic factors. Birth Defects, 5(3):125.
- Till, M., Larrauri, S. and Smith, P.G. (1978): Dermatoglyphics in childhood leukaemia: a guide to prognosis and aetiology? Br. J. Cancer, 37:1063.
- Tuncbilek, E., Atasü, M. and Say, B. (1972): Dermatoglyphics in trisomy 8. Lancet, 2:821.
- Uchida, I.A., Miller, J.R. and Soltan, H.C. (1964): Dermatoglyphics associated with XYY chromosome complement. Am. J. Hum. Genet., 16:284.
- Uchida, I.A., Patou, K. and Smith, D.W. (1962): Dermal patterns of 18 and D1 trisomies. Am. J. Hum. Genet., 13:345.
- Uehara, M. and Hayashi, S. (1981): Hyperlinear palms: association with ichthyosis and atopic dermatitis. Arch. Dermatol., 117(8):490.
- Verbov, J.L. (1967): Simian Line and psoriasis. Lancet., 2:779.
- Verbov, J.L. (1968): Dermatoglyphic and other findings in alopecia areata and psoriasis. Br. J. Clin. Pract. 22(6):257.
- Verbov, J.L. (1969): Dermatoglyphics and leukaemia. Lancet., 2:323.
- Verbov, J.L. (1970a): Dermatoglyphics in leukaemia. J. Med. Genet., 7:125.

- Verbov, J.L. (1970b): Clinical significances and genetics of epidermal ridges: a review of dermatoglyphics. J. invest. Dermatol., 54:261.
- Verbov, J.L. (1970c): Hypohidrotic (or anhidrotic) ectodermal dysplasia: an appraisal of diagnostic methods. Br. J. Dermatol., 83:341.
- Verbov, J.L. (1971): Fingerprint changes in coeliac disease. Br. Med. J., 1:48.
- Verbov, J.L. (1972): Dermatoglyphic and other findings in atopic dermatitis. Trans. St. John's Hosp. Derm. Soc., 58(1):81.
- Verbov, J.L. (1973): Hypohidrotic ectodermal dysplasia: unusual palm print in a heterozygote. Br. J. Derm., 88:92.
- Verbov, J.L. (1979): Atopic dermatitis. Practitioner, 223:820.
- Verbov, J.L. (1985): Dermatoglyphics. Int. J. Dermatol., 24(10):640.
- Verbov, J.L., Kumar, P.J. and Marks, R. (1971): Fingerprint changes in dermatitis herpetiformis. Br. Med. J., 4:300.
- Verma, K.C. and Jain, V.K. (1981): Dermatoglyphics in vitiligo. Indian J. Dermatol., 47(2):102.
- Verma, K.C., Jain, V.K. and Joshi, R.K. (1981): Dermatoglyphics in ichthyosis and alopecia areata. Indian J. Dermatol., 47(1):35.
- Verma, K.C., Joshi, R.K. and Jain, V.K. (1980): Dermatoglyphics in psoriasis. Indian J. Dermatol., 46(1):28.
- Vormittag, W., Weninger, M., Scherak, O. and Kolarz, G. (1981): Dermatoglyphics and systemic lupus erythematosus. Scand. J. Rheumatol (Sweden), 10(4):296.
- Walbaum, R., Farriaux, J.-P., Breynaert, R. and Fontaine, G. (1966): La trisomie 18 et son diagnostic dermatoglyphique. Ann. Pediatr. (Paris), 13:794.
- Walker, N.F. (1957): The use of dermal configurations in the diagnosis of mongolism. J. Pediatr., 50:19.
- Warburton, D. (1969): Comments on dermatoglyphics: Birth Defects 5(3):123.
- Warburton, D. and Miller, O.J. (1967): Dermatoglyphic features of patients with a partial short arm deletion of a B-group chromosome. Ann. Hum. Genet., 31:189.
- Weizman, Z. (1990): Dematoglyphic (fingerprint) patterns in coeliac disease. J. Pediatr. Gastroenterol. Nutr., 10(4):451.
- Wendt, G.C., Rube, M. and Kindermann, I. (1971): Papillarleisten und Krankheit. Deutsche Medizinische wochenschrift, 96:1056.

- Wertelecki, W. (1979): The simian and sydney crease. Birth Defects: Orig. Art. Series., 15(6)455.
- Wertelecki, W., Plato, C.C. and Fraumeni, J.F. (1969): Dermatoglyphics in leukaemia. Lancet., 2:806.
- Wertelecki, W., Plato, C.C., Fraumeni, J.F. and Niswander, J.D. (1973): Dermatoglyphics in leukaemia. Pediatr. Res., 7:620.
- Whipple, I.L. (1904): The ventral surface of the mammalian chirodium. J. Morph. Anthropol., 49:153.
- White, J.C. (1889): A case of keratosis (ichthyosis) follicularis. J. cutan. genito-urin. Dis., 7:201.
- Wilder, H.H. (1902): Palms and soles. Am. J. Anat., 1:423.
- Wittwer, B. (1967): Dermatoglyphics in cheilognathopalatoschisis. Lancet., 2:617.
- Wittwer, B., Breucker, G. and Rockahr, G. (1970): New findings concerning the genetics of endogenous eczema. Dermatologische Monatsschrift, 156(5):534.
- Wolf, V. Reinwein, H., Porsch, R., Schroter, R. and Baitsch, H. (1965). Defizienz an den kurzen Armen eines chromosoms Nr. 4. Humangenetik, 1:397.
- Zaias, N. and Ackerman, A.B. (1973): The nail in Darriers-White disease. Arch. Derm., 107:193.

ADDENDUM

- Blanjero, J. (1988): Estimating F/st using multivariate polygenic traits. Am. J. Phys. Anthrop.; 75:187.
- Chakraborty, R. (1991): Heredity and Environment, in Plato, C.C. (ed) Dermatoglyphics : Science in Transition, Birth Defects Original Article Series : Wiley.
- Constandse - Westermann, T.S. (1992): Coefficients of Biological Distance. Anthropological Publications. Oosterhout N.B.: Netherlands.
- Durham, N.M. and Plato, C.C. (1990) eds.: Trends in Dermatoglyphic Research. Studies in Human Biology : Vol. 1. Kluwer Academic Pubs. : Dordrecht, Netherlands.
- Jantz, R.L., Hawkinson, C.H., Brehme, H. and Hitzeroth, H.W. (1992): Finger ridge-count variation among various subsaharan African groups. Am. J. Phys. Anthrop., 57:311-321.
- Kolski, R. and Scazzochio, C. (1961) Estudio de la frecuencia de caracteres dermopapilares en nuestra poblacion. Rev. Fac. Hum. Cienc, Montevideo, 22:221
- Loesch, D.Z. (1979): Dermatoglyphic Distances. Selected Topics. Birth Defects Original Article Series, xv(6) : 225-248.
- Loesch, D.Z. (1983): Quantitative Dermatoglyphics : Classification, Genetics and Pathology. Oxford Monographs on Medical Genetics. No. 10 Oxford Univ. Press: Oxford.
- Meier, R.J. (1978): Dermatoglyphic variation in five Eskimo groups from Northwestern Alaska, in Mavalwala, J. (ed) Dermatoglyphics: An International Perspective. The Hague: Mouton.
- Nemec, B. (1968): Papillarlinienbilder auf den Fingern der rechten und linken Hand der Manner und Frauen in der Tschechoslowakischen Population. Anthropologie, Brno, 5: 53-59.
- Plato, C.C. (1991)ed.: Dermatoglyphics: Science in Transition Birth Defects Original Article Series. Wiley : New York.
- Preus, M. (1977): A diagnostic index for Down Syndrome. Clin. Genet. 42: 47-55.
- Relethford, J.H. and Blangero, J. (1989): Detection of differential gene flow from patterns of quantitative variation. Am.J. Phys. Anthrop., 78:289.
- Rudan, P., Simi, D. and Bennett, L.A. (1988): Isolation by distance on the island of Korcula: correlation analysis of distance measures. Am. J. Phys. Anthrop., 77: 97-103.
- Schaumann, B. and Opitz, J.M. (1991): Clinical Aspects of Dermatoglyphics, in Plato, C.C. (ed) Dermatoglyphics : Science in Transition, Wiley: New York.

APPENDIX 1Self-Printing Kit

This was posted to patients and was composed of:-

1. Introductory letter Fig. A1.1
2. Questionnaire Fig. A1.2
3. Printing Instructions Fig. A1.3
4. Two Print Sheets Fig. A1.4
5. Specimen Print Sheet A1.5
6. Two Durester Printake inked sheets
7. Two paper towels
8. Stamped addressed envelope to Dept. of Anthropology

Figure A1.1 - Introductory Letter ($\frac{3}{4}$ size)

THE UNIVERSITY OF
NEWCASTLE UPON TYNE

DEPARTMENT OF DERMATOLOGY
THE ROYAL VICTORIA INFIRMARY
NEWCASTLE UPON TYNE NE1 4LP ENGLAND
TELEPHONE NEWCASTLE 328511 ext 3177
325131 ext 573

University of Durham

Department of Anthropology

43 Old Elvet,
Durham, DH1 3HN, England
Telephone: Durham 64466 (STD code 0385)

Dear Sir/Madam,

The University of Durham and the Dermatology Department of the R.V.I. have combined to undertake a study of the relationship between finger and palm prints and a series of skin disorders. The purpose of the study is to investigate whether individuals who possess particular skin disorders can be identified as susceptible by the combination of digital and palmar patterns. Similar studies have been undertaken in the past for many other disorders and have given encouraging results.

In view of the fact that you suffer from one of the disorders in which we are particularly interested we would like to ask you to take part in this study. All that is required is that you take a set of finger and palm prints and complete a short questionnaire.

Please answer the questions on the questionnaire enclosed, the answers will be kept completely confidential. Then by following the instructions on the enclosed instruction sheet take prints of both fingers and palms of each hand.

Please return the completed questionnaire and two sets of prints in the envelope provided.

Thanking you in anticipation of your co-operation.

Yours faithfully,

D. Blackwell

D. Blackwell BA., M.Sc., M.Ed., M.I. Biol.

FIGURE A1.2 - QUESTIONNAIRE

Please answer the following questions:

(All answers will be treated in the strictest confidence)

Q1. Hospital No.

Q2. Age in years

Q3. Sex (please tick) Male

Female

Q4. Birthplace (Town or City)

Q5. Mother's Birthplace (Town or City)

Q6. Father's Birthplace (Town or City)

Q7. Do you suffer from any of the following?

(please tick, you may tick more than one box)

Hay Fever

Asthma

Eczema

Arthritis

Q8. Do you have any allergies?

Yes

No

if yes please give details

.....

.....

Q9. Skin Type

In summer when you get your first good exposure to the sun

which of the following would you say best describes your skin?

(please tick one box only)

Always burn never tan

Always burn sometimes tan

Sometimes burn always tan

Never burn always tan

Q10. Does any other member(s) of your family suffer from any form of skin disorder:

Yes

No

if Yes state who (e.g. brother, sister) and the skin disorder if known

Figure A1.3 - Instruction Sheet ($\frac{3}{4}$ size)

INSTRUCTION SHEET

1. Please check that you have:-

Two sheets of white paper (PRINT SHEETS)
 Two plastic backed black ink sheets - stuck together
 Sheet with specimen palm and finger print
 Paper towel to wipe off excess ink

In addition you will need to provide some washing up liquid
 for cleaning hands) and newspaper (for covering surface on
 on which you are working).

2. Place one sheet of white paper on a flat surface.
3. Pull apart the plastic ink sheets, put one to one side.
 Place the ink sheet on the flat surface next to the white
 paper.
4. Place palm of right hand on the centre of the ink sheet.
 Press down with other hand on top to thoroughly ink palm.
5. Lift up right hand from ink sheet.
6. Place right hand on the centre of the white sheet and press
 on top of hand with other hand so that a clear imprint is
 made. Note that the most difficult part to print is the base
 of the fingers so press there particularly.
7. Lift up right hand, check to see that palm print is
 satisfactory. Compare to that of specimen on enclosed sheet.
8. Roll thumb of right hand on ink sheet from left to right so
 that it becomes lightly covered in ink.
9. Transfer thumb to white paper and roll again so that imprint
 is left on white sheet. Do this only once so that smudging
 does not occur.
10. Repeat this same procedure for each finger on right hand as
 for thumb. Roll the finger in the box provided.
11. The white sheet should now have an impression of your right
 palm in the centre with your finger prints in sequence along
 the side. (see specimen)
12. Wipe your right hand with paper towel to remove excess ink.
13. Repeat steps 2 to 11 for left hand using second white sheet
 and ink sheet.
14. Place the two sheets of prints in the envelope along with the
 completed questionnaire and return as requested.

THANK YOU VERY MUCH FOR YOUR COOPERATION

- N.B. If you make a mistake or wish to try again to improve the
 prints this can be done on the reverse of the print sheets
 or on any piece of plain paper.

Figure A1.4- Print Form ($\frac{3}{4}$ size)

UNIVERSITY OF NEWCASTLE UPON TYNE Department of Dermatology	PRINT SHEET	UNIVERSITY OF DURHAM Department of Anthropology
Palm Print		
Large empty area for the palm print		Little Finger
		Ring Finger
		Middle Finger
		Fore Finger
		Thumb

Figure A1.5 - Completed Print Sheet ($\frac{3}{4}$ size)

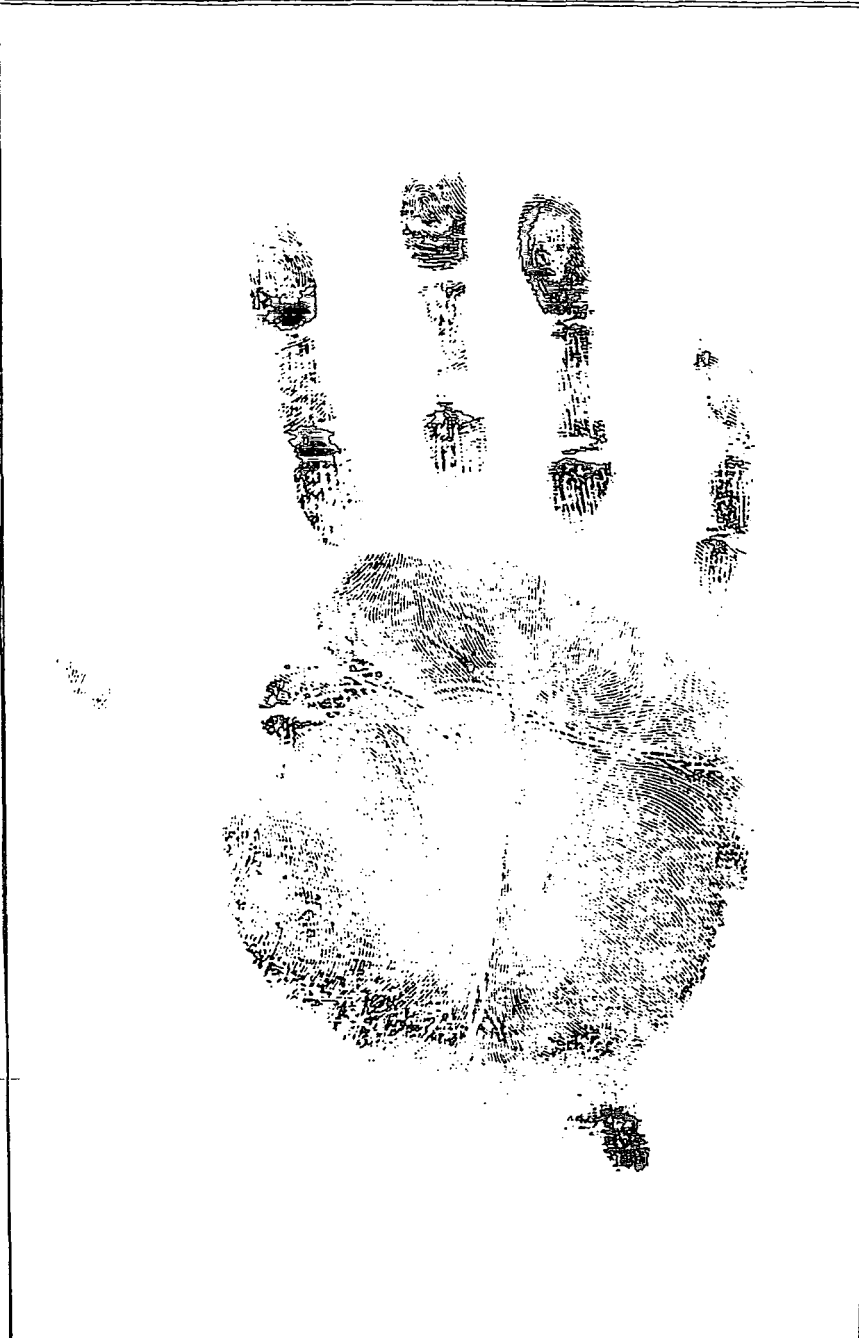
SPECIMEN	
Palm Print	
	Little Finger
	Ring Finger
	Middle Finger
	Fore Finger
	Thumb

APPENDIX 2 - Computer data sheet of variable coding information

Figure A2.1 - Computer Data Sheet

CASE NO				CARD	AGE			SEX	LOC	DIS			ST	FM	SAP			FBP		
1	2	3	4	5	6	7	8	9	10	11	12	13	14	15	16	17	18	19	20	
MBP				AY	LW				LH				RW							
21	22	23	24	25	26	27	28	29	30	31	32	33	34	35	36	37	38	39	40	
RH																				
41	42	43	44	45	46	47	48	49	50	51	52	53	54	55	56	57	58	59	60	
01	02	03	04	05	06	07	08	09	70	71	72	73	74	75	76	77	78	79	80	

CASE NO				CARD	LFU1	LFU2	LFU3	LFU4	RFU1	RFU2	RFU3	RFU4							
1	2	3	4	5	6	7	8	9	10	11	12	13	14	15	16	17	18	19	20
				2															
LFR4				LFU5	LFR5	RFR1	RFU1	RFR2	RFU2	RFR3	RFU3	RFR4							
21	22	23	24	25	26	27	28	29	30	31	32	33	34	35	36	37	38	39	40
RFU4				RFR5	RFU5	LP1	LP2	LP3	LP4	LP5	RP1	RP2							
41	42	43	44	45	46	47	48	49	50	51	52	53	54	55	56	57	58	59	60
RP3				RP4	RP5	LA	FNL			RA	FMR								
01	02	03	04	05	06	07	08	09	70	71	72	73	74	75	76	77	78	79	80

CASE NO				CARD	PT	RT	P2	C2	P3	C3	P4	C4	U4	PH	CH	RH	UHT	PAR	HRA	
1	2	3	4	5	6	7	8	9	10	11	12	13	14	15	16	17	18	19	20	
				3																
AK	AU	BR	BU	CR	CU	DR	DU	X2	X3	X4	LP01	T	T1	T11	TBL				AB	
21	22	23	24	25	26	27	28	29	30	31	32	33	34	35	36	37	38	39	40	
BC				CD	BD	AC	ATD	FC	HYD	ATR	TCV	TCT								
41	42	43	44	45	46	47	48	49	50	51	52	53	54	55	56	57	58	59	60	
01	02	03	04	05	06	07	08	09	70	71	72	73	74	75	76	77	78	79	80	

CASE NO				CARD	PT	RT	P2	C2	P3	C3	P4	C4	U4	PH	CH	RH	UHT	PAR	HRA	
1	2	3	4	5	6	7	8	9	10	11	12	13	14	15	16	17	18	19	20	
				4																
AR	AU	BR	BU	CR	CU	DR	DU	X2	X3	X4	RFZE	T	T1	T11	TBR				AB	
21	22	23	24	25	26	27	28	29	30	31	32	33	34	35	36	37	38	39	40	
BC				CD	BD	AC	ATD	FC	HYD	ATR	TCV	TCT								
41	42	43	44	45	46	47	48	49	50	51	52	53	54	55	56	57	58	59	60	
01	02	03	04	05	06	07	08	09	70	71	72	73	74	75	76	77	78	79	80	

A2.2 - Information for Coding of Variables in Data SheetCARD ONE

<u>CASE NO.</u>		0001 - 9999	
<u>CARD</u>		1	
<u>HOSP. NO.</u>		Hospital Number - RVI only.	MISSING = 99999
<u>LOC.</u>		Location of Printing	
	e.g.	1 = RVI	
		2 = Sunderland Royal	
		etc.	MISSING = 0
<u>AGE</u>		01 - 99	MISSING = 00
<u>SEX</u>		MALE = 1	FEMALE = 2
<u>DIS.</u>		DISORDER	
	e.g.	000 = CONTROL	
		100 = PSORIASIS	
		200 = ATOPIC ECZEMA	
		etc.	
<u>SBP</u>	=	Subject's birthplace	
<u>MBP</u>	=	Mother's birthplace	
<u>FBP</u>	=	Father's birthplace	Codes from Dennis(1977) MISSING = 999
<u>FH</u>	=	Family History	
		0 = none known	
		1-8 = number of family specified	
		9 = missing data	
<u>ST</u>	=	Skin Type	
		1 = always burn never tan	
		2 = always burn sometimes tan	
		3 = sometimes burn always tan	
		4 = never burn always tan	
		9 = missing data	
<u>AY</u>		Atopy	
		Combinations of hay fever, asthma, eczema, arthritis, allergies	
		Codes for combinations of the above disorders	
		00 = none	
		99 = missing data	

CARD ONE cont.

LW1 White lines on fingers L = Left hand
LW2 (Linear grooves) W = White lines
LW3 See below 1 - 5 = finger number

LW4LW5

CODES 0 = none
 1 = slight
 2 = moderate
 3 = severe

LH1 Hyperlinearity of finger L = Left hand
LH2 H = Hyperlinearity
LH3 1 - 5 = finger number
LH4 (codes as above for severity)

LW5RW1RW2

RW3 White lines on fingers of right hand
RW4 (codes as above for severity)

RW5RH1RH2

RH3 Hyperlinearity on fingers of right hand
RH4 (codes as above)

RH5

CARD TWO

CASE NO. as for card one

CARD NO. = 2

FINGER RIDGE COUNTS (Boxes 6 - 46)

	<u>HAND</u>	<u>CONSTANT</u>	<u>COUNT</u>	<u>DIGIT NO.</u>	
LFU1	Left	Finger	Ulnar	One	
LFR1	Left	Finger	Radial	One	
					numerical count
RFR5	Right	Finger	Radial	Five	00 = no count
RFU5	Right	Finger	Ulnar	Five	99 = missing data

FINGER PATTERNS (Boxes 48 - 68)

	<u>HAND</u>	<u>CONSTANT</u>	<u>DIGIT NO.</u>	<u>CODES</u>
LP1	Left	Pattern	One	00 = Arch 01 = Tented arch
RP5	Right	Pattern	Five	02 = Ulnar loop 03 = Radial loop 04 = Whorl 05 = Double loop (Twinned loop) 06 = Ulnar double loop 07 = Radial double loop 08 = Central pocket loop ulnar 09 = Central pocket loop radial 10 = Accidentals (see DYN p.29) 99 = Missing data

FINGER RIDGE ATROPHY

LA = Ridge atrophy on fingers of left hand

CODES:

0 = absent (no atrophy visible)
1 - 3 = atrophy present (see below)
9 = missing data

CARD TWO cont.

F Nos L = Finger number left hand - fingers involved
1 - 5 Degree of atrophy on particular fingers

CODES: 0 = none
 1 = slight
 2 = moderate
 3 = severe
 9 = missing data

RA = Ridge atrophy on fingers of left hand
 (codes as for LA)

F Nos R = Finger number right hand
1 - 5 (codes as for F Nos L)

CARDS THREE AND FOUR

Variables are identical on each hand except the card three refers to left hand and card four to right hand. Variable codes are therefore preceeded or followed by L or R to denote which hand.

CASE NO. as for card one

CARD 3 or 4

PATTERNS IN PALMAR AREAS (Boxes 6 - 20)

<u>PATTERN:</u>	<u>LOCATION/DIRECTION</u>
PT	Peripheral Thenar
RT	Radial Thenar
P2	Peripheral Pattern in 2nd interdigital area
C2	central " " " " "
P3	Peripheral Pattern in 3rd interdigital area
C3	Central " " " " "
P4	Peripheral Pattern in 4th interdigital area
C4	Central " " " " "
U4	Ulnar " " " " "
PH	Peripheral Hypothenar
CH	Central Hypothenar
RH	Radial Hypothenar
UHT	Ulnar Hypothenar Tented
HRA	Hypothenar Radial Arch

CODES for above 0 = absent
1 = pattern present
9 = missing data

TURNING TRIRADII (Boxes 20 - 28)

Triradius/Direction

AR	=	Triradius a turning to radial side of palm
AU	=	" a " " ulnar " " "
BR	=	" b " " radial " " "
BU	=	" b " " ulnar " " "
CR	=	" c " " radial " " "
CU	=	" c " " ulnar " " "
DR	=	" d " " radial " " "
DU	=	" d " " ulnar " " "

CARDS THREE/FOUR cont.

CODES: 0 = absent
 1 = present
 9 = missing data

EXTRA TRIRADII IN INTERDIGITAL AREAS (Boxes 30 - 32)

X2 = Extra triradius in area 2
 X3 = " " " " 3
 X4 = " " " " 4

CODES: 0 = no extra triradii
 1 = one extra triradius
 2 = two " triradii
 3 = three extra triradii
 etc.

 9 = missing data

PALMAR TRIRADII TOTAL (PPII)

LPPII = Left Palmar Triradii total (Boxes 34 and 35)
CODES: numerical count
 99 = missing data

POSITION OF AXIAL TRIRADII (Boxes 37 - 40)

T = 0 - 14 (t)
 TII = 14 40 (t')
 TIII = 40 (t'')
 TBL = Border Triradii (t^b)
CODES: 0 = absent
 1 = present
 9 = missing data

CARDS THREE/FOUR cont.PALMAR RIDGE COUNTS (Boxes 41 - 50)

AB = a-b

BC = b-c

CD = c-d

BD = missing c triradius b-d

AC = missing b triradius a-c

CODES: 2 figures for numerical count

0 = no count

99 = missing data

ATD = Maximal atd angle

CODES: = numerical value (degrees)

99 = missing data

FC = Flexion creases (transverse flexion crease variations)

CODES: 0 = normal (Alter 1970)

1 = connected lines towards hypothenar

2 = connected lines towards thenar

3 = close lines

4 = simian line

5 = sydney line

6 = cascade configuration

9 = missing data

HYP = Hyperlinearity of palm

ATR = Atrophy of ridges on palm

CODES for HYP and ATR:-

0 = absent

1 = slight

2 = moderate

3 = severe

9 = missing data

CARDS THREE/FOUR cont.

TCV = Thenar crease variations

CODES:
0 = normal
1 = double
2 = forked
3 = broken
4 = short
5 = cascade

TCT = Thenar crease Terminus

CODES:
1 at proximal transverse crease near radial border
2 at separate and distinct radial terminus
9 missing data

Table A3.1

Percentage Frequencies

Family History

(a) Sex = Male

Group	Cases	Percentage Frequencies								
		0	1	2	3	4	5	6	7	8
Controls	200	97.0	3.0	0.0	0.0	0.0	0.0	0.0	0.0	0.0
Psoriasis	201	35.3	45.8	17.4	1.0	0.0	0.5	0.0	0.0	0.0
Atop Ecz	203	31.0	45.8	21.7	1.5	0.0	0.0	0.0	0.0	0.0
Vitiligo	201	56.7	40.8	2.5	0.0	0.0	0.0	0.0	0.0	0.0
Alop Are	210	38.1	55.7	6.2	0.0	0.0	0.0	0.0	0.0	0.0
BCC	211	72.0	23.2	4.3	0.5	0.0	0.0	0.0	0.0	0.0
Act Ker	129	72.9	24.0	1.6	1.6	0.0	0.0	0.0	0.0	0.0

(b) Sex = Female

Group	Cases	Percentage Frequencies								
		0	1	2	3	4	5	6	7	8
Controls	202	90.6	8.4	0.5	0.5	0.0	0.0	0.0	0.0	0.0
Psoriasis	203	40.9	32.0	19.7	4.9	1.0	1.0	0.0	0.5	0.0
Atop Ecz	203	30.5	35.5	32.0	0.5	1.5	0.0	0.0	0.0	0.0
Vitiligo	205	44.9	46.3	8.8	0.0	0.0	0.0	0.0	0.0	0.0
Alop Are	206	45.6	43.2	10.2	1.0	0.0	0.0	0.0	0.0	0.0
BCC	202	67.8	26.7	4.5	1.0	0.0	0.0	0.0	0.0	0.0
Act Ker	174	59.3	35.5	5.2	0.0	0.0	0.0	0.0	0.0	0.0

Table A3.2

Percentage Frequencies

Skin Type

(a) Sex = Male

Group	Cases	Percentage Frequencies			
		1	2	3	4
Controls	200	3.0	15.0	73.0	9.0
Psoriasis	202	1.5	27.2	61.9	9.4
Atop Ecz	203	3.0	39.4	60.2	7.4
Vitiligo	201	1.5	13.9	68.2	16.4
Alop Are	210	0.0	26.2	70.0	3.8
BCC	211	5.7	35.1	48.8	10.4
Act Ker	129	6.2	48.8	37.2	7.8

(b) Sex = Female

Group	Cases	Percentage Frequencies			
		1	2	3	4
Controls	202	2.0	21.3	63.9	12.9
Psoriasis	204	13.2	29.4	45.1	0.0
Atop Ecz	203	7.4	36.0	41.9	14.8
Vitiligo	205	1.5	22.4	61.0	15.1
AlopAre	206	1.9	33.0	57.8	7.3
BCC	202	6.9	43.1	41.1	8.9
Act Ker	174	9.3	61.0	28.5	1.2

Table A3.3

Percentage Frequencies

Atopy

(a) Sex = Male

Group	Cases	Percentage Frequencies														
		0	1	2	3	4	5	6	7	8	9	10	11	12	13	14
Controls	206	84.5	8.0	1.0	0.0	0.0	5.5	0.0	0.0	0.0	1.0	0.0	0.0	0.0	0.0	0.0
Psoriasis	202	71.4	0.5	0.5	3.8	9.7	10.3	0.0	0.0	0.0	0.0	0.0	0.0	0.0	0.0	2.2
Atop Ecz	203	3.0	3.0	1.5	29.2	0.5	9.9	1.5	10.4	0.0	4.0	0.0	0.0	0.0	0.0	0.0
Vitiligo	201	79.1	3.1	1.5	0.5	3.6	11.2	0.0	0.0	0.0	0.0	0.0	0.0	0.5	0.0	0.5
Alop Are	210	70.8	2.4	1.0	0.5	1.4	23.0	1.0	0.0	0.0	0.0	0.0	0.0	0.0	0.0	0.0
BCC	211	65.8	1.1	1.6	1.6	24.2	4.2	0.0	0.0	0.0	0.5	0.0	0.0	0.0	0.0	0.0
Act Ker	129	59.8	0.8	1.6	0.8	28.7	6.6	0.0	0.0	0.0	0.0	0.8	0.8	0.0	0.0	0.0

Group	Cases	Percentage Frequencies									
		15	16	18	19	20	21	23	26	28	29
Controls	206	0.0	0.0	0.0	0.0	0.0	0.0	0.0	0.0	0.0	0.0
Psoriasis	202	0.5	0.0	0.0	0.0	0.5	0.5	0.0	0.0	0.0	0.0
Atop Ecz	203	0.0	0.0	0.0	0.0	0.0	0.0	0.0	0.0	0.0	0.0
Vitiligo	201	0.0	0.0	0.0	0.0	0.0	0.0	0.0	0.0	0.0	0.0
Alop Are	210	0.0	0.0	0.0	0.0	0.0	0.0	0.0	0.0	0.0	0.0
BCC	211	0.5	0.0	0.0	0.0	0.5	0.0	0.0	0.0	0.0	0.0
Act Ker	129	0.0	0.0	0.0	0.0	0.0	0.0	0.0	0.0	0.0	0.0

Table A3.3 cont.

(b) Sex = Female

Group	Cases	Percentage Frequencies														
		0	1	2	3	4	5	6	7	8	9	10	11	12	13	14
Controls	203	78.2	4.5	2.5	0.5	1.5	9.9	0.0	0.0	0.0	0.0	0.0	0.0	0.0	0.0	0.0
Psoriasis	202	71.4	0.5	0.5	3.8	9.7	10.3	0.0	0.0	0.0	0.0	0.0	0.0	0.0	0.0	2.1
Atop Ecz	203	8.0	2.0	2.5	28.9	0.5	13.9	1.0	6.5	0.0	3.0	7.0	1.0	1.0	0.5	7.5
Vitiligo	205	79.0	1.5	1.5	0.0	4.9	9.3	0.5	0.0	0.5	0.0	0.0	0.0	1.0	0.0	0.0
Alop Are	206	56.8	1.5	1.9	2.4	6.8	25.2	0.5	0.5	0.5	0.5	0.5	0.0	0.0	0.0	1.0
BCC	202	55.6	1.9	0.6	2.5	30.2	5.6	1.2	0.0	0.0	0.0	0.0	0.0	0.0	0.0	0.0
Act Ker	174	55.5	0.0	0.6	0.6	28.7	11.0	0.0	0.0	0.0	0.0	0.0	0.0	0.6	0.0	0.0

Group	Cases	Percentage Frequencies									
		15	16	18	19	20	21	23	26	28	29
Controls	203	0.5	0.0	0.5	0.0	0.0	0.0	0.0	0.0	0.0	0.0
Psoriasis	205	1.1	1.1	0.0	0.0	0.0	0.0	0.0	0.0	0.0	0.0
Atop Ecz	203	0.0	7.0	1.0	0.5	4.0	0.0	1.5	1.5	0.5	1.0
Vitiligo	205	0.0	0.0	1.0	0.0	0.5	0.0	0.5	0.0	0.0	0.0
Alop Are	206	0.5	1.0	0.0	0.0	0.5	0.0	0.0	0.0	0.0	0.0
BCC	202	2.5	0.0	0.0	0.0	0.0	0.0	0.0	0.0	0.0	0.0
Act Ker	174	2.4	0.0	0.6	0.0	0.0	0.0	0.0	0.0	0.0	0.0

APPENDIX 4 - Assessment of epidermal ridge pitting in Darier's diseaseMethod

Using x10 of the binocular microscope the degree of ridge pitting and plaque formation was assessed for each of the finger tips and palmar areas using a 0-3 scale of severity, where 0 = absent and 3 = severe. Also for each of the above areas, hyperlinearity was assessed, and for the finger tips only white line occurrence was determined using the 0-3 scale. The area covered by the various ridge disturbances was also noted for each of the areas. The values obtained were then entered in the appropriate boxes in the computer data sheet (Figure A4.1).

Key to variable codes on sheet (Figure A4.1)Card 1

LF1 W Left hand finger 1 white lines
 LF1 H " " " " hyperlinearity
 LF1 PT " " " " pitting
 LF1 PQ " " " " plaques
 AREA " " " " % age area covered

RF5 area Right hand finger 5-% area covered

Card 2

LP1 H Left palmar area I, hyperlinearity
 UP1 PT " " " " pitting
 LP1 PQ " " " " plaques
 LP1 Arch " " " " % area covered

RPP area right hand parathenar area - % area covered - -

Figure A4.1 - Computer Data Sheet for ridge pitting in Darier's disease

CASE NO.					CARD	DIS			SEX	AGE		LF1 _W H PT PQ AREA				LF2 _W H PT					
1	2	3	4	5	6	7	8	9	10	11	12	13	14	15	16	17	18	19	20		
PQ		AREA		LF3 _W	H	PT	PQ	AREA	LF4 _W	H	PT	PQ	AREA	LF5 _W	H	PT	PQ	AR			
21	22	23	24	25	26	27	28	29	30	31	32	33	34	35	36	37	38	39	40		
RF1 _W		H		PT	PQ	AREA	RF2 _W		H		PT	PQ	AREA	RF3 _W		H		PT	PQ	AREA	RF4 _W
41	42	43	44	45	46	47	48	49	50	51	52	53	54	55	56	57	58	59	60		
H		PT	PQ	AREA	RFS _W		H		PT	PQ	AREA	TALF		TABF							
61	62	63	64	65	66	67	68	69	70	71	72	73	74	75	76	77	78	79	80		

CASE NO.					CARD	LF1 _W H PT PQ AREA				LF2 _W H PT PQ AREA				LF3 _W H PT PQ AREA											
1	2	3	4	5	6	7	8	9	10	11	12	13	14	15	16	17	18	19	20						
					2																				
LP4 _W		H		PT	PQ	AREA	LP4 _W		H		PT	PQ	AREA	LPP _W		H		PT	PQ	AREA	TLPA	RPH		PT	
21	22	23	24	25	26	27	28	29	30	31	32	33	34	35	36	37	38	39	40						
PQ		AREA		RF2 _W	H		PT	PQ	AREA	RP3		H		PT	PQ	AREA	RPH		H		PT	PQ	AREA	RPH	PT
41	42	43	44	45	46	47	48	49	50	51	52	53	54	55	56	57	58	59	60						
PQ		AREA		RPP _W		H		PT	PQ	AREA	TRPH														
61	62	63	64	65	66	67	68	69	70	71	72	73	74	75	76	77	78	79	80						

APPENDIX 5 - Method for Sweat Pore Counting

The prints were examined under x10 of the binocular microscope. Each of the fingertip prints were divided into quadrants and a sweat pore count was made for 1mm in each quadrant. The same was done for each of the interdigital areas I₂, I₃ and I₄ and the hypothenar area.

The four counts for each of the areas outlined above i.e. five fingers and four palmar areas, for each hand were then recorded on the computer data sheet as shown below (Figure A5.1).

The mean count per cm was computed for each area, for the finger tips combined on each hand and for each palm, for both sets of fingers and palms and for the mean of all areas combined.

Key to computer data sheet (Figure A5.1)

LF1:1 = Left hand finger 1 quadrant 1



RF5:4 = Right hand finger 5 quadrant 4

I₂L:1 = Left hand interdigital area 1 quadrant 1



IHR:4 = Right hand hypothenar area quadrant 4

Figure A5.1 - Computer data sheet for Sweat Pore Counts

CASE NO.				CARD	SX	DIS	LF1				LF2																												
1	2	3	4	5	6	7	8	9	10	11	12	13	14	15	16	17	18	19	20																				
				1																																			
3				4 LF3				1				2				3				4																			
21	22	23	24	25	26	27	28	29	30	31	32	33	34	35	36	37	38	39	40																				
LFS				1				2				3				4				RF1				1				2											
41	42	43	44	45	46	47	48	49	50	51	52	53	54	55	56	57	58	59	60																				
3				4 RF3				1				2				3				4 RF4				1				2				3				4			
61	62	63	64	65	66	67	68	69	70	71	72	73	74	75	76	77	78	79	80																				

CASE NO.				CARD	RFS				I2L				I3R																										
1	2	3	4	5	6	7	8	9	10	11	12	13	14	15	16	17	18	19	20																				
				2																																			
4 I3L				1				2				3				4 I4L				1				2				3				4 IH				1			
21	22	23	24	25	26	27	28	29	30	31	32	33	34	35	36	37	38	39	40																				
2				3				4 I2R				1				2				3				4 I3R				1				2				3			
41	42	43	44	45	46	47	48	49	50	51	52	53	54	55	56	57	58	59	60																				
4 I4R				1				2				3				4 IHR				1				2				3				4							
61	62	63	64	65	66	67	68	69	70	71	72	73	74	75	76	77	78	79																					