

Durham E-Theses

*An examination of selected trace elements in modern
and ancient samples of triticum spelta*

Joy Langston

How to cite:

Langston, Joy (1994) An examination of selected trace elements in modern and ancient samples of triticum spelta. Doctoral thesis, Durham University.

Use policy

The full-text may be used and/or reproduced, and given to third parties in any format or medium, without prior permission or charge, for personal research or study, educational, or not-for-profit purposes provided that:

- a full bibliographic reference is made to the original source
- a <https://etheses.durham.ac.uk/id/eprint/5509/> is made to the metadata record in Durham E-Theses
- the full-text is not changed in any way

The full-text must not be sold in any format or medium without the formal permission of the copyright holders.

Please consult the [full Durham E-Theses policy](#) for further details.

**An examination of selected trace
elements in modern and ancient
samples of *Triticum spelta***

by

Joy Langston

BSc (Leicester)

**A thesis submitted for the degree of Doctor of Philosophy
in the University of Durham, England**

April 1994

The copyright of this thesis rests with the author.
No quotation from it should be published without
his prior written consent and information derived
from it should be acknowledged.



1 0 MAR 1995

Thesis
1994/
LAW

**This thesis results entirely from my own
work and has not previously been offered
in candidature for any other degree or
diploma.**

Joy Langston

April 1994

ABSTRACT :

Analyses were made of concentrations of six elements (the micronutrients copper, iron, manganese and zinc, and the macronutrients calcium and magnesium) in samples of *Triticum spelta* and the soil they were grown on to investigate relationships between the two, and the possibility of sourcing material found in the archaeological record.

Charred and fresh grains of geographically and geologically diverse locations were broken down in nitric acid using a microwave digestion technique. The resultant solutions were analysed by atomic absorption spectroscopy. Soil extractions using nitric acid and diethylene triamine penta-acetic acid allowed analyses of total and available elements. The results of soil / grain digests were investigated but no consistently significant relationships could be discerned.

Growth experiments were performed by growing grain samples from various locations on one soil type to assess which factors were primarily important in elemental uptake. Calcium and magnesium uptake appears strongly influenced by the growing environment, but that of the micronutrients is additionally affected by genetic factors.

In order to assess changes in elemental concentration due to burial, diagenetic experiments were carried out using grain from various locations and a series of differing burial periods. It was found that there was a trend for concentrations of the micronutrients and magnesium to decrease, whilst calcium concentrations increased substantially.

On completion of work with modern grain, samples from the archaeological record were analysed. Elemental concentrations were found to be very different in ancient material and more significantly related to the burial environment. It appears possible to differentiate between leached, rural and waterlogged / urban sites.

CONTENTS

	<i>Page</i>
<i>Acknowledgements</i>	<i>i</i>
<i>Abbreviations</i>	<i>ii</i>
<i>List of figures</i>	<i>iv</i>
1. INTRODUCTION, BACKGROUND AND AIMS	
1.1. Introduction and aims of project	1
1.2. Selection of experimental material	2
1.3. Archaeological background	7
1.4. Previous work on trace elements in cereal grains	15
1.5. Suppositions and assumptions relating to research	16
1.6. The plant	17
1.7. Experimental work	19
1.8. Analytical work	20
1.9. The soil	21
1.10. Archaeological samples	22
1.11. Plan of research	24
2. PHYSIOLOGY OF THE CEREAL PLANT	
2.1. Introduction	27
2.2. Seed structure	28
2.3. Seed formation	33
2.4. Nutrient movement into the plant	36
2.5. Conclusions	41
3. DIGESTION AND ANALYSIS OF THE GRAIN	
3.1. Introduction	42
3.2. Preliminary experimental work	45
3.3. Development of the microwave technique	52
3.4. Microwave digestion of fresh grains	53
3.5. Digestion of charred grains	64
3.6. Problems encountered using the microwave digestion technique	66
3.7. Choice of elements for analysis	68
3.8. Choice of AAS as an analytical tool	75

	<i>Page</i>
3.9. Results	79
3.10. Statistical work	106
3.11. Conclusions	136
 <i>4. THE SOIL</i>	
4.1. Introduction	138
4.2. Trace element in soils	139
4.3. Experimental work with soil samples	149
4.4. Experimental method	150
4.5. Results	154
4.6. Conclusions	175
 <i>5. INFLUENCE OF ENVIRONMENT AND GENETIC FACTORS</i>	
5.1. Introduction	177
5.2. Experimental method	179
5.3. Digestion and analysis	183
5.4. Results	183
5.5. Conclusions	193
 <i>6. DIAGENETIC CONSIDERATIONS</i>	
6.1. Introduction	194
6.2. Experimental method	198
6.3. Results	201
6.4. Conclusions	216
 <i>7. ARCHAEOLOGICAL MATERIAL</i>	
7.1. Introduction	218
7.2. Experimental procedure	222
7.3. Results	227
7.4. Interpretation of results	232
 <i>8. IN CONCLUSION</i>	
8.1. Recapitulation and conclusions	237
8.2. Discussion	248
8.3. Summary	252

	<i>Page</i>
<i>9. BIBLIOGRAPHY</i>	254
<i>10. APPENDICES</i>	290

Acknowledgements:

I would like to thank the following:-

The Science and Engineering Research Council for funding this project for three years.

Prof. M.K.Jones for initiating the project, Jacqui Huntley for suggesting the topic and field of research, Dr.B.A.Whitton for advice and facilities in the Dept. of Biology, University of Durham, and Dr.C.C.Haselgrove without whose help and encouragement I could not have finished.

Paul Jackson, Jacqui and Brian Huntley for help and advice with computing.

Prof. R.C.Searle and Dr. J.Pearce, Dept. of Geochemistry, University of Durham for permission to use the microwave digester.

Marijka van der Veen and all those associated with her research who supplied modern spelt grains (Wendy Carruthers, Astrid Caseldine, Camilla Dixon, Frank Green, Allan Hall, Hilary Healey, Nick Johnson, Lisa Moffett, Peter Murphy, Mark Robinson, Vanessa Straker, Phillipa Tomlinson and Percival Turnbull). Also Mim Bower, Paul Fenwicks (Nickersons Seeds) and Terry Miller (PBI).

Ann Davis, Jacqui Huntley, Martin Jones, Vanessa Straker and Marijka van der Veen who gave samples of archaeological grain.

Dimitris Koustopoulos and Bill Simon for advice about sample preparation.

Bob Coult, Jaricka Dostal and Judith Magee who gave instruction and help with AAS.

Derek Coates and Brian Priestley for advice regarding soil analysis.

The staff of the University Botanic Garden who made space for pots of growing spelt and provided soil.

Dr.P.Cochrane for permission to use photomicrographs.

John Watkins for drawing the botanical section diagrams.

Shaun Doran for all his help with photo-copying.

Jacqui, Louisa, Sue and Shaun in the Bio-lab, and Julia, Vanessa, Paul and Gul in the Courtyard Lab, for constant help and encouragement throughout the good, bad and unbelievably awful times of this project!

Crispin for reading the script and support (physical, monetary and scientific).

Abbreviations:

(listed alphabetically)

AAS	Atomic absorption spectroscopy
ADP	adenosine di-phosphate
ANOVA	analysis of variance
ATP	adenosine tri-phosphate
avail.	available
Ca	calcium
CaCl ₂	calcium chloride
ch.	charred
ch.wt.	charred weight
cm	centimetre
conc.	concentration
CO ₂	carbon dioxide
Cu	copper
DNA	deoxyribose nucleic acid
DTPA	diethylene triamine penta-acetic acid
e	electron
EDX	energy dispersive X-ray
Eh	redox potential
EIXE	electron induced X-ray emission
Fe	iron
Fe ₂ O ₃	ferric oxide
fr.	fresh
g	gram
H	hydrogen
HCO ₃ ⁻	bicarbonate ion
HCl	hydrochloric acid
HClO ₄	perchloric acid
HF	fluoric acid
H ₂ O	water
H ₂ SO ₄	sulphuric acid
IAA	indole acetic acid
ICPAES	inductively coupled plasma atomic emission spectroscopy
KCl	potassium chloride
kg	kilogram
KPa	kilo-Pascals
LaCl ₃	lanthanum chloride
HNO ₃	nitric acid
M	molar
m	metre
M.A.F.F.	Ministry of Agriculture, Fisheries and Food
MHz	megahertz
mm	millimetre
Mg	magnesium
mg g ⁻¹	milligrammes per gram
min.	minute
ml	millilitre
Mn	manganese
NADP	nicotinamide adenine dinucleotide phosphate
NMR	nuclear magnetic resonance
NO ₂	nitrogen dioxide
OH ⁻	hydroxide radicle
orig.wt.	original weight

PCA	principal components analysis
PFA	poly fluoro-alkoxy
PIXE	proton induced X-ray emission
pm	picometre
ppm	parts per million
prob.	probability
psi	pounds per square inch
PTFE	poly tetra fluoro ethylene
RNA	ribose nucleic acid
rpm	revolutions per minute
sec.	second
SEM	scanning electron microscope
TCA	tricarboxylic acid
TEA	triethanolamine
$\mu\text{g g}^{-1}$	microgrammes per gram
μm	micrometres
W	watts
Zn	zinc
o	degrees
$^{\circ}\text{C}$	degrees Centigrade
%	percent

List of figures:

Fig.No.	Title	Page
2.1.	Logitudinal section of wheat grain	29
2.2.	Transverse section of crease region of wheat grain	35
2.3.	Tranverse section of wheat grain	36
3.1.	Disrtibution map of sites producing modern grain	43
3.2.	Geological map of the British Isles	44
3.3.	Concentrations from the original digests : copper/manganese	50
3.4.	iron/zinc	50
3.5.	magnesium/calcium	51
3.6.	Microwave digestion vessel components	55
3.7.	Pressure increases in a fresh grain digest	61
3.8.	Pressure increases in a charred grain digest	65
3.9.	Mean concentrations of elements in fresh and charred grains: copper	80
3.11.	iron	82
3.13.	manganese	84
3.15.	zinc	86
3.17.	calcium	88
3.18.	magnesium	88
	Mean concentrations of elements in fresh grains plotted against	
3.10.	those of charred : copper	81
3.12.	iron	83
3.14.	manganese	85
3.16.	zinc	87
3.19.	calcium	89
3.20.	magnesium	90
3.21.	Total micronutrient concentration in fresh grain : actual values	91
3.22.	percentages	92
3.23.	Total macronutrients : actual values	92
3.24.	: percentages	92
	Mean concentrations of elements in charred grain	
3.25.	(pre-burning weight and charred weight) : copper	95
3.26.	iron	96
3.27.	manganese	97
3.28.	zinc	98
3.33.	calcium	102
3.34.	magnesium	102
	Total micronutrient concentrations in charred grains (actual values) :	
3.29.	charred weight	99
3.30.	pre-burning weight	99
	Total micronutrient concentrations in charred grains (percentages) :	
3.31.	charred weight	100
3.32.	pre-burning weight	101
	Total macronutrient concentrations in charred grains (actual values) :	
3.35.	charred weight	103
3.36.	pre-burning weight	104
	Total macronutrient concentrations in charred grains (percentages) :	
3.37.	charred weight	105
3.38.	pre-burning weight	105
3.39.	Statistical calculations used in PCA for fresh grains	107
3.40.	Statistical calculations used in PCA for charred grains	112
3.41.	PCA distribution diagram : fresh grains : Axes 1 and 2	110
3.42.	: Axes 3 and 4	111

CHAPTER 1

INTRODUCTION, BACKGROUND & AIMS

The grains of first importance and most useful to mankind are spelt and wheat.
Columella

1.1. Introduction and aims of project

The aim of this research project is to establish if it is possible to find a relationship between trace elements in cereal grains and in the parent soil. If so this might conceivably enable the sourcing of grains found in the archaeological record. It is known that grains contain mineral elements essential for seed germination and the early stages of growth; it is also known that these elements do not always occur in the same proportions (Hesse, 1971; Mitchell and Burrige, 1979; Tinker, 1981; Kubota, 1983). If the elemental suite in the grain mirrors that of the soil the parent plant was grown on, then it should be possible to analyse a sample of grain and state certain chemical characteristics of its parent soil, assuming it was grown "organically" and without the addition of chemical fertilisers (which can enhance the amounts of certain elements). Crops grown in the pre-industrial period were probably manured with household and stable refuse but there would obviously be no additions of synthetic chemicals.

Such analyses, should they be possible, would prove of great value to archaeological study. Food is a basic commodity required by all, and flour from cereal grains is one of the most important sources of carbohydrate in the diet of mankind. For instance, in Britain following the development of towns in the Roman period it

can be assumed that not everyone grew a small plot for personal usage and grain obviously had to be traded, be it very locally or on a larger scale. Sourcing of cereal grain to particular soil types or tracts of landscape could therefore help to establish the extent of trading practices, and whether movement of foodstuffs was widespread and over large distances, or more restricted and on the scale of transport to the local market centre. For example, recent archaeological studies have suggested that the grain found in pits at Danebury came from several different environments and was brought to the hillfort for storage (Jones, 1984). The ability to source grain might also aid in assessing whether grain production was on a large scale or at "household" level (i.e. small and very localised and for the consumption of a single family unit).

1.2. Selection of experimental material

Before investigation of archaeological material can take place it is necessary to establish a basic data set using modern material from known environments. It is possible to chemically break down cereal grains and soil to extract trace elements for analysis; results can then be compared and any relationships between the elemental suites in the soil and those taken up into the grain examined. Working on modern and expendable grains also allows experimental technique to be perfected prior to the analysis of rarer archaeological material. One could reasonably expect ancient grains to be more difficult and complex to work with due to post-depositional changes following burial, and it is therefore sensible to establish the basic criteria for elemental extraction and analysis on more uniform modern material.

Samples for modern work relating to trace elements in grain and soil obviously had to be uncontaminated and unpolluted, as far as possible, and grown without the addition of fertilisers and soil improving agents which could distort the pattern of uptake. *Triticum spelta* (spelt wheat) was chosen as the experimental material with which to establish the modern data set because it is possible to obtain pure grain samples from Dr.M.van der Veen and those involved in her research in cereal crops and associated weeds in the field environment. This spelt was grown without any synthetic additions and, as far as possible, in "natural" sites which had no previous known history of industrial usage, intensive agriculture or heavy human interference. Whilst it is recognised that any human activity will have an effect on the soil it was hoped that, in the main, elemental uptake by the grains would provide an accurate reflection of elements from the soil rather than modern chemical enhancement. Additionally, spelt is well represented in the archaeological record being extensively cultivated from the later prehistoric to Roman periods (see section 1.3.), and was considered more relevant as a research material than other cereals grown more recently. If modern work is to relate to ancient material in any way it is obviously necessary to investigate the same species when establishing the pattern of elemental suites.

It was hoped initially that work could also be done with *Triticum aestivum* (bread wheat) to assess if there is a significant degree of difference in the uptake of elements between species; unfortunately it proved impossible to obtain pure samples. Even crops grown organically on land approved by the Soil Association tend to be harvested and packaged in ways which can cause contamination of those elements only found in small quantities

such as copper. A possible solution would have been to obtain grains of bread wheat from as clean a source as possible and then grow them up on "pure" soil, but even doing this could incur problems since there may be environmental and genetic factors relating to elemental uptake by the grain (see Chapter 6). If the parent plant passes on a genetic factor then the elements in grains of the F1 generation relate in part to the soil the grain producing the parent plant was grown on, and not solely to the soil producing the F1 grain. It would therefore be necessary to grow an F2 generation before analysis of the grain could relate totally to a known soil type, but this was not considered practical within the scope of this project.

Bread wheat is also free-threshing with loose grains which are exposed as the ear ripens and can be shaken off. This could prove to be a disadvantage in that it is easier for contamination to take place prior to analysis. Spelt grains are held tightly within the glumes and pales and can therefore be carefully extracted in the laboratory in a clean environment (see Plate 1).

Spelt is a hexaploid wheat of the genus *Triticum*, and related to bread wheat. The origins of the cultivated wheat species lie in the Near East in the area described as the Fertile Crescent, which is located across parts of the present day Israel, the Lebanon, Syria and Iraq (Bell, 1987; Zohary and Hopf, 1988). Hybridisation of wild grasses, which are still found in the area today, began at least ten thousand years ago, and it is from these early crosses that modern wheats evolved. The initial wild wheats were either diploid plants with seven pairs of chromosomes, or tetraploid with fourteen pairs. It is believed that a cross between a wild diploid einkorn (*T.urartu*) and a wild diploid goat grass of the *Aegilops* species gave rise to the tetraploid wild emmer wheat (*Triticum*

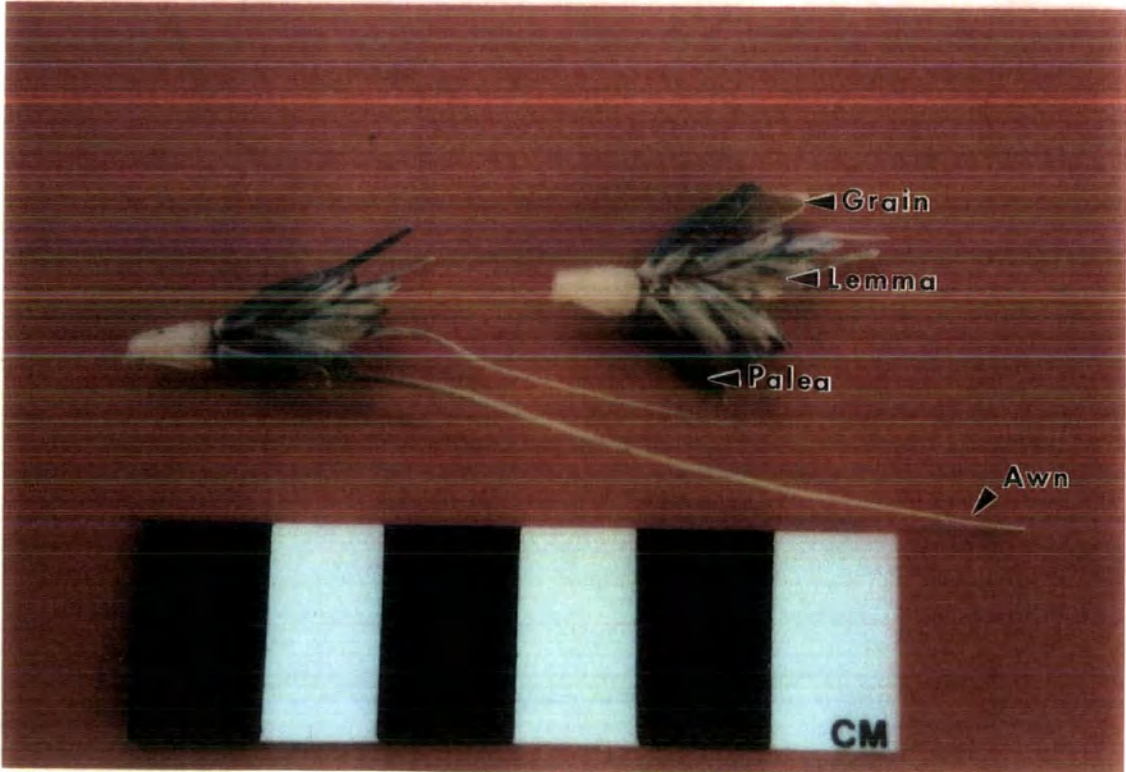
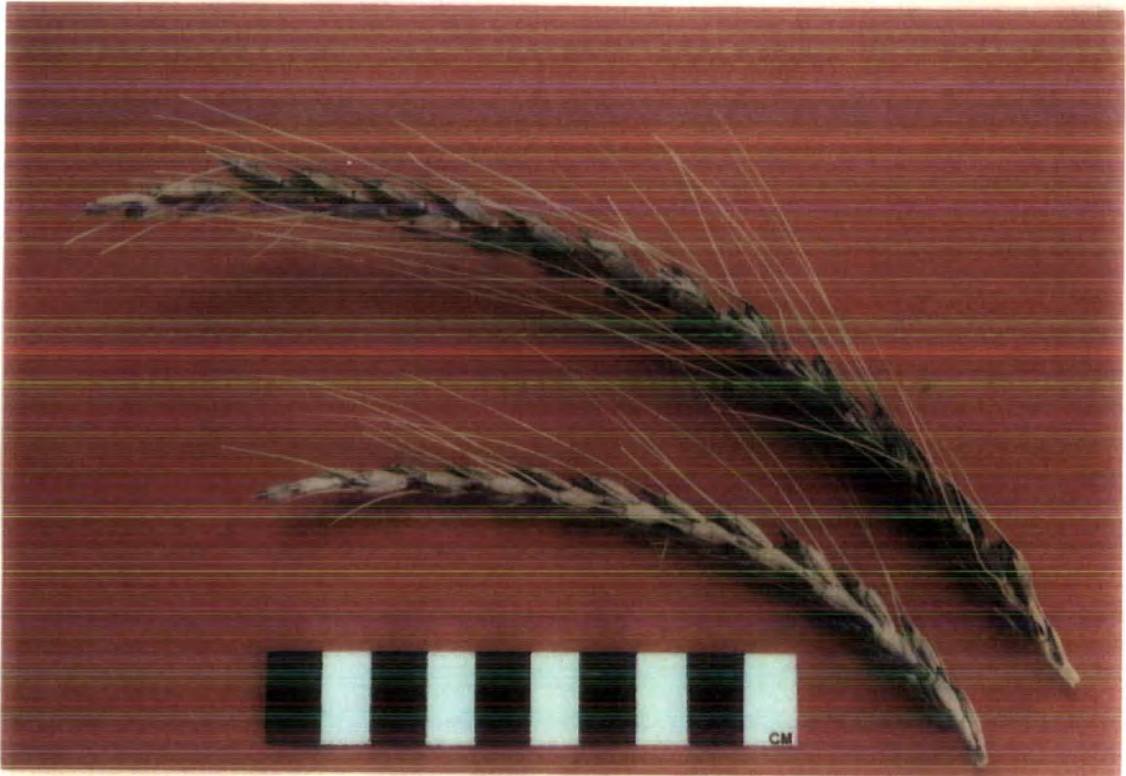

Plate 1 : Top - ear of speltz
Bottom - individual spikelet

dicoccoides) which has twenty eight chromosomes combining two distinct genomes (designated AABB). *T.urartu* has fourteen chromosomes and contains two sets of a single genome (AA), whilst the *Aegilops* progenitor has the same number of chromosomes but a different genome (BB) (Miller, 1987; 1992). In normal cross-breeding the next generation receives half of its genetic material from each parent, which means that parents and offspring possess the same number of chromosomes. However, in the cross which resulted in wild emmer doubling of chromosomes occurred, producing a tetraploid generation from two diploid parents. This spontaneous doubling happens rarely in cross-breeding but is extremely important because it ensures that each chromosome has an identical partner. Without this, normal pollen and egg cells would not have been produced by early crosses and the resulting hybrid would have been sterile and seedless (Bingham et al., 1991).

Emmer and einkorn (*T.monococcum*) were the first wheats to be taken into agriculture at some time before 7000 B.C. (Feldman, 1976), and cultivation led to improvements on the wild forms in two respects. Wild wheats have fragile ears which shatter into individual spikelets on ripening, each spikelet containing only one or a few grains which are each protected by a tough, tightly adhering husk, aiding a very effective dispersal mechanism. However these properties are of little use to the farmer; a fragile shattering ear means the crop is easily lost, and husked grains are difficult to thresh. The early cultivated wheats were less fragile and easier to thresh and the first farmers must have selected (consciously or unconsciously) plants with these properties, picking out genetic differences and making steps towards deliberate plant breeding.

Spelt has evolved through various crossings of cereal plants to produce a hexaploid plant with forty two chromosomes containing three different genomes, AABBDD. Briefly, the diploid goat grass *Aegilops squarrosa* (with the genome DD) crossed with cultivated tetraploid emmer (AABB) to produce the hexaploid wheats including spelt, bread and club wheats, and also the less widespread Vavilov's, Makha and Indian shot wheats (*T.vavilovi*, *T.macha* and *T.sphaerococcum*)(Bingham et al., 1991). There are both wild and cultivated forms of diploid and tetraploid wheats (the former being the einkorns and the latter the emmers and durum wheats) but hexaploid species are only found as cultivated forms and have no direct wild ancestor (Zohary and Hopf, 1988). The cultivated wheats form two distinct classes according to their response to threshing; one group containing diploid einkorn, tetraploid emmer and hexaploid spelt has hulled grains with tough pales and spikelet glumes. A second group containing certain tetraploid durums and hexaploid bread wheats are free-threshing with thinner pales and glumes which do not invest the grains tightly, thus releasing naked kernels on threshing (rather than spikelets as in the previous group). Hulled and naked wheat forms can be genetically very close and belong to the same species, the difference between the varieties being governed by a single mutation in the q gene (Zohary and Hopf, 1988).

It was originally thought that bread wheat arose by gene mutation or crossing of different forms of spelt, but it is now apparent that the former first appeared in the Near East or Anatolia, with hexaploid bread wheats making their first appearance in the archaeological record at around 6000 B.C. in the Neolithic levels at Knossos in Crete (Renfrew, 1969). The wild progenitors

of wheat are all found in the "sub-Mediterranean vegetation belt" of mild winters and hot dry summers, but spelt appears in a different ecological environment, being found further to the north and spreading into Europe, and it would seem that it is the D genome which renders it more adaptive to climatic variation (Zohary, 1969).

Spelt is one of the hardiest cereals, rarely affected by frosts which can destroy other wheats (making it suitable for autumn sowing), and it grows at all elevations up to 3,000 feet above sea level. Korber-Grohne (1987) found that it is not demanding of soil conditions, fertility or soil cultivation, a conclusion reached by Columella nearly one thousand years previously (*circa* A.D.50). In experimental trials at Butser Ancient Farm spelt yields were best on heavier soils, although still good on light thin soil (Reynolds, 1987). Percival (1921) suggested that spelt had greater resistance than bread wheat to smut, bunt and rust funghi, and was free from attacks by birds; unfortunately this was not found to be the case in experimental growing work at Durham (see Chapter 5), where rust and birds (plus rabbits!) all played a major part in decreasing the harvest.

1.3. Archaeological background

Spelt would appear to have originated in Europe (despite the earliest and most primitive wheats coming from the Near East) and is found in varying amounts in the archaeological record in Britain from early in the prehistoric era. It is difficult to draw any firm conclusions about crop production from the poor evidence currently available from Neolithic to Early Bronze Age sites; Field et al. (1964) found a small number of spelt grains of Neolithic date at

Hembury, Dorset, and traces of a similar date were also found by Milles (1986) at the Scord of Brouster, Shetlands. By the Late Bronze Age sites generally produce much larger assemblages of cereals, and Jones (1981) has postulated that early in the first millennium B.C. there was an increase in population and a decline in soil fertility which together triggered an increase in the scale of arable production, leading to diversification in the crops grown and soils cultivated. This was probably associated with climatic changes; Northern Europe became wetter from about the third millennium B.C. and this, together with forest clearance, led to podsolisation and the formation of peats with consequent increased waterlogging and erosion. There was also a slight temperature increase during the late Iron Age and this undoubtedly made more marginal and higher land viable for crop production (J.P. Huntley, pers. comm.). Recent research on Bronze Age sites (1500-600 B.C.) has shown that typical crops grown were emmer, spelt and hulled barley (*Hordeum vulgare*)(Greig, 1991). Spelt of this date has been found on a number of widely dispersed sites, some of which are listed below at Fig. 1.1. By the early Iron Age occurrences of spelt increase, and it replaces emmer as the principle wheat crop, assemblages again having been found on numerous sites. In the later Iron Age and Roman period spelt was increasingly widespread (Jones, 1984a), and a survey by Greig (1991) has found that the main crops grown at this time were spelt and barley, with some emmer and bread wheat. Most grain samples are found in storage pits or granary contexts but examination of the gut contents of an Iron Age bog body from Lindow Moss in Cheshire revealed remains of spelt, barley and emmer (Holden, 1986; Hillman, 1986). Finely ground cereal

components suggested the man's last meal consisted of bread, a fine gruel or something similar to dumplings (Sales et al., 1991).

A number of spelt samples have been recorded from Roman military sites, but the grain was not solely abundant where there were large numbers of soldiers. It has also been found in excavations of the urban levels of Roman towns, and in smaller village sites and rural contexts (see Fig. 1.1.).

On a wider scale the picture in Northern Europe at this time was also similar, with spelt being the main cereal grown in the Upper Rhine, although bread wheat was more common in the Lower Rhine areas (Korber-Grohne, 1981). During the first millennium A.D. the glume wheats (emmer and spelt) are replaced by free-threshing bread wheat and the incidence of spelt in the archaeological record decreases.

Period:	Site:	Author:	
Neolithic:	Hembury, Dorset	Field et al., 1964	
	Scord of Brouster, Shetlands	Milles, 1986	
Bronze Age:	Black Patch, Sussex	Drewett, 1982	
	Dinorben, Gwynedd	Jones, 1981	
	Hallshill, Northumberland	van der Veen, 1987b	
	Oakbank Crannog, Loch Tay	Clapham & Scaife, 1988	
	Potterne, Wiltshire	Carruthers, 1986	
	Runnymede, Surrey	Greig, 1990	
	WestRow, Mildenhall, Suffolk	Martin & Murphy, 1988	
	Iron Age:	Danebury, Hampshire	Jones, 1984
		Farmoor, Oxfordshire	Lambrick & Robinson, 1979
		Hengistbury Head, Dorset	Nye & Jones, 1987
Mickeldever Wood, Hampshire		Monk & Fasham, 1980	
Murton Crags, Northumberland		van der Veen, 1987a	
	Poundbury, Dorset	Monk, 1987	
	Stonea, Cambridgeshire	van der Veen, in press	
Roman:			
Urban:	Carlisle	Huntley, 1992	
	Colchester	Murphy, 1984	
	Leicester	Moffett, 1993	
	London	Straker, 1984	

Period:	Site:	Author:
Military:	Ambleside, Cumbria	Carruthers, 1993
	Bearsden, Strathclyde	Dickson, 1989
	Birdoswald, Cumbria	Huntley, 1991
	South Shields, Tyne and Wear	van der Veen, 1988
	York	Williams, 1979
Rural:	Alchester, Oxfordshire	Giorgi & Robinson, 1985
	Catsgore, Somerset	Hillman, 1982
	Dalton Parlours, Yorkshire	Murray, 1990
	Fishbourne, West Sussex	Carruthers, 1991
	Wanborough, Surrey	Carruthers, 1992

Fig. 1.1. Table of selected sites from various periods where spelt has been found during the excavations.

The introduction of spelt into Britain has raised numerous interesting problems. As noted previously, isolated samples are found on early prehistoric sites, but by the Iron Age period it was one of the main crops grown and was found throughout England and spreading into Wales and Southern and Central Scotland. Historically it was assumed that agriculture in Britain prior to the Roman conquest was small scale, unintensified and lacking innovation. Piggott (1958) talks of "Celtic cow-boys and shepherds, footloose and unpredictable, moving their animals over rough pasture and moorland". Twenty years later Frere (1978) was still being similarly dismissive, holding the view that it was the Roman army and its vast consumption of grain that made the greatest mark on the economy of Britain by stimulating cereal production in the South and introducing it for the first time in some Northern regions. This line of thought is undoubtedly erroneous as recent work has proved. Turner, in her research with pollen spectra (1981) has stated that in the early Iron Age forest clearance of an unprecedented scale started taking place in England, spreading from the South-East to the West and North, encompassing the South-West peninsula and Wales.

By A.D.1 clearing was taking place in Northumberland and spreading to the Lake District and Central Scotland between A.D.1 and A.D.500 Wilson (1981), looking at pollen spectra from North East England argues that the clearances are distinct from earlier ones, the clearance horizons of the Iron Age being more permanent than the relatively short-lived Bronze Age clearances. Jones (1982) states that "such an intensified use of hitherto marginal land is further reflected in the crop repertoire that characterises the Iron Age and Roman periods", which includes barley, oats (*Avena* sp.), rye (*Secale cereale*), celtic bean (*Vicia faba var.minor*) and the wheats: emmer, spelt and bread wheat. As already indicated, spelt would have been of especial importance in crop production as it is more tolerant of unfavourable conditions; its hardiness to frost, heavy damp soils and higher altitudes made it well suited to marginal land in Northern Europe.

The increase in the popularity of spelt as a crop in the Late Iron Age and Roman periods was found throughout England and not restricted to the southern counties; abundant grain production is evidenced in the North by van der Veen (1992) at numerous sites including Dod Law and Chesterhouse (both in Northumberland), and Stanwick (North Yorkshire), and also at Nidderdale Moors, Yorkshire by Tinsley (1975), and Hallowell Moss, Co.Durham by Donaldson and Turner (1977). Whilst the expansion of arable agriculture in the North may have been accelerated by the Roman presence, in many areas it undoubtedly precedes the conquest rather than following it (Jones, 1982). Similarly, van der Veen's conclusions (1992) that Northern Britain had a reasonably thriving arable economy and was not populated by pastoralists had been

evident to a number of archaeologists working on the Iron Age in this area for at least a decade.

The diet of the Roman soldier is relatively well known from documentary and environmental remains (Davies, 1971; King, 1984; Dickson, 1989, 1990). The basic diet was ground wheat, cheese, bacon and vegetables. The popular belief that the Roman army did not eat meat apart from at times of celebration is erroneous (Davies, 1971) as archaeozoological remains from British Roman forts show evidence of beef, lamb, mutton, pork, deer, chicken, hare, fish and shellfish being eaten (the latter obviously being found in greater quantities at those sites near the sea, such as South Shields and Maryport, where there was greater opportunity to obtain them).

Certainly the Romans required a lot of grain; each soldier ate about one third of a ton each year (Breeze, 1984) - an amount occupying half a cubic yard of space in the granary. Examination of the granaries of legionary and auxiliary forts show they were capable of containing very large amounts of grain; when Agricola was governor of Britain (78-84 A.D.) Tacitus stated that every fort in Roman Britain had sufficient for one year's supply (Tacitus, *Agricola* 22, 2-3). Each soldier had three pounds (1.35kg) of grain per day, and with the frontier forces stationed along Hadrian's Wall numbering around thirty thousand men in the second century (Breeze, 1984) this amounts to a daily consumption of some forty tons (40.8 tonnes)(Davies, 1989). In addition the horses used for cavalry and draught required grain and hay for fodder leading to a huge demand for agricultural produce. Grinding of the corn ration was either done collectively by the garrison or by personal hand mill; according to Herodian the emperor Caracalla ground his own ration of wheat and baked his own bread whilst in the army (Herodian, 4.7.5

). The elder Pliny when writing of foodstuffs defined *panis militaris* as wholemeal bread (Pliny, *Naturalis Historia* 18.67), and Vopiscus stated that this came in two forms - the normal standard *panes militares castrenses* and the superior quality *panes militares mundos* (Petronius, *Satyricon* 66.2).

Grain supplies in peacetime were requisitioned or compulsorily purchased at a fixed price from civilians in the local farming community. Some was also probably grown on military land around the forts; at Xanten on the Rhine there are references to the area of fields, pasture and orchards around the fort being called the *territorium*, and there is a similar reference for the auxiliary fort at Chester-le-Street, Co.Durham (Manning, 1975). Food could be produced here by the military themselves, or by civilians who leased the land (Mocsy, 1967). Research by Petrikovits (1960) has suggested that the *territorium* at the legionary fortress of Vetera (Xanten) could produce fifteen hundred tons of wheat per year, or two pounds per day for a year for six thousand men. The high cost of moving bulk goods overland was presumably avoided as much as possible ; transport by water was cheaper and the legionary forts of Caerleon, Chester and York were all on navigable rivers. However the auxiliary forts of Northern Britain were not easily reached by water and must have had local supply sources which were moved along the roads built during the Agricolan, Hadrianic and Severan periods. There is a severe lack of evidence for how the grain supply was organised, and there probably was no uniform solution because demand varied, as did the ability of the local population to supply the need.

When one considers the volume of grain needed to supply the forts it becomes obvious that not all of the requirement could be

grown locally, hence some must have been imported. Where supplies came from is unknown; some grain may have been transported on the roads from Southern England, and it is also feasible that some came by ship from Gaul to South Shields (which was a major Roman port as well as a fort) prior to being moved west along the Stanegate to other forts on Hadrian's Wall.

Spelt is the main type of wheat found in the granaries of the Roman forts along Hadrian's Wall. It was initially intended that, following the experimental work with modern material, some archaeological samples from this area could be analysed to examine similarities and differences in elemental suites within the grains. Unfortunately only South Shields yielded enough grains for the necessary five replicates used in experimental work. There are records of grain being found at Corbridge but, in common with many older excavations, organic material was not preserved. In other instances grain was improperly stored or too contaminated for trace element analysis and therefore only one sample from Hadrian's Wall was used, the other archaeological material being supplied from Iron Age and other Roman sites in Britain (Danebury, Hibaldstow, Shepton Mallet, the Forum and Bucklersbury sites in London, and Lancaster). Whilst the research on the archaeological material could only allow a brief examination of the possibilities, the sites selected cover a wide range of contexts (urban, military and rural). These could be reasonably expected to contain both local and imported grain and it was therefore hoped that any relevant differences in the elemental suites would be apparent. Work with archaeological grain is discussed in depth in Chapter 7.

1.4. Previous work on trace elements in cereal grains

Much of the previous work relating to elements in the cereal crops has been on young seedlings, roots and leaves, with very little experimental study of the grains. In the 1930s and 40s a number of American workers were examining the relationships between elements in the soil and those analysed in wheat plants, including Sullivan (1933); Beeson (1941); Morris et al. (1945) and Shrenk and King (1948). Observations drawn from their work were that the mineral composition was influenced in the main by locality, with the minor elements (manganese, iron and copper) demonstrating a wider range of values than the major ones (potassium, phosphorus, magnesium and calcium). Shrenk and King (1948) concluded that mineral content was not greatly influenced by variety or climatic factors, and that the soil series of the growing location was more important. However, most of this early work used samples which had been grown with the addition of fertilisers.

Later work on grain has tended to concentrate on more human aspects. Numerous papers relate to nutritional and dietary research, and the mineral compositions of flour and bread, including those by Czerniejewski et al. (1964); Karvanek and Janicek (1969); Lorenz and Loewe (1977) and M.A.F.F.(1981). Work has also been done on improving cereal crop yields by selecting the best cultivar for varying soil types and climatic conditions (Bacon and Collins, 1987; French and Ewing, 1989; Guzy et al., 1989). Investigating trace elements in cereals has led to an increased level of research into fertilisers; Laszitivity (1989) investigated the increased uptake of elements into plants after the application of fertilisers, whilst the works of McCord et al. (1984); Grant et al.(1988) and Sachdev et al. (1988) evaluated nutrient interactions and how these modify the

mineral nutrition of plants - an understanding of which would lead to the formulation of a sound fertiliser schedule.

Leading on from this was genetic work in breeding new cultivars for mineral content and high yield which would show better tolerance and increased production in specific nutrient environments (Rasmusson et al.,1971). Inheritance studies led to plants being bred which could utilise minerals more efficiently, and cope with abnormally high or low levels of elements - previously either at toxic or deficient levels (Kleese et al., 1968; Saric, 1987; Vogel et al., 1989).

Most of the recent studies on cereal plants have concentrated on elemental uptake by roots (Marschner et al., 1987; Linehan et al., 1989; Huang et al., 1991), transport through the plant (Borkovec et al., 1990; Campbell et al., 1990; Liljeroth et al., 1990)and deposition in the leaves (Schenk and Fuller, 1990; Gaudillere and Barcelo, 1991; Rawson, 1991) with much work at cellular and organelle level (Clarkson et al., 1988; Johannes et al., 1991; Hofer et al., 1992; Nasuda et al., 1993) Very little research appears to have been concerned with the grain - indeed, much is based on seedlings and immature plants. Many recent studies which have looked at the whole organism are,not surprisingly, related to pollution and factors causing the uptake of pollutants into plants (Pilegaard, 1978; Cawse, 1982; Harrison and Chirgawi, 1989).

1.5. Suppositions and assumptions relating to research

In a three year project it is impossible to cover every factor relating to this general field of research, and it is necessary to select those aspects pertaining to associations between soil/plant/trace element on which one is going to work. This project

involved the establishment of a basic data set using modern grain samples grown on known soil types (Chapters 3 and 4), but it also proved necessary to investigate changes in elemental concentrations and proportions in charred grain (Chapter 3), and the influence of genetic and environmental factors on elemental uptake (Chapter 5). Since some archaeological material was also analysed (Chapter 7) it was considered useful to examine the effects of short term burial in an attempt to assess possible diagenetic changes in elemental patterns (Chapter 6). To cover all eventualities certain assumptions must also be made before experimental work can start; these cover all aspects of work and relate to both the basic biological materials (plants and soil) and the experimental and analytical stages.

1.6. The plant

One must assume that the modern plants used in establishing the basic data set are physiologically and biochemically similar to the Iron Age and Roman species. Genetically they are known to have the same set of genomes (AABBDD), and since much research has been done on the origins of the spelt genus (Percival, 1921; Harlan, 1965; Kihara, 1965; Helbaek, 1966; Harris, 1967; Riley et al., 1967; Harlan et al., 1973; Zohary and Hopf, 1988) the present day species is thought to be similar to its predecessor in most, if not all, ways. Van der Veen obtained the grain for growing in her test plots from Dr.P.Reynolds, who was originally provided with spelt from the Near East for the Butser Ancient Farm Project (1987).

When analysing grain samples with a view to relating elemental suites to those of the parent soil, the enormous assumption is made that all grains in the sample have the same origin. The modern grain

used in the experimental work was all grown in known areas so there is no doubt about its provenance. However, there is the possibility that grain supplied to Reynolds may have come from more than one environment. If the uptake of elements into the grain has a genetic factor then there may be differences relating to the site where the parent plant originated. In order to minimise any possible variation all the modern grain used came from the second harvest at the selected sites; this meant that both seed and parent plant should relate to the same soil type. This matter is further discussed in Chapter 5. Whilst the work with modern grain hopes to prove conclusively that grain grown on a particular soil type will have different proportions of the chosen elements from that produced on another soil, problems arise when archaeological grain is examined as there is a possibility that samples contain material from various growing sites. For example, samples can be obtained from "rural" contexts, such as a villa or a small farm; the grain may have been produced (a) all on one local soil type, (b) locally but on a variety of surrounding soils, or (c) brought in from other areas by trade or barter mechanisms. Similarly, samples from storage pits at hillforts possibly came from grain producing areas outside the immediate vicinity. The hypothesis that hillforts were proto-urban and acted as "central places" (Cunliffe, 1991) where grain was brought in tribute payment to those at the top of the hierarchy makes it highly possible that material from the same context could come from geologically and geographically distinct regions. This problem is also encountered in grain from Roman contexts - especially those from the military granaries where, to fulfil dietary needs, some must have been imported. It is feasible that grain from the South Shields granaries could have come from the

North of England, the South of England or Gaul. Whilst the experiments with archaeological grain would hopefully demonstrate that material grown in different areas did show varying proportions of the elements, the possibility remains that if a sample under analysis contained grains from a number of widely diverse areas the results would not in fact relate directly to any, being a combination of all those present. There is no way of sourcing the grain prior to analysis and therefore one can only assume an unmixed sample. In the future it may be possible to develop methods allowing analysis of single grains such that a large number may be examined and their similarities and differences related to one or more growing areas: the techniques available for this present research preclude the analysis of such small amounts of elements and therefore samples must consist of a larger number of grains.

1.7. Experimental work

Experimentally a further range of problems are encountered. To establish a basic data set one must assume that the method of elemental extraction works and gives comparable results; the decomposition and removal of ions from the sample must also be complete and not show any inequalities. Chapter 3 deals with the microwave digestion of the grains, which was the technique chosen for breaking down the seeds to release ions and produce samples suitable for analysis. Various tests were made to check that digests were complete and the results comparable, but when dealing with different samples and anticipating varying proportions one has to assume the procedures hold good for all.

Charred modern grains were required for two experiments involving the analysis of burned material and elemental changes

occurring during burial, and there are obviously various techniques of charring. The chosen method involved combustion in an open vessel, and was used for all sample requirements. Other methods involve heating at higher or lower temperatures, or the use of closed vessels; these may have given different results on analysis but time and grain supplies being limited only the first method was used experimentally. Comment was passed that charring small individual samples of grain was not a similar procedure to firing a granary or grain pit. This is accepted, but as it was necessary to know the original pre-charring weight of each sample it was decided that burning should be done separately for each replicate. In addition, not all the charred grain came from burnt pits or granaries; much of the material was obtained from flotation and burning small samples would seem to be acceptable in relation to this.

1.8. Analytical work

Analysis of trace elements in grains makes the initial assumption that the elements are actually present in the first place. Recent work using electron induced X-ray emission (EIXE) and proton induced X-ray emission (PIXE) techniques of analysis (see Chapter 2) proves without doubt that they are, and has even been able to localise certain elements within specific structures (Mazzolini et al., 1981). Since decomposition of the grains is apparently complete using an acid digest, one assumes all elements are liberated into the resulting solution. It would have been interesting to compare distribution patterns of elements within the grain in fresh, charred and archaeological material; samples were prepared in resin mounts and sent for examination under the scanning

electron microscope (SEM) in the Oxford laboratory but unfortunately these could not be examined. Possibly SEM examination of archaeological grain may not have proved interesting because the amount of elements taken up in samples such as those from Lancaster are so great that they must have a distribution throughout the grain rather than being specific to certain areas (see Chapter 7). The system used in the Oxford laboratory provides a semi-quantitative method of analysis for samples, and archaeological material may cause further problems; when large amounts of elements are examined signals from one element may interfere with other signals in a positive or negative way, thus enhancing or reducing values (Dr.K.Durose, pers.comm.). It is possible to obtain corrected values by the use of calibration programs but these are complex (Goldstein et al., 1992).

1.9. The soil

Vexed questions remain regarding soil analysis, both in the methods used and the value or accuracy of the results. It is accepted that chemical extraction cannot replicate how a plant utilises the elements in the soil, and that the amount of a specific element in the soil is not necessarily proportional to that in the plant tissues (Wentworth and Davidson, 1987). However, comparison of the total and available elements in a soil sample gives an idea of how amounts of elements vary from site to site, which might relate to uptake by the plant. Baize (1988) also suggests that the ratio of available (free) element to total element can indicate the degree of weathering in a soil with high values indicating a well-weathered soil. It is not disputed that environmental factors such as temperature, rainfall and microbial activity can alter

conditions within a soil, as also can pH, cation exchange capacity and redox potential (Singer and Munns, 1991), but the initial aims of the project were more botanically orientated and it was not possible to include a full soil analysis. Therefore it was decided most relevant to examine the total concentrations of the chosen six elements in all soil samples, together with the available micronutrient concentrations and pH. It was hoped to examine the available macronutrient concentrations but unfortunately the results obtained using the method described by Hesse (1971) involving leaching the soils with 1M ammonium acetate were widely divergent; as a large standard deviation from the mean is an indication that the values are not reliable these were disregarded, and only the total concentrations of calcium and magnesium included in this work.

1.10. Archaeological samples

When selecting archaeological grain for analytical work several assumptions have had to be made. Even experts with long years of experience agree that it is extremely difficult to identify grain samples to species level without rachis and glume fragments, due to the overlap in grain morphology between species and changes in shape occurring during the charring and burial processes (J.P.Huntley, pers.comm.; Kuhn, 1991). Most specialist work is assisted by comparing modern reference specimens and diagrams in seed atlases with the ancient material. When chaff fragments are available venation patterns and angles on the glume faces can be examined and are diagnostic to each ploidy levels, and to some extent to each species (Jacomet, 1987). When only naked grain is available problems arise. The shape of the grain can give a basic indication; spelt grains have a low, rounded dorsal profile, rounded ends, more

or less straight or parallel sides, and are longer than the maximum width. Emmer grains have a marked dorsal ridge and pointed ends, whilst bread and club wheats have a more pronounced dorsal curve, a steeply placed embryo, and are short and fat with the greatest width near the embryo. It is possible that non-compact grains of bread wheat may be identified as spelt, and vice versa compact grains of spelt as bread wheat (van der Veen, 1992). Departures from the typical picture were accentuated when modern samples were charred. The burnt product, whilst not undergoing gross distortion, did have a very rounded and plump appearance, and looked more similar to bread wheat. Barley, oat and rye are more easily recognisable having more distinct and individual grain morphologies. When looking at archaeological samples one can therefore only discard those grains which are obviously from other species, and select those which most resemble the botanical description of spelt. In doing this one must be aware that one might be discarding spelt and including other cereal species, but until totally accurate methods for selection are devised this is the best that can be achieved.

Also associated with archaeological samples is the problem of provenance. If the grain deposit is sufficiently large it is obviously sensible to take the sample from an area in the centre to avoid the possibility of peripheral contamination from the burial environment. Mixed grain assemblages and smaller contexts do not allow this degree of selection, but one still has to allot the same degree of purity. Additionally, the possibilities (perhaps even likelihood) of contamination by excavator or at the processing stage must exist. Four of the archaeological grain samples were obtained after flotation and sorting in other laboratories, and the suppliers of the ancient material could not state exactly which

washing and drying procedures had been followed. Whilst one assumes care was taken to avoid contamination it remains a possibility. In an ideal situation one would be present at excavation stage to remove and clean samples personally but this was neither possible nor practicable.

1.11 Plan of research

Spelt wheat was selected as the research material with which to establish a data set of elemental concentration values because it was available in uncontaminated form from a number of sites throughout Britain covering a wide range of geological and environmental locations. It is also found in the archaeological context allowing a comparison between modern and ancient samples of the same species.

The first stage of the experimental work involved developing a technique which would extract the ions of interest from the grains in a form suitable for analysis by atomic absorption spectroscopy. Decomposition of biological materials is commonly performed using mineral acids, and initial extractions from the grains utilised a "hot plate" boiling method. This was found to be unsuitable and a technique involving closed vessels in a microwave oven was developed. Experimental method and results using the modern grain samples are detailed in Chapter 3.

If a comparison is to be made between elements in the plant and in the soil analytical work must also be done on the growing medium. Soil samples were therefore obtained from the original production sites (of the modern grain) around Britain, and total and available nutrient element concentrations measured together with pH; the methods used and the results are given in Chapter 4.

Since it is currently unknown which factors affect elemental uptake into the grain in a cereal crop, experimental work was also done in an attempt to assess the importance of genetic and environmental factors. This involved growing grains (produced on different soils around Britain) up to harvest on one "new" soil type in Durham; the resultant crops were then analysed and the differences in elemental concentrations in the original and harvested grains examined. This experiment was repeated over a period of three years to ensure that any falsely high or low results (due to adverse weather conditions) were seen to be abnormal and not accepted as accurate. The methods used and the results obtained are given in Chapter 5.

When elemental concentrations in archaeological material are examined there is always the problem of which percentage of the measurement relates to the *in-vivo* conditions, and how much is due to post-depositional change. Various workers have examined changes in human bone, but little investigation appears to have been done with other materials. In an attempt to discern which elements are most likely to show measurable differences in concentration due to burial, a short-term experiment was designed to assess diagenetic changes. Chapter 6 deals with the burial method, recovery, analyses and results.

Finally, it was possible to analyse a small number of archaeological samples. These proved difficult to obtain because many sites could not provide a sufficiently large quantity of uncontaminated grain, and the number of sites involved in the series is unfortunately small. However, those chosen give a wide variety of contexts, and a large range of concentration values. Chapter 7 gives details of treatments applied to the archaeological grain and the

results obtained. The latter, together with points from earlier experimental work in this research, are more fully discussed in Chapter 8 which attempts to draw some useful conclusions about the study and future possibilities.

CHAPTER 2

PHYSIOLOGY OF THE CEREAL PLANT

Now all grain sends out an ear from the third to the fourth joint; and when it has pushed out the entire spike it casts its bloom within eight days.

Columella

2.1. Introduction

As the experimental work involved breaking down cereal grains and extracting various elements it is necessary to understand something of the formation and structure of the seed, how nutrient elements are taken up by the plant and passed into the grain, and where and in what form they are stored.

Each cereal plant originates from a seed which after germination develops into a young plant or seedling with roots, stem and leaves. To allow establishment of the seedling, grains need to store sufficient reserves of organic compounds and mineral nutrients to support the early growth processes. By the time these have been utilised the root system of the new plant has a sufficiently developed root system to absorb further minerals from the soil. When the plant is mature (and according to season) flowers form and fertilisation occurs leading to the development of seeds, which will produce the next generation. Ninety nine per cent of the plant material is composed of carbon, hydrogen, oxygen, nitrogen, phosphorus and sulphur, with the macronutrient elements calcium, sodium, potassium and magnesium forming the remainder. A number of micronutrients (or trace elements) are essential for normal growth and development including copper, iron, manganese and zinc, which

although of vital importance are only found in very small amounts (Duffus and Slaughter, 1980). A variety of these minerals are present in cell walls and organelles, associated with maintaining the integrity of membranes, and involved with enzymes and metabolic processes. A further proportion is found in metallo-proteins, or combined with phytin in globoid crystals inside protein bodies (see below , 2.2.).

The macronutrients calcium and magnesium, and the micronutrients copper, iron, manganese and zinc were selected for study and reasons for this choice together with the functions of each individual element within the plant are given in Chapter 3 (3.7.).

2.2. Seed structure

The average ear of spelt wheat contains between forty and fifty grains. These are small (approximately 8mm. by 3mm.) with a smooth, rounded dorsal surface and a furrow, or crease, along the ventral surface. A longitudinal section through a mature grain is shown at Fig. 2.1. The outer layer, or pericarp, is composed of four or five layers of cells, surrounding the starchy endosperm which forms the bulk of the seed and acts as a carbohydrate store. The embryo at the base of the grain on the dorsal side is a highly differentiated organ which develops into the seedling after germination. In the seed it is separated from the endosperm by the scutellum, a fleshy, shield like structure. Inside the pericarp are the aleurone cells composing a single layer of large rectangular cells derived from the outermost layer of the endosperm.

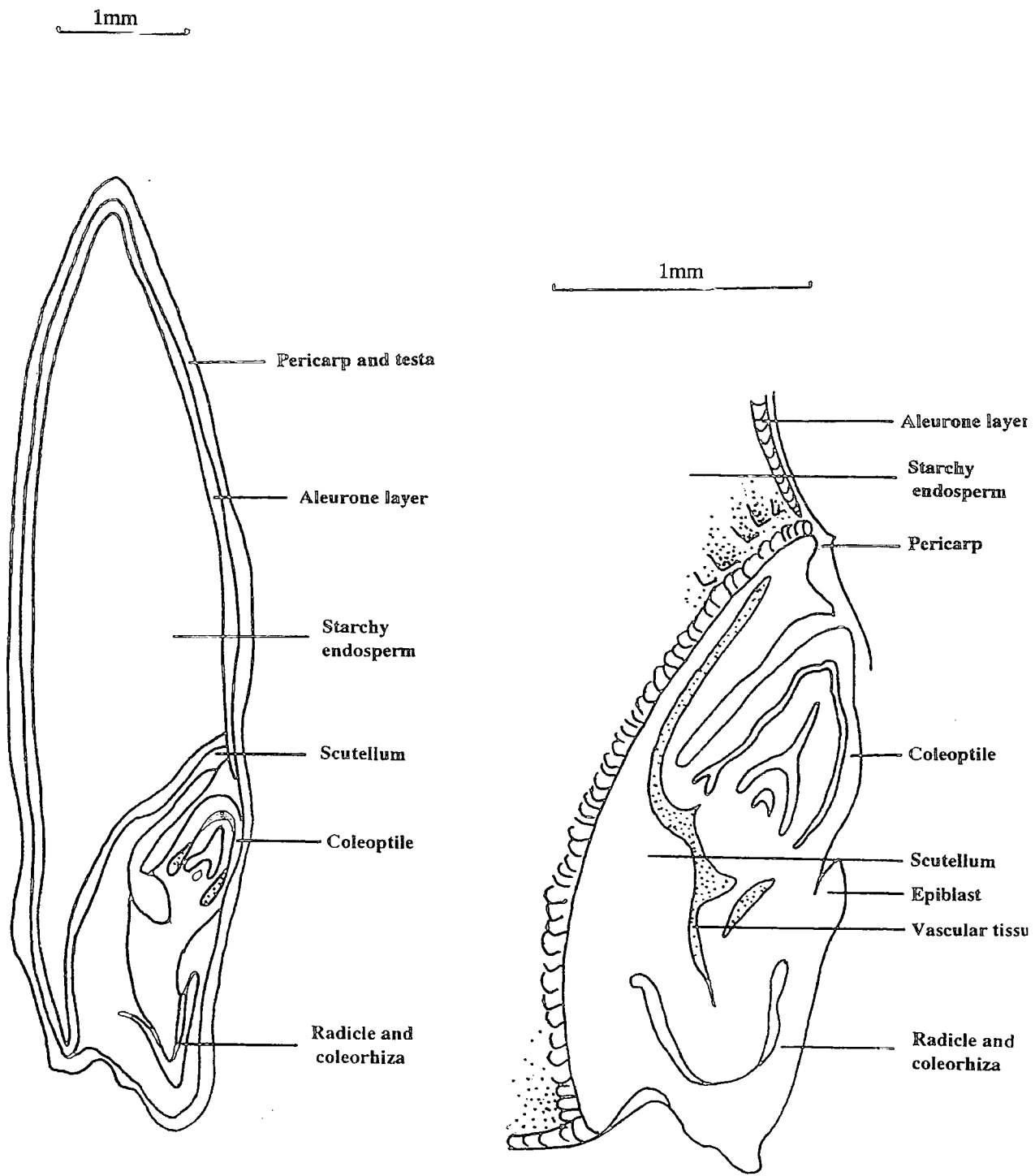

Fig.2.1. Longitudinal section through a mature grain of wheat

Morrison et al. (1978) distinguished three distinct types of aleurone cell of varying size, shape, ultrastructural organisation and location within the grain: (a) those around the dorsal and flank regions, which are the most abundant, (b) those extending over the scutellum, and (c) those in the crease region. In each of these types the cytoplasm of the mature aleurone cells is characterised by the presence of electron dense protein bodies (or aleurone grains) of vacuolar origin which contain inclusions known as phytin globoids. These subcellular structures are involved in the storage of mineral reserves within the cell and have considerable structural diversity ranging from an amorphous proteinaceous matrix to complex forms containing globoid crystals, soft globoids and protein crystalloids (Lott and Spitzer, 1980). Much of the volume of the protein bodies is occupied by proteinaceous reserves, and minerals are stored mainly in the globoid crystal portion. These mineral reserves are mainly in the form of "phytin", a cationic salt of inositol hexaphosphoric acid, which acts as a chelator, binding cations, and is also able to complex some proteins. For a more detailed description of phytin see Appendix 1. Magnesium and potassium are the most commonly occurring cations in globoid crystals, but calcium, iron, manganese and sodium are also localised. Buttrose (1963) showed the globoids formed a rich store of phosphorus, potassium and magnesium in wheat, and Ogawa et al. (1979) gained similar results with rice. The total amount of minerals in the grain changes little from the nineteenth day post-anthesis to maturity (at circa thirty five days) but the elements are initially distributed through the starchy endosperm and only concentrate in the aleurone layer in the fourth and fifth weeks (Tanaka et al., 1974).

Jacobsen et al. (1971) found that in barley the greatest accumulation of phytin was in aleurone cells nearest to the crease, and close to the vascular supply; Stewart et al.(1988) also examined barley grains using energy dispersive X-ray (EDX) techniques and found varying levels of calcium, phosphorus, potassium and magnesium in the different types of aleurone cells. However, Morrison et al. (1978) discovered phytin distribution in wheat to be very different, with the aleurone cells closest to the vascular supply having least phytin. Later work by Lott and Spitzer (1980) confirmed that the globoid crystals farthest from the embryo and crease contain the highest levels of phosphorus, potassium and magnesium.

Improved technology has led to greater knowledge in the fields of elemental distribution. Various workers (Lott and Spitzer, 1980; Pitman et al.,1981; Storey et al.,1983; Stewart et al.,1988) using X-ray techniques were able to spot-analyse chosen cell regions and found specific distribution patterns of certain elements, with concentrations of magnesium in the aleurone layer together with lower amounts of calcium, and only traces of iron and manganese. Analysis of the whole grain found larger amounts of calcium suggesting it was present outside the globoids, and in other forms apart from phytin.

X-ray micro-analytical techniques use electrons instead of light hence increasing the resolution of microscopy; as the wavelength of electrons is much shorter than that of light the resolving power of the electron beam is much greater than a light beam. The electron microscope can also be adapted for analysis, at least for elements of atomic number eleven (sodium) and above. The elements are bombarded with high energy electrons and emit X-rays that can be analysed in terms of energy and wavelength, each of

which is specific to given elements, and the response can be quantified. The PIXE (proton induced X-ray emission) has a major sensitivity advantage over the electron microprobe EIXE system (electron induced X-ray emission), and improvement in beam resolution has made it better for studies in the localisation of elements, although not without problems. The dry crumbly nature of cereal grains caused difficulties in the production of thin sections; Mazzolini et al. (1981) found those of 30-40um thickness had to be supported between nylon foils which were a possible source of contamination. Leaching and migration of elements can also occur in specimen preparation; Hall and Gupta (1983) noticed a loss of organic material under electron probe irradiation, and Legge and Mazzolini (1980) found there was elemental loss with an unscanned beam using a proton microprobe.

The work of Mazzolini, Legge and Pallaghy (1981) in Melbourne has produced some of the finest distribution scans for wheat grains which demonstrate very definite concentration zones of certain elements. Manganese and iron show the densest concentrations and most precise localisation of the elements examined, being found primarily in the scutellum, coleorhiza and extending into the nucellar projection (but with a marked absence from the epiblast, lateral and primary roots). Calcium and copper are shown as a fine scatter throughout the grain, whilst magnesium is predominantly concentrated in the aleurone layer. Zinc appears to be generally scattered throughout the grain (but at slightly denser concentrations than calcium and copper) with areas of increased density in the nucellar projection and aleurone layer.

2.3. Seed formation

Each cereal grain is a one-seeded fruit - the fertilised and mature ovary of the flower. All cereals, with the exception of rye, are almost entirely self pollinating and the pollen remains within the flower in which it developed, germinating on the stigma, and forming a pollen tube which penetrates the style. This carries the two male nuclei into the embryo sac; one nucleus fuses with the nucleus of the female egg to form the zygote from which the embryonic tissues develop. The other unites with the two polar nuclei to form the triploid primary endosperm nucleus. This divides rapidly and within fifty to sixty hours post-fertilisation has formed up to 5,000 free endosperm nuclei in wheat (Frazier and Appalanidu, 1965). At this stage cell wall formation starts and the endosperm becomes cellular; further growth is by normal cell division which continues for three to four weeks after anthesis, the final cell numbers in wheat being approximately 100,000 - 150,000. Subsequent growth of the grain is by cell expansion during which the endosperm cells fill with starch and protein. It is because the endosperm is such a highly developed food storage tissue that cereals have great nutritional and economic importance.

When cell wall formation begins other cells also start differentiating, including the vascular elements in the pericarp which eventually develop into the vascular bundle in the ventral crease - the translocatory tissues which conduct nutrients into the grain. Three weeks after anthesis there are two areas concerned with nutrient translocation - the pericarp vascular bundle, and the portion of the nucellus known as the nucellar projection. Between these two areas lies the chalaza, the point where the integuments diverge from the nucellus (see Figs. 2.2.and 2.3.). The pericarp,

chalaza and nucellar projection extend, with some changes in general outline, from the base of the grain to the apex. The vascular bundle serving as the principal channel of nutrient transfer contains both xylem and phloem, and extends through the pericarp at the base of, and parallel to the crease. Nutrients move into the grain by coming up the vascular bundle, moving across the chalaza and out into the kernel via the nucellar projection. Zee and O'Brien (1970) found sudanophilic bodies in the chalazal cells of wheat and suggested they were involved in controlling the flow of water and solutes into the grain. This was confirmed by Sofield et al. (1977) who noted that when lipids were deposited in the chalazal cells, water entry into the grain ceased, suggesting that growth is terminated by a lipid blockage. This deposition appears to take place in response to water stress (Barlow et al., 1980) and causes hydraulic isolation of the grain. Water movement in the grain is a vexed question - the similar concentration of nutrients in the phloem sap (which is moving into the grain) and in the grain suggest that a lot of water is passing in, but grain weights show that it is not accumulated. Jenner (1982) suggested water is re-circulated, and Cochrane (1983) that the xylem parenchyma cells control the amount of water entering the endosperm, with excess amounts being exported via the xylem, or lost by pericarp transpiration.

Environmental conditions before anthesis influence the number and size of ears in wheat, whilst conditions at anthesis and in the following few days determine how many grains are set, high temperature, low illuminance and water stress being particularly unfavourable at this time (Fischer, 1973). Subsequent grain growth is sustained largely by photosynthesis and transfer of nutrients and water via the phloem system.

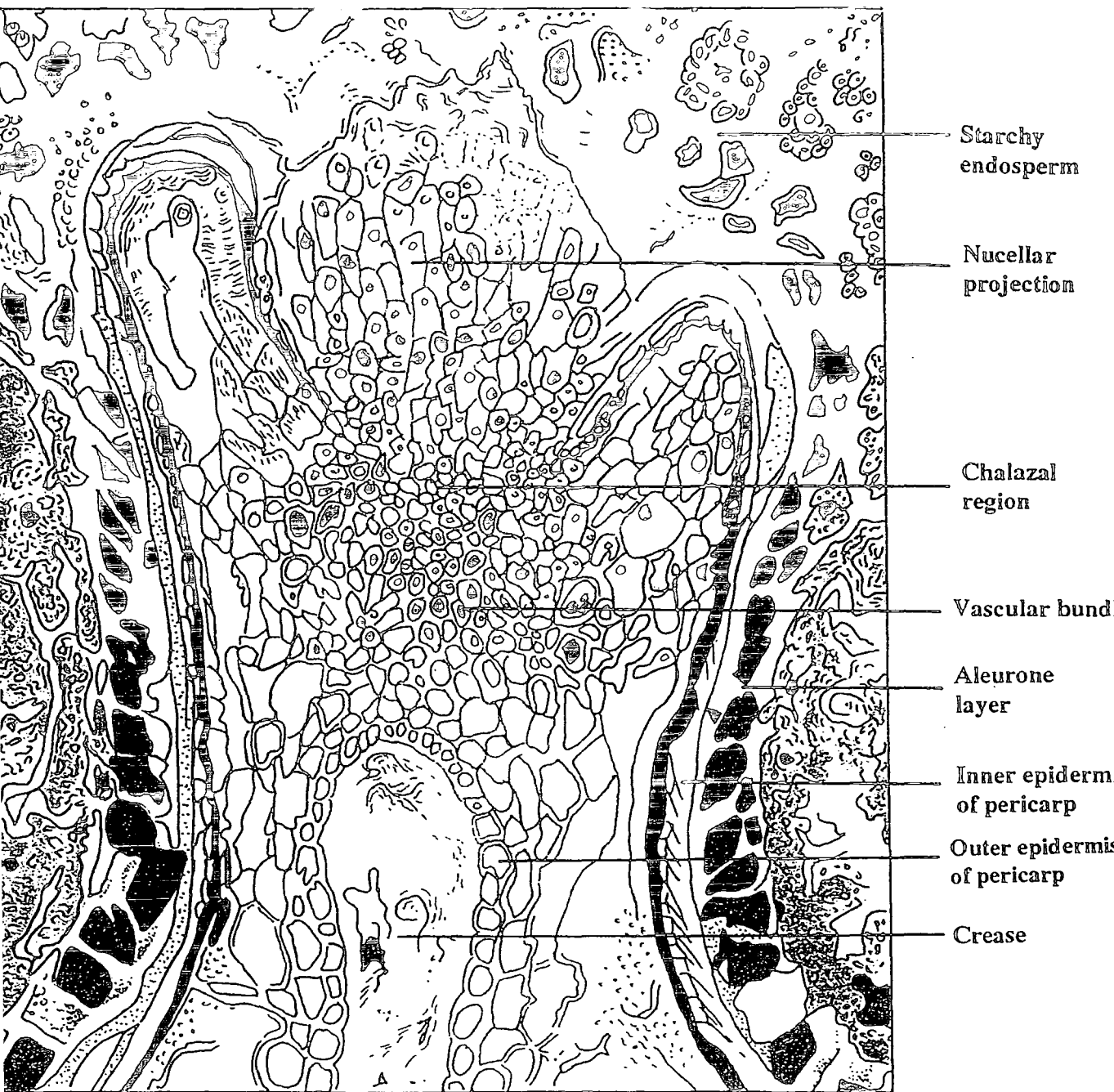

(X400)

Fig. 2.2. Transverse section through crease region of mature wheat grain (after a photomicrograph by Dr. P.Cochrane).

1mm

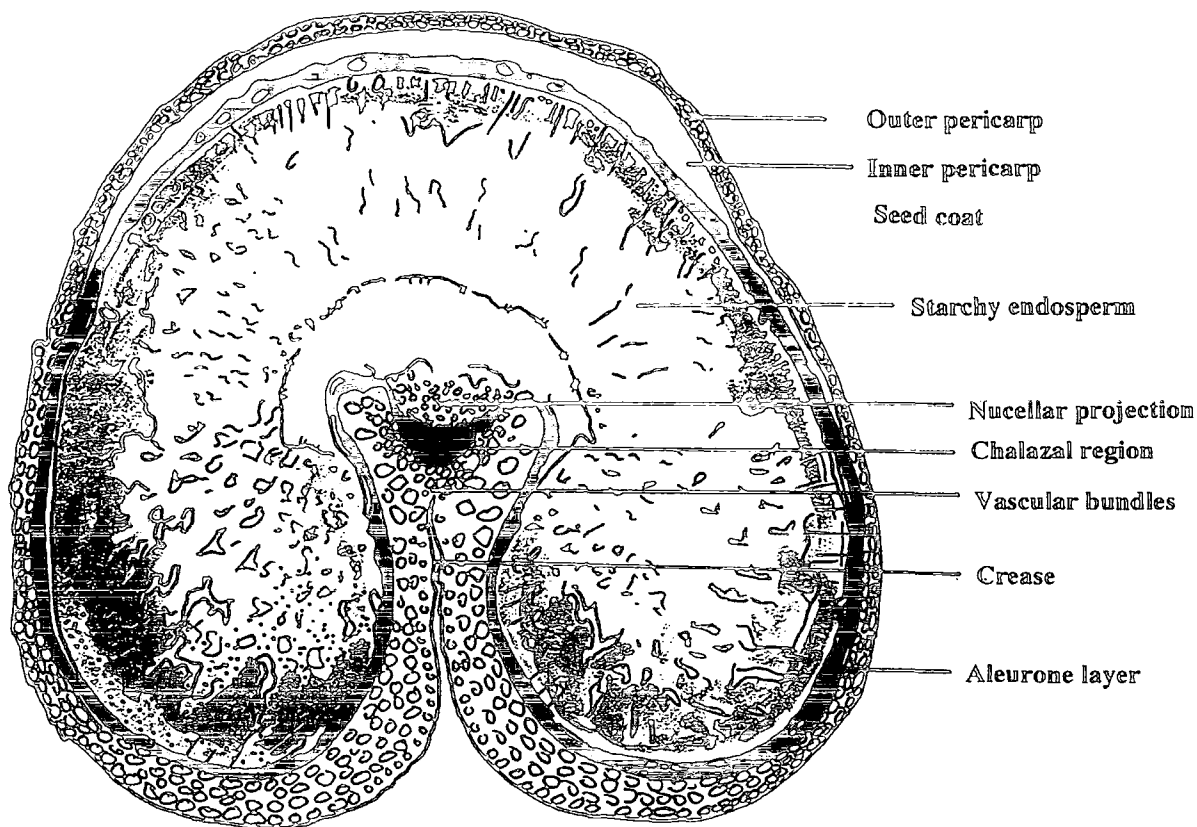

Fig. 2.3. Transverse section of wheat grain.

2.4. Nutrient movement into the plant

Plant growth requires a continuous net shift of ions from the soil system into the plant - i.e. a steady input of ions from the solid phase into the soil solution and a continuous metabolic removal of ions from the soil solution by the plant. This process has four stages:

- (1) Release of ions from the solid phase into available form in the soil solution.
- (2) Movement of ions to the vicinity of the root.
- (3) Movement of ions into the root, where they can accumulate.
- (4) Movement of ions up through the plant.

The uptake can be limited at any one of these stages, being influenced by the transport of ions to the root surface and also by the nutrient demands of the plant.

Nutrients move to the root from the soil solution by two processes; mass flow (or convection) and diffusion. In mass flow water is absorbed by the roots to meet losses due to transpiration from the shoots; this causes more water, carrying dissolved ions, to flow towards the roots replacing the fluid taken up. In diffusion ions move along a concentration gradient established between the root surface and the body of the soil; ions diffuse towards the root if they are taken up faster than they are carried to the root surface by mass flow (and away from it if the converse occurs). If mass flow is unable to supply sufficient quantities of a particular nutrient its concentration at the root surface is reduced and a concentration gradient established. Ions then move from points of high concentration to points of low concentration down the gradient. How far this extends from the root surface depends on the rate of diffusion, and this latter process persists until an equilibrium is re-established. This ensures that low concentrations of nutrients in the vicinity of the roots can be increased by additional amounts of elements being brought in.

Roots are extremely well adapted to exploit the soil for mineral nutrients as they form a widely branching network with a large surface area. Water from the soil solution is able to enter the root in three ways: (a) through the relatively undifferentiated tissues near the root tip (which is the most active zone of uptake), (b) through the root hairs, or (c) through the cortical cells of the rest of the root system. Ion uptake into roots is a difficult research topic because growing roots are inaccessible and

experimental methods must inevitably involve the destruction of their environment. In the living plant the root system is undergoing continual changes in its length and spatial distribution and conditions within the soil (pH, wetness, aeration and temperature) are not constant. Most work is therefore done in culture solutions involving a single section of root of known length in a constant and controlled environment which probably only gives a partial reflection of the actual uptake processes (Brewster and Tinker, 1972).

Ions in solution enter the plant through the root system and are transported to regions of need. These ions are subjected to two main physical forces; they can move down a chemical gradient from a higher to a lower concentration, or are acted upon by an electrical gradient where cations are attracted to negative electro-potentials, and anions to positive. Living cells contain various electro-chemical gradients which must be considered as affecting any ionic movement around, across or within them.

For nutrients to enter into the plant, ions have to be transported across the root membranes by either passive or active processes. Passive transport involves the diffusion of ions down or along an electro-chemical gradient through protein channels which can be opened or closed by a protein spanning the membrane. This "gating" of the channel is affected by a change of potential across the membrane, the binding of specific chemicals or physical factors, and is probably under metabolic control but the movement of the ion is simply down a gradient of free energy (Flowers and Yeo, 1992). Since roots are able to accumulate ions to higher concentrations than those in the soil solution outside, there must also be active transport processes operating to allow uptake against a

concentration gradient. Active uptake is selective to specific ions and closely associated with metabolic processes, especially respiration which produces adenosine tri-phosphate (ATP) and hence provides the energy necessary for uptake. The biochemical processes are still not fully understood and there are currently two theories attempting to explain ion transfer (Flowers and Yeo, 1992). The "Carrier ion hypothesis" involves a phosphorylated molecule with specific binding sites for the ion. At the outer membrane (or plasmalemma) boundary the carrier molecule and ion are bound together to form a complex which can traverse membranes of limited or no permeability to free ions. This diffuses across the membrane to the inner boundary where a phosphatase enzyme splits the complex and the ion is released into the cytoplasm. A carrier ATP kinase enzyme located at the inner membrane regenerates the selectivity of the carrier and the newly phosphorylated molecule diffuses back to the outer boundary to repeat the process. The carrier molecules are possibly ribonucleo-proteins or other phosphorylated energy rich nitrogen compounds; proteins are probable because they are capable of forming reversible complexes, show a high degree of specificity towards particular ions, and can alter their shape by folding or unfolding of polypeptide chains to bind ions. Each ion species is transported by specific carrier sites but there is evidence of competition between closely related species of elements (Epstein and Leggett, 1954; Chaudhry and Loneragan, 1972; Robson and Pitman, 1983).

The "Ion pump theory" suggest that ATPase activity in the membrane results in the production of adenosine di-phosphate (ADP) in the cytoplasm and hydrogen ions which are released into the outer medium resulting in pH changes. This establishes electrochemical

gradients across the membrane, with the inner side more negatively charged. Since ionic absorption must maintain an overall electrical neutrality within the plant cations are attracted into the cytoplasm and the membrane depolarises. Anions can be taken up similarly with changes in the concentration of cytoplasmic hydroxide (OH^-) or bicarbonate (HCO_3^-) ions. It is highly probable that both ion pump and carrier molecule systems exist to ensure adequate transport of ions into the plant (Pitman, 1982).

Transport of ions through the root involves the crossing of three membranes: (a) at the outer surface of the cytoplasmic phase, (b) at the boundary between the cytoplasm and the vacuole, and (c) between the symplast and the xylem (Pitman, 1972). Once in the root itself some nutrients may be metabolised (in the production of root hormones and growth substances for example) or accumulated in vacuoles; others are required by the plant and transported to the stele and into the xylem system which is involved in the conduction of water and nutrients up from the roots to the shoots in the transpiration stream. This is probably based on "plant demand" where transport to the shoot is controlled by active nutrient transfer into the xylem, regulated by the supply of metabolites from the shoot. In the shoot nutrients are utilised by the leaf cells and the excess exported back to the root in the phloem transport system, and this feedback causes increased or decreased uptake.

There is also a secondary redistribution of ions from mature leaves to actively growing centres (seeds and young leaves). The degree of movement and transfer depends on the mobility of the element in the phloem. Calcium is of low mobility and not readily redistributed from senescing leaves; as it is continually required for metabolic processes and cell maintenance this causes high total

levels of the element in the plant. Magnesium, manganese and zinc are freely mobile as free ions, as is copper to a more limited degree (although a larger proportion is probably transported in ionic form). Iron is reduced at the root boundary from Fe(III) to the divalent Fe(II), but after absorption is oxidised again and translocated in the form of iron(III) citrate (Christ, 1974).

2.5. Conclusions

Plants require a continual supply of inorganic ions to enable them to grow and complete their life cycle; these are taken up in varying amounts from the soil solution and re-distributed throughout the plant. To enable seeds to germinate and produce a seedling trace elements must also be deposited within the seed to allow growth before the absorptive mechanisms in the roots have developed; in cereal grains these are found in the protein bodies of the aleurone cells. In order to analyse the elements the grains must be chemically broken down and the ions extracted from the aleurone layer. The methods used to gain a solution containing the relevant elements from the grains are discussed in the following chapter.

CHAPTER 3

DIGESTION & ANALYSIS OF THE GRAIN

Boil thou first i' the charmed pot
Shakespeare

3.1. Introduction

Grain samples of spelt were obtained from eighteen plots used by Dr.M.van der Veen in her research on the relationships between weeds and cereal plants in the field. Additional samples were provided by Ms.M.Bower (Cambridge and West Stow), and the seed and botanical research stations in Rothwell, Lincolnshire (Nickersons) and Cambridgeshire (P.B.I.). These twenty two sites were geographically widespread through England, Wales and Scotland (see Fig. 3.1.), and covered a wide range of ecological and geological habitats (Fig. 3.2.). For example, Boston soils are derived from Jurassic clays and alluvium, those on the Wirral from the Triassic Bunter sandstone, and those at Lampeter from Ordovician shales. The solid geology of Truro relates to very old intrusive igneous rocks, whilst that of the Durham area is associated with the Carboniferous coal measures (Applied Geochemistry Research Group, 1978). The implications of different bed rocks and soil types are more fully discussed in Chapter 4.

Grain from the plots used by van der Veen and Bower had been grown without the addition of fertilisers, and as far as possible were in uncontaminated areas. All the grain samples used were grown in the same way and harvested in the same year (1989), being grown from grains harvested in the previous year. From literature searches

it would appear that such samples have never before been collected together and analysed chemically. Previous research on large grain samples from diverse locations involved the use of soil improving agents and fertilisers, and the results of their analyses reflected how well man had interfered with his basic material, rather than how the plant utilised a natural environment.

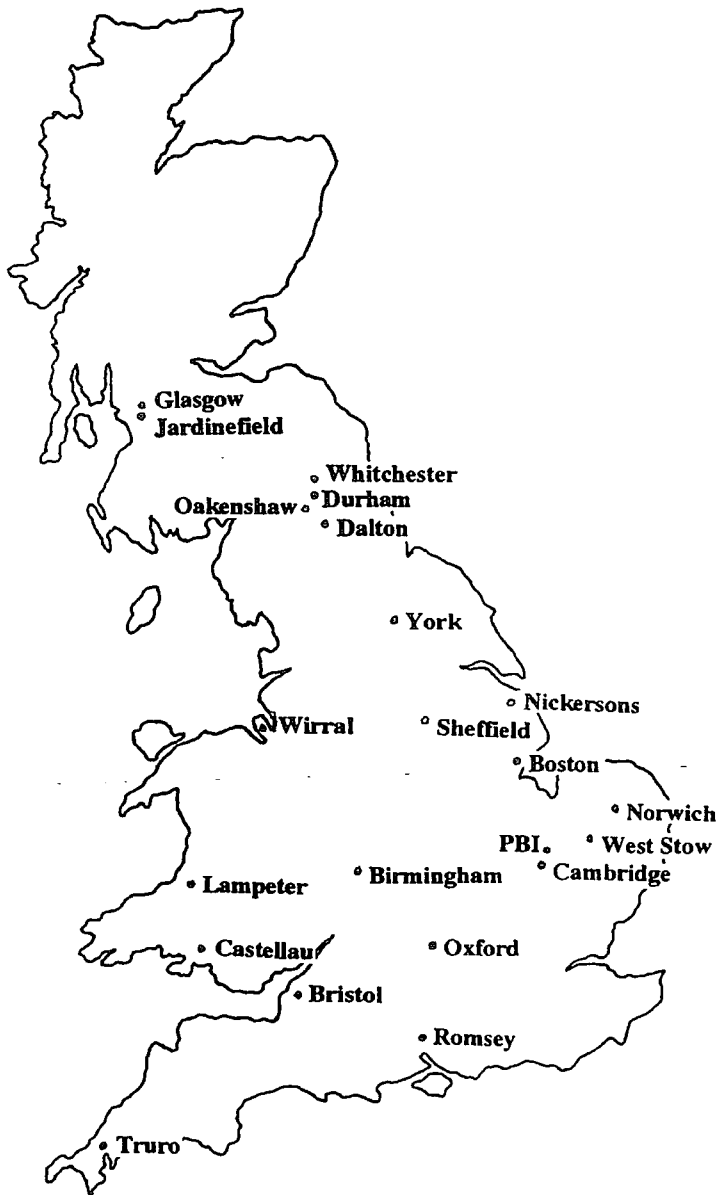

Fig. 3.1. Distribution of sites producing modern experimental material.

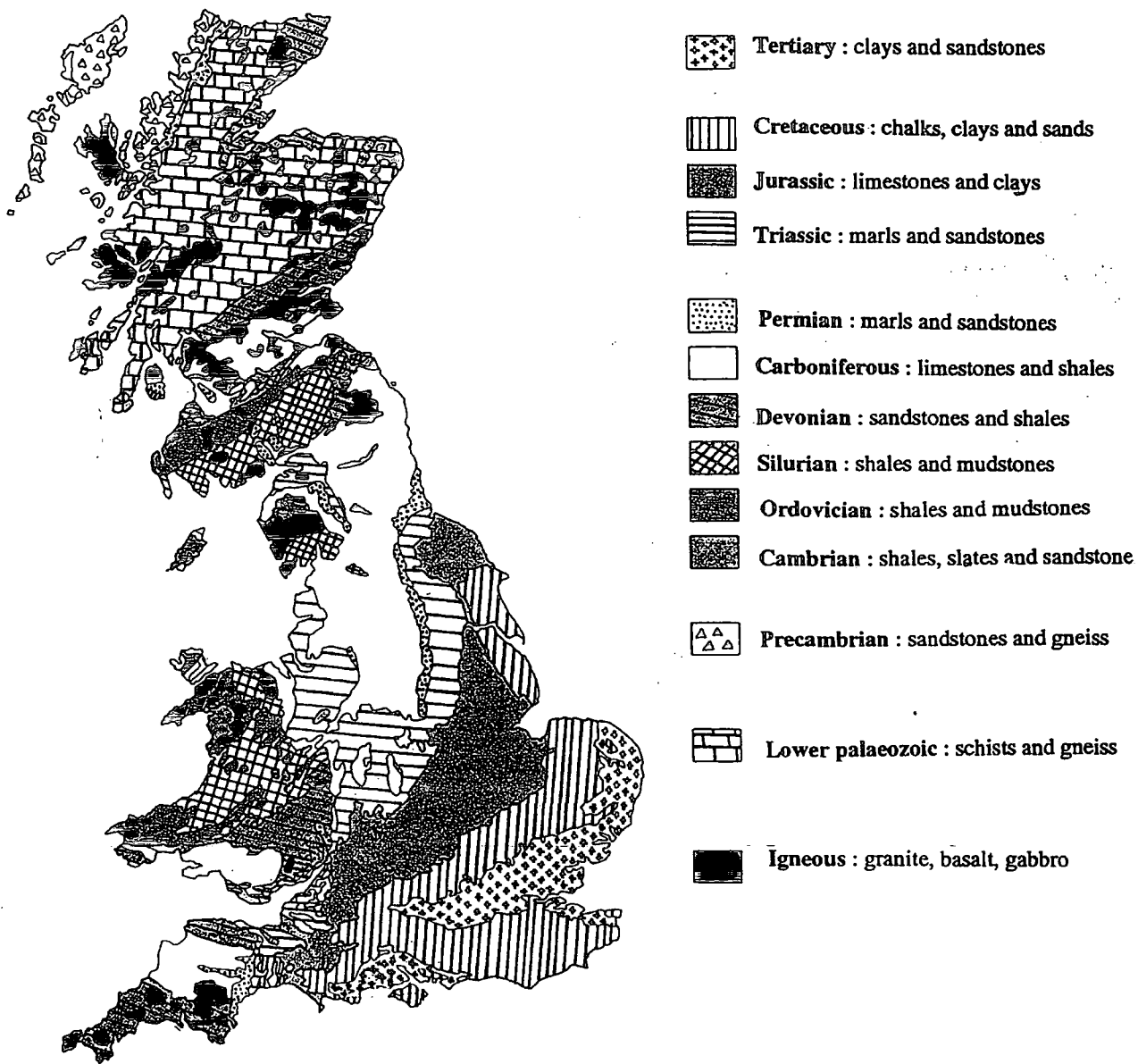

Fig. 3.2. Geology associated with the growing sites.

3.2. Proliminary experimental work

The first series of experiments were carried out to determine whether seeds from selected sites in Britain did in fact show differing proportions of the chosen six elements (copper, iron, manganese, zinc, calcium and magnesium - see 3.7.).

Nine sites were selected because of the diversity of their geography and local geology, being Boston, Castellau, Glasgow, Oxford, Norwich, Romsey, Truro, York, and Wirral. The local environment of different base rocks, together with factors such as weathering and erosion, obviously produces varying soil types, which would hopefully be reflected in the elemental uptake of plants grown.

Ears of spelt wheat were selected from plants grown at each site and grains extracted following removal of the glumes and paleae with plastic forceps; these were previously washed in 4% HNO₃ to ensure minimal risk of contamination. The grains were then placed in glass petri dishes and dried to constant weight in ovens at 105°C. Fresh grains contain a varying percentage of water, and whilst most (small) botanical material reaches constant weight after 24 hours in a hot oven this was not found to be the case with spelt as the seed coat offers protection against dessication. Individual grains did reach constant weight after 24 hours; after 48 hours no grains lost further weight and all samples were therefore placed at temperature for at least 48 hours. A longer period of drying did not affect results, but a shorter period might have given apparently lower concentrations of elements due to a "higher" sample weight.

Once at constant weight material for analysis has to be broken down to release the elements. Destruction of matter by dry ashing (burning in a furnace) leads to decreased levels of copper, iron and

zinc (Baker and Smith, 1974) and the grains were therefore denatured in an acid digest (or wet ashing) procedure. With biological samples this is conventionally done by heating the material in a mineral acid - nitric (HNO_3), hydrochloric (HCl), sulphuric (H_2SO_4), perchloric (HClO_4) and fluoric (HF) acids being commonly used. The acid dissolution of a matrix is a complex matter and it is obviously desirable that the chosen acid should efficiently decompose the sample and form soluble salts with the metal ions of interest. In addition to the decomposition of the sample it is obviously important that the acid cannot interact with the digestion container; for this reason HF cannot be used with glass or quartz. Other acids also present problems; H_2SO_4 has a very high boiling point of 339°C , and if digests reach this temperature most plastics melt, including Teflon PFA (Kingston and Jassie, 1988). HCl is not an oxidising agent and therefore rarely used for organic digests, the exceptions being for the analysis of amino acids and carbohydrates. Perchloric acid is a strong oxidising agent and extremely efficient at decomposing biological material; however it also has a high explosive risk and requires the use of specialised (and unavailable) fume cupboards, and was therefore not considered as a possible digestion agent.

HNO_3 is a strong oxidising agent and widely used for liberating trace elements from botanical samples. It is efficient at the destruction of organic material and decomposes all but a few organic molecules. Kingston and Jassie (1988) found trace quantities of nitro-aromatics after carbohydrate decomposition, as even high temperatures and pressures will not break the pi-bond of the benzene ring, but these did not affect inorganic analytical determinations by atomic absorption spectroscopy (AAS). HNO_3 has a

low boiling point of 120°C, and produces highly soluble nitrate salts, which do not cause interference like sulphate and phosphate ions produced in decompositions involving sulphuric and phosphoric acids. In addition, it is one of the few acids which can be obtained in ultra-high purity. For these reasons "Spectrosol" Atomic Absorption Grade Nitric Acid prepared by BDH Chemicals (Poole) was used for all acid digests and analytical work.

Various attempts were made to break up the grains into smaller pieces to increase the surface area for acid attack prior to placing them in acid. However, the small dessicated grains proved extremely hard and resisted mortar and pestle, and cutting by scalpel blade. Advice was sought and an agate rolling mill suggested, but as the risk of contamination was high and cleaning problematic, this was discounted. An alternative option would have been to cut up the grains before they were dessicated but this was seen as a further procedure where contamination could have occurred.

The grains were then placed in small (30ml) Kjeldahl flasks with 5ml 4M HNO₃ (diluted down from the 16M acid supplied by BDH using ultra-pure Milli-Q water), and heated on a boiling rack. From this stage on numerous problems were encountered. The thermostat was set to allow the samples to maintain a temperature of around 120°C (hence "simmering" close to the boiling point of the acid); unfortunately organic materials are prone to the phenomenon known as "frothing" in which sudden explosive boiling occurs. This causes possible loss of sample from the flask, together with the risk of cross-contamination from one vessel to another. It was not possible to seal a vessel and maintain release of gases (caps of foil or glass proved unsuccessful) so that many samples had to be discarded and the digests repeated.

A greater problem was the non-destruction of the grains. Colleagues working with algae and mosses were able to complete acid digestions in about thirty minutes, but the spelt proved more durable. Boiling the samples continuously eventually led to loss of liquid volume, and "topping-up" the flasks meant that the final molarity of the solution was unknown, making the preparation of acid-matched standards for analysis difficult.

After boiling for in excess of eight hours the grains had partly broken down, but the remaining solution was rich in sediment and obviously unsuitable for analysis by AAS. Centrifuging the samples was unsuccessful; the particles were apparently composed of a lighter and a heavier fraction, the former of which would not settle to the bottom of the tube and remained in suspension. In the hope of breaking up the particles to make them all of an equal size which could be spun down sonication was tried, but this again was unsuccessful. One method of obtaining a more complete digest would have been to use a more concentrated acid, as was proved when test digests were performed using 8M HNO₃. However, this caused further problems; if samples are more concentrated than 1M then the acid strips elements from the metal of the nebuliser and burner head unit of the atomic absorption machine causing contamination and false readings. Obviously samples can be diluted but this means that elements such as copper, which are only present in very small quantities, will be much reduced and may fall below detection levels.

Filtration of the samples proved very time consuming and inherently problematic. Cellulose paper was in a short time destroyed by the action of the acid (frequently before the filtration was complete), and whilst glass fibre discs did not

break down, zinc was leached from them causing contamination. Acid digestion of the glass fibre filters proved the leaching but also showed that the amount of zinc released was not constant, and therefore could not give a standard value for correction of analyses, thus making the filters completely unsuitable.

Eventually a set of sample solutions were obtained for analysis but these contained many particles which caused frequent blockages of the tube leading to the nebuliser head in the AAS machine. In addition, because the digest of the grains was incomplete large organic molecules (predominantly starches) remained in solution and were not broken down. When the solution was nebulised into the flame these were deposited on the burner head producing a wonderful aroma of baking bread but, more seriously, blocking the flame and causing erroneous readings leading to extremely frequent and time consuming changes of the burner head.

The results given in the AAS were used to calculate the total amount of metal extracted from each sample, but because sample weights necessarily varied the values used in drawing the graphs are mean concentrations of each element per gram of dry weight ($\mu\text{g g}^{-1}$) calculated from the five replicates. This allows true comparisons between sites.

As expected from previous work involving cereal grains and micronutrient elements copper and manganese were present in the smallest quantities (see Fig. 3.3.). Concentration values for copper range from 4.5-9.2 $\mu\text{g g}^{-1}$, whilst those for manganese show a much wider range from 9.6-32.0 $\mu\text{g g}^{-1}$.

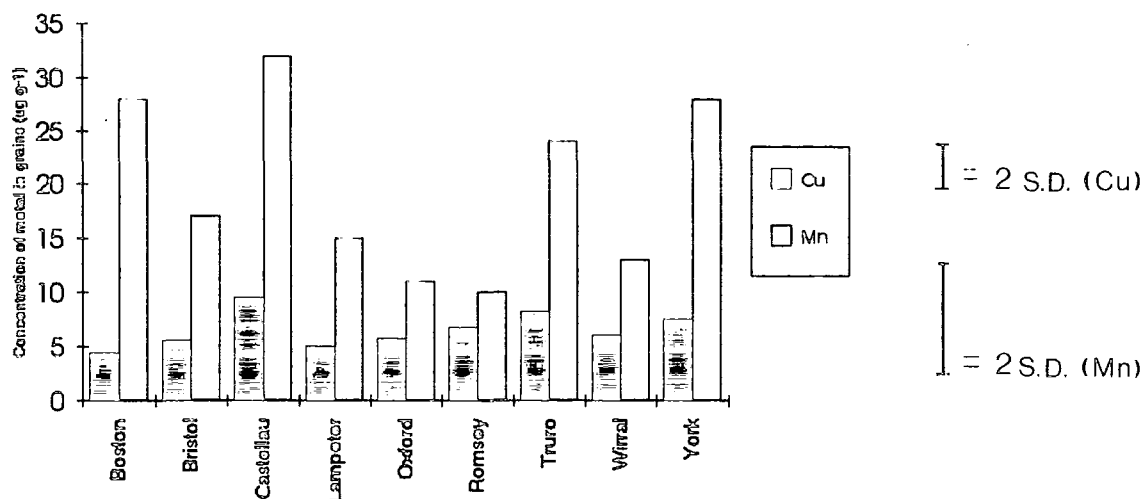

Fig. 3.3. Mean concentrations of copper and manganese obtained from the original digests.

Iron and zinc were present in moderate amounts (see Fig. 3.4.) with the latter element showing a much wider range of concentration values (30-124 $\mu\text{g g}^{-1}$) than iron (30-45 $\mu\text{g g}^{-1}$). Unfortunately the excellent zinc extraction shown in the Castellau sample was never equalled again and must be assumed to be due to contamination at some stage.

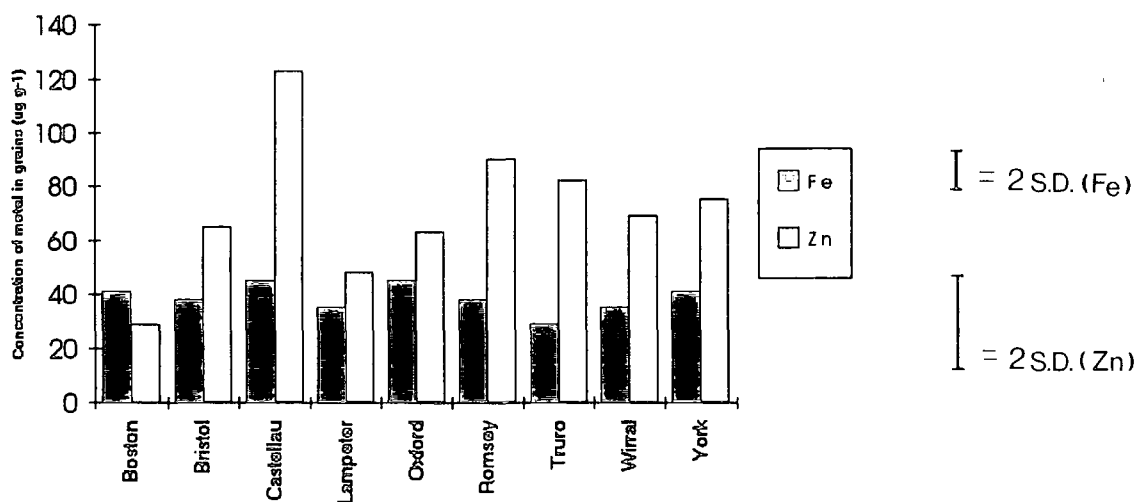

Fig. 3.4. Mean concentrations of iron and zinc obtained from the original digests.

The macronutrient elements calcium and magnesium were present in much larger amounts (see Fig. 3.5.). In all cases, except Boston, the ratio of calcium to magnesium concentrations was approximately 1 : 3-4. In view of the uniformly smaller amounts of calcium found in other samples the very large value from the Boston samples must again be considered potentially incorrect and due to contamination.

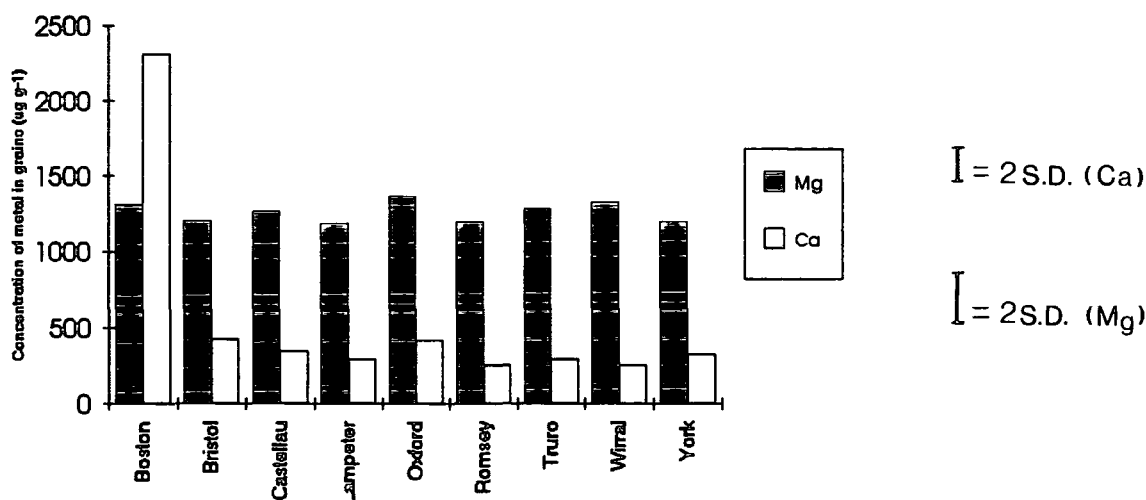

Fig. 3.5. Mean concentrations of magnesium and calcium obtained from original digests.

Whilst the results from the AAS of these initial decompositions could not be regarded as resulting from well controlled and comparable digests, they did suggest that differences in the elemental suites were present in grain samples from different areas, and that it would be worthwhile developing an improved technique in order to obtain more accurate values.

3.3. Development of the microwave technique

The aims of the acid digest were now to obtain a complete decomposition of the sample at a molarity of not greater than 1, resulting in a clear solution suitable for analysis by AAS. Following discussion with biochemical research workers it was subsequently decided that a closed vessel microwave digestion technique might prove successful. Microwave energy provides rapid heating ability and closed vessels mean that higher temperatures and pressures can be attained giving faster reaction rates.

The use of microwave energy as a heat source in wet ashing procedures was first demonstrated in 1975 (Abu-Samra et al.), but it did not become a commonly used technique until the mid-1980's when research had developed the closed digestion vessel. This resolved the problems of open unsealed vessels which allowed the risk of environmental contamination, mechanical or volatile loss of material, and also restricted the maximum temperature to the boiling point of the acid. Various scientific apparatus companies (including CEM and Floyd in the USA, and MLS in Germany) developed specialised microwave digestors with numerous advantages over the previously used domestic models which much improved efficiency, technique and safety, and allowed the reproducible, controlled and uniform application of microwave power.

"Microwaves" are electromagnetic energy in the form of a non-ionising radiation that causes molecular motion by migration of ions and rotation of dipoles, but does not cause changes in molecular structure. The frequency range of microwave energy is from 300-300,000MHz (falling between infra-red and radiowaves); four frequencies are used for industrial and scientific heating of which

2450MHz is the most commonly used, microwaves of this frequency having a wavelength of about 120mm (Neas and Collins, 1988).

Like all forms of electromagnetic radiation, microwaves consist of oscillating electric and magnetic fields at right angles to each other. It is the oscillating electric field that causes liquids exposed to microwave energy to heat, by either of two mechanisms - dipole rotation or ionic conduction. Polar molecules tend to align their dipole moments with the microwave electric field; because the field is changing constantly the molecules are rotated back and forth, causing them to collide with nearby molecules and generate heat. At 2450MHz the alignment of molecules followed by their return to disorder occurs 4.9×10^9 times per second (Neas and Collins, 1988) resulting in very rapid heating. Ionic conduction is the conductive migration of dissolved ions in an applied electromagnetic field; the migration causes ions to collide with other molecules, again generating heat. The two mechanisms occur simultaneously generating approximately five billion molecular collisions every second (Lautenschlager, 1989), and contribute varying amounts to the overall rate of liquid heating. An ionic sample heated by microwave energy will initially be dominated by dipole rotation, but as the temperature increases ionic conduction plays a greater part.

3.4. Microwave digestion of fresh grains

One of the main benefits of the microwave technique is that it reduces sample dissolution times due to a better heating method. Vessels used in conductive heating processes (involving hot plates etc.) are generally poor conductors of heat, and it takes time to heat the vessel and then transfer that heat to the solution. Because

vaporisation at the surface of the liquid occurs, a thermal gradient is also set up by convection currents, and therefore only a small portion of the fluid is at the temperature of the heat applied to the outside of the vessel. Microwaves heat all the sample fluid simultaneously without heating the vessel, and boiling point is reached very rapidly. Because the rate of heating is so fast localised superheating frequently occurs.

The development of closed vessel digestion for acid dissolutions has many advantages. Higher temperatures can be achieved because the boiling point of the acid is raised by the pressure produced inside the vessel; higher temperatures increase reaction rates and decrease digestion times. Because no evaporation occurs from a closed vessel the acid volume is not reduced and the molarity remains constant (making acid matching of standard solutions for analysis relatively simple).

As high internal pressures are produced during heating double walled vessels have been developed with an inert lining and an outer case able to withstand pressure without shattering or deforming. CEM Lined Digestion Vessels were used for all decompositions; these are transparent to microwave energy so allowing liquid samples to absorb the maximum amount of incident microwave energy. The liner, cover and rupture membrane (see Fig. 3.6.) are constructed of Teflon PFA, whilst the vent screw is of polytetrafluoroethylene (PTFE). Teflon PFA is inert to almost all industrial chemicals and solvents due to three characteristics of the Teflon molecule: (1) the very strong interatomic bonds between carbon and fluorine atoms; (2) the almost perfect shielding of the carbon backbone of the polymer by fluorine atoms; and (3) the very high molecular weight and long polymer chain length compared to other polymers (CEM, 1989). The

melting point is just above 300°C, and the PFA polymer is used (as opposed to PTFE) due to its high mechanical strength; it is able to retain acceptable mechanical properties up to 260°C (which is the melting point of PTFE).

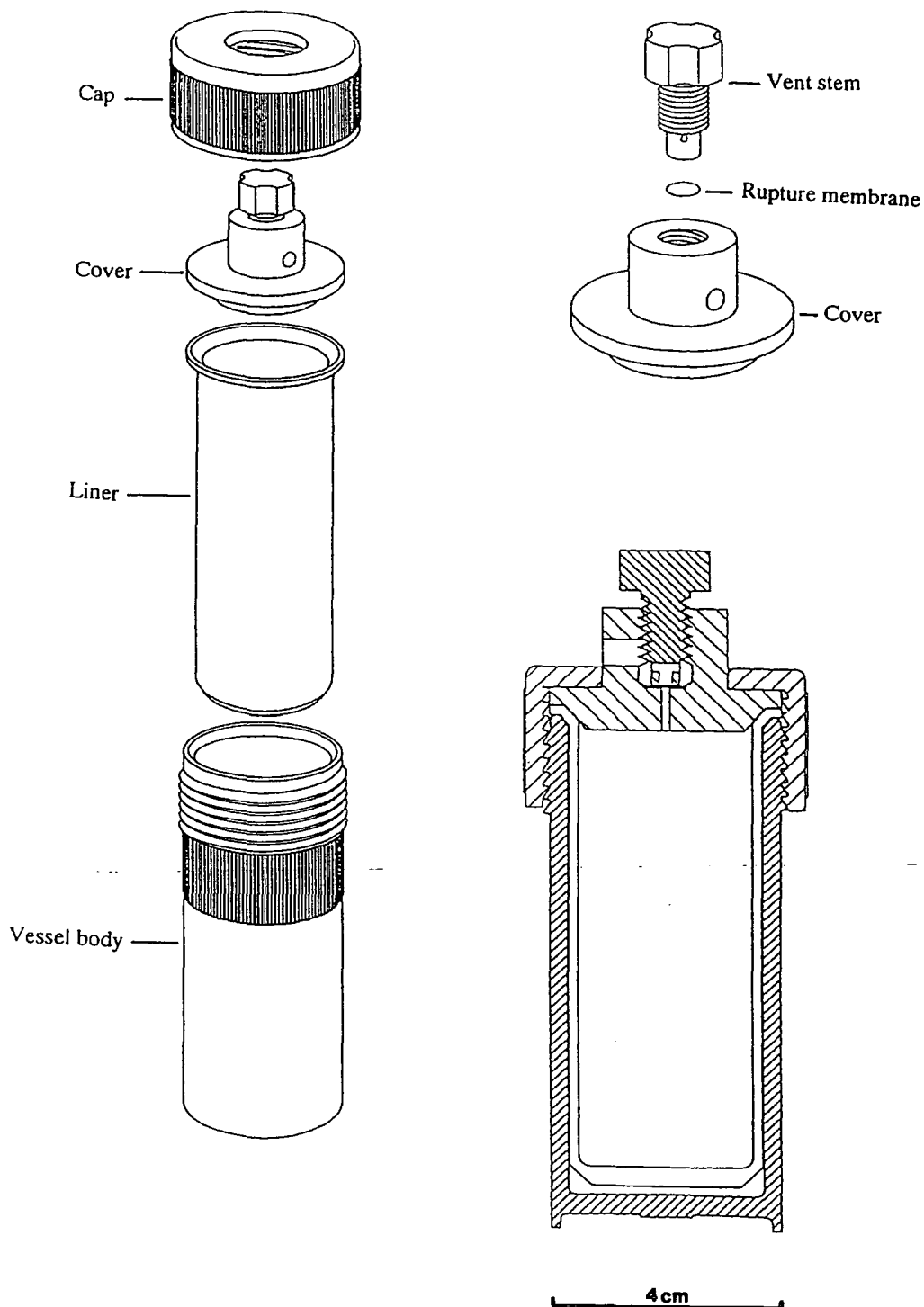

Fig. 3.6. Components of the CEM lined digestion vessels.

All plastics, including PFA, are particularly prone to a phenomenon called "creep", meaning they deform when low force is applied to them. Mechanical properties of a plastic, such as stiffness, tensile strength and creep resistance are influenced by the degree of crystallinity present in the material, and to increase this the PFA liners are extensively annealed by heat treatment, making them about 80% crystalline. This develops strength and ensures that the relief valves open reproducibly at the upper pressure limit of the vessel (200psi/1379KPa). Temperature and pressure can cause mechanical damage in vessel dimensions, including the vessel threads and sealing surfaces, and to protect against this the liner is fully enclosed by the outer body and cap. These are made of "Ultem" polyetherimide, a high strength thermoplastic. Although the Teflon PFA is chemically unreactive the risk of cross-contamination between samples was eliminated by soaking the liners in 4% HNO₃ for at least twelve hours between digestion procedures, followed by prolonged rinsing in Milli-Q water and drying in a warm oven. This washing and rinsing procedure was followed for all glassware and equipment used in digestion of samples and preparation of aliquots and standard solutions for AAS. The vessel body and cap never come into contact with the sample solution and only required cleaning after material blew through the vent stems in early uncontrolled experiments.

Organic samples prove something of a challenge to decompose efficiently; many require high temperatures for a complete digest, and copious amounts of gaseous by-products are given off during an acid decomposition which raises safety problems. When organic samples and a powerful oxidising agent are sealed in vessels and microwave heated the pressure developed can rise with dramatic

suddenness. Reactions become exothermic above a certain temperature, ranging from 140-160°C for HNO₃, and at, or above, that temperature the pressure rises almost instantaneously. For reasons of safety it was considered essential to be able to monitor and control pressure increases and therefore the CEM microwave digester, Model MDS-81D (CEM Corporation, Matthews, North Carolina) was used with a pressure controller. This device monitors the pressure developed in the digestion vessel and compares it with an upper limit previously selected by the user. If the pressure in the vessel exceeds the user selected value the pressure controller regulates the magnetron by switching it on and off at a rate which maintains the pressure at the set value (plus or minus 1psi/7KPa). This works in theory but if high power is applied to organic samples the heat and pressure generated may continue to increase after the magnetron has switched off, reaching unacceptable and dangerous levels. Initial experiments using high power caused two vessels to burst and therefore a slow increase of power chosen for the final digestion programs.

It was also discovered that organic samples had to be small, and certainly no larger than 0.5g, or the proportions of organic material to acid volume became unsafe, causing uncontrolled reactions in which excessive amounts of CO₂ and NO₂ were produced. This was unfortunate as it had been hoped to use higher sample weights to increase the concentration of copper, and possibly bring molybdenum within detection range. However, the risk of damage to machine and vessels necessitated that discretion be the better part of experimental procedure, and safer, smaller weights were used.

In most analytical acid digestions the small sample size is generally advantageous, less mass taking less time to decompose. However, small samples absorb less microwave energy, and the

reflected unabsorbed energy can cause damage to the magnetron producing the power. The magnetron is an electron tube surrounded by permanent magnets, and excess energy is reflected back on to it causing it to heat up, reducing the field strength of the permanent magnets and shifting the resonant frequency of the magnetron, which is then unable to deliver as much power. The output can drop by 10-15% (Gilman and Engelhart, 1989) causing less effective heating. This problem is overcome in the MDS-81D by using an isolator which only allows the microwaves to pass in one direction, any microwaves reflected out of the cavity being deflected onto a fan-cooled solid capable of absorbing the energy.

For reasons stated previously (3.2.) HNO_3 was again used for the acid dissolution of the organic matrix. By using sealed vessels and microwave heating elevated temperatures are gained under pressure and HNO_3 reaches 176°C at approximately 65psi/448KPa, which is above the atmospheric boiling point. Higher temperatures cause a substantial increase in oxidation potential and so the reaction proceeds more rapidly. CO_2 and NO_2 are the gaseous products of the breakdown of carbohydrates and other organic molecules, but pressure can be safely released at the end of the digestion procedure. Whilst perchloric acid is extremely efficient at decomposing organics, it cannot be used in a closed vessel; at temperatures approaching 240°C pressure rapidly increases with no increase in temperature and on cooling the vessel remains pressurised as the reaction with this acid is irreversible.

As mentioned earlier organics are prone to sudden explosive boiling causing possible contamination and sample loss. After discussion with biology department staff, and initial trial experiments, it was found that the risk of this occurring was

considerably lessened by a period of "pre-digestion" and grains which had not undergone this treatment showed much more rapid and uneven gains in pressure when microwaved. Grains dried to constant weight were placed in 30ml Kjeldahl flasks with 5ml 4M HNO₃ for initial breakdown of the seed. After ten days it was observed that all the grains had swollen up and burst, and so all samples were allowed to pre-digest for this length of time. Leaving the grains for longer did not alter the eventual analysis values, but for as far as possible all samples had a pre-digest period of ten to twelve days to ensure comparable conditions.

The pre-digested grain and acid were placed in the Teflon liner together with a further 2.5ml 4M HNO₃ and 25ml of Milli-Q water. By addition of the water the acid was diluted down to 0.92M. This was strong enough to complete the digest but still below 1M strength and therefore not concentrated enough to liberate contaminating ions from the AAS machine. Digests using only the addition of 25ml water to the pre-digest gave a final molarity of 0.6M and this gave an incomplete digest of the sample material (at the temperatures and pressures which were used).

In approximately 50% of the digests small amounts of sediment settled out to the bottom of the vessel after microwaving. By having a total digest volume of 32.5ml it was easy to remove a 25ml aliquot (which was immediately ready for analysis without further filtration or dilution) leaving any extraneous material in the remaining 7.5ml. Analysis of a secondary digestion of the sediment showed that the chosen elements were below detection level and no trace could be obtained for them on the chart recorder of the AAS machine. It was therefore considered that the primary digest was a

complete and efficient method of releasing metal ions into solution.

As noted earlier in this section a pressure monitor was used in all digestions to control the possibly dangerous increases in pressure encountered in the decomposition of biological materials. Using the CEM system only one vessel in each load of twelve samples can be monitored, and this should be representative of all. Sample weights were as near to 0.5g as possible but since grains had to remain whole the weights did vary slightly. Since a larger weight represented more organic material it was thought safest to monitor the pressure of the heaviest sample in the load, and use its rate of reaction to control the others. Theoretically the vessels are made to withstand an internal pressure of 200psi/1379KPa, but following discussions with the manufacturers it became clear that constant and long-term usage at this pressure led to considerable shortening of life. Since it was financially not feasible to obtain further sets of vessels it was decided that the digestion procedures should use lower pressures, even if this meant an increase in digest time. The initial test digests proved that a maximum internal pressure of 80psi/552KPa, increasing over the first forty minutes and being held for at least twenty minutes provided good destruction of material and release of ions. Longer digestion times of up to two hours, and at higher pressures of up to 120psi/827KPa did not increase the yield of those elements analysed. The pressure controller was therefore set to a maximum of 80psi, and the microwave digester programmed for three periods of twenty minutes each of continually increasing power; initially 40% (280W), increasing to 50% (350W) and finally 60% (420W). The sealed vessel always registered an initial pressure of 3-4psi/21-28KPa which rose slowly to 19-23psi/131-159KPa

in the first twenty minutes (see Fig. 3.6.). Once power was increased to 50% the pressure rose more rapidly reaching 80psi after approximately a further ten minutes, at which stage the pressure control monitor prevented further increase.

The assumption is made that all the vessels on the turntable have a similar reaction rate, and obtain similar pressures to the control vessel. It is theoretically possible that some smaller weight samples did not attain the maximum pressure, the amount of organic material decomposing proving too small to generate sufficient gaseous reaction products to attain 80psi. However since all samples were broadly similar in weight (the difference between lightest and heaviest being less than 0.09g), and none appeared to be under-digested or give dissimilar readings on analysis it was assumed the digests were comparable.

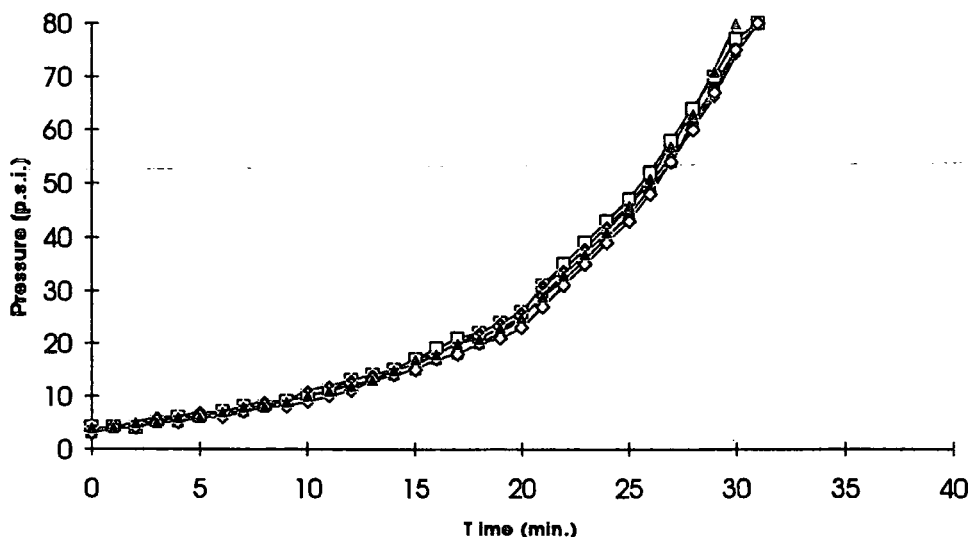

Fig. 3.7. Graph showing pressure increases to the maximum 80psi in the microwave decomposition of a series of fresh grain digests.

Whilst all digests proved remarkably similar in their behaviour, (as can be seen from the Fig. 3.7.), not all samples reached 80psi at the same time, variations of 2.5 mins. being present. To make digests exact replicates of each other it may have been more comparable to allow samples to attain full pressure and then be given a further set time period at 80psi. However, this would have meant re-programming the machine in the middle of digestion, and would have led to varying total times. It was therefore decided to allow a total digest time of sixty minutes, of which at least twenty-eight minutes were at maximum pressure for all samples.

When the digestion procedure was complete the vessels were left in the digester, with the power off, to allow cooling down and return to low pressure. Reduction in pressure took a considerable period of time and had generally only fallen to about 50psi/345KPa after one hour. At this stage the eleven vessels not being monitored were cool enough to handle and were transferred to a fume cupboard to allow further cooling. The control vessel was left in the digester until the pressure had further reduced to around 35psi/241KPa when it was possible to safely loosen the ferrule around the pressure sensing line and vent the reaction gases. If this was attempted whilst the pressure was still high the sudden release of gases and subsequent drop in pressure caused rapid boiling and forced fluid up through the adaptor assembly. It was also possible manually to vent the other vessels at higher pressure with similar loss of fluid, and these were therefore allowed to cool completely before the vent stem was unscrewed. Noxious gases were safely removed in the fume cupboard, and in the case of the control vessel by the venting system of the digester. On opening the

vessels brown fumes were observed; these are associated with the digestion process involving HNO_3 . During digestion there is a sudden change in the solubility of NO_2 , influenced by the total pressure within the vessel. The increase in the solubility of NO_2 results in a decrease in its partial pressure above the sample in the closed vessel. When the sample container is opened the NO_2 slowly degasses, without effervescing, evolving the characteristic fumes of nitrogen dioxide, and the solution becomes a paler yellow at the same time.

All the vessels were then allowed to stand for twelve hours to enable settlement of any sediment before removal of 25ml aliquots by pipette. These were stored in 30ml acid-washed snap-cap universal bottles until required for analysis.

Once the microwave technique had been successfully developed, it was possible to digest samples from each of the twenty-two modern sites. Statistical advice from Dr. P. Altham (University of Cambridge) suggested a minimum of five replicates for each sample, and this number was used for all experimental work. Five replicates of fresh grain (dried to constant weight) from the chosen sites were each digested in a total volume of 32.5ml at 0.92M, following a pre-digestion period of ten to twelve days in 4M HNO_3 . The digestion programme lasted sixty minutes in total, being twenty minutes each at 40%, 50% and 60% power. The maximum pressure of 80psi was attained approximately halfway through the second period and maintained until the end of the third. After cooling and a return to low pressure 25ml aliquots of each sample were removed for analysis into small universal snap-cap bottles .

3.5. Digestion of charred grain

As the study of archaeological samples will (almost) inevitably involve working with charred material, it was obviously necessary to analyse charred modern grain to study what differences, if any, occurred in the elemental proportions due to burning. In order to look at this five replicates of grains from each site were again selected, dried to constant weight and weighed; each sample was as close to 0.5g as possible. Charring was done in a fume cupboard in a small porcelain crucible held over a bunsen burner (blue flame). Initially on heating copious amounts of gases were evolved, followed by combustion when these ignited; once the grains were burning the crucible was removed from the heat. The contents were then allowed to burn until the flames died down; the burning period lasted longer in some samples than others presumably because of different amounts of fats and oils in the grains. Whilst the samples all consisted of similar sized grains as far as possible, some sites did produce larger and fatter seeds which must have contained larger amounts of combustible material. When cool the grains were weighed again. Weight loss was very variable; all charred samples obviously weighed less than the fresh ones, but the percentage weight losses were not proportional, the heaviest fresh samples not necessarily being the heaviest after charring. It was expected that burning would cause the grains to explode like popcorn, but this did not happen and their shape remained basically unchanged. Subjection to a pre-digest in 4M HNO₃ caused no alteration in grain form, and following the microwave digestion the grain was still unchanged. Analysis of the samples obtained in the initial digests of charred material gave greatly reduced amounts of all the elements. To check whether this was a "true" result, or due

to an ineffective or incomplete digest (which was considered more likely) the grains were then crushed to give a uniform powder by a glass rod prior to digestion to see whether values were increased. The charred grains were placed in 30ml Kjeldahl flasks and crushed with a glass rod before addition of 5ml 4M HNO₃ for a pre-digest period of ten to twelve days. To ensure comparable results the charred samples were treated identically to the fresh, and given the same microwave digestion programme.

The charred grain samples behaved in a similar way to the fresh throughout the microwave digestion procedure (see Fig. 4.7.). During the first period of twenty minutes at 40% power the rise in pressure generated was almost identical; the rise to maximum pressure however was slightly less steep and was reached at about three-quarters of the way through the second period.

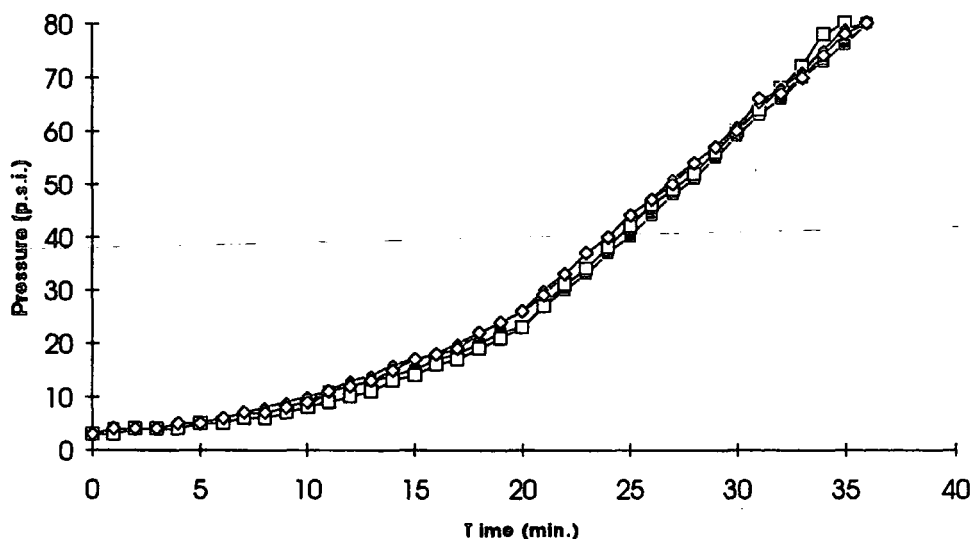

Fig. 3.8. Graph showing pressure increases to the maximum of 80psi in the microwave decomposition of a series of charred grain digests.

Presumably, burning the grains caused a reduction in the amount of organic material to be decomposed by the acid, and thus production of gaseous by-products was less. It was also noticed that return to low pressure took less time than for the fresh samples; charred samples showing a reduction to 40psi/276KPa in approximately thirty minutes.

Analysis of the crushed charred grains gave values which correlated closely to the results from the fresh grains. This suggests that digestion of the whole charred grain was incomplete, possibly due to organic compounds on the outer burnt surface shielding inner material from decomposition by the acid. All charred samples were therefore crushed to a uniform powder prior to the pre-digestion.

In all cases a black sediment was left in the bottom of the vessels and an orange solution obtained for analysis; solutions from the fresh grain digests being pale yellow. Analysis of the solution obtained from a secondary digest of the sediment again proved all the elements examined to be below detection level.

To guard against possible contamination acid blanks of each batch of 4M HNO₃ used in the experimental work were "digested" using the same method as for the grain samples (barring the pre-digest period). Acid dilution from 16M to 4M was done in 250ml batches using acid washed glassware and Milli-Q water. Analysis of acid blanks showed all elements to be below detection level in all cases.

3.6. Problems encountered using the microwave digestion technique

Although theoretically this method should have worked perfectly problems did occur, but these were associated with mechanical failure rather than chemistry. The alternating turntable

in the microwave digester is designed to rotate at 6rpm through 360° to allow uniform heating of the contents of each vessel, and to ensure that the tube linking the pressure monitor to the control vessel does not twist. Unfortunately due to an idiosyncrasy in the turntable mechanism there were occasionally 720° turns, leading to the line kinking and catching on the vent caps of other vessels. This upset the balance of the turntable causing jolting, which in turn upset readings on the pressure monitor, but more seriously risked sudden depressurisation of a vessel through twisting of the vent cap. Examination of the turntable controls did not reveal a fault, and the only foolproof way of avoiding problems was to watch the turntable throughout the digestion procedure, stopping the machine and untwisting the tube when trouble occurred, which proved safe but exceptionally tedious.

Less easy to explain were the instances where samples were lost during the microwave digest. When the vessels were uncapped at the end of the digestion procedure it was sometimes discovered that the volume of one, and occasionally two, vessels was greatly reduced, causing the loss of about 6% of the total number of samples digested. The technical officer at CEM could offer no advice, and it was later decided that the loss must be due to rupture membrane failure. These membranes, made of Teflon PFA and fitted in the liner cover under the vent stem, are part of the safety pressure relief mechanism to protect the vessel. Theoretically they remain as a flat seal until the pressure reaches the safety limit of the vessel (200psi/1379KPa), at which time they distort allowing the venting of gases, resealing when the pressure drops to a safe level. In this way the closed vessel system is compromised only if pressure becomes

unsafe. If no relief mechanism is used the vessels will burst if pressure exceeds 250psi/1724KPa.

Using the digestion procedure described pressure should not have developed to a level of 200psi in any vessel, but in the event of this happening the membrane could have ruptured causing the sample in the vessel to boil violently upon relief of pressure so that some material was lost through the vent. Alternatively, the membrane could have distorted and then failed to reseal, allowing the gradual escape of the sample. The only other reason for loss would be that the liner covers were not seated properly allowing leakage around the edges, but given the design of the vessels this seems unlikely. Teflon PFA is a soft plastic which is easily damaged, and scratches on the liner lip and cover may create leaks but as no abrasives were ever used in cleaning this does not seem a likely cause. The losses were not restricted to any particular vessels and therefore could not have been the result of a manufacturing fault or cleaning damage. Whilst extremely annoying, the losses were not irremedial as further replicates could be prepared; had any samples been rare or in reduced supply there could have been major problems.

3.7. Choice of elements for analysis

Previous work by several authors suggested elements which might prove interesting to examine. Concentrations of the macronutrients calcium and magnesium have been investigated in cereals (plants and/or grains) by various researchers including Kleese et al. (1968), Rasmusson et al. (1971) and Lasztity (1989), and their results suggested these elements should be included in the current work. Of the micronutrients, copper, iron, manganese, zinc,

molybdenum and nickel were originally decided upon, but early analyses proved the latter two to be below detection limits by AAS, and the analytical work was therefore concentrated upon the remaining four. Again the usefulness of these elements in this project was suggested by previous investigations of cereals by Erdman and Moul (1982), McCord et al. (1984), Bjerre and Schierup (1985), Bolland and Baker (1988) and Fukuoka and Horino (1989).

In addition, it was found that several authors had investigated trace element concentrations in other botanical material (including flax, vegetables and fodder), and their results confirmed the choice of elements for the present research (Collins, 1989; Crush et al., 1989; Grant and Bailey, 1989; Mathur et al., 1989; and Vogel et al., 1989).

Iron, copper, manganese and zinc are all transition metals which may account for their importance in biological materials. They all have electronic structures with similar physical and chemical properties including variable oxidation states (except zinc), a metallic nature, the ability to form complexes, and catalytic activity; the individual properties are not necessarily unique to the transition metals but their collective behaviour is distinct.

All of the chosen elements form inorganic ions required as essential nutrients by green plants. Mengel and Kirkby (1978) class sixteen as being truly essential: carbon, hydrogen, oxygen, nitrogen, phosphorus, sulphur, potassium, calcium, magnesium, iron, manganese, copper, zinc, molybdenum, boron and chlorine. However, as Wild and Jones (1988) say, this may not be a complete list. Sodium, silicon and cobalt are essential to some, but not all, higher plants, and vanadium and bromine are required by some algae but do not meet the requirements of an essential mineral as defined by

Arnon and Stout in 1939 (whose definition is still followed today):

(a) Deficiency makes it impossible to complete the vegetative or reproductive stage of the plant life cycle.

(b) Deficiency is specific to the element in question and can only be prevented or corrected by supplying that element.

(c) The element is directly involved in the nutrition of the plant, either as a constituent of an essential metabolite, or as a requirement for the action of an essential enzyme system.

The functions of the nutrient ions are many and various, and include non-specific ionic cellular functions, such as maintenance of ionic balance and establishment of osmotic potentials in cell organelles, as well as involvement in specific enzyme systems. The nutrient elements function as activators , co-factors and regulators of enzymes, and as Mahler (1961) noted:-

"There probably does not exist a single enzyme catalysed reaction in which either substrate, product, enzyme or some combination within this triad is not influenced in a very direct and highly specific manner by the precise nature of the inorganic ions which surround or modify it".

The enzyme processes are governed in part by metal ions but the reactions are not in isolation - they are interdependent, influencing and influenced by others, forming a highly integrated system.

Each of the chosen six elements has specific functions which are briefly considered below.

Calcium:

There are a great variety of calcium dependent biochemical and physiological processes, and the element plays an important role in

plant growth and development having both extracellular and intracellular functions (Dieter and Marme, 1981; Marme, 1983). It is required for cell elongation and division, being involved in microtubule and cell plate formation during mitosis (Marcum et al., 1978; Auel et al., 1980). Pollen germination and growth are also dependent on calcium, lack of which causes inhibition of the pollen tube tip growth due to irregular incorporation of cell wall material (Herth, 1978; Reiss and Herth, 1979). In general plant development calcium is associated with auxin dependent growth, and deficiency causes failure of cell elongation (Griffing and Ray, 1979). It also plays an essential role in membrane stability and maintenance of selective permeability, and deficiency causes membranes to become leaky (Morre and Bracker, 1976).

In contrast with other cation species calcium plays a comparatively minor role in enzyme activation. It is thought it may inhibit the activating effect of magnesium by displacing that element from functional sites, whilst the protein calmodulin (which incorporates calcium) regulates the enzyme nicotinamide adenine dinucleotide (NAD) kinase (Dieter and Marme, 1980; 1981). The enzyme glutamate dehydrogenase, found mainly in mitochondria, is also dependent upon the presence of calcium ions for maximal activity (Joy, 1973; Nauen and Hartmann, 1980).

Magnesium:

Magnesium occurs as the central atom of the tetrapyrrole ring of the chlorophyll molecule and so is essential in photosynthesis. The structure of the chlorophyll molecule is similar to the haem-porphyrin ring binding iron, but magnesium cannot accept or donate electrons directly (as iron can), although it is capable of

electron emission if excited by light, as in the photosynthetic process.

Magnesium activates more enzymes than any other element and so is of paramount importance in energy metabolism. It functions as a co-factor in almost all enzymes activating the phosphorylation process by forming a bridge between the co-enzymes adenosine triphosphate (ATP) or adenosine diphosphate (ADP) and the enzyme protein. In some enzyme reactions magnesium ions can be substituted by manganese ions, but many are magnesium dependent and more have a higher affinity for, and will bind preferentially to, magnesium (Mengel and Kirkby, 1978). Magnesium is also a component of ribosomes and chromosomes, and therefore vital to cell life and function.

Iron:

The functions and effects of iron depend on changes in the oxidation state of the ion. It is supplied to the plant root as Fe(II), Fe(III) or in chelated form; the latter separates to Fe(II) and chelating molecule prior to absorption, and Fe(III) is reduced to Fe(II) at the root surface before uptake (Chaney et al., 1972). After absorption the Fe(II) is oxidised and translocated through the plant in ionic form as iron(III) citrate (Wild and Jones, 1988).

Functionally iron forms the central atom of the porphyrin haem molecule which acts as the prosthetic group of a number of enzymes including catalases, peroxidases and cytochromes. The iron in the haem group can change its valency from Fe(II) to Fe(III) enabling the transfer of electrons, the oxidised Fe(III) group being known as the haemin group (Fe(II) being the haem). The cytochromes (found in mitochondria and plastids), of which many forms have been isolated, contain different structural forms of the haem group and

are important in electron transport and respiration (Sandmann et al., 1982; Bohner et al., 1980).

Iron is also present as a ferric phospho-protein (phytoferritin) found in chloroplasts, where it acts as an iron reservoir (Barton, 1970). Another form of non-haem iron in chloroplasts is ferredoxin - a group of iron-sulphur compounds capable of electron transfer in oxido-reduction processes such as the photosynthetic reduction of nicotinamide adenine dinucleotide phosphate (NADP)(Boehme, 1979). The enzyme superoxide dismutase also contains an iron prosthetic group in one of its three forms (the other two forms contain manganese, or either copper or zinc). All are involved in catalyzing the conversion of the superoxide radical $CO_2^{\cdot -}$ to form hydrogen peroxide and oxygen.

Manganese:

Functionally manganese and magnesium ions are similar; both ion species are able to act as a bridge between ATP and the enzyme complex, and certain decarboxylases and dehydrogenases of the tricarboxylic acid (TCA) cycle are activated non-specifically by either ion. However, arginase, pyruvate carboxylase and phosphotransferase are manganese dependent. The element also brings about the oxidation of indole acetic acid (IAA) by activating IAA oxidases, probably by a valency change of Mn(III) to Mn(II) (Taylor et al., 1968). In addition manganese is also involved in the oxidation-reduction processes in the photosynthetic transport system associated with both oxygen evolution and electron donation (Bishop, 1971).

Zinc:

Functionally zinc ions resemble those of magnesium and manganese in bringing about the binding and conformation between

enzyme and substrate. The ions are able to substitute for one another, but zinc is specific to the activation of carbonic anhydrase, which catalyzes the reversible reaction of carbon dioxide with water (Jacobson et al., 1975). This enzyme is localised within chloroplasts and may act as a buffer in other reactions. It is also essential in alcohol dehydrogenase and superoxide dismutase in plants (Wild and Jones, 1988). Zinc is closely involved with nitrogen metabolism in the plant, and associated with the synthesis of ribose nucleic acid (RNA) being essential for both RNA and deoxyribosenucleic acid (DNA) nucleotidyltransferases. It is also required in the synthesis of tryptophane, a precursor of the growth substance IAA, and may be involved in starch formation (Mengel and Kirkby, 1978).

Copper:

Copper is highly concentrated in chloroplasts, being a constituent of the chloroplast protein plastocyanin which is involved in electron transport during photosynthesis. Several copper enzymes are known including cytochrome oxidase, ascorbic acid oxidase, laccase and polyphenol oxidase, all of which are involved in reactions reducing molecular oxygen.

Copper appears to participate in protein and carbohydrate metabolism and is involved in RNA and DNA synthesis (Mengel and Kirkby, 1978). It is also associated with the lignification of sclerenchyma and xylem elements, and thus in the regulation of water transport (Marschner, 1975). Allied to this is the fact that a low level of copper also depresses lignification of the endothecium causing failure in the rupture of the anther walls leading to pollen sterility (Dell, 1981).

3.8. Choice of AAS as an analytical tool

Atomic absorption spectroscopy was chosen as the method of analysis for various reasons, not least being its accessibility. The experimental work yielded large numbers of samples and it was thought important that these should be personally analysed as and when required, rather than involving a technique in a location outside Durham. This allowed control over preparation of samples and standards, and their actual passage through the machine, giving personal responsibility for accuracy, calibration and basic maintenance of parts, such as the burner head (which unless perfectly clean can give incorrect readings). The Machine used was a Perkin-Elmer 5000 atomic absorption spectrophotometer (Perkin-Elmer Corp., Connecticut, U.S.A.).

AAS is also a comparative method of analysis, comparing standards of known concentration with the test samples, resulting in related values rather than individual numbers which may mean little on their own. This means it is usually easier to spot when the machine is not functioning correctly; delays in noticing malfunctioning obviously result in loss of samples and wasted time.

The precision for each element measured does vary in AAS with zinc being the most precise due to the ease with which it can be nebulised into the flame. Of the other elements examined magnesium is the next most precise followed by copper, calcium, iron and manganese (in that order).

The preparation of standard solutions involved acid and matrix matching. These are important because matrix interference can cause suppression or enhancement of the analyte signal, and for accurate results sample and standard should be physically and chemically as similar as possible. Standards were made using a serial dilution

technique from SpectrosoL standard solutions (BDH Chemicals, Poole) which are supplied at a strength of 1000 mg l^{-1} . For analysis of grain samples prepared concentrations of the standards ranged from $10.0\text{-}0.05 \text{ mg l}^{-1}$ for the micronutrients (copper, iron, manganese and zinc), and from $50.0\text{-}0.25 \text{ mg l}^{-1}$ for the macronutrients (calcium and magnesium). All six elements were included in the same solution (for matrix matching), and the final molarity of each standard was adjusted to 0.9M using SpectrosoL atomic absorption grade nitric acid to provide acid matching. All solutions were diluted to correct volume using Milli-Q ultra-pure water to lower the risk of contamination. The same methods were followed to prepare standard solutions for soil analyses but stronger concentrations were necessary; the range for micronutrients was from $100.0\text{-}0.5 \text{ mg l}^{-1}$, and that for macronutrients from $250.0\text{-}1.25 \text{ mg l}^{-1}$. To check the accuracy of the serial dilutions the standard solutions for 5 and 0.5 mg l^{-1} were then passed through the AAS machine and the resultant peaks on the chart compared with those produced by solutions at 5 and 0.5 mg l^{-1} prepared independently by staff in the chemistry department.

Micronutrients in the grain samples were in low concentrations and an impact bead was used in the nebuliser section of the burner head; this improves the sensitivity and detection limits of the machine. For macronutrients in all samples, and higher concentrations of micronutrients in the soil samples, a flow spoiler was substituted as this minimises the interference from matrix components (Perkin-Elmer Manual, 1982). The burner angle was also altered as necessary to give the most accurate results; if high concentration solutions are nebulised into the flame the ions may be too dense for absorption to take place fully, and the reading is

therefore too low. For analyses of zinc, copper and manganese the burner was turned through 30° for concentrations of $20-100 \text{ mg l}^{-1}$, and through a further 30° (to 60°) for concentrations of zinc in excess of 100 mg l^{-1} . Analyses of magnesium required a burner angle of 30° between 5 and 20 mg l^{-1} , and 60° for concentrations of $20-100 \text{ mg l}^{-1}$, whilst calcium only needed the burner turned to 30° for levels in excess of 100 mg l^{-1} . For analyses of iron (under 100 mg l^{-1}) the burner could remain in the original position. All the elements analysed required a flame burning air and acetylene. The Perkin-Elmer manual suggests varying gas mixtures for different elements but analytical staff in the Chemistry Department have found that the machine gives more accurate results using a standard setting. The height of the burner head was adjusted for maximum efficiency at the beginning of each session, and individual lamps for each elements were set to their optimum energy levels prior to usage.

The analysis of calcium and magnesium requires the addition of special chemicals to samples and standards, and these two elements are often known as "preparation elements". Chemical interference occurs in the solution whereby the number of atoms in the flame capable of absorbing light is reduced; this can be overcome by adding a releasing agent or competing cation to the solution which then preferentially reacts with the interferent. For example, calcium and phosphate ions do not totally dissociate in the flame and as the phosphate concentration increases the absorbance of calcium decreases. If an excess of lanthanum ions are added these are able to tie up the phosphate and release the calcium, making calcium absorbance independent of the phosphate present. The most simple method of using lanthanum is by the addition of lanthanum

chloride solution giving a total concentration of 7% (i.e. 7.5ml of LaCl_3 is added to 100ml of standard solution, and 0.3ml to 4ml of sample). A solution of similar strength must also be made with Milli-Q water for calibration of the machine prior to analysis.

The results for copper, iron, manganese and zinc in the grain digests were printed out in the form of a peak height chart by a chart recorder to give a permanent record. For maximum accuracy standards were charted after every five replicates so that each separate set of samples was calibrated to a specific set of standards. Once the recording was finished the peak height of each standard and sample trace was measured and entered into a specifically designed programmed data sheet on "Microsoft Excel". By use of a regression equation this calculated the amount of element in each sample; mean values and standard error / standard deviation were also calculated. As noted previously to allow comparisons between sites the amounts of each element were converted into a concentration of the amount of element per gram of sample dry weight. A sample spreadsheet is given at Appendix 2.

Values for calcium and magnesium in the grain digests, and for all six elements in the soil digests were read numerically from the keyboard as a concentration figure relating to standard solutions, each individual sample value being an average of five readings for maximum accuracy. Calibration was by three standards, one being of greater concentration than the sample, one of lesser concentration, and one of approximately the same strength. These sample concentration values were converted to a weight of element per unit weight of grain ($\mu\text{g g}^{-1}$) by entering the relevent figures in a second specifically designed spreadsheet (see Appendix 3.).

Many researchers are now preferring to use inductively coupled plasma atomic emission spectroscopy (ICPAES) as an analytical tool as it is less susceptible to interference and has lower detection limits than AAS; additionally, a number of elements can be analysed at once. However, this method is not without problems; it is more expensive than AAS and the quality of results depends upon the experience of the operator. In simultaneous analysis there is also the problem of devising a sample decomposition which renders soluble a range of elements with diverse chemical properties. Thompson (1983) compared both methods and came to the conclusion that for copper, iron, manganese, zinc and magnesium both techniques gave similar results. ICPAES is marginally better for calcium, and it might have been interesting to pass the same sample through both machines to compare the magnitude of the difference. However, as calcium is a macronutrient in plants and present in relatively high amounts it was thought unnecessary at this stage.

3.9. Results

The results of analyses for copper, iron, manganese, zinc, magnesium and calcium in charred and fresh modern grains harvested from twenty two sites around Britain are shown below. Numerical values are listed at Appendix 4.

The values obtained for copper concentrations in the microwave digests are within the same range as those from the initial experiments (being from $3.6-8.3 \mu\text{g g}^{-1}$). The highest values were obtained in samples from Nickersons, Oakenshaw, Truro and West Stow (Fig. 3.9.). The land used by Nickersons (the agricultural plant research centre in Lincolnshire) is known to have been supplemented by fertilisers and this may explain the high copper value. Likewise,

the high concentration of copper in the sample from Truro doubtless relates to high natural levels within the area. There is also the possibility that the abnormally high values may be associated with the Cornish mining industry and therefore do not solely relate to the soil.

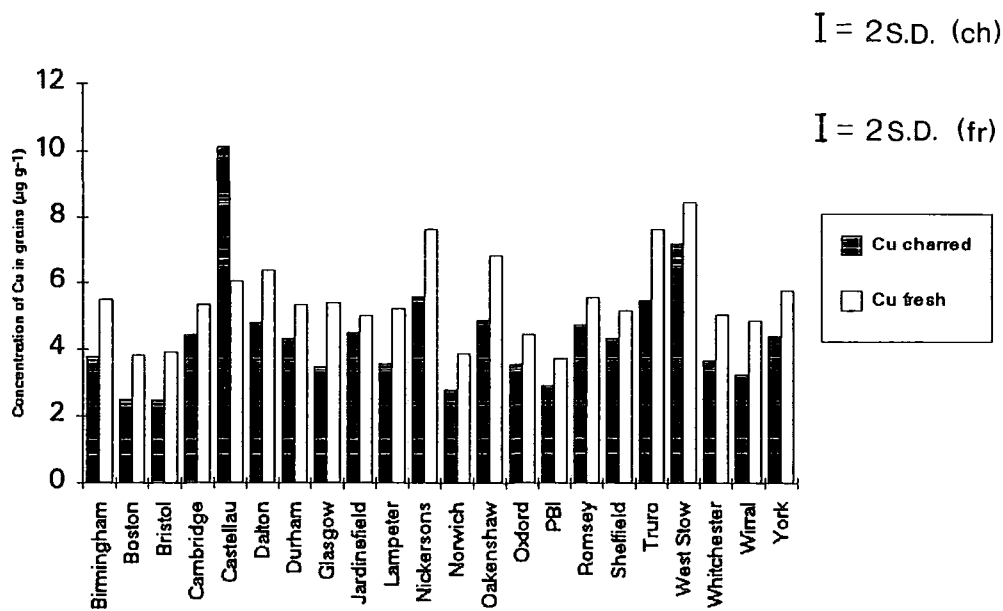

Fig 3.9. Mean concentrations of copper in fresh and charred samples of grain. Values are given in $\mu\text{g g}^{-1}$. (Error bars have not been drawn because they are sufficiently small to confuse the graph: for fresh grains the largest standard deviation is 0.35, and 0.36 for charred).

The most obvious point regarding the fresh and charred grains is that the latter always contain a lower concentration of the element than the fresh (the Castellau result in which the copper concentration in the charred grain is 50% higher must be regarded as resulting from contamination at some stage). This is clearly demonstrated if the concentrations of copper in fresh grains are plotted against those in charred grains (see Fig. 3.10.). If the

concentrations were the same (or very similar) in fresh and charred samples the points would all lie on, or close to, the line. As they all lie above the line this indicates that copper concentrations are greater in fresh samples. The single point below the line corresponds to the Castellau sample. Losses associated with charring are on average between 20-30%, which is a significant amount. The reduction in the copper value is presumably due to volatility of the element during burning. It is unlikely that charring creates a complex and indestructible molecule around the copper as this would be broken in the acid digest and the element liberated, thus maintaining the same values as in the fresh material.

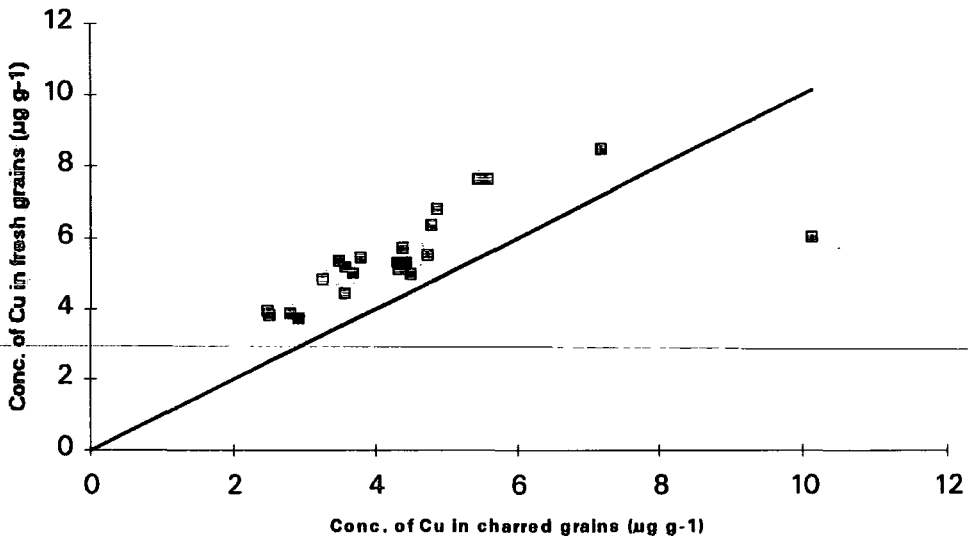

Fig. 3.10. The concentration of copper in fresh grains plotted against that of charred grains.

The range for concentrations of iron in the fresh and charred grains (22-59 µg g⁻¹) is again very similar to that obtained in the initial hot plate digests. The highest values are found in

samples from Oakenshaw, West Stow, Whitcheater, and in grain supplied by Nickersons (see Fig. 3.11.). High levels in the latter are possibly again associated with enhancement due to specific fertilisers and may not reflect the chemistry of the soil alone.

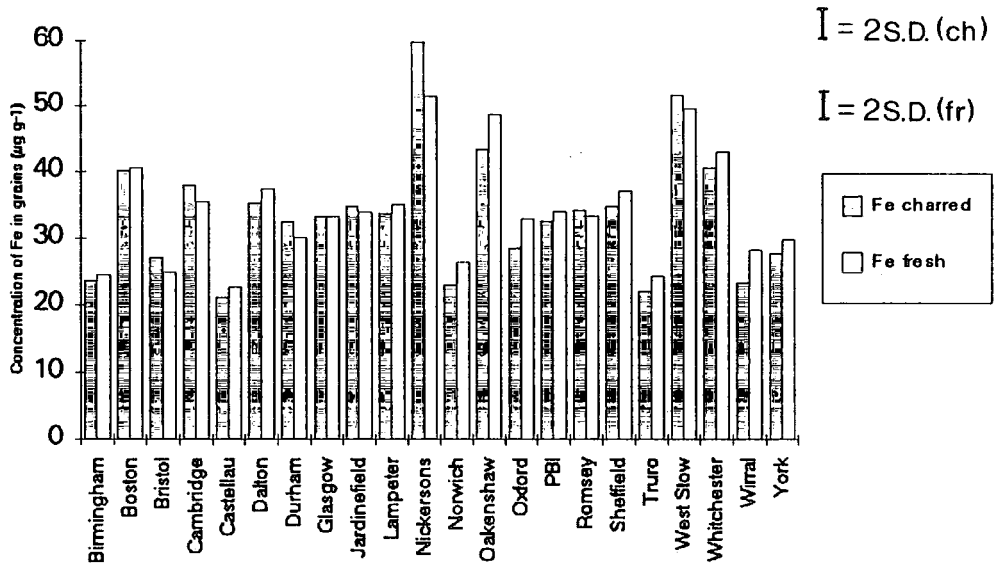

Fig.3.11. Mean concentration of iron in fresh and charred samples of grain. Values are in $\mu\text{g g}^{-1}$. (Error bars are again omitted as they create confusion; the highest standard deviation in the fresh material is 1.4, and in the charred 1.5).

There is no distinct pattern of fresh material always containing a higher or a lower concentration of iron; fifteen out of twenty-two samples do have higher values in the fresh material (see Fig. 3.12.), but the differences between fresh and charred are small and generally less than 5%, and all the points lie on or around the line (which represents equal concentrations in the charred and fresh material). It is not obvious why there is a difference in the results for fresh and charred grain, or why there is an increase in only some of the charred samples. Any increase is

suggestive of iron becoming more extractable due to burning but this is unlikely because it does not happen in every sample.

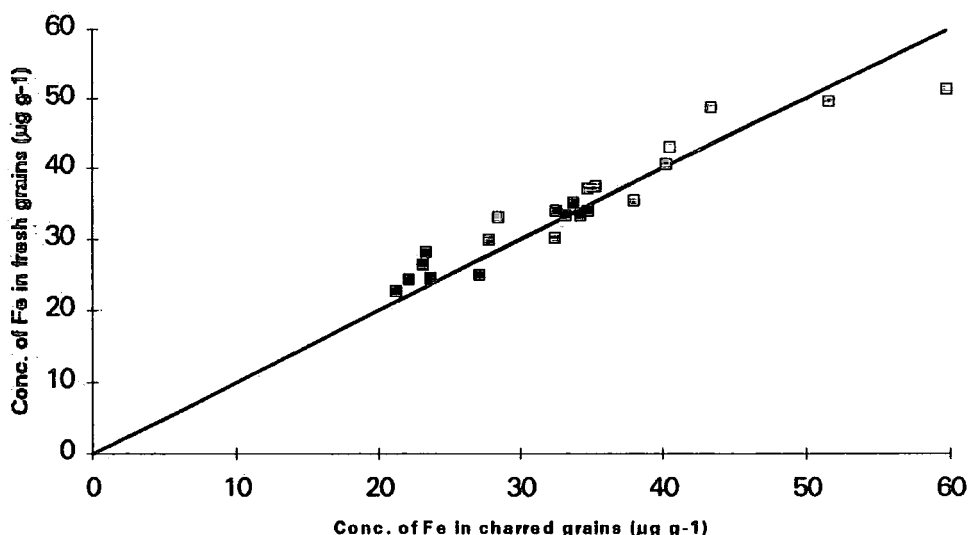

Fig. 3.12. The concentration of iron in fresh grains plotted against that of charred ones.

The values for concentrations of manganese in microwaved samples range from 11-47 $\mu\text{g g}^{-1}$. Whilst this is higher than that obtained in the initial digests, those samples giving very high values were not among those considered in the first experiments; those that were digested on the hot plate give similar values with the improved technique.

Samples from Oakenshaw and West Stow again give high concentration values, together with those from Boston and Cambridge (Fig. 3.13.). These results presumably give some indication of basic soil chemistry; the very high values in grain supplied by Nickersons and PBI must be viewed with suspicion as it is known both research stations used fertilisers in their growing plots.

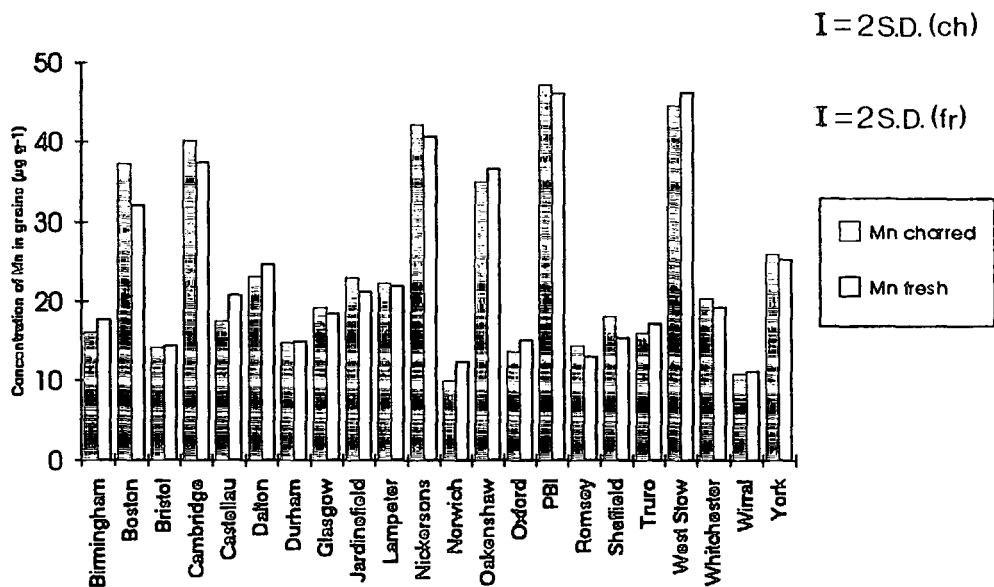

Fig. 3.13. Mean concentrations of manganese in fresh and charred grains. Values are in $\mu\text{g g}^{-1}$. (The highest standard deviations are 1.0 in fresh samples and 1.2 in the charred).

As with the iron results, no clear pattern emerges regarding higher or lower values in the manganese concentration in the fresh and charred grains; indeed, exactly half of the samples have higher values in the former group, and half in the latter. Plotting the fresh values against the charred (see Fig. 3.14.) shows the resultant points lying close to the line. Again, the reason for the differences remains unknown since the samples are not all affected in the same way.

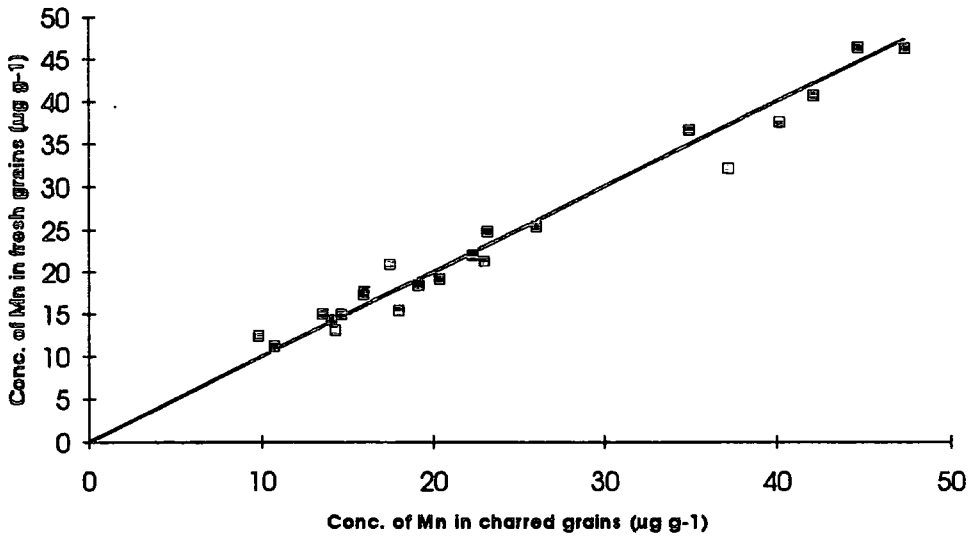

Fig. 3.14. The concentration of manganese in fresh grains plotted against that of charred ones.

The range of values for zinc concentrations in the microwaved samples (24-83 $\mu\text{g g}^{-1}$) is again similar to those obtained in the initial hot plate digests. Particularly high values were found in grain from Birmingham, Dalton, Glasgow and Romsey which are assumed to relate to the soil at those sites (see Fig. 3.15.). The moderately high value from Truro may be associated with mining pollution, as with the copper. The very low value in the PBI sample may be associated with fertilisers and land usage; high levels of other divalent ions are known to depress uptake of zinc which could account for this result.

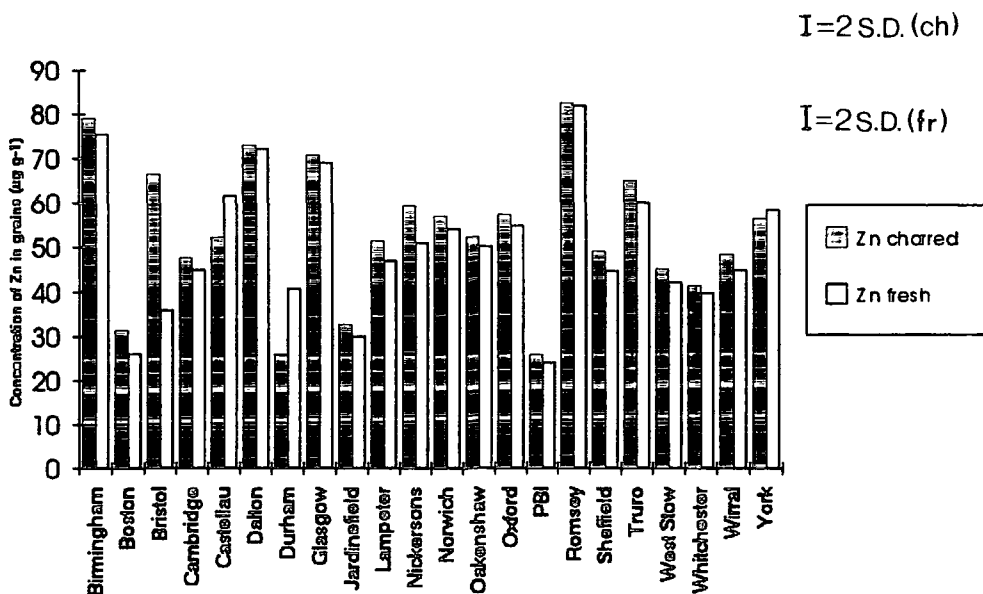

Fig. 3.15. Mean concentrations of zinc in fresh and charred grains. Values are in $\mu\text{g g}^{-1}$. (The highest standard deviations are 1.6 in the fresh material and 1.4 in the charred).

Of the twenty-two samples only three (Castellau, Durham and York) have higher zinc concentration values in the fresh grains and these results are indicated by those points above the line in Fig. 3.16. The very high concentration of zinc in the charred material from Bristol (seen as the point which is markedly below the line) is probably due to contamination at some stage, but it is probable that even in a pure sample the value would still have been higher than in the fresh grains.

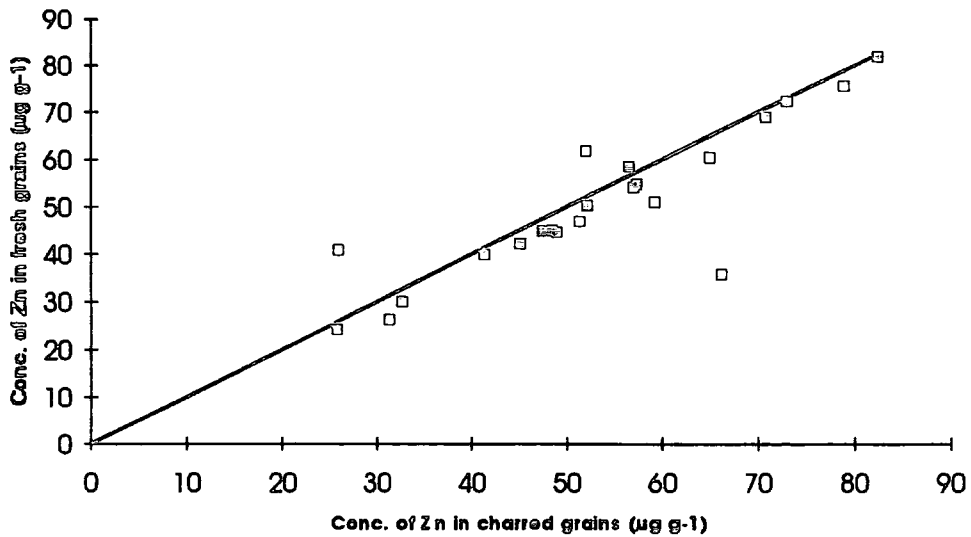

Fig. 3.16. The concentration of zinc in fresh grains plotted against that of charred ones.

Such a strong pattern of higher values in charred material does suggest that burning releases more zinc, or perhaps allows a greater level of extraction from the grain, although why this should be so is not obvious. Concentrated nitric acid is able to thoroughly decompose almost all material and it is difficult to envisage a structure which can be affected by burning but not by the action of acid.

The results for the macronutrient elements also show similarities with the initial hot plate digests (see Figs. 3.17 and 3.19.). Magnesium is again found at much greater concentrations in all samples ranging from 888-1450 $\mu\text{g g}^{-1}$, compared to the range for calcium of 215-498 $\mu\text{g g}^{-1}$. High values of one element do not appear to relate to high or low values of the other.

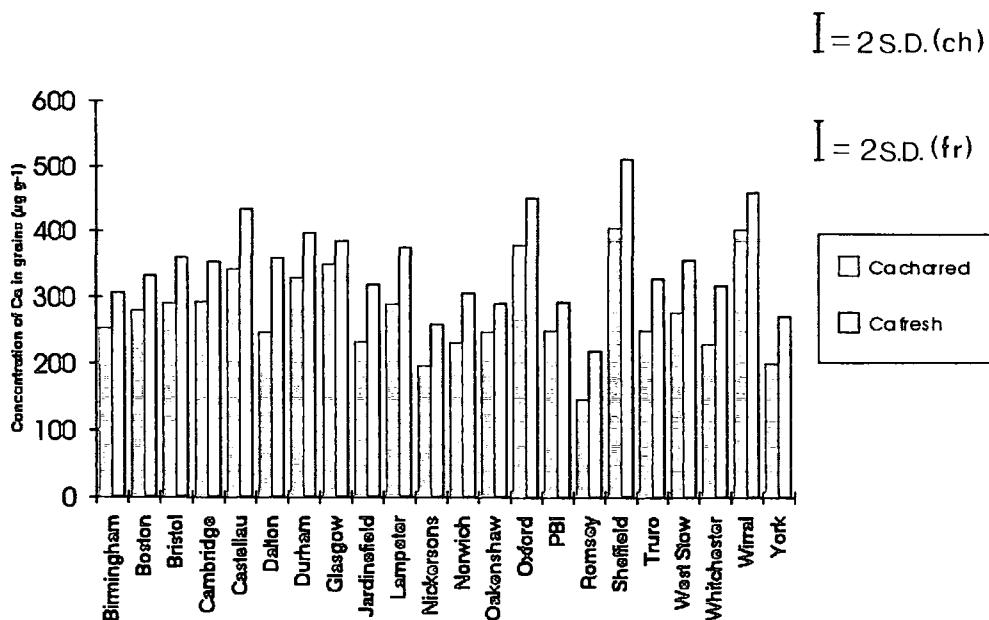

Fig. 3.17. Mean concentrations of calcium in fresh and charred grains. Values are in $\mu\text{g g}^{-1}$. (The highest standard deviation values are 21 in fresh grains and 24 in charred).

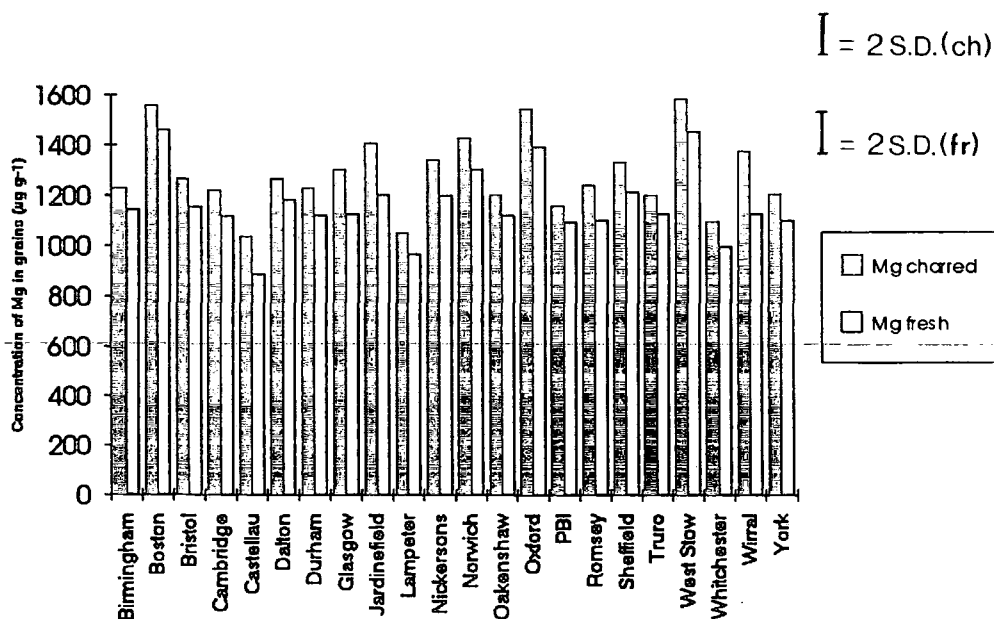

Fig. 3.18. Mean concentrations of magnesium in fresh and charred grains. Values are in $\mu\text{g g}^{-1}$. (The highest standard deviation values are 77 in fresh grains and 80 in charred).

Of interest is the fact that charred samples always contain a lower concentration of calcium but a higher concentration of magnesium (see Figs. 3.19. and 3.20.). As with copper, the calcium results suggest the element has a volatile fraction which is lost on burning. Conversely it would appear that the charring process releases more magnesium which can then be extracted.

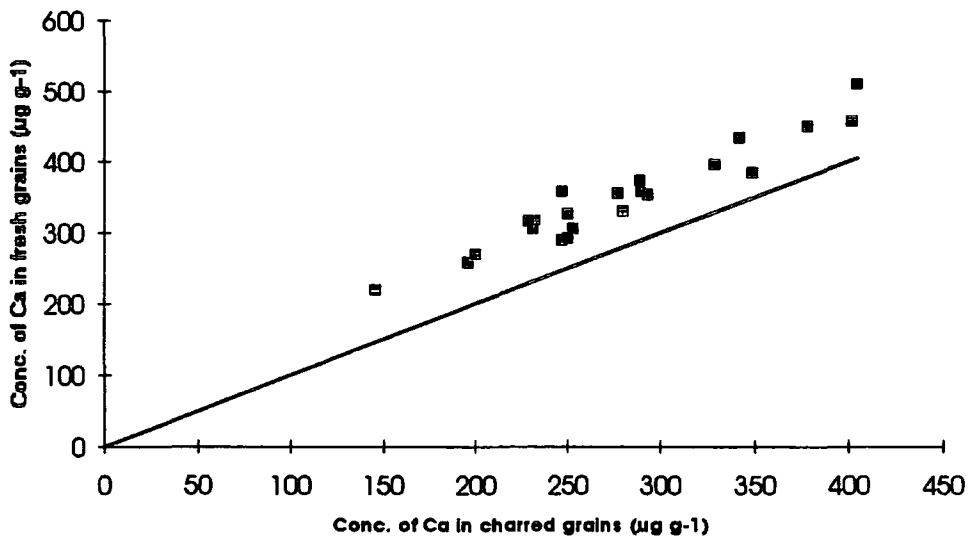

Fig. 3.19. The concentration of calcium in fresh grains plotted against that of charred ones.

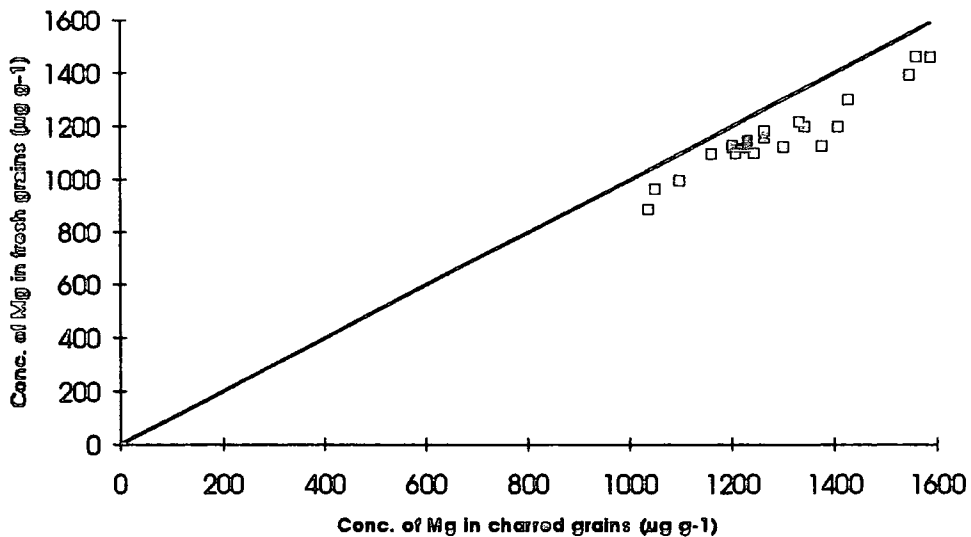

Fig. 3.20. The concentration of magnesium in fresh grains plotted against that of charred ones.

If the mean micronutrient concentrations in the fresh grain digests are viewed as a whole it is possible to draw a graph of the total concentrations in each sample (see Fig. 3.21.). This shows clearly that the total micronutrient concentrations vary considerably, and it is not only the individual elements which have variable values. As expected from the high levels noted in the separate element graphs the highest total values are in samples from Nickersons, Oakenshaw and West Stow.

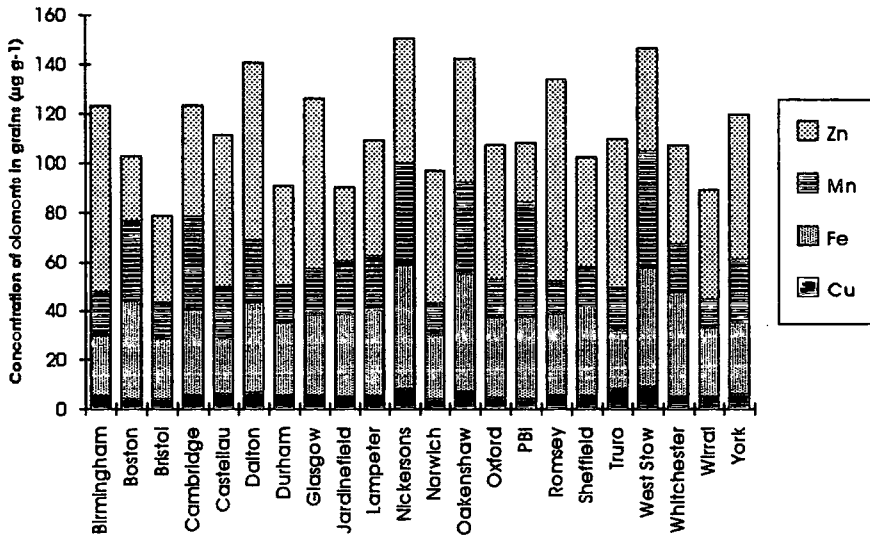

Fig. 3.21. Total micronutrient concentrations in microwave digests of fresh grain.

Plotting the total micronutrients as percentages of a total (Fig. 3.22.) shows the relative "importance" of each element in samples from the various sites. As copper is only present in small quantities the percentage does not vary significantly and all values are below 10%. However, proportions of iron, manganese and zinc all show considerable variation. The latter element shows the largest range of percentage values which account for between just over 20-60% of the total; concentration values for iron range from 20-40% of the total, and for manganese from 10-42%.

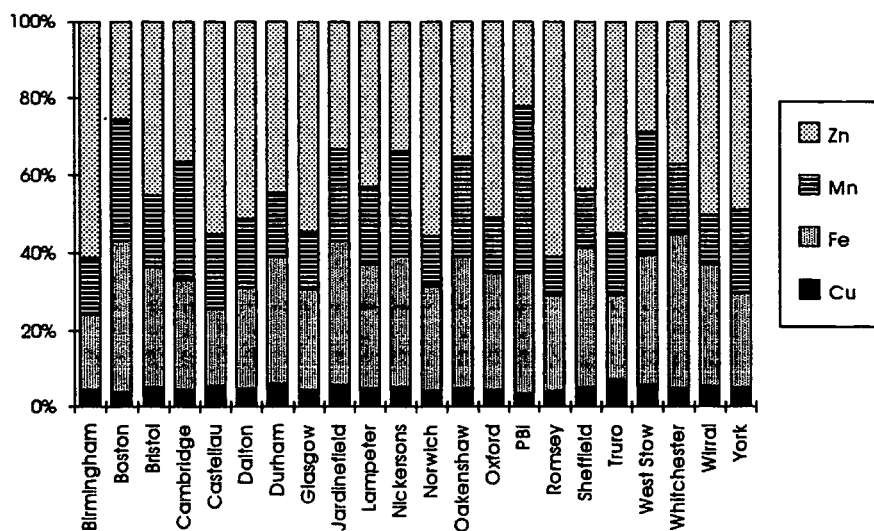

Fig. 3.22. The values in Fig.3.21. presented as percentages.

The macronutrient concentrations in the samples show similar variation (see Fig. 3.23.), with total concentration values (being the sum of the mean concentration values for calcium and magnesium) ranging from 1300-1850 $\mu\text{g g}^{-1}$.

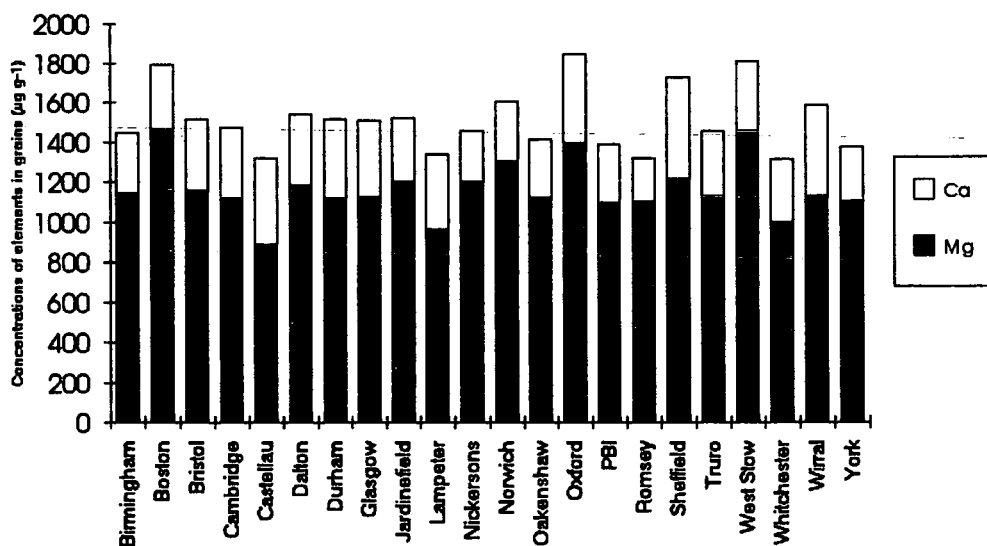

Fig. 3.23. The total macronutrient concentrations measured in samples of fresh grain.

All the samples have a larger concentration of magnesium, and if the values are presented as percentages of the whole (see Fig 3.24.) it can be seen that in only four samples (Castellau, Lampeter, Sheffield and Wirral) does calcium account for more than 25% of the total.

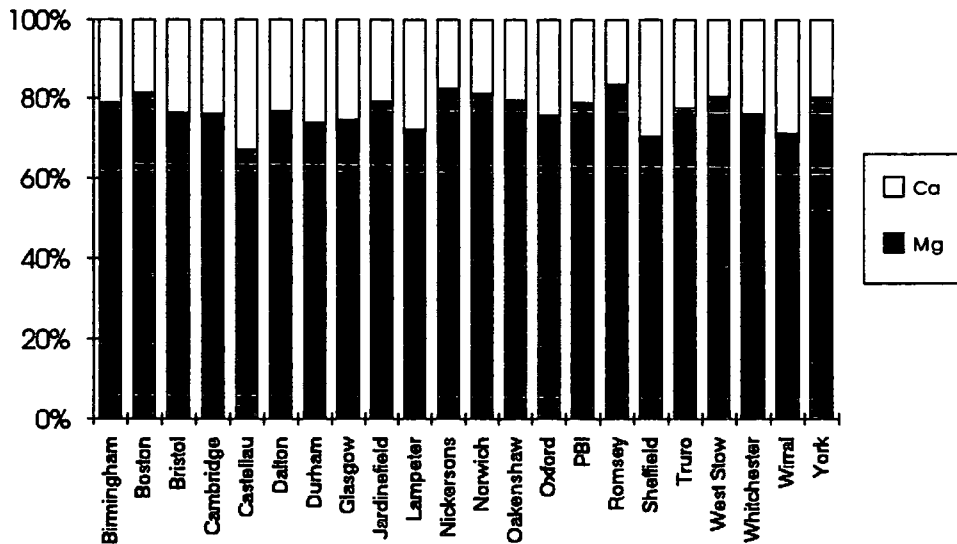

Fig. 3.24. The figures in Fig. 3.23. presented as a percentage of a whole.

The values used in drawing the series of graphs from Fig. 3.9. to 3.24. are calculated using two sample weights; the "fresh" results use the weight of fresh grains prior to acid digest, and the "charred" results use the weight of the grain before it was charred (and prior to acid digest). In order to assess the degree (or absence) of change in elemental concentrations between fresh and charred samples the same scale of weight must be used in calculations, hence the initial pre-burning weights had to be used in the latter series because the weight of the charred grain being less would give apparently higher concentration values. However,

archaeological grain is generally found in a charred state and the pre-burning fresh weight unknown; a second set of results were thus needed to investigate the different concentrations and proportions in charred grain based on the charred weights. The next series of graphs (Figs. 3.25. to 3.31.) are drawn to show the differences in concentration values in charred grain samples by using values calculated from the pre-burning weight and the charred (post-burning) weight of the same sample. Obviously concentration values using the lighter charred weights are significantly greater than those using the larger pre-burning weights.

The values for copper concentrations are approximately five times greater in the calculations based on the charred weight (see Fig. 3.25.). As previously noted, the extremely large value seen in the Castellau sample must be due to contamination at some stage, and should be disregarded. Exceptions occur in the samples from Boston, Bristol, Nickersons, Norwich, Oxford and Wirral, where the concentrations are all apparently "too low" in the charred weight group (i.e. the concentration value based on the original pre-burning weight is greater than 20% that calculated from the charred weight). This must be due to a lesser reduction in weight between the fresh and charred samples; lighter sample weights would give an apparently higher concentration, and one which is lower must relate to a "heavier" charred sample. As mentioned before all the charred weights are lower than the fresh weights but the percentage loss is not constant. The reasons for this are presumably associated with the biochemistry of the grains; possibly those which contain more fats and oils will burn for longer and at a higher temperature resulting in a greater weight loss. Results which vary from the "expected" highlight the problem of "standardisation"; it is

impossible to make everything fit the same base line and grains differ in their size and chemical composition. As seen below, elements which have higher concentration values can appear to "deviate" farther from the expected because larger numbers magnify the differences.

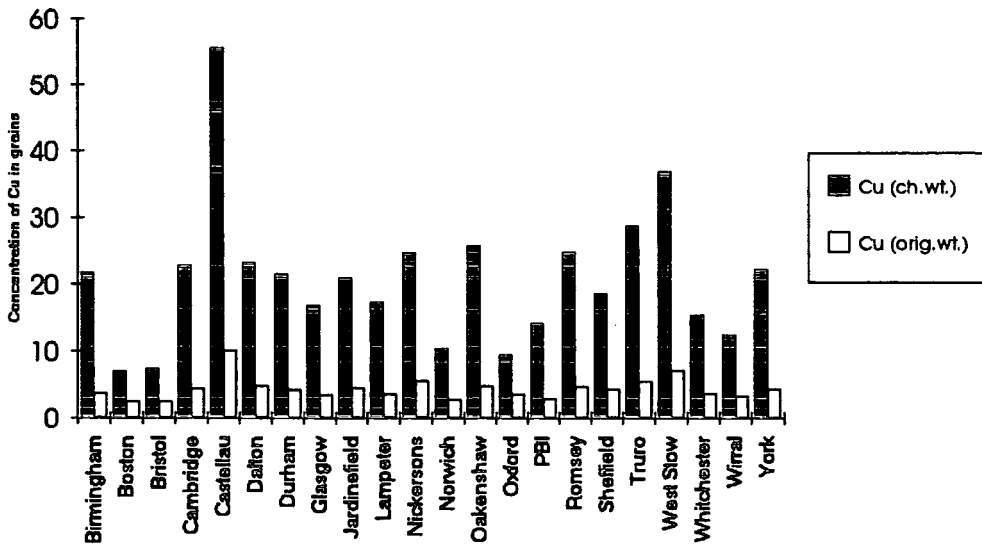

Fig. 3.25. Mean concentrations of copper in charred modern grains calculated using the original pre-burning weight (orig.wt.) and the charred weight (ch.wt.).

The results for iron concentrations (see Fig. 3.26.) again show that the charred values are approximately five times greater than those based on the original weights. "Lower than expected" results in the charred weight concentration values are noted in the same samples as for copper but because the numbers concerned are greater the differences are magnified. In addition, the results from Sheffield and Whitchester, which were only marginally low for copper, are now shown to have lower values than expected (i.e. than

the predicted five times the value for the original pre-charring calculation).

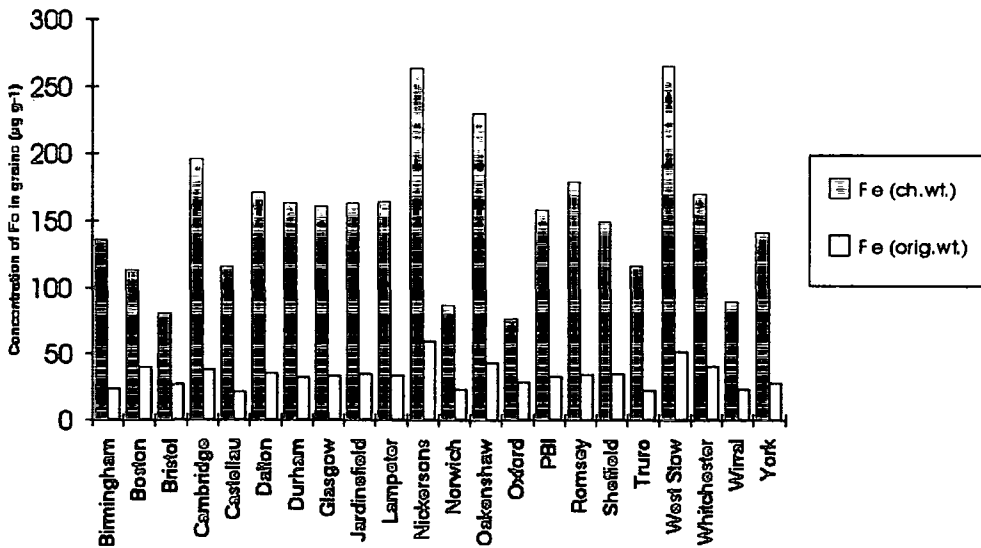

Fig. 3.26. Mean concentrations of iron in charred grains calculated using the original pre-burning weight (orig.wt.) and charred weight (ch.wt.).

The results for manganese (see Fig. 3.27.) again demonstrate that the concentration values in the charred weight calculations are approximately five times those based on pre-burning weights. The same six sites as were found to have "low" values in the copper results (Boston, Bristol, Nickersons, Norwich, Oxford and Wirral) have similarly lower than predicted values for manganese.

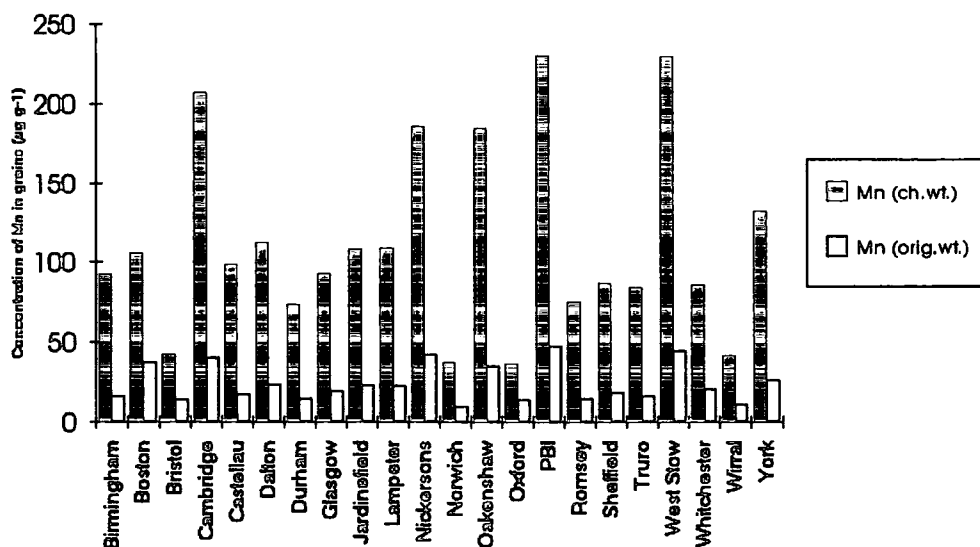

Fig. 3.27. Mean concentrations of manganese in charred grains calculated using the original pre-burning weight (orig.wt.) and the charred weight (ch.wt.).

As the number involved become larger the differences between expected and actual values are greater and this is clearly seen in the zinc results (Fig. 3.28.). The charred weight results are still approximately five times greater than the original weight calculations but more values are not exactly as predicted; Boston, Bristol, Nickersons, Norwich, Oxford, Sheffield, Whitcheater and Wirral have lower values than expected, whilst those for Birmingham, Castellau and Truro are slightly too high.

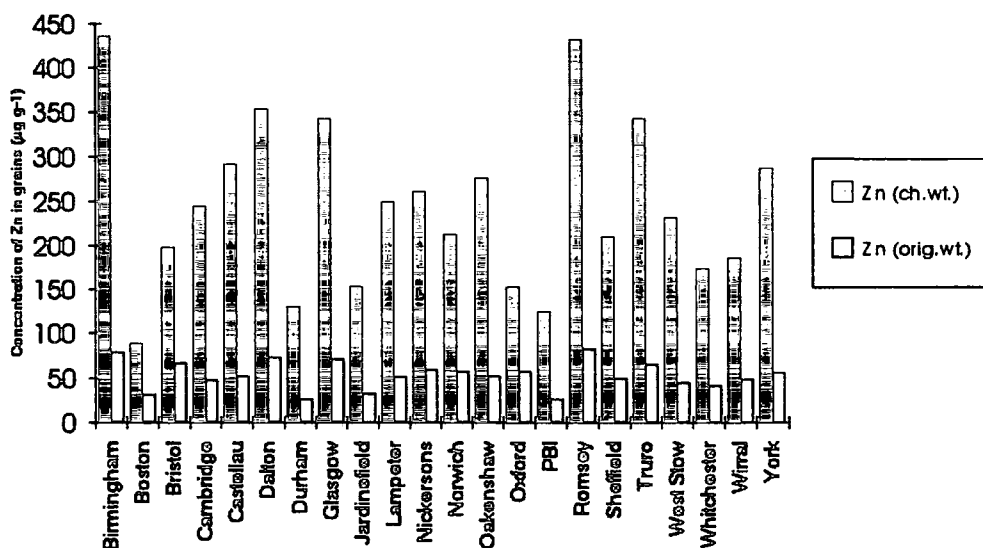

Fig.3.28. Mean concentrations of zinc in charred grains calculated using the pre-burning weight (orig.wt.) and the charred weight (ch.wt.).

If the mean values for the micronutrient concentrations are presented as a total for each sample comparisons can be made between the results calculated using the charred weights (Fig. 3.29.) and the original pre-burning weights of the grains (Fig. 3.30.). As expected, the columns for Boston, Bristol, Norwich and Oxford are significantly lower in Fig. 3.29. (charred weights). The differences in the samples from Nickersons and Wirral are not as obvious because although their values were consistently lower than expected (in the charred weight results) for each individual element this difference is masked by the fact that values for the Nickersons grain are among the highest measured, and the Wirral results among the lowest - thus the decrease in height of the columns between Fig. 3.30 and 3.29. is not as marked.

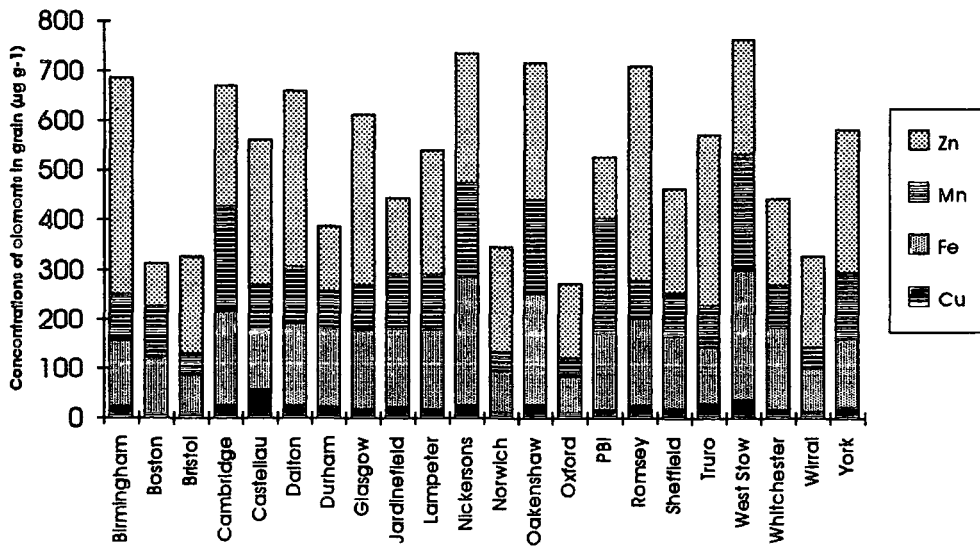

Fig. 3.29. Total concentrations of the micronutrients in charred grains calculated using the mean values of the charred weight.

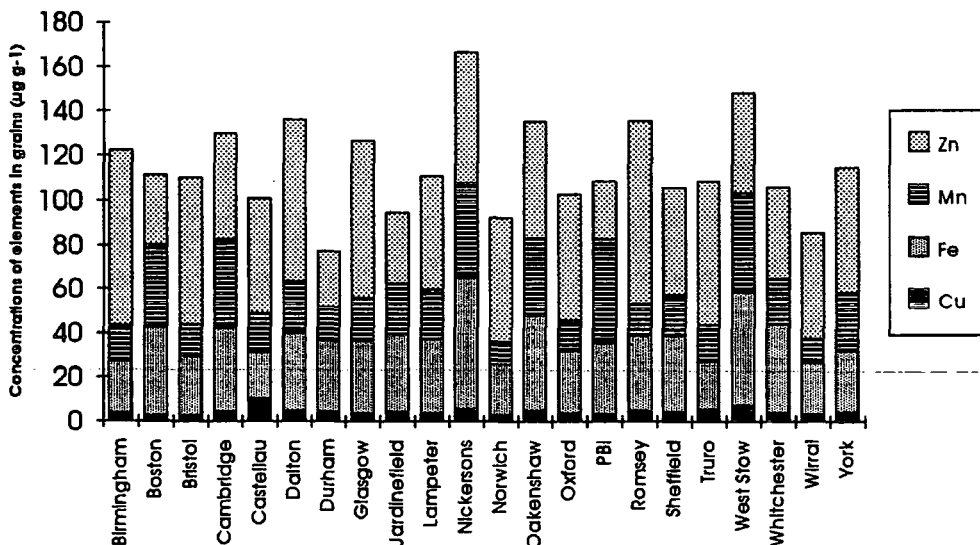

Fig. 3.30. Total micronutrient concentrations in charred grains calculated using the pre-burning weight.

An examination of Fig. 3.21. (which shows the mean total micronutrient concentration values in fresh grains) with the charts in Figs. 3.29. and 3.30. allows a comparison between concentrations

in fresh and charred material. As expected, because the values were similar, the results calculated from the fresh grain weights and the pre-burning (charred) grain weights produce an almost identical pattern, except for the Boston and Bristol samples where the columns are markedly higher in Fig. 3.30. (pre-burning weights).

When total concentrations are considered as percentages of a whole the proportions seen in the charred and pre-burning grain weight results are identical (see Figs. 3.31. and 3.32.). This is not surprising as the two calculations are based on the same basic data.

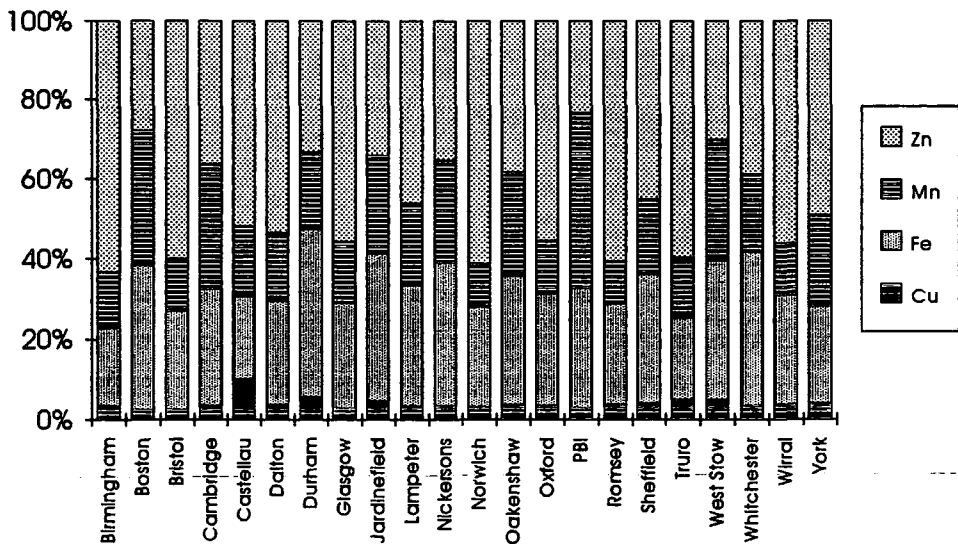

Fig.3.31. The micronutrient elements presented as percentages of a whole calculated using the charred weights of the grains.

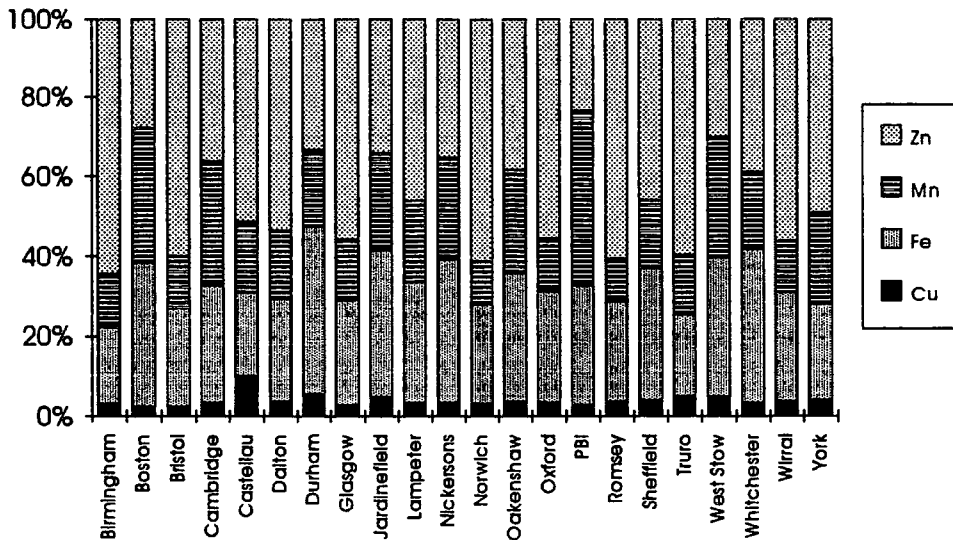

Fig. 3.32. The micronutrient elements presented as percentages of a whole calculated using the pre-burning weights of the grain.

If the fresh grain percentages are examined (see Fig. 3.22.) the proportions are again very similar, although there is some variation in the Bristol values where the percentage of zinc is greater, and that of iron less, in the charred material.

The values for the macronutrients follow the same pattern as the micronutrient elements. The results for the mean concentration values of calcium and magnesium calculated from the charred and the pre-burning grain weights are shown below at Figs. 3.33. and 3.34. Once again the results based on the charred weights are approximately five times greater than those from the pre-burning weights.



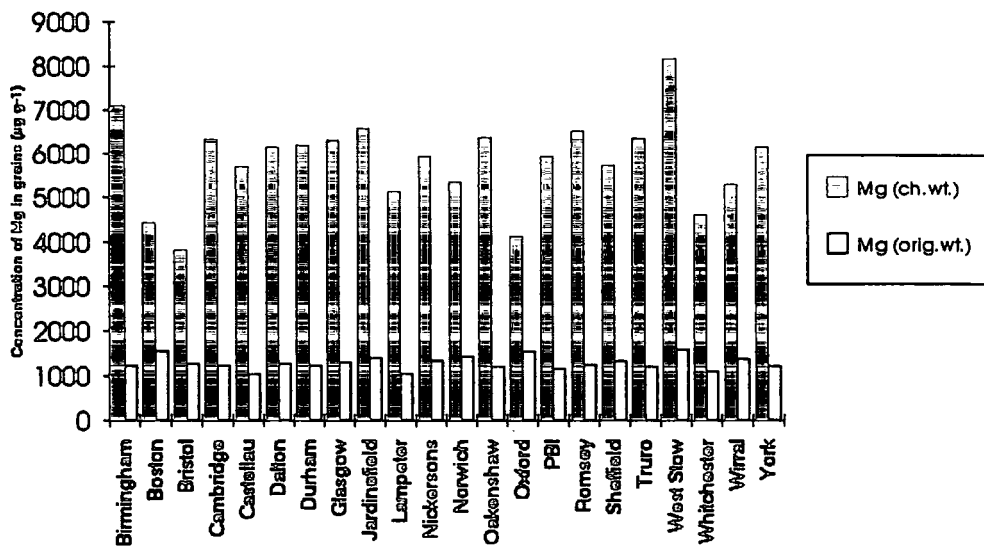

Fig. 3.33. Mean concentration of magnesium in charred grains calculated using the pre-burning weight (orig.wt.) and the charred weight (ch.wt.)

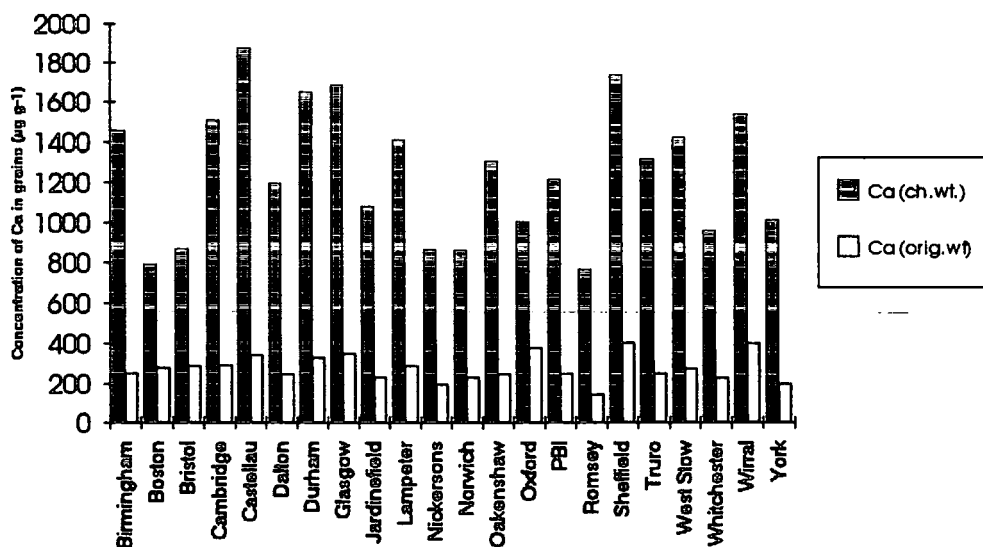

Fig. 3.34. Mean concentrations of calcium in charred grain calculated using the pre-burning weight (orig.wt.) and the charred weight (ch.wt.)

If the macronutrient element totals are considered as a whole (Figs. 3.35.and 3.36.) there are again differences between the results for the two sets of calculations based on pre-burning and charred weights. Obviously the concentration values for the charred weights are much higher than those for the (heavier) original weights, but the pattern of the column heights are similar. As before, differences are seen in the columns corresponding to the Boston, Bristol, Norwich and Oxford (where the heights, and therefore the total mean concentration value, are considerably lower in the charred weight results (Fig. 3.35.).

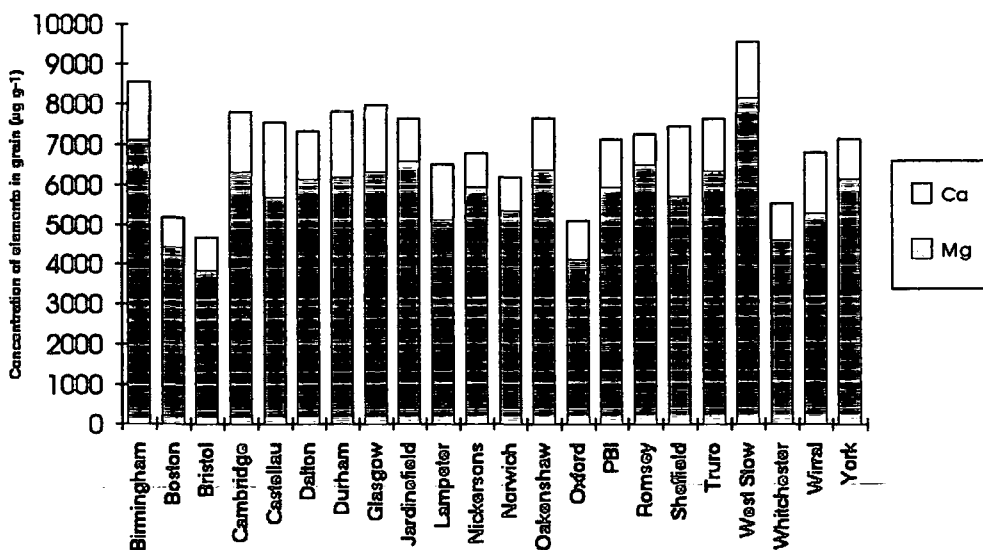

Fig. 3.35. Total concentrations of the macronutrient elements calculated using the charred weights of the grains.

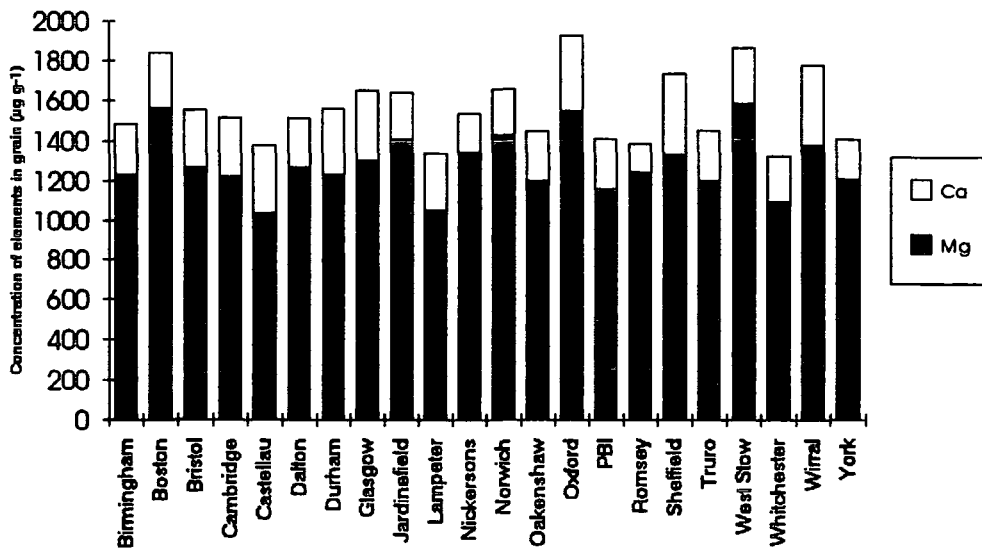

Fig. 3.36. Total concentrations of the macronutrients calculated using the initial pre-burning weight.

However, if the total macronutrient values are presented as percentages (Figs. 3.37. and 3.38.) the graphs for the results based on the two "charred" weights are virtually identical. If the percentage values for the micronutrients in the fresh grain are examined (Fig. 3.24.) the pattern is again almost identical, the difference being that the percentage of calcium is less in the charred material whilst that of magnesium is higher.

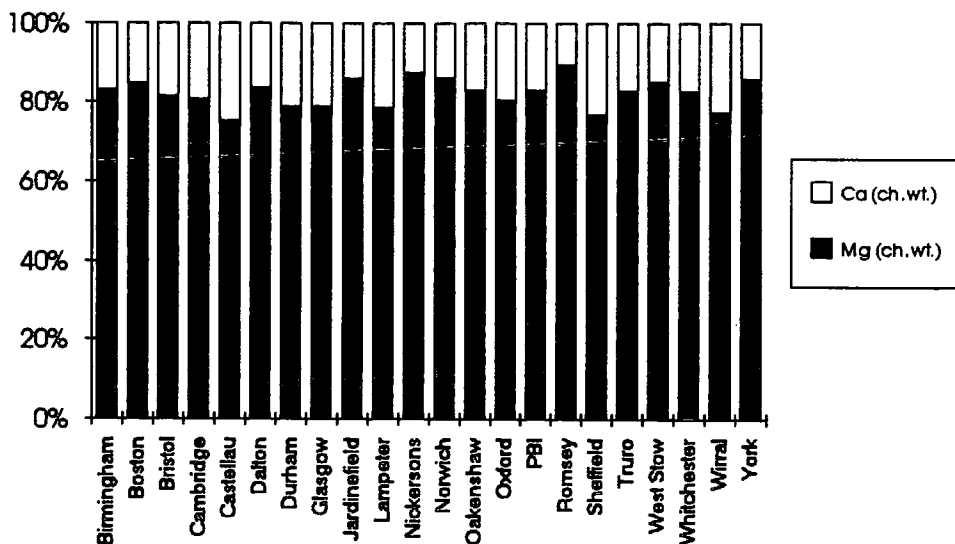

Fig. 3.37. The macronutrients presented as percentages of a whole calculated using the charred weights of the grains.

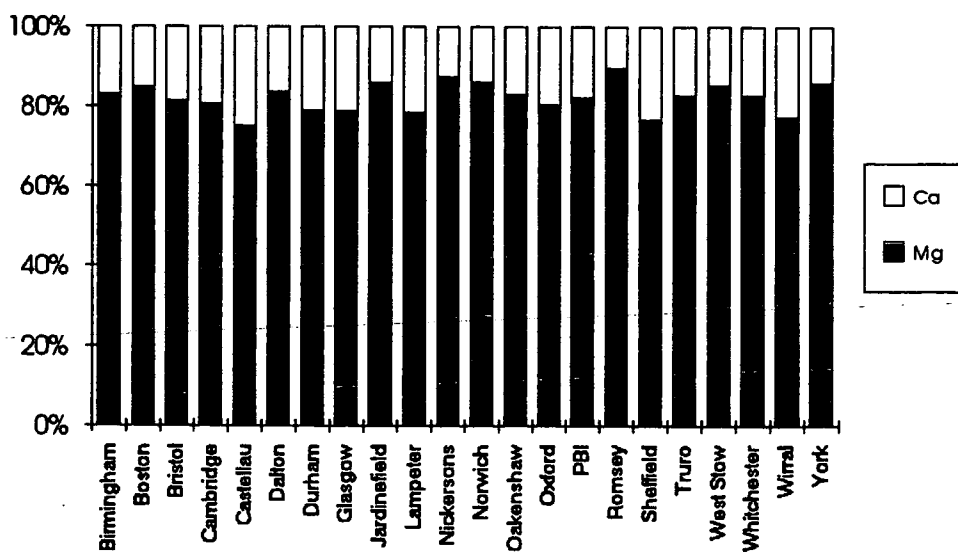

Fig. 3.38. The macronutrients presented as percentages of a whole calculated using the initial pre-burning weights of the grain.

3.10. Statistical work

The results from the individual element analyses indicate that the samples are biochemically distinct in relation to elemental concentrations - as might be expected in grain grown on a wide variety of soil types. However, it was felt that in order to utilise the results of the digestions of fresh and charred grains more fully, and gain further insight into the relationships between the elemental concentrations, various forms of multivariate analysis should be used. These included techniques for ordination of data (principal components analysis (PCA) and "Decorana"), the classifying program "Twinspan", and nearest number and minimum variance cluster analyses.

The wide range of concentration values gave problems with all of these techniques, and it is a matter for discussion as to how worthwhile or relevant the results actually are. To use the forms of multivariate analysis above the concentration values had to be in matrix form, with each sample result consisting of a one, two or three figure number; there were no problems with the micronutrients or calcium but only 10% of the magnesium concentration values were under one thousand and hence the majority required some form of adjustment. Following advice from Dr. B. Huntley (Dept. of Biology, University of Durham) it was decided to reduce the values to a tenth of the original - thus 1419 became 142 and 1203 was listed as 120; those results which were under one thousand were also correspondingly reduced so that all figures were in line, hence 974 became 97. Obviously other methods could have been used to enable the values to be entered but this was thought to be simplest. It could however be argued that this procedure reduces the "importance" of magnesium in relation to the other elements because their "true"

values are used. This results in calcium values being apparently higher (ranging from approximately 200 to 500), and those of other elements being disproportionately large - values for zinc, for example, are read as being approximately half the value of those of magnesium instead of about one twentieth.

Principal components analysis was employed in order to determine if it were possible to obtain cluster patterns of the results, where a grouping of points from different sites might indicate similarities in the elemental concentrations not apparent when the values are considered individually. Whilst it is simple to plot one element against another and examine the distribution, PCA has the advantage of being able to consider all of the elements together, and therefore how concentrations of one relate to, and are affected by, those of the others.

Examination of Figs. 3.41 to 3.43 shows the type of scatter distribution plot obtained from running a PCA program. As can be seen there is no clustering between groups of sites and a widespread general scatter is obtained for both fresh and charred results. However, if the figures/calculations relating to these plots (see Fig. 3.39 below) are analysed certain problems become apparent:

<u>Axis</u>	<u>Eigenvalue</u>	<u>Percent of total</u>
1	4991.573	89.52
2	298.893	5.36
3	161.129	2.89
4	92.078	1.65
5	31.142	0.56
6	1.426	0.03

Eigenvectors (component loadings)

	Plot	Axis 1	Axis 2	Axis 3	Axis 4	Axis 5	Axis 6
1	A	0	0	0	0	0	1
2	B	-0.033	-0.24	-0.096	0.438	0.86	0
3	C	-0.071	-0.405	-0.162	0.738	-0.51	0
4	D	-0.02	0.8	0.321	0.507	0	0
5	E	0.997	-0.018	-0.015	0.077	-0.008	0
6	F	0.008	-0.372	0.928	0	0	0

Fig.3.39. Statistical calculation values used in PCA of modern (fresh) grain.

(1) The large eigenvalue figures relate to a large range of input values in the matrix and for meaningful results smaller figures are more desirable.

(2) The numbers 1-6 in the eigenvectors (lower part of the above table) relate to the elements (1=Cu, 2=Fe, 3=Mn, 4=Zn, 5=Ca and 6=Mg). The figures in the axes columns indicate the effect each element has on a particular axis with positive figures relating to increasing concentrations and negative ones to decreases. It can be seen that copper has no effect on any axis except 6. This is due to the very small concentrations of this element found in the grain samples which are effectively "swamped" by the others.

(3) Related to this are the 'percent of total' figures in the upper part of the table. Almost all the variation present is associated with Axis 1 (89.52%), with Axis 2 relating to only 5.36% of all the pattern; the remaining axes account for an even smaller percentage. This is an abnormal distribution of variation and indicates problems with the input matrix values.

An explanation of what the axes relate to can be determined if the eigenvectors (component loadings) are examined. Axis 1 is

associated primarily with increasing calcium whilst axis 2 relates to increasing zinc and, to a lesser extent, decreasing manganese and magnesium. The right-hand end of the first axis therefore relates to high concentrations of calcium and the left to low values. The upper part of axis 2 is associated with high values for zinc, together with low values for manganese and magnesium, whilst the lower relates to low zinc and high manganese and magnesium. Fig. 3.41. shows axes 1 and 2 and the distribution pattern of the individual (fresh grain) samples. Thus sample 19 (Romsey) in the top left corner has high concentrations of zinc together with lower levels of calcium, manganese and magnesium. Sample 1 (Birmingham) has similar concentrations of zinc, manganese and magnesium, but more calcium. Sample 10 (Jardinefield) lies at the same position in relation to axis 1 and so contains similar concentrations of calcium, but being lower on axis 2 has lower levels of zinc and higher manganese and magnesium. There is no real clustering of samples but similarities in relation to these elements are apparent; for example, samples 16 and 24 (Oxford and Wirral) are more alike than samples 1 and 2 (Birmingham and Boston).

Fig. 3.42 shows the distribution scatter when axes 3 and 4 are considered; 3 relates primarily to increasing magnesium (with low values at the bottom and high ones at the top) and 4 is associated with increasing manganese together with, and to a lesser degree, increasing iron and zinc (low values on the left and high ones on the right). Thus sample 22 (West Stow), being found in the upper right-hand corner, has high levels of magnesium, manganese, iron and zinc, and is distinct from sample 23 (Whitcheater) on the lower left which has lower concentrations of these elements.

PCA (MVSP) - fresh

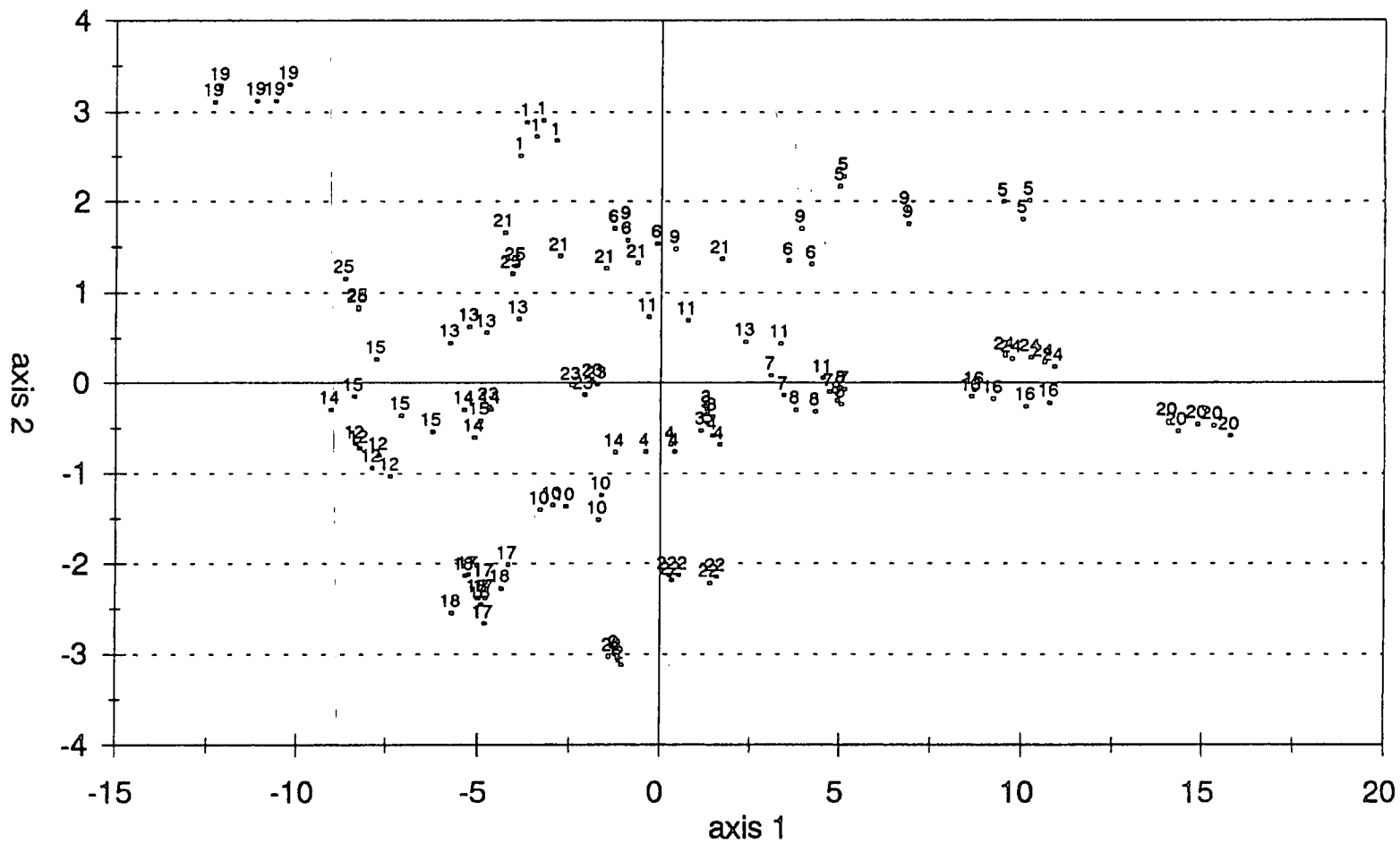

Fig. 3.41. PCA of fresh grains : Axes 1 and 2.

PCA (MVSP) - fresh

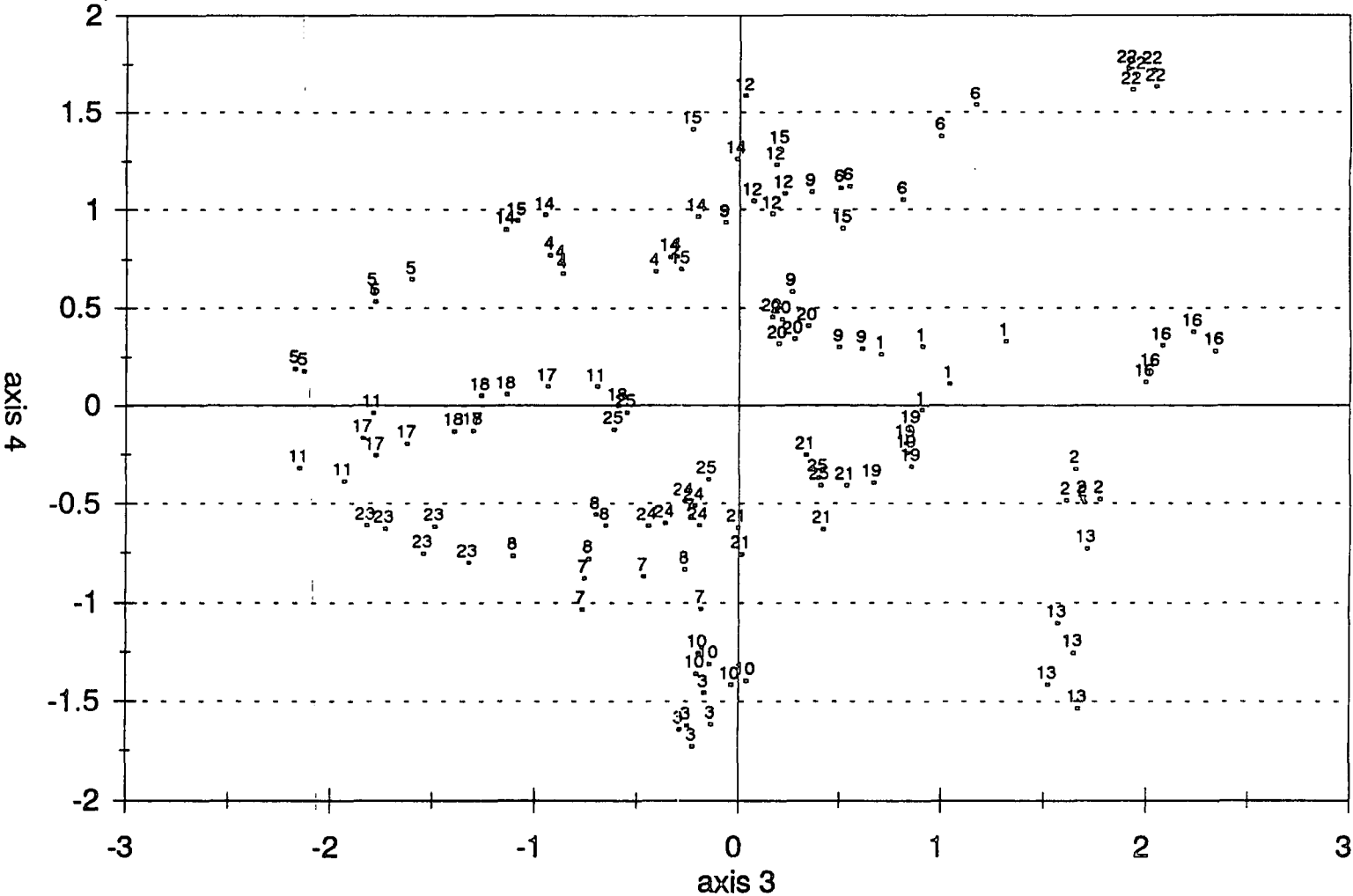

Fig. 3.42. PCA of fresh grains : Axes 3 and 4.

When the carbonised grain results are considered differences are apparent both in statistical calculations and scatter diagrams. Using the uncorrected figures there are still problems as can be seen below (Fig. 3.40.). Eigenvalues are large and axis 1 is still associated with a very high percentage of the total variation. When the eigenvectors are examined it can be seen that the figures are slightly different from those in Fig. 3.39. but the axes still relate to the same elemental increases/decreases; i.e. axis 1 is associated with increasing calcium, and axis 2 with increasing zinc and decreasing magnesium. The scatter diagram relating to these axes is shown at Fig. 3.43. There is still a general widespread scatter with no real clustering of sites, although again there are sites that show similarities in relation to these elements including Samples 12 and 15 (Nickersons and Oakenshaw), and 6,13 and 21 (Dalton, Norwich and Truro). Individual samples from the same site are also closer together indicating a smaller variation in values for charred grain - see sample 19 (top left) and sample 11 (close to the intersection of the axes). Also evident in the figure is the effect of charring on the concentration of calcium in the grains: this was always found to be lower after burning and is reflected in way samples have "dropped" in relation to the axis scale values.

<u>Axis</u>	<u>Eigenvalue</u>	<u>Percent of total</u>
1	4320.205	87.16
2	320.489	6.47
3	205.401	4.14
4	82.634	1.67
5	24.956	0.50
6	2.891	0.06

Eigenvectors (component loading)

	Plot	Axis 1	Axis 2	Axis 3	Axis 4	Axis 5	Axis 6
1	A	0	0	0	0	0	1
2	B	-0.038	-0.266	0.195	0.391	0.859	0
3	C	-0.064	-0.461	0.085	0.728	-0.496	0
4	D	-0.063	0.847	0.108	0.517	-0.001	0
5	E	0.994	0.014	-0.021	0.103	0.007	0
6	F	0.042	0	0.971	-0.193	-0.128	0

Fig. 3.40. Statistical calculation values used in PCA of modern (charred) grain.

What is noteworthy is the fact that very small differences in sample values are magnified when all the elements are considered together - hence small standard deviation values in the individual elements produce distributions which show wider spacing of the samples than might be expected.

In order to allow the effects of elements with low concentrations to enter into the statistical calculations a new matrix was created where each value was a three figure number. Copper values were thus increased one-hundred fold so that a concentration of 3.87 was entered as 387. Other values for other elements were similarly treated; a manganese value of 15.3 became 153, whilst an iron concentration of 39.6 was entered as 396. As can be seen from Fig. 3.44. this causes large differences in the eigenvalues and eigenvectors.

<u>Axis</u>	<u>Eigenvalue</u>	<u>Percent of total</u>
1	1.778	29.63
2	1.493	24.88
3	1.127	18.78
4	0.700	11.67
5	0.664	11.07
6	0.238	3.97

Eigenvectors (component loadings)

	<u>Plot</u>	<u>Axis 1</u>	<u>Axis 2</u>	<u>Axis 3</u>	<u>Axis 4</u>	<u>Axis 5</u>	<u>Axis 6</u>
1	A	-0.144	0.611	0.393	0.516	0.048	0.427
2	B	-0.471	-0.004	-0.439	0.111	0.757	0.032
3	C	-0.649	-0.058	0.218	0.256	-0.29	-0.615
4	D	0.263	0.690	-0.013	-0.282	0.225	-0.570
5	E	0.511	-0.295	0.105	0.664	0.294	-0.337
6	F	-0.076	-0.246	0.771	-0.368	0.452	0.010

Fig. 3.44. Calculation values for PCA of modern (fresh) grain using adjusted figures.

Eigenvalues are lower reflecting a smaller range of elemental concentration values after standardisation, whilst the percentage of the total variation associated with axis 1 is reduced

and correspondingly increased on the other axes. The eigenvectors now show that all six elements have an effect on all the axes

Whilst increasing calcium values still affect axis 1 there is additionally an association with decreasing iron and manganese, and Axes 2 now relates to increasing copper and zinc concentrations.

When the charred results are considered there are differences in the figures associated with changes in the concentrations between fresh and burned grain, which are magnified due to the three-figure adjustment i.e. copper concentration values of 3 and 5 in charred and fresh grains become 300 and 500, as can be seen below in Fig. 3.45.

<u>Axis</u>	<u>Eigenvalue</u>	<u>Percent of total</u>
1	1.898	31.63
2	1.422	23.70
3	1.045	17.42
4	0.945	15.90
5	0.406	6.76
6	0.276	4.59

Eigenvectors (component loadings)

	<u>Plot</u>	<u>Axis 1</u>	<u>Axis 2</u>	<u>Axis 3</u>	<u>Axis 4</u>	<u>Axis 5</u>	<u>Axis 6</u>
1	A	0.096	-0.400	0.248	0.831	-0.265	-0.085
2	B	0.593	0.048	-0.267	0.230	0.687	-0.225
3	C	0.650	-0.074	0.121	-0.150	-0.230	0.694
4	D	-0.364	-0.443	-0.588	0.131	0.237	0.502
5	E	-0.269	0.602	0.320	0.379	0.336	0.453
6	F	0.113	0.522	-0.636	0.269	-0.486	-0.042

Fig. 3.45. Calculation values for PCA of modern (charred) grain using adjusted figures.

The amount of variation present in each axis is still broadly similar, with 31.63% and 4.59% of the variation being associated with axes 1 and 6 respectively in the charred material analyses (the figures for the same axes being 29.63 and 3.97 in the fresh). Additionally, there are differences in the elements associated with each axis and these are generally associated with reversal/inversion patterns. For example, axis 1 is associated with increasing calcium and decreasing iron and manganese in fresh grain analyses, but with increasing iron and manganese and decreasing calcium and zinc in the charred results. This is reflected in the scatter plots where samples move from the left of axis 1 in fresh material to the right in the charred (and similarly from above axis 2 when fresh grains are considered to below the axis when burnt material is analysed).

These differences have an effect on the distribution pattern of the samples; this is demonstrated in Figs. 3.46 to 3.51. which are the scatter plots relating to each axis in the PCA.

Fig. 3.46. shows axes 1 and 2 relating to the analysis on fresh grains. As well as showing a different scatter pattern there are also changes in the elements associated with each axis. Axis 1 now relates to increasing manganese and calcium and decreasing iron, whilst Axis 2 is linked with increasing copper and zinc; thus those samples shown in the top right hand corner have high concentrations of these elements.

A further point to notice is that the scales on the axes are much decreased; in the initial PCA axis 1 was scaled from -15 to +20 but with adjusted values (and thus a smaller overall range) this is reduced to a scale from -0.4 to +0.2. Relating to this is the much tighter grouping of the resultant plot, with most samples

concentrated around the intersection of the axes, indicating less variation in the samples than when the figures were unadjusted (thus perhaps inferring that the distribution is rather artificial). The two small "outlying" clusters relate to samples from Nickersons and Oakenshaw (top left) and Boston and PBI (bottom left); all of these samples have lower manganese and calcium together with more iron than those on the right of the diagram, but are distinct from each other in that those at the top have higher concentrations of copper and zinc than the lower group.

Fig. 3.47. shows the distribution obtained from a PCA of the carbonised grains. Again the axes have much smaller scales than those seen in the unadjusted plots. The scatter is still widespread but "clumping" of samples is more evident producing numerous small clusters each with similar concentrations of the elements.

Figs. 3.48. and 3.49. show the distributions associated with axes 3 and 4 in fresh and carbonised grain. Both show a relatively tight scatter around the intersection of the axes. The outlying group in Fig. 3.48. relates to the samples from West Stow (also seen in Fig. 3.42.). The distinct group in the carbonised grain scatter relates to the samples from Castellau and is separate due to the effects of contamination and high copper concentrations (and should therefore be disregarded).

There is a similar lack of distinct and separate clustering in the patterns associated with axes 5 and 6 in both fresh and carbonised analyses (see Figs. 3.50 and 3.51.), and both give a general scatter, although that for the carbonised samples is more tightly grouped around the intersection.

(The number coding in the PCA diagrams is explained in Appendix 8)

fresh

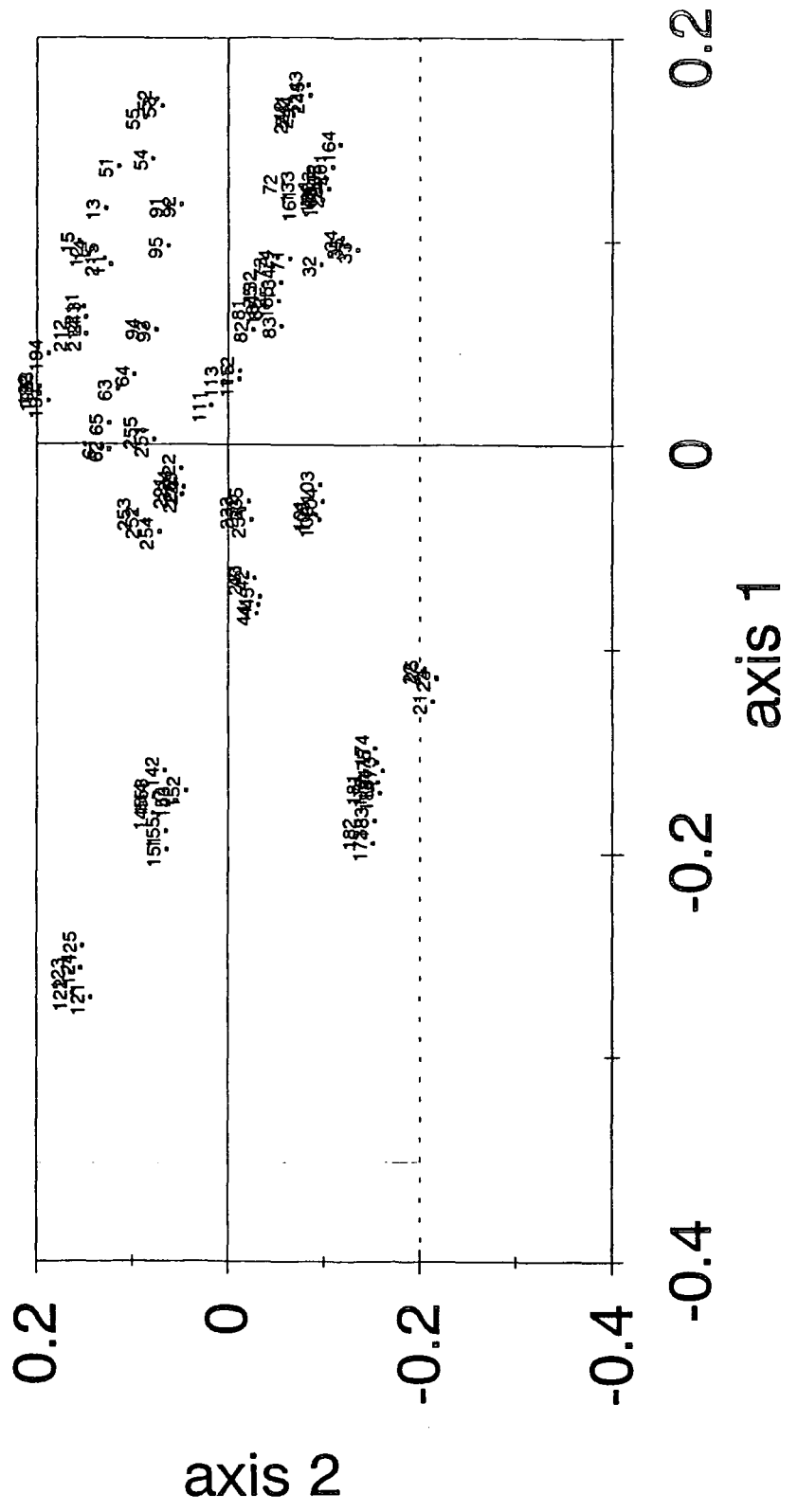

Fig.3.46. PCA fresh grain results (adjusted figures) : Axes 1 and 2

carbonised

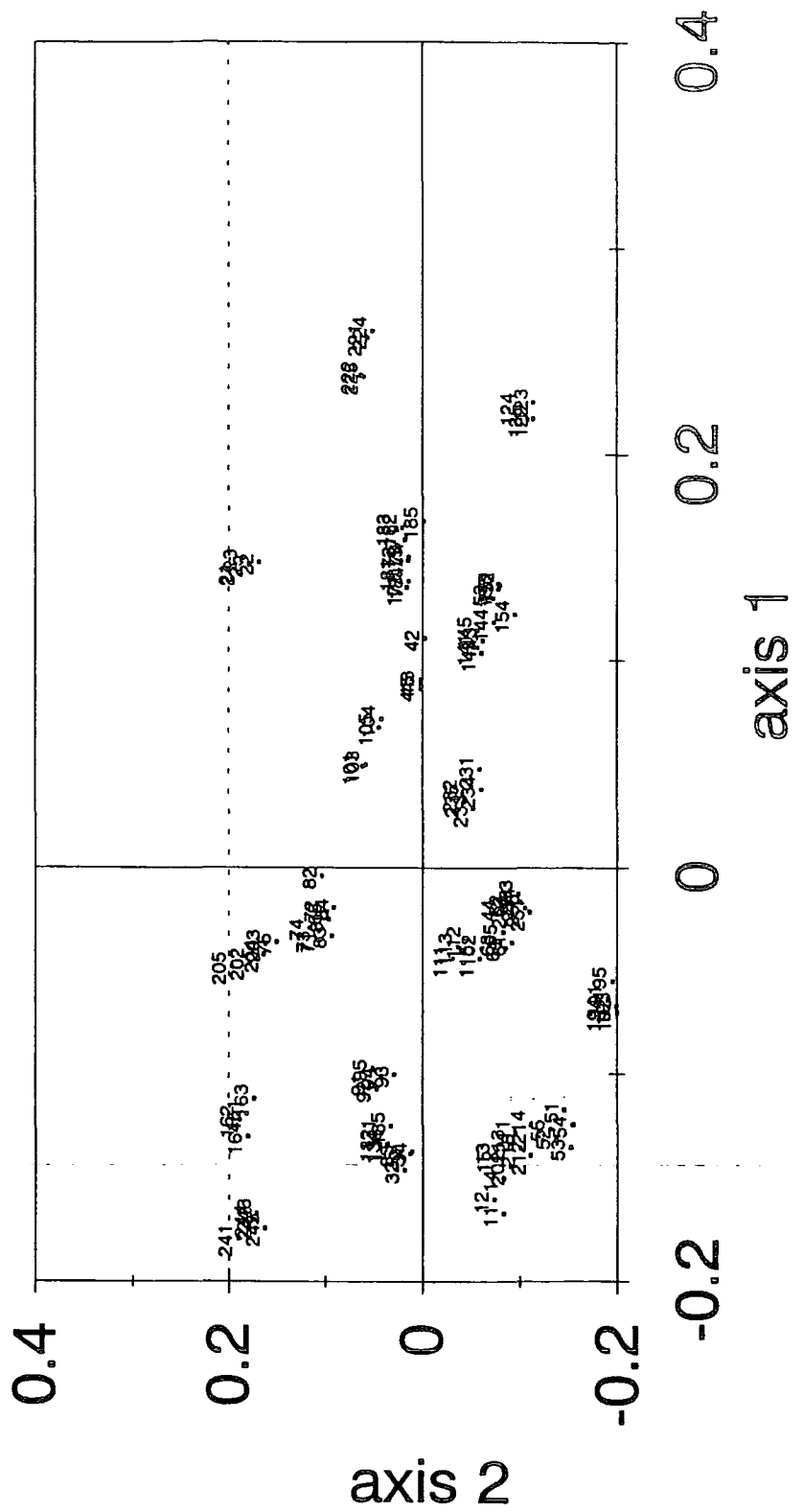

Fig.3.47. PCA for charred grain results (adjusted figures) : Axes 1 and 2

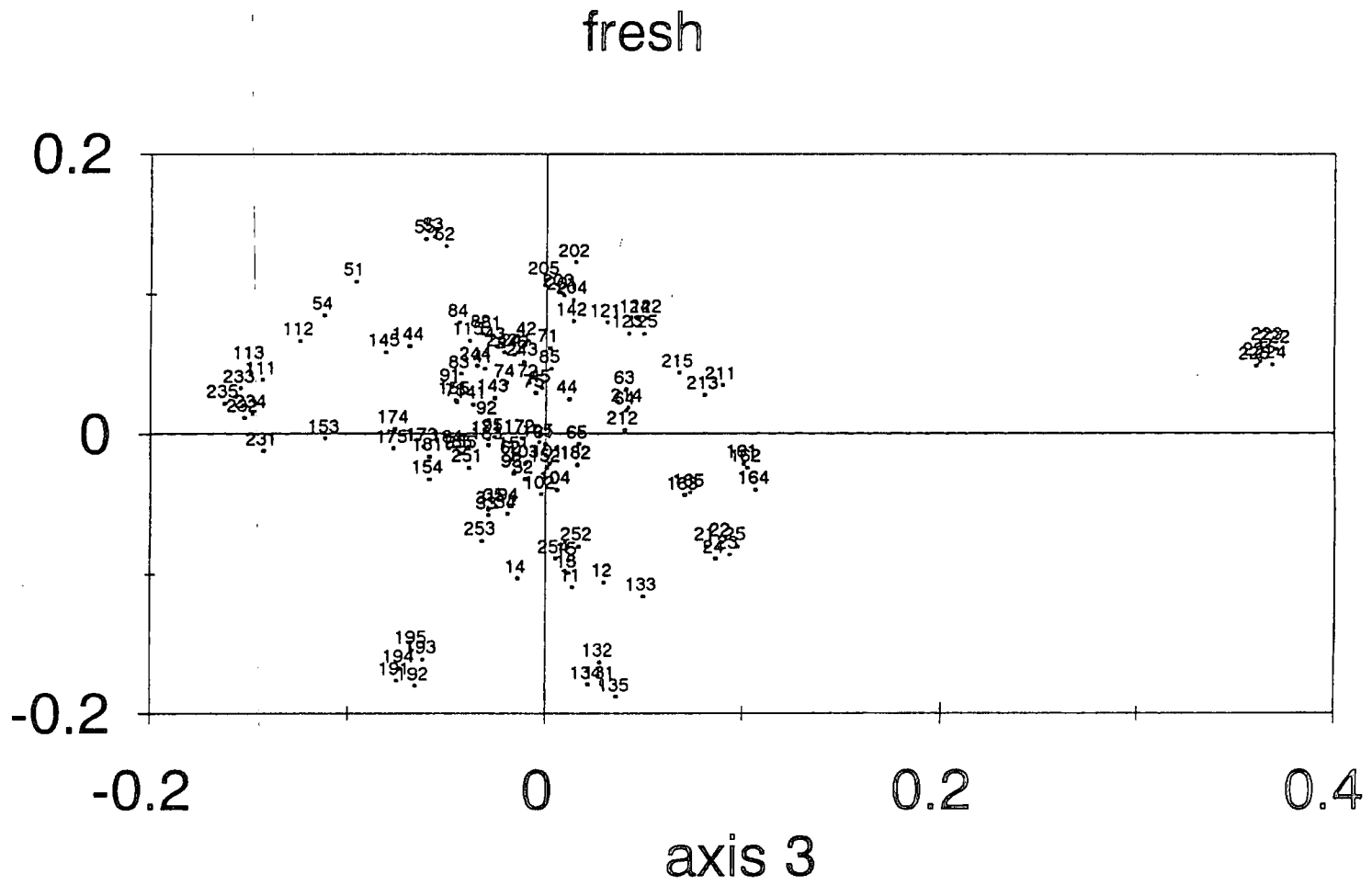

Fig. 3.48. PCA of fresh grain results (adjusted figures) : Axes 3 and 4.

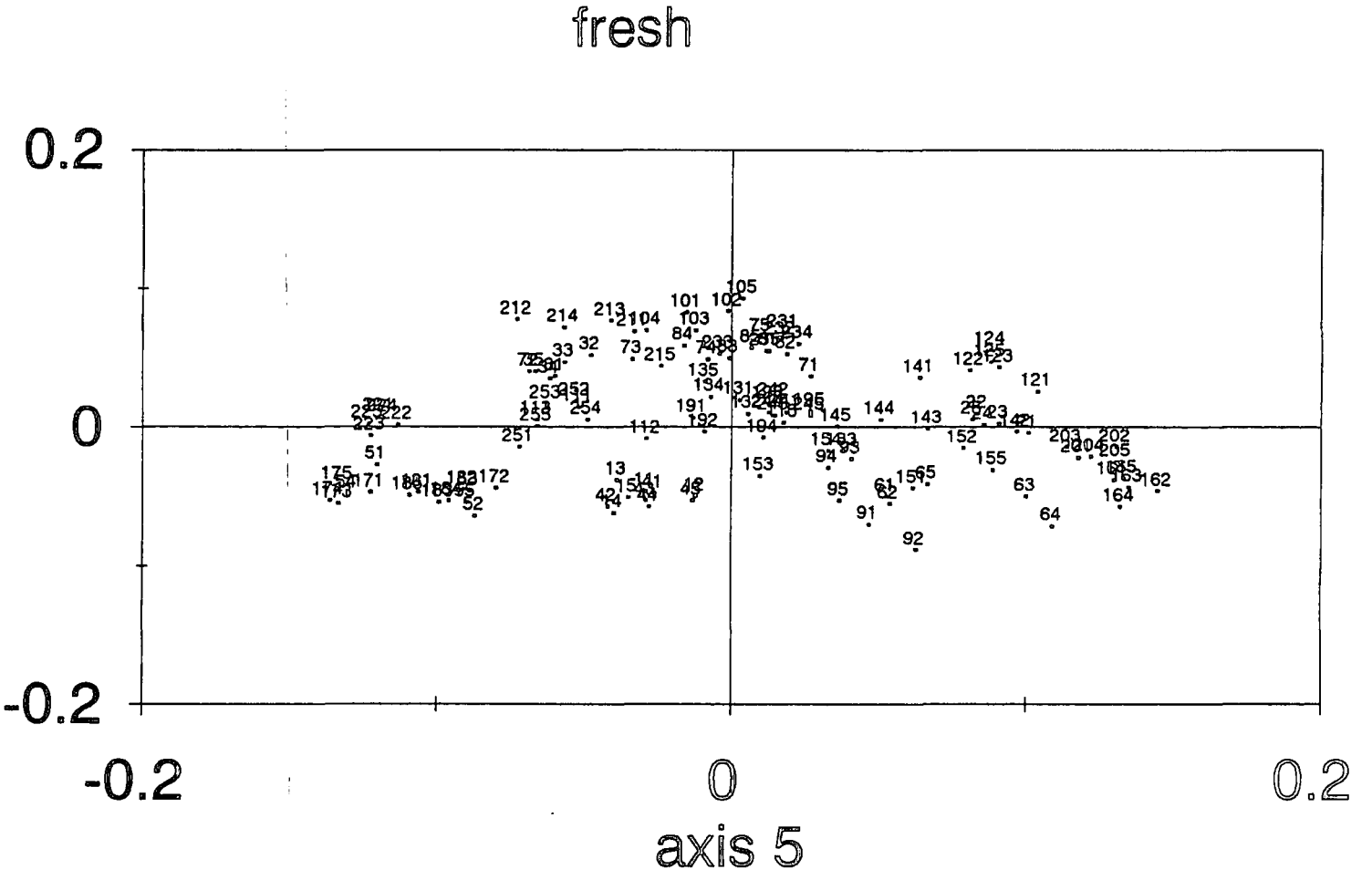

Fig. 3.50. PCA of fresh grain results (adjusted figures) : Axes 5 and 6.

carbonised

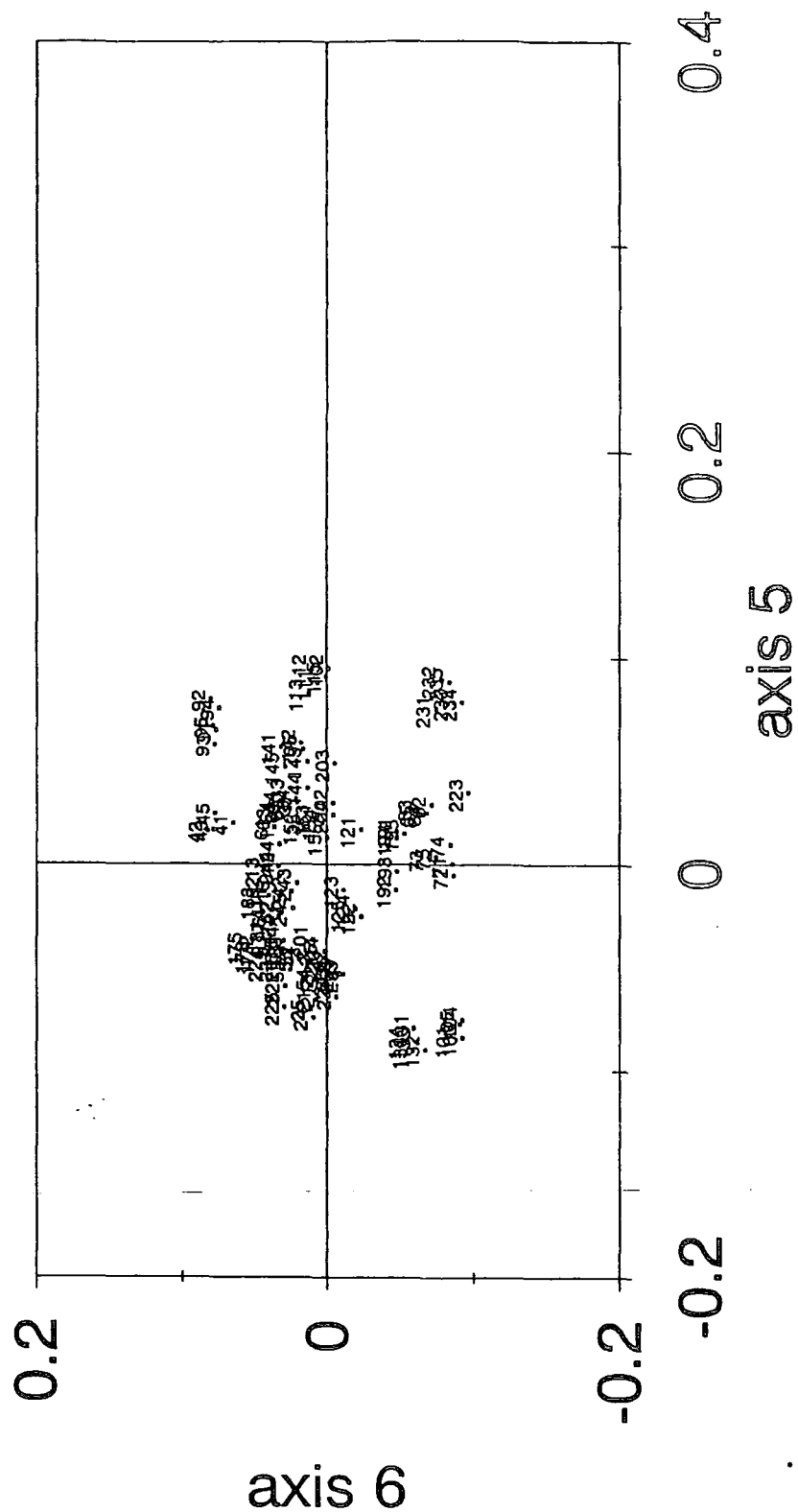

Fig. 3.51. PCA of charred grain results (adjusted figures) : Axes 5 and 6.

A "Decorana" program was also run on the results from fresh and charred grain analyses. This is another method of ordination and a derivative of PCA but only the first four axes are extracted. In addition, whereas PCA considers the absolute values in the matrix "Decorana" normalises data prior to computing and hence examines the relative amounts. Once again there was no evidence of relationships between the sample groups and a widespread general scatter was obtained in all cases as can be seen in Figs. 3.52 and 3.53. There are similarities in the distribution patterns of fresh and charred grains for axes 1 and 2, in that many samples are found in the same quarter of both diagrams, although once again the samples from the same sites are more tightly clustered in the plot relating to the carbonised material, indicating there is more variation in the results from the fresh grains.

Another statistical package used was "Twinspan" which classifies how similar samples are, but depends on pseudospecies set by the programmer which act as the "cut-off" points within the original data. This means that with judicious numbering (of the pseudospecies) it is possible to form highly artificial groups which can be used to "prove" a theory. This being said it was still felt that it might prove interesting to study the tree-type diagrams produced by using two different sets of pseudospecies. The resultant patterns are seen at Figs. 3.54 to 3.57. and show very different results for fresh and charred modern grain analyses, with little (or no) similarity between the two, even when the same cut-off points are used. Twinspan classifies by initially dividing the data into two unlike groups (in relation to elemental concentrations), and then subdividing these until the groups cannot be split any further (i.e. until all the samples at the bottom of the branches

are "alike"). A larger tree indicates more variation and a greater number of dis-similar samples. When values of 1,50,100,150 and 200 are used as pseudospecies (see Figs. 3.54. and 3.55.) the resultant trees are significantly different, with more branches being formed in the carbonised analyses, suggesting wider variation and more distinct and separate sample groups. With different pseudospecies (1,10,25, 40,100 and 200) the tree pattern is altered; both fresh and carbonised have significantly more branches (see Figs. 3.56. and 3.57.) and the classification shows greater variety exists between the sites - samples from the same site still tend to be grouped together.

Finally, two statistical packages were used to examine the relationships between samples using "nearest neighbour" and "minimum variance" clustering. Nearest neighbour clusters by assessing which sample is closest to the cluster when adding other members. It adds individuals by measuring terms of dissimilarity and hence there is high variance between samples and the dendrogram produces long chains. Minimum variance clustering measures the variance of the cluster and adds an individual to that cluster whose variance it will increase least when it joins it i.e. individuals are related to the centre of the cluster producing spherical groups. The resultant dendrogram consists of close clusters with big breaks in between as the groups are separated by large differences in variance. The results are shown in dendrogram form at Figs. 3.58 to 3.61. Samples from the same site show close grouping as expected from the results of the analyses which have small standard deviation from the mean values. This apart, each set of samples appears to form a distinct entity on its own and there is no evidence of groups of sites being biochemically linked.

DECORANA - fresh modern

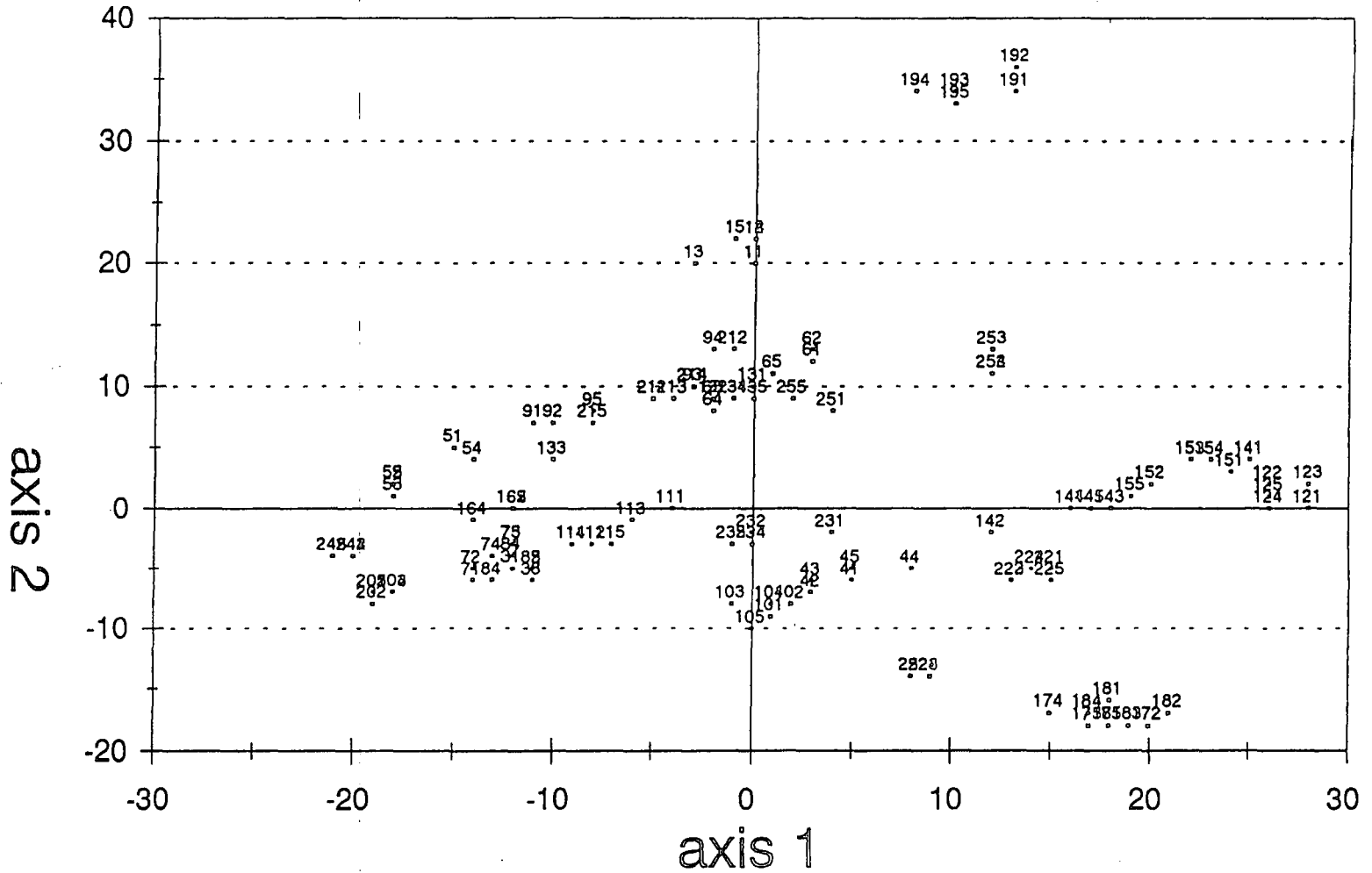

Fig.3.52. Decorana distribution for fresh grain : axes 1 and 2.

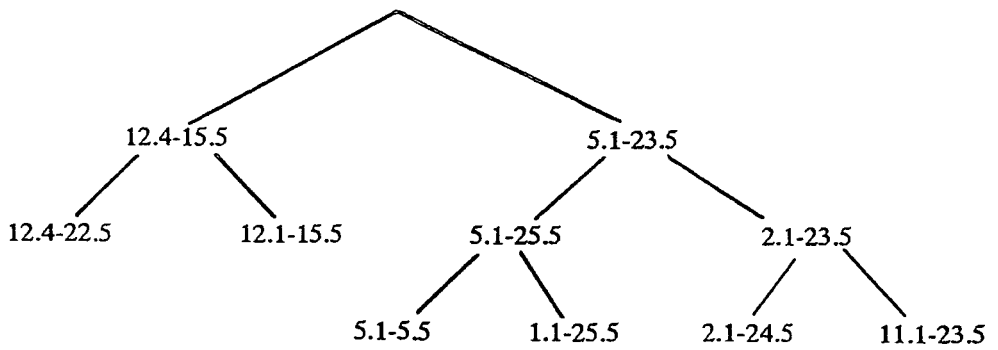

Fig.3.54. Twinspan classification of fresh grain (pseudospecies 1,50,100,150 and 200)

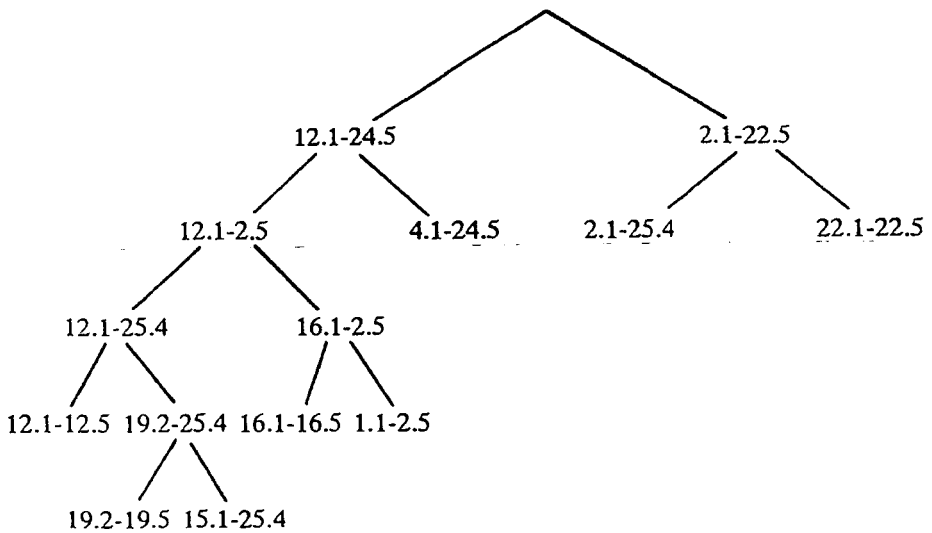

Fig.3.55. Twinspan classification of carbonised grain (pseudosp. 1,50,100,150 and 200)

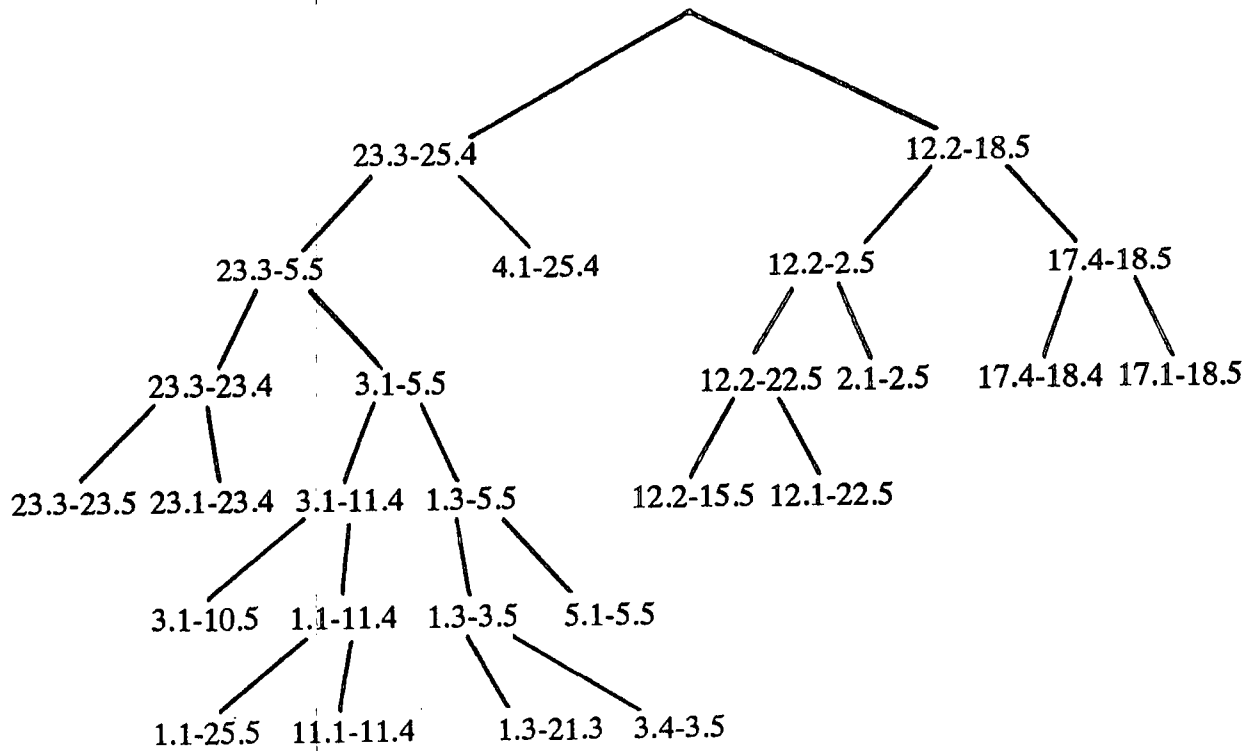

Fig.3.56. Twinspan classification of fresh grain (pseudospecies
1,10,25,40,100 and 200)

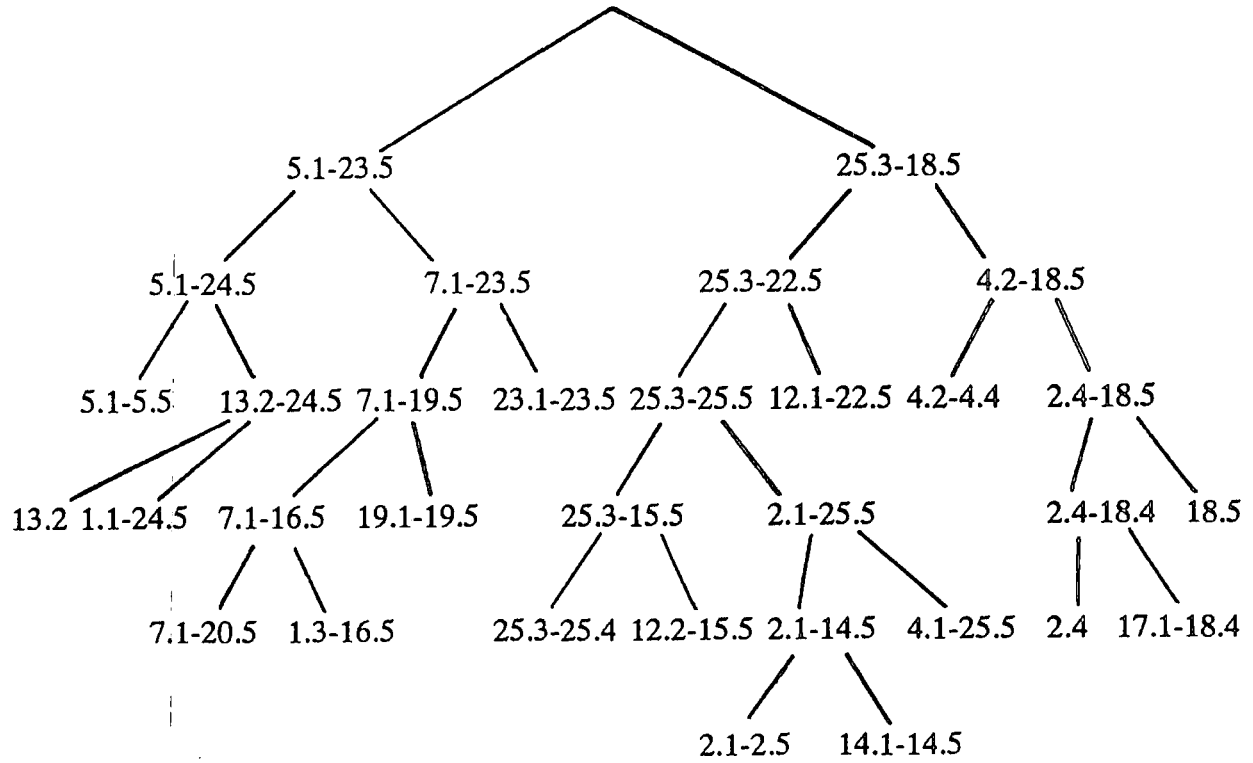

Fig.3.57. Twinspan classification of carbonised grain (pseudosp. 1,10,25,40,100 and 200)

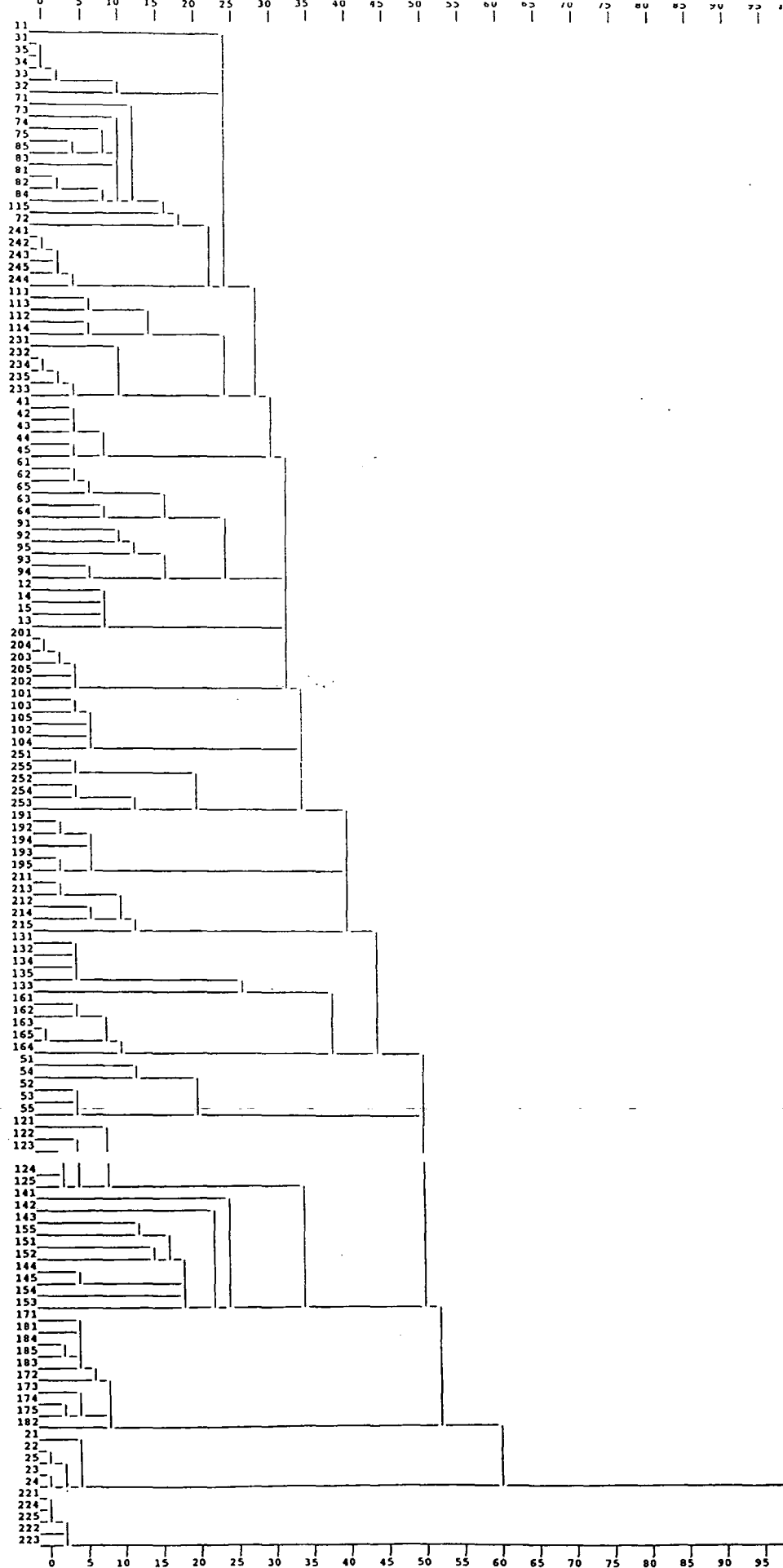

Fig. 3.58. Dendrogram for nearest neighbour clustering : fresh grain.

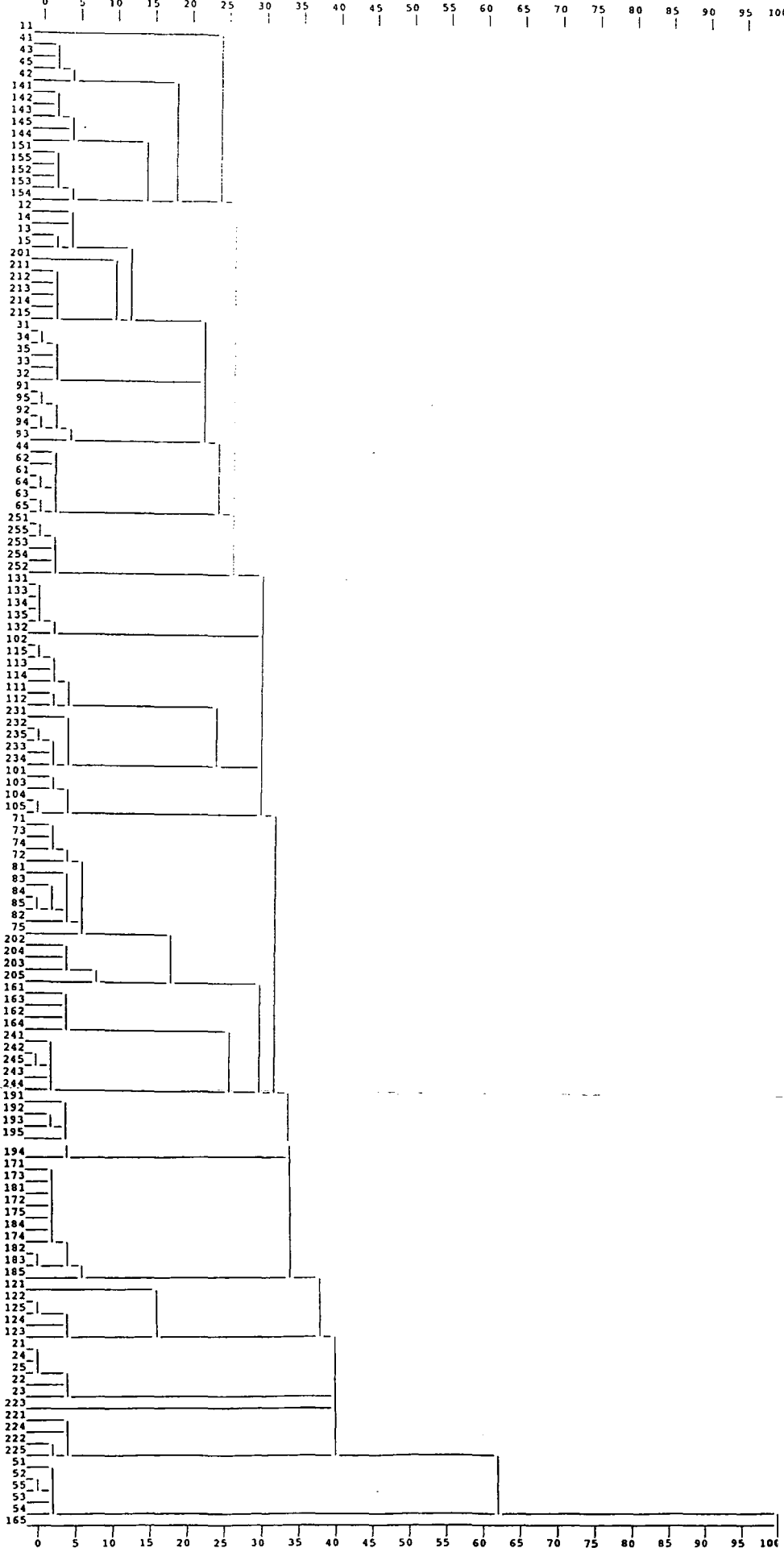

Fig.6.59. Dendrogram for nearest neighbour clustering : carbonised grain.

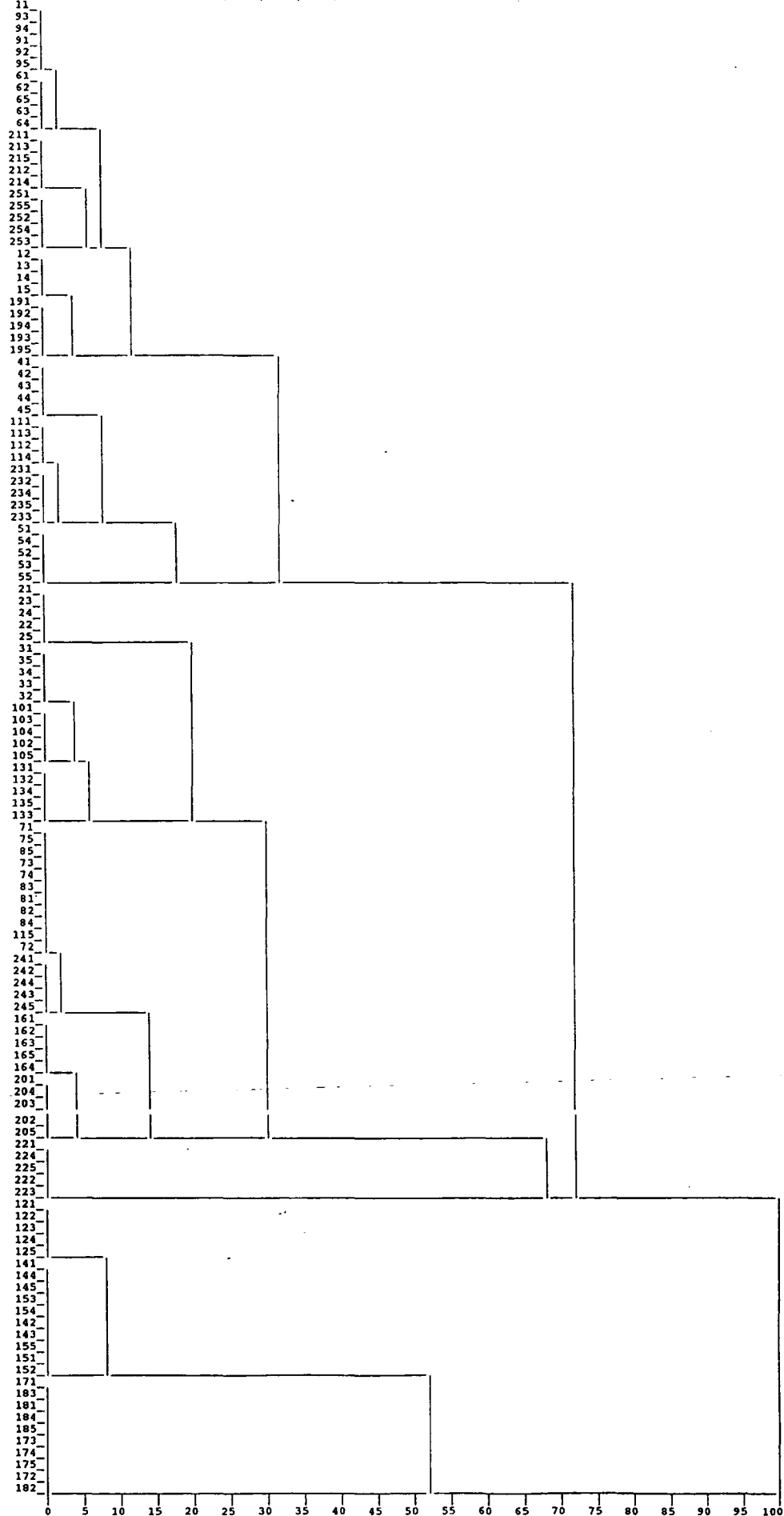

Fig.3.60. Dendrogram for minimum variance clustering : fresh grain.



Fig.3.61. Dendrogram for minimum variance clustering : carbonised grain

3.11. Conclusions.

Following the unsuccessful decomposition of spelt grains in acid using a hot plate to heat the material, a method of digestion using nitric acid in a closed vessel microwave technique was developed. This provided a solution of less than one molar strength which was suitable for analysis by AAS.

The theory proposing that grain grown on different soil types would contain different proportions of elements was shown to be true, both for the individual elements considered (copper, iron, manganese, zinc, calcium and magnesium), and also when the total mean concentrations of the micro and macronutrients are examined. This was further demonstrated by the use of various statistical programs.

Since archaeological material (which is frequently in a charred condition) was to be investigated experiments were performed to assess what changes in elemental concentrations and proportions occurred due to burning. It was found that the concentrations of copper and calcium are always lower in charred material, whilst that of magnesium is always higher. Results for iron show a slight trend for fresh grains to have a slightly higher concentration of the element, whilst charred grains have a slightly higher concentration of zinc. The results for manganese are very equally spread with exactly 50% containing more of the element in fresh grains (and obviously 50% of the charred samples showing a higher value), although the range between charred and fresh values is very small. It is accepted that twenty two sites is a very small sample number to make generalisations about and to verify the trend of results obtained for iron, manganese and zinc more samples would have to be analysed.

Concentration values were calculated using three different grain weights (fresh, pre-burning and charred); of these the latter is probably the most useful when considering the archaeological grain. For this reason the values used in plotting graphs 3.29. (total micronutrient concentration) and 3.35. (total macronutrient concentration) are perhaps the most helpful for comparison with elemental suites in ancient material. It might also be instructive to compare the percentage values of the elements in charred material (Figs. 3.31. and 3.37.) with the older samples.

CHAPTER 4

THE SOIL

"I am a little world cunningly made of elements"
Donne

4.1. Introduction

Sposito (1983) gives one of the best definitions of soil when he defines it as an "open multi-component chemical system containing solid, liquid and gaseous phases, influenced by living organisms and by the terrestrial gravitational field. From this strictly chemical point of view, soils are complex assemblies of matter whose properties continually are modified by the actions of biological, hydrological and geological agents. The labile aqueous phase in soil, the soil solution, is the principal seat of this activity, a dynamic, open, natural water system whose properties represent the effects of soluble complex formation, oxidation-reduction, adsorption and precipitation-dissolution reactions that proceed concurrently. The net outcome of these many reactions is a dense web of chemical inter-relations mediated by variable fluxes of matter and energy from the atmosphere, hydrosphere and biosphere."

Soil varies in its chemical, biological and physical properties from place to place, depending on parent rock, climate, topography, and age. Ninety eight per cent of the earth's crust is made up of eight elements: oxygen, silicon, aluminium, iron, calcium, sodium, potassium and magnesium (in that order of abundance), and more than 80% of the crust is formed from silicates and alumino-silicates, which are geochemically simple low-

density minerals (Plant and Raiswell, 1983). Those silicates formed first from the magma, at the highest temperatures and pressures, are generally compounds of iron, magnesium and calcium, forming the ultra-basic and basic rocks such as gabbro (West, 1981). The last rocks to solidify, at low temperature and pressure, are mostly compounds of sodium and potassium with quartz, forming acid granites and rhyolites. Since the nature of the parent rock essentially determines the trace element content of the soil, those formed from granites tend not to be fertile because they were crystallised from a magma depleted of most of the bio-essential elements.

4.2. Trace elements in soils

The incorporation of trace elements into the crystal lattices of silicates is controlled largely by their valency and ionic radii, with electronegativity and crystal field stabilisation energies also being important. Smaller ions preferentially replace others in crystal lattices, and the less electronegative a cation, the greater its tendency to enter an ionic crystal lattice. One ion can substitute for another if the radius of the larger ion does not differ from the smaller one by more than 15%, and the ionic charges do not differ by more than one. Magnesium and iron (II) have atomic radii of 66pm and 74pm respectively ($\text{pm} = 10^{-12}\text{m}$), and they can be replaced by cobalt (II) (72pm), chromium (III) (63pm), nickel (69pm), zinc (78pm), and to some extent by copper (II) (72pm). Consequently soils formed on basic rocks are generally well-endowed with micronutrients; in some ultra-basic rocks such as serpentine the amounts of the elements including chromium and nickel can rise to toxic levels (Davies and Jones, 1988). Magnesium, iron and

manganese are all found as divalent ions in the octahedral positions of silicate minerals; these elements are commonly concentrated in the first minerals formed and decrease in concentration as the magmatic cooling sequence progresses. Variations in the amounts of elements in rocks are often proportional to their ionic radii - magnesium with the smallest radius is most highly concentrated in early members of the cooling sequence; manganese with a larger radius is least concentrated in early formed minerals. Zinc, which is uniformly distributed among rocks formed at the various stages of development, has a tendency to be associated with sulphides; copper has an even greater tendency to associate with sulphides, and because of its high electronegativity is to some extent excluded from the silicates. Iron in magmas is principally a function of the oxidation state of the magma - those formed without contact with air are largely in the Fe(II) state, whilst those oxidised are largely Fe(III) compounds. Elements such as fluorine, uranium, tin and tungsten tend to be incompatible with ionic and molecular sites in major rock-forming minerals and are only found in highly evolved potassium granites, which may explain why they are not of major biological importance.

Igneous rocks generated at high temperatures and pressures are not in equilibrium with conditions at the earth's surface and so are eroded and chemically altered by weathering processes, whereby rock (hard, usually non-porous and of low reactivity) is transformed through various stages to soil (soft, porous and chemically active). By physical action the rock is broken into smaller particles which have an increased surface area open to attack by water and air (the main agents of chemical weathering), in the processes of dissolution, oxidation, hydrolysis and acid hydrolysis. The

resistance of minerals to weathering depends on basic mineralogy and chemistry. The low temperature silicates, such as hornblende, are generally more stable than the high temperature phases such as olivine and the ferro-magnesian minerals; it is significant that most biologically important trace elements are found in appreciable amounts in the most readily weathered rocks.

Breakdown and re-deposition of the igneous rocks leads to the formation of the sedimentary sands, silts and clays, which by the process of humification (the incorporation of organic matter) eventually form soil. Of the earth's rocks, 95% are igneous and 5% are sedimentary, of which 80% are shales, 15% sandstones and 5% calcareous (West, 1981). The sedimentary rocks are more important agriculturally because although they only account for 15% of the crustal volume, they are spread over 75% of the earth's surface (Davies and Jones, 1988). Weathering of the primary igneous minerals breaks down the mineral lattice releasing elements such as iron, magnesium, zinc and manganese. The trace element content of the soil varies widely and is related to composition and environment; those formed from sandstones and other arenaceous sediments, which come from the most resistant igneous minerals, have a lower content of bio-essential elements, whilst higher levels are found in argillaceous shales, especially those associated with organic debris. Mobilisation of elements occurs in arable surface soils but only a very small proportion remain in solution in ionic forms which are highly available to plants. Hodgson et al. (1965) assessed soil solutions by water extraction and found elements to be below detection level by AAS. West (1979) also investigated the free ion solution levels in soils and found that copper was typically in the range 10^{-7} - 10^{-8} M, and manganese and zinc from 10^{-6} - 10^{-4} M.

Many cations, such as iron, magnesium, zinc and manganese are held incorporated within the layer lattices of the clay minerals, where they usually replace aluminium, becoming available to plants when released by ion exchange. The large negatively charged surface areas of the clay minerals have a high cation exchange capacity (defined by Stout and Overstreet (1950) as the maximum number of adsorbed ions held by a given weight of soil material) and are able to adsorb considerable amounts of elements. Although strongly held, these are potentially more available than those bound in crystal lattices which can only be released by further weathering. Aluminium, manganese and iron also tend to be occluded within precipitated oxides or bound within insoluble organic species and mineral lattices, where they are generally unavailable to plants but can replenish the soil by further weathering. Those trace elements locked in primary (and some secondary) minerals can only be utilised on a very long term basis.

Two of the major factors affecting the availability of trace elements within a soil are the redox potential (E_h) and the pH. The redox potential of a solution is a measure of its oxidising capacity (the ability to accept electrons from a reducing agent), or its reducing capacity (the ability to supply electrons to an oxidising agent). This is especially important for reactions involving first row transition metals such as manganese and iron which exist in different oxidation states within the normal range of conditions. In many surface environments E_h is mainly a function of the supply of gaseous / dissolved oxygen in relation to the amount of organic matter to be oxidised. If the supply of organic matter exceeds that of oxygen then reducing conditions occur, as are found in poorly drained acid soils and peat bogs. Conversely, in areas underlain by

porous sediments oxygen-carrying groundwater percolates downwards and oxidising conditions persist to a considerable depth. Redox reactions can influence chemical forms of environmentally significant trace metals in soils in two ways; firstly, directly through changing the oxidation state of the metal itself, and secondly, indirectly through changing the oxidation state of a different metal contained in the ligand that forms chemical bonds with the metal of consideration.

The pH of a solution is a measure of the hydrogen ion content (more commonly known as the acidity or alkalinity), and is important in controlling mineral dissolution and precipitation reactions of the major anionic species of the earth's crust. pH also affects processes such as ion exchange and complexing where the H^+ ion can participate in reactions; in low pH conditions there is a reduced exchange capacity for metal ions because the H^+ ions are not easily displaced.

Both E_h and pH are involved in the chemistry of many elements in the surface environment; for example -

(a) The precipitation of aqueous iron(III) ions as iron(III) oxide (haematite) is pH dependent :

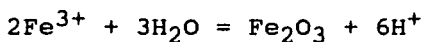

(b) The oxidation of aqueous iron(II) ions to iron(III) ions is E_h dependent



(c) The oxidation of aqueous iron(II) ions and their precipitation as iron(III) oxide is dependent on both E_h and pH :

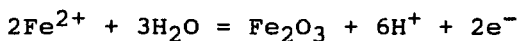

Soil wetness (and its associated redox effects) and pH are two factors which strongly influence the release of mineral elements to plants (Bjerre and Schierup, 1985). In gleyed soils with impeded drainage there is generally an increase in the amount of elements available, although this effect is reversed in strongly acid soils. The input of organic matter increases acidity and makes the soil less suitable for crops, hence the practice of liming to decrease the pH. An increase of pH of 1, within the range of pH 5-6 will halve the availability of most cationic trace elements, except copper which is scarcely affected, and molybdenum and selenium which actually increase (West, 1981).

Colloids and particles of secondary phases are also important in transporting metals in solution. In natural waters both organic and inorganic compounds can occur as colloids, which are very small particles, of $1 - 10^{-4}$ μm size. The most important properties of colloids are their surface charge and surface area, which is very large in relation to volume. The charges on different colloids vary in nature and magnitude; sulphide and organic colloids generally have a negative charge, whilst oxides and hydroxides carry a positive charge. However, the surface behaviour may be determined by a surface coating rather than the mineralogy, e.g. organic material coating iron oxide results in an overall negative rather than a positive charge. Ions are held on colloids by electrostatic forces which range from weak to strong depending on the surface charge characteristics of the colloid and the ion (divalent being more strongly held than univalent). The process of ion exchange is important in the transport and redistribution of elements and generally the attachment of adsorbed ions is sufficiently weak to enable their replacement by other ions.

Complexation is another important process by which elements become fixed on colloids, with one or more central atoms or ions, usually metal, being attached to several ligands (ions or molecules), the charge depending on the sum of the charges of the central atom and ligands. There is generally a correlation between the ionic potential of a metal ion and its ability to form complexes, with cations of small size and high charge, such as the 2^+ and 3^+ transition metal ions, forming many stable complexes, whilst the large alkali metal ions, (potassium and sodium) are poor complex formers (Plant and Raiswell, 1983). The ligands are generally molecules containing atoms of electronegative elements having an unshared pair of electrons (such as carbon, hydrogen, oxygen, sulphur or the halides). Molecules containing more than one atom capable of donating a pair of electrons are known as chelating agents, and include many biologically important natural organic compounds e.g. chlorophyll and haemoglobin. Within soils organic complexes, which are a complicated group of humic compounds, are of major importance in binding metals, especially those of the first row transition series. They have the capacity to complex considerable quantities of metal ions depending on the element concerned; manganese only forms weak bonds, but zinc and iron(II) complex more strongly, whilst copper and iron(III) form the strongest bonds of all the transition elements (Tinker, 1981). High molecular weight organic compounds, such as lignins, are essentially immobile and tend to immobilise elements associated with them (Hodgson, 1963). In addition, the functional groups of organics are often weak acids with configurations offering opportunity for chelation, and tend to bind metals very strongly. Due to this organic matter contributes significantly to the cation exchange

capacity of many soils. Whilst organic matter retains trace elements in the surface horizons of the soil this may be beneficial; Reaves and Berrow (1979) found that certain toxic elements, such as lead were also immobilised and thus prevented from polluting the soil.

The soil is a mix of many elements but the relative and total amounts form poor indicators of their respective biological importance. The total amount of iron is large, but the available fraction is much smaller; similarly, trace elements may be present in small quantities, but their biological effect is far out of proportion with their concentration (Kubota, 1983).

Obviously certain soil conditions will favour the presence of certain elements. The copper content of soils derived from basic rocks is greater than that of acid rock derived sediments by a factor of five (Reaves and Berrow, 1984). Higher levels are found in fine textured alkaline soils than coarse grained organics due the element being complexed by metal chelating humus. As Kiekens and Cottenie (1981) point out, this is one of the reasons that organic soils are generally poor sources of micronutrients; lack of clay minerals and hence of adsorption surfaces is a second cause of low levels. Copper may be deficient on newly prepared peat soils (due to fixing by organics) but since none of the soils examined in this series were peaty this effect was not observed. There is a decrease in the copper content of soils with increasing sand content, and its availability decreases as the soil dries out (Archer and Hodgson, 1987).

Iron in the soil is associated with primary minerals including the iron ores, biotitic micas and ferromagnesian silicates; free iron is predominantly in the form of oxides, or in the case of podsollic soils, associated with organic complexes (Hesse, 1971).

Compounds of iron are good indicators of drainage and weathering conditions, and are one of the primary causes of soil colour. Gleyed soils with poorly drained, reducing conditions are greenish grey due to iron(II) compounds, whilst calcareous soils have a yellowish colour due to iron(II) carbonates being oxidised to limonite. Iron levels are highest in "red" soils (whose colour is due to non-hydrated iron oxides), and least in leached sediments where the high pH restricts availability because the element is in the insoluble iron(III) form. Iron(II) (reduced state) is more readily available to plants than the iron(III) (oxidised) form. Excess manganese, zinc and copper can also induce apparent iron deficiency due to decreased availability.

Manganese is found in greater amounts in acid soils, being less prevalent in calcareous alkaline and organic sediments. This is because in acidic or anoxic conditions Mn(IV) and Mn(III) oxides and hydroxides are reduced to the more soluble manganous forms, and below pH 5.0 appreciable amounts of the element are brought into solution (Sims, 1986; Moore and Patrick, 1989). Manganese is frequently deficient in soils with a pH range of 6.5-8.0 due to being rendered insoluble, and a change from the oxidised to soluble forms of the element favoured by reducing soil conditions, compacted and / or waterlogged soils, and an abundance of acid organic matter. Mn(II) ions are released from manganese oxides by bacterial action and it is known that alternate waterlogging and draining of soils increases the availability of the element. Oxides of manganese commonly occur together with those of iron in nodules, iron pan and laterite (Hesse, 1971). There is also a strong interaction between iron and manganese uptake in wet conditions; Tanaka and Navasero (1966), working with rice, found that increasing levels of iron in

the growth medium decreased the manganese in the plants and vice versa. None of the soils examined in this series was especially wet or waterlogged and therefore this effect was not observed in the samples analysed.

Zinc is frequently associated with industrial pollution; in "clean" soils it is found in higher amounts in organic sediments (especially those from clays and palaeozoic shales), and becomes less available with increasing pH in alkaline basic or sandy layers. As pH increases zinc availability is reduced because the solubility of zinc ions decreases one hundred fold for each unit increase of pH (Lindsay, 1972). Increasing levels of magnesium and calcium cause a decrease in zinc uptake but this is due to interference between the chemically related ion species and probable competition at uptake sites rather than reduced amounts in the soil (Chaudry and Loneragan, 1972a). Excess copper can also induce zinc deficiency.

Calcium and magnesium, being macro-nutrients, are found in larger amounts in a wider range of soils and are not directly involved in redox reactions. However, both are less available in acid soils and higher in calcareous alkaline sediments. Low levels of calcium are associated with soils containing high proportions of dolomite or feldspar, and clays reduce the availability of exchangeable ions (Hesse, 1971). Magnesium occurs principally in clay minerals and the element is precipitated in alkaline soils. Its availability is also affected by ion antagonism, notably by potassium in acid, potassium-rich soils, or by high levels of calcium.

4.3. Experimental work with soil samples

Elemental extractions in soil, as with other materials, require the decomposition of the solid samples and the liberation of the analyte elements into solution. Elements that have an environmental impact are likely to be readily soluble and total extraction is accomplished by a strong mineral acid, giving results which are reproducible and easy to interpret (Thompson, 1983). However, the total amount of an element frequently bears little relation to the amount which is available to plants. For this reason selective extraction procedures are employed which dissolve that fraction of the analyte in a specific chemical form, and give results which are more related to environmental processes, such as uptake of elements by plants.

Unfortunately it was not possible to obtain soil samples from all the sites where modern grain was grown; altered ownership and land usage meant material could not be taken from Bristol, Dalton, Jardinefield, Oxford and Whitchester. Nickersons and PBI (both botanical research stations) could not definitely state where the grain they supplied had been grown, and had also changed fertiliser schedules in their growing plots, meaning that any soil supplied might not bear any resemblance to that where the spelt plant was grown, and it was therefore decided to omit soil testing from these sites.

In the fifteen sites where soil was available owners were asked to supply approximately 500g from the area where the crops were produced. This was taken from a depth of 9 - 12 inches after the surface soil had been scraped away; in this way it was hoped that unnecessary contamination from the upper layers could be avoided, and also that the material supplied would be the same as

that through which the roots had grown. Soil was posted to Durham sealed inside two polythene sample bags and was then stored at 4°C until required. Keeping the soil cool and dark reduced the likelihood of chemical and biological change and meant that analyses would correspond as closely as possible to the growing environment.

4.4. Experimental method

The method used for extraction of elements from grains was repeated for the total element extraction from the soils. Initial preparation consisted of spreading the soils out on large plastic trays and partially drying for twenty four hours at room temperature before passing through three nylon sieves of 4mm, 2mm and 1mm gauge to obtain a fine, uniform powder without large organic debris and stones. Whilst these latter materials are obviously part of the soil matrix it was thought that their inclusion would give false weights and results; for example, a sample containing stones would weigh more than a similar volume of soil material with stones removed, and hence the analyses would give apparently lower concentrations of elements. The soil was then air dried to constant weight prior to analytical work. Drying at raised temperatures in an oven causes profound changes in the soil chemistry and both Hesse (1971) and Baize (1988) recommend that this should be avoided. Five replicates of each soil sample were prepared weighing 0.5g each; these were pre-digested in 5ml 4M HNO₃ in exactly the same way as the cereal grains in order to reduce any "frothing" due to sudden rapid decomposition of organic material. The microwave programs used previously were also retained to give a totally comparable method, using an hour long period of digestion, split into three periods of twenty minutes each at 40%, 50% and 60% power. The pressure

increases for the grain samples all proved to be remarkably similar (see Chapter 3) but this was not the case with the soil samples. As seen in Fig. 4.1. the time taken to reach the maximum pressure of 80psi varied over a range of twenty to forty minutes. This was found to be related to organic content; samples with a higher percentage of organic material reaching maximum pressure in a shorter time than the more mineralised soils.

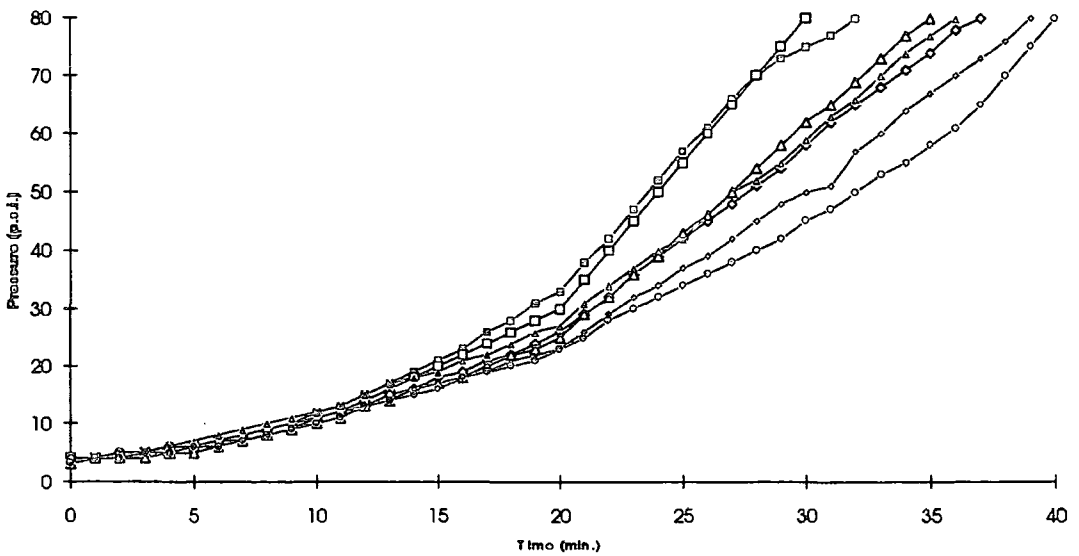

Fig. 4.1. Graph showing the pressure increases in the microwave decomposition of a series of soil digests.

At the end of the digestion period all vessels were found to contain a residue which settled out from the solution. Aliquots of 25ml were removed by pipette from the supernatant for elemental analysis by AAS. The values obtained for the different elements were converted to a concentration of metal per gram of soil by a specially designed computer program on "Microsoft Excel" as detailed in Chapter 3.

To check the efficacy of the digests twelve samples of the residue from different soils were retained by filtering, washed in 25ml Milli-Q water and re-digested in the same manner as the original samples; the resulting solutions were analysed and it was found that levels of elements were below detection limits by AAS.

The grain samples all reached maximum pressure at a more or less similar time, and hence had a broadly similar period at 80psi. The time at maximum pressure for the soil samples varied between twenty and thirty-two minutes, and it was thought that this could cause discrepancies and problems. However, when a sample from the soil which took longest to reach 80psi was re-digested no further elements could be extracted, and so it was assumed that a complete digest had taken place within the shorter time period. Whilst it may have been better to adjust the microwave programs to allow a set period at maximum pressure, it was decided that this was probably unnecessary. It may have been that a much shorter digest program could also have given complete digests, but this was not investigated owing to time constraints.

The extraction for available micronutrients in the soil was performed following the method described by Lindsay and Norvell (1979). Concentrations of copper, manganese, zinc and also iron were examined; the latter element although found in large quantities in total soil extractions is frequently found in unavailable forms, and therefore can be considered as a micronutrient in this case. The extractant solution was prepared immediately prior to usage by dissolving 14.92g TEA (triethanolamine), 1.97g DTPA (diethylene triamine penta-acetic acid) and 1.47g calcium chloride in 20ml distilled water. The resulting solution was diluted to 900ml and the pH adjusted to pH 7.3 with 6ml 1M HCl, after which the volume was

made up to one litre with Milli-Q water. Five replicates of each soil sample were prepared by weighing 10g of air dried soil into a polythene bottle and adding 20ml of extractant solution. The vessels were all agitated on a horizontal shaker for two hours to thoroughly mix the contents for an efficient extraction. The resultant suspensions were then filtered through No.42 ashless Whatman filters, and the solutions analysed by AAS as described above.

Measuring soil pH proved to be a more complex problem than initially imagined. If taken in the field the values will certainly change between a hot summers day and freezing temperatures of midwinter, and this may give rise to some inaccuracies. It is also possible that samples left in laboratories or poorly stored could alter their chemical composition hence affecting pH.

The pH of a solution is the negative logarithm of the hydrogen activity, i.e. $\text{pH} = -\log(\text{H}^+)$, where $(\text{H}^+) = \gamma[\text{H}^+]$, γ is the activity coefficient of H^+ , and $[\text{H}^+]$ is the concentration of the ion in solution in moles per litre. Because hydrogen is present in aqueous solutions as a cation the soil pH has to be considered in terms of exchangeable H^+ as well as solution H^+ , and it does not have the same precise meaning as given above for a solution. Because the pH value for a soil solution decreases through the diffuse layer close to a negatively charged particle, it may be more correct to think of soil pH as the pH of a solution in the pores of a moist soil.

The usual method of measurement of soil pH involves the preparation of a suspension of soil and water (at a ratio of 1g soil to 2.5ml water). The addition of water to the soil changes the concentration of H^+ in the soil solution, and in an acid soil this causes the pH to rise. However, if the soil has a negative charge, more divalent ions in the solution become adsorbed on dilution. H^+

is then desorbed from exchange surfaces to counteract the dilution by water, and this exchangeable H^+ becomes significant if the suspension is allowed to settle prior to measurement; the pH in the supernatant is higher (by about 0.2 pH units) than in the soil paste. To avoid dilution problems a dilute electrolyte solution (0.01M $CaCl_2$ or 0.1M KCl) can be used in preparation of suspensions so that the added cation displaces H^+ into solution thus counteracting the effect.

Although soil pH can have no precise value and is a somewhat arbitrary and ambiguous measurement (Hesse, 1971), a knowledge of its value is useful as an indicator of soil character. It can suggest levels of availability and mobility of cations, affects the way soil particles act as cation exchange centres, and determines which biological lifeforms are found. With regard to arable crop production the optimum pH is from 6.5-7.5 (Baize, 1988) and the majority of the soil samples examined fell within this range. The method utilised for sample testing followed that described by Rowell (1988), which involved mixing 10g soil with 25ml 0.01M $CaCl_2$ in a plastic beaker at 32°C. The vessels were placed on a horizontal shaker for thirty minutes to completely mix the materials, then allowed to stand until the solids settled out; the resulting supernatant was poured off into a clean universal bottle. The pH of the solution was measured using a meter previously calibrated on four buffer solutions of known pH (3,5,7 and 10). The results are given below in Figs.4.2. to 4.7.

4.5. Results

The results of all three analyses are shown on a single graph, plotting total and available elements and pH for each site.

Numerical values are given at Appendix 5. The concentration of elements in the soil varies considerably with very wide ranging values being seen in the total element extractions. The difference in the concentrations of total and available elements is also very large, the values for iron being particularly noteworthy with the available concentration being less than 20% of the total extractable concentration in all samples. The range for pH values was not as wide as expected; the most "alkaline" soil has a pH of 7.4 and the most "acid" of 4.1, with over 50% of the samples measuring between pH 6.0-6.5.

The results for copper are shown at Fig. 4.2. Most of the samples agree with the findings of Levesque and Mathur (1986) that 57% of the total soil copper is in non-extractable form; exceptions are found in the high results from Truro, Sheffield, and West Stow. Whilst the former is probably due to high natural levels of this element, the latter results might indicate some form of copper pollution rather than soil chemistry alone, since a high concentration was expected at Truro but not at the other two sites. The range of concentration values in the total extraction was from 28-188 $\mu\text{g g}^{-1}$ and from 6-115 $\mu\text{g g}^{-1}$ for the available. In both cases (total and available) the lowest values were found in the Castellau sample, whilst the highest were found in the Truro soil.

Analysis of the copper results using a statistical package in Microsoft "Excel" show a high correlation between available and total concentrations (the co-efficient of correlation = 0.97); soils with low total values also give the lowest available ones, moderate total values equate to moderate available values and high total to high available.

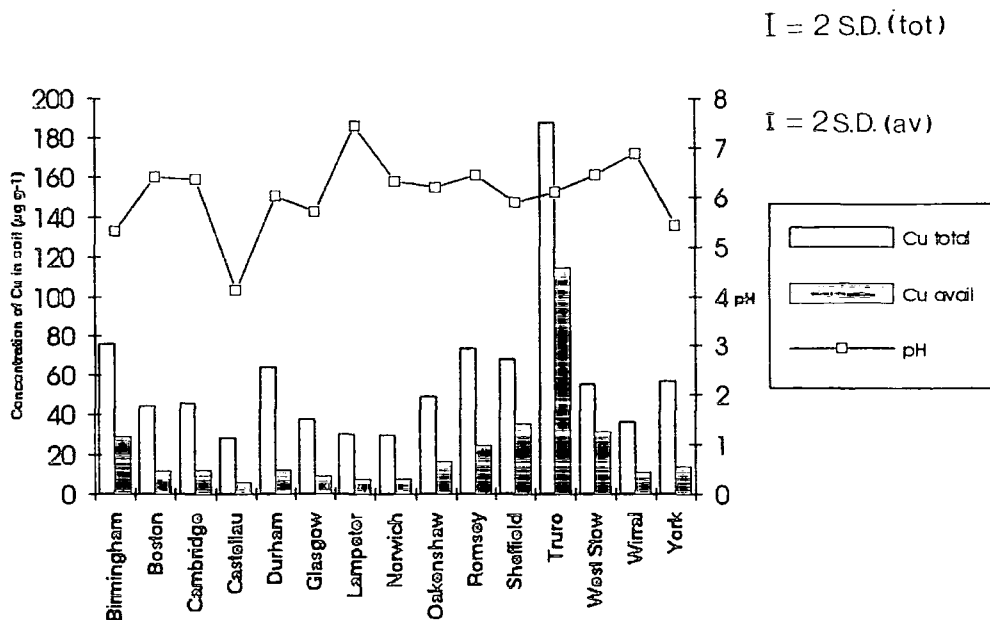

Fig. 4.2. Total and available copper concentrations in fifteen soil samples plotted against pH.

Mengel and Kirkby (1978) noted that the availability of copper decreases if the pH is less than 5.5 or greater than 6; in the samples analysed this is certainly true for the most acidic (Castellau, pH 4.1) and the most alkaline (Lampeter, pH 7.4) soils as both have very low concentrations of available copper. However, when the highest concentrations of available copper are examined, it is found that only in one sample (Sheffield, pH 5.9) is the pH within the range 5.5-6.0. The two other high measurements are found in the Birmingham and West Stow samples which have a pH of 5.3 and 6.5 respectively.

The results for iron are shown at Fig. 4.3. The concentration of total iron in the soil has a very large range of 728-3108 $\mu\text{g g}^{-1}$ whilst the values for available iron are from 70-228 $\mu\text{g g}^{-1}$. High total concentrations do not relate to high available values as seen previously with copper; in fact the correlation co-efficient has a negative value of -0.03 indicating only a weak relationship between

total and available values with a slight tendency of one value to decrease as the other increases. This is seen in the sample from West Stow which has one of the lowest total concentrations and one of the highest available values; the converse is true in the sample from Truro where a high total concentration gave a low available value.

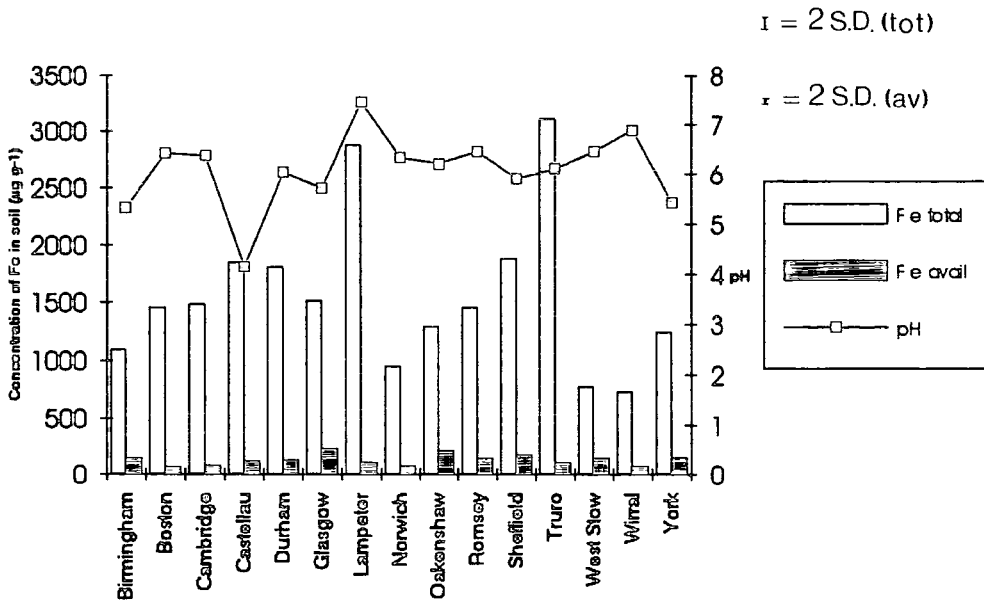

Fig.4.3. Total and available iron concentrations in fifteen soil samples plotted against pH.

There does not appear to be an obvious relationship between pH value and the concentration of available iron in the soil despite what other authors found (Harter, 1983; Sims, 1986). Possibly the range of pH is too small and it is only in more acidic and more alkaline soils that any effect is observed. Mengel and Kirkby found that availability decreases if the pH is less than 5 and greater than 7 but the lowest measured amounts of available iron in this series are in samples from Boston (pH 6.4), Cambridge (6.4), Norwich (6.3) and Wirral (6.9). However the highest

concentrations are found in samples which correspond well to the range suggested by these authors: Glasgow (pH 5.7), Oakenshaw (6.2) and Sheffield (5.9).

Manganese results are plotted at Fig. 4.4. The total concentrations range from 172-962 $\mu\text{g g}^{-1}$, and available values from 6-191 $\mu\text{g g}^{-1}$. The highest total value is found in soil from Truro and this is almost certainly again related to mining pollution, although this is not reflected in the low available manganese concentrations in the same sample. There is a weak correlation between total and available manganese concentrations (co-efficient = 0.26), with higher values of the former relating to higher values of the latter.

Available soil manganese levels are supposedly highest in strongly acid or alkaline samples with a decrease in availability between pH 5.5 and 8.75 (Mengel and Kirkby, 1978). Certainly there are some very low measurements of available manganese concentrations within this range in the series analysed, notably Norwich, Truro, West Stow and Wirral. The only sample to fall outside the above range is that from Castellau (pH 4.1) but the concentration in this soil is lower than those measured in samples from Cambridge and Sheffield, which have a pH of 6.4 and 5.9 respectively.

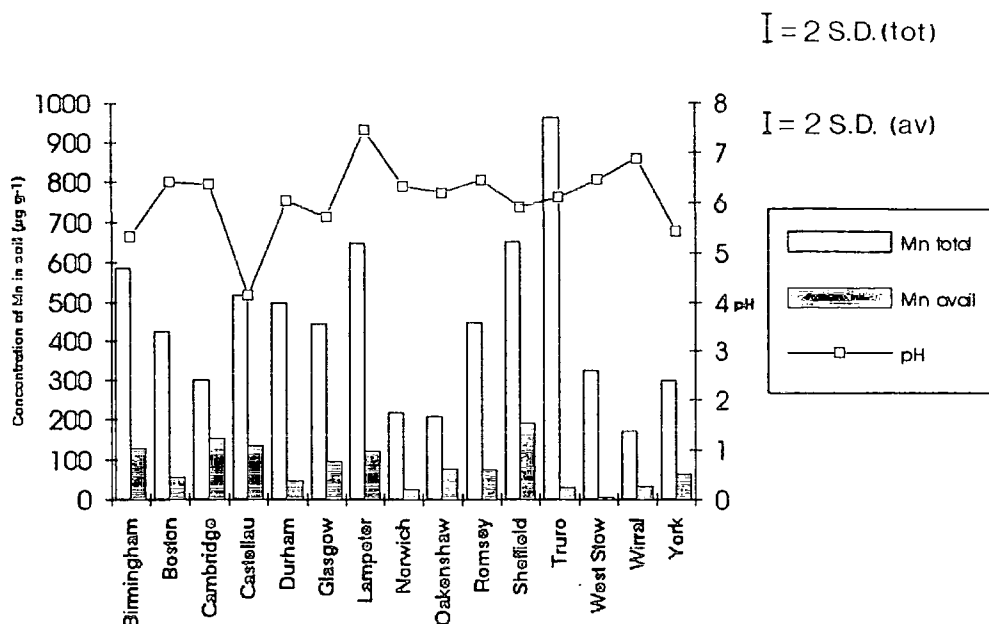

Fig.4.4. Total and available manganese concentrations in fifteen soil samples plotted against pH.

Zinc results are shown at Fig. 4.5. The total soil concentration values range from 58-348 $\mu\text{g g}^{-1}$, and the available from 8-170 $\mu\text{g g}^{-1}$. The highest total concentration is perhaps rather surprisingly found in the soil sample from Romsey rather than that from Truro as this element is frequently associated with mining pollution. The lowest total and lowest available values are both found in the sample from Boston. The correlation between total and available soil zinc is high (co-efficient = 0.79), but yet again there is no obvious relationship between pH and elemental values and the lowest and highest pH values are both associated with intermediate concentrations. Mengel and Kirkby (1978) state that available zinc is highest in slightly acid soils (pH circa 6.0), and Grant and Bailey (1989) that zinc availability decreases as pH increases. Within this series the soil with the highest pH (Lampeter, 7.4) has one of the lowest available zinc concentrations,

whilst the highest concentrations are found in samples from Norwich, Romsey, Truro and West Stow (all pH 6.0-6.5).

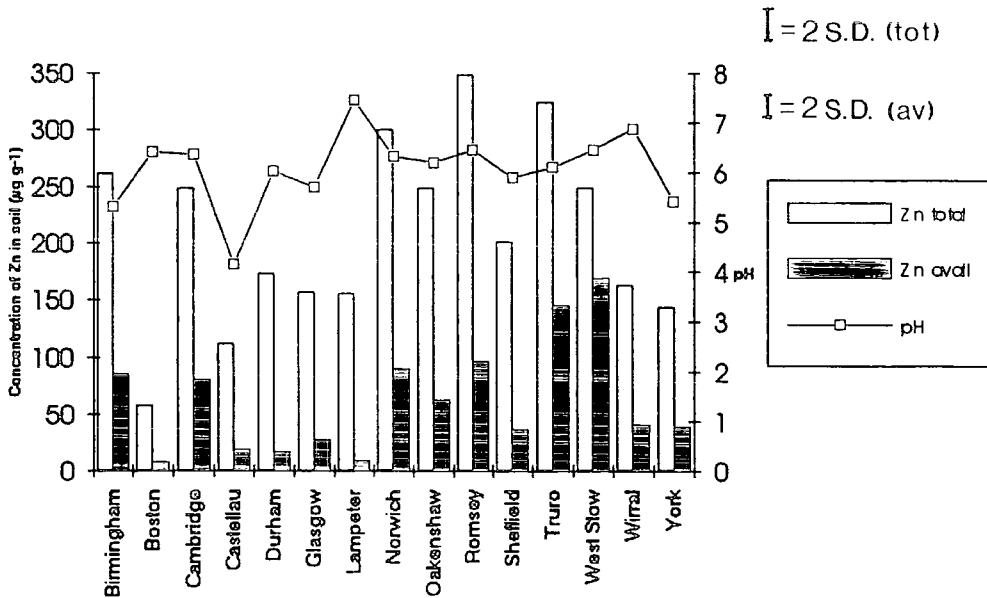

Fig.4.5. Total and available zinc concentrations in fifteen soil samples plotted against pH.

A similar lack of relationship is demonstrated when pH values and concentrations for calcium and magnesium are examined (Figs. 4.6. and 4.7.). The lowest concentration of calcium is found in the Castellau sample which does have the lowest pH (4.1) of the soils analysed, but the highest concentrations (Boston and Cambridge) are in soils with a pH of 6.4 (which is not the highest measured). This is also the case with magnesium where the highest analysed concentration values are in the Boston, Truro and West Stow soils (pH 6.1-6.5).

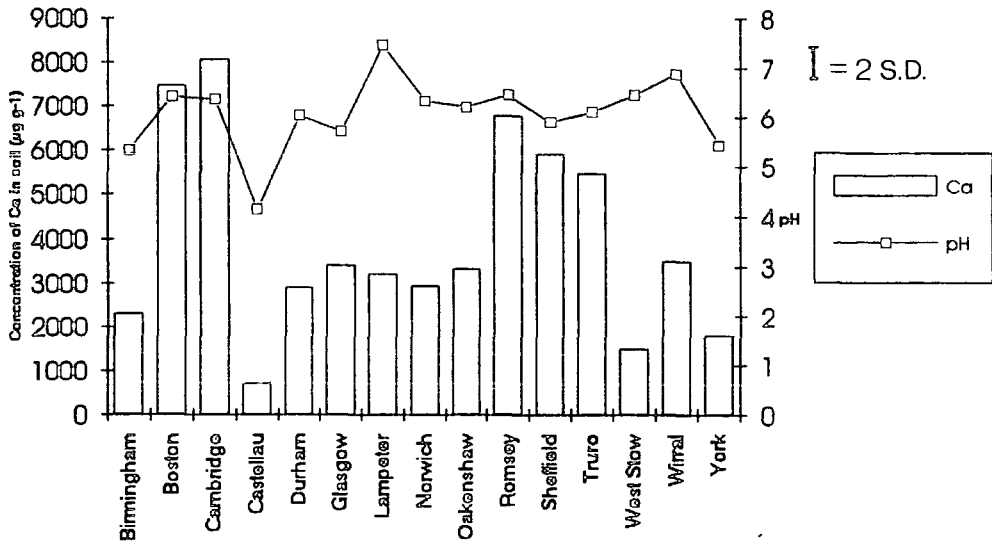

Fig.4.6. Total calcium concentration in fifteen soil samples plotted against pH.

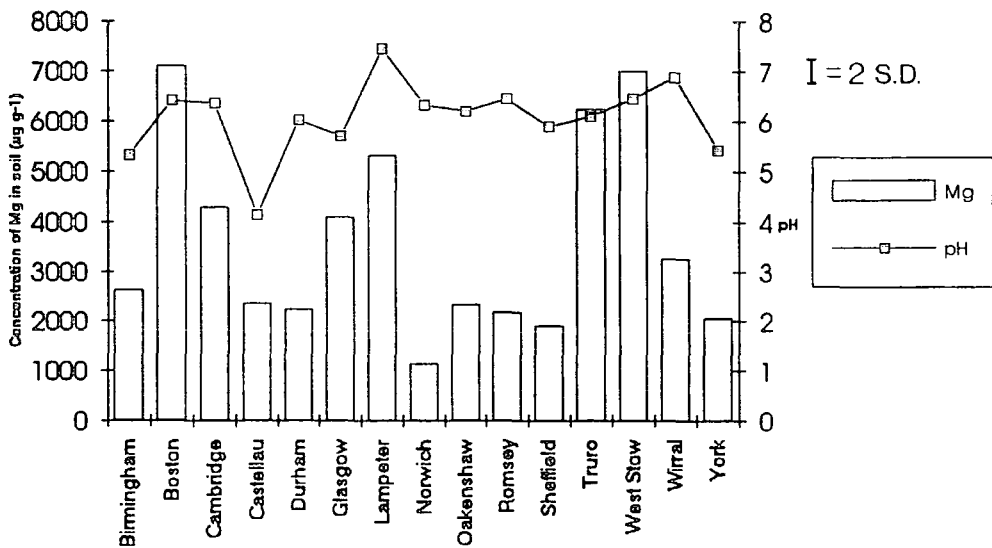

Fig.4.7. Total magnesium concentration in fifteen soil samples plotted against pH.

If the mean concentrations of the four micronutrients are graphed together as a total concentration it is obvious that great differences exist between the soil samples. The lowest total value

is found in the Wirral soil (see Fig. 4.8.) which is unsurprising as the sample from this plot was almost pure sand. Low total micronutrient concentrations are also seen in the West Stow and Norwich soil samples. The highest total concentration was found in the Truro sample; most probably the high levels of manganese and zinc are associated with the Cornish mining industry but iron forms the major part of this total. All the samples reflect the high concentrations of total soil iron (and likewise low copper).

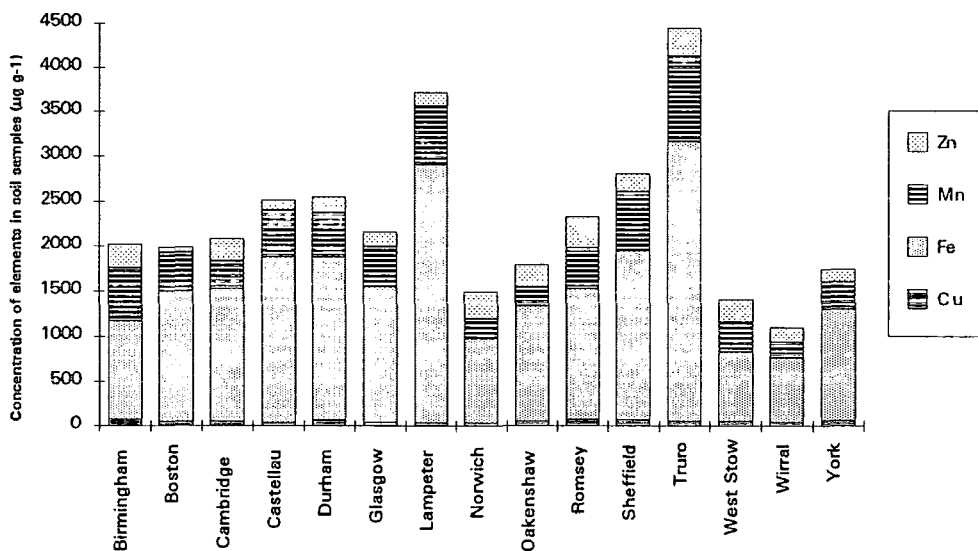

Fig.4.8. Concentrations of the four micronutrients as measured in total elemental extractions of fifteen soil samples.

This is also demonstrated when the values are presented as percentages of a whole for each sample (see Fig. 4.9.). Iron accounts for more than 50%, whilst copper is below 5% in all samples. Manganese forms the larger percentage of the remaining two micronutrients being above 20% in nine samples. Zinc is only found in larger concentrations in two samples and this is reflected in the fact that this element is only above 10% of the total in seven samples.

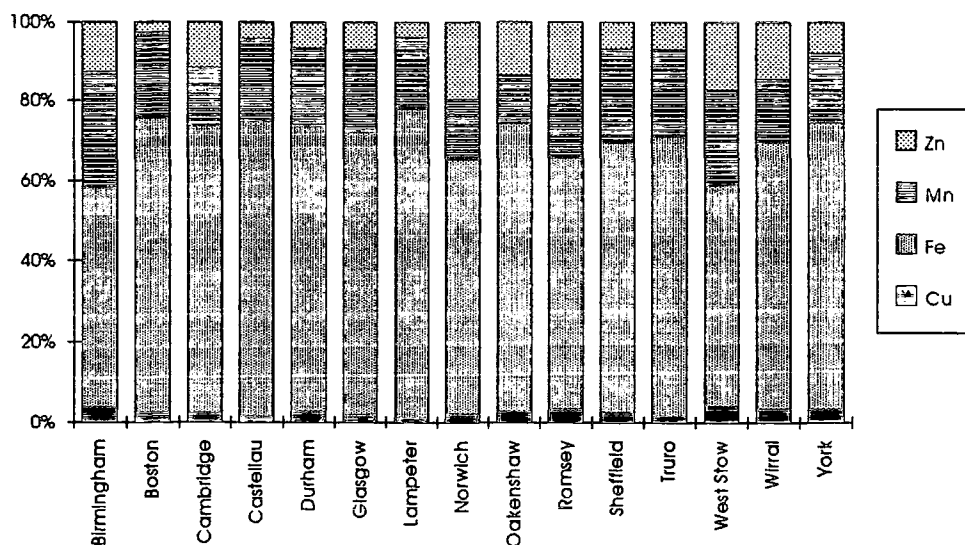

Fig. 4.9. The same values as shown in Fig. 4.8. presented as percentages of a whole (total element extraction).

When the values for the total macronutrient extractions are examined (see Fig. 4.10.) comparatively small total concentrations of total calcium and magnesium are found in the Castellau, Norwich and York samples. Norwich also has a low total concentration of micronutrients (see Fig. 4.8.) perhaps suggesting this soil is relatively "demineralised". High total concentrations of the macronutrients are found in the soils from Boston, Cambridge and Truro.

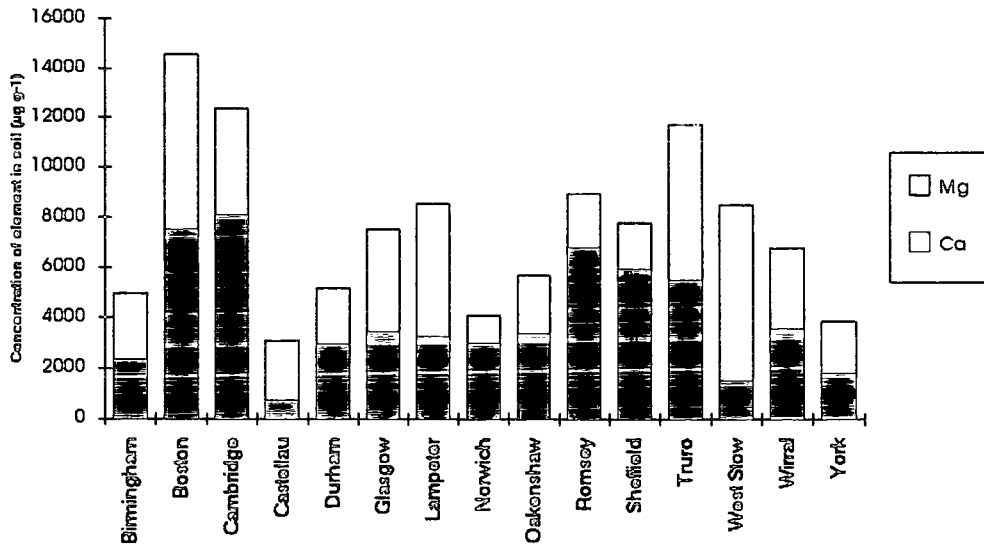

Fig. 4.10. Total concentrations of the macronutrient elements in fifteen soil samples.

When the values for the total macronutrients are presented as percentages of a whole sample (see Fig. 4.11.) it is apparent that neither element is always present in higher concentrations. Of the fifteen samples analysed seven have a higher percentage of magnesium and eight of calcium (although of these three are only slightly greater than 50%). Low total magnesium concentrations (25% or less) are found in the samples from Norwich, Romsey and Sheffield, whilst low total calcium was measured in the Castellau and West Stow soils.

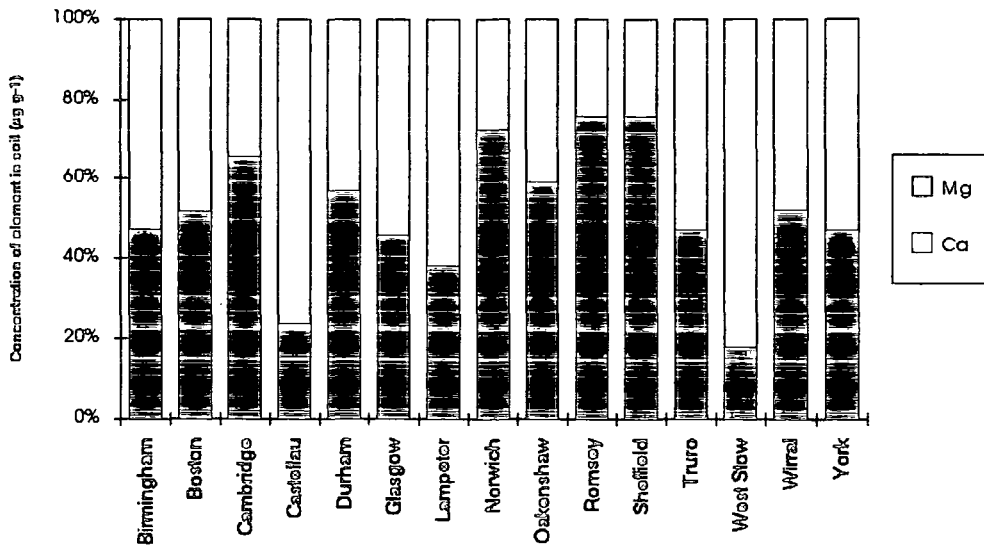

Fig. 4.11. The same values as shown in Fig. 4.10. presented as percentages of a whole.

When the mean values for the available element concentrations are presented as total concentrations for each sample the picture is radically different (see Fig. 4.12.). The Wirral sample has a comparatively low total concentration of available micronutrients (reflecting the fact that soils derived from sandstone have low levels of both total and available elements) but the sample from Boston has an even lower value. Why this should be so is unclear; the pH of the Boston sample was in the mid-range of those measured (6.4) and other soils of similar pH have much higher concentrations of available elements (e.g. Romsey and West Stow which both have a pH value of 6.5). Likewise, other soils which have very similar concentrations from the total micronutrient extraction, such as Glasgow (which, zinc apart, is almost identical), again have higher available element concentrations. The comparatively high levels of soil magnesium and calcium found in the Boston sample may have an effect on the available micronutrients, although if this

were the case it could be expected that the micronutrient concentrations in the Cambridge and Truro would be lower.

Higher concentrations of the available micronutrients are found in the soils from Birmingham, Sheffield and Truro; the latter is not unexpected but the Birmingham sample has a comparatively low value for the concentrations from the total extraction, which is only marginally higher than the total concentration found in the Boston sample. Two other samples (Romsey and West Stow) also demonstrate that low concentrations in the total elements can give high values for the available elements. Again the reason for this is not immediately apparent and pH value does not seem to be a relevant factor.

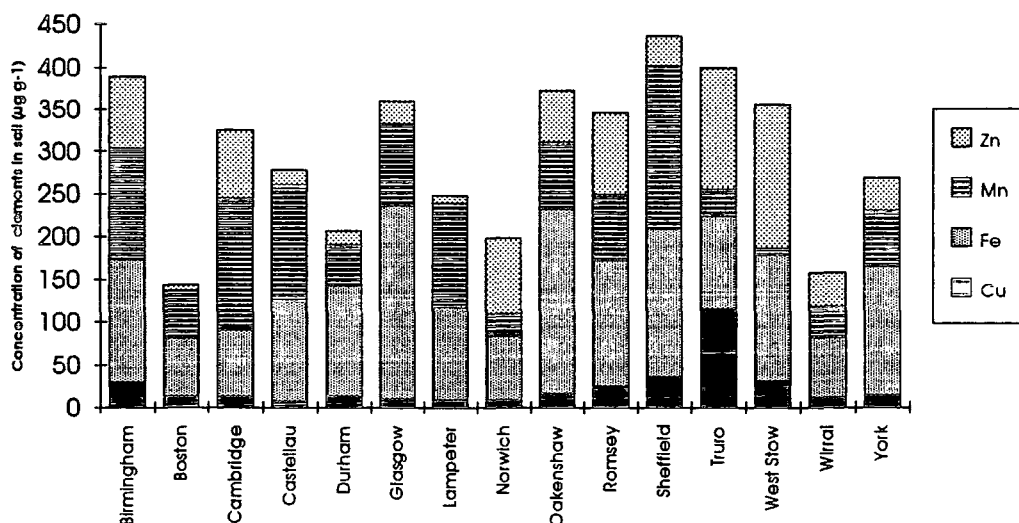

Fig.4.12. Concentrations of the four micronutrients as measured in available elemental extractions of fifteen soil samples.

Differences in individual elements can also be seen. For instance, although the values for the concentration of copper in the samples have actually decreased (when compared to the results from

the total element extraction) they form a greater part of the total available elements. The proportions of manganese and zinc are similarly increased (see Fig. 4.13.). The values for total soil iron concentrations are much greater than the available and iron forms a significantly smaller part of the available total, and this is clearly seen when the values are presented as percentages of a whole sample.

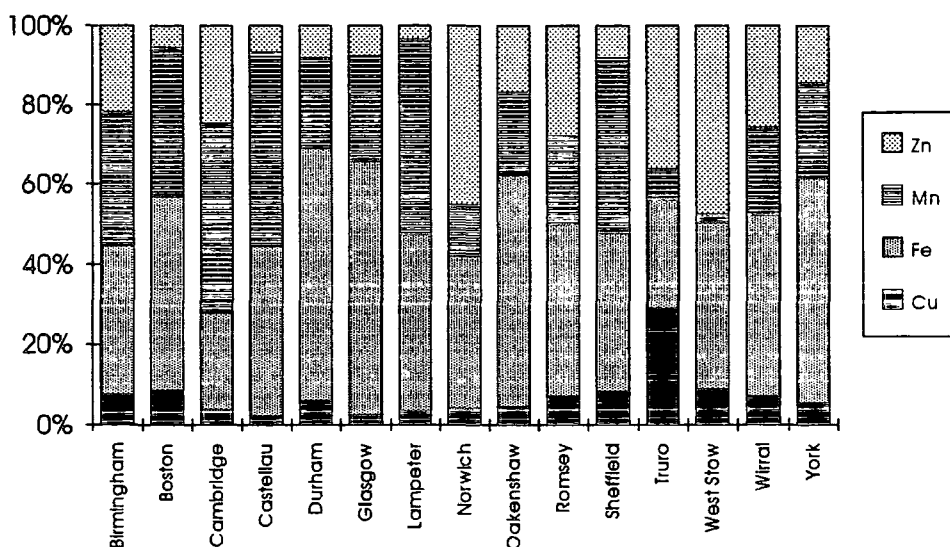

Fig. 4.13. The same values as shown in Fig. 4.12. presented as percentages of the whole (available element extraction).

When considering the relationships between the available elements in the soil and those in the grain two sets of results are examined; firstly, the concentrations of elements in the soil and the fresh grain, and secondly, the concentrations in the soil and the charred grain (as calculated from the charred weight of the grain, i.e. the highest concentration examined in the experiments in Chapter 3). The numerical values used in these calculations are given at Appendix 6.

When the results for copper are examined (see Fig. 4.14.) two distinct peaks are evident: that for available copper in the Truro soil sample and that of the charred grain from Castellau. The former is almost certainly associated with soil pollution, and as noted in Chapter 3, the latter must be due to contamination at some stage of the extraction or analysis procedure. The correlation coefficient of the concentrations of available copper in the soil and in the fresh grain is 0.54. This value is reduced to 0.16 when available copper is correlated to the concentration in charred grain. However if the Castellau results are ignored this figure increases to 0.46 which may be a more accurate reflection of the relationship between charred grain and available copper concentrations. Although not presented in graphed form the correlations between total copper concentrations in the soil and those in fresh and charred grain were also calculated. These values were also moderately high being 0.48 with fresh grain and 0.39 for charred (rising to 0.49 when the Castellau results are ignored). This is presumably a reflection on the fact the the correlation between total and available copper concentrations is high (0.97).

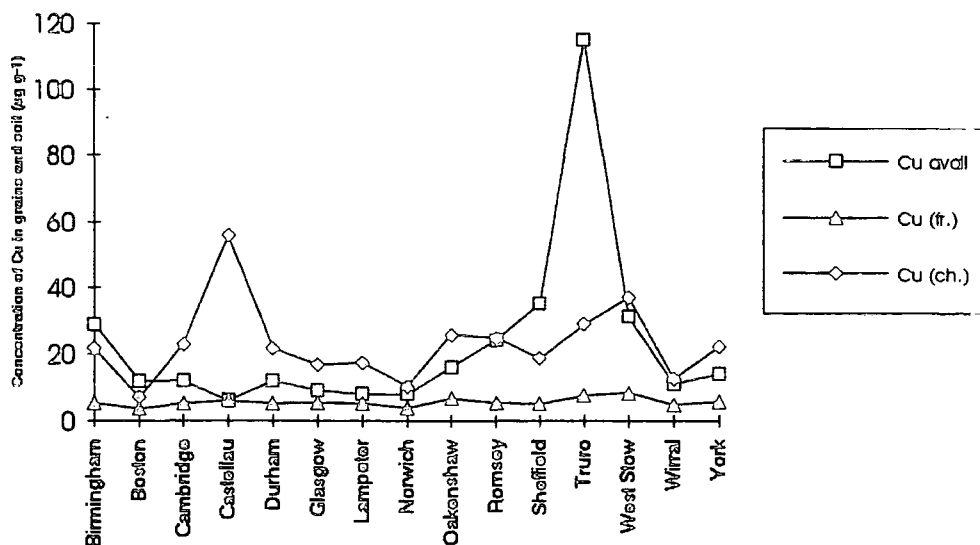

Fig. 4.14. Graph showing the relationship between copper concentrations in fifteen grain samples (fresh and charred) and the available copper concentration in the soil where they were grown.

The results for iron are shown at Fig. 4.15. Variation between the concentrations of iron in the charred grain is much greater than in the fresh (ranging from 186-265 $\mu\text{g g}^{-1}$ as opposed to 23-50 $\mu\text{g g}^{-1}$ in the latter) and this is associated with the relationships to the available soil iron. As can be seen in the graph the charred grain and available iron lines follow a much closer pattern and the correlation value is 0.52; the value for fresh grain is 0.36 indicating a weaker relationship.

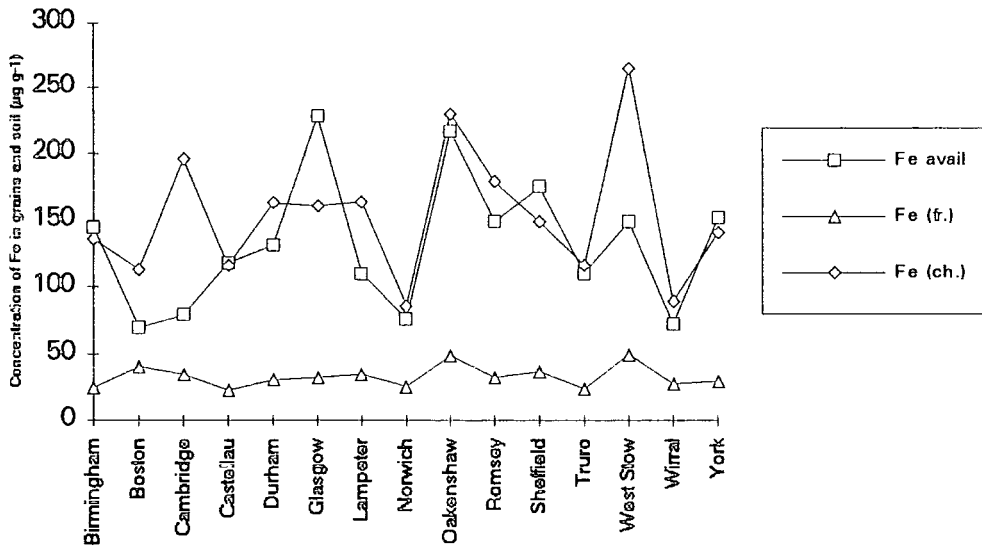

Fig. 4.15. Graph showing the relationship between iron concentrations in grains from fifteen sites (fresh and charred) and the available iron in the soil where they were grown.

The correlation values between total soil iron concentration and those of fresh and charred grain are even lower, being -0.24 and -0.12 respectively, indicating a slight tendency of one value to increase as the other decreases or vice versa. As with copper, these results reflect the relationship between total and available elements in the soil which in the case of iron is very weak; the correlation co-efficient is -0.03 and therefore not significant.

It is interesting to note that significantly lower levels of available iron do not give greatly reduced concentrations of iron in fresh grain. This can perhaps be related to the work of Romheld (1987) who found that plants have evolved adaptive mechanisms to mobilise iron at the root-soil interface (the rhizosphere). Mechanisms associated with this include increasing the solubility of iron to enhance its availability to the plant. This is done by (a) enhancing the reduction of Fe(III) to Fe(II), (b) lowering the

rhizosphere pH which favours the formation of Fe(II), and (c) the solubilizing of sparingly soluble inorganic Fe(III) compounds by plant produced chelating agents. These latter are known as phytosiderophores and their release from the plant is stimulated by the onset of iron shortages. Chemically they are non-proteinaceous amino acids and they are highly selective not recognizing either synthetic or microbial iron chelates (Romheld and Marschner, 1986). If iron is limited then one or more of these processes can be activated but the adaptive mechanisms are suppressed when the iron requirement of the plant is satisfied (this avoids toxicity in the plant due to excessive iron uptake).

The results for manganese (see Fig. 4.16.) show extremely disparate and wide ranging values which are reflected in the very low correlations found in both fresh and charred grains (-0.06 for the former and 0.08 for the latter when correlated against the available soil manganese).

Similarly low correlations are obtained when the total elemental concentrations are considered, with values of -0.29 for fresh grain / total soil manganese, and -0.23 for charred material.

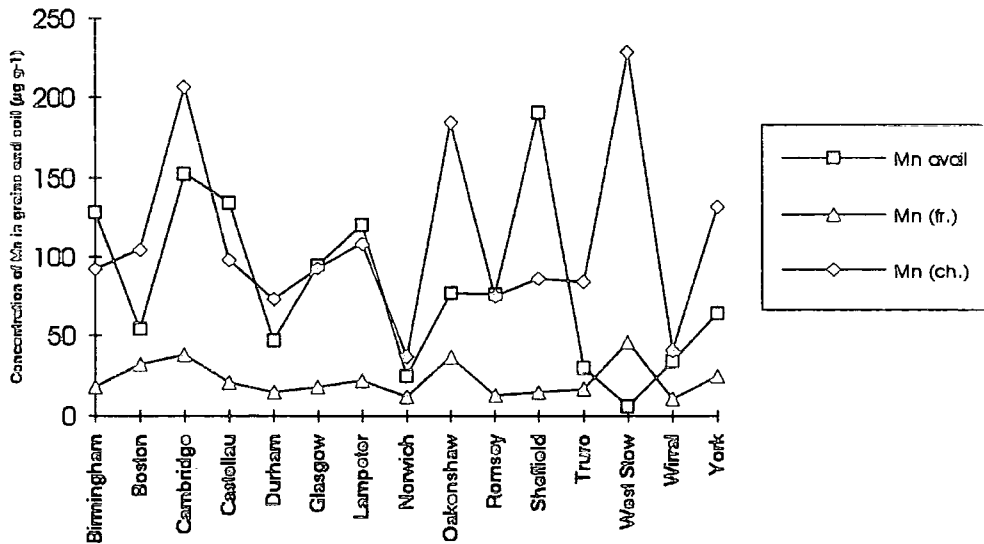

Fig. 4.16. Graph showing relationships between the concentrations of manganese in grains from fifteen sites (fresh and charred) and the available concentration in the soil.

The zinc results (see Fig. 4.17) are somewhat anomalous to this series in that the higher correlations are obtained using the total soil concentrations with values of 0.50 (total zinc / fresh grain) and 0.56 (total zinc / charred grain). The correlation values calculated for available zinc and grain are reduced being 0.24 (fresh grain) and 0.39 (charred grain) respectively.

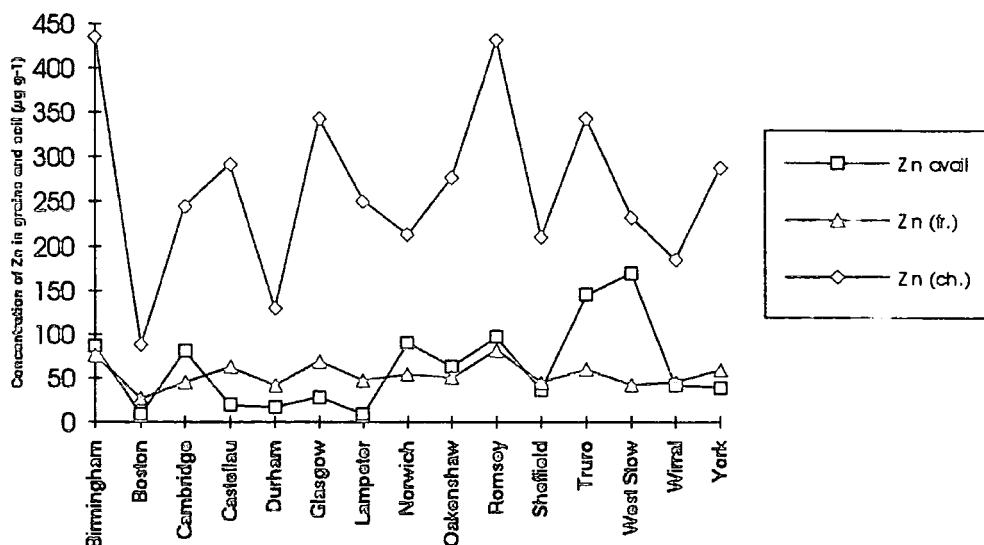

Fig. 4.17. Graph to show the relationship between zinc concentrations in grains from fifteen different sites (fresh and charred) and the available zinc in the soil where they were grown.

This is rather an unexpected result because the correlation between total and available zinc concentrations in the soil is relatively high (0.79). It appeared from the copper results that where there is a strong correlation between the total and available soil elemental concentrations the correlations values for the grain/available element and grain/total element concentrations would be closer (and vice versa where there was little correlation between the total and available elemental concentrations as seen in iron and manganese).

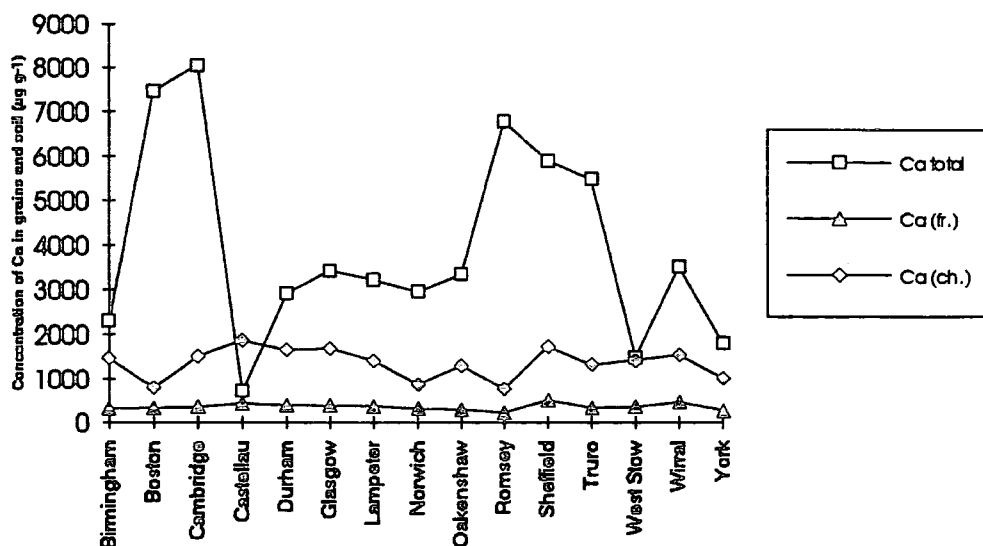

Fig. 4.18. Graph to show the relationship between total soil calcium and calcium concentrations in fresh and charred grains at fifteen sites.

The results for calcium (see Fig. 4.18.) show a higher correlation between the charred grain / total soil calcium concentrations (-0.33) than the fresh grain / total soil calcium (-0.1). With magnesium the converse is true and the correlation between fresh grain / total soil magnesium concentration (0.43) is considerably higher than the charred grain / total soil magnesium (0.06) (see Fig. 4.19.).

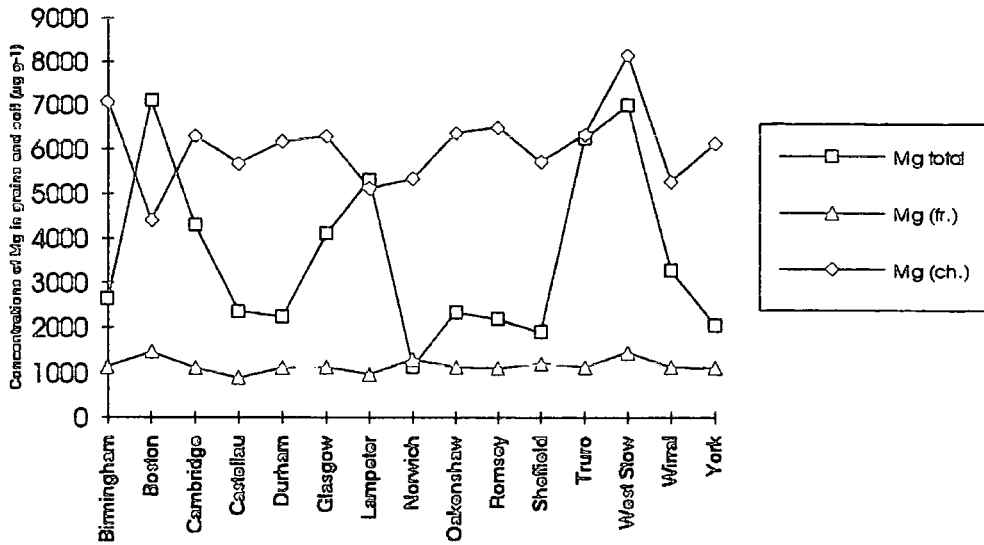

Fig. 4.19. Graph to show the relationship between total soil magnesium and magnesium concentration in fresh and charred grains from fifteen sites.

4.6. Conclusions

Total and available micronutrient extractions (copper, iron, manganese and zinc) plus the total macronutrient extractions (calcium and magnesium) show that the soils examined contain a wide concentration range of the elements. The difference between the total and available concentrations of the micronutrients is very marked and demonstrated by Figs. 4.8. and 4.12.

Correlations between elemental concentrations in charred and fresh grain and the concentrations of available elements in the soils were examined. Those values for copper (0.54) and iron (0.52) in charred grain were found to be significant (at $p = 0.05$, or one to twenty). Of the correlations between total elemental concentrations in the soils and those in the grains, those of zinc in both fresh (0.56) and charred grain (0.5) were significant (at the same degree i.e. 1:20). Obviously the small size of the sample

must preclude any real conclusions about relationships between the elements in the soil and grain. If the series were enlarged and many more samples analysed then it might be possible to say whether the correlations above were "real" values or only due to the samples being "closely related" without any wide variety of distinction. For example, analyses of grains and soils from a very peaty or strongly calcareous environment might produce results which would render the above correlations completely meaningless.

The pH of the soils was also analysed; unfortunately the range measured was small and did not include either strongly acid or alkaline soils. Whilst either of these would undoubtedly change the patterns of elemental availability it is probable that neither type would produce a good crop of spelt. The best agricultural soils are of neutral and slightly acid pH, whilst crops can be grown on marginal land farmers do not use soils at the extremes of the range without a lot of chemical assistance.

In conclusion, although these experiments have not shown that there is an unambiguous relationship between all the elements present in the grain and those of the soil, grains grown on different soil types do have different concentrations and proportions of those elements. Since the plant species is the same and the climate not so widely dissimilar throughout Britain as to cause major changes in elemental uptake, the soil is the one remaining variable which must have a dominant effect on the biochemistry of the plant. It may be that a much larger suite of elements needs to be analysed, including some of those present in very small amounts (which were below the detection limit of machinery available in this project), before the precise nature of the elemental relationship between plant and soil is revealed.

CHAPTER 5
INFLUENCE OF ENVIRONMENT &
GENETIC FACTORS

My crop of corn is but a field of tares.
Tichborne.

5.1. Introduction

When considering analysis of grain from differing localities there is also the problem of precisely which factors have an effect on uptake of elements. It is known that different cultivars of cereals accumulate ions in varying proportions (Boken, 1970; Erdman and Moul, 1982; Perby and Jensen, 1986): what is of interest here (and on which no work appears to have been done) is whether seeds from the same cultivar produced on different soils and then grown to harvest on another soil type will produce grains which have the same elemental proportions as the grain producing the parent plant (i.e. genetically determined), or have a completely different elemental pattern (i.e. environmentally determined). At present it is still unclear to what extent the proportions of elements present are due to genetic or environmental factors. If the genetic input is the more important, then the elements present in the grain relate more to the seed and soil from which the parent generation originated; if the environment is the stronger factor then the elements will relate principally to the soil producing the seed of the F1 generation (i.e. the grains that were analysed). This matter is of some importance in analysis of both modern and archaeological grain. In the latter case, it is not improbable that at least some of the

grain used by the Romans on Hadrian's Wall was locally grown, possibly on military land around the forts (J.P.Huntley, pers.comm.). If the uptake of elements into the grain is genetically controlled and the seed for sowing was imported, then analysis of the resultant harvest would relate more to the growing environment of the parent plant (which could be in another area of England, Wales, or even Gaul), meaning that grain grown up locally would not be detectable as such.

Grains of spelt for planting in van der Veen's experimental plots were initially supplied by Reynolds from harvested crops at Butser Ancient Farm; these were then grown up on various sites and the harvested grain replanted to produce the crop of the following year. All grain analysed for the modern data set in this research came specifically from the second harvest on each plot for two important reasons: (a) by using grains from the first harvest to grow up plants producing the next generation one can assess elemental uptake in the analysed (second harvest) grains and attempt to relate it to a known environment and soil; and (b) if grains from harvests of different years are used there is the possibility that environmental factors such as a particularly hot or wet summer might affect elemental uptake. Whilst it is obvious that weather conditions can vary from site to site in a single year, the selection of grains from one specific harvest must reduce the chances of major differences.

Work by various authors (Grant and Bailey, 1989; Mathur et al., 1989; Petelkau and Dannowski, 1990) has suggested that the environment plays a more significant part in the elemental uptake. This is perhaps only to be expected; farmers have long recognised

that particular soils produce especially good harvests and there are a number of classical references which discuss this matter:

Now for the characters of various soil,
Their strength, their colour and their qualities
For bearing produce.

Earth that is black and, when you drive your share in,
Looks rich, and crumbly soil (the aim of ploughing)
Is mainly best for corn.

Virgil, Georgics II, 177-178, 203-205

More recently the "trace element deserts" in parts of Australia have been transformed to productive land through fertilisation with copper, zinc and molybdenum (Anderson and Underwood, 1959). Obviously the success of crop production relates strongly to the geochemical environment and one might assume that the soil plays the more vital role in elemental uptake. To confirm this experiments were performed to assess the degree of change in elemental suites for grains from different areas when grown up to harvest on a new soil type.

5.2. Experimental method

The aim of the experiment was to grow grain produced at various different sites in Britain up to harvest on one soil from Durham (which would therefore be different from that of the original site where the parent plant was grown). Grains produced from these plants would then be analysed and differences or similarities in elemental uptake assessed.

Samples of grains from eleven different sites were selected, these being Birmingham, Boston, Bristol, Cambridge, Castellau, Lampeter, Romsey, Sheffield, Truro, Wirral and York. The initial

choice of these sites was made on account of two points: (a) the original digests and analyses had shown a wide range of concentration values for the six elements which might be expected to show a significant degree of change, and (b) it was possible to obtain enough grain from a single harvest (1989) from these sites to allow repetition of this experiment over three years. This was felt to be important because climatic factors such as high rainfall levels might enhance or reduce certain element values giving a false impression; repeating the growing up and harvesting gives more consistent results and helps pinpoint abnormalities.

There were problems in finding a suitable growing site, and also in obtaining a harvest. Unfortunately, the University Botanical Gardens in Durham do not have land available for experimental plots; space was available in the greenhouse but it was felt that this did not mirror the field environment. The constant (higher) temperature, increased humidity and strong lighting leads to a shorter growing season which in turn could result in a reduced period for uptake of elements into the grain, and hence possibly to lower values in the analyses (although it is equally possible that a shorter but more active period might lead to the same or even an increased uptake). Duffus and Rosie (1976) working with barley grain found that iron and zinc are accumulated rapidly whilst levels of manganese and copper increase more slowly. Linehan et al (1989) also noted that increasing soil temperature influenced the extent and pattern of micronutrient mobilisation, reaching a maximum in the field in July. It was therefore decided to grow the grain in individual large plastic pots (height: 40cm.; diameter: 50cm.) filled with soil supplied from the Botanical Gardens from an area not utilised for regular growing i.e. one which had not been

fertilised or treated in any way. Obviously this is not an exactly similar environment to being field grown; it was realised that root branching might be impeded and that the flow of water through the pot was not like that in the ground. However as the only alternative was a very windy plot at 425m above sea level, beside an expanse of heather moorland it was felt that the plants stood more chance of producing a harvest in Durham. Fresh soil samples were supplied each year as it was felt that meaningful results would not be obtained using the same, and hence more elementally depleted, soil for subsequent growing season.

The spelt grains were removed from the ears and planted as naked seed in November, being buried under approximately 10cm of soil at a density of one hundred grains per pot. No fertilisers, chemical or otherwise were added at any stage of the growing.

Initially the pots stood close to the laboratory in a "pollution free environment" - no cars can drive near the area and it is secluded from the general university population. The pots were also open to watering by rainfall; whilst it is accepted that some pollutants can be carried in air and rain it was felt that since plants in the field are watered in this way it would create a less meaningful environment if only chemically "pure" water was used, and such pollution is unlikely to import significant amounts of the elements under analysis in this area. However, the peace and seclusion led to a major problem which almost concluded the experiment. By mid-May the plants had produced shoots of about 40cm. height which were growing successfully. Examination of the plants after one particular weekend revealed that in seven of the pots the shoots had been virtually reduced to soil level, having been eaten by a young rabbit (living very comfortably in a nearby heating

duct!). Alternatives at this stage were to replant the pots with fresh grain (giving a much reduced growing season in a soil which may have been significantly depleted of nutrient elements by the previous growth), or to allow the damaged plants to re-grow. Discussion with Dr.P.Gates (Dept. of Botany) suggested the latter to be the better option; in the Middle East if crops are damaged, or the early part of the growing season is particularly poor climatically, the plants are cut back and allowed to start growing when conditions have improved. This leads to a better final harvest than if the plant is allowed to continue growing in a poor physical or nutritional state. In order to gain totally comparable results the plants in the remaining pots were also cut back to the same extent. Protection against the rabbit was provided in the form of fencing placed around the pots, but further problems ensued. Despite the area receiving at least seven hours of direct sunlight per day this was not enough to prevent serious aetiolation of the plants, which were in addition then attacked by rust (despite Percival's claim (1921) that spelt is not prone to this disease). A more open space was required and at this stage the pots were transferred to the Botanical Gardens, to an area behind the greenhouses normally used for transplanting of seedlings.

All of the pots produced a harvest which was collected in late August and early September, although the yield was unspectacular. It had been hoped initially to collect enough grains from each pot to allow analysis of the requisite five samples and to have sufficient remaining to plant and grow up to produce an F2 generation. However, this being impossible grains were taken from the same harvest at the original site and grown in the same way in the following two years.

Given the problems of the first year it might have been expected that all would proceed smoothly afterwards; unfortunately this was not to be. The fencing around the pots protected the plants from the rabbit population, but not the mice, and traps and a smaller gauge of wire had to be utilised. Later in the year the top of the fencing provided a perfect perch for birds to raid the ears of spelt, again reducing the harvest. In the final year a net covering prevented this and allowed substantial increases in yield.

5.3. Digestion and analysis

Plants grown from seeds from the original eleven sites produced a harvest in each of the three years (1990,1991 and 1992). The complete ears were collected and the grains removed in the laboratory, the resulting samples being dried to constant weight in an oven at 105°C. Five replicates for each sample were prepared; the microwave digestion process in nitric acid was the same as that detailed in Chapter 3, and analyses were again by AAS. The resultant peak heights and values from this procedure were converted to a concentration of metal per dry weight of grain using the "Excel" spreadsheet program specifically created for this purpose.

5.4. Results

The resultant average concentration values for each element and each sample are tabled in Appendix 7, together with the values obtained from the seed grown on its original soil. These same results are presented graphically in figures 5.1. to 5.6.

The aim of this experiment was to see if it were possible to determine whether genetic or environmental factors were more important in relation to elemental uptake for spelt. If the soil

environment is the more important then the lines produced by graphing the results could be expected to be more or less level, because all the grains should take up an equal amount of the element from the growing medium. This is clearly demonstrated when the graphs relating to the uptake of magnesium and calcium are examined (Figs. 5.1. and 5.2.). The analyses for the original grains (when grown on their various local soils) show a wide range of values which when graphed give a line with sharp peaks. All three Durham harvests produced grains which when analysed showed very similar results for both magnesium and calcium, giving three more or less horizontal lines.

The factors affecting the spacing of the lines representing the results from the harvested grain analyses remains unclear. The values from the magnesium analyses produce three separate and distinct lines; all the digestions and analyses were performed by exactly the same method, and it is highly unlikely that contamination could have influenced all the values in such a regular manner. The soil used for growing the 1991 crop (which produced the highest levels) may have been magnesium enriched, but this does not explain why the levels recorded in 1990 are significantly higher than those for 1992. Enrichment of magnesium to a lesser degree is unlikely because other elements are unaffected and demonstrate very close results for the 1990 and 1992 crop (as seen in the calcium values).

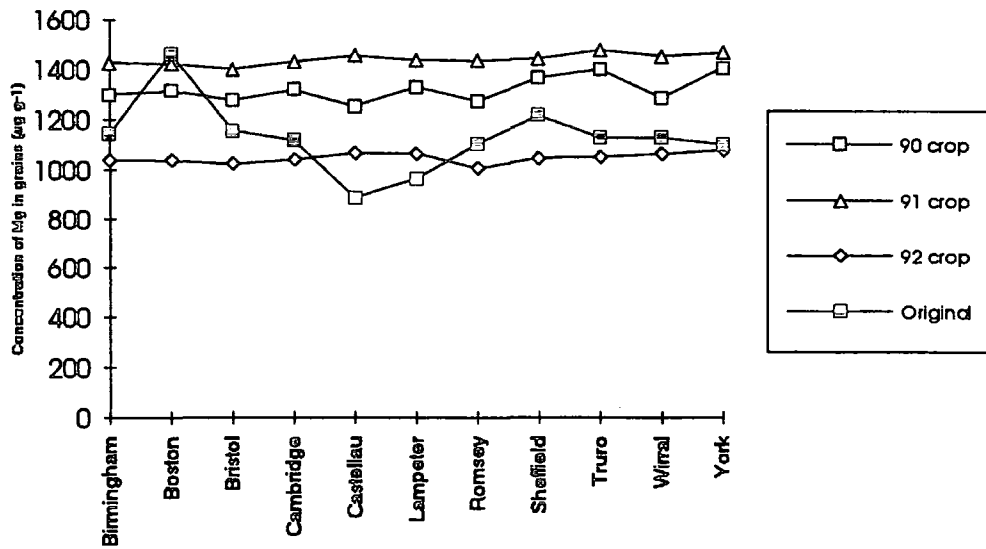

Fig.5.1. Concentrations of magnesium analysed in grains from eleven different sites, and from the harvested grains grown up on a different soil over three years.

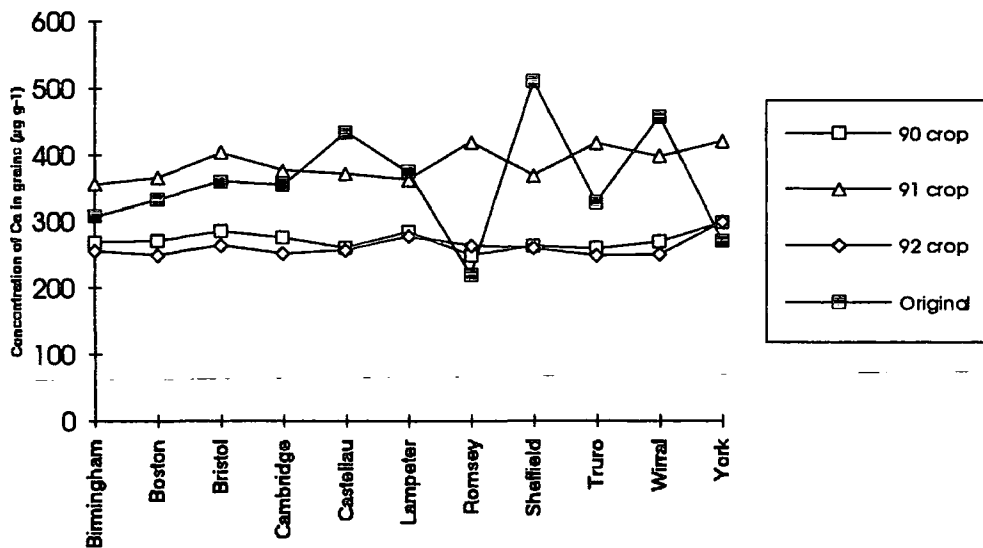

Fig.5.2. Concentrations of calcium analysed in grains from eleven different sites, and from the harvested grains grown up on a different soil over three years.

Possibly environmental factors such as rainfall or temperature were such as to favour uptake of magnesium in varying amounts, but

unfortunately these were not recorded on a regular basis. The variations could also be related to problems involving pests and plant diseases; a better harvest may have led to an effective "dilution" of magnesium between more grains (if an excess was not present in the soil and available for uptake) hence giving higher magnesium values in those years with fewer grains and a poorer harvest (1990 and 1991).

The results for calcium (and for the micronutrients to a lesser degree) suggest that two different soils were supplied from the Botanic Gardens. It was understood that the soil had come from exactly the same place for all three years, but results suggest that the material supplied in 1991 came from a different area to that given in 1990 and 1992: results from the latter two years are much closer than those obtained from the harvest in 1991. Regrettably there is no definite way of proving this as only soil from the 1990 batch was retained for analysis.

The results for calcium and magnesium analyses proved to be of a similar form, demonstrating the major effect of the soil on macro-elemental uptake into the grain. The results for analyses of copper, iron, manganese and zinc also formed a group but indicated that there may be some genetic input in their uptake.

Initial examination of the results for copper (Fig.5.3.) suggests that although the lines produced from the analyses values of the harvested grain have not levelled out as much as those for calcium and magnesium, they are much more uniform than those graphed by the original values. However, the apparent peaks in Fig. 5.3. are largely due to the scale on the Y axis - if the numerical range was only doubled the line would appear flattened. In addition the values from the harvested grains in all three years have a range of less

than $1\mu\text{g g}^{-1}$. Since levelling out of the harvested grain results indicates that the soil environment is of primary importance in the uptake of elements the values for copper suggest that although the range of concentrations is small, and there does appear to be a minor genetic effect, it is the environment which has most influence on elemental concentrations.

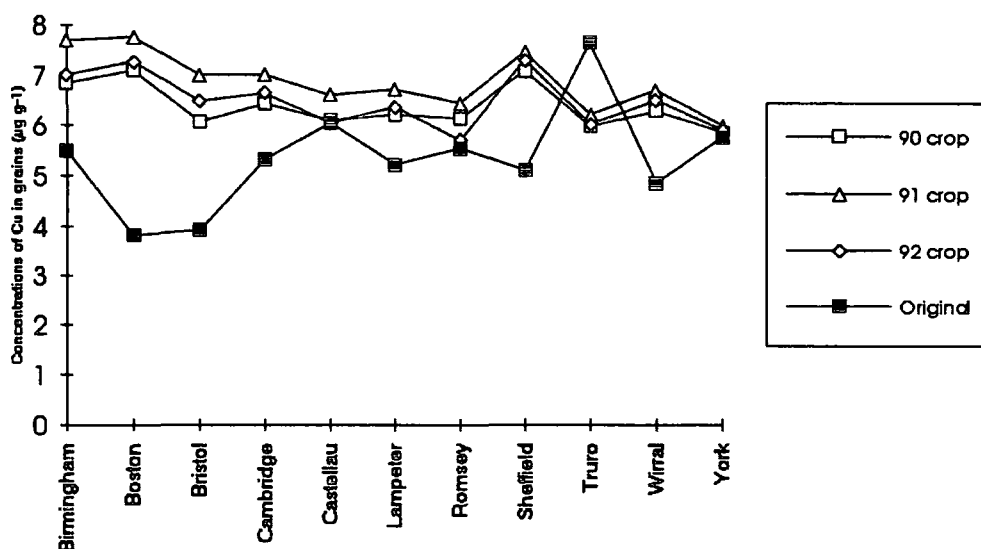

Fig.5.3. Concentrations of copper analysed in grains from eleven different sites, and from the harvested grains grown up on a different soil over three years.

The only groups to show closely related values are those from Castellau and York; the results from the Romsey samples are also less widely spaced than the others. This possibly suggests that the soil from these three sites was comparable to the "new" soil in Durham, otherwise some changes could have been expected in the uptake values. However, when available copper concentrations in the soil samples from Castellau, Durham, Romsey and York are examined the values are widely different being 6, 12, 24 and $14\mu\text{g g}^{-1}$ respectively. This fact raises yet another point regarding elemental

values in soil; the concentration of copper is calculated for a specific weight of soil but this value is not the same as the total amount of the element in a given volume. Plant roots can obviously spread through a large volume of soil and may effectively concentrate elements to levels in excess of the concentration unit value. Thus it could be argued that values for elemental concentrations in soil cannot be directly related to concentrations found in plant material. Additionally, a limited sample (such as five replicates) does not eliminate the possibility of "hot or cold spots" for elemental concentrations in the soil.

The remaining samples show more widely divergent values with disparity between the original values and those obtained from the harvested grain. The original sample from Truro was produced on a soil with a high copper content and when analysed gave the highest uptake of that element into the grain; this is almost certainly related to environmental pollution associated with the Cornish mining industry. However, when grown in Durham the harvested grains showed a reduced level. Conversely, grains from Birmingham, Boston, Bristol, Cambridge, Lampeter, Sheffield and Wirral all had relatively low original values, and all increased in the harvested material (by nearly 100% in the Boston seed). Possibly the copper content in the "low uptake" sites was at scarcely adequate levels leading to the seeds taking up much higher amounts when grown on a copper sufficient soil. Loneragan et al. (1980) studied copper supply in the soil in relation to copper content in the wheat plant and found that the element is highly mobile when present in adequate supply and immobile at low levels; thus if copper is in low supply very little is found in the grains, if the supply is adequate there is an increasing amount, and if there is a "luxury" supply very

large amounts are deposited in the grain. It would have been interesting to grow the F1 grains up in soil from Durham to produce an F2 harvest; if the hypothesis that the environment is more important is correct then the results from the analyses should show more comparable results and further levelling out of the graphed line.

The results for iron (Fig.5.4.) can be interpreted in a similar way. As with the elements previously discussed the pattern of uptake over the three years is similar and the graphed lines mirror each other, with the results for 1991 again being higher than in the other two years.

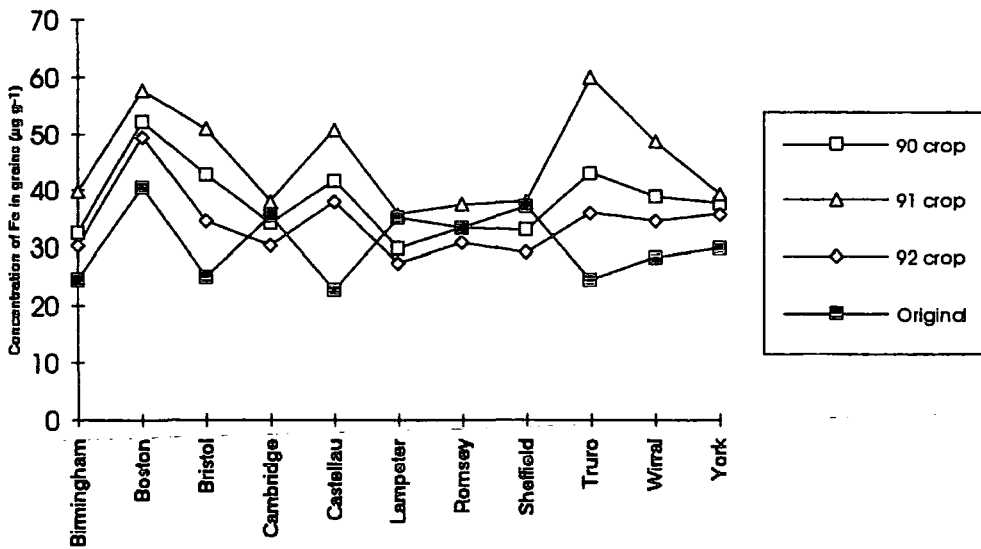

Fig.5.4. Concentrations of iron analysed in grains from eleven different sites, and from the harvested grains grown up on a different soil over three years.

Four samples, Cambridge, Lampeter, Romsey and Sheffield have closely grouped values; those for York are also relatively less widely spaced than the rest. Again the interpretation that the

available iron content in the soil of these five sites was very similar to that of the Botanic Garden sample does not appear reasonable; the concentration values from the soil samples from Cambridge, Durham, Lampeter, Romsey and Sheffield were calculated as 79, 131, 110, 149 and 175 $\mu\text{g g}^{-1}$ respectively.

Each of the other samples show increases on the values obtained from the original grain, with the results for Truro rising by 200% in the 1991 crop. Presumably the Durham soil was iron rich compared to that of the original sites and allowed greater uptake of the element into the grains, but the actual amount taken up was modified by the grain itself suggesting a genetic input. Had the environment been the only factor affecting iron values then one could expect the lines for the harvested grain analyses to be consistently above, below or the same as the original (as happens in the magnesium and calcium results). As this is not the case a genetic effect is inferred, but other factors must be involved because of the wide variation in results (i.e. if the uptake were solely under genetic control one would expect the harvested values to be close to the originals). Therefore there are limitations on iron uptake, with this influence being particularly apparent at Cambridge, Lampeter, Romsey, Sheffield and York. This may be an actual limitation on iron take-up or due to differences in the efficiency of the take-up mechanism.

The anomalous results in this series are those from Boston: like the other samples they show increased values on the original, but unlike the others the original grain had a comparatively high concentration of iron to start with (it was in fact the highest measured in any of the eleven samples selected). It would have been more explicable had the results from the harvested grain been

reduced or close to the original value. Again the possibility of contamination seems unlikely; the results might suggest that the original value was too high, but this number was the average of five replicates whose standard deviation from the mean value was only 0.9, and iron enhancement of each sample seems improbable.

The general trend of high original values giving lower results in the analyses from the harvested grains, and vice versa, as seen with copper and iron, is broadly repeated in the results for manganese and zinc (Figs.5.5. and 5.6.).

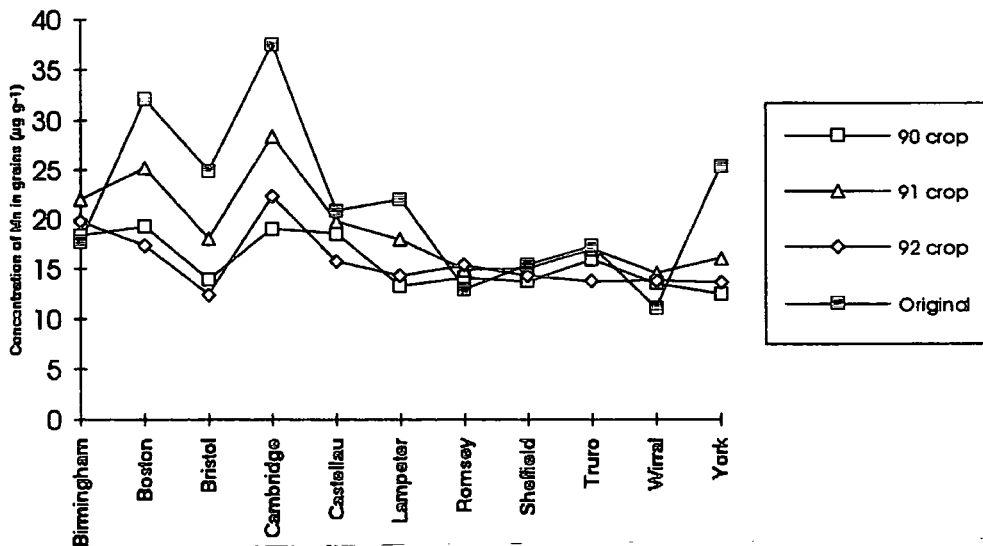

Fig.5.5. Concentrations of manganese analysed in grains from eleven different sites, and from the harvested grains grown up on a different soil over three years.

As with the previous elements there are some samples with very closely grouped results (Birmingham, Romsey, Sheffield, Truro and Wirral), but again there is no similarity between the available soil manganese of the original sites and that of Durham, and the concentration values range from 30 to 190 $\mu\text{g g}^{-1}$. Those samples

with originally high levels of the element all show reduced concentrations in the harvested grain (Boston, Bristol, Cambridge and York), and a decrease is also seen in those which had "moderate" levels (Castellau and Lampeter).

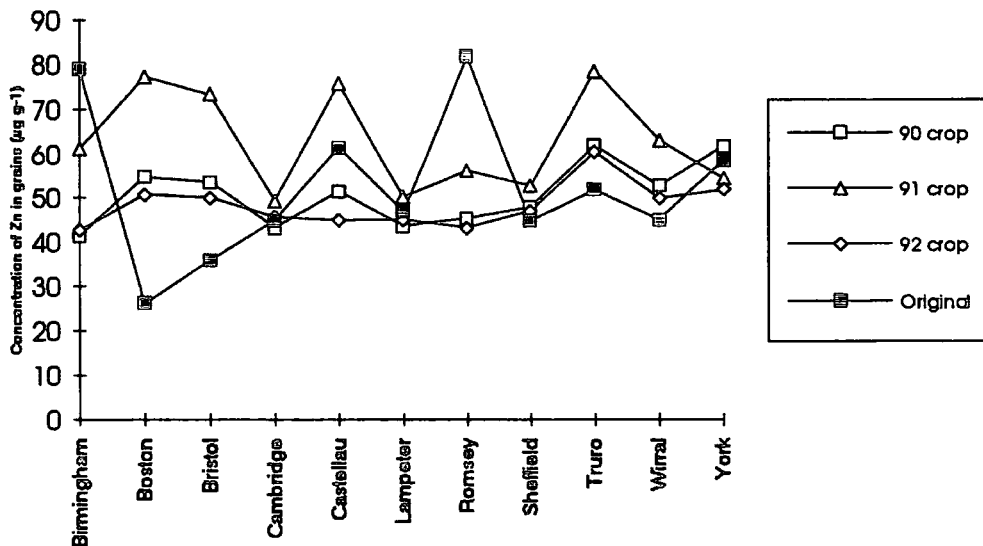

Fig.5.6. Concentrations of zinc analysed in grains from eleven different sites, and from the harvested grains grown up on a different soil over three years.

Zinc analyses of the harvested grain follow a similar pattern to the previous three elements with high original values being reduced (see Birmingham and Romsey), and vice versa (low original values being observed at Boston, Bristol, Truro and Wirral). Four samples show comparable concentrations of zinc in the analyses of original and harvested grains (Cambridge, Lampeter, Sheffield and York); as perhaps expected by now the concentrations of available soil zinc at these sites are not comparable with that of Durham and range from 9 to 81 $\mu\text{g g}^{-1}$.

5.5. Conclusions

The results for magnesium and calcium give the most conclusive proof for the hypothesis that the soil environment is the most important factor in elemental take-up into the grain; the analyses for these elements in grains produced from three harvests on one soil type give virtually horizontal lines when graphed, whilst the grains grown on the original sites show a wide range of values. It is possible that such results are only obtained if calcium and magnesium are at adequate or enriched levels in the soil, as they presumably were in this case; it would be interesting to repeat the experiment on deficient soils to see whether the grains gave uniformly low amounts of the elements.

Copper, iron, manganese and zinc would appear to demonstrate that whilst the environmental factor is important, there is also some limited genetic input which affects the levels of these elements in the F1 generation. However, consideration of percentage variation and the artefactual effects of varying the axis scale (especially for very small values) suggests that this genetic influence is minor when compared to the environmental / soil influence. Further studies will be necessary to clarify this point.

CHAPTER 6

DIAGENETIC CONSIDERATIONS

When I am laid in earth
(Dido's Lament) Tate

6.1. Introduction

A major problem in elemental analysis of archaeological material is the recognition and evaluation of diagenetic changes which can lead to the leaching and/or enrichment of elements in buried material. These changes have many causes including groundwater, soil and sediment composition, physico-chemical factors (such as pH, temperature, diffusion and uptake of elements) and biological activity (Runia, 1988).

Diagenetic processes and their effect on the archaeological record have been the subject of considerable recent interest, most especially with regard to human skeletal remains (Henderson et al., 1983; Brown and Blakely, 1985; DeNiro, 1985; Runia, 1987; Francalacci, 1989; Sealy et al., 1991). In the absence of similar work on grain or plant material a brief survey of this work is included.

Fresh bone composition is approximately 70% mineral, 20% collagen, 8% water and 2% non-collagenous components (Klepinger, 1984). The mineral phase is principally composed of calcium phosphate, which in adult humans is mainly in the form of crystalline hydroxyapatite; this is far from chemically pure and may incorporate minor and trace elements, the concentrations of which may give indications as to dietary intake, lifestyle and status.

However, Francalacci and Tarli (1988) analysed prehistoric human bone and showed that material from the same individual contained differing amounts of trace elements, which were in no way predictable. These differences were not due to experimental error as repeated tests gave concordant results. The "remarkable and unpredictable intra-individual variation" noted by Francalacci and Tarli was also found by Klepinger et al. (1986) and Herrmann and Grupe (1988). In an attempt to explain the wide ranging values it was suggested that the dishomogeneity of bone tissue or the metabolic differences in the various body parts could result in different amounts of the elements, but this does not provide an answer for those differences noted within the same skeletal parts (e.g. spine, ribs). Certainly, localised differences in the geochemical environment of the burial could lead to uptake and enrichment of elements, causing alteration of the *in vivo* levels of elements. Alternatively, leaching may occur leading to decreases.

Grupe and Piepenbrink (1988) have also noted diagenetic changes due to micro-organisms which invade the body after death and burial and play a major part in the decomposition process. These affect the trace element concentrations in two ways: (a) the acid metabolites of the micro-organisms dissolve hydroxyapatite causing depletion of elements bound to that chemical and collagen; and (b) some micro-organisms can accumulate heavy metals which are thus carried into the bone. The two micro-organisms used in experimental work by Grupe and Piepenbrink also acted differently within the bone; *Penicillium brevi-compactum* had mainly a surface effect which could be removed by cleaning and grinding away the outer layers of bone, whilst *Cladosporium* sp. have penetrating hyphae which cause irremovable contamination.

Runia (1988) also agrees that diagenesis causes alteration of chemical composition, and states that "because soil conditions and the diagenetic environments are unique to each site these are necessarily unpredictable and it is impossible to generalise on the behaviour of trace elements in buried bones". Bone is particularly problematic to analyse due to the range of pH values found within the body; the bone matrix is essentially an alkaline biomineral surrounded by an acid soft tissue and these factors influence the concentrations of elements in decomposing / buried material. Alterations in chemical concentrations also occur in buried grain, but since the pH values are on the acid side of neutral due to the nature of the material, these are unlikely to be as variable as in bone where the environment undergoes wider changes in acidity / alkalinity.

Analysis of the ancient diet on the basis of the inorganic content of excavated human bone is accurate only if the elemental levels in the bone correspond to those present at the time of death, and this has led to investigation of the conditions which promote diagenesis, its mechanisms and the elements which are most specifically altered. Nelson and Sauer (1984) looked at post-depositional changes in human bone and concluded that strontium and zinc probably did not undergo much diagenetic change; manganese, whilst more susceptible, was found to have relatively stable concentrations in alkaline and neutral soils. Lambert et al. (1985) examined a much larger sample of bones from Middle and Late Woodland sites in Illinois and also concluded that levels of strontium, zinc and magnesium were essentially unaffected and had a low sensitivity to diagenetic change (under those conditions). Levels of calcium, sodium, potassium and possibly lead were significantly lower than

predicted in the excavated samples, demonstrating leaching out of elements. Iron, manganese and aluminium all showed higher values and enrichment of elements with a net movement from the soil to the bone. It could be said that because bone is a porous material it might be expected to undergo changes but Lambert et al. (1982) found that the effects noted above were found in both porous cancellous rib bone and in denser cortical femoral bone. Their results indicated that strontium and zinc were the elements most resistant to the effects of diagenesis, and therefore the most reliable for dietary research. Calcium and sodium, although subject to leaching, were also of some value. However, in older and very decomposed bones, all four elements could be unreliable. Iron, manganese, aluminium, potassium, copper, barium, vanadium and uranium gave consistently highly contaminated values, and magnesium and lead showed mixed results.

In addition to these investigations in excavated bones, some authors have also examined the changes taking place in cremated bone, and the effects burning has on the chemical composition. Herrmann and Grupe (1988) found extensive changes in the structural organisation of the mineral matrix and combustion of organic components. Price and Kavanagh (1982) digested cremated bone in nitric acid and analysed the concentrations of magnesium, calcium and phosphorus; these were found to be enriched by burning and thus gave higher amounts in cremated samples (although the calcium : phosphorus ratios remained constant).

Analysis of modern charred grain demonstrated that levels of magnesium are consistently higher in burnt specimens (see Chapter 3, 3.9). The converse is true with calcium where levels in fresh grain are always higher, and this was also found to be the case with

copper. In the analyses of charred grain for iron, zinc and manganese no such consistency existed; the trends were for iron concentrations to be higher in fresh grains, zinc to be higher in charred, whilst analyses for manganese resulted in an equal division between fresh and charred grains having the greater values.

In the absence of any specific diagenetic source-work for grain it was unclear whether the effects associated elemental concentrations in bone would also hold true for seeds and therefore a limited study was undertaken.

6.2. Experimental method

It was decided to investigate diagenetic changes in buried grain in an experiment which, although necessarily of short duration, might indicate which elements were liable to the greatest degree of change. Modern grain was selected from six sites chosen for diversity of results from the initial analyses (Bristol, Castellau, Lampeter, Norwich, Romsey and York). Twenty five replicates from each site were prepared, each of twenty five grains which were dried to constant weight, weighed and charred using the same method as described in Chapter 3. It was necessary to char the grain because fresh grain would have sprouted and grown when buried. The burnt grains were re-weighed and placed in small bags made from six inch diameter discs of 500 micron nylon mesh (manufactured by the Locker Wire Co. Ltd., Warrington) tied with nylon fishing line to which was attached a spun polypropylene label with the identification number of the sample. The replicates were then divided into five groups of five, one of which was used as a control, whilst the other four were buried for periods of twelve, nine, six and three months in separate pots containing soil from the

same source. The pots were placed in an area at the University Botanical Gardens where they were open to rain and sunshine but would not be overhung by other plants or watered / sprayed with chemicals. It was found that weeds grew in the pots since there was no screening to stop seeds falling on the soil. Although the roots of some did grow down to the level of the buried bags the fine weave of the nylon was small enough to stop them entering amongst the grain samples where they may have caused depletion of elements by absorbing them into the plant. Had time and spare grain samples permitted it may have been useful to bury material in a more open weave fabric to assess the effects of roots growing within the burial environment.

At the end of the burial periods the bags were recovered from the soil and washed for one minute under flowing Milli-Q water. This ensured removal of soil particles and solution so that only the grain was analysed and not adherent contaminants, but would not be sufficient to cause leaching of elements from the sample (see work on washing samples in Chapter 7). The washed grains were then dried for twenty four hours in a drying oven (105°C) and weighed again. Weighing was repeated at each stage because analyses values were calculated for fresh weight, charred weight and recovered weight to discover if there were radical changes in amounts and proportions of each element dependent on treatment. The grains were then placed in 30ml Kjeldahl flasks, crushed and pre-digested in 4M HNO₃ for ten days prior to digestion in the microwave following exactly the same procedure as described in Chapter 3.

The grains from the control samples were also placed in nylon bags but instead of being buried in soil were put in a clean sealed glass jar, in a dark cupboard, for twelve months. In this way they

would not be acted on (and possibly chemically altered) by water, light or temperature changes. At the end of the experiment (after one year) the samples were removed from the jar, washed for one minute in running Milli-Q water, dried and digested in exactly the same manner as the buried grains. The control samples were washed because this meant that the only difference between them and the buried samples would be a period of time in the soil.

The increases in pressure throughout the digestion process for the recovered grains followed a very similar pattern to that shown by the charred grains in Chapter 3, and maximum pressure was reached in the same time period. This was to be expected since burial did not increase the organic content of the grains, and elemental proportions should not affect the rise to maximum pressure.

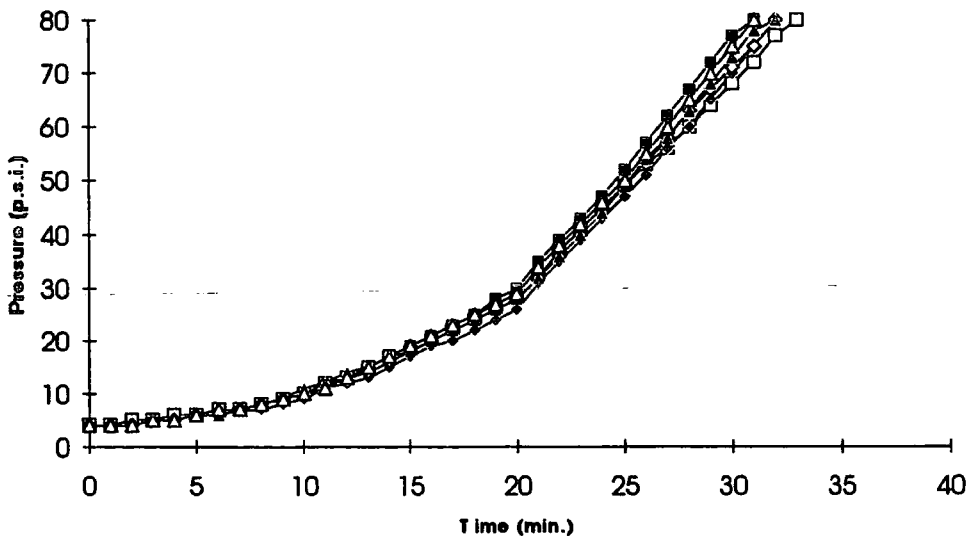

Fig. 6.1. Graph showing the pressure increases to the maximum of 80psi in the microwave decomposition of a series of recovered grain samples.

Analysis of the resulting solutions was again by AAS, and calculations of elemental values utilised the same "Excel" spreadsheets as previously.

6.3. Results

Three sets of results were obtained from the analytical values by using the weights of grain samples at various stages. The first set calculated the elemental concentrations using the final weight of the sample following burial, recovery, washing and drying (i.e. immediately prior to acid digestion)(see Fig. 6.2.). This was thought to be probably the most useful, because in analysis of any archaeological material this weight would be the only one known (weights prior to burial obviously being unknown). The second set of results relate to the weight of the grain immediately after charring (and before burial)(see Fig. 6.3.) and the third set to the initial weight of the fresh grains prior to any treatments (see Fig. 6.4.).

Fig. 6.2. shows the results of analysis of the micronutrients present as a total concentration for each sample. Each column represents the addition of the mean values for copper, iron, manganese and zinc obtained from five replicates. Each set of five columns represents grains from one site, the six groups of columns relating to Bristol, Castellau, Lampeter, Norwich, Romsey and York (left to right). In each group the column on the left shows the results for the twelve month burial period, the second left those for nine months, and so on; the column on the right of each group shows the mean values from analyses of the control samples.

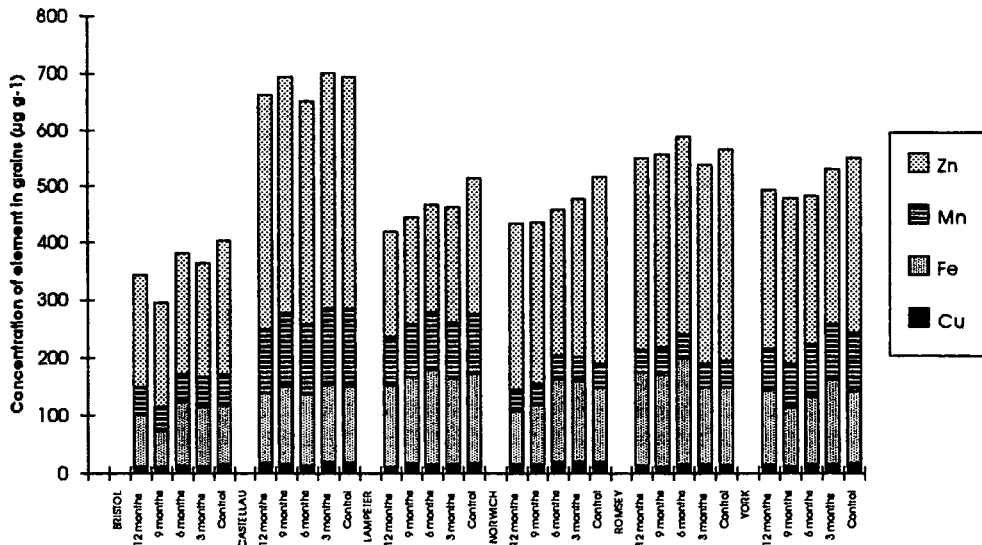

Fig.6.2. Total micronutrient concentrations analysed in recovered buried grain (based on the weight of grain following washing and drying after removal from the soil).

(To present this data more clearly Figures 6.7. to 6.10. show the changing analyses values for each individual element throughout the four different burial periods, and in the control samples.)

Grain from all six sites produced widely differing values for the micronutrients when analysed, as was expected from the original results. However, the ratios for each element were broadly similar, with zinc being present in the largest amounts, iron second largest, manganese third and copper least. The grains from Castellau contained the greatest total amounts of the four elements, but these samples also showed the smallest degree of change, with the range for all four burial periods and the control being only from 625-650µg g⁻¹ Conversely, the samples of grain from Bristol contain only on average, about 350µg g⁻¹ of the elements in total (almost half the amount analysed for the Castellau samples); in addition these

five results show the widest range of values from just under 300 to over 375 $\mu\text{g g}^{-1}$.

The pattern for total loss and gain is different for each sample in each burial period as can be seen by comparing the heights of all the columns; for example the value for the total amounts of the four elements in grains from Bristol and York is less after nine months of burial than at a year, but for Lampeter this situation is reversed - the grains buried for twelve months show the lowest total value. All grains show some variation from the control sample but the range of variation differs. The samples from Lampeter and Norwich would appear to suggest that the longer the burial period then the smaller the total elemental amount; i.e. those grains buried longest have lost more elements to the environment. Unfortunately, this does not happen in any other samples, and those from Romsey actually show the opposite with amounts of elements higher after six, nine and twelve months burial than those found in the control.

Work on human bone suggested that zinc was one of the elements least affected by diagenetic change, but this experiment would seem to suggest that this is not the case in cereal grains. No samples maintain the same percentage (or absolute amount) of any of the micronutrients as the control sample, even after a very short period of burial, and values for all six elements investigated can go up or down, as seen in the table of results at Fig. 6.5.

Fig. 6.3. shows total amounts of the four micronutrient elements calculated using the weight of the charred grains prior to burial. The total concentrations of the elements analysed are slightly less than in the first set of calculations because during the burial and recovery processes the weight of each sample is

reduced by a small amount, probably due to unavoidable loss of small fragments of charred grain. Smaller sample weights obviously produce higher concentrations hence the different values.

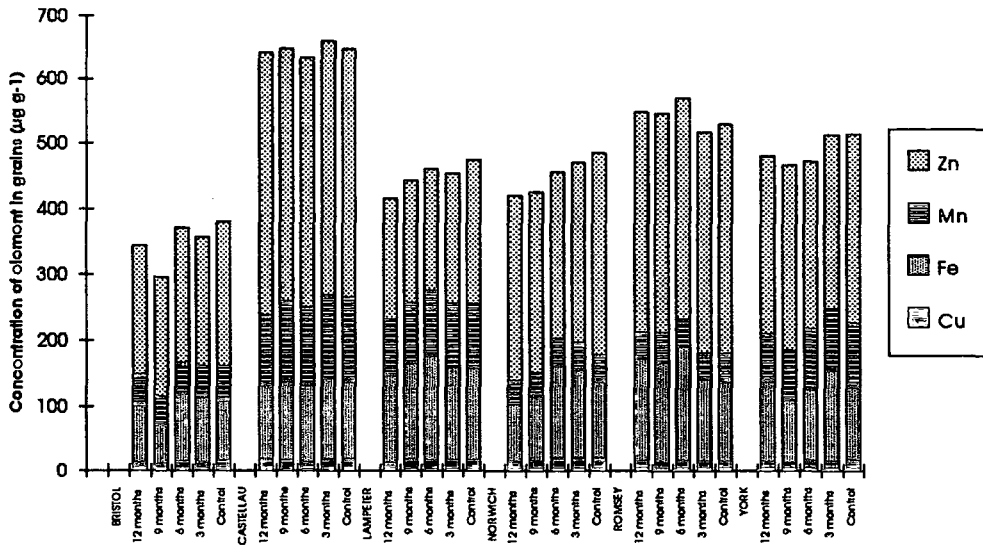

Fig. 6.3. Analyses of recovered grain based on the weight of the charred grains prior to burial.

Fig. 6.4. shows results of calculations based upon the original weight of the grain before charring or burial. The amounts of each element are less because obviously the fresh grain weighs more than the charred (and hence gives lower amounts in calculations of the analysed values) but again the proportions are exactly similar to those relating to the charred, buried, recovered and washed grain.

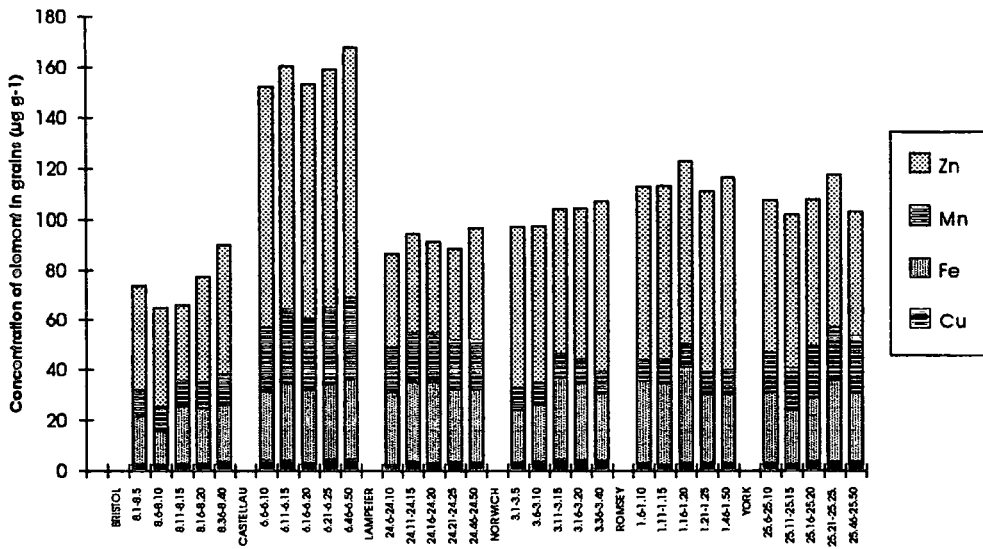

Fig. 6.4. Analyses of recovered buried grain (based on the weight of the grain prior to charring and burial).

If the mean values of all the elemental concentrations and their standard deviations are examined more closely certain trends are apparent. These are given below at Fig. 6.5.

	Cu	Fe	Mn	Zn
BRISTOL:				
Control	14.3(0.5)	96(3.7)	51(0.6)	220(3.1)
3 month burial	11.6(0.4)	103(3.8)	47(0.6)	197(5.7)
6 month burial	12.3(0.9)	107(7.4)	46(1.5)	206(5.1)
9 month burial	9.5(0.6)	63(5.4)	42(1.4)	182(5.8)
12 month burial	10.5(1.1)	91(9.1)	46(2.0)	196(13.8)
CASTELLAU:				
Control	16.2(0.5)	121(3.6)	123(2.2)	404(7.2)
3 month burial	17.9(0.6)	126(5.2)	124(4.8)	401(7.80)
6 month burial	11.4(0.6)	107(8.6)	116(4.7)	400(8.9)
9 month burial	14.6(0.9)	109(11.3)	120(5.6)	389(9.1)
12 month burial	16.6(0.8)	109(18.2)	106(5.3)	388(32.2)
LAMPETER:				
Control	15.5(0.8)	144(4.6)	95(4.1)	221(5.1)
3 month burial	15.8(1.1)	138(5.4)	95(4.3)	200(8.0)
6 month burial	14.4(1.7)	163(7.1)	97(4.9)	187(12.7)
9 month burial	16.5(1.9)	149(13.7)	91(5.7)	188(13.2)
12 month burial	10.4(1.9)	139(18.5)	82(5.5)	184(11.5)

	Cu	Fe	Mn	Zn
NORWICH:				
Control	18.1(0.3)	109(2.5)	37(0.8)	311(3.7)
3 month burial	18.5(0.4)	140(2.9)	39(0.6)	268(4.3)
6 month burial	17.0(0.5)	131(4.7)	40(1.4)	249(8.3)
9 month burial	14.0(0.6)	101(7.5)	35(1.8)	276(13.3)
12 month burial	13.7(1.1)	91(7.1)	35(1.8)	281(16.3)
ROMSEY:				
Control	12.8(0.4)	125(8.9)	42(2.2)	372(3.8)
3 month burial	13.8(0.5)	128(9.4)	39(2.4)	337(11.4)
6 month burial	14.3(0.7)	177(9.9)	38(2.3)	327(14.8)
9 month burial	10.3(0.5)	157(9.5)	44(2.9)	334(15.8)
12 month burial	14.0(0.7)	155(11.0)	38(5.1)	338(24.4)
YORK:				
Control	15.5(0.4)	115(6.6)	95(4.8)	289(8.4)
3 month burial	13.9(0.8)	142(7.7)	91(8.7)	266(10.7)
6 month burial	15.2(1.0)	113(14.8)	89(5.5)	256(14.0)
9 month burial	10.7(0.9)	85(11.6)	74(11.6)	283(13.7)
12 month burial	12.6(1.4)	97(25.2)	70(10.3)	272(24.1)

Fig. 6.5. Mean values for micronutrient concentrations ($\mu\text{g g}^{-1}$) in all the samples. Standard deviations are given in parentheses.

It is obvious from the table above that there is a strong trend of increasing standard deviation value with increasing burial time, and this occurs irrespective of whether the actual concentration values are increasing or decreasing. The lowest standard deviation value is always found in the control sample, except in the copper analyses for Bristol where the value for the three month burial sample is lower by 0.1. This demonstrates increasing variation related to the burial time suggesting diagenetic changes do not occur uniformly or cause the same effects in grain samples, thus agreeing with the results obtained following analyses of ancient human bone.

From the figures above it is possible to calculate percentage losses (or gains) over the total burial period. Disregarding the intermediate values the difference between those of the control and twelve month burial period was calculated as a percentage and these values are shown below at Fig. 6.6.

very similar but that the magnitude of the actual changes is unpredictable. The changes demonstrated by the copper results cover a relatively much wider range despite the smaller actual values involved, suggesting perhaps that diagenetic changes relating to that element are even more prone to be erratic and uncertain.

Whilst the percentage decreases (or gains) in concentration value between the control and twelve month burial samples can be variable, the range in values between the highest and lowest concentration results (when all burial periods are considered) is often much greater. For example (see Fig. 6.5.) the range between the minimum and maximum mean concentration values for iron in the Norwich samples is 49 but the difference between the results for the control and the twelve month burial period samples is only 18. This is because there are varying losses and gains in each burial period and no steady and continual decrease occurs. This is clearly demonstrated in the results for zinc in the Bristol samples where there is an initial loss followed by a gain then a loss and a final gain in analysed concentration. Although the overall trend would appear to be a decrease in elemental concentration, in the short term only four sets of samples show a more or less steady reduction in values throughout all periods (Norwich/copper, York and Lampeter/manganese, and Lampeter/zinc). This does raise the question of which analyses are most useful or justified - those based on the greatest variation or those related to a set time period? In this case the calculations based on the maximum burial period concentrations were thought to relate more to overall trends but it would be interesting to continue the experiment over a period of say five years to examine how long the increases and decreases in

concentration continued for, and at what stage chemical equilibrium occurred (if indeed this were reached within this timescale).

It was initially thought that samples with larger concentration values might show a wider range in variation but this was not found to be the case. Samples from Castellau have the highest concentration values of zinc but a range of only 16 (388-404) when all periods were considered. Lampeter samples on the other hand have a much lower zinc concentration value but a significantly larger range of 37 (184-221).

It is thought highly probable that elemental concentrations are affected by the burial environment, and the trend of overall loss in these experiments is doubtless associated with this. The grains were buried in free draining soil in pots standing on sand to prevent water accumulation at the base. These were subjected to periodic wetting by rainfall and depletion of elements by leaching was to be expected. An interesting further experiment would be to bury grain in specifically water-logged / acid / alkaline environments to examine whether enrichment or different changes occurred, or perhaps to control the volume, concentration and throughput of leaching solutions.

Both macronutrient elements are present in large concentrations in all samples with magnesium comprising the larger percentage in all the controls and most of the buried samples, Lampeter being a notable exception (see Figs. 6.11 and 6.12.). As noted later the increase in concentration of calcium is assumed to be related to high soil calcium; however, the extremely large increases in the Lampeter samples are abnormal in relation to the others and some form of contamination would seem probable.

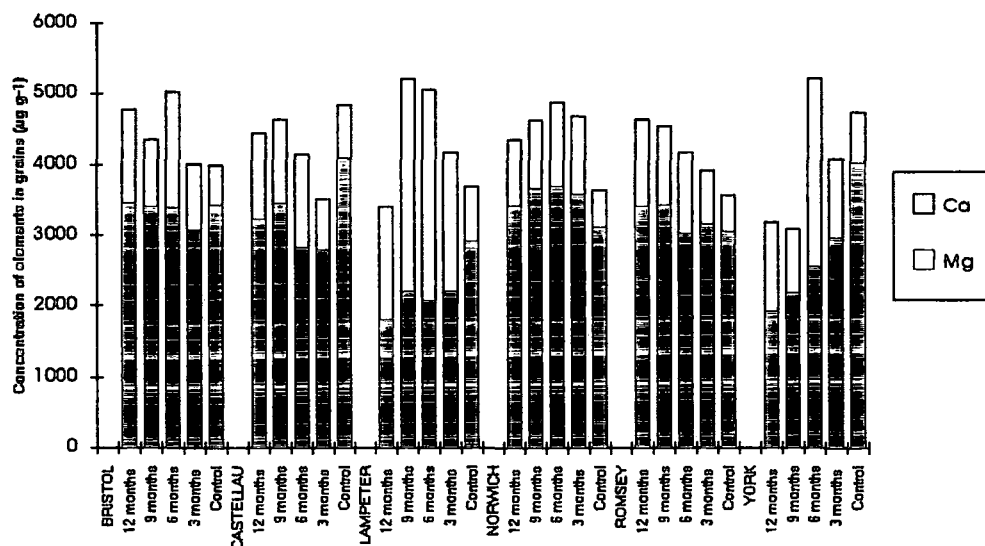

Fig. 6.11. Mean concentrations obtained for the macronutrient elements calculated using the grain weights following recovery from burial (values in $\mu\text{g g}^{-1}$).

An interesting point in changing total element concentrations is that the pattern for loss / gain is different in the micro and macronutrients. If Figs. 6.2. and 6.11. are compared it can be seen, for example, that the micronutrients in the Lampeter and Norwich samples underwent a steady reduction in the value of the total concentrations. When one examines the total macronutrients the same samples show initial increases in the total concentration values prior to a loss in the nine and twelve month burial samples at Norwich, and the twelve month sample at Lampeter.

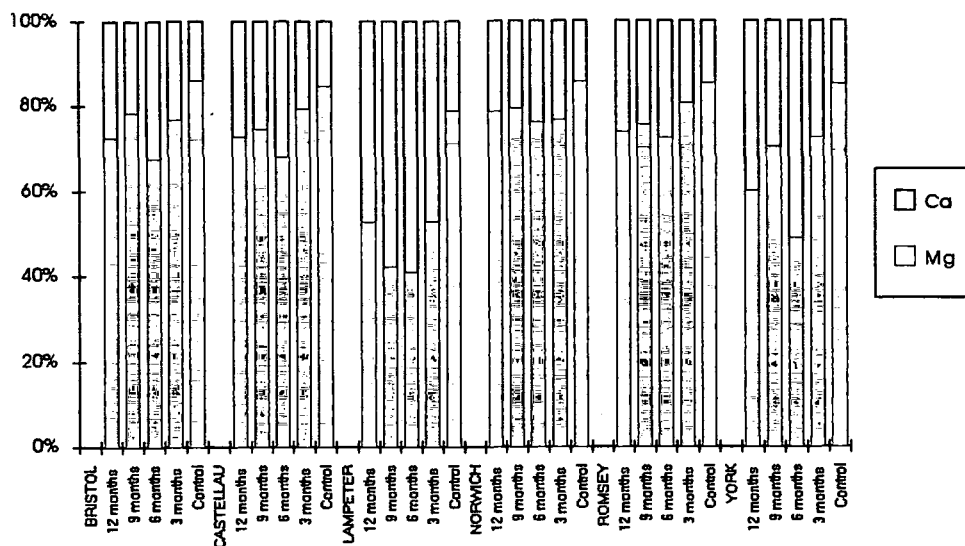

Fig. 6.12. The values in Fig. 6.11. expressed as percentages.

The values for the mean concentrations of the macronutrient elements calcium and magnesium in the control samples and those for each of the four burial periods are shown below at Fig. 6.13. together with the standard deviation values.

	Mg	Ca
BRISTOL:		
Control	3417(64)	573(40)
3 month burial	3065(119)	947(59)
6 month burial	3390(107)	1637(55)
9 month burial	3394(145)	959(94)
12 month burial	3448(172)	1320(123)
CASTELLAU:		
Control	4082(23)	756(19)
3 month burial	2777(131)	740(29)
6 month burial	2815(181)	1330(51)
9 month burial	3443(277)	1189(82)
12 month burial	3219(289)	1224(99)
LAMPETER:		
Control	2901(66)	796(38)
3 month burial	2193(84)	1980(42)
6 month burial	2061(90)	2994(46)
9 month burial	2185(84)	3015(116)
12 month burial	1787(114)	1620(73)

	Mg	Ca
NORWICH:		
Control	3104(43)	533(21)
3 month burial	3567(187)	1106(95)
6 month burial	3689(112)	1179(56)
9 month burial	3655(236)	966(165)
12 month burial	3407(200)	939(191)
ROMSEY:		
Control	3039(69)	532(28)
3 month burial	3143(85)	773(60)
6 month burial	3011(119)	1156(68)
9 month burial	3413(113)	1127(63)
12 month burial	3400(154)	1227(95)
YORK:		
Control	4014(240)	723(19)
3 month burial	2952(60)	1130(52)
6 month burial	2535(79)	2668(69)
9 month burial	2165(78)	921(54)
12 month burial	1903(114)	1275(51)

Fig. 6.13. Mean values of concentrations for the macronutrient elements ($\mu\text{g g}^{-1}$). Standard deviations are given in parentheses.

Notwithstanding the larger values involved the ranges both between the control and the twelve month burial samples, and the maximum and minimum concentrations are much larger than those measured in the micronutrient elements. This is especially noticeable in the values for calcium; the difference between the maximum and minimum concentrations in the Lampeter samples is 2219 which is almost three times the value of the minimum (796). However, the ranges in calcium values between control and twelve month burial samples are much lower, demonstrating large and unpredictable increases and decreases in concentration values and instability of the element throughout the burial periods.

As with the micronutrient results the trend is for standard deviation to increase with increasing burial time irrespective of concentration values (i.e. the higher concentration values do not necessarily have larger standard deviations).

If the trends in overall loss or gain throughout the twelve month burial period are examined the magnesium results are very similar to those for copper. Three samples show overall increases in concentration values (Bristol, Norwich and Romsey) whilst three have decreased values (Castellau, Lampeter and York). Like the copper results the increases are small in relation to the large decreases (see Fig. 6.14) and again may indicate that an overall decrease in concentration is more likely to occur, especially over a longer time scale.

	Mg	Ca
Bristol	+9	+130
Castellau	-27	+62
Lampeter	-62	+107
Norwich	+10	+76
Romsey	+12	+131
York	-111	+76

Fig. 6.14. Percentage losses and gains in mean concentration values calculated from the differences between the control and twelve month burial samples.

Conversely all the calcium results show a large increase in concentration values over the years burial but the magnitude of increase is unpredictable. For example, the percentage increase in calcium concentration in the Bristol samples is more than twice as much as that in the Castellau samples (130% compared to 62%). All the samples (in all burial periods) increase their proportion of calcium in comparison to the control sample to a significant amount (see Fig.6.12.) . This is assumed to be related to the fact that calcium is present in very large concentrations in the soil and is

therefore available for deposition in the buried material. It would be interesting to repeat the burial experiment in a calcium reduced environment to examine whether this element could be leached out of the grains to the same degree as the others.

6.4. Conclusions

Authors working on human bone concluded that levels of zinc probably did not undergo much diagenetic change and that examination of calcium and magnesium could prove of some value. The results from this series of experiments with grain show that those elements can undergo significant diagenetic changes with trends suggesting overall decreases in copper, iron, manganese, zinc and magnesium, and increases in calcium concentrations. The percentage losses are variable and not predictable within any one set of samples; percentage decreases in copper concentrations ranged from 19-33%, those for iron from 3-17%, for manganese from 5-16% and for zinc from 4-17%. This being so it can be said that the percentage decreases in copper concentrations can be expected to be at least 20%, whilst those for other micronutrients will probably exceed 5%.

Examination of the macronutrient concentrations shows even larger percentage changes with losses of between 27-111% in magnesium and gains of 62-131% in calcium. It should also be noted that variation in sample values increases with increasing burial time and that this makes interpretation of results more difficult. Obviously more work needs to be done using a larger series of grain samples and different burial environments for the work to be conclusive.

All of the samples used in this experiment were buried in the same material environment; it would be interesting to investigate whether similar changes in elemental concentration could be obtained

in different environments. For example, does calcium concentration tend to always increase in different soil types, such that the increase is a factor of the way calcium behaves rather than a reaction to the chemistry of a specific soil (or does it demonstrate a loss of concentration in, for example, an acid soil, and a gain in a neutral soil). Since diagenetic changes are so difficult (if not impossible) to predict, work relating to elements (trace or macro) in archaeological material is necessarily questionable and any results which suggest definite values as being those of the original unburied material should perhaps be regarded as dubious.

The most serious shortcoming of this experimental series is the short time scale involved: what happens in the short term could quite possibly be reversed in the long term, and these results can only be viewed as an indication of what changes occur in elemental concentrations during a burial period of a year. However, whilst not able to indicate the magnitude of change in any one element the experiment does indicate that changes due to diagenesis undoubtedly occur, even within a short time, and that elemental concentrations in archaeological material need to be interpreted with care as they are probably very different from the pre-burial values.

CHAPTER 7

ARCHAEOLOGICAL MATERIAL

I have considered the days of old: and the years that are past.
Psalm 77

7.1. Introduction

The establishment of a data set using modern material meant it was then possible to begin analysis of archaeological samples to determine if there are any correlations in the elemental suites of fresh and ancient grains. It was hoped that archaeological material would contain measurable amounts of the selected elements in proportions which would relate to those found in modern samples. Following the diagenetic experiments (Chapter 6) it was realised that actual elemental concentrations within the grain would differ due to the effects of burial, but it was hoped that some similarities would still be apparent. Prior to commencing this work it was necessary to decide which type of archaeological material to include. To relate to the experiments with modern grain, the ancient samples obviously had to be charred, and not mineralised. In order to reduce variables it was also decided that samples should be chronologically similar, and for this reason material was restricted to the Late Iron Age and Roman periods; by this time spelt was one of the most commonly produced grain crops in Britain and the likelihood of finding it in the archaeological context was therefore high. The incidence of spelt in later deposits decreases (as bread wheat becomes more common) and it is much rarer in earlier contexts, thus reducing the chance of finding enough grains for

analysis. It was originally hoped that all the archaeological grain to be analysed would come from Roman sites along Hadrian's Wall. These could have been of similar period and context, coming in the main from military granaries, and this would have reduced extraneous variation. It was also thought probable that any such grain could have come from a wide variety of sources, both in Britain and abroad, which might be reflected in differing elemental suites. However, it proved impossible to obtain sufficient uncontaminated seed from this area, apart from samples from South Shields.

When analysing the modern charred grains it was found that a sample of approximately twenty five seeds gave sufficiently high concentrations of the "low value" elements (especially copper) to come well within the detection range and limits of the standard solutions prepared for A.A.S. For statistical reasons the minimum number of replicates for each site had to be (at least) five (Dr. P. Altham, pers.comm.). Analysing five samples rather than only one demonstrates if there is a large degree of intra-sample variation or not, and the standard deviation from the mean value in the sample range indicates whether that value can be regarded as accurate and reliable. The standard deviations from the mean concentration in analyses of the modern grain were very small and showed little intra-sample variation inferring that the grains had all taken up approximately the same amount of each element. This was to be expected as the material had all come from the same environment with regards to soil type and growth conditions.

With archaeological samples wider variations are more likely because: (a) the grains in each replicate could have been grown in different areas; and (b) buried material can be subject to diagenetic change or contamination in a "micro-environment", such

that within the same sample context the analysed concentrations of elements can be significantly different. To obtain totally reliable results a number of replicates have to be analysed; whilst even greater accuracy may have been gained by using a minimum of ten (or more) replicates there was a problem of finding large enough samples in the archaeological record to supply sufficient material, and since five replicates requires a minimum of one hundred and twenty five grains it was decided that this was a sensible number to analyse. Obtaining even this quantity of archaeological spelt proved to be something of a problem; a number of sites could have supplied around twenty (probable) grains, but only seven had contexts containing large amounts of uncontaminated material.

The large Iron Age hillfort of Danebury in Hampshire, excavated by Cunliffe from 1969 to 1988 (Cunliffe and Poole, 1991), had numerous grain storage pits which provided exceptionally rich contexts of well preserved charred grain. It was therefore possible to discard seeds from the "outside" of samples, selecting only the hopefully uncontaminated inner material. This also provided a larger sample from which to choose those grains most likely to be spelt; those selected for analysis were most similar to the classical description given by van der Veen and other botanists, and any which appeared incorrect morphologically were discarded. Large numbers of grains were also excavated by Bidwell in 1984 from a granary at the Roman fort at South Shields, probably built in AD208 for the Severan campaigns (Bidwell and Holbrook, forthcoming). This again allowed similar selection of samples for analysis.

A further Roman military site to provide grain was the fort in Lancaster, excavated by Newman in 1988-92. The context of a drip trench belonging to a third century A.D. Roman building provided

well preserved grain, much of which could be identified as spelt (J.P.Huntley, pers. comm.) in sufficient numbers for analysis. A spread of industrial debris was associated with this context, possibly laid down by high temperature industrial processing in the Roman period. The building was refurbished on several occasions throughout the Roman occupation of the site, and later Medieval rubbish pits frequently disturbed the Roman features (Lancaster University Archaeological Unit, 1993) All of these factors are doubtless linked to the exceptionally high levels of copper, iron, manganese and zinc.

Grain was also supplied from two sites in London, but not in such large amounts. In 1976 the Museum of London excavated first century A.D. levels at the Roman Forum situated under the present day Fenchurch Street (Moir, 1989) finding sediments containing exceptionally well preserved seeds which were positively identified as spelt. In 1987 excavations investigated the late first century A.D. Roman levels at the Bucklersbury site near to the modern Cheapside (Spence et al., 1989) and limited amounts of grain were found. In the early Roman period this was a small scale industrial area close to the Walbrook, which was canalised by the Romans allowing goods to be brought in by water, presumably accounting for the presence of spelt. Preservation was not as good as at the Forum and a number of grains were damaged. Of the seeds selected some were ambiguous.

The remaining two sites to provide grain were Hibaldstow in Lincolnshire, and Shepton Mallet in Somerset. The former site was excavated by Smith in 1976-7 (Goodburn, 1978), and the latter by Leach in 1990 (Frere, 1991). Both date to the early Roman period (first century A.D.). The locations are similar, both being rural,

and the excavation findings consistent with small village-type habitation. Small amounts of grain were found, most of which was sufficiently well preserved to be positively identified as spelt.

It is accepted that these samples form a rather eclectic group with as many differences as similarities (despite the restrictions placed on which samples should be analysed). This obviously means that less can be expected of the results, and that any interpretation and conclusions concerning these are less valid than if the samples had been of a greater number and from a more structured group of sites.

7.2. Experimental procedure

Environmental material from excavations is usually collected as a bulk sediment sample from suitable contexts such as ditches, storage and cess pits or domestic habitation levels. These are washed and sieved to release material which is then dried, sorted and identified. Only the sample from Lancaster was prepared in the Biological Laboratory in Durham, the others all being sent in the cleaned state from those holding the archive material. In retrospect it would have been extremely useful to have analysed soil samples from around the grain bearing contexts to compare the amounts of the various elements in sediment and grain; unfortunately this was impossible as most of the sites were excavated some years previously and the Lancaster soil was not retained.

Grains removed from the ground may have adherent particles of soil and other material attached to them. Since this experimental work was concerned solely with analysis of the grain all samples were washed in Milli-Q ultra pure water prior to acid digestion to remove any possible surface contamination. This was done by wrapping

the grains loosely in 500 micron nylon mesh (manufactured by the Locker Wire Co. Ltd., Warrington) which allowed free flow of water without damage to the seeds. As there were large numbers of grains available from Danebury it was possible to conduct limited experiments with these with respect to washing times in order to obtain the most accurate results. It was also possible to digest and analyse washed and unwashed grains and observe the differences. The aim with the washing was to obtain a clean grain but to avoid leaching of elements. The initial times selected for the washing trials were arbitrary; thirty seconds was chosen as a "short" period, sixty seconds as a "medium" period and five minutes as a "long" period. However, in the event sixty seconds proved to be a suitable time in all respects. Analyses of grains washed for thirty seconds gave slightly reduced concentration values (compared to unwashed material); those washed for sixty seconds gave a further reduction whilst the grain treated by the longest wash showed only a marginal (if any) decrease on the second set of values (see Figs. 7.1. and 7.2.). These results are interpreted as demonstrating that the sixty second wash removes significant contamination which appears to be unaffected by a shorter washing period. Prolonged washing gave no improvements in concentration values following analysis, and the time and amounts of water involved were deemed excessive in view of the perfectly adequate results obtained with reduced washing. It was therefore decided to wash all the archaeological samples for sixty seconds prior to the microwave digestion procedure.

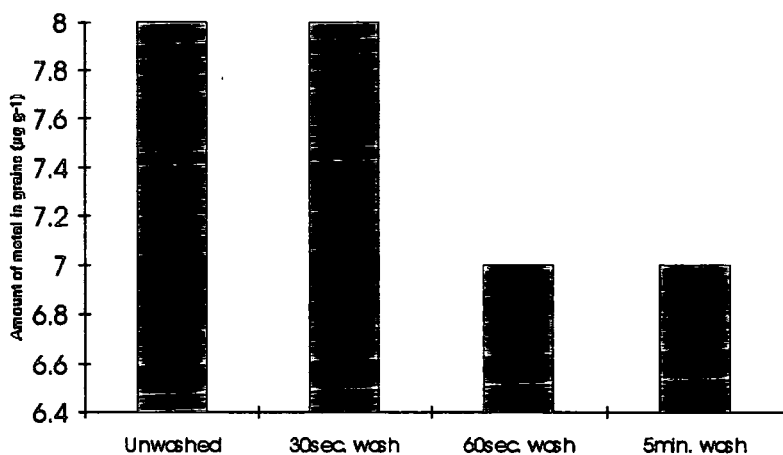

Fig 7.1. Grain from Danebury showing the differences in the concentrations of copper analysed in washed and unwashed samples (values in $\mu\text{g g}^{-1}$).

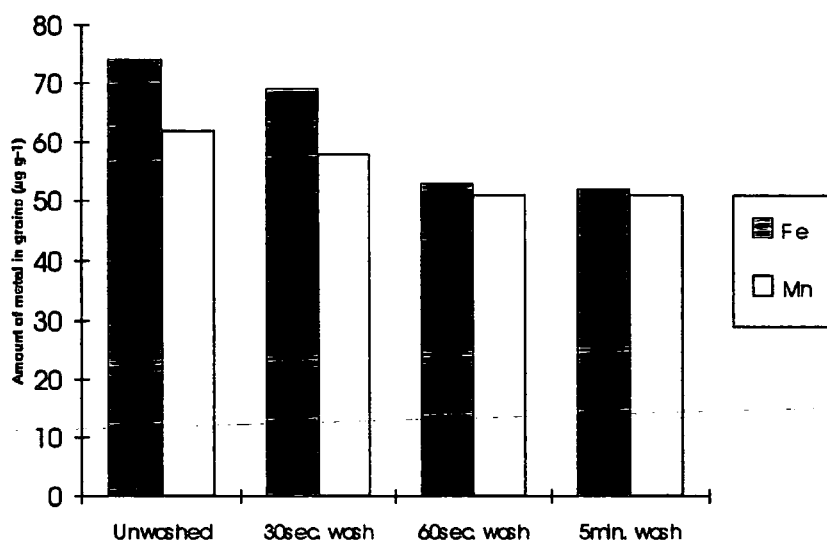

Fig.7.2. Grain from Danebury showing the differences in the concentrations of iron and manganese analysed in washed and unwashed samples (values in $\mu\text{g g}^{-1}$).

As can be seen from the table at Fig.7.3. concentrations of zinc, magnesium and calcium did not show such marked differences between

the washed and unwashed samples, and are therefore not presented in graphical form.

	Cu	Fe	Mn	Zn	Mg	Ca
Unwashed	8	74	62	110	168	44656
30sec. wash	8	69	58	108	168	44636
60sec. wash	7	53	51	105	167	44441
5min. wash	7	53	51	104	166	44439

Fig.7.3. Concentrations of the various elements analysed in washed and unwashed samples of spelt from Danebury (values in $\mu\text{g g}^{-1}$).

The lesser amount of spelt from South Shields meant that it was only possible to compare the results from analysis of those seeds which were unwashed or washed for sixty seconds. The values for the six elements are given below at Fig.7.4.

	Cu	Fe	Mn	Zn	Mg	Ca
Danebury washed	7	53	51	105	167	44441
(standard deviation)	0.3	1.9	1.3	1.6	10.4	554
Danebury unwashed	8	74	62	110	168	44656
(standard deviation)	0.4	2.6	1.9	4.2	11.7	857
% loss	12.5	28.4	17.7	4.5	0.6	0.48
South Shields washed	155	1164	93	119	1224	32769
(standard deviation)	4.2	107	2.1	1.8	63	1230
South Shields unwashed	177	2466	179	135	1466	55307
(standard deviation)	7.3	179	4.9	3.8	75	4738
% loss	12.4	52.8	48.0	11.9	16.5	40.7

	Micronutrient total	Macronutrient total
Danebury washed	216	44608
Danebury unwashed	254	44824
% loss	15.0	0.48
South Shields washed	1531	33993
South Shields unwashed	2957	56773
% loss	48.2	40.1

Fig.7.4. Concentrations of the various elements analysed in washed and unwashed samples from Danebury and South Shields (values in $\mu\text{g g}^{-1}$).

Not surprisingly the values for the washed grains from Danebury and South Shields both have lower standard deviations than those of the unwashed, proving that removing surface contamination gives more accurate results and also reduces the variation within the sample replicate group. Given that other researchers have found large intra-sample differences when analysing archaeological bone (see Chapter 6, 6.1.) it was expected that the analyses from the grain samples would also show large standard deviations from the mean value. Surprisingly perhaps this was not found to be the case (see also Fig. 7.5.) - even the highest standard deviation of 4738 is fairly small when the mean value is 55307.

The experimental procedure for the microwave digestion followed for the archaeological material was the same as that used for modern grains. Following washing the samples were dried in an oven and weighed, then placed in 30ml. Kjeldahl flasks, crushed and pre-digested in 5ml. 4M HNO_3 . The digestion programs were the same as those detailed in Chapter 3 and analyses were by A.A.S.

7.3. Results

The results obtained cover a much wider range of values than those of the modern grain, suggesting, in some cases, a large degree of diagenetic change and contamination within the burial environment. The sites of Bucklersbury and Lancaster stand out as having extremely high values for copper, iron, manganese and zinc (although surprisingly the latter has a much lower value for the amount of calcium than any of the other sites considered). The mean concentrations of each element analysed are given at Fig. 7.5.

<u>Site</u>	<u>Cu</u>	<u>Fe</u>	<u>Mn</u>	<u>Zn</u>
Bucklersbury	480 (5.2)	5873 (268)	3635 (79)	209 (4.3)
Danebury	7 (0.3)	53 (1.9)	51 (1.3)	105 (1.6)
Forum	11 (1.3)	318 (6)	2463 (99)	41 (0.9)
Hibaldstow	38 (0.9)	1803 (56)	112 (2.9)	93 (2.3)
Lancaster	1148 (31)	4630 (199)	3408 (122)	1906 (50)
Shepton Mallet	55 (3)	1967 (46)	90 (1.7)	154 (2)
South Shields	155 (4.2)	1164 (107)	93 (2.1)	119 (1.8)
	<u>Mg</u>	<u>Ca</u>		
Bucklersbury	866 (35)	41110 (1977)		
Danebury	167 (10.4)	44441 (554)		
Forum	683 (21.7)	54386 (2257)		
Hibaldstow	335 (14.6)	44640 (2513)		
Lancaster	714 (65)	21742 (1714)		
Shepton Mallet	412 (13.6)	47674 (1725)		
South Shields	1224 (63)	32769 (1230)		

Fig. 7.5. Average concentrations of the various elements analysed in washed samples from archaeological contexts (values in $\mu\text{g g}^{-1}$). The standard deviations from the mean are given in parentheses.

The measured concentrations of the elements are much larger in the archaeological grain, which is not what was expected. It was thought that due to diagenetic changes the amounts of the micronutrients and magnesium might be reduced, but this was not seen in any sample. All of the archaeological grains show a much increased proportion of iron - especially those from Shepton Mallet and Hibaldstow. This is possibly due to long term burial in an iron rich soil, but as local soil samples were unobtainable this could not be tested. Larger amounts of the other micronutrients are probably associated with contamination and this is discussed later in this chapter. The only element which follows the expected pattern of diagenetic change (from the short term burial experiments) is calcium; all the archaeological samples contain extremely large concentrations of this element, with values approximately ten times those found in modern material.

If the results are presented graphically in the form of a column chart representing the total concentrations of copper, iron, manganese, zinc and magnesium analysed it becomes obvious that there are very large differences in the concentrations of the five elements extracted from each sample. For example the total concentration of these elements measured in the Lancaster sample is about twenty four times that found in the Danebury grains, whilst the Bucklersbury and Lancaster material contains about three to four times the amount measured in the other samples (see Fig. 7.6.). Magnesium is included with the four micronutrients in this case because the concentrations for this element are very much smaller than those of calcium, and graphing the two macronutrients together proved impractical.

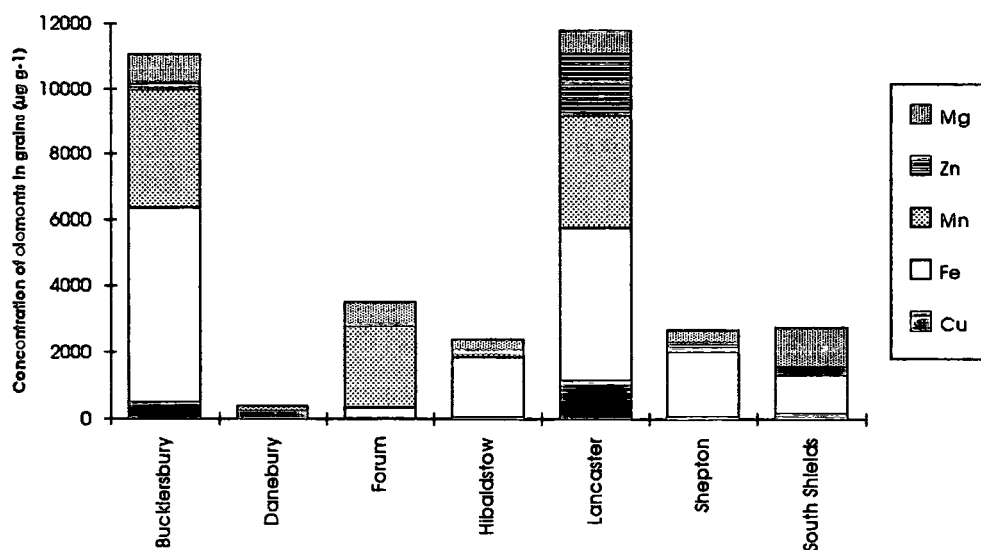

Fig. 7.6. Copper, iron, manganese, zinc and magnesium extracted from the archaeological material shown as a total concentration per sample (values in $\mu\text{g g}^{-1}$).

(If a similar graph to above is made ignoring the extra high values from Bucklersbury and Lancaster the resultant columns still bear no relationship to those created from the modern charred results. This is because the large concentrations of iron in the archaeological material makes up the majority of the columns and the other elements appear insignificant.)

If the values used for Fig. 7.6. are then presented as percentages of a whole (see Fig. 7.7.) the proportions of each element in each sample can be seen, without reference to values in other samples. Here again large differences are apparent between the samples, the most striking probably being the very large percentage of manganese in the Forum sample, and the high iron in the Hibaldstow and Shepton Mallet grains.

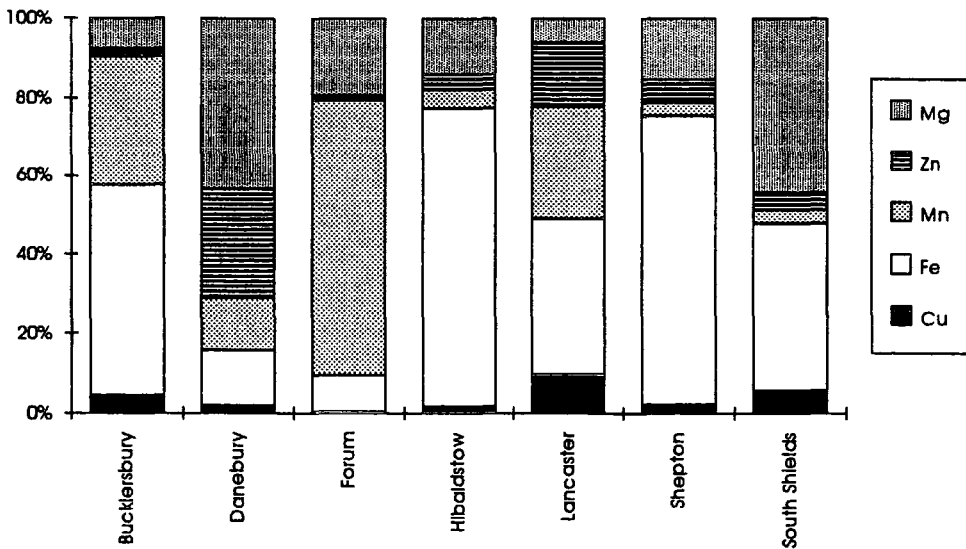

Fig. 7.7. The five elements extracted from the archaeological material presented as percentages of each sample.

This can serve to show similarities or differences from site to site, but apparent likenesses need to be verified by actual figures since each column relates only to itself and the elemental proportions, not to the other samples. For example, the proportions of the elements in the Hibaldstow and Shepton Mallet samples appear very similar. In numerical terms however the Hibaldstow grains contain 31% less copper, 8.3% less iron, 40% less zinc and 20% more manganese. Similarly, although zinc is the most abundant micronutrient present in the Danebury sample, comprising almost 50% of the total, the concentration of the extracted element was only 110 $\mu\text{g g}^{-1}$. The amount of zinc in the Bucklersbury sample made up only about 2% of the total, but the "real" concentration was 209 $\mu\text{g g}^{-1}$, almost twice that extracted from the Danebury grains.

The same point is further demonstrated regarding copper in the Lancaster and South Shields samples; in both the percentage of the element is about 10% of the total micronutrients, but the actual

concentration values are 1178 $\mu\text{g g}^{-1}$ for the former and only 155 $\mu\text{g g}^{-1}$ for the latter. Again, the Forum sample is largely (85%) composed of manganese, but the actual concentration value of 2463 $\mu\text{g g}^{-1}$ is 28% less than that in the Lancaster sample (3408 $\mu\text{g g}^{-1}$).

The proportional representation of the Danebury values is in fact very similar to that for the Lampeter sample (see Fig. 3.31.). However the actual concentration values for the two samples are quite dissimilar and the Danebury grain cannot therefore be related to the same soil type which produced the Lampeter spelt.

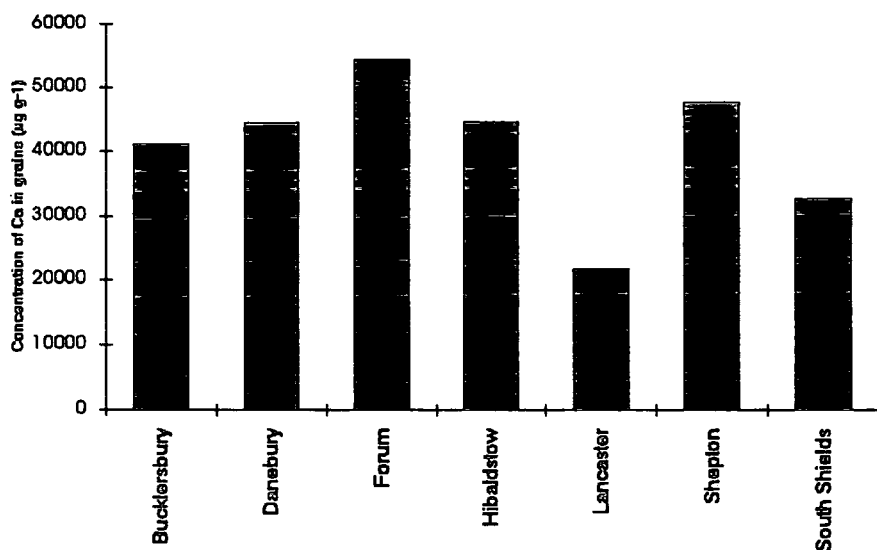

Fig. 7.8. Concentrations of calcium extracted from the archaeological samples (values in $\mu\text{g g}^{-1}$).

Concentration values for calcium are extremely high and range between 21742 $\mu\text{g g}^{-1}$ (Lancaster) and 54386 $\mu\text{g g}^{-1}$ (Forum). The value for the former site does stand out as being very low compared to the others and possible reasons are discussed below. The high concentrations are undoubtedly related to diagenetic changes occurring in the material during burial, as noted above.

7.4. Interpretation of results

A major problem associated with the samples is that those sites able to supply material cover a very wide range of social and cultural contexts. However, following closer examination of Fig. 7.6. it is possible to tentatively divide the results into three classes: (a) those with very small concentrations of elements (both individual and total) e.g. Danebury, (b) those with moderate total concentrations and relatively high iron e.g. Hibaldstow and Shepton, (c) those with either very large total concentration values or with high concentrations of particular elements (especially manganese) e.g. Bucklersbury, Lancaster and the Forum. The results from South Shields fall between the two latter groups and this is further discussed below.

These divisions can then perhaps be interpreted as indicating distinct burial environments which have a major effect on the elemental concentrations of buried material. The hillfort at Danebury is situated on a free-draining chalk soil subject to periodic and regular solution changes due to the British climate (i.e. rainfall throughout the whole year). Continual wetting by water flowing through the soil is almost certain to cause a significant degree of leaching, hence reducing the concentration of elements within the grain. In addition the high percentages of zinc and magnesium in the Danebury material (see Fig. 7.7.) may be due to these elements being more resistant to leaching than the others, suggesting that they may be more diagenetically stable than imagined from the short term burial experiments where concentrations of zinc were shown to decrease (see Chapter 6).

The burial environment suggested by the second division is perhaps in a free draining soil which has a moderate water retaining

capacity - not water-logged but not as dry as a chalk soil so that leaching is reduced. The higher iron values could be related to iron sesqui-oxides being washed through the top soil and concentrating at lower levels. It would be interesting to examine grain from other similar contexts to see whether results are comparable (in total concentration values and elemental proportions), and could perhaps be interpreted as being typical of a "rural" site.

Of the last group both the sites at Lancaster and Bucklersbury were associated with industrial usage in the Roman period and this probably, at least in part, accounts for the high elemental concentrations. In addition, Bucklersbury, Lancaster and the Forum are all urban sites with deeply stratified sediments still lying below present day towns with a history of continual occupation. Urban contexts are frequently water-logged or in soils which are highly water retentive and this provides a very stable and consistent soil and solution regime. Whilst enrichment by industrial pollution has almost certainly taken place at two of these sites there has been little chance of leaching and artefacts from a wet burial environment may prove to be the most useful for trace element studies.

The lower total concentration levels in the samples from the Forum can perhaps be explained in two ways. The extremely good preservation and intact outer layers of the grain may provide some protection against post-burial deposition of elements; grains from both Lancaster and Bucklersbury were not so well preserved and broken areas of the seed coat could allow solutions to penetrate more easily. Also, there is no evidence of industrial usage on the Forum site and it may be that the results obtained from the samples are more typical of "ordinary" urban residues.

The South Shields results appear to fall between those of Hibaldstow and Shepton, and the Forum. Although the site is below a present day town, this is not reflected in a high concentration of manganese, possibly implying that the intensity of previous occupation has not been as great as in London or Lancaster. Proportions of this element (and also of zinc) are much more in line with those of Hibaldstow and Shepton and probably relate more to the "rural" nature of the deposits. It would be extremely interesting to investigate the elemental concentrations of grain from other similar forts along Hadrian's Wall, such as Corbridge, to see whether similar results are obtained. The high proportion of magnesium is similar to that found in the Danebury samples but the reasons for this are unclear. The Roman fort was built on clay and magnesium minerals in this may have caused higher concentrations by uptake or simply by the diffusion gradient, which would be more significant in the less freely draining soil.

In retrospect two further points can be made with reference to analysis of archaeological material:

(a) The sample weights used were based on those weights found to be sufficient for successful analysis of modern charred grain; following examination of the results in this chapter it would appear that future work (especially that concerned with samples from urban and unleached rural contexts) could be conducted with smaller samples. This would have the considerable advantage of allowing sites where only smaller quantities of grain had been found to be included in any data set of archaeological material. From the tentative divisions made relating to burial environment it would seem reasonable to base sample weight on the type of environment

found at the site. Samples from very freely draining soils, such as those found at Danebury, apparently require the largest weights as the elements are not found in high concentrations. Conversely, those from "urban / industrial" sites (like Bucklersbury and Lancaster) could be reduced by at least 75% and still come well within the detection range of AAS. However, although it is technically possible to analyse significantly reduced weights these may not provide reliable results. Very small weights also significantly reduce the number of grains and analysis may then relate more to a single seed than the variation between a larger number. Since conditions can alter within a single burial environment analysed concentrations might then reflect a single spot rather than a whole context, possibly with the danger of very localised "hot spots". This would also seem to be a problem to be considered when analysis by ICPAES is advocated; this method uses very small sample weights which can only be meaningful if conditions are constant.

(b) The grains from Danebury were probably not ideal for using in a washing/cleaning experiment as they had already undergone a significant degree of leaching (as demonstrated by the percentage losses noted in Fig. 7.4.). Unfortunately this was the only sample with sufficient grains to allow such work. It is possible that the material from other contexts needed a longer period of washing to totally remove surface contamination - equally, that the sixty second wash may have started leaching some elements. This can only be resolved by further work with material from deeply stratified urban or water-logged sites. However, by being washed for a set period of time all the grains received the same initial treatment prior to analysis and consequently any "ill-effects" of cleaning should have been the same in each sample. This is certainly better

than no washing at all, where some grains could be leached and others still covered in soil residues or chemical deposits associated with specific sites, leading to totally misleading results.

In conclusion, whilst it is accepted that the archaeological samples formed a very small study group, it is hoped that these initial experiments have suggested the ranges of concentrations to be expected for each element, and which are most worthy of investigation. It would also seem possible to tell which sort of context (i.e. rural, urban, leached soil) the grains were buried in from the elemental proportions and concentrations. This necessarily requires a great deal more work with a larger sample set before definite conclusions can be drawn.

CHAPTER 8 IN CONCLUSION

The great tragedy of Science - the slaying
of a beautiful hypothesis by an ugly fact.
Huxley

8.1. Recapitulation and conclusions

The initial aim of this project was to establish whether a relationship between elements present in the grain and those of the soil (where the parent plant was grown) can be shown. Spelt wheat was chosen as the experimental material with which to establish a data set of elemental concentration values relating to modern grain. Previous work on trace elements in cereal plants was primarily botanical, involved seedlings, roots and leaves with very little investigation of mature grains. Most studies have been related to dietary or nutritional needs, fertiliser usage, or breeding of new cultivars for increased yield and tolerance of environments where minerals are not at optimum levels. Much of the recent experimental work is at cellular level and relates to specific actions of elements within micro-structures and organelles. Archaeological work on cereal grains has investigated proteins and lipid structures but no studies have analysed trace element concentrations.

Six elements were selected for investigation: the micronutrients copper, iron, manganese and zinc, and the macronutrients calcium and magnesium. All are essential elements within plants, and all have been shown to be present in cereal grains following sophisticated microprobe analysis.

To enable trace element analysis botanical material has first to be decomposed and the ions of interest released into a solution. Once released they can be measured by AAS. Initial experiments with a hot plate boiling method proved unsuccessful and a closed vessel microwave technique was developed whereby the grains could be broken down in nitric acid. Grain samples were acquired from twenty two sites and five replicates of each digested; analyses provided a concentration value for each element. The first series of microwave digests used fresh grains. As expected from previous botanical work on the micronutrients, copper was present in the lowest concentrations (range $3.7-8.5 \mu\text{g g}^{-1}$); iron, manganese and zinc were found in medium concentrations (ranges: Fe $23-51 \mu\text{g g}^{-1}$, Mn $11-46 \mu\text{g g}^{-1}$, Zn $24-82 \mu\text{g g}^{-1}$). The individual micronutrients gave widely ranging values, and a similar variety of results was seen when the mean micronutrient concentrations were presented as a total. High values of one element did not relate to low concentrations of another (or vice versa) and hence a similar total value was not found in all grains. Because the spelt plants are botanically the same this wide variation suggests that the different soils and growing environments are responsible for the changing amounts of elements taken up into the grains. The range for total micronutrient concentrations was from $79-151 \mu\text{g g}^{-1}$. It is interesting to note that whilst the Bristol samples have the lowest total micronutrient concentration, lower concentration values for each individual element were found in other samples (i.e. the lowest copper concentration was in the PBI sample, and the lowest iron in grain from Castellau). In these fresh digests copper made up less than 10% of the total micronutrient concentration in all samples (and less than 5% in many). Iron was found to account

for 20-40%, whilst manganese had a greater range from just under 10% to just over 40%. Zinc was found to be the micronutrient element present in the highest concentrations and made up over 50% of the total in nine samples, whilst a further five had over 40% zinc.

Statistical work revealed that there was a high correlation between iron/manganese concentrations in fresh grain (co-efficient = 0.67); relationships also existed between copper and the other micronutrients, although these were weaker and not significant (Cu/Fe = 0.42; Cu/Mn = 0.37; Cu/Zn = 0.36).

Of the macronutrients in fresh grain magnesium was found at higher concentrations than calcium (the range of the former being from 888-1460 $\mu\text{g g}^{-1}$, and the latter from 219-511 $\mu\text{g g}^{-1}$). Higher concentrations of magnesium are not associated with low ones of calcium and the correlation between the two elements in fresh grain was very low (0.04). When the concentrations of the two macronutrients are added together and viewed as a total magnesium accounts for over 65% in all samples.

All the results of analyses of the grain digests are given as a mean concentration value for each element, being the average of five replicates. Standard deviations from the mean were very low in all cases indicating that grains from the same site took up similar amounts of each element; had plants in different areas of each original growing site taken up varying amounts of the elements the results would have shown wider variation, and thus been less meaningful and reliable. Indeed, had a wide variation in results been evident it would probably not have been realistic or scientific to proceed with these investigations.

A second series of experiments examined the difference that charring causes to elemental concentrations. Charring of each

replicate was performed in an open crucible and the burned grains digested and analysed using the same methods as for fresh material.

Copper and calcium are similar in that each is found in higher concentrations in fresh grains, concentrations in charred samples being 20-30% less for copper and 10-30% less for calcium. These elements are the only ones to show an irrefutable and constant difference between charred and fresh grain. Manganese showed an exactly equal division with 50% of the samples giving a higher concentration in the fresh grains, and 50% in the charred. However, the differences between the fresh and charred samples were small, (less than 10%) suggesting this variation to be non-significant. Within the grains analysed, iron concentrations were higher in 70% of the fresh samples, the remaining 30% showing higher values in the charred grain. When zinc concentrations were examined it was found that 85% of the samples had higher values in the charred grain, and again the differences were generally less than 10%. All the charred grains had higher concentrations of magnesium than the fresh material, but the increases were not as great as those found with the other macronutrient and less than 10% for the majority of the samples. To recapitulate, Ca and Cu concentrations are higher in fresh grains, whilst those of Mg are higher in charred. There are definite trends to higher concentrations of Mg in charred material and Fe in fresh. Concentrations of Mn are equally divided with neither fresh or charred samples showing a bias to higher values. The reasons for these differences in concentration values between fresh and charred grains as yet are unclear; the copper and calcium results indicate that a proportion of these elements is volatile and lost on burning. The magnesium results, and most of those for iron and zinc, might suggest that amounts of these elements are in

unextractable forms in fresh grain but can be released by burning. The manganese results are difficult to explain as some samples give higher concentrations in fresh samples and some in charred. These findings would need amplifying by a study using much larger numbers of replicates, and perhaps then it would be possible to eliminate random variation by different statistical techniques.

The correlations between elemental concentrations in charred grain are similar to those in fresh samples, with the co-efficient for iron/manganese again being highest at 0.78. Correlation co-efficients for other elements in charred samples are Cu/Fe = 0.4; Cu/Mn = 0.35; Cu/Zn = 0.43; that for Mg/Ca is increased in the burned material to 0.37 but this is still a somewhat weak relationship and not statistically significant.

Two different calculations were used when examining elemental concentrations in charred samples: (a) those based on the pre-burning weight of the grain, for a direct comparison with the fresh material; and (b) those based on the charred weight of the sample to allow comparison with ancient material where the pre-burning weight is obviously unknown. The former give similar concentrations to those of the fresh grains as expected, whilst the latter give much higher values due to the lower sample weights. If the individual elements are examined the initial impression is of very little difference between fresh and charred (pre-burning calculation); as noted earlier most differences are less than 10%. However, if the micronutrient concentrations are presented as a total value then variations in the general "pattern" between sites appear. These are related to the percentage weight loss of the grain on burning - thus where a sample loses less weight (due to individual variations in grain biochemistry) the grains are comparatively heavier and the

concentration values lower. This is most clearly seen in the samples from Boston, Bristol, Dalton, Norwich, Oxford, Sheffield and Wirral, where the values for the charred weight samples are lower than expected (i.e. the column heights are lower). With the macronutrients the total concentration values remain similar in fresh and charred samples - the decrease in calcium concentrations in the charred being cancelled out by the increase in magnesium, and vice versa. If the values are presented as percentages of a whole the "pattern" remains the same for fresh and charred grains but the actual percentages are different (i.e. calcium is always lower in charred material). This repetition of the pattern is not seen in the micronutrients where some samples have lower/higher values for iron, magnesium and zinc concentrations.

By use of an ANOVA program in Microsoft "Excel" it was possible to prove that significant differences are present in the elemental concentrations of grains grown on different soil types, both in fresh and charred material. All the results gave low P-values showing that the differences between samples were greater than those within the samples, indicating, (a) that the different values obtained from grains grown on the various sites were real and had not occurred by chance; and, (b) that there was very little variation in the results from the replicate samples of each individual site (as was also proved by the low standard deviations from the mean values).

The next series of experiments attempted to determine what relationships existed between the concentration values in the grains and those of the parent soil. Analyses demonstrated that the soil samples contained widely different concentrations of each element both in total and available form. Of the micronutrients iron was the

principal element, accounting for more than 60% of the total in all but two samples. Manganese was also important being found to form a higher percentage of the total than zinc in thirteen of the fifteen samples analysed.

In the grain samples magnesium was always found at higher concentrations than calcium (reflecting its importance in plant metabolism) but this was not the case with the soils where just over 50% of the samples have higher calcium (and hence just under 50% have higher magnesium concentrations). Various workers have suggested that soil pH is of prime importance in nutrient availability but this was not indicated in this series. The correlations between pH and available element concentrations gave uniformly low values, the highest of which was between soil pH / available manganese (-0.3) implying only a weak relationship.

When the results for available soil nutrients and fresh / charred grain elemental concentrations were analysed statistically there were less significant relationships than had been hoped. Correlations of copper concentrations in soil and grain gave co-efficients of 0.54 (fresh) and 0.46 (charred), the former of which is significant (at $p = 0.05$). A relationship to the same degree of significance was found between the concentrations of available iron in the soil and that in charred grains (co-efficient = 0.52). Correlation co-efficients were also calculated for soil pH and elemental concentrations in fresh grains; of these only the values for iron (0.4) and manganese (-0.4) are of interest, and these only indicate weak and non-significant relationships.

Whilst these results cannot prove a relationship between elements in the soil and the grain it must be noted that the sample

size is very small and the pH range limited; a larger series may be of more use in indicating links between the concentration values.

A series of cereal crop growing experiments designed to assess the importance of genetic and environmental factors on elemental uptake into the grain suggested that magnesium and calcium was largely controlled by the environment and hence the amount of these elements in the growing medium. This suggests that the concentrations of these two elements in the soil is directly related to that in the grain but unfortunately this cannot be proved as it was not possible to obtain reliable results in the analyses of the soil samples for available calcium and magnesium concentrations. Investigation of the concentrations of these two elements may therefore prove worthwhile for future research. Since magnesium is found mainly in the phytin fraction of the aleurone layer it may also be possible to examine particular seed components in order to assess the differences in concentration values in various cells.

Both genetic and environmental factors appear to affect micronutrient uptake into grains which obviously complicates the investigation of soil/plant relationships. At present it is not possible to elucidate what percentage of elemental uptake is controlled by which factor, and indeed, it may not even be constant.

A small number of archaeological samples were selected for study and prior to their analysis a short-term experiment was performed with modern grain to assess which elements might be affected by diagenetic changes due to burial. Experimental work in this study only lasted for one year but the general trend over this period was for the concentrations of all elements (except calcium) to decrease in a manner which was not easily predictable. Although copper is only present in comparatively low concentrations the

losses are significant, ranging from 19-33%. The losses for the other micronutrients are lower, ranging from 3-17% (iron), 5-16% (manganese) and 4-17% (zinc). Magnesium shows a wider range of percentage decrease in the mean concentration value with losses of 27-111%, whilst calcium is the only element to demonstrate an increase in concentration value among the samples examined, with increased values ranging from 62-131%. Obviously this is a short-term experiment and changes observed in the elemental concentrations over a one year period cannot be categorically stated to also occur over a longer time scale, as was in fact discovered when archaeological samples were analysed. Trends indicated that calcium concentrations increase following burial but that decreases could be expected in those of copper, iron, manganese, zinc and magnesium, the magnitude of change being greatest in the two macronutrients. Unfortunately these changes are in no way predictable and varied between and within the samples despite their being buried in the same environment. It was found that standard deviations from the mean concentration value increased with burial time indicating that those results from the longer burial periods showed wider variation and were becoming less reliable and therefore less useful as a research tool.

Analyses of the archaeological grains commenced with a small scale experiment on the effects of sample washing as it was felt that soil particles and adherent material could give false concentration values. Following examination of the results all ancient samples were washed for one minute in ultra-pure water prior to acid digestion and analysis using the same methods as those employed for the modern material.

It was hoped that the analyses of charred archaeological material might bear some relationship to those of charred modern grain samples, but this was not found to be the case. Fig. 8.1. shows the concentration values measured in archeological samples together with the ranges for each element found in modern material. Of the values for copper only three (Danebury, Forum and Hibaldstow) fall within the range of those found in modern burned spelt; the same is true for manganese but the sites concerned are different (Danebury, Shepton Mallet and South Shields). If the iron values are examined only the Danebury result is within the modern range; the reverse is found with zinc as only the Lancaster and Forum values are outside those obtained for modern material. All of the magnesium values are lower than those in modern grain, and all of the calcium ones are much greater which follows the trend seen in the diagenetic experiments.

Site:	Cu	Fe	Mn	Zn	Mg	Ca
Bucklersbury	480	5873	3635	209	866	41110
Danebury	7	53	51	105	167	44441
Forum	11	318	2463	41	683	54386
Hibaldstow	38	1803	112	93	335	44640
Lancaster	1148	4630	3408	1906	714	21742
Shepton	55	1967	90	154	412	47674
South Shields	155	1164	93	119	1224	32769
Modern range	7-37	76-265	36-230	88-435	3809- 8145	765- 1874

Fig. 8.1. Table to show the range of mean concentration values for each element in charred modern and ancient samples. (Values are in $\mu\text{g g}^{-1}$.)

Closer examination of the manganese results shows that if the "contaminated" sites are disregarded (Bucklersbury, Forum and Lancaster) the remaining values are in the lower half of the

expected range - and the diagenetic experiment indicated that concentrations of this element were likely to be reduced following burial. This is also true for zinc; the very high concentration found in the Lancaster sample is undoubtedly due to contamination and if this is ignored the rest of the results are again in the lower part of the expected range. What is impossible to assess is to what degree the concentration value in an archaeological sample is due to diagenetic change, or how much was present in the material prior to burial. For example, it is easily seen that the Bucklersbury, Forum and Lancaster grains have disproportionately high concentration values for manganese; site reports give evidence of industrial working and contamination but to what degree or magnitude this has changed the "original" concentration value is totally unknown. The range for this element in the modern samples is 36-230 $\mu\text{g g}^{-1}$; if the high values in the archaeological samples are disregarded those remaining range from 51-112 $\mu\text{g g}^{-1}$: these values may be (a) reasonably close to those found in the grains when they were freshly charred, or (b) they may be enhanced, or (c) they may be reduced, either greatly or to only a small degree. In addition to all these variables one must also add the possibility that the range found in the modern charred samples is itself restricted, and that grain grown on other soil types could have both higher and lower concentrations of manganese.

The concentration values for copper and iron are also difficult to interpret. The high results for copper at Bucklersbury and Lancaster are undoubtedly related to industrial processes (during the Roman period) at those sites, but this explanation cannot be applied to the high concentrations found in the South Shields sample. The copper concentration in the Forum samples are

also perhaps unexpectedly low given that this site was also thought to be "contaminated". Similarly the iron results pose problems; the short term diagenetic experiment suggested that the concentration of iron becomes reduced following burial, but, apart from the Danebury grains, all the other samples have concentration values in excess of the modern range. Iron is one of the major elements in the soil (despite available iron often only being present in low amounts in available terms) and these results suggest that although in the short-term it is lost from buried material, long-term burial leads to deposition of iron salts within the grains.

Unfortunately the chosen suite of elements have proved unsuccessful in elucidating any relationships between elemental concentrations in modern and archaeological material, and therefore it would seem it is currently not feasible to source ancient grain or to differentiate grains which have come from different environments using these methods, although it may be possible to provide some limited and general indication of the nature of the burial environment i.e. waterlogged / urban, free-draining, leached or contaminated (either in the archaeological or recent context).

8.2. Discussion

Dick et al. (1985) working with barley cultivars examined concentrations of potassium, sodium, calcium, magnesium, copper, iron, manganese and zinc and found that "there is little or no correlation between available nutrients in the soil and plant uptake. Whilst many soil chemical properties are related to the composition of the crop grown on that soil, most of these relationships are slight and insignificant". However, the variability in plant composition (noted in every paper relating to

mineral concentrations in botanical material) remains unaccounted for despite multiple correlations between grain, soil and pH, which suggests that other environmental and genetic factors have a very significant determinative role in plant biochemistry. Soil temperature and drainage (which were not examined in this project) have been identified as having an important effect on nutrient uptake (Williams and Moore, 1952; Bjerre and Schierup, 1985) and it may be that small variations in these factors have considerable influence on elemental take-up by the plant. Whilst water supply and temperature may be relatively easily regulated in laboratory or greenhouse, they would be difficult both to monitor and control in the field leading to further problems in analysing trace element relationships.

In retrospect, the series of fifteen sites examined in this current study was perhaps too small to indicate accurately relationships between soil / grain elemental concentrations, and that a larger sample is required. However, since the material was provided from the sites used in van der Veen's study, the number of samples was limited to grain produced in those locations.

Considering the results obtained it seems perhaps that the choice of elements was not ideal; literature current at the start of the project indicated that large differences in the concentrations of the elements chosen could be expected both in the grain and the soil. This was indeed found to be the case, but any relationship between the values proved to be illusive. Had an ICPMS machine been available, it might have been more instructive to examine the lanthanide or rare earth elements (a series of fourteen elements from lanthanum to lutetium). These are a particularly useful group of elements in geochemical mapping studies because, by virtue of

their chemical similarity, they tend to behave as a group. Their "natural" pattern can be radically altered by geochemical processes leading to a wide variation of patterns found in soils and rocks affecting concentrations of the various elements, the general ratio of light to heavy rare earths, and anomalies for specific elements in the group. McCurdy et al. (1992) have successfully used these variations to source French wines from four different regions. Concentrations of the elements are very low, being measured in picogrammes per millilitre (or parts per trillion) but standard deviations were low in the French series indicating a high level of reliability. One possible problem relating to grain studies is that the sourcing may be too accurate; wines from the same geographical area (Bordeaux) had distinctly different patterns, suggesting that it may be possible to link a particular rare earth element pattern to an individual vineyard. Sourcing grain would ideally relate the harvested material to a particular soil type or tract of landscape; linking material to one single field in an area would probably not be useful and would certainly complicate the data set.

~~In addition to the problems associated with environment and~~ soil type there are obviously also genetic factors affecting the elemental uptake into the plant. With a view to sourcing archaeological material this obviously creates problems. It is known that the Romans grew wheat around some of their forts, but if the sown grain came from a number of different sources the resultant crop would have a variety of different concentration values for each element - hence grain found in the archaeological context could be grown locally but appear to originate in a number of other areas. Neither is this the only problem associated with analysing ancient samples since they are also affected by diagenetic changes.

Although the six elements analysed cannot be applied in sourcing studies it may be possible to examine the relative trace element values from different samples within the same site to demonstrate that a variety of sources were being used - even if not where they came from. This would be possible in two ways: (a) if samples of grain were analysed and showed a large standard deviation from the mean value, suggesting different concentrations of the elements within that group and therefore different origins; or (b) if analytical techniques were developed sufficiently to analyse single grains allowing the formation of a data set based on individual values, a large range of values indicating a variety of grain production sites.

In sites where industrial contamination exists it is possible that localised areas may have greater concentrations of elements leading to enrichment of adjacent material, and for this reason this type of site may not be useful for trace element studies. It would be useful to analyse grain samples from different locations within a storage pit (i.e. bottom, sides, centre and top), especially if such contexts could be found in varying geological areas. In the same way it would also be interesting to experiment with contaminant elements, such as copper, manganese and zinc, by, for example, burying pieces of metal wire around the margins of a context to investigate to what distance buried grains showed increased concentrations of the element when analysed. Obviously, for studies such as these to be meaningful in any way experimental work would have to be carried on over an increased time period. It could also be argued that such artificial creation of an environment does not mirror what happens in reality, but results would at least give basic indications of what might be expected.

There are a number of archaeological questions to which trace element studies are applicable. For example, it has been suggested that it might be possible to theoretically detect loss of fertility over time (in field soil) if one were able to say that granaries continued to use the same source of grain. However, this poses a number of problems. With some kinds of site (e.g. a small isolated farmstead) it may be safe to make the assumption that grain is likely to have come from the same local fields, but this is obviously not applicable to a Roman fort. Loss of soil fertility would presumably be extremely difficult to detect and assess from elemental concentrations in grains because elements are present in the soil in different amounts and it can be assumed that they do not decline to infertile levels at the same rate. Additionally it may not be possible to determine the percentage of elements occurring naturally in soils and those applied through manuring and fertilising of the ground which would doubtless take place once crop yields were reduced.

8.3. Summary

The current research project was in many ways rather negative in that it proved it was not possible to relate elements in the grain to those in the soil at this stage; neither was a significant and reproducible relationship between the elements in modern and archaeological grain discovered. Hence it was not feasible to source grain to a particular soil type in modern or ancient samples. Whilst it may be possible with more sophisticated techniques and different elements to establish a link between elemental concentrations in soil and cereal crop, there are a great many variables to be investigated before such results can even tentatively be applied to

ancient materials. It is important that the nature and limitations of trace element studies are appreciated in relation to archaeological (and modern) material, and the burial environment, diagenetic change and factors within the living plant all need to be understood more fully before sourcing work becomes feasible.

BIBLIOGRAPHY

Abu-Samra, A., Morris, J.S. and Koirtyohann, S.R. (1975) Wet ashing of some biological samples in a microwave oven.

Anal. Chem. **47**, 1475-1477

Amberger, A. (1973) The role of manganese in the metabolism of plants.

Agrochimica **17**, 69-83

Anderson, A.J. and Underwood, E.J. (1959) Trace element deserts.

Scien. Amer. **200**, 97 - 106

Applied Geochemistry Research Group (Imperial College of Science and Technology)

(1978) The Wolfson Geochemical Atlas of England and Wales.

Oxford University Press, Oxford.

Archer, F.C. and Hodgson, I.H. (1987) Total and extractable trace element contents of soils in England and Wales.

J. Soil Sci. **38**, 421-431

Arnon, D.I. and Stout, P.R. (1939) The essentiality of certain elements in minute quantity for plants with special reference to copper.

Plant Physiol. **14**, 371-375

- Auel, D., Petzelt, C. and Capesius, I. (1980) The mitotic Ca^{2+} - adenosine triphosphatase in proliferating tissue of *Vicia faba*.
Cell Biol. Int. Rep. 4, 869-872
- Bacon, R.K. and Collins, F.C. (1987) Interaction of wheat cultivars and soil series.
Arkansas Farm Research 36 (2), 4
- Baize, D. (1988) Soil Science Analyses: A guide to current use.
Translated G. Cross (1993) John Wiley and Sons, Chichester.
(originally published in French by I.N.R.S., Paris)
- Baker, A.S. and Smith, R.L. (1974) Preparation of solutions for atomic absorption analyses of Fe, Mn, Zn and Cu in plant tissue.
J. Agric. Food Chem. 22, 103-107
- Barlow, E.W.R., Lee, J.W., Munns, R. and Smart, M.G. (1980) Water relations of the developing wheat grain.
Aust. J. Plant Phys. 7, 519-525
- Barton, R. (1970) The production and behaviour of phytoferritin particles during senescence of *Phaseolus* leaves.
Planta 94, 73-77
- Beeson, K.C. (1941) The mineral composition of crops with particular reference to the soils in which they were grown.
U.S. Dept. Agric. Misc. Publ. No. 369 (Washington)

- Bell, G.D.H. (1987) The history of wheat cultivation.
(in : Wheat breeding - its scientific basis. pp31-49
ed. F.G.H. Lupton. Chapman and Hall, London)
- Bidwell, P.T. and Holbrook, N. (forthcoming) The Roman fort at South Shields:
the excavation of the headquarters building and the south west gate.
- Bingham, J., Law, C. and Miller T. (1991) Wheat: Yesterday, Today and Tomorrow.
Plant Breeding International (P.B.I.) and AFRC Institute of Plant
Science Research, Cambridge.
- Bishop, N.J. (1971) Photosynthesis : the electron transport system of green plants.
Ann. Rev. Biochem. 40, 197-226
- Bjerre, G.K. and Schierup, H.H. (1985) Influence of waterlogging on availability and
uptake of heavy metals by oat grown in different soils.
Plant Soil 88, 45-56
- Bohme, H. (1979) On the role of ferredoxin and ferredoxin-NADP⁺ reductase in cyclic
electron transport in spinach chloroplasts.
Eur. J. Biochem. 72, 283-289
- Bohner, H., Bohme, H. and Boger, P. (1980) Reciprocal formation of cytochrome
E553 and the influence of cupric ions on photosynthetic electron transport.
Biochim. Biophys. Acta. 592, 103-112
- Boken, P. (1970) Studies on methods for determining varietal utilisation of nutrients.
II. Barley varieties and phosphorus.
Plant Soil 33, 645-652

- Bolland, M.D.A. and Baker, M.J. (1988) High phosphorus concentrations in seeds of wheat and annual medic are related to higher rates of dry matter production in seedlings and plants.
Aust. J. Expt. Agric. 28, 765-770
- Borkovec, V., Prochazka, S. and Ibrahim, M.E.D. (1990) Transport of C-14-sucrose and C-14-benzyl adenine in winter wheat (*Triticum aestivum* L.) in the pre-anthesis period.
J. Agron. Crop Sci. 165, 217-223
- Breeze, D.J. (1984) Demand and supply on the northern frontier.
(in : Between and Beyond the Walls. Essays on the Prehistory and History of North Britain in Honour of George Jobey. pp264-286
eds. R. Miket and C. Burgess. John Donald Publ. Ltd., Edinburgh.)
- Brewster, J.L. and Tinker, P.B. (1972) Nutrient flow rates into soils.
Soils Fert. 35, 355-359
- Brown, A.B. and Blakely, R.L. (1985) Biocultural adaptation as reflected in trace element distribution.
J. Human Evol. 14, 461-468
- Buttrose, M.S. (1963) Ultrastructure of the developing aleurone cells of wheat grain.
Aust. J. Biol. Sci. 16, 768-774
- Campbell, C.A., Cutforth, H.W., Selles, F., DePauw, R.M. and Clarke, J.M. (1990) Dynamics of dry matter, N and P accumulation in the developing kernels of four spring wheat cultivars for irrigation and dryland.
Can. J. Plant Sci. 70, 1043-1056

Carruthers, W. (1986) The late Bronze Age midden at Potterne.

Circaea 4 (1), 16 - 17

Carruthers, W. (1991) Fishbourne Roman Palace, West Sussex: carbonised plant
macrofossils from garden features.

Ancient Monuments Laboratory Report 130 / 91

Historic Buildings and Monuments Commission for England.

Carruthers, W. (1992) Wanborough Green Lane: analysis of charred plant remains
from deposits associated with Roman priestly regalia.

Ancient Monuments Laboratory Report 65 / 92

Historic Buildings and Monuments Commission for England.

Carruthers, W. (1993) A charred grain deposit from Ambleside Roman fort granary,
Cumbria.

Ancient Monuments Laboratory Report 11 / 93

Historic Buildings and Monuments Commission for England.

Cawse, P.A. (1982) Inorganic particulate matter in the atmosphere.

Envir. Chem. 2, 1-62

CEM (1989) Instructions for use of lined digestion vessels. pp1-14

CEM Corporation, Matthews, USA.

Chaney, R.L., Brown, J.C. and Tiffin, L.O. (1972) Obligatory reduction of ferric chelates
in iron uptake by soybeans.

Plant Physiol. 50, 208-213

- Chaudhry, F.M. and Loneragan, J.F. (1972) Zinc absorption by wheat seedlings: II. Inhibition by hydrogen ions and by micronutrient cations.**
Soil Sci. Soc. Am. Proc. 36, 327-331
- Chaudhry, F.M. and Loneragan, J.F. (1972a) Zinc absorption by wheat seedlings: I. Inhibition by macronutrient ions in short-term experiments and its relevance to long-term zinc nutrition.**
Soil Sci. Soc. Am. Proc. 36, 323-326
- Christ, R.A. (1974) Iron requirement and iron uptake from various iron compounds by different plant species.**
Plant Phys. 54, 582-585
- Clapham, A. and Scaife, R.G. (1988) A pollen and macrofossil investigation of Oakbank Crannog, Loch Tay, Scotland.**
(in : The exploitation of wetlands. pp293 - 325
eds. P. Murphy and C. French.)
BAR British Series 186 Oxford.
- Clarkson, D.T., Brownlee, C. and Ayling, S.M. (1988) Cytoplasmic calcium measurements in intact higher plant cells : results from fluorescence ratio imaging of Fura-2.**
J. Cell Sci. 91, 71-80
- Cochrane, M.P. (1983) Morphology of the crease region in relation to assimilate uptake and water loss during caryopsis development in barley and wheat.**
Aust. J. Plant Phys. 10, 473-491

- Collins, M. (1989) Mineral concentrations in whole crop and pressed forage of three legumes.
Agron. J. 81, 901-906
- Columella, L. J. M. (fl. 1st. century A.D.) De Re Rustica. Book II.IX.3.
(Translated: H.B. Ash (1951), William Heinemann, London.)
- Crush, J.R., Evans, J.P.M. and Cosgrove, J.P (1989) Chemical composition of ryegrass (*Lolium perenne* L.) and prairie grass (*Bromus willdenowii* Kunth) pastures.
New Zeal. J. Agric. Res. 32, 461-468
- Cunliffe, B. (1991) Iron Age Communities in Britain. pp213-370
Routledge, London.
- Cunliffe, B. and Poole, C. (1991) Danebury : an Iron Age hillfort in Hampshire. The excavations 1979-1988. Vols. 4 and 5.
CBA Research Report 73, London.
- Czerniejewski, C.P., Shank, C.W., Bechtel, W.G. and Bradley, W.B. (1964) The minerals of wheat flour and bread.
Cereal Chem. 41, 65-72
- Davies, B.E. and Jones, L.H.P. (1988) Micronutrients and toxic elements.
(in: Russell's soil conditions and plant growth. pp 780-814
ed. A. Wild. Longmann Scientific and Technical, Harlow)
- Davies, R.W. (1971) The Roman military diet.
Britannia 2, 122 - 142

- Davies, R.W. (1989) Service in the Roman Army. pp187-206
(ed. D.Breeze and V.A. Maxfield. Edinburgh University Press, Edinburgh)
- Dell, B. (1981) Male sterility and anther wall structure in copper deficient plants.
Ann. Bot. 48, 599-608
- DeNiro, M.J. (1985) Postmortem preservation and alteration of in vivo bone collagen
isotope ratios in relation to palaeodietary reconstruction.
Nature 317, 806-809
- Dick, A.C., Malhi, S.S., O'Sullivan, P.A. and Walker, D.R. (1985) Relationships of soil
chemical properties to composition of five barley cultivars, and relationships
between constituents of whole plants and of grain.
Plant and Soil 88, 23-29
- Dickson, C. (1989) The Roman army diet in Britain and Germany.
Archaobotanik, Dissertationes Botanicae, 133, 155 - 166,
- Dickson, C. (1990) Experimental processing and cooking of emmer and spelt wheats
and the Roman army diet.
(in: Experimentation and Reconstruction in Environmental Archaeology.
pp33-41
ed. D.E. Robinson. Oxbow Books, Oxford.)
- Dieter, P. and Marme, D. (1980) Partial purification of plant NADKinase by calmodulin-
sepharose affinity chromatography.
Cell Calcium 1, 279-286

- Dieter, P. and Marme, D. (1981) Far-red light irradiation of intact corn seedling affects mitochondrial and calmodulin dependent microsomal Ca^{2+} transport.
Biochem. Biophys. Res. Comm. 101, 749-755
- Donaldson, A.M. and Turner, S. (1977) A pollen diagram from Hallowell Moss, near Durham City.
J. of Biogeography 4, 25-33
- Drewett, P.L. (1982) Later Bronze Age downland economy and excavations at Black Patch, East Sussex.
Proc. Prehist. Soc. 48, 321 - 400
- Duffus, C.M. and Rosie, R. (1976) Changes in trace element composition in developing barley grain.
J. Agric. Sci. Camb. 87, 75-79
- Duffus, C.M. and Slaughter, J.C. (1980) Seeds and their uses. p.4.
John Willey and Sons, Chichester.
- Epstein, E. and Leggett, J.E. (1954) The absorption of alkaline earth cations by barley roots: Kinetics and mechanisms.
Am. J. Botany 41, 785-791
- Erdman, J.A. and Moul, R.C. (1982) Mineral composition of small grain cultivars from a uniform test plot in South Dakota.
J. Agric. Food Chem. 30, 169-174

- Feldman, M. (1976) **Wheats.**
(in : Evolution of crop plants. pp 120-128
ed. N.W.Simmonds. Longmans, London.)
- Field, N.H., Matthews, C.L. and Smith, I.F. (1964) **New Neolithic sites in Dorset and
Bedfordshire.**
Proc. Prehist. Soc. 30, 352-381
- Fischer, R.A. (1973) **The effects of water stress at various stages of development
on yield processes in wheat.**
(in: Plant response to climatic factors. pp233-234
UNESCO, Paris)
- Flowers, T.J. and Yeo, A.R. (1992) **Solute transport in plants.**
Blackie Academic and Professional, London.
- Francalacci, P. (1989) **Dietary reconstruction at Arene Candide Cave (Liguria, Italy)
by means of trace element analysis.**
J. Arch. Sci. 16, 109-124
- Francalacci, P. and Tarli, S.B. (1988) **Multi-elementary analysis of trace elements
and preliminary results on stable isotopes in two Italian prehistoric sites.
Methodological aspects.**
(in : Trace elements in environmental history. pp 41 - 52
eds. G. Grupe and B. Herrmann. Springer-Verlag, Berlin.)
- Frazier, J.C. and Appalanaidu, B. (1965) **The wheat grain during development with
reference to nature, location and role of its translocatory tissues.**
Am. J. Bot. 52, 193-198

- French, R.J. and Ewing, M.A. (1989) Soil type influences the relative yields of different cereals and crop legumes in the Western Australian wheatbelt. *Aust.J. Expt. Agric.* **29**, 829-835
- Frere, S. (1978) *Britannia : A History of Roman Britain.* (p 260)
Routledge and Kegan Paul, London.
- Frere, S. (1991) Roman Britain in 1990. 1. Sites explored.
Britannia **22**, 279
- Fukuoka, T. and Horino, T. (1989) Differences in nitrogen and mineral contents, and their balance between hard and soft wheats.
Jap. J. Crop Sci. **58**, 502-506
- Gaudillere, J.P. and Barcelo, M.O. (1991) The effects of water potential and osmotic potential on wheat tiller growth.
Agronomie **10**, 423-431
- Gilman, L.B. and Engelhart, W.G. (1989) Recent advances in microwave sample preparation.
Spectroscopy **4**, 14-21
- Giordano, P.M., Noggle, J.C. and Mortvedt, J.J. (1974) Zinc uptake by rice as affected by metabolic inhibitors and competing cations.
Plant Soil **41**, 637-646

- Giorgi, J. and Robinson, M. (1985) **The Environment.**
(in: M. Foreman and S. Rahtz. **Excavations at Faccenda Chicken Farm near Alchester.)**
Oxoniensia 49, 38-46
- Goldstein, J.I., Newbury, D.E., Echlin, P., Joy, D.C., Romig, A.D., Jr., Lyman, C.E., Fiori, C. and Lifshin, E. (1992)
Scanning electron microscopy and X-ray microanalysis.
(**Chapt. 9. Quantitative X-ray analysis: Practice and theory. pp 417-523**)
Plenum Press, New York.
- Goodburn, R. (1978) **Roman Britain in 1977. 1. Sites explored.**
Britannia 9, 433
- Grant, C.A. and Bailey, L.D. (1989) **The influence of soil levels of Ca, Mg, P and Zn on the dry matter yield and chemical composition of flax (*Linum usitatissimum* L.).**
Comm. Soil Sci. Plant Anal. 20, 1163-1179
- Grant, C.A., Racz, G.J. and Bailey, L.D. (1988) **The effects of Ca and K levels on the herbage yield and nutrient composition of barley plants grown in high Mg soils.**
Comm. soil Sci. Plant Anal. 19, 1813-1835
- Greig, J.R.A. (1990) **The prehistoric riverside settlement at Runnymede, Surrey : the botanical story (Final Report).**
Ancient Monuments Laboratory Report 40/90
Historic Buildings and Monuments Commission for England

Greig, J.R.A. (1991) The British Isles.

(in : Progress in Old World Palaeoethnobotany. pp299 - 334

eds. W.V. Zeist, K. Wasylkowa and k.E. Behre. Balkema, Rotterdam)

Griffing, L.R. and Ray, P.M. (1979) Dependence of cell wall segregation on calcium.

Plant Physiol. 63 (supp.) 51

Grupe, G. and Piepenbrink, H. (1988) Trace element contaminations in excavated human bones by micro-organisms.

(in : Trace elements in environmental history. pp 103 - 112

eds. G. Grupe and B. Herrmann. Springer-Verlag, Berlin)

Guzy, M.R., Edhaie, B. and Waines, J.G. (1989) Yield and its components in diploid, tetraploid and hexaploid wheats in diverse environments.

Ann. Bot. 64, 635-642

Hall, T.A. and Gupta, B.L. (1983) The localisation and assay of chemical elements by microprobe methods.

Quart. Rev. Biophysics 16, 279-339

Harlan, J.R. (1965) The possible role of weed races in the evolution of cultivated plants.

Euphytica 14, 173-176

Harlan, J.R., de Wet, J.M.J. and Price, E.G. (1973) Comparative evolution of cereals.

Evolution 27, 311-325

Harris, D.R. (1967) New light on plant domestication and origins.

Geog. Rev. (N.Y.) 57, 90-107

- Harrison, R.M. and Chirgawi, M.B. (1989) The assessment of air and soil as contributors of some trace metals to vegetable plants. III. Experiments with field grown plants. *Sci. Total Envir.* 83, 47-62
- Harter, R.D. (1983) Effect of soil pH on adsorption of lead, copper, zinc and nickel. *Soil.Sci. Soc. Am. J.* 47, 47-51
- Helbaek, H. (1966) Commentary on the phylogenesis of *Triticum* and *Hordeum*. *Econ. Bot.* 20, 350-360
- Henderson, P., Marlow, C.A., Molleson, T.I. and Williams, C.T. (1983) Patterns of chemical change during bone fossilization. *Nature* 306, 358-360
- Herrmann, B. and Grupe, G. (1988) Trace element content in cremated human remains. (in : Trace elements in environmental history. pp 91 - 101 eds. G. Grupe and B. Herrmann. Springer-Verlag, Berlin)
- Herth, W. (1978) Ionophor A 23187 stops tip growth but not cytoplasmic streaming in pollen tubes of *Lilium longiflorum*. *Protoplasma* 96, 275-282
- Hesse, P.R. (1971) A textbook of soil chemical analysis. John Murray, London.
- Hillman, G.C. (1982) Evidence for speltling malt. (in: R.Leech. Excavations at Catsgore 1970-73 : A Romano-British village. pp137-141 Western Archaeological Trust. Excavation Monograph No. 2)

Hillman, G.C. (1986) Plant foods in ancient diet: the archaeological role of palaeofaeces in general and Lindow Man's gut contents in particular. (in : Lindow Man; The Body in the Bog. pp99 - 115 eds. I.M. Stead, J.B. Bourke and D.Brothwell. British Museum, London)

Hodgson, J.F. (1963) Chemistry of the micronutrient elements in soils. Adv.Agron. 15, 119-159

Hodgson, J.F., Geering, H.R. and Norvell, W.A. (1965) Micronutrient cation complexes in soil solution : partition between complexed and uncomplexed forms by solvent extraction. Proc. Soil Sci. Soc Am. 29, 665-669

Hofer, J.M., Dekker, E.L., Reynolds, H.V., Woolston, C.J., Cox, B.S. and Mullineaux, P.M. (1992) Coordinate regulation of replication and virion sense gene expression in wheat dwarf virus. The Plant Cell 4, 471-476

Holden, T.G. (1986) Preliminary report on the detailed analyses of the macroscopic remains from the gut of Lindow Man. (in : Lindow Man; The Body in the Bog. pp 116 - 125 eds. I.M. Stead, J.B. Bourke and D. Brothwell. British Museum, London)

Huang, B.R., Taylor, H.M. and McMichael, B.L. (1991) Behaviour of lateral roots in winter wheat as affected by temperature. Environ. Exp. Bot. 31, 187-192

- Huntley, J.P. (1991) **Macrobotanical remains from the Roman fort of Banna**
(Birdoswald) Cumbria.
Ancient Monuments Laboratory Report 104 / 91
Historic Buildings and Monuments Commission for England.
- Huntley, J.P. (1992) **Plant remains from excavations at The Lanes, Carlisle, Cumbria.**
Ancient Monuments Laboratory Report 51 / 92
Historic Buildings and Monuments Commission for England.
- Jacobsen, J.V., Knox, R.B. and Pyliotis, N.A. (1971) **The structure and composition**
of aleurone grains in the barley aleurone layer.
Planta 101, 189-209
- Jacobson, B.S., Fong, F. and Heath, R.L. (1975) **Carbonic anhydrase of spinach.**
Studies on its location, inhibition and physiological function.
Plant Physiol. 55,468-474
- Jacomet, S. (1987) **Prachistorische Getreidefunde.**
Botanisches Institut der Universitat, Basel.
- Jenner, C.F. (1982) **Movement of water and mass transfer into developing grains of**
wheat.
Aust. J. Plant Phys. 9, 69-82
- Johannes, E., Brosnan, J.M. and Sanders, D. (1991) **Calcium channels and signal**
transduction in plant cells.
BioEssays 13, 331-336

Jones, M.K. (1981) The Development of Crop Husbandry.

(in : The Environment of Man; the Iron Age to the Anglo-Saxon Period.

eds. M.K. Jones and G.W. Dimbleby. pp95-127)

BAR, British Series 87, Oxford.

Jones, M.K. (1982) Crop production in the Roman Britain.

(in : The Romano-British Countryside. Studies in Rural Settlement and Economy.

ed. D. Miles. pp 97-107)

BAR, British Series 103, Oxford.

Jones, M.K. (1984) The Plant Remains.

(in : Danebury : an Iron Age hillfort in Hampshire. Vol.2. The excavations 1969
1978 : The finds.

eds. B. Cunliffe et al. pp483-495)

CBA Research Report 52, London

Jones, M.K. (1984a) Regional patterns in crop production.

(in : Aspects of the Iron Age in Central Southern Britain.

eds. B. Cunliffe and D. Miles. pp120-125

Oxford University Committee for Archaeology, Monograph No. 2, Oxford.)

Joy, K.W. (1973) Control of glutamate dehydrogenase from *Pisum sativum* roots.

Phytochem. 12, 1031-1040

Karvanek, M. and Janicek, G. (1969) Study of the chemistry of oat and its products.

XIV.Effect of locality and variety on the content of some trace elements
in oat grains.

Sci. Papers of the Instit. of Chem. Tech. , E24, Prague.

- Kiekens, L. and Cottenie, A. (1981) Behaviour of copper in soils : adsorption and complexation reactions.
(in: Copper in animal wastes and sewage sludge. pp 85-101
Proc. of EEC workshop organised by Institut National de la Recherche Agronomique. D. Reidel Publ. Co. Dordrecht, Holland.)
- Kihara, H. (1965) The origin of wheat in the light of comparative genetics.
Jap. J. Genetics 40, 45-54
- King, A.C. (1984) Animal bones and dietary identity of military and civilian groups in Roman Britain, Germany and Gaul.
(in : Military and Civilian in Roman Britain. pp 187 - 217
eds. T.F.C. Blagg and A.C. King.)
BAR British series 136, Oxford.
- Kingston, H.M. and Jassie, L.B. (1988) Monitoring and predicting parameters in microwave dissolution.
(in : Introduction to Microwave Sample Preparation. pp 93-154
eds. H.M. Kingston and L.B. Jassie, Am.Chem.Soc., Washington)
- Kleese, R.A., Rasmusson, D.C. and Smith, L.H. (1968) Genetic and environmental variation in mineral element accumulation in barley, wheat and soybeans.
Crop Sci. 7, 591-593
- Klepinger, L.L. (1984) Nutritional assessment from bone.
Ann. Rev. Anthropol. 13, 75-96

- Klepinger, L.L., Kuhn, J.K. and Williams, W.S. (1986) An elemental analysis of archaeological bone from Sicily as a test of predictability of diagenetic change.
Am. J. Phys. Anthrop. 70, 325-331
- Korber-Grohne, U. (1981) Pflanzliche Abdrucke in eisen-zeitlichen Keramik. Spiegelbild damaliger Nutzpflanzen.
Fundberichte aus Baden-Wurttemberg 6, 165 -211
- Korber-Grohne, U. (1987) Nutzpflanzen in Deutschland. Kulturgeschichte und Biologie.
Theiss, Stuttgart.
- Kubota, J. (1983) Soils and plants in the geochemical environment.
(in : Applied Environmental Geochemistry. pp 103 - 122
ed.I. Thornton. Academic Press, London)
- Kuhn, F. (1991) Problems of identification of seeds and fruits of spelt wheat, oats and legumes.
(in : New Light on Early Farming. pp 59 - 60
ed. J.M.Renfrew. Edinburgh University Press, Edinburgh)
- Lambert, J.B., Vlasak, S.M., Thometz, A.C. and Buikstra, J.E. (1982) A comparative study of the chemical analysis of ribs and femurs of Woodland populations.
Am.J. Phys. Anthrop. 59, 289-294
- Lambert, J.B., Simpson, S.V., Szpunar, C.B. and Buikstra, J.E. (1985) Bone diagenesis and dietary analysis.
J. Human Evol. 14, 477-482

- Lambrick, G. and Robinson, M. (1979) Iron Age and Roman riverside settlements at Farmoor, Oxfordshire.
C.B.A. Research Report 32, London.
- Lancaster University Archaeological Unit (1993) Lancaster Mitchells Brewery Excavations 1988-1992 (pp 12-13)
- Lasztity, B. (1989) Dynamics of nutrient element uptake in various plant pots of winter wheat.
Novenytermeles (Crop Production) 38, 139-152
- Lautensschlaeger, W. (1989) Microwave digestion in a closed-vessel high pressure system.
Spectroscopy Int. 2 (2), 18-22
- Legge, G.J.F. and Mazzolini, A.P. (1980) Elemental microanalysis of biological and medical specimens with a scanning proton microprobe.
Nucl. Instr. Methods 168, 563-569
- Levesque, P.M. and Mathur, S.P. (1986) Soil tests for copper, iron, manganese and zinc in histosols : 1: The influence of soil properties, iron, manganese and zinc on the levels and distribution of copper.
Soil Sci. 142, 153-163
- Liljeroth, E., Van Veen, J.A. and Miller, H.J. (1990) Assimilate translocation to the rhizosphere of two wheat lines and subsequent utilisation by rhizosphere micro-organisms at two soil nitrogen concentrations.
Soil Biol. Biochem. 22, 1015-1021

- Lindsay, W.L. (1972) Inorganic phase equilibria of micronutrients in soils.
(in: Micronutrients in agriculture. pp41-57
eds. J.J. Mortvedt, P.M. Giordano and W.L. Lindsay
Soil Science Society of America, Madison, Wisconsin.)
- Lindsay, W.L. and Norvell, W.A. (1979) Development of a DTPA soil test for zinc, iron,
manganese and copper.
Soil Sci. Soc. Am. J. 42, 421-428
- Linehan, D.J., Sinclair, A.H. and Mitchell, M.C. (1989) Seasonal changes in Cu, Mn,
Zn and Co concentration in soil in the root zone of barley (*Hordeum vulgare*).
J. Soil Sci. 40, 103-115
- Loneragan, J.F., Snowball, K. and Robson, A.D. (1980) Copper supply in relation to
content and redistribution of copper among parts of the wheat plant.
Ann. Bot. 45, 621-632
- Lorenz, K. and Loewe, R. (1977) Mineral composition of U.S. and Canadian wheats
and wheat blends.
J. Agric. Food Chem. 25, 806-809
- Lott, J.N.A. and Spitzer, E. (1980) X-ray analysis studies of elements stored in protein
body globoid crystals of *Triticum* grains.
Plant Phys. 66, 494-499
- M.A.F.F. (Ministry for Agriculture, Fisheries and Food) (1981) Survey of copper and
zinc in food.
Food Surveillance Paper 5. H.M.S.O., London.

- Mahler, H.R. (1961) Inter-relationships with enzymes.
(in : Mineral Metabolism. pp 96-125
eds. C.L. Comar and F. Bronner. Academic Press, New York)
- Manning, W.H. (1975) Economic influences on land use in the military areas of the
Highland zone during the Roman period.
(in : The Effect of Man on the Landscape : the Highland Zone. pp 112 - 116.
eds. J.G.Evans, S. Limbrey and H. Cleere.
C.B.A. Research Report No. 11, London)
- Marcum, J.M., Dedman, J.R., Brinkley, B.R. and Means, A.R. (1978) Control of
microtubule assembly / disassembly by calcium dependent regulator protein.
Proc. Nat. Acad. Sci. USA 75, 3771-3775
- Marme, D. (1983) Calcium transport and function.
(in : Inorganic Plant Nutrition. pp 609-619
Encycl. Plant Physiol. New Series Vol. 15B
Eds. A. Lauchli and R.L. Bielecki. Springer-Verlag, Berlin)
-
- Marschner, H. (1975) Mineral metabolism : Role of Mineral Elements.
Progress in Botany 37, 98-106
- Marschner, H. and Richter, C. (1974) Calcium translocation in roots of maize and bean
seedlings.
Plant Soil 40, 193-210
- Marschner, H., Romheld, V. and Kissel, M. (1987) Localization of phytosiderophore
release and of iron uptake along intact barley roots.
Phys. Plant. 71, 157-162

- Martin , E. and Murphy, P. (1988) West Row Fen, Suffolk: a Bronze Age fen-edge settlement site.
Antiquity 62, 353-358
- Mathur, S.P., Levesque, M. and Sanderson, R.B. (1989) The influence of soil properties, total copper, iron, manganese and zinc on the yield of oat, carrot, onion and lettuce.
Comm. Soil Sci. Plant Anal. 20, 1809-1820
- Mazzolini, A.P., Legge, G.J.F. and Pallaghy, C.K. (1981) The distribution of trace elements in mature wheat seed using the Melbourne proton microprobe.
Nucl. Instr. Methods 191, 583-589
- McCord, A.K., Reuter, D.J., Hannay, J.N., Riggs, J.L. and Gouzos, J. (1984) Nutrient concentrations in cereals and pasture legumes grown in the Nethernton and Yumali areas of the Southern Mallee of South Australia.
Agricultural Research (South Australia) 16, 6-11
- McCurdy, E., Potter, D. and Medina, M. (1992) Trace elements in wines.
Laboratory News, Sept 92, 10 - 11
- Mengel, K. and Kirkby, E.A. (1978) Principles of Plant Nutrition. pp 391-474
International Potash Institute, Berne, Switzerland.
- Miller, T.E. (1987) Systematics and evolution.
(in: Wheat breeding - its scientific basis. pp 1-30
ed. F.G.H.Lupton. Chapman and Hall, London.)

- Miller, T.E. (1992) A cautionary note on the use of morphological characters for recognising taxa in wheat (genus *Triticum*).
 Prehistoire de l'agriculture : nouvelles approches experimentales et ethnographiques. Monographie du CRA No.6, ed. CRNS.
- Mitchell, R.L. and Burridge, J.C. (1979) Trace elements in soils and crops.
 Phil.Trans.R.Soc.Lond. B 288, 15 -24
- Milles, A. (1986) Charred remains of barley and other plants from Scord of Brouster.
 (in: Scord of Brouster, an early agricultural settlement. pp119-122
 eds. A. Whittle et al. Oxford University Committee for Archaeology.
 Monograph 9)
- Mocsy, A. (1967) Zu den Praten Legionis.
 (in : Studien zu den Militargrenzen Roms. pp 211 - 214
 Vortrage des 6. Ed. H. Schonberger.
 Internationalen Limeskongresses in Suddeutschland. Koln.)
- Moffett, L.C. (1993) Macrofossil plant remains from Leicester Shires.
 Ancient Monuments Laboratory Report 31 / 93
 Historic Buildings and Monuments Commission for England.
- Moir, D. (1989) Finds appraisal for 166 Fenchurch Street.
 Museum of London, Dept.of Urban Archaeology. London.
- Monk, M.A. (1987) Archaeobotanical studies at Poundbury.
 (in: Evcavations at Poundbury, Dorset, 1966 - 82. pp 132-137
 eds. C.J. Green et al. Dorset Nat. Hist. and Arch. Soc., Monograph 7.)

- Monk, M.N. and Fasham, P.J. (1980) Carbonised plant remains from two Iron Age sites in central Hampshire.
Proc. Prehist. Soc. 46, 321-344
- Moore, D.P. (1972) Mechanism of micronutrient uptake by plants.
(in : Micronutrients in Agriculture. pp 171-198
eds. J.J. Mortvedt, P.M. Giordano and W.L. Lindsay.
Soil Sci. Soc. Amer. Inc., Madison, Wisconsin.)
- Moore, Jr., P.A. and Patrick, Jr., W.H. (1989) Manganese availability and uptake by rice in acid sulfate soils.
Soil Sci. Soc. Am. J. 53, 104-109
- Morre, D.J. and Bracker, C.E. (1976) Ultrastructural alteration of plant plasma membranes induced by auxin and calcium ions.
Plant Physiol. 58, 544-547
- Morris, V.H., Pascoe, E.D. and Alexander, T.L. (1945) Studies of the composition of the wheat kernel. II. Distribution of certain inorganic elements in center sections.
Cereal Chem. 22, 361-371
- Morrison, I.N., Kuo, J. and O'Brien, T.P. (1975) Histochemistry and fine structure of developing wheat aleurone cells.
Planta 123, 105-116
- Morrison, I.N., O'Brien, T.P. and Kuo, J. (1978) Initial cellularisation and differentiation of the aleurone cells in the ventral region of the developing grain.
Planta 140, 19-30

- Murphy, P. (1984) Charred cereals from Building 45, Room 6.
(in : Excavations at Lion Walk, Balkeene Lane and Middlesborough,
Colchester, Essex. p.108
eds. P. Crummy et al. Colchester Arch. Report 3)
- Murray, J. (1990) The carbonised plant remains from selected Roman deposits.
(in: Dalton Parlours : Iron Age settlement and Roman villa. pp189-194
eds. S. Wrathmell and A. Nicholson. West Yorkshire Archaeology Service.)
- Nasuda, S., Liu, Y.G., Sakamoto, A., Nakayama, T., Iwabuchi, M. and Tsunewaki, K.
(1993) Chromosomal locations of the genes for histones and a histone
gene-binding protein family HBP-1 in common wheat.
Plant Mol. Biol. 22, 603-614
- Nauen, W. and Hartmann, T. (1980) Glutamate dehydrogenase from *Pisum sativum*.
Planta 148, 7-16
- Neas, E.D. and Collins, M.J. (1988) Microwave heating : Theoretical concepts and
equipment design.
(in : Introduction to Microwave Sample Preparation. pp 7-32
eds. H.M.Kingston and L.B.Jassie. Am.Chem.Soc., Washington)
- Nelson, D.A. and Sauer, N.J. (1984) An evaluation of post-depositional changes
in the trace element content of human bone.
Am. Antiquity 49, 141-147

- Nye, S. and Jones, M.K. (1987) The carbonised plant remains.
(in : Hengistbury Head, Dorset. Vol. I. The prehistoric and Roman
settlement 3500BC - AD500. pp323 - 328
eds. B. Cunliffe et al.
Oxford Univ. Committee for Archaeology, Monograph 13)
- Ogawa, M., Tanaka, K. and Kasai, Z. (1979) Accumulation of phosphorus, magnesium
and potassium in developing rice grains followed by electron microprobe
analysis focusing in the aleurone layer.
Plant Cell Physiol. 20, 19-27
- Perby, H. and Jensen, P. (1986) Variations in growth and accumulation of N, K⁺, Ca⁺⁺
and Mg⁺⁺ among barley cultivars exposed to various nutrient regimes and
root/shoot temperatures.
Phys. Planta 67, 166-172
- Percival, J. (1921) The Wheat Plant. (1974 Facsimile Edition) p. 326-329
Duckworth, London.
- Perkin-Elmer Manual (1982) Instruction Manual. Section 9.1.
Perkin-Elmer Corp. Analytical Instruments. Norfolk, Connecticut, USA.
- Petelkau, H. and Dannowski, M. (1990) Effect of repeated vehicle traffic in traffic
lanes on soil physical properties, nutrient uptake and yield of oats.
Soil and Tillage Research 15, 217-226
- Petrikovits, H. von (1960) Das romische Rheinland : Archaeologische Forschungen
seit 1945. pp 63-72
Opladen, Koln.

- Piggott, S. (1958) Native economies and the Roman occupation of the North.
(in : Roman and Native in North Britain. pp 1 - 27
ed. I.A. Richmond. Nelson, London.)
- Pilegaard, K. (1978) Heavy metal uptake from the soil in four seed plants.
Bot. Tidsskr. 73, 167-176
- Pitman, M.G. (1972) Uptake and transport of ions in barley seedlings. III. Correlation
between transport to the shoot and relative growth rate.
Aust. J. Biol.Sci. 25, 205-219
- Pitman, M.G. (1982) Ion movement within the plant.
Quart. Rev. Biophysics 15, 481-488
- Pitman, M.G., Lauchli, A. and Stelzer, R. (1981) Ion distribution in roots of barley
seedlings measured by electron probe X-ray microanalysis.
Plant Physiol. 68, 673-679
- Plant, J.A. and Raiswell, R. (1983) Principles of environmental geochemistry.
(in : Applied Environmental Geochemistry. pp 1-39
ed. I. Thornton. Academic Press, London)
- Price, T. and Kavanagh, M. (1982) Bone composition and the reconstruction of diet :
examples from the Mid-Western United States.
Mid-Continental J. Archaeol. 7, 61-79
- Rasmusson, D.C., Hester, A.J., Fick, G.N. and Byrne, I. (1971) Breeding for mineral
content in wheat and barley.
Crop Sci. 11, 623-626

- Rawson, H.M. (1991) Rapid leaf growth in wheat and its links with flowering.
Aust. J. Plant Physiol. 18, 109-119
- Reaves, G.A. and Berrow, M.L. (1979) The lead content of soils of the Wigtownshire
area of Scotland.
J. Sci. Food Agric. 30, 1-7
- Reaves, G.A. and Berrow, M.L. (1984) Total copper content of Scottish soils.
J. Soil Sci. 35, 583-592
- Reiss, H.D. and Herth, W. (1979) Calcium ionophore A23187 affects localised
wall secretion in the tip region of pollen tubes of *Lilium longiflorum*.
Planta 145, 225-232
- Renfrew, J.M. (1969) The archaeological evidence for the domestication of plants :
methods and problems.
(in : The domestication and exploitation of plants and animals. pp 149-172
eds. P.J. Ucko and G.W. Dimbleby. Duckworth, London.)
- Reynolds, P.J. (1987) Butser Ancient Farm Yearbook 1986.
Butser Ancient Farm Project Trust.
- Riley, R., Coucoli, H. and Chapman, V. (1967) Chromosomal interchanges and the
phylogeny of wheat.
Heredity 22, 233-248
- Robinson, D. (1986) Limits to nutrient inflow rates in roots and root systems.
Phys. Plant. 68, 551-559

- Robson, A.D. and Pitman, M.G. (1983) Interactions between nutrients in higher plants.
 (in: Inorganic Plant Nutrition. pp 147-180
 Encyclopedia of Plant Physiology : Vol. 15A
 eds. A. Lauchli and R.L. Bielecki, Springer Verlag, Berlin.)
- Romheld, V. (1987) Different strategies for iron acquisition in higher plants.
Physiol. Plant. **70**, 231-234
- Romheld, V. and Marschner, H. (1986) Evidence for a specific uptake system for iron
 phytosiderophores in roots of grasses.
Plant Phys. **80**, 175-180
- Rowell, D.L. (1988) Soil acidity and alkalinity.
 (in : Russell's soil conditions and plant growth. pp 844-898
 ed. A Wild. Longmann Scientific and Technical, Harlow)
- Runia, L. (1987) The chemical analysis of prehistoric bones. A palaeodietary and eco-
 archaeological study of Bronze Age West-Friesland.
 BAR Int. Series **363**, Oxford.
- Runia, L. (1988) Discrimination factors on different trophic levels in relation to the trace
 element content in human bones.
 (in : Trace elements in environmental history. pp 53-66
 eds. G.Grupe and B. Herrmann. Springer-Verlag, Berlin)
- Sachdev, P., Deb, D.L. and Rastogi, D.K. (1988) Effects of varying levels of zinc and
 manganese on dry matter yield and mineral composition of wheat plants at
 maturity.
J. Nuclear Agric. Biol. **17**, 137-143

- Sales, K.D., Oduwole, A.D., Robins, D., Hillman, G.C. and Holden, T.G. (1991) An analysis of the stomach contents of Lindow Man with ESR spectroscopy. (in : New Light on Early Farming. pp 51 - 58 ed. J.M.Renfrew. Edinburgh University Press, Edinburgh)
- Salin, M.L. and Bridges, S.M. (1980) Localization of superoxide dismutases in chloroplasts from *Brassica campestris*.
Z. Pflanzenphysiol. **99**, 37-45
- Sandmann, G., Reck, H., Kessler, E. and Boger, P. (1982) Distribution of plastocyanin and soluble plastidic cytochrome C in various classes of algae.
Arch. Microbiol. **134**, 23-27
- Saric, M.R. (1987) Progress since the first international symposium : 'Genetic aspects of plant mineral nutrition', Beograd, 1982, and perspectives for future research.
Plant Soil **99**, 197-209
- Schenk, D. and Feller, U. (1990) Rubidium export from individual leaves of maturing wheat.
J. Plant Physiol. **137**, 175-179
- Sealy, J.C., van der Merwe, N.J., Sillen, A., Kruger, F.J. and Krueger, H.W. (1991) $^{87}\text{Sr}/^{86}\text{Sr}$ as a dietary indicator in modern and archaeological bone.
J. Arch. Sci. **18**, 399-416
- Shrenk, W.G. and King, H.H. (1948) Composition of three varieties of Kansas-grown wheat. Mineral analysis of wheat and soil.
Cereal Chem. **25**, 61-71

- Sims, J.T. (1986) Soil pH effects on the distribution and plant availability of manganese, copper and zinc
Soil Sci. Soc. Am. J. 50, 367-373
- Singer, M.J. and Munns, D.N. (1991) Soils : an introduction.
pp 257-289 Macmillan Publishing Co., New York.
- Sofield, I., Warden, I.F., Evans, L.T. and Zee, S.Y. (1977) Nitrogen, phosphorus and water contents during grain development and maturation in wheat.
Aust. J. Plant Phys. 4, 799-810
- Spence, C., Schofield, J. and Shepherd, L. (1989) Digging in the City : the annual review 1988.
Museum of London, Dept. of Urban Archaeology.
- Sposito, G. (1983) The chemical forms of trace metals in soils.
(in : Applied environmental geochemistry. pp 123 - 170
ed. I. Thornton. Academic Press, London)
- Stucek, C.G. and Koontz, H.V. (1970) Phloem mobility of magnesium.
Plant Physiol. 46, 50-52
- Stewart, A., Nield, H. and Lott, J.N.A. (1988) An investigation of the mineral content of barley grains and seedlings.
Plant Physiol. 86, 93-97
- Storey, R., Pitman, M.G., Stelzer, R. and Carter, C. (1983) X-ray microanalysis of cells and cell compartments of *Atriplex spongiosa*. 2. Roots.
J. Exp. Bot. 34, 196-206

Stout, P.R. and Overstreet, R. (1950) Soil chemistry in relation to inorganic nutrition of plants.

Ann. Rev. Plant Phys. 1, 305-342

Straker, V. (1984) First and second century carbonised cereal grain from Roman London.

(in : Plants and Ancient Man. pp 323 - 329

eds. W. van Zeist and W.A. Casparie. Balkema, Rotterdam.)

Sullivan, B. (1933) The inorganic constituents of wheat and flour.

Cereal Chem. 10, 503-514

Tanaka, A. and Navasero, S.A. (1966) Manganese content of the rice plant under water culture conditions.

Soil Sci. Plant Nutr. 12, 67-72

Tanaka, A., Yoshida, T. and Kasai, Z. (1974) Distribution of mineral elements in the outer layer of rice and wheat grains, using electron microprobe X-ray analysis.

Soil Sci. Plant Nutr. 20, 87-91

Taylor, D.M., Morgan, P.W., Joham, H.E. and Amin, J.V. (1968) Influence of substrate and tissue manganese on the IAA oxidase system in cotton.

Plant Physiol. 43, 243-247

Thompson, M. (1983) Analytical methods in applied environmental geochemistry.

(in : Applied Environmental Geochemistry. pp 75-101

ed. I Thornton. Academic Press, London.)

- Tinker, P.B. (1981) Levels, distribution and chemical forms of trace elements in food plants.
Phil.Trans.R.Soc.Lond. B 294, 41 - 55
- Tinsley, H.M. (1975) The former woodland of the Nidderdale Moors (Yorks.) and the role of early man in its decline.
J. of Ecology 63, 1-26
- Turner , J. (1981) The Vegetation.
(in : The Environment of Man; the Iron Age to the Anglo-Saxon Period.
eds. M.K. Jones and G.W. Dimbleby. pp 53-56)
BAR British Series 87, Oxford.
- van der Veen, M. (1987) The Plant Remains.
(in : The excavation of an Iron Age settlement at Thorpe Thewles,
Cleveland, 1980-1982.
eds. D. Heslop et al. pp93-99)
C.B.A. Research Report 65, London
- van der Veen, M. (1987a) Plant Remains
(in : Prehistoric, Romano-British and later remains on Murton High Crag,
Northumberland.
I and G. Jobey, Archaeologia Aeliana, 15, 151 - 198)
- van der Veen, M. (1987b) The carbonised plant remains from Hallshill, Northumberland.
Ancient Monuments Laboratory Report 48 / 87
Historic Buildings and Monuments Commission for England.

- van der Veen, M. (1988) Carbonised grain from a Roman granary at South Shields,
N.E. England. pp 353 - 365
(in : Der prahistorische Mensch und seine Umwelt (ed. U. Korber-Grohne)
Forschungen und Berichte zur Vor- und Fruhgeschichte in
Baden-Wurttemberg, 31)
- van der Veen, M. (1992) Crop Husbandry Regimes.
Sheffield Archaeological Monographs 3, J.R.Collis Publications,
Dept. of Archaeology and Prehistory, University of Sheffield.
- van der Veen, M. (in press) The plant remains.
(in : Excavations at Stonea, Cambs. 1980 -1984.
R.P.J.Jackson and T.W.Potter. British Museum Publications, London)
- Vogel, K.P., Mayland, H.F., Reece, P.E. and Lamb, J.F. (1989) Genetic variability
for mineral element concentration in crested wheatgrass forage.
Crop Sci. 29, 1146-1150
- Wentworth, T.R. and Davidson, E.A. (1987) Foliar mineral elements in native plants
on contrasting rock types: multivariate patterns and nutrient balance regulation.
Soil Science 144, 190-202
- West, T.S. (1979) Biosignificance and analysis of trace elements in agricultural soils.
First T.B. Miller Memorial Lecture : Special Publication
North of Scotland College of Agriculture, Aberdeen.
- West, T.S. (1981) Soil as a source of trace elements.
Phil. Trans. R. Soc. Lond. B294, 19-39

- Wild, A. and Jones, L.H.P. (1988) Mineral nutrition of crop plants.
(in : Russells soil conditions and plant growth. pp 69-112
ed. A. Wild. Longman Scientific and Technical, London.)
- Williams, D. (1979) The plant remains
(in : Biological evidence from the Roman warehouses in Coney Street.
pp 52-62 eds. H.K. Kenward and D. Williams.
The Archaeology of York 14 (2).)
- Williams, C.H. and Moore, C.W.E. (1952) The effect of stage of growth on the copper,
zinc, manganese and molybdenum contents of Algerian oats grown on thirteen
soils.
Aust. J. Agric. Res. 3, 343-361
- Wilson, D.H. (1981) Pollen analysis and settlement archaeology of the First Millemium
B.C. from North-East England.
MPhil Thesis, Oxford University.
- Zee, S.Y. and O'Brien, T.P. (1970) Studies on the ontogeny of the pigment strand in
the caryopsis of wheat.
Aust. J. Biol. Sci. 23, 1153-1171
- Zohary, D. (1969) The progenitors of wheat and barley in relation to domestication
and agricultural dispersal in the Old World.
(in : The domestication and exploitation of plants and animals. pp46-66
eds. P.J. Ucko and G.W. Dimbleby.. Duckworth, London.
- Zohary, D. and Hopf, M. (1988) Domestication of plants in the Old World. pp13-52
Clarendon Press, Oxford.

APPENDIX 1 : The phytates.

The phytates are a complex class of naturally occurring compounds chemically known as the phosphorylated inositols, of which there are numerous examples forming various compounds. Their terminology is confusing and they are known as PHYTINS, PHYTATES and PHYTIC ACID. Properly, phytic acid is myo-inositol hexaphosphoric acid, or scientifically, 1,2,3,4,5,6-hexakis (di-hydrogen phosphate) myo-inositol. "PHYTIN" implies a Ca-Mg salt of phytic acid, and "PHYTATE" a mono to dodeca anion of phytic acid (Maga, 1982). Phytic acid can also be de-phosphorylated by phosphatase enzymes commonly called "PHYTASES"; the same effect can be gained by heating in acid solutions. Nine stereo-isometric inositols are possible, but only one myo- form has been isolated from plants; neo-, chiro- and scyllo-inositol hexaphosphates have been identified in soils (Cosgrove, 1966).

Structurally two models of phytic acid have been proposed:

(1) The Anderson model proposed by the British biochemist Anderson in 1914:

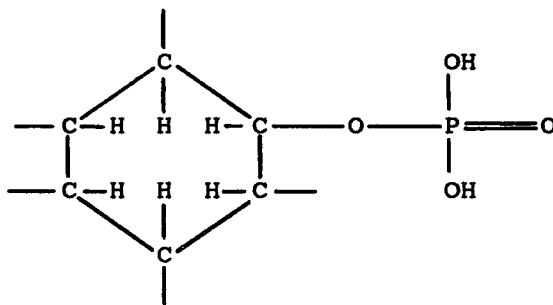
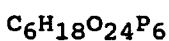

(each carbon atom in the ring is bonded to a hydrogen atom and a phosphorus radicle group as shown on the right of the above diagram)

This model was "proved" by Johnson and Tate (1969) using NMR; they also found that the 2- phosphate is in the axial position, whilst the phosphate groups on carbons 1, 3, 4, 5 and 6 are equatorial.

(2) The Neuberg model proposed by the German chemist in 1908:

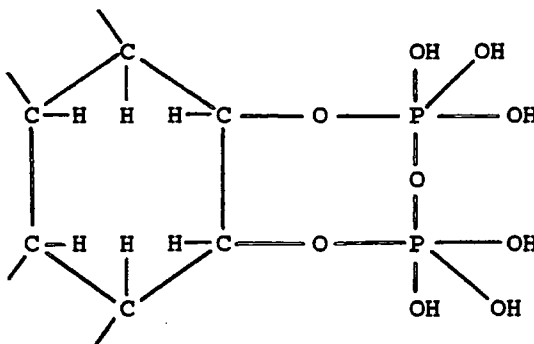
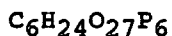

(the three pairs of carbon atoms in the ring are each attached to a molecule containing two phosphorus, nine oxygen and six hydrogen atoms as shown on the right of the above diagram)

There are arguments for both structures, and possibly both exist. The models differ by only three water molecules and it is possible that the "Anderson phytate" is a degradation product of the "Neuberg phytate", as suggested by Brown et al (1961), who was able to give convincing evidence of three strongly bound water molecules.

Blank et al (1971) examined the structure using X-ray analysis and favoured the Anderson model. Blank used a single sodium phytate crystal in his analyses, whilst Johnson and Tate used a dilute solution. There are a number of different forms of sodium phytate known which differ in the degree of hydration, leading to

variable stereo-chemistry. Blank et al favour a structure where the phosphates at carbons 1,3,4,5 and 6 are axial, with that at 2 being equatorial

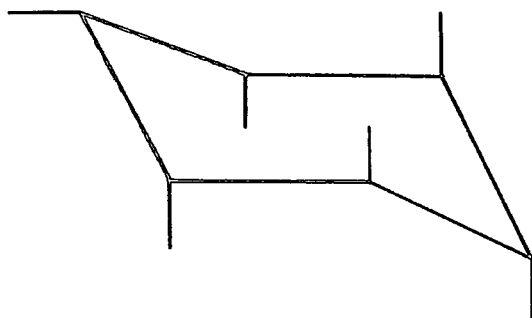

Pfeffer (1872) was the first person to report that globules composed of calcium and magnesium salts and an organic phosphate were present in the aleurone layer of cereals.

Bibliography:

Anderson, R.J. (1914) J. Biol. Chem. 17, 141-

Blank, G.E. et al (1971) The structure of myo-inositol hexaphosphate dodecasodium salt octatriacontahydrate : a single crystal X-ray analysis.

Biochem. Biophys. Res. Comm. 44, 319-325

Brown, G.E. et al (1961) Phytic acid : an analytical investigation.

Can. J. Chem. 39, 1290-1297

Cosgrove, D.J. (1966) Rev. Pure Appl. Chem. 16, 209-

Johnson, L.F. and Tate, M.E. (1969) Structure of "phytic acids".

Can. J. Chem. 47, 63-73

Maga, J.A. (1982) Phytate : its chemistry, occurrence, food interactions, nutritional significance, and methods of analysis.

J. Agric. Food Chem. 30, 1-9

Neuberg, C. (1908) Biochem. Z. 9, 557-

Pfeffer, E. (1872) Jahrb. Wiss. Bot. 8, 429-

APPENDIX 2 : Calculation of micronutrient concentration from AAS chart printout.

Sample: Oakenshaw (Mn charred)

Std pk ht (units)	Std (mg/l)	Label	Peak ht (units)	Conc (mg/l)	Vol (ml)	Dry wt (g)	Metal accum (µg/g)	Avg metal acc (µg/g)
79	1	31.6	60	0.75845	25	0.50633	37.44828	37.13242
39.5	0.5	31.7	62	0.78402	25	0.50933	38.48282	
16.5	0.2	31.8	59	0.74566	25	0.50396	36.99014	
		31.9	58	0.73288	25	0.51074	35.87328	
		31.10	59.5	0.75205	25	0.50997	36.86761	

n = 5

Regression statistics

Multiple R	0.9999687
R square	0.9999375
Adjusted R square	0.9999875
Standard error	0.35355
Observations	3

Analysis of variance

	df	Sum of squares	Mean square	F	Significance F
Regression	1	1998.375	1998.375	15987	0.005035
Residual	1	0.125	0.125		
Total	2	1998.5			

	Coefficients	Std. error	t statistic	P-value	Lower 95%	Upper 95%
Intercept	0.67857	0.40564	1.67286	0.23633	-4.4755	5.83265
x1	78.21429	0.61859	126.4397	6.2545E-05	70.3544	86.0741

Statistical information

Mean	37.13242
Standard error	0.42421
Median	36.99014
Mode	N/A
Standard deviation	0.94857
Variance	0.89979
Kurtosis	1.03869
Skewness	0.23252
Range	2.60955
Minimum	35.87328
Maximum	38.48282
Sum	185.66213
Count	5

Regression calculations are based on the equation:

$$y = mx + c$$

where m = gradient, x = concentration, and c = the intercept (the point at where the regression line cuts the x axis: ideally this should be 0 but it can be a positive value if the point is to the right of where the x and y axes cross, or a negative value if to the left).

In the above spreadsheet Multiple R = the regression co-efficient (which should be close to 1 if the results are reliable).

If the equation above is used the regression curve can be drawn from known standard solution concentrations and known standard peak heights.

Hence, using the values in the sample spreadsheet (sample 27.1):

$$y = mx + c$$

24 (the sample peak height) = 14.961538 (the x_1 co-efficient)
x 1.452442 (the sample conc.) + 2.269231 (the intercept co-efficient)

APPENDIX 3 : Calculation for high concentration elements from AAS keyboard results.

Sample: Birmingham (Total soil Zn)

Label	AAS reading (units p.p.m.)	Dry weight (g)	Metal in sample	
			(mg/g)	(μ g/g)
14.1	5.21	0.50129	0.25982	259.82
14.2	5.22	0.50076	0.26061	260.61
14.3	5.31	0.50085	0.26505	265.05
14.4	5.32	0.50076	0.26559	265.59
14.5	5.21	0.50278	0.25906	259.06

Statistical information

Mean	262.03
Standard error	1.3699
Median	260.61
Mode	N/A
Standard deviation	3.0632
Variance	9.3853
Kurtosis	-3.0227
Skewness	0.4838
Range	6.5367
Minimum	259.06
Maximum	265.59
Sum	1310.13
Count	5

APPENDIX 4 : Mean concentrations of elements in grains from the selected sites as calculated from charred weight (ch.wt.), charred samples original weight (ch.) and fresh weight (fresh). Values in µg/g.

	Cu (ch.wt.)	Cu (ch.)	Cu (fresh)	Fe (ch.wt.)	Fe (ch.)	Fe (fresh)	Mn (ch.wt.)	Mn (ch.)	Mn (fresh)
Birmingham	21.7	3.8	5.5	136.2	23.6	24.5	92.2	16.0	17.7
Boston	7.1	2.5	3.8	113.5	40.2	40.5	105.2	37.2	32.1
Bristol	7.4	2.5	3.9	80.9	27.1	24.9	42.0	14.1	14.3
Cambridge	22.7	4.4	5.3	195.7	37.9	35.4	207.2	40.2	37.5
Castellau	55.6	10.1	6.0	116.1	21.2	22.6	98.1	17.5	20.9
Dalton	23.1	4.8	6.4	170.8	35.3	37.4	112.2	23.2	24.8
Durham	21.5	4.3	5.3	162.8	32.5	30.1	73.4	14.6	14.9
Glasgow	16.8	3.5	5.4	160.6	33.2	33.3	92.6	19.2	18.4
Jardinefield	20.9	4.5	5.0	162.7	34.8	33.9	107.7	23.0	21.3
Lampeter	17.3	3.6	5.2	164.1	33.7	35.1	108.7	22.3	22.0
Nickersons	24.7	5.6	7.6	263.3	59.7	51.4	186.1	42.2	40.7
Norwich	10.4	2.8	3.9	86.4	23.1	26.5	36.8	9.9	12.4
Oakenshaw	25.7	4.9	6.8	229.5	43.4	48.6	184.9	35.0	36.7
Oxford	9.4	3.6	4.4	75.9	28.5	33.0	36.1	13.6	15.0
PBI	14.1	2.9	3.7	157.8	32.5	33.9	229.7	47.4	46.3
Romsey	24.7	4.7	5.5	178.9	34.2	33.4	74.8	14.3	13.0
Sheffield	18.5	4.3	5.2	149.2	34.8	37.6	86.4	18.0	15.4
Truro	28.7	5.5	7.6	116.5	22.1	24.4	83.9	15.9	17.3
West Stow	36.9	7.2	8.5	265.1	51.6	49.5	229.3	44.6	46.4
Whitchester	15.4	3.7	5.0	169.6	40.6	43.0	85.1	20.4	19.2
Wirral	12.5	3.3	4.9	89.5	23.4	28.2	41.3	10.8	11.1
York	22.2	4.4	5.7	141.1	27.8	29.8	132.3	26.1	25.4

	Zn (ch.wt.)	Zn (ch.)	Zn (fresh)	Mg (ch.wt.)	Mg (ch.)	Mg (fresh)	Ca (ch.wt.)	Ca (ch.)	Ca (fresh)
Birmingham	435.1	79.0	75.6	7090	1231	1143	1459	253	307
Boston	88.3	31.3	26.2	4406	1559	1460	792	280	332
Bristol	197.6	66.2	35.7	3809	1265	1155	867	290	359
Cambridge	244.1	47.4	44.8	6297	1222	1118	1510	293	354
Castellau	291.3	52.0	61.6	5678	1036	888	1874	342	434
Dalton	353.2	72.9	72.3	6120	1265	1182	1195	247	359
Durham	129.8	25.9	40.7	6166	1230	1119	1651	329	397
Glasgow	342.2	70.8	69.0	6292	1301	1124	1685	349	384
Jardinefield	152.5	32.7	30.1	6565	1407	1202	1080	232	318
Lampeter	249.8	51.3	46.8	5114	1050	966	1408	289	374
Nickersons	260.9	59.2	50.9	5922	1341	1200	865	196	259
Norwich	212.7	57.0	54.1	5335	1428	1301	863	231	306
Oakenshaw	276.2	52.2	50.2	6355	1201	1121	1305	247	290
Oxford	152.3	57.3	54.7	4107	1546	1394	1004	378	451
PBI	124.2	25.8	24.0	5920	1159	1095	1215	250	293
Romsey	431.4	82.5	81.9	6495	1242	1102	765	146	219
Sheffield	209.8	49.0	44.6	5709	1332	1215	1736	405	511
Truro	342.1	65.0	60.2	6327	1202	1127	1318	250	328
West Stow	231.8	45.1	42.2	8145	1586	1455	1423	277	356
Whitchester	172.9	41.4	39.8	4587	1097	998	959	229	317
Wirral	185.4	48.4	45.0	5271	1376	1127	1539	402	458
York	287.0	56.6	58.5	6131	1208	1102	1013	200	271

APPENDIX 5 : Available and total mean concentrations of elements ($\mu\text{g/g}$) and pH in soil samples

Sites	Cu avail	Cu total	Fe avail	Fe total	Mn avail	Mn total	Zn avail	Zn total	Ca total	Mg total	pH
Birmingham	28.8	75.8	144.5	1097	128.5	586	86	262	2314	2633	5.32
Boston	11.7	44.3	69.8	1459	54.2	425	8	58	7466	7099	6.41
Cambridge	11.9	45.5	79.3	1487	152.5	299	80.8	249	8054	4292	6.36
Castellau	5.8	28.3	117.5	1853	135	518	19.3	112	717	2361	4.14
Durham	12.1	63.6	130.5	1812	47.2	498	16.9	173	2917	2240	6.02
Glasgow	9	37.4	227.8	1515	94.7	444	27.7	157	3420	4098	5.7
Lampeter	7.7	30.1	110.3	2877	121.1	649	9	156	3217	5315	7.44
Norwich	7.7	29.9	75.5	949	25	218	90.1	300	2947	1139	6.32
Oakenshaw	16.4	49	217	1288	76.8	209	62.8	249	3334	2339	6.2
Romsey	24.4	73.4	149	1459	76.2	448	96.5	348	6771	2181	6.45
Sheffield	35.2	68	174.5	1885	190.5	652	36.5	201	5895	1895	5.9
Truro	114.7	187.5	110.3	3108	30.3	962	145.3	324	5467	6236	6.1
West Stow	31.2	55	149.3	776	5.9	326	169.5	249	1495	6997	6.45
Wirral	11.1	36.1	72.3	728	34.1	172	41	163	3511	3263	6.88
York	13.9	56.6	151.8	1244	64.1	299	39.1	144	1798	2048	5.43

APPENDIX 6 : Mean concentrations of available micronutrients and total macronutrients in soil samples together with mean concentrations of elements in fresh (fr.) and charred (ch.) grains. Values in µg/g.

	Cu avail.	Cu (fr.)	Cu (ch.)	Fe avail	Fe (fr.)	Fe (ch.)	Mn avail	Mn (fr.)	Mn (ch.)
Birmingham	29	5.5	21.8	145	25	136	129	18	92
Boston	12	3.8	7	70	41	113	54	32	105
Cambridge	12	5.3	22.7	79	35	196	153	38	207
Castellau	6	6	55.6	118	23	116	135	21	98
Durham	12	5.3	21.5	131	31	136	47	15	73
Glasgow	9	5.4	16.8	228	33	113	95	18	93
Lampeter	8	5.2	17.3	110	35	164	121	22	109
Norwich	8	3.9	10.4	76	26	86	25	12	37
Oakenshaw	16	6.8	25.7	217	49	230	77	37	185
Romsey	24	5.5	24.8	149	33	179	76	13	75
Sheffield	35	5.1	18.5	175	37	149	191	15	86
Truro	115	7.6	28.7	110	24	116	30	17	84
West Stow	31	8.5	36.9	149	50	265	6	46	229
Wirral	11	4.9	12.5	72	28	89	34	11	41
York	14	5.8	22.2	152	30	141	64	25	132

	Zn avail	Zn (fr.)	Zn (ch.)	Ca total	Ca (fr.)	Ca (ch.)	Mg total	Mg (fr.)	Mg (ch.)
Birmingham	86	76	435	2314	307	1459	2633	1143	7090
Boston	8	26	88	7466	332	792	7099	1460	4406
Cambridge	81	45	244	8054	354	1510	4292	1118	6297
Castellau	19	62	291	717	434	1874	2361	888	5678
Durham	17	41	130	2917	397	1651	2240	1119	6166
Glasgow	28	69	342	3420	384	1685	4098	1124	6292
Lampeter	9	47	250	3217	374	1408	5315	966	5114
Norwich	90	54	213	2947	306	863	1139	1301	5335
Oakenshaw	63	50	276	3334	290	1305	2339	1121	6355
Romsey	97	82	431	6771	219	765	2181	1102	6495
Sheffield	36	45	210	5895	511	1736	1895	1215	5709
Truro	145	60	342	5467	328	1318	6236	1127	6327
West Stow	170	42	232	1495	356	1423	6997	1455	8145
Wirral	41	45	185	3511	458	1539	3263	1127	5271
York	39	59	287	1798	271	1013	2048	1102	6131

APPENDIX 7: Mean concentration values of elements as analysed in grain from its original growing site and in three harvests grown on a different soil type. Values in µg/g

	COPPER				IRON			
	90 crop	91 crop	92 crop	Original	90 crop	91 crop	92 crop	Original
Birmingham	6.8	7.7	7.0	5.5	32.5	39.7	30.2	24.5
Boston	7.1	7.8	7.3	3.8	52.3	57.7	49.5	40.5
Bristol	6.1	6.9	6.5	3.9	42.7	50.9	34.6	24.9
Cambridge	6.4	7.0	6.6	5.3	34.1	38.0	30.3	35.4
Castellau	6.1	7.3	6.0	6.0	41.7	50.9	37.9	22.6
Lampeter	6.2	6.7	6.4	5.2	29.8	35.7	27.2	35.1
Romsey	6.1	6.4	5.7	5.5	33.5	37.5	30.9	33.4
Sheffield	7.0	7.5	7.3	5.1	33.0	37.9	29.1	37.2
Truro	5.9	6.2	6.0	7.6	43.0	60.0	36.0	24.4
Wirral	6.3	6.7	6.5	4.9	38.8	48.8	34.6	28.2
York	5.9	5.9	5.9	5.8	37.6	39.3	35.8	29.8

	MANGANESE				ZINC			
	90 crop	91 crop	92 crop	Original	90 crop	91 crop	92 crop	Original
Birmingham	18.3	21.9	19.7	17.7	41.4	61.2	42.6	79.0
Boston	19.2	25.2	17.3	32.1	54.8	77.3	50.7	26.2
Bristol	13.9	18.0	12.4	24.9	53.6	73.4	50.0	35.7
Cambridge	19.0	28.4	22.3	37.5	43.1	49.3	45.6	44.8
Castellau	18.5	19.7	15.7	20.8	51.4	75.8	44.9	61.6
Lampeter	13.3	17.9	14.3	22.0	43.5	50.1	45.0	46.8
Romsey	14.1	14.8	15.3	12.9	45.2	56.2	43.0	81.9
Sheffield	13.7	15.0	14.3	15.4	47.8	52.8	46.9	44.6
Truro	15.9	17.0	13.8	17.3	62.0	78.7	60.5	51.8
Wirral	13.5	14.6	13.8	11.1	52.8	63.3	49.9	45.0
York	12.5	16.1	13.7	25.4	61.8	54.5	51.8	58.5

	MAGNESIUM				CALCIUM			
	90 crop	91 crop	92 crop	Original	90 crop	91 crop	92 crop	Original
Birmingham	1300	1428	1039	1143	355	268	255	307
Boston	1313	1420	1036	1460	365	270	249	332
Bristol	1277	1401	1023	1155	403	285	263	359
Cambridge	1318	1430	1040	1118	377	275	251	354
Castellau	1252	1454	1067	888	371	260	257	434
Lampeter	1329	1438	1065	966	362	284	277	374
Romsey	1272	1433	1006	1102	420	249	263	219
Sheffield	1367	1443	1048	1215	369	262	260	511
Truro	1400	1477	1052	1127	418	259	248	328
Wirral	1287	1453	1063	1127	398	269	250	458
York	1406	1467	1079	1102	421	298	299	271

APPENDIX 8: Coding numbers used in the statistical diagrams.

<u>SITE:</u>	<u>Figs. 3.41.-3.43.</u>	<u>Figs. 3.46.-3.53, 3.58.-3.61.</u>	<u>Figs. 3.54-3.57.</u>
Birmingham	1	11-15	1.1-1.5
Boston	2	21-25	2.1-2.5
Bristol	3	31-35	3.1-3.5
Cambridge	4	41-45	4.1-4.5
Castellau	5	51-55	5.1-5.5
Dalton	6	61-65	6.1-6.5
Durham	7 & 8	71-75 & 81-85	7.1-7.5 & 8.1-8.5
Glasgow	9	91-95	9.1-9.5
Jardinefield	10	101-105	10.1-10.5
Lampeter	11	111-115	11.1-11.5
Nickersons	12	121-125	12.1-12.5
Norwich	13	131-135	13.1-13.5
Oakenshaw	14 & 15	141-145 & 151-155	14.1-14.5 & 15.1-15.5
Oxford	16	161-165	16.1-16.5
PBI	17 & 18	171-175 & 181-185	17.1-17.5 & 18.1-18.5
Romsey	19	191-195	19.1-19.5
Sheffield	20	201-205	20.1-20.5
Truro	21	212-215	21.1-21.5
West Stow	22	221-225	22.1-22.5
Whitchester	23	231-235	23.1-23.5
Wirral	24	241-245	24.1-24.5
York	25	251-255	25.1-25.5

