

Durham E-Theses

New π -electron donor systems based on 1,4-dithin derivatives

Alexander Kit Lay

How to cite:

Lay, Alexander Kit (1997) New π -electron donor systems based on 1,4-dithin derivatives. Doctoral thesis, Durham University.

Use policy

The full-text may be used and/or reproduced, and given to third parties in any format or medium, without prior permission or charge, for personal research or study, educational, or not-for-profit purposes provided that:

- a full bibliographic reference is made to the original source
- a <https://etheses.durham.ac.uk/id/eprint/4725/> is made to the metadata record in Durham E-Theses
- the full-text is not changed in any way

The full-text must not be sold in any format or medium without the formal permission of the copyright holders.

Please consult the [full Durham E-Theses policy](#) for further details.

NEW π -ELECTRON DONOR SYSTEMS
BASED ON
1,4-DITHIIN DERIVATIVES

Alexander Kit Lay B.Sc. (Hons.)

(University College)

Department of Chemistry

University of Durham

The copyright of this thesis rests
with the author. No quotation
from it should be published
without the written consent of the
author and information derived
from it should be acknowledged.

A Thesis submitted for the degree of Doctor of Philosophy
at the University of Durham

December 1997



1 2 AUG 1998

STATEMENT OF COPYRIGHT

The copyright of this thesis rests with the author. No quotation from it should be published without their written consent and information derived from it should be acknowledged.

DECLARATION

The work described in this thesis was carried out in the Department of Chemistry at the University of Durham between October 1994 and September 1997. All the work is my own, unless stated to the contrary, and it has not been submitted for a degree at this or any other University.

Dedicated to my Parents and Grandparents

ABSTRACT

NEW π -ELECTRON DONOR SYSTEMS BASED ON 1,4-DITHIIN DERIVATIVES

Alexander Kit Lay B.Sc. (Hons.)

A thesis submitted for the degree of Doctor of Philosophy

University of Durham (December 1997)

A review of organic, π -electron donor molecules is given. The focus is on non-tetrathiafulvalene based systems. Polycyclic arenes, thioalkyl substituted arenes, chalcogenated fulvalenes, *peri*-dichalcogen bridged polycyclic arenes and heteroarenes are covered.

Various π -electron donor molecules based on acenaphtho[1,2-*b*][1,4]-dithiin have been synthesised *via* various methodologies. The redox properties of these molecules, as studied by cyclic voltammetry, provide evidence that these species are efficient π -electron donors. A selection of these compounds have also been studied by Electron Spin Resonance.

Two ring expansion methodologies have been utilised in the synthesis of acenaphtho[1,2-*b*][1,4]-dithiin based systems from 1,2-dithiols. Complexation of 7,12-dithia-benzo[*k*]fluoranthene, thus synthesised, with 2,5-dibromo-7,7,8,8-tetracyano-*p*-quinodimethane and iodine (I₄ counter ion) yielded highly crystalline but poorly conducting salts.

1,2-Dibromoacenaphthylene and benzo-1,2-dithiolate species have been reacted to form new 7,12-dithia-benzo[*k*]fluoranthene derivatives, two of which have been studied by X-ray diffraction.

The versatile oligo(1,3-dithiole-2,4,5-trithione) compound has been used to generate various compounds containing the 1,4-dithiin ring including 8,9-di(methylsulfanyl)acenaphthylene[1,2-*b*][1,4]dithiine, which forms complexes with 7,7,8,8-tetracyano-*p*-quinodimethane, 2,5-dibromo-7,7,8,8-tetracyano-*p*-quinodimethane and iodine (I₇ counter ion) all three of which have been studied by X-ray diffraction.

A novel 1,2,4-trithiolane has also been synthesised and characterised by X-ray diffraction.

ACKNOWLEDGEMENTS

This thesis could not have been completed without the help of the following people, to whom I express my thanks and gratitude.

Prof. Martin Bryce, my supervisor, for his ideas and encouragement throughout this satisfying project and the hours he spent proof reading this work.

Dr. Antony Chesney, for his invaluable aid in beginning the experimental work, his suggestions, conversations, company and for keeping lab 29 in order.

Dr. Adrian Moore, for his useful advice and the sanctuary of lab 30.

Dr. Andrei Batsanov and Prof. Judith Howard (University of Durham) for performing single-crystal X-ray structural analysis. Dr. Mike Jones and Miss Lara Turner for obtaining mass spectra, Mr Ray Hart and Mr Gordon Haswell (glassblowing), Mrs. Julia Say for obtaining 400 MHz NMR spectra and Mrs. J. Dostal for microanalyses

Prof. Klaus Bechgaard and Ib Johansen for their warm hospitality and advice during my stay at the Risø National Laboratory, Denmark.

Prof. Fabian Gerson (Basel) and his group for performing ESR studies and Dr. Richard Bushby (Leeds) for the use of his ESR spectrometer.

Past and present members of Martin's group (in no particular order), Adrian, Chez, Graham, Mike, Wayne, Vincent, Mark, Pete, Andy, John-Michael, Brian, Derek, Terry, Claire and Richard.

In addition Peter, Zillah, Simon, Robin and Mat for their friendship.

I would also like to thank the EPSRC for their financial support.

CONTENTS

	Page
CHAPTER ONE - INTRODUCTION AND BACKGROUND	1
ORGANIC ELECTRON CONDUCTORS	
1.1 INTRODUCTION	2
1.2 HISTORICAL OVERVIEW	2
1.3 PHYSICAL CONCEPTS	4
1.3.1 Band Theory	4
1.3.2 Charge-Transfer and Radical-Cation Salts	7
1.3.3 Peierls Distortion	8
1.4 ORGANIC π -ELECTRON DONOR MOLECULES AND THEIR CONDUCTING SALTS	9
1.4.1 Polycyclic Arenes	9
1.4.2 Thioalkyl Substituted Arenes	12
1.4.3 Chalcogenated Fulvalenes	15
1.4.3.1 'Core-TTF' Donors	15
1.4.3.2 Extended TTF Systems with Central Spacers	19
1.4.4 <i>Peri</i> -Dichalcogen Bridged Polycyclic Arenes	21
1.4.4.1 Introduction	21
1.4.4.2 Tetracene Based Systems	22
1.4.4.3 Anthracene Based Systems	24
1.4.4.4 Naphthalene Based Systems	26
1.4.4.5 Systems Based upon Other Arenes	28

1.4.5 Heteroarenes	31
1.4.5.1 Heteroarenes Based on Pyrene	32
1.4.5.2 Heteroarenes Based on Perylene	35
1.4.5.3 Heteroarenes Based on Other Systems	37
1.4.6 Conclusions	39
CHAPTER TWO - ACENAPHTHO[1,2-<i>b</i>][1,4]-DITHIIN AND ITS FUNCTIONALISATION	40
2.1 ACENAPHTHO[1,2- <i>b</i>][1,4]-DITHIIN	41
2.1.1 Introduction	41
2.1.2 Synthesis	42
2.2 FUNCTIONALISATION OF 117	46
2.2.1 Introduction	46
2.2.2 Lithiation and Substitution	46
2.2.3 The Use of Other Dithiols in Synthesis of Derivatives of 117	49
2.2.3.1 Single-Crystal X-Ray Analysis of 137	54
2.3 ELECTROCHEMICAL STUDIES AND CHARGE-TRANSFER COMPLEXES	54
2.3.1 Electrochemical Studies	54
2.3.2 Charge-Transfer Salts	56
2.3.2.1 Single-Crystal X-Ray Study of 137 :Br ₂ TCNQ	57
2.3.3 Radical-Cation Salts	59
2.4 CONCLUSIONS	59

CHAPTER THREE - 1,4-DITHIIN DERIVATIVES VIA NUCLEOPHILIC ATTACK OF 1,2-DITHIOLATE ANION	61
3.1 INTRODUCTION	62
3.2 SYNTHESIS	64
3.2.1 Synthesis <i>Via</i> 1,2-Dibromoacenaphthylene	64
3.2.2 Acenaphthylene-1,2-Dithiolate Dianion	67
3.3 ELECTROCHEMICAL STUDIES OF COMPOUNDS 180 AND 181 AND SALT SYNTHESIS	70
3.3.1 Electrochemical Studies	70
3.3.2 Salts	71
3.4 CONCLUSIONS	71
CHAPTER FOUR - 1,4-DITHIIN DERIVATIVES FROM OLIGO(1,3-DITHIOLE-2,4,5-TRITHIONE	72
4.1 INTRODUCTION	73
4.2 SYNTHESIS OF ACENAPHTHO-1,4-DITHIIN DERIVATIVES	76
4.2.1 Single-Crystal X-Ray Analysis of 207 and 214	79
4.2.2 Electrochemical Studies of 207 and 214	83
4.2.3 Salts of Donors 207 and 214	83
4.3 OTHER 1,4-DITHIINS FROM OLIGO(1,3-DITHIOLE-2,4,5-TRITHIONE)	85
4.4 CONCLUSIONS	90

CHAPTER - FIVE EXPERIMENTAL PROCEDURES AND ANALYTICAL DATA	92
5.1 GENERAL PROCEDURES	93
5.2 EXPERIMENTAL PROCEDURES FOR CHAPTER 2	97
5.2.1 Experimental for section 2.1.2	97
5.2.2 Experimental for Section 2.2.2	99
5.2.3 Experimental for Section 2.2.3	100
5.3 EXPERIMENTAL PROCEDURES FOR CHAPTER 3	106
5.3.1 Experimental for Section 3.3.1	106
5.3.2 Experimental for Section 3.2.2	108
5.4 EXPERIMENTAL PROCEDURES FOR CHAPTER 4	111
5.4.1 Experimental for Section 4.2	111
5.4.2 Experimental for Section 4.3	115
REFERENCES	119
APPENDIX ONE - A NOVEL 1,2,4-TRITHIOLANE	134
APPENDIX TWO - ELECTRONSPIN RESONANCE STUDIES	140
APPENDIX THREE - X-RAY CRYSTALLOGRAPHIC DATA	143
APPENDIX FOUR - RESEARCH COLLOQUIA, SEMINARS, LECTURES AND CONFERENCES	152
APPENDIX FIVE - PUBLICATIONS AND PRESENTATIONS	157

Chapter One

Introduction and Background

ORGANIC ELECTRON CONDUCTORS

1.1 INTRODUCTION

Organic materials that are capable of conducting electricity in the manner of semiconductors (e.g. silicon and germanium), conductors (e.g. copper and silver) and superconductors (e.g. very low temperature mercury) have drawn a huge amount of research interest over the past quarter century.¹ The versatility of organic chemistry, which enables subtle changes to be made in the molecular structure, introduces the possibility of 'fine tuning' the properties of these materials to suit a specific task. These organic materials are also potentially cheaper and easier to manufacture than traditional inorganic conductors. They may also be polymeric or crystalline and exist as solids or thin films, thus the potential for industrial applications is very large.

The suggestion that organic materials could exhibit electronic conductivity was advanced over eighty years ago.² Now as we approach the end of the century the research on these substances remains extensive and multi-disciplinary, bringing together organic chemists, solid state physicists, X-ray crystallographers and materials scientists. These materials have the potential to make a comparable impact on the electronics industry in the twenty-first century, as silicon and other inorganic materials did in the twentieth.

A large proportion of this worldwide research effort, and many of its successes, have concerned the synthesis of electrically conducting charge-transfer (CT) and radical-ion (RI) salts. The work presented in this thesis concerns the synthesis of novel, organic, electron donor compounds and the synthesis and properties of the CT and radical cation (RC) salts derived from them.

1.2 HISTORICAL OVERVIEW

In 1911 it was proposed by McCoy and Moore that materials composed of non-metallic elements may possess metallic behaviour.^{2a} Not until 1954 was this realised when Akamatu *et. al.* synthesised a perylene-bromine complex and found it to have an electrical conductance ($\sigma_{rt} = ca. 1 \text{ Scm}^{-1}$) very much greater than that of pure perylene ($\sigma_{rt} = ca. 10^{-15} \text{ Scm}^{-1}$).³ Unfortunately this compound was unstable and its conductance decreased, and was finally lost, over several days. Work involving the salts of the electron acceptor tetracyano-*p*-quinodimethane (TCNQ) **1** in the 1960's produced many compounds which exhibited semiconducting properties.⁴ It was not until 1973 when the 1:1 crystalline CT salt of TCNQ **1** and the organosulfur electron donor tetrathiafulvalene (TTF) **2** was synthesised, and found to have good metallic

conductivity ($\sigma_{\text{rt}} = 500 \text{ Scm}^{-1}$, $\sigma_{\text{max}} = 10^4 \text{ Scm}^{-1}$ at 59K),⁵ that the synthesis of a stable organic, metal-like conductor was first realised.



Over the next decade many advances were made in the field of conducting CT salts. The vast majority of these centred on compounds containing derivatives of the basic electron donor TTF **2**. In 1980 the first organic superconductor was reported. The electron donor tetramethyltetraselenafulvalene (TMTSF) **3**, when the component of a 2:1 radical cation salt, showed the onset of superconductivity at $T_c = 0.9 \text{ K}$ at 12 Kbar with PF_6^- ,⁶ and $T_c = 1.4 \text{ K}$ at ambient pressure with ClO_4^- .⁷ Currently the highest T_c for an organic superconductor belongs to a salt discovered in 1990, $k\text{-(BEDT-TTF)}_2 \text{Cu}[\text{N}(\text{CN})_2]\text{X}$, where $\text{X} = \text{Br}, \text{Cl}$ and BEDT-TTF = **4**; $T_c = 11.6 \text{ K}$ at ambient pressure for $\text{X} = \text{Br}$,⁸ $T_c = 12.5 \text{ K}$ at 0.3 kbar for $\text{X} = \text{Cl}$.⁹

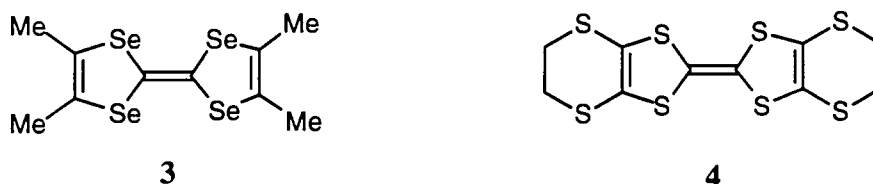

In addition to the many TTF and TCNQ based systems, conducting organic charge-transfer and radical-cation salts have been synthesised incorporating other organic electron donor and electron acceptor compounds (Section 1.4). In conjunction with these salts it was found in the 1970s that by doping polyacetylene with various donor or acceptor species, its electrical conductivity could be increased by *ca.* 13 orders of magnitude.¹⁰ It was also shown that polymers of certain main group elements, in particular $(\text{SN})_x$,¹¹ and certain linear chains of chelated transition metals,¹² are also electrically conducting.

When speaking of material conductivity values it is often useful to put these in context with the conductivity of other substances. Figure 1.1¹³ illustrates the values of various materials in relation to each other, on a scale of conductivity measured in Scm^{-1} .

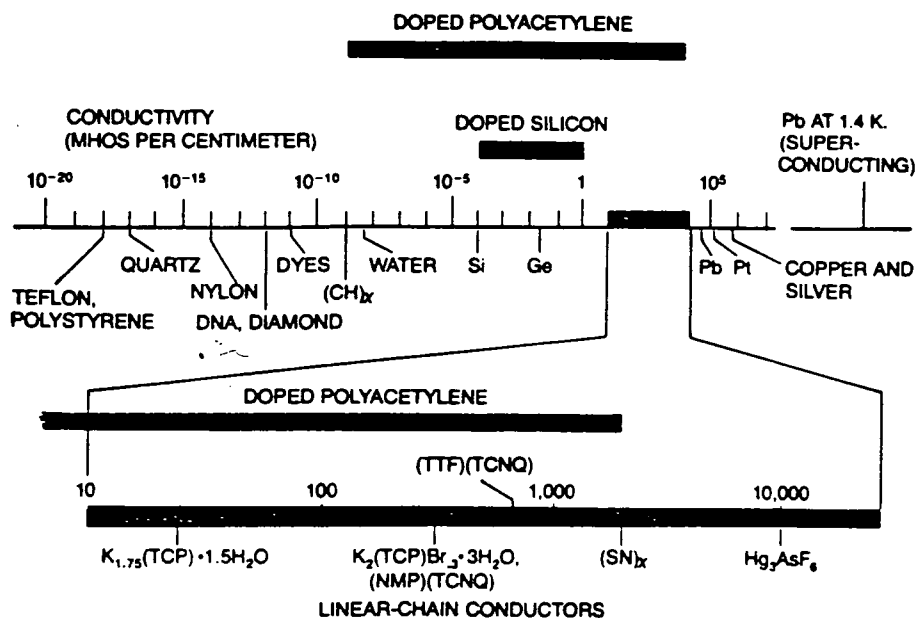

Figure 1.1

1.3 PHYSICAL CONCEPTS

1.3.1 Band Theory

Band theory outlines the basic concepts through which we may understand the metallic behaviour of certain organic materials. In a crystalline solid, where a large number of molecules or atoms (the electronic states) are brought together in close proximity, the atomic and molecular orbitals can combine to form bands (a continuum of energy states). An example which illustrates this behaviour, are the energy bands that form when a set of ethylene molecules are stacked (Figure 1.2). If we bring together two sp^2 carbon atoms to form the central double bond of an ethylene molecule, the two atomic p-orbitals of the adjacent carbon atoms combine and form a lower energy π -bonding and a higher energy π^* anti-bonding orbital. The two electrons from the original sp^2 carbon p-orbitals pair and fill the lower energy π -bonding orbital, leaving the π^* anti-bonding orbital empty. If two of these ethylene molecules then stack together their two sets of π -orbitals combine and split once more. The result of this combination is two π -bonding orbitals (lower energy) and π^* anti-bonding orbitals (higher energy). The two pairs of electrons from the original ethylene molecules reside in the two lower energy π -bonding orbitals and the π^* anti-bonding orbitals remain empty. If the stacking of ethylene molecules was continued within this hypothetical crystal until there were n stacked molecules, we would end up with n π -bonding orbitals

separated by an extremely small energy difference; these orbitals are collectively known as the HOMO band (HOMO = Highest Occupied Molecular Orbital), and are completely filled with $2n$ electrons. Likewise, there would be n , unoccupied, π^* anti-bonding orbitals which also form a band but of higher energy, the LUMO band (LUMO = Lowest Unoccupied Molecular Orbital). The extent to which the molecular orbitals of the individual ethylene moieties overlap determines the width of these bands. The formation of HOMO and LUMO bands by extensive overlap of individual π -molecular orbitals is not the only requirement for the conduction of electrons. The occupancy of these energy bands by electrons has a profound effect on their physical characteristics. The valence electrons are responsible for electron conduction, not those from the inner core shells. The valence electrons derive from the HOMO orbital and it is the ease with which these move through the solid that determines how effective the conduction will be. The energy states which are closest to the highest occupied state within a band, known as the Fermi Level, are the most easily accessible. It is electrons in these energy states very near the Fermi Level which are involved in conduction.

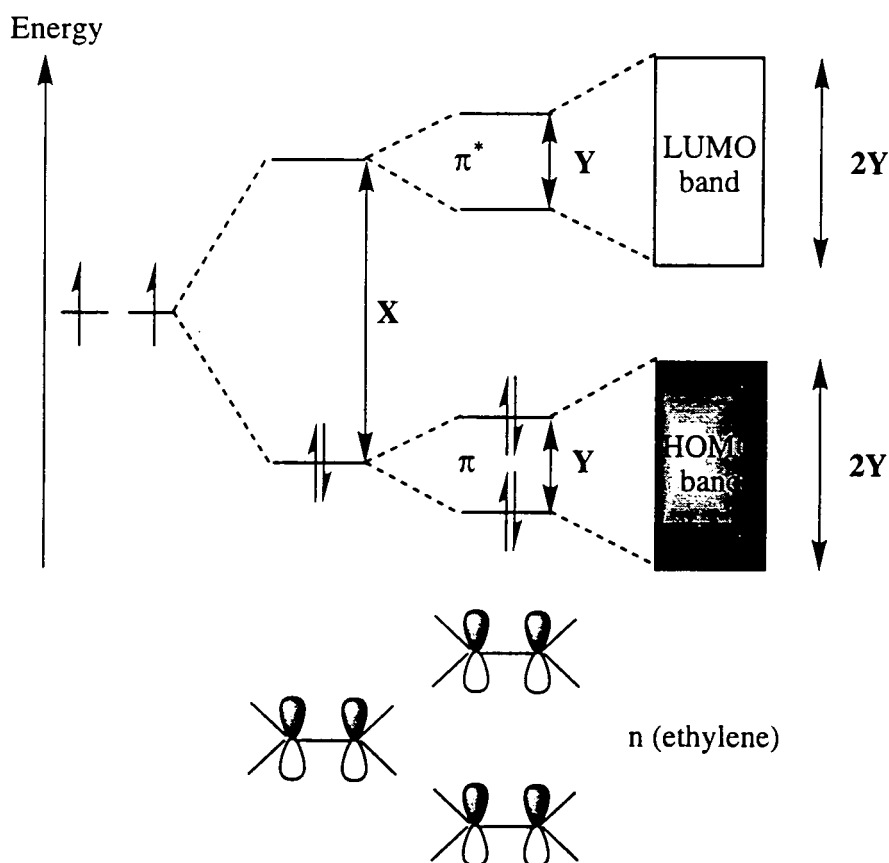

Figure 1.2 - Formation of electronic bands from a stack of ethylene molecules. X = initial splitting energy between bonding and anti-bonding orbitals in monomer. Band width ($2Y$) is approximately twice the value of the dimer splitting energy (Y).

In an insulator the energy gap, E_g , between the HOMO band and the LUMO band is large (Figure 1.3a) and electrons cannot move from the valence band to the conduction band and flow under the influence of an electric field (e.g. diamond, $E_g > 4$ eV). If the energy gap is decreased (Figure 1.3b), electrons may gain enough thermal energy to move from the valence band to the conduction band. These materials are semiconductors (e.g. silicon, $E_g = 1.1$ eV) and their conductivity decreases as the temperature is lowered. If the energy gap becomes extremely small (Figure 1.3c) there is good conduction as it is easy for electrons close to the Fermi level to enter the conduction band (e.g. group 2 metals) and move throughout the solid; these substances are known as semi-metals. If we have a case where the valence band is only partially filled (e.g. group 1 metals, only one electron available per atom) large numbers of electrons close to the Fermi energy level can easily move to the conduction band (Figure 1.2d), the lowest unoccupied molecular orbital (LUMO), and cause conduction. These substances are metals and have a greater conductance than semi-metals because of an increased population of electrons at the Fermi level. In metals, as temperature decreases, crystallinity increases and lattice vibrations are reduced. The result is more efficient intermolecular overlap and conductivity is increased.

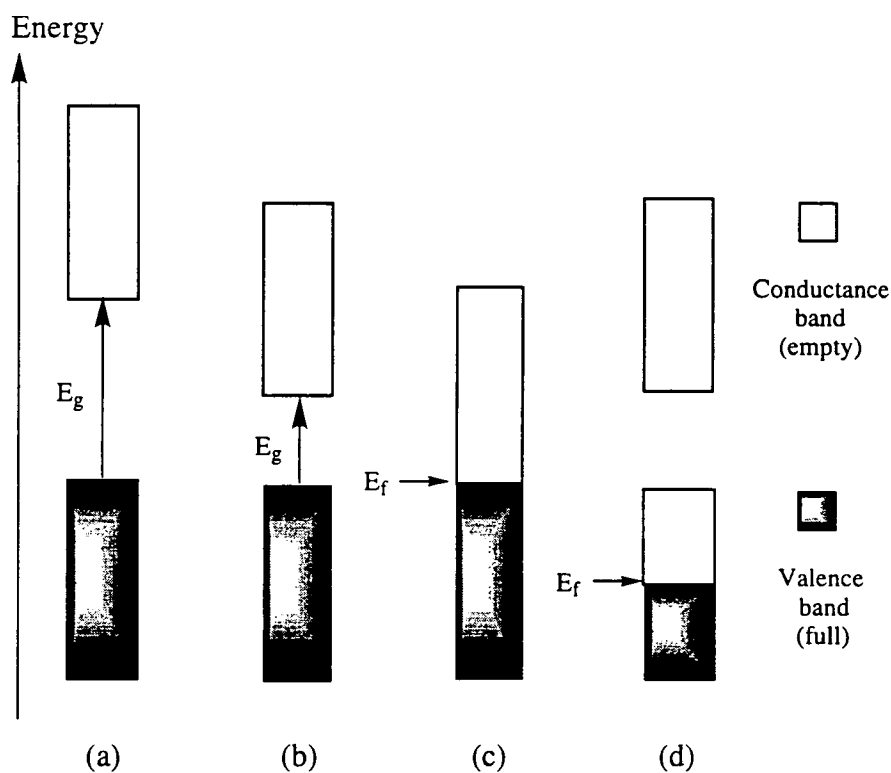

Figure 1.3 - Band structures of (a) an insulator, (b) a semiconductor, (c) a semimetal, (d) a metal.

Thus the difference between metals and semiconductors is that lowering of the temperature increases the ease of movement of a fixed number of charge carriers in the former, and decreases the number of charge carriers in the latter.

1.3.2 Charge-Transfer and Radical-Cation Salts

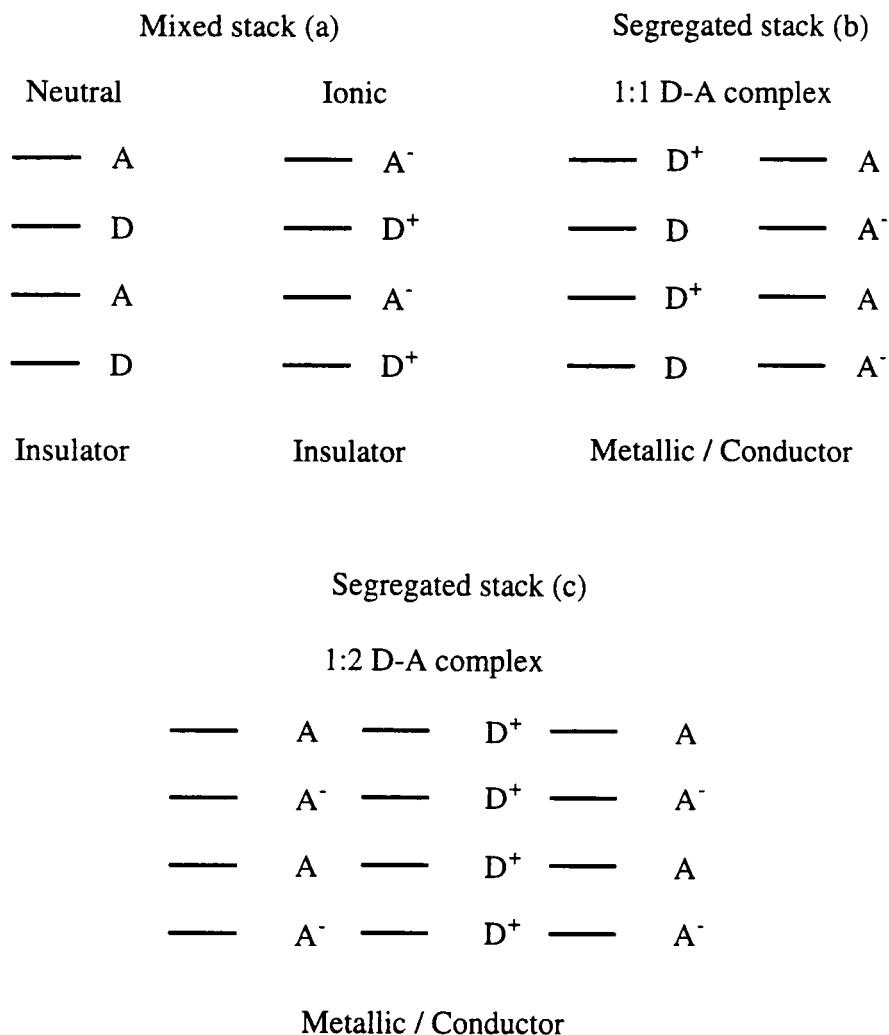

Figure 1.4 - Classification of C-T Complexes

A charge-transfer salt is a complex resulting from the transfer of an electron from a donor to an acceptor molecule. The most common case is that of an ionic crystal where donor and acceptor components stack alternately face-to-face (Figure 1.4a). In such a case, regardless of charge transfer, the resulting solid will have low conductivity. In special cases, ordered arrays of donor and acceptor components form segregated stacks with transfer of electrons between the stacks. If the complex has a 1:1 stoichiometry of donor and acceptor components and there is partial charge transfer (Figure 1.4b), or the complex is non stoichiometric (Figure 1.4c), a partially filled HOMO is formed and conduction may occur. In these cases the radical ions must be

may occur. In these cases the radical ions must be thermodynamically stable. There is considerable π -electron overlap in these complexes and delocalisation is along the one-dimensional stacks, consequently conductivity is anisotropic.

A radical-ion salt contains stacks of open-shell π -electron donors or acceptors, the counter ions being closed-shell species *e.g.* (Cl^- , I_3^- or K^+ , Cu^{2+}). Conductivity is also anisotropic along the stacks.

1.3.3 Peierls Distortion

In the 1950's Fröhlich¹⁴ and Peierls¹⁵ put forward theories on one-dimensional (anisotropic) metals. They argued that the physics of one-dimensional systems can be dramatically different from three-dimensional systems, in that the former could not support long range order, and lattice distortions would make them unstable. The nature of the partially filled bands determines the degree of this instability. In a half filled band each molecule is a radical ion and their unpaired spins provide a driving force for spin pairing. The pairing of spins, at a critical temperature, causes the dimerisation of molecules within the stack, which in turn causes the half-filled conduction band to split into a fully occupied band of lower energy and an empty band of higher energy with a band gap (known as the Peierls gap) between them. Thus a semiconducting or insulating state will emerge from a previously conducting state (Figure 1.5).

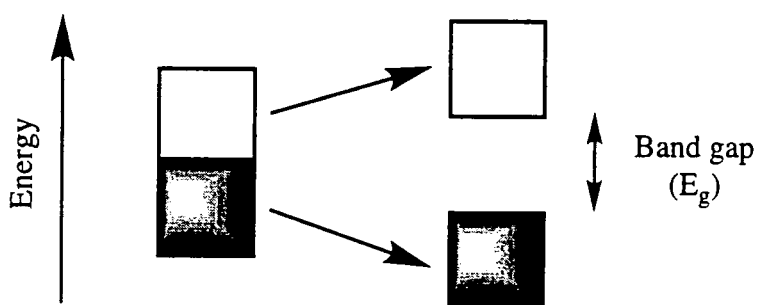

Figure 1.5 - Band splitting caused by Peierls distortion

The conducting chain also becomes contracted at points where two molecules have dimerised, and stretched inbetween. This in turn causes alternating zones of high and low charge density, known as a charge density wave (CDW). Conductivity which could result from the translation of the CDW is prevented by the band energy gap. Defects and impurities cause random electrostatic potentials which tie the CDW to the lattice and favour the Peierls distortion. In systems where the CDW is free to act as a charge carrier, high conductivity or even superconductivity may result. If a system

interacts in two or three dimensions, lattice rearrangement of the type described is more difficult and the Peierls distortion would become much less significant.

A more detailed discussion on the theory of conductivity in organic metals can be found in various review articles.¹⁶

1.4 ORGANIC π -ELECTRON DONOR MOLECULES AND THEIR CONDUCTING SALTS

As outlined previously, many conducting, organic, charge-transfer and radical-cation salts have been synthesised and their physical properties investigated. In the following sections the various families of organic π -electron donor molecules which have been used in the synthesis of potentially conducting salts, will be discussed. For convenience these donor systems are divided into five general groups and each group will be considered individually. These sections will focus on the main items of research interest within each family.

The first group consists of polycyclic aromatic hydrocarbons. As mentioned in Section 1.2, the first conducting organic radical cation salt incorporated perylene as the electron donor component and workers have since utilised other polyaromatic hydrocarbons as π -electron donors in the synthesis of conducting complexes.

The second group consists of polyarene donors which possess thioalkyl substituents, which improve the stability of the derived radical cation species and enhance the properties of their charge transfer salts.

The third group is the most extensive and consists of donors based on the tetrathiafulvalene (TTF) **2** structure. There are many excellent reviews^{1 23} on this highly successful family of π -electron donors, so only a brief overview will be given here.

The fourth group consists of *peri*-dichalcogenide bridge substituted polyarenes and contains systems for which some of the lowest oxidation potentials for any organic π -electron donors have been measured.

The fifth and final group consists of heteroarenes. These compounds are based on the polycyclic arenes but have one or more sp^2 carbons replaced by chalcogen atoms. There are two general types, those which are isoelectronic with the original arene and those which become isoelectronic on the loss of one or more electrons.

1.4.1 Polycyclic Arenes

Polycyclic arenes have a relatively low ionisation potential compared to other hydrocarbons¹⁷ and have been utilised as π -electron donor components in radical-cation salts. Akamatu³ *et al.* were the first to report that a bromine complex of the polycyclic

arene perylene **5**, had an electrical conductivity of a significant order ($1\sim 10^{-2} \text{ Scm}^{-1}$). Later, this work was criticised by Kommandeur and Hall for the time dependence of the conductivity (which decreased significantly after 2-3 weeks), the lack of a well-defined crystal structure and the non-stoichiometric composition of the complex.¹⁸ These workers synthesised well-defined iodine complexes of both perylene **5** and pyrene **6** and identified the problem of contact resistance in the conductivity measurement, which caused heating and consequent sublimation of iodine from the complex. They postulated that this effect may have caused the conductivity / time effects reported by Akamatu and solved the problem by using a modified four-probe, rather than two-probe, conductivity experiment. Single crystals of a perylene-iodine complex [(**5**)₂:(I₂)₃] had a conductivity of $12.5 \times 10^{-2} \text{ Scm}^{-1}$ at room temperature. A microcrystalline complex of pyrene and iodine [**6**:(I₂)₂] was also synthesised and this material exhibited a conductivity of $1.3 \times 10^{-2} \text{ Scm}^{-1}$ at room temperature. They also proved, by variable temperature experiments, that these complexes behaved as semiconductors. Both of these complexes were unstable in an open atmosphere, as iodine sublimed from the complex to leave behind solid polycyclic arene.

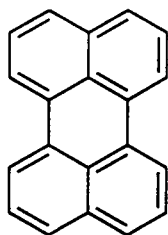

5

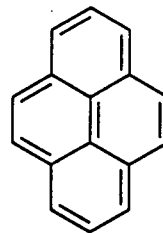

6

The instability of the radical cations of polycyclic arenes in solution hinders the synthesis of their charge-transfer and radical-cation salts. However, in 1978 Fritz *et al.* demonstrated that stable radical cations of these arenes may be generated by anodic oxidation and isolated in the presence of suitable anions as radical cation salts in the form of shiny black crystals (e.g. [naphthalene₂]^{•+} PF₆⁻).¹⁹ Kröhnke *et al.* developed this idea and synthesised a range of radical-cation salts incorporating various polycyclic arenes with a number of counter anions and measured their room temperature conductivities (Table 1.1).²⁰

These salts show a reasonable electrical conductivity and X-ray diffraction studies showed that arene stacks were the common structural principle within all these complexes (e.g. Figure 1.6). In addition, all the organic moieties within these stacks were crystallographically identical, suggesting that the radical cation is not localised. Both of these facts may contribute to the electrical conductivity (see Section 1.3).

Arene	X	Conductivity (Scm ⁻¹)
Naphthalene	PF ₆	0.12 ²¹
Fluoroanthene	PF ₆	0.05
	AsF ₆	0.02
	SbF ₆	0.01
Perylene	BF ₆	4x10 ⁻⁴
	PF ₆	0.04
	AsF ₆	0.04
	SbF ₆	4x10 ⁻³
Pyrene	AsF ₆	1x10 ⁻³
	SbF ₆	1x10 ⁻³
Triphenylene	PF ₆	7x10 ⁻³
	AsF ₆	3x10 ⁻³

Table 1.1 Salts [arene₂]⁺ X⁻ synthesised by electrocrystallisation²⁰ and their conductivities at 295° K

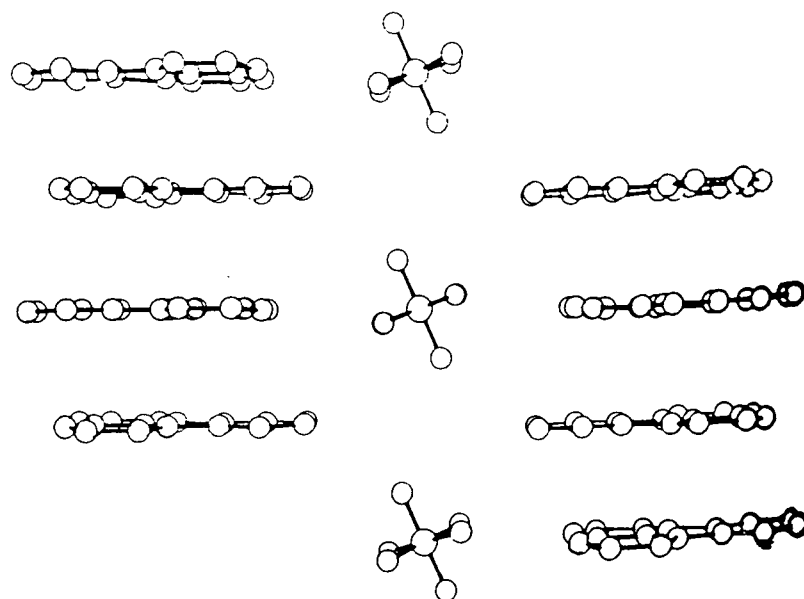

Figure 1.6 Crystal Structure²⁰ of [Fluoroanthene₂]⁺PF₆⁻

1.4.2 Thioalkyl Substituted Arenes

To improve the stability of the aromatic radical cations thioalkyl groups have been attached to the arene core. Not only may these substituents improve the stability of the radical cations, but they may also interact in the solid state to give supramolecular heteroatom contacts, which should improve the electronic dimensionality within a complex (see Section 1.3.3).

Heywang *et al.*²² synthesised 1,3,6,8-tetrakis(methylthio)pyrene **7** which exhibits an oxidation potential of $E_1 = 0.65$ V vs Ag/AgCl. Electrocrystallisation of this donor molecule with various counter anions formed crystalline radical-cation salts which have moderate to good conductivities. The single crystal conductivity of the perchlorate salt $(7)_2^{+}:\text{ClO}_4^-$ falls between 300 and 677 Scm^{-1} and exhibits a metallic like temperature dependence (Section 1.3.1). X-ray diffraction analysis of the perchlorate and triiodide salts revealed good overlap of the donor (**7**) units which were also arranged into stacks. The heat stability of these salts was a vast improvement upon the basic arene salts, the triiodide being stable up to 245°C whereupon loss of iodine and reversion to compound **7** occurs.



Following the observation that BEDT-TTF (**4**) formed superconducting salts²³ (Section 1.2) the ethylenedithio bridge, evident in BEDT-TTF, was incorporated into the polycyclic arenes. Lapouyade *et al.*²⁴ synthesised tris(ethylenedithio)benzene (TEDTB) **8** which was found, by cyclic voltammetry, to have a relatively high, partially reversible, one-electron redox step at 1.1 V and an irreversible second step at ca. 1.5 V (*vs* SCE). A crystalline radical-cation salt was prepared, by electrocrystallisation, with BF_4^- in a 2:1 stoichiometry (donor to anion). This salt exhibited a single crystal conductivity of $\sigma_{\text{r}} = \text{ca. } 10^{-2} \text{ Scm}^{-1}$ with a semi-conducting temperature profile. X-ray diffraction analysis (Figure 1.7) revealed stacks of TEDTB

transverse electronic interactions through S...S contacts,^{24a} indicating the possibility of escaping from the electronic one-dimensionality conventionally detected in arene salts (section 1.4.1).

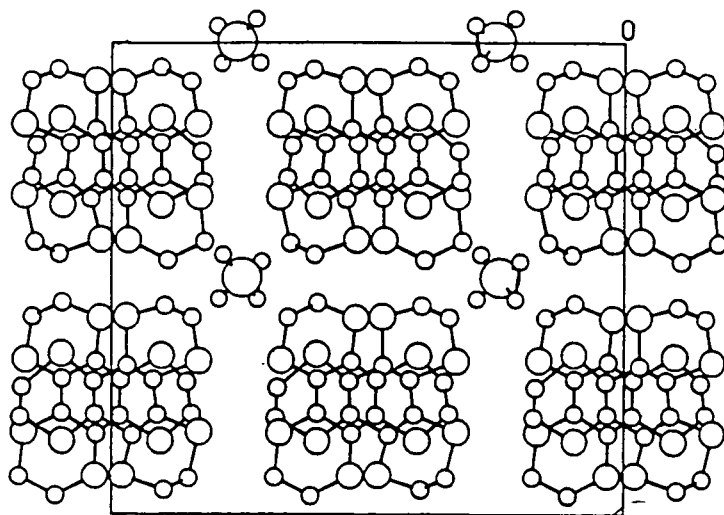
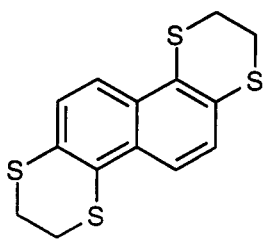
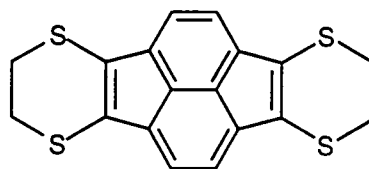

Figure 1.7 Crystal structure²⁴ of $(\text{TEDTB})_2\text{BF}_4$

Tani *et al.* have synthesised the naphthalene derivative **9**²⁵ and the pyracylene derivative **10**.²⁶



9



10

Cyclic voltammetric studies on compound **9** revealed, two single-electron oxidations with peak values +0.90 and +1.25 V, respectively (vs. SCE). Two crystalline radical-cation salts were grown, $(\mathbf{9})^{+\bullet}_2\text{ClO}_4^-$ and $(\mathbf{9})^{+\bullet}_2\text{BF}_4^-$, which exhibited relatively high electrical conductivities, $\sigma_{\text{RT}} = 3.5$ and 0.4 Scm^{-1} , respectively. The temperature dependence of the conductivity for $(\mathbf{9})^{+\bullet}_2\text{ClO}_4^-$ indicated semiconducting behaviour. The single crystal X-ray structure of this salt (Figure 1.8) shows columnar stacks of donor and short S...S contacts, 3.574 Å within the columns and 3.822 Å between the

columns. The first of these contacts is significant in that it is shorter than the sum of the van der Waals radii of two S atoms (3.7Å). These columns and close S...S contacts are consistent with the good electrical conductivity of the complex.

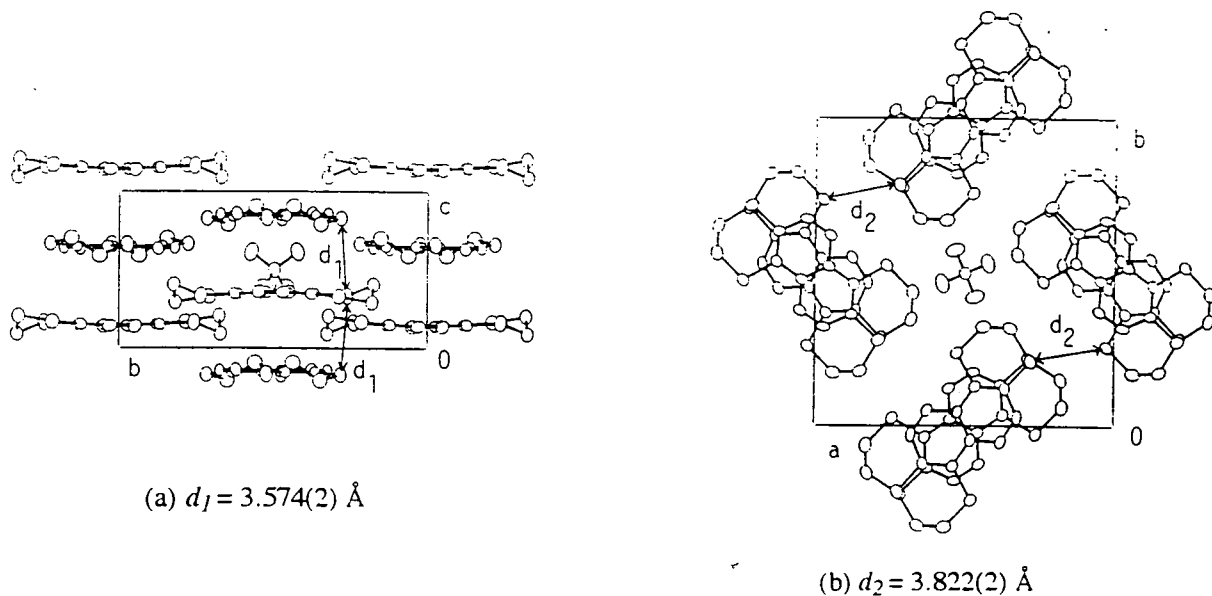

Figure 1.8 Crystal Structure²⁵ of $(\mathbf{9})^{+\bullet} \cdot 2\text{ClO}_4^-$ viewed along (a) the a axis and (b) the c axis.

Compound **10** exhibited two, reversible, one-electron oxidations, $E_{1/2}^1 = +0.43 \text{ V}$ and $E_{1/2}^2 = +0.75 \text{ V}$ (vs. SCE), which are considerably lower than those for other electron donors of this type. Four radical-cation salts were synthesised from this donor. The ClO_4^- and BF_4^- salts did not provide a clear stoichiometry by elemental analysis and were unsuitable for X-ray diffraction. Their compressed pellet conductivities were $\sigma_{\text{rt}} = 10^{-3}$ to 10^{-4} Scm^{-1} respectively. The two other salts were identified by elemental analysis as $(\mathbf{10})_3^{2+\bullet}(\text{PF}_6^-)_2$ and $(\mathbf{10})_2^{+\bullet}\text{I}_3^-$ and gave conductivities of 10^{-5} and 10^{-2} Scm^{-1} , respectively. The single crystal X-ray diffraction study of the PF_6^- salt showed S...S interactions and segregated stacks consisting of 3 separate types of donor moiety **10**, two of which were radical cation species and the other electrically neutral. This arrangement explains the low conductivity of the complex as the non-uniform stack hinders long-range electron mobility. The X-ray diffraction study of the I_3^- salt revealed a structure that was similar to that of $\kappa\text{-(BEDT-TTF)}_2\text{I}_3$, (BEDT-TTF = **4**), which shows superconductivity at normal pressure (Section 1.4.3.1).

1.4.3 Chalcogenated Fulvalenes

TTF (**2**) was first reported in 1970 and since then many analogous π -electron donor molecules based on this system have been synthesised. There are many excellent reviews²⁷ on these donors so only a brief overview is presented here on a couple of the main, interesting areas of research.

1.4.3.1 'Core-TTF' Donors

Tetrathiafulvalene (TTF) **2** has been mentioned in Section 1.2 and its synthesis,²⁸ and the properties of its charge-transfer and radical-cation salts have been much investigated. The substitution of the sulfur atom in this molecule by other chalcogens has also been successfully achieved. Tetraselenafulvalene (TSF, **11**)²⁹ and tetratellurafulvalene (TTeF, **12**)³⁰ are considerably harder to synthesise than TTF but exhibit higher conductivity values on complexation with the electron acceptor TCNQ (**1**). Room temperature conductivity values for the TCNQ complexes are 700-800 Scm^{-1} for TSF and 2200 Scm^{-1} for TTeF, compared with 500 Scm^{-1} for TTF-TCNQ. The enhancement in interstack π -interactions in the donor regions, which are facilitated by the increasingly diffuse p and d orbitals of the selenium and tellurium atoms, has been cited as a reason for this increase in conductivity.

The σ -bond framework of these molecules may be extended by attaching methyl groups to the TTF system to furnish the donors tetramethyl-TTF (TMTTF, **13**),³¹ and tetramethyl-TSF (TMTSF, **3**).⁵¹ Tetramethyl-TTeF is still unknown.

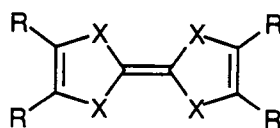

3 TMTSF, X = Se, R = Me

11 TSF, X = Se, R = H

12 TTeF, X = Te, R = H

13 TMTTF, X = S, R = Me

Donor **3** has aroused outstanding interest within the field of organic, electrically conducting materials. By varying the anion, salts of the general formula $(\text{TMTSF})_2\text{X}$ were synthesised (*e.g.* where $\text{X}=\text{PF}_6^-$, FSO_3^- , ReO_4^- and ClO_4^-), and these are known as

the Bechgaard salts. Under hydrostatic pressure $(\text{TMTSF})_2^+\text{PF}_6^-$ became the first organic superconductor (Section 1.2).

The single crystal X-ray crystal structure of $(\text{TMTSF})_2^+\text{BrO}_4^-$ is shown in Figure 1.9.³² The donor molecules are essentially planar and are stacked, in a ring-over-bond fashion, into donor columns where both *inter-* and *intra-* stack Se...Se distances are very similar. These *interstack* interactions give rise to electrical two-dimensionality, rather than the one-dimensionality of TTF-TCNQ, with the advantage that Peierls distortion is more likely to be suppressed (Section 1.3.3). The formation of a three-dimensional array is foiled by the presence of the counter anions.

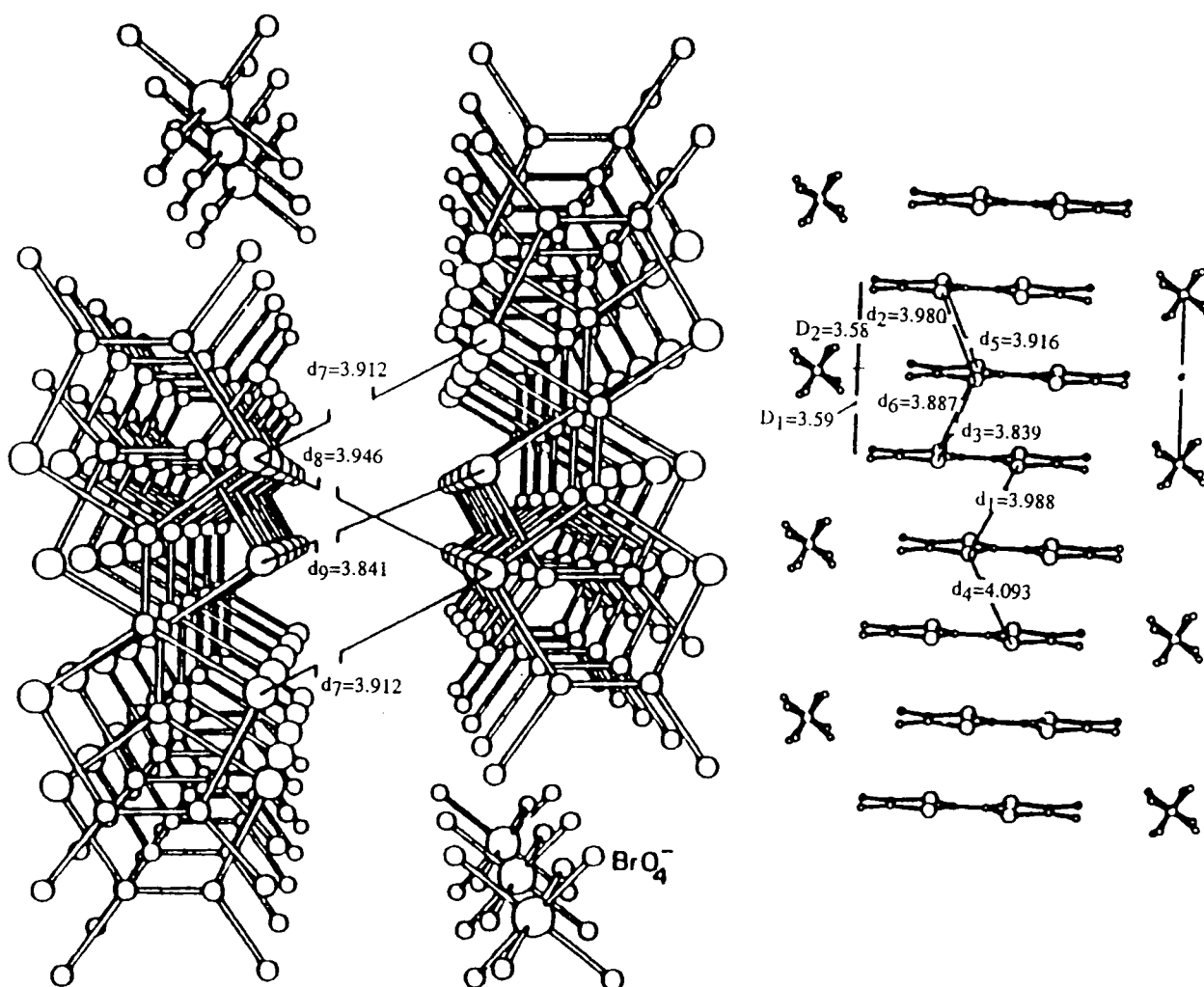
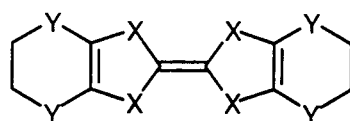

Figure 1.9 Crystal Structure of $(\text{TMTSF})_2^+\text{BrO}_4^-$. Interstack Se...Se distances are shown on the left, whilst the intrastack distances are on the right.

One of the most interesting TTF derivatives based donors is BEDT-TTF 4 which is the donor component of a superconducting salt with the highest T_c for any

organic superconductor (Section 1.2) (excluding fulleride salts)³³. BEDT-TTF was first synthesised in 1977,³⁴ and most of the known ambient pressure organic superconductors feature this donor.⁹ It is perhaps surprising, when we regard the case of the Bechgaard salts, that no complexes of the donors BEDS-TSF³⁵ **14** and BEDS-TTF³⁶ **15** exhibit superconducting properties. The salts (**14**)₂⁺I₃⁻ and (**4**)₂⁺I₃⁻ are isostructural, but only the latter shows superconductivity at both ambient and applied pressures.³⁷



- 4** BEDT-TTF, X = S, Y = S
14 BEDS-TSF, X = Se, Y = Se
15 BEDS-TTF, X = S, Y = Se

There is a difference in structures of the Bechgaard salts and those of the BEDT-TTF family which lead to their good electrical conductivities. The non-planarity of BEDT-TTF **4**, together with the large thermal vibration of the peripheral ethylene bridges, hinders the good π -overlap within face-to-face donor stacks which occurs in the Bechgaard salts. Superconductivity is still observed, however, in these complexes despite this situation.

An example of this new type of assembly is seen in the single crystal X-ray structure of the salt *k*-(BEDT-TTF)₂Cu[N(CN)₂]Br (Figure 1.10).³⁶ This structure shows the formation of orthogonal BEDT-TTF dimers (κ -packing), with close intermolecular S...S contacts shorter than 3.60 Å, forming an ordered, conducting, three-dimensional S...S network. Hence the material is able to support superconductivity at higher temperatures than seen for other salts. The salt (BEDT-TTF)₂I₃ forms four different types of stoichiometric phases, termed α , β , θ and κ , of which the last three are superconductors.^{37a,38} Recently, it has become a major challenge to produce further α , β , θ or κ -phase charge-transfer salts.

Other structures which show κ -type phases include (BMDT-TTF)₂,³⁹ (MDT-TTF)₂AuI₂,⁴⁰ and (DMET)₂AuBr₂,⁴¹ derived from the donors **16**, **17** and **18**, respectively. The last two donors illustrate that superconductivity does not necessarily require symmetrical donors (both provide superconducting salts whilst the parent symmetrical donors of the former, TTF and BMDT-TTF, yield at best, only metallic CT materials).

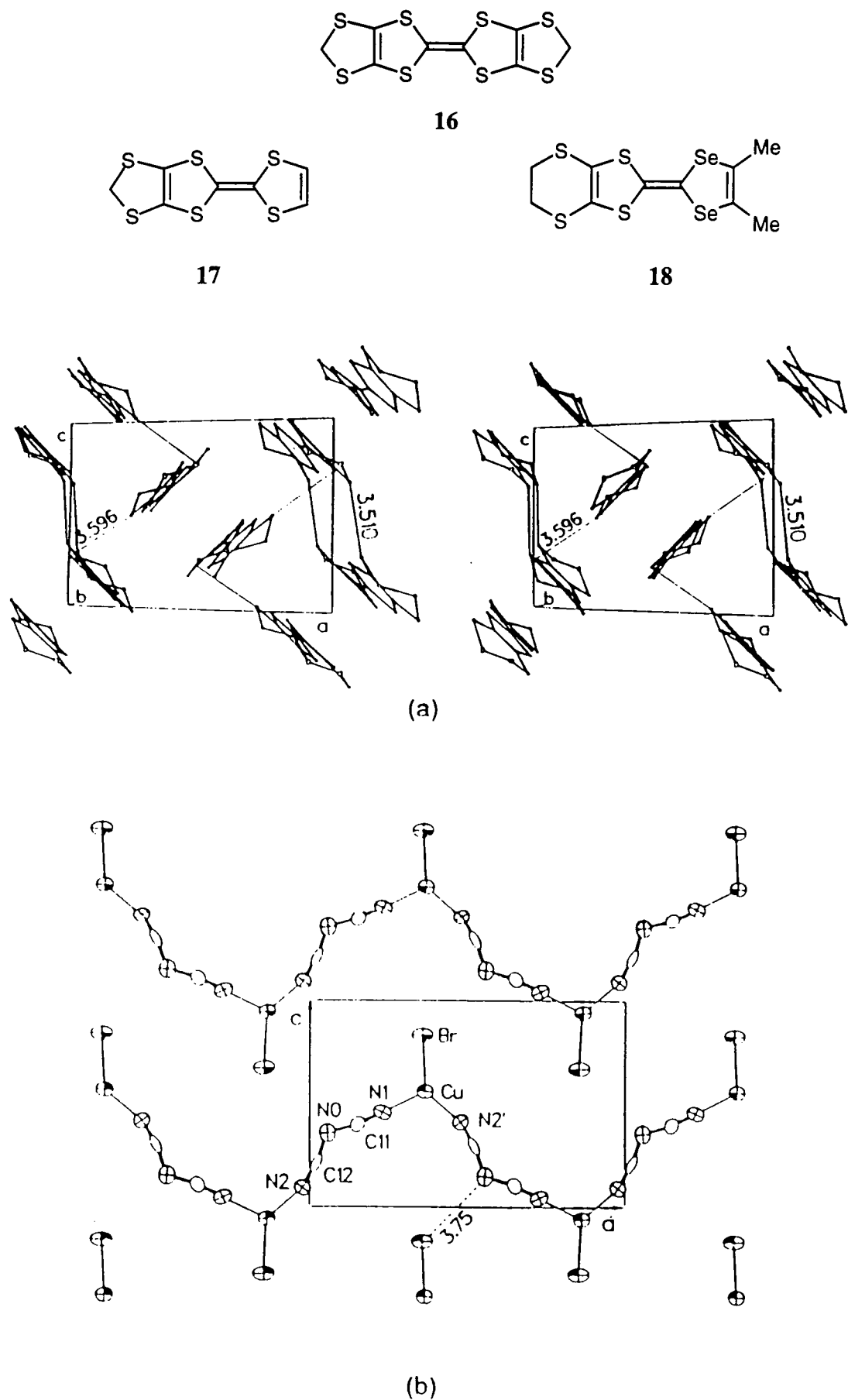

Figure 1.10 Crystal structure of k -(BEDT-TTF) $_2$ Cu[N(CN) $_2$]Br (a) orthogonal BEDT-TTF dimers, (b) polymeric chains with anion

1.4.3.2 Extended TTF Systems with Central Spacers

The concept behind π -extended TTF systems is that a conjugated linker placed between the two 1,3-dithiole ring systems of the TTF system will lower the oxidation potential and reduce the intramolecular Coulombic repulsion in the oxidised dication state, and thus this state will be more accessible, perhaps facilitating high electron mobility.

Various vinylogous TTF derivatives have been synthesised. Yoshida *et al.* have prepared ethanediylidene-2,2'-bis(1,3-dithiole) **19**,⁴² and 1,4-butenediylidene-2,2'-bis(1,3-dithiole) **20**.⁴³ The redox behaviour of these two compounds, compared with TTF, is presented in Table 1.2.



Donor	E_1 / V	E_2 / V	$(E_2 - E_1) / V$
2 TTF	0.34	0.71	0.37
19	0.20	0.36	0.16
20	0.22	---	---

Table 1.2: Cyclic voltammetric data for TTF **2** and donors **19** and **20**. Pt electrode vs. Ag/AgCl, supporting electrolyte Et₄NClO₄ 0.1M, 20°C, in CH₂Cl₂.

Donors **19** and **20** show a considerable lowering of the first and second oxidation potentials, and the difference between the two waves is greatly reduced in going from TTF to donor **19**. On extending the π -spacer to **20** there is no further reduction in the redox values but the 1,3-dithiole rings now act independently of each other and a single, two-electron oxidation wave is observed. This indicates that the insertion of carbon sp²-derived spacer groups does indeed suppress the Coulombic repulsion and promotes the formation of the dication state at lower applied potentials.

Other TTF based systems synthesised with vinylogous spacers,⁴⁴ include donor **21a**⁴⁵ which forms a 1:1 charge-transfer salt with TCNQ (Figure 1.11). The complex has a mixed-stack structure and thus a low conductivity (Section 1.3), and on the whole the salts of vinylogous TTF-TCNQ salts have had rather disappointing properties.

However, Misaki *et al.* have reported high conductivities, and even superconductivity in radical ion salts of **21b**.⁴⁶

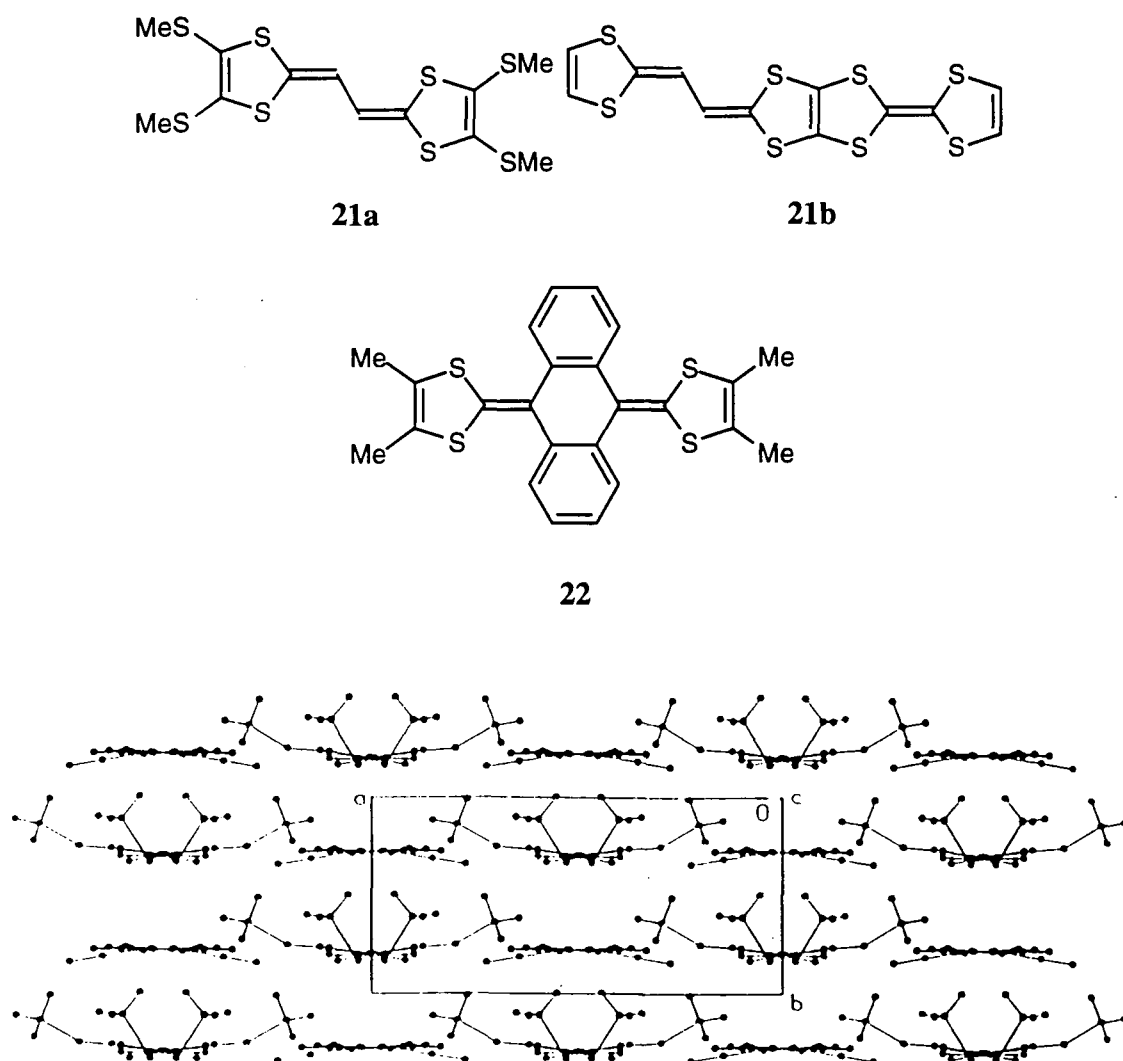

Figure 1.11 Crystal structure of **21a**TCNQ complex viewed down the long axes of the molecules

Another approach to separating the 1,3-dithiole rings, in an extended TTF system with a conjugated linker, is to utilise aromatic rings.⁴⁷ These spacers provide a more rigid system which may encourage the growth of crystalline organic conductors.⁴⁸

Compound **22** is an interesting example,⁴⁹ it exhibits a two electron oxidation to the dication state at +0.34 V, showing that the two 1,3-dithiole rings act simultaneously. The oxidation is not cleanly reversible, but the reduction of the dication can be detected at +0.07 V. This donor forms a conducting (room temperature $\sigma = 60 \text{ Scm}^{-1}$) 1:4 TCNQ complex where the 1,3-dithiolium cations form dihedral angles of 86° relative to the anthracene plane. This twisted donor conformation is very unusual for a semi-metallic TCNQ complex based on a TTF system.

1.4.4 *Peri*-Dichalcogen Bridged Polycyclic Arenes

1.4.4.1 Introduction

Polycyclic arenes which feature *peri*-dichalcogen bridges as components in conducting organic materials, have generated much interest.⁵⁰ A notable representative of these compounds is naphthaceno[5,6-cd:11,12-c'd']bis[1,2]dithiole **23**, known as tetrathiotetracene (TTT). This compound was the first widely-studied member of this family of donors.⁵¹ It exhibits a stronger electron donating ability than TTF and forms complexes which have good room temperature conductivity, including an iodine complex with the very high conductivity value of 10^3 Scm^{-1} .

It has been postulated that these compounds are excellent π -electron donors because of the strong interaction between the chalcogen lone pairs in the heteroatom bridge and the π -orbitals of the arene core.⁵² Because of the extensive delocalisation within the molecule, the HOMO level of the compound is elevated, which in turn, lowers its ionisation energy and oxidation potential. Another model concerns the fused 1,2-dithiole rings that feature in these systems, which are 7π electron systems and hence the loss of an electron results in a favourable 6π aromatic state.⁵³ Poor solubility is a problem with this family of donors so a large amount of research has focused on increasing the solubility by introducing alkyl groups (which also increase the donor properties) and synthesising smaller homologues. Replacing sulfur with selenium and tellurium often results in an improvement in the donor properties but to the detriment of the solubility of the system.

The synthesis of these compounds is predominantly based upon the reaction of a sodium dichalcogenide and certain *peri*-substituted polyarenehalides (usually chlorides), in a dipolar aprotic solvent such as DMF or hexamethylphosphoramide (Scheme 1.1). This step is simple and the generation of the arylhalide often proves to be the most technically challenging procedure. The sodium dichalcogenides are easily generated by reacting the chalcogen with sodium metal in the reaction solvent before the addition of the arylhalide.

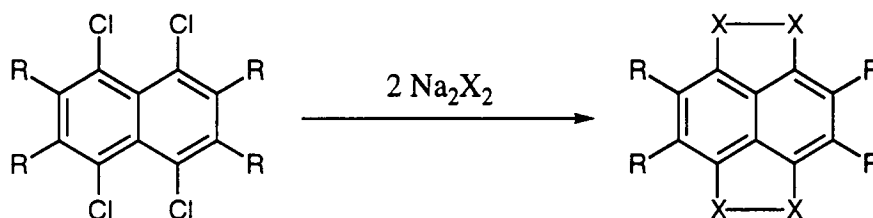

Scheme 1.1 R = alkyl or aryl, X= S or Se or Te.

Separate families of compounds based on the parent polycyclic arenes which have been generated are reviewed below. The oxidation potentials obtained by cyclic voltammetry for each donor are compiled together, for ease of comparison, in Table 1.3 at the end of this section.

1.4.4.2 Tetracene Based Systems

As mentioned above (Section 1.4.4.1) TTT (**23**) is an excellent electron donor system and therefore, by analogy with the higher chalcogen TTF systems (Section 1.4.3.1), tetraselenotetracene (TSeT)⁵¹ **24** and tetratellurotetracene (TTeT)⁵⁴ **25** have successively lower oxidation potentials (Table 1.3, due to calibration with a different reference electrode TTeT does not feature in the table but has been shown independently to have lower oxidation potentials than TSeT⁵⁴).⁵⁵ A notable problem is the poor solubility of TTT in common solvents and, in addition, TSeT and TTeT are successively more insoluble. This has hindered complex formation, but nonetheless, a range of charge-transfer and radical cation salts of TTT and TSeT have been prepared.⁵¹ The most interesting of these salts are (TTT)₂⁺I₃⁻⁵⁶ and (TSeT)₂⁺I⁻⁵⁷ which both have the remarkably high conductivity values of $\sigma_{rt} = 1 \times 10^3$ and $3.8 \times 10^3 \text{ Scm}^{-1}$, respectively. The single crystal X-ray structure of the complex (TTT)₂⁺I₃⁻ is shown in Figure 1.12. The presence of TTT stacks and iodine chains are seen and the interplanar TTT...TTT spacing is identical along the whole stack (3.32 Å), indicating that cationic charge is delocalised along these stacks, whilst iodine chains occupy the interstack channels.

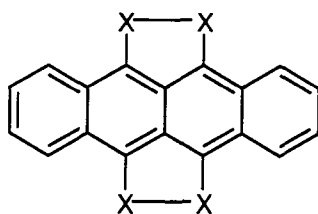

23 TTT X = S

24 TSeT X = Se

25 TTeT X = Te

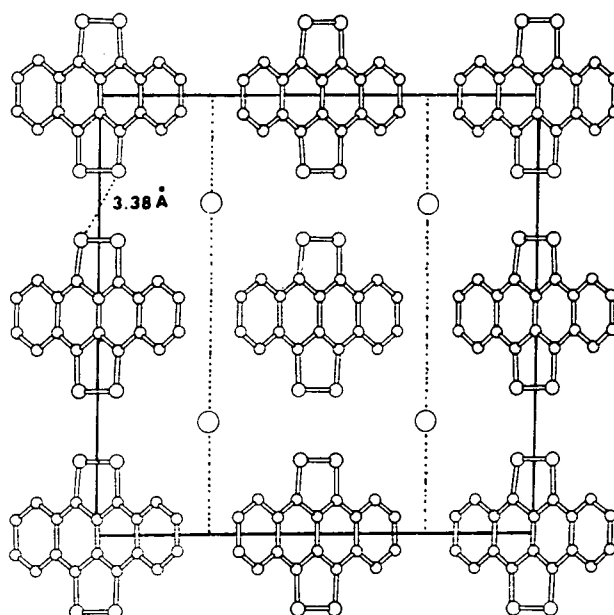
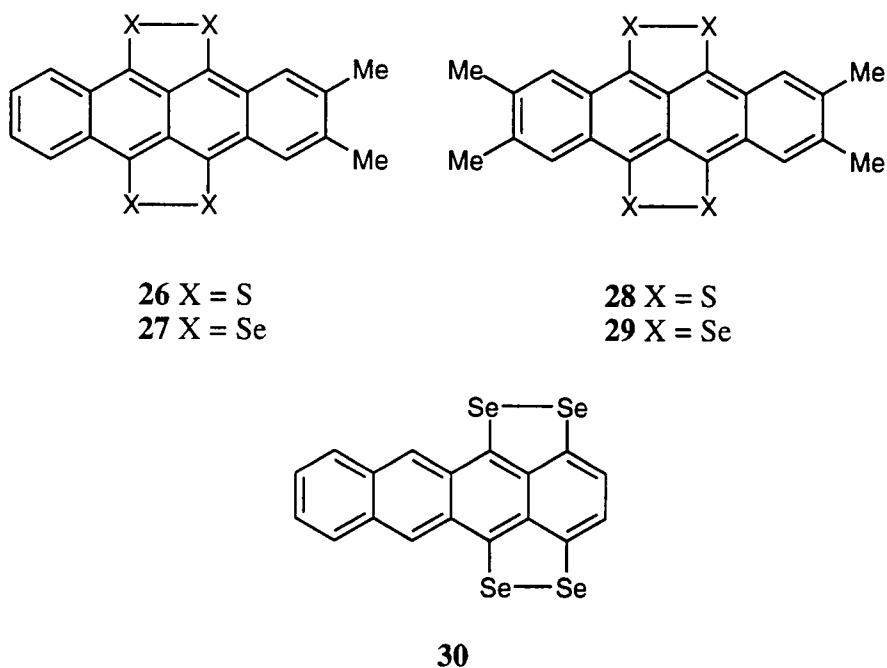

Figure 1.12 Crystal structure of $(TTT)_2^+I_3^-$ projected along the conducting axis



To enhance not only the donor strength but also the solubility of these compounds, certain workers have synthesised systems exhibiting peripheral alkyl groups,^{55,58} e.g. the unsymmetrical dimethyl derivatives DMTTT **26** and DMTSeT **27**, and the symmetrical tetramethyl compounds TMTTT **28** and TMTSeT **29**. No TTeT analogues have been reported. Cyclic voltammetry revealed that these compounds

show two reversible redox waves whose half-wave oxidation potentials are lower than those of the parent compounds **23** and **24**, and are some of the lowest values for any organic π -electron donor (Table 1.3). TCNQ complexes of these compounds have good conductivities in the range of 1 to 0.1 Scm^{-1} .⁵⁵

The unsymmetrical organoselenium compound **30** has also been synthesised and although a weaker electron donor than TST, it has improved solubility and conducting salts have been generated.⁵⁹

1.4.4.3 Anthracene Based Systems

The tetracene (Section 1.4.4.2) based systems have good electron donor properties but low solubility. Thus, research has been directed towards the synthesis of lower homologues in the hope of improved solubility whilst emulating these donor properties.

There are two tetrathioanthracene isomers, compounds **31**⁶⁰ and **32**,⁶¹ and also their corresponding selenium analogues **33**⁶² and **35**,⁶¹ which were all synthesised using the procedure outlined in Scheme 1.1. However, compared to the tetracene systems their donor abilities are much decreased (Table 1.3) and their solubilities are not much improved. The tellurium analogues are unknown. A few conducting complexes of these donors have been synthesised,⁶³ but more interesting salts involve the di- and tetra-methyl derivatives of the 1,4,9,10-tetrachalcogenoanthracenes, compounds **35** - **42**. These were synthesised by Otsubo and co-workers⁶⁴ in the hope of increased solubility and donor ability in the manner of the alkyl substituted compounds **26** - **29**.

These donors do indeed have an improved donor ability,^{64b} although the effect is more noticeable in the first, rather than the second, oxidation potential. There seems to be no difference between the enhancement effect of dimethylation at the 2,3- or 6,7 positions and substitution of sulfur for selenium seems to have little effect. However, substitution by tellurium considerably lowers both the first and second oxidation potentials, so compounds **37** and **42** have very strong electron donating abilities, comparable, or superior to, that of TTT **23**.

Many conducting charge-transfer^{64b} and radical-cation⁶⁵ salts have been synthesised from these donors. X-ray analysis has shown that most of the more highly conducting salts have uniformly stacked donor columns, indicative of strong intermolecular heteroatomic interactions. The most conducting salt in this series is the 2:1 bromide salt of the tellurium donor **37** (figure 1.13) which exhibits a room temperature conductivity value of 1300 Scm^{-1} .^{65c}

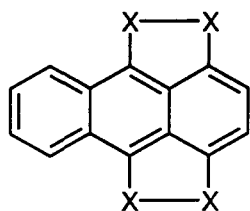

31 X = S
33 X = Se

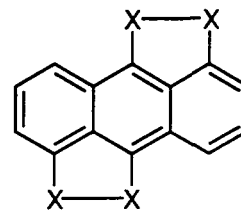

32 X = S
34 X = Se

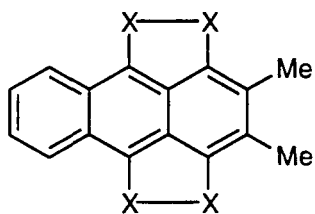

35 X = S
36 X = Se
37 X = Te

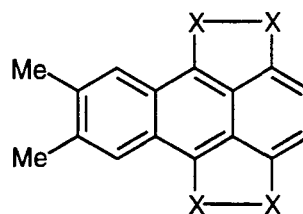

38 X = S
39 X = Se

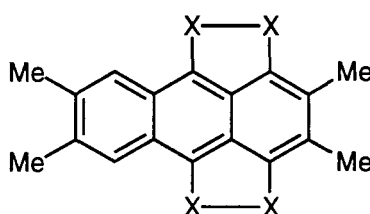

40 X = S
41 X = Se
42 X = Te

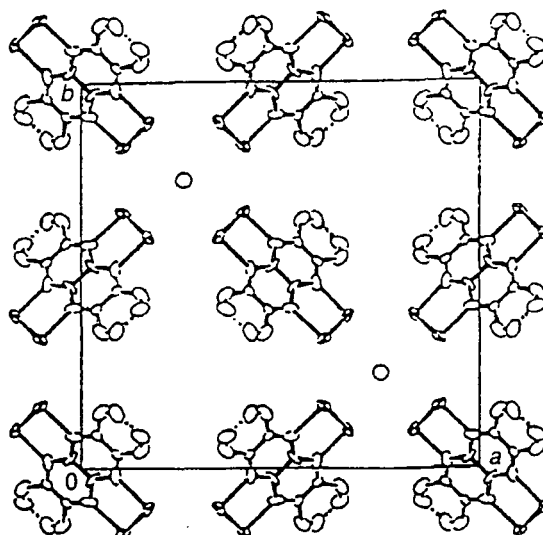
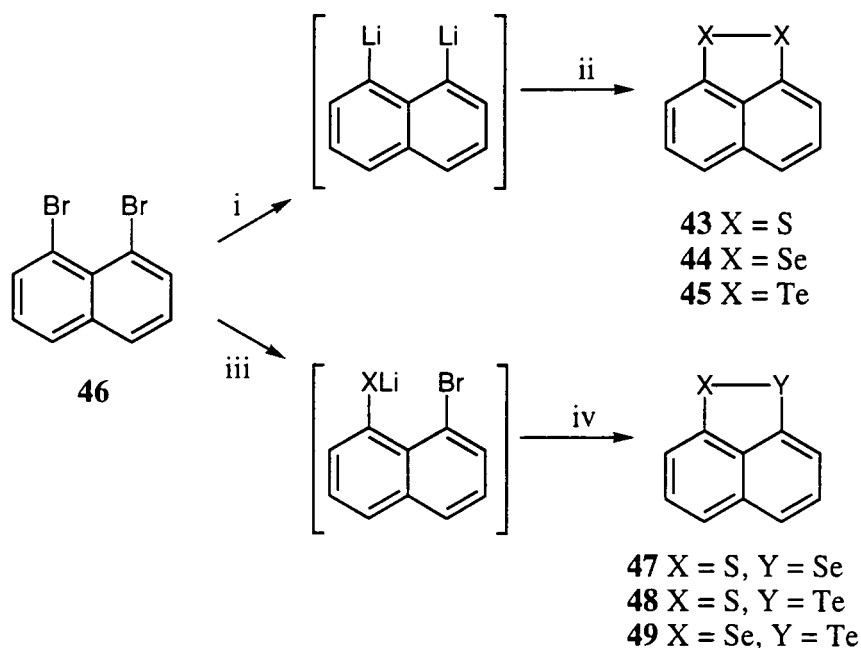

Figure 1.13 Crystal structure^{65c} of 37_2Br projected onto the ab plane

1.4.4.4 Naphthalene Based Systems

Dichalcogenide donors based on naphthalene are the simplest compounds in this series. The mono-bridged donors **43** - **45** have been synthesised (Scheme 1.2) via the double lithiation of 1,8-dibromonaphthalene **46** followed by the chalcogen insertion of sulphur, selenium or tellurium, respectively.⁶⁶ The unsymmetrical sulfur - selenium (**47**), sulfur - tellurium (**48**) and selenium - tellurium (**49**) compounds have also been synthesised by two successive lithiation / chalcogen insertion reactions (Scheme 1.2).⁶⁷



Scheme 1.2 i, 2 ⁿBuLi; ii, X; iii, ⁿBuLi, X; iv, ⁿBuLi, Y.

Compounds **43** and **44** have also been synthesised using other different methodologies.^{50,68}

Mono-bridged dichalcogens of this type show only one oxidation potential and its value (Table 1.3) is lowered on going from sulfur to selenium to tellurium. The conductivity of the TCNQ charge-transfer complexes of compounds **43** - **45** also increases with chalcogen size: **43**-TCNQ, 10^{-11} Scm⁻¹; **44**-TCNQ, 5×10^{-6} Scm⁻¹; **45**-TCNQ, 2×10^{-2} Scm⁻¹.^{66c}

Bis-dichalcogen substituted naphthylenes **50** and **51** are more interesting than **43** - **45** as they exhibit two redox waves. Wudl *et al.* studied **50** and found that its TCNQ charge-transfer complex has the high room temperature conductivity of 40 Scm⁻¹.⁶⁹ Unfortunately, apart from an iodine complex, the radical-cation salts which have also been synthesised from **50** have not shown high conductivities.⁷⁰ The selenium system **51** has been synthesised but its insolubility in common solvents prevents the study of its

complexes.⁷¹ In addition, it has not been possible to synthesise the tellurium derivative, probably due to high insolubility.

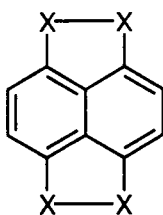

50 X = S
51 X = Se

The insolubility of compounds **50** and **51** led Otsubo *et al.* to synthesise systems **52** - **57** which, predictably, are more soluble and have lower oxidation potentials than the parent systems.⁷²

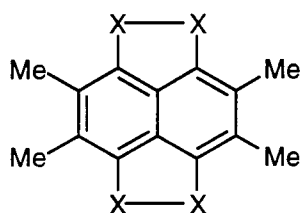

52 X = S
53 X = Se
54 X = Te

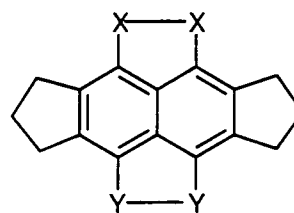

55 X = Y = S
56 X = Y = Se
57 X = S, Y = Se

These compounds were synthesised from the respective aryl tetrachlorides and sodium dichalcogenides, as per Scheme 1.1, albeit in low yield (6-19 %). Compound **57** was synthesised by addition of one equivalent sodium disulphide and the isolation of the mono-bridged system, followed by addition of sodium diselenide, to afford this unsymmetrical donor.

As can be seen from Table 1.3, the first and second oxidation potentials of compound **54** are almost identical to those of TTF (+0.34 and +0.71 V respectively). The improved solubility aids complexation studies and various charge-transfer and radical-cation salts of these donors have been synthesised which show conductivities over a wide range (10^1 to 10^{-8} Scm^{-1}).^{72b} The best of these was the 1:1.14 radical-cation complex of **52** and I^- which exhibited a room temperature conductivity of 1.8 Scm^{-1} . Unfortunately the tellurium compound **54** decomposed under electrolysis and so no radical-cation salts could be generated. In addition only one crystalline salt of the unsymmetrical donor **57** could be obtained (1:1 with TCNQF_4 , semiconducting).

1.4.4.5 Systems Based upon Other Arenes

Related to the mono-dichalcogen bridged naphthylenes **43** - **45** are the acenaphthene systems **58** - **60**.⁷³ The introduction of an ethylene bridge to the naphthylene reduces the oxidation potential of the system in relation to the parent bridged naphthalene (Table 1.3), the best system being the tellurium donor **60** showing a reversible one electron oxidation at +0.33 V. This compound also forms charge-transfer salts with various TCNQ type donors which have good conductivity values

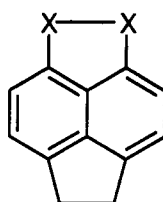

58 X = S
59 X = Se
60 X = Te

The di-sulfur, -selenium and -tellurium bridged acenaphthylenes **61** - **63** have also been synthesised.⁷⁴ 5,6-Dibromoacenaphthylene **64** was treated with ⁿbutyl-lithium to generate a dilithio derivative which was consequently reacted with the appropriate elemental chalcogen to generate the bridged systems (Scheme 1.3).

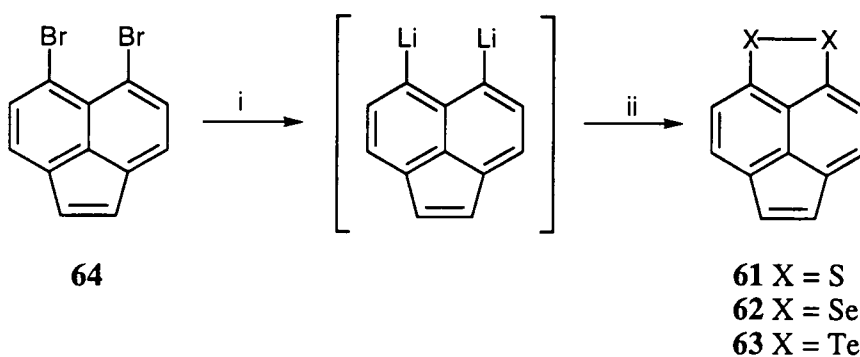

Scheme 1.3 i, 2 ⁿBuLi, THF, -78°C; ii, 2X

Cyclic voltammetric studies of these compounds reveal that **61** and **62** do not exhibit reversible oxidation waves and that the tellurium derivative **63** shows a half-wave oxidation potential of + 0.60 V (Table 1.3).⁷⁵ Black TCNQ salts have been synthesised from all three,⁷⁴ but the room temperature conductivity of the salts of **61** and **62** were poor, being 10^{-8} and 10^{-7} Scm⁻¹, respectively. The TCNQ complex of **63** was unstable and gave an unreliable conductivity measurement of 2×10^{-4} Scm⁻¹.

Similar systems have been synthesised using fluoranthene as the parent polycyclic arene. Fluoranthene itself has been shown to form highly conducting radical cation salts (Section 1.4.1, Table 1). Compounds **65** - **67** were synthesised by sodium dichalcogenide substitution on 3,4-dichlorofluoranthene **68** in varying yields (Scheme 1.4).⁷⁵

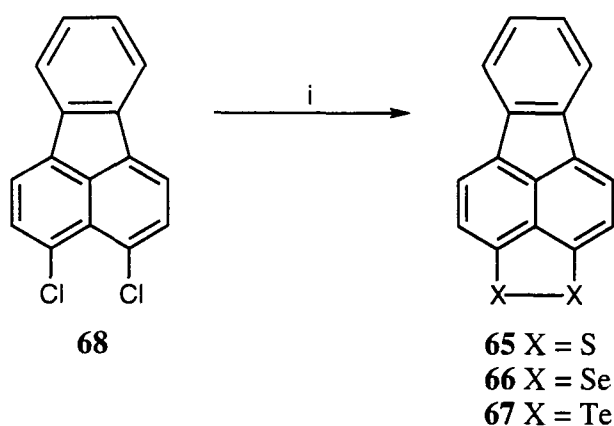

Scheme 1.4 i, Na₂X₂, DMF, 90 - 140°C (X = S, 26 %; X = Se, 77 %; X = Te, 18 %)

Cyclic voltammograms (Table 1.3) of compounds **65** - **67** show reversible one electron oxidations but these are not as low as the corresponding values for their mono-bridged naphthalene counterparts **43** - **45**.⁷⁶ It might be concluded then, that the interaction of the arene and the chalcogen of peri-chalcogenonaphthalenes is reduced by the introduction of a fused conjugated ring at the other peri position. This could also be the case for the acenaphthylene systems **61** - **63**.

Both compounds **65** and **66** form 1:1 charge-transfer salts with TCNQ and TCNQF₄ but these showed low conductivities ($\sigma_{rt} = 10^{-8}$ to 10^{-11} Scm⁻¹) and compound **67** failed to form such complexes.⁷⁶ More conducting radical-cation salts were synthesised from all three donors, the best being **66**-(I)₂ which showed a room temperature conductivity of 1.5×10^{-3} Scm⁻¹.⁷⁶

A variety of bis-dichalcogen bridged phenanthrenes **69** - **74** have been synthesised, by Otsubo *et al.*, from 1,8,9,10-tetrachlorophenanthrenes which were subsequently reacted with the various sodium dichalcogenides (cf. Scheme 1.1).⁷⁷

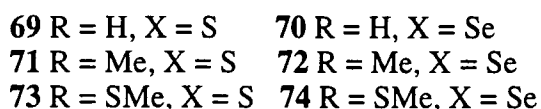
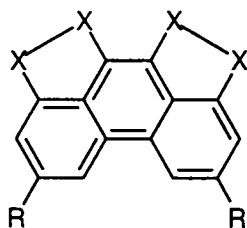

These compounds are structurally related to bis-dichalcogen bridged anthracenes (Section 1.4.4.2) but the half-wave oxidation potentials (Table 1.3) of **69** and **70** show a weaker electron donor ability than their anthracene counterparts. Also the second oxidation potential is elevated, reflecting the close proximity of the two heterocyclic rings. Introduction of methyl groups, to afford compounds **71** and **72**, lowers the first oxidation potential but not the second. Compounds **73** and **74** bearing methylthio groups have lower first and the second oxidation potentials. This implies that the conjugation of the methylthio groups with the parent heterocycles results in more effective charge delocalisation in the higher oxidation state than the non-conjugative methyl groups.

Only compound **70** gave a charge-transfer salt with TCNQ and this crystalline 1:1 salt showed good room temperature conductivity of 55 Scm^{-1} . The other donors in this series gave a number of conducting complexes with the stronger electron acceptors TCNQF₄ and DDQ, which rarely give conducting complexes. Unfortunately although the electron donating properties of the methylthio compounds **73** and **74** are improved, their charge-transfer complexes generally have lower conductivities than those of their parent systems. This could be attributed to steric considerations in the solid state packing.

Several highly conducting radical-cation salts ($\sigma_{\text{rt}} = 10^1 - 10^4 \text{ Scm}^{-1}$) of donors **69**, **70**, **73** and **74** have also been synthesised by electrocrystallisation.⁷⁷

Comp.	$E_{1/2}^1 / V$	$E_{1/2}^2 / V$	Comp.	$E_{1/2}^1 / V$	$E_{1/2}^2 / V$
22	0.19	0.56	24	0.21	0.58
26	0.13	0.52	27	0.15	0.53
28	0.08	0.48	29	0.1	0.48
30	0.27	0.60	31	0.36	0.75
32	---	---	33	0.35	0.71
34	0.47	0.78	35	0.32	0.73
36	0.31	0.72	37	0.20	0.63
38	0.31	0.72	39	0.30	0.68
40	0.26	0.69	31	0.26	0.68
42	0.16	0.55	43	0.94	---
44	0.77	---	45	0.43	---
50	0.56	0.97	51	0.52	0.89
52	0.46	0.94	53	0.45	0.90
54	0.31	0.73	55	0.48	0.96
56	0.46	0.87	57	0.45	0.92
58	0.68	---	59	0.57	---
60	0.32	---	61	---	---
62	---	---	63	0.60	---
65	1.15	---	66	0.88	---
67	0.53	---	69	0.65	1.02
70	0.64	1.02	71	0.59	1.00
72	0.58	0.98	73	0.58	0.91
74	0.58	0.90			

Table 1.3 Half-wave Oxidation Potentials of Donors Discussed in Section 1.4.4 (vs. Ag/AgCl)

1.4.5 Heteroarenes

Section 1.4.1 described the use of polycyclic arenes as π -electron donor components in conducting charge-transfer and radical-cation salts. Considerable effort has been directed to analogues with heteroatoms, especially sulfur replacing one (or more) of the sp^2 carbons in the polycyclic system. The resulting heteroarenes usually have lower ionisation potentials than the original hydrocarbons, and, additionally, the incorporated heteroatoms can induce strong intermolecular electronic interactions in the solid state which may improve the conductivity of their molecular complexes.

There are two different types of heteroarene which have been studied:

- i) Those which are isoelectronic with the original parent arene possessing one sp chalcogen atom for every two sp² carbon atoms replaced .
- ii) Those which replace one or more sp² carbon atoms with an equal number of sp chalcogen atoms and thus become isoelectronic with the parent arene upon the loss of one π -electron for every chalcogen atom. These heterocycles also produce one and two new aromatic sextets in one of the canonical formulæ for the cation and dication, respectively. These are known as Weitz type donors.⁷⁸

In general, pyrene (**6**) and perylene (**5**) have been used as a basis for donors of this type, as each has shown the propensity to form conducting complexes (Section 1.4.1). These two families will be discussed separately, followed by other heteroarenes.

1.4.5.1 Heteroarenes Based on Pyrene

Otsubo *et al.* have synthesised both the isomeric dithioarene compounds **75** and **76** and the monothioarene compound **77**.⁷⁹ These three compounds are all π -isoelectronic with pyrene (**6**).

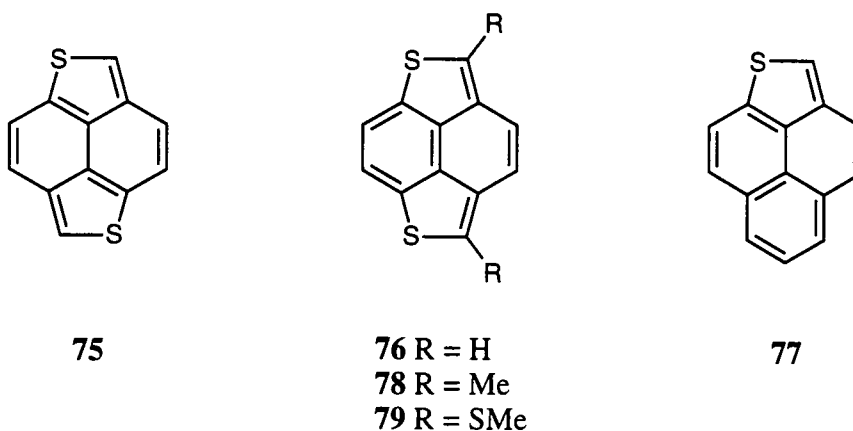

Compound **75** is more attractive than its isomer **76** as it does not exhibit a Kekulé benzene ring in its structure, and is thus expected to possess the lower oxidation potential of the two. MNDO MO calculations⁷⁹ show a higher HOMO for **75** (-7.982 eV) compared to **76** (-8.223 eV) which seems to back this prediction. Indeed, cyclic voltammetry showed one irreversible oxidation wave at +1.01 V and +0.93 V for **76** and **75**, respectively, which are both substantially lower than that shown for pyrene (+1.35 V). Isomer **75** is unstable in air and decomposes in the solid state. Compound **77** is a poorer electron donor than its relatives (+1.13 V) but is still an improvement on pyrene.

Dimethyl and dithiomethyl derivatives of compound **76** were also synthesised (**78** and **79**, respectively). These substituents block the thiophene reactive site and thus show reversible oxidation waves which are considerably lowered in potential by substituent effects (**78** $E_{1/2} = +0.84$ V, **79** $E_{1/2}^1 = +0.71$ V $E_{1/2}^2 = +0.94$ V).⁷⁹

Compound **76** forms a charge-transfer complex with DDQ which exhibits a high electrical conductivity, $\sigma_{rt} = 2.1$ Scm⁻¹. It also forms an iodine complex with a σ_{rt} value ca. two orders of magnitude higher than that for the pyrene-iodine complex (Section 1.4.1), 0.92 and 0.013 Scm⁻¹, respectively.⁷⁹

Isomer **75** and the methylthio derivative **79** form similar conducting materials with the same electron acceptors.⁷⁹

Methyl derivative **78** was electrocrystallised to form an I₃⁻ salt with the high conductivity, $\sigma_{rt} = 27$ Scm⁻¹.⁷⁹

The electron donor compounds 1,6-thiapyrene (**80**), 1,6-dioxapyrene (**88**) and a number of their derivatives have been synthesised. These compounds may each lose 2 π electrons to become isoelectronic with pyrene itself. In addition every electron loss enables each of the 7 π sulfur heterocycles to become, successively, stable 6 π aromatic systems. The CV data for **80-93** are listed on Table 1.4.

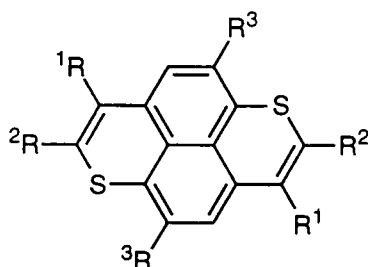

- 80** R¹ = H, R² = H, R³ = H
81 R¹ = Ph, R² = H, R³ = H
82 R¹ = H, R² = SMe, R³ = H
83 R¹ = H, R² = SeMe, R³ = H
84 R¹ = SMe, R² = H, R³ = H
85 R¹ - R² = SCH₂CH₂S, R³ = H
86 R¹ = Me, R² = H, R³ = Me

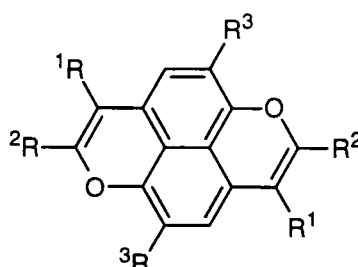

- 87** R¹ = Me, R² = H, R³ = Me
88 R¹ = H, R² = H, R³ = H
89 R¹ = Me, R² = Me, R³ = Me
90 R¹ = Et, R² = H, R³ = Me
91 R¹ = Me, R² = H, R³ = Pr
92 R¹ = Ph, R² = H, R³ = Me
93 R¹ = Ph, R² = Me, R³ = Me

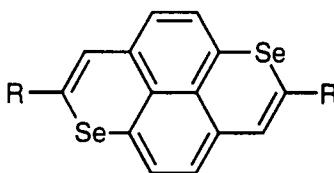

- 94** R = H
95 R = SMe
96 R = SeMe

Compound	$E_{1/2}^1 / \text{V}$	$E_{1/2}^2 / \text{V}$	Reference
80	0.36	0.75	80
81	0.36	0.73	80
82	0.34	0.64	81
83	0.37	0.64	82
84	0.40	0.82	82
85	0.48	0.83	81
86	---	---	unpublished
87	0.32	1.00	83
88	---	---	83
89	0.22	0.82	83
90	0.33	1.00	83
91	0.29	0.97	83
92	0.38	1.10	83
93	0.25	0.86	83
94	0.37	0.84	84
95	0.41	0.73	84
96	0.44	0.73	84

Table 1.4 Half-wave Oxidation Potentials of Donors **80** - **96** (vs. SCE)

1,6-Dithiapyrene (DTPY, **80**) had been synthesised as early as 1951,⁸⁵ but it was not until 1985 that Bechgaard *et al.* reported a charge-transfer salt with TCNQ.⁸⁶ This salt, consisting of regular segregated stacks of donor and acceptor, showed a room temperature conductivity of 4 Scm^{-1} , and conducting behaviour down to 4 K. The two reversible oxidation potentials for **80** (+0.36, +0.73 V) are considerably lower than those of the isoelectronic systems **75** - **77** (+1.01, +0.93 and +1.13 V, respectively) and pyrene itself (+1.35 V) which, in addition, display one, rather than two, oxidations. This illustrates the superior electron donating ability of the Weitz type donors.

Nakasuji *et al.* also synthesised the diphenyl substituted system **81** which showed almost identical oxidation potentials to the parent **80** (Table 1.4).⁸⁰

In order to increase intermolecular interactions in the solid state, and thus introduce multidimensionality, alkylthio groups were introduced. Compounds **82** - **86** were synthesised and a number of charge-transfer and radical-cation complexes formed.^{81,82,87} The most highly conducting charge-transfer salts derived from donor **82**, where the 1:1 chloranil and bromanil complexes showed metallic conductivities of $\sigma = 140$ and 230 Scm^{-1} , respectively.⁸¹ The **82** - chloranil complex crystallised in uniform, segregated stacks of donors and acceptors (Figure 1.14). Donors **84** and **85** both formed conducting radical cation salts, the best being the semiconducting **84**(PF₆)_{0.67} with $\sigma_{\text{rt}} = 43 \text{ Scm}^{-1}$.⁸²

Bechgaard *et al.* have synthesised and studied a number of 1,6-dioxapyrene **88** (originally synthesised by Buisson)⁸⁸ derivatives **87** - **93**.⁸³ Replacing sulfur heterocycles for oxygen containing systems tends to lower the oxidation potentials of the system. Radical-cation salts of **87** with PF₆ and BF₄ have been synthesised and they have σ_{r} values ca. 30 Scm⁻¹.⁸⁹

Three 1,6-diselenapyrenes have also been synthesised (**94** - **96**) and initial complexation studies undertaken;⁸⁴ the effect of introducing selenium seems to be a lowering of the oxidation potentials (Table 1.4).

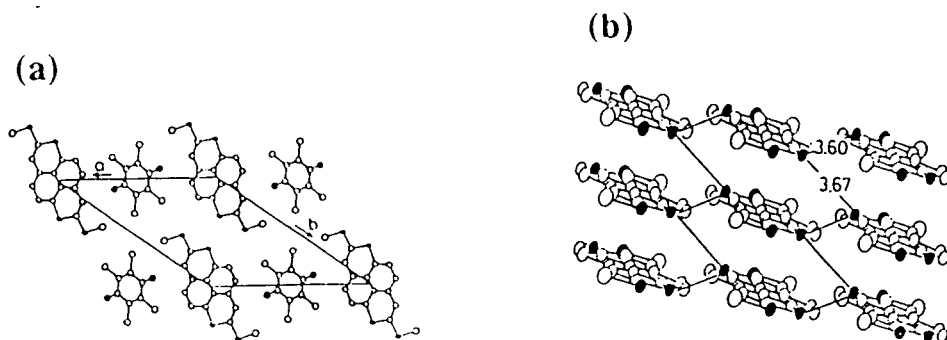
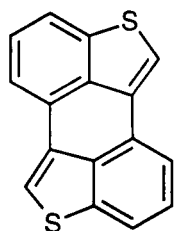

Figure 1.14 Crystal structure⁸¹ of **82** - chloranil complex, (a) view along the *c* axis and (b) view of sheet-like network of the donors

1.4.5.2 Heteroarenes Based on Perylene

Wudl *et al.* synthesised compound **97**⁹⁰ and Otsubo *et al.* have synthesised compounds **98** - **100**.⁷⁹ All are isoelectronic with perylene (**5**).



97

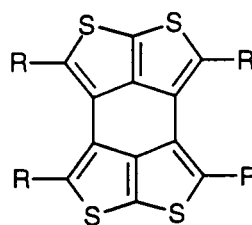

98 R = H
99 R = Me
100 R = SMe

Cyclic voltammetry⁹⁰ of heteroarene **97** revealed an oxidation wave at +1.03 V vs. SCE and thus it is only slightly easier to oxidise than perylene itself (+ 1.06 V vs.

SCE). This compound also forms iodine complexes of varying stoichiometry which show a very similar conductivity ($\sigma_{rt} = 20 - 2.5 \times 10^{-2} \text{ Scm}^{-1}$) to the perylene - iodine complex discussed in Section 1.4.1 ($12.5 \times 10^{-2} \text{ Scm}^{-1}$).¹⁸ In addition it was found that the heteroarene complex lost iodine at room temperature and pressure to yield **97**, similar to the perylene complex.

Compounds **98** - **100** have four peripheral sulfur heteroatoms which were expected to show strong intermolecular contacts in the solid state. The basic system **98** showed a quasi-reversible oxidation wave with a potential of +1.01 V which is remarkably similar to that of compound **97** and perylene. In addition, **98** also formed an iodine complex with a conductivity similar to the other two complexes discussed above ($\sigma_{rt} = 11 \times 10^{-2} \text{ Scm}^{-1}$). Compounds **99** and **100** have peripheral methyl and thiomethyl groups, respectively, and were expected to have increased donor ability and stability. They showed oxidation waves at +0.93 and +0.88 V respectively, which are indeed lower than **98**. They both formed charge-transfer complexes with the strong acceptors, DDQ and TCNQF₄, but their conductivities were low.

Compounds **101** - **104**, synthesised by Nakasuji *et al.*, become isoelectronic with perylene upon the loss of two electrons.⁸⁷ The oxidation potentials for these compounds are listed in Table 1.5.

3,10-Dithiaperylene (**101**) and its 2,11-diphenyl derivative (**102**) were synthesised and complexes generated.⁸⁰ The DDQ charge-transfer salt **102** - DDQ_{0.75} showed a high room temperature of 0.5 Scm^{-1} , which is unusual as it consists of neither a TTF-type donor nor TCNQ-type acceptor.

3,9-Dithiaperylene (**103**) forms an iodide complex with a good conductivity value of $\sigma_{rt} = 7 \text{ Scm}^{-1}$.⁹¹ 1,7-Dithiaperylene (**104**) formed charge-transfer and radical-cation salts, **104**(NO₃)_x having a single crystal room temperature conductivity of $\sigma = 1.4 \text{ Scm}^{-1}$.⁹²

Table 1.5 shows that the three donors **103**, **104** and **101**, in this order, show increasing oxidation potentials which indicate that the energies of the HOMO's for the three donors are lowering in that order. This observation has been attributed to the structural considerations.⁸⁷

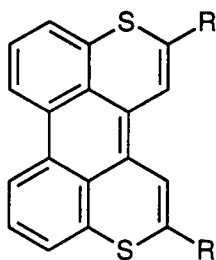

101 R = H
102 R = Ph

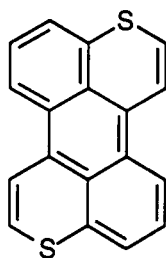

103

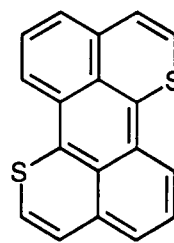

104

Donor	E_1^{ox} / V	E_2^{ox} / V	Reference
101	0.42	0.76	80
102	0.58	0.96	80
103	0.30	0.66	91
104	0.39	0.82	92

Table 1.5 Half-wave Oxidation Potentials of Donors **101** - **104** (vs. SCE)

1.4.5.3 Heteroarenes Based on Other Systems

A number of other heteroaromatic compounds have been investigated as electron donors in charge-transfer and radical-cation salts. Below is a review of some of the more interesting systems

Fischer *et al.* investigated the heteroarenes **105-110** which are isoelectronic with dibenzo[*g,p*]chrysene.⁹³ All these compounds showed an irreversible redox wave of around +1.1 V; the irreversibility was attributed to chemical reactions at the C(2) + C(3) positions in the thiophene moieties of the radical cations. Electrochemical data for dibenzo[*g,p*]chrysene was not obtainable. Only one complex was studied, the 1:1 charge-transfer complex **105** - TCNQ. The single crystal X-ray structure (Figure 1.15) revealed columns of alternating donor and acceptor moieties with an estimated degree of charge transfer of zero, which explain the insulating nature of this complex.

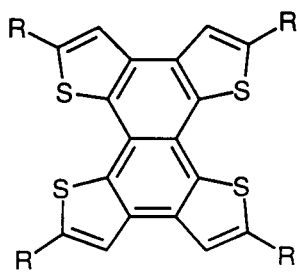

105 R = H
106 R = Me
107 R = Bt

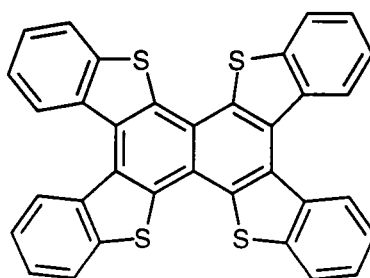

108

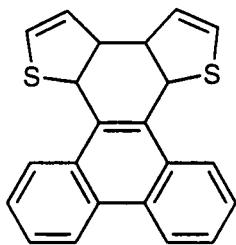

109

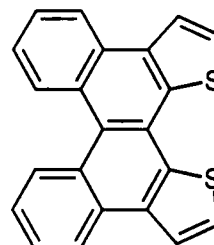

110

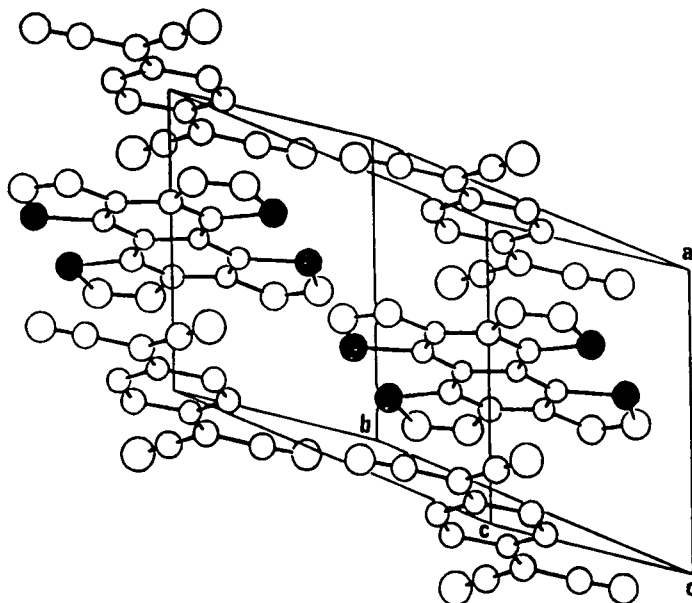
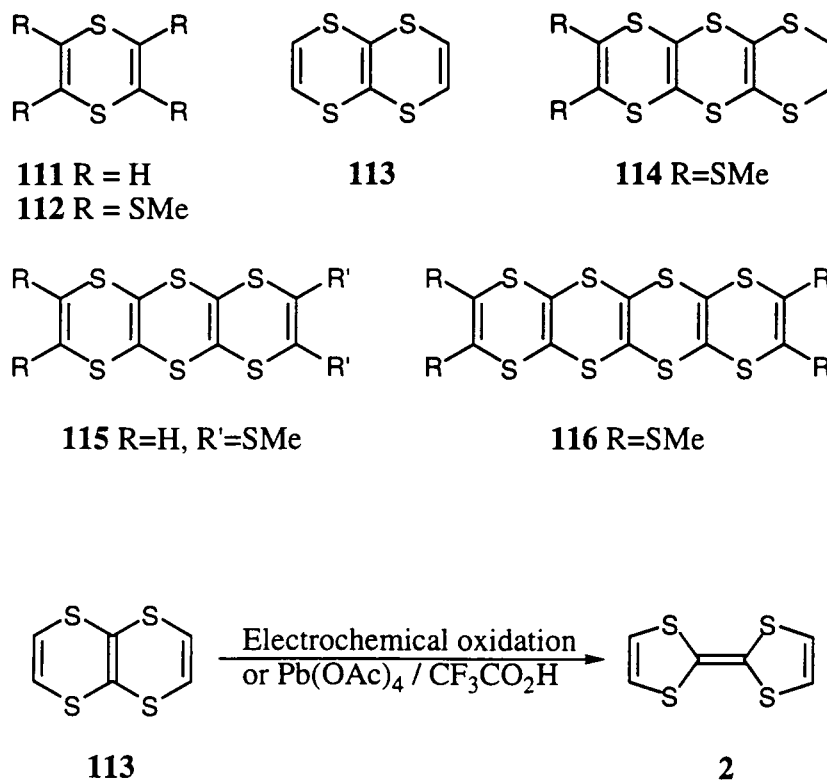

Figure 1.15 Crystal structure⁹³ of **105** - TCNQ, sulfur atoms are darkened

Quite a few electron donor compounds have been synthesised which incorporate 1,4-dithiin (**111**) ring systems.

The bis- fused 1,4-dithiin compound 1,4,5,8-tetrathiatetralin (**113**) is an isomer of TTF (**2**) and differs structurally from the latter only in the arrangement of the two ethyne bridges. It was first synthesised by Mizuno *et al.*⁹⁴ and then by a more efficient route by Varma *et al.* who also obtained an X-ray crystal structure.⁹⁵ Unfortunately this compound is a poorer electron donor ($E_1 = +0.97\text{V}$ reversible, $E_2 = +1.41\text{V}$ irreversible, vs. Ag/AgCl)⁹⁶ than TTF and has not formed interesting salts. It was found however that the dicationic state of compound **113** rearranges into TTF (Scheme 1.6).⁹⁶ Okada *et al.* have synthesised the tellurium derivative of **113**, 1,4,5,8-tetratelluranaphthalene and found no rearrangement for this system.⁹⁷ It has also been found that compound **113** could be converted into TTF in 70% yield via reaction with lithium diisopropylamide,⁹⁸ this reaction has recently been utilised in the multi-gram synthesis of TTF and BEDT-TTF (**4**).⁹⁹

Sugimoto *et al.* have synthesised a number of systems based around fused 1,4-dithiin rings (**112**, **114** - **116**) which incorporate alkylthio substituents.⁹⁶ All these compounds show a reversible one electron oxidation at *ca.* +1.0V and an irreversible one electron oxidation at *ca.* +1.2V; they show no rearrangement of the dication.



Scheme 1.6

1.4.6 Conclusions

From this survey of the different π -electron donor families it is seen that although research has predominantly focused on materials based upon the TTF system, other compounds may be just, if not more, interesting. The peri-dichalcogen bridged polycyclic arenes in particular prove to be very versatile, with many compounds having stronger electron donor properties than TTF, and they form a large number of highly conducting radical-cation and charge-transfer salts. The heteroarenes also show a range of attractive features and have been utilised in the synthesis of complexes with interesting physical properties. There is much scope for future development of all these families, and further research should result in the synthesis of novel conducting and perhaps even superconducting materials.

Chapter Two

Acenaphtho[1,2-b][1,4]-dithiin and its Functionalisation

2.1 ACENAPHTHO[1,2-*b*][1,4]-DITHIIN

2.1.1 INTRODUCTION

In 1994, Tani *et al.*¹⁰⁰ reported the synthesis of the new thia-arene π -electron donor acenaphtho[1,2-*b*][1,4]dithiin **117** (which has also been referred to as 7,10-dithiafluoranthene). This new compound displays a reversible first oxidation wave ($E^{1/2} = +0.68\text{V}$ versus SCE) and forms both charge-transfer and cation-radical salts.^{100,101}

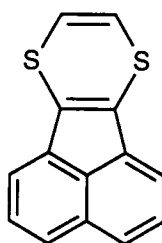

117

The crystal structures of neutral donor **117** and the radical cation salts of **117** with both PF_6^- and BF_4^- counter anions, grown by electrocrystallisation techniques, have been determined.¹⁰¹ Neutral **117** is bent through the peripheral two sulfur atoms by 36.51° , however this molecule becomes planar when a component of certain radical cation salts. The salt $(\mathbf{117})_2\text{PF}_6$ possess a columnar stack of donor molecules with a small degree of alternate intermolecular separation. The vinylenedithio moieties are partially overlapped in this column with $\text{S}\cdots\text{S}$ contacts (3.509 \AA and 3.516 \AA) which are shorter than the sum of the van der Waals radii (3.7 \AA), there are also similar $\text{S}\cdots\text{S}$ contacts between the columns. Thus $\text{S}\cdots\text{S}$ networks exist in two directions, suggesting the possibility of a quasi two dimensional conduction system parallel to this plane. Indeed it has been found that there is high electrical conductivity ($\sigma = 5.0 \text{ Scm}^{-1}$ at room temperature) along this plane.

In the $(\mathbf{117})\text{BF}_4$ salt, there are also stacks of donor but only one short $\text{S}\cdots\text{S}$ contact is observed between the vinylenedithio groups, along the columnar stacking direction, and no $\text{S}\cdots\text{S}$ networks. The low conductivity of $(\mathbf{117})\text{BF}_4$ ($\sigma < 10^{-8} \text{ Scm}^{-1}$ at rt) can be rationalised on the basis of molecular packing.

Compound **117** formed not only radical cation salts with inorganic anions, but also charge transfer salts with iodine and 7,7,8,8-tetracyanoquinodimethane (TCNQ).¹⁰¹ Crystallographic X-ray diffraction analysis of the salt (**117**)TCNQ showed mixed stacking of donor and acceptor moieties, which explains (Section 1.3) the very low conductivity of the crystal ($\sigma < 10^{-8} \text{ Scm}^{-1}$ at rt).

Two iodine salts of different stoichiometries were prepared, their conductivities were moderate ($\sigma = 4.1 \times 10^{-3} \text{ Scm}^{-1}$ for (**117**)_{4,6}, $\sigma = 3.1 \times 10^{-4} \text{ Scm}^{-1}$ for (**117**)_{3,5}). A single crystal X-ray analysis of these salts was not possible as they were isolated as black powders.

Thus, it has been demonstrated that compound **117** forms various, stable, charge transfer and radical cation salts, several of which showed significant, room temperature, electrical conductivity.

2.1.2 SYNTHESIS

The initial aim of our investigation into acenaphtho[1,2-*b*][1,4]-dithiins was to substitute the parent compound **117** with other functionality. This would generate a range of compounds, based on **117**, which could be investigated as π -electron donors in charge-transfer and radical cation salts. This technique has been used extensively, and with great success using the TTF π -electron donor as the basic framework.

Thia-arene **117** was synthesised using the procedure outlined below (Scheme 2.1),¹⁰² which involves significant modifications of the original method.¹⁰⁰ Ketone **119** was synthesised from commercially available acenaphthen-1-ol **118** by chromic acid oxidation, in good yield. In 1980 Ong described a method for thioactetalization and ketalization of carbonyl groups, using aluminium trichloride and both mono- and dithiols.¹⁰³ In our hands, all attempts to perform the synthesis of **120** using an aluminium trichloride mediated dithioketalisation of **119** with ethane dithiol, as reported by Tani *et al*¹⁰⁰, were unsatisfactory. Instead, we found that this conversion was readily accomplished by the reaction of acenaphthene-1-one **119**, with ethane-1,2-dithiol in the presence of a catalytic amount of toluene-*p*-sulfonic acid in refluxing benzene, with azeotropic removal of the residual water *via* a Dean-Stark apparatus. Dithioketal **120** was isolated from this reaction but not purified. Instead it was immediately treated with tellurium tetrachloride in dichloromethane¹⁰⁴ to furnish the dihydroacenaphtho-1,2-*b*][1,4]dithiin derivative **121** (45% overall yield from **119**) which proved to be spectroscopically identical to that reported by Tani *et al*.¹⁰⁰ Dehydrogenation of **121** was achieved using freshly recrystallised 2,3-dichloro-5,6-dicyano-1,4-benzoquinone

(DDQ) in anhydrous 1,4-dioxane at 100°C, to afford **117** in 28% yield. Attempts to perform this transformation at high temperatures using either sulfur or selenium as dehydrogenation reagents proved unsuccessful.

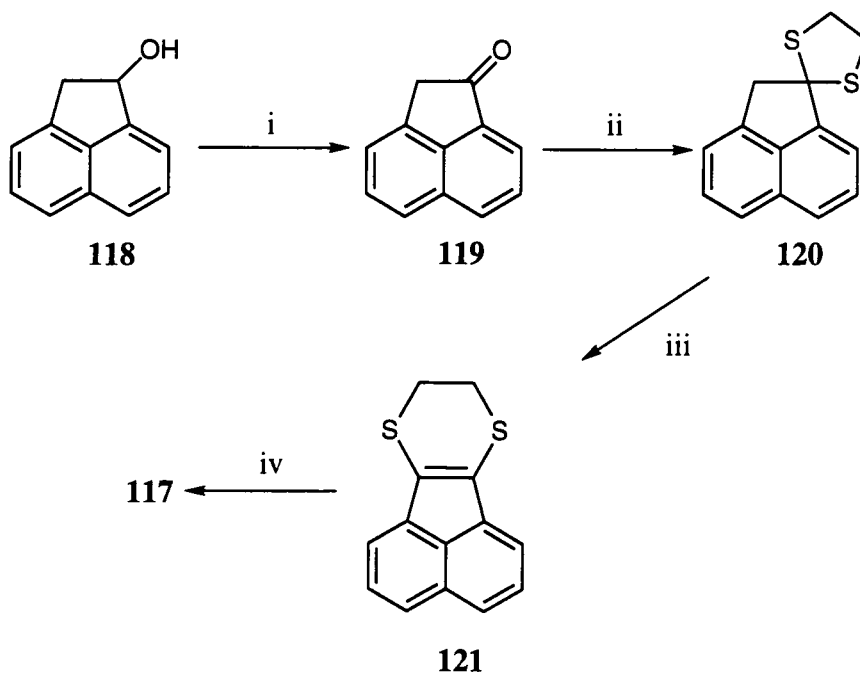

Scheme 2.1 Reagents and conditions: i, Chromic acid $\text{Et}_2\text{O}/\text{CH}_2\text{Cl}_2$, 82%; ii, $(\text{CH}_2\text{SH})_2$, PhH, *p*-TsOH (cat.), reflux, 15h; iii, TeCl_4 , CH_2Cl_2 , 45% (based on **119**); iv, DDQ, 1,4-dioxane, 28%

The conversion of dithioketal **120** into dihydro-dithiin **121** is an interesting oxidative ring expansion which was first reported by Tani *et al*¹⁰⁴ in 1990. On treatment with tellurium tetrachloride in dichloromethane at room temperature, 1,3-dithiolanes and 1,3-oxathiolanes afford dihydro-1,4-dithiin and dihydro-1,4-oxathiin derivatives respectively, in moderate to good yields. The postulated mechanism¹⁰⁴ of this reaction is shown in Scheme 2.2. A survey of the literature indicates that there are several inferior precedents for such a conversion. Treatment of 1,3-dithiolanes with *N*-chlorocarbamates¹⁰⁵ or phenylselenenyl chloride¹⁰⁶ afforded dihydro-1,4-dithiins. In the first case ring expansion was accompanied by chlorination and yields were moderate. In the latter case chromatographic purification was needed to remove diphenyl diselenide. In Scheme 2.2 the byproduct is tellurium dichloride which disproportionates to tellurium tetrachloride and elemental grey tellurium which may be simply filtered from the reaction.

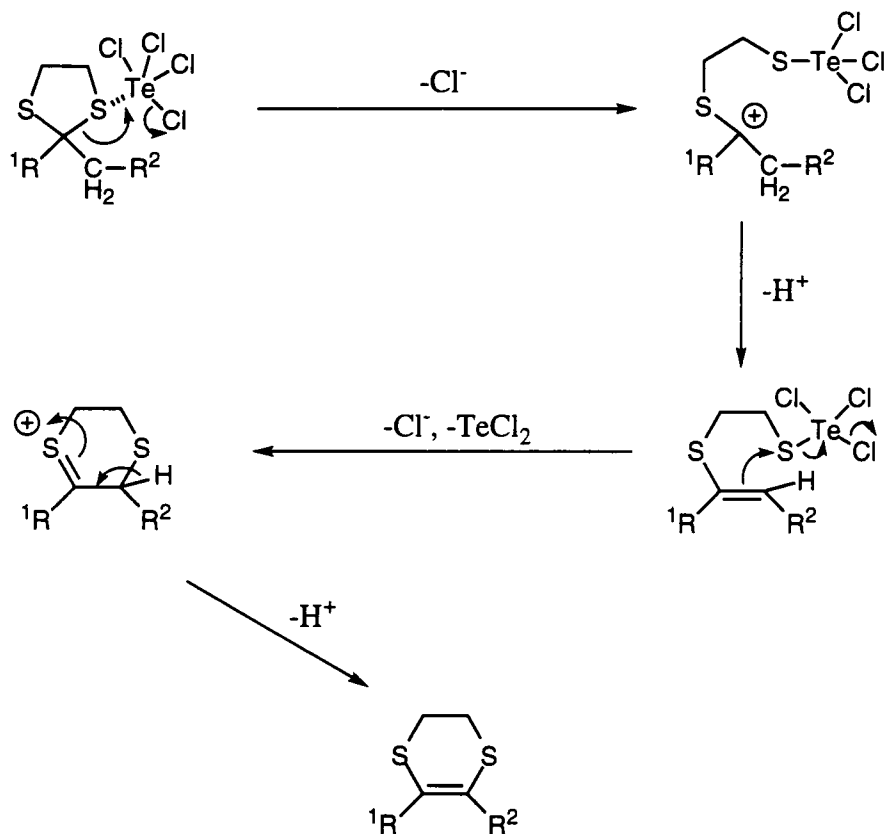

Scheme 2.2

Although this method is satisfactory, we devised an alternative and higher yielding synthesis of **121** based on a ring expansion serendipitously discovered by Chang *et al.*¹⁰⁷ In this work photolysis of the diazo ethylene acetal **122** gave the 1,4-dioxin **124** presumably *via* oxygen migration within the carbene intermediate **123** (Scheme 2.3).

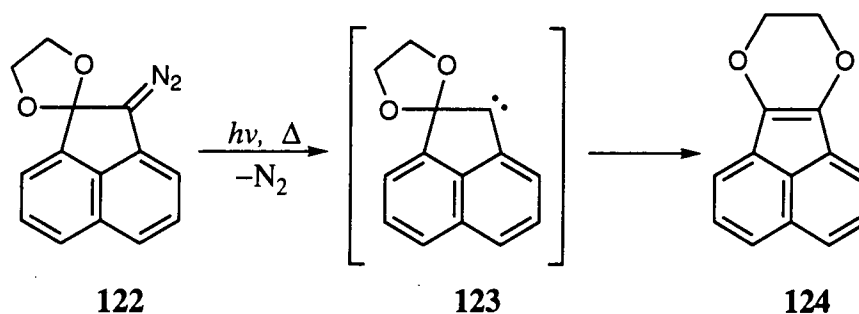

Scheme 2.3

We sought to apply this ring expansion to the synthesis of a dihydro-dithiin (Scheme 2.4).¹⁰² Commercial acenaphthenequinone **125** was readily converted into dithioketal **126** (75% yield) by refluxing it in toluene with one equivalent of ethane-1,2-dithiol and a small amount of toluene-*p*-sulfonic acid with azeotropic removal of the residual water. Compound **126** was reacted with hydrazine hydrate in methanol to afford the hydrazone derivative **127** in 55% yield. This was then treated with activated manganese dioxide in diethyl ether, (to which a small amount of saturated aqueous potassium hydroxide had been added), to give a solution containing the unstable diazo intermediate **128**. This pale purple solution rapidly changed to a bright red solution of dihydro-dithiin **121** on the addition of a small amount of hydrochloric acid and manual agitation (71% yield based on **127**). Presumably this transformation was due to the decomposition of the diazo compound **128** to a carbene intermediate which rearranges to the ring expanded compound **121**. The DDQ mediated dehydrogenation of compound **121** to compound **117** was then performed as per Scheme 2.1.

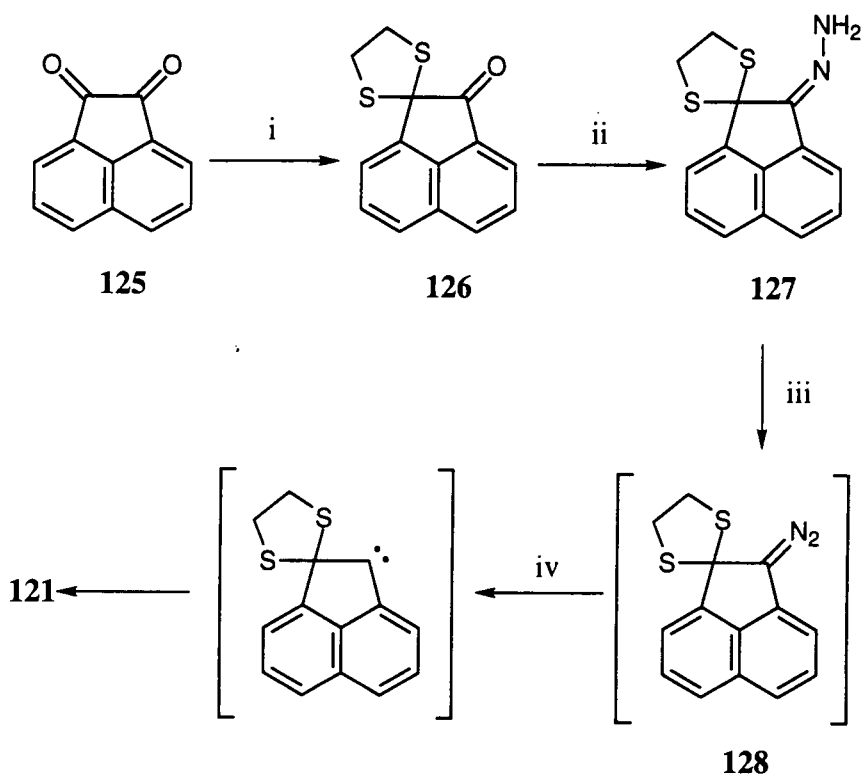

Scheme 2.4 Reagents and conditions: i, $(\text{CH}_2\text{SH})_2$, PhH, *p*-TsOH, heat, 73%; ii, H_2NNH_2 , MeOH, heat, 55%; iii, MnO_2 , Et_2O , KOH ; iv, HCl , 71% (based on **127**)

To our knowledge, this ring expansion procedure has never before been applied as a purposeful synthetic step. It proceeds in good yield and is easy to apply. It may be

interesting to investigate its application as a general synthetic procedure for 1,4-dihydrodithiin generation.

2.2 FUNCTIONALISATION OF **117**

2.2.1 INTRODUCTION

Initially, two complementary methodologies to synthesise derivatised systems based on basic framework **117** were envisaged. These were;

(i) Functionalisation of the 8 and / or 9 positions (*viz.* the peripheral alkene carbons) of **117**, *via* a lithiation-based protocol and the Vilsmeier formylation reaction;

(ii) The introduction of functionality early in the reaction sequence outlined in Scheme 2.1 and 2.4, by the use of substituted dithiols in step i.

2.2.2 LITHIATION AND SUBSTITUTION

In the first approach we sought to modify the basic skeleton of **117** by lithiation at the 8 and / or 9 positions, followed by quenching the anion(s) with electrophiles, as outlined in Scheme 2.5. Such an approach has been successfully applied to the synthesis of many functionalised tetrathiafulvalene (TTF) derivatives.¹⁰⁸ It was hoped that the known propensity of the parent 1,4-dithiine to ring-open upon lithiation,¹⁰⁹ would be suppressed by the presence of a large fused aromatic moiety within system **117**.

The formation of the mono-lithiated derivative **129** was therefore attempted using both lithium diisopropylamide (LDA) or BuLi as base, both at -78°C and at ambient temperature.¹⁰² Quenching these reactions with either methyl iodide or ethyl chloroformate did not however lead to the formation of the mono - functionalised systems **130** but, instead led to the recovery of starting material **117** in high yield. The use of two equivalents of ⁿBuLi in ether at room temperature did lead to a distinct colour change from the purple of the starting material to a deep red colour but, quenching these reactions did not lead to the mono - derivative **130** nor to the disubstituted analogues **131**.

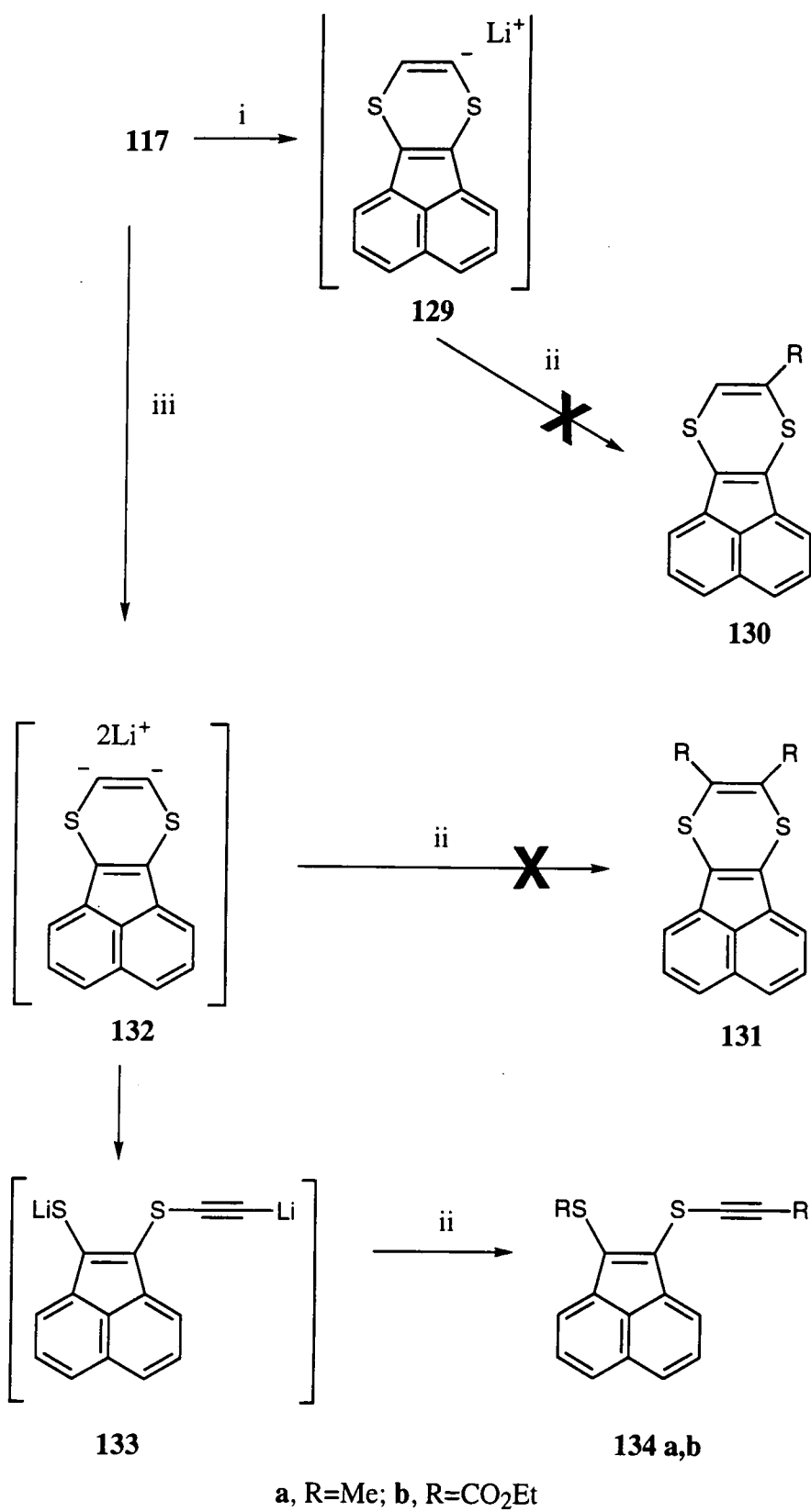

Scheme 2.5 Reagents and conditions: i, n-BuLi (1 equiv.) -78°C, Et₂O; ii, RX; iii, n-BuLi (2 equiv.), Et₂O, 20°C.

The only products isolated from these reactions were the substituted acetylenic derivatives **134 a,b** which were presumably formed by ring-opening of the initially-formed dianionic species **132** to afford dilithio intermediate **133** which was subsequently trapped by the electrophile (Scheme 2.5). Acetylenic derivatives **134 a,b** were clearly identified by ^1H and ^{13}C NMR spectroscopy and by the presence of an acetylene peak in the IR spectrum. Both derivatives **134 a,b** decomposed at room temperature over 1-2 days, and all attempts to purify them for further structural determination by CHN analysis and/or high resolution mass spectrometry proved futile, with only the diester **134 b** giving a satisfactory parent ion in the mass spectrum.

The failure of the lithiation protocol to produce a viable route to substituted derivatives of **117** is indicative of the propensity of the 1,4-dithiin dianion system to undergo irreversible ring opening (Scheme 2.6). The fact that the dianion of **117** does not ring open below 0°C , demonstrates that it is significantly more stable than the dianion formed from the parent 1,4-dithiin, which opens spontaneously above -30°C .¹⁰⁹

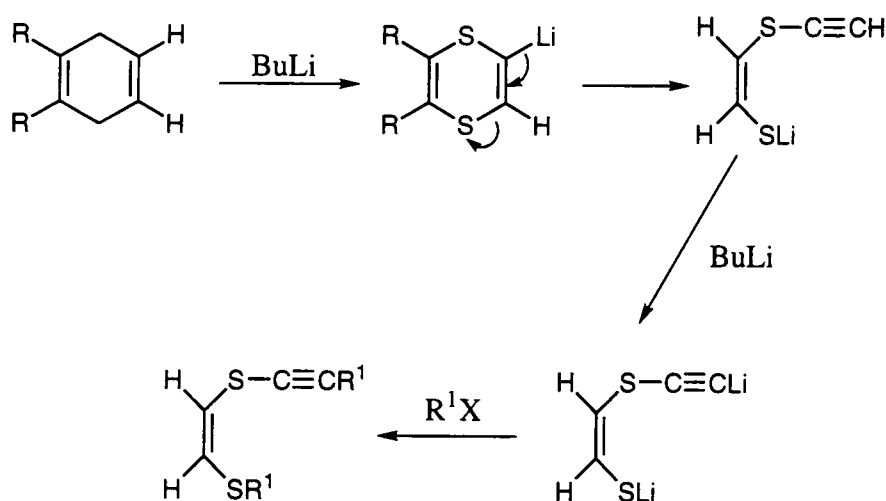

Scheme 2.6

The second complimentary approach to the functionalisation of the parent system **117** was to attempt to introduce functionality *via* the Vilsmeier reaction.

The Vilsmeier reaction is a common method for the formylation of aromatic hydrocarbons and heterocycles.¹¹⁰ In 1953 Parham *et al.* reported the formylation of benzo-1,4-dithiin using this methodology,¹¹¹ although the parent 1,4-dithiin gives no substitution products, it instead undergoes polymerisation in the presence of Lewis acids.¹¹² The introduction of a formyl group to acenaphtho[1,2-*b*][1,4]-dithiin, **117**, would be advantageous in that it would give a reactive 'handle' through which further functionality could be introduced *via* such procedures as the Wittig reaction. However, reaction of **117**¹⁰² with a mixture of phosphorus oxychloride and *N*-methylformanilide

failed under a range of conditions, as did the variation using dimethyl formamide (DMF) and oxalyl chloride as the formylating reagents.

2.2.3 THE USE OF OTHER DITHIOLS IN THE SYNTHESIS OF DERIVATIVES OF **117**

After the failure of direct substitution methods on system **117**, the incorporation of secondary functionality *via* the substitution of different dithiols for ethane dithiol in Scheme 2.1 was addressed. Two new targets were envisaged, *viz* compounds **137** and **141**¹⁰² incorporating either a benzo- or thienyl- fused ring. These particular substituents were chosen for the following reasons;

i) An aromatic system fused to the dithiin system may increase the extent of π - π interactions in the solid state and so help to encourage close stacking and interstack interactions between donor moieties, which may reduce Peierls distortion (Section 1.3.3);¹¹³

ii) The presence of a thienyl unit allows the possibility of additional intermolecular S---S interactions as well as polymerisation of the system by chemical¹¹⁴ or electrochemical methods¹¹⁵ which, in turn, may lead to 1,4-dithiin substituted conducting polymers.

The synthesis of the benzo-acenaphthene dithiin donor **137** is outlined in Scheme 2.7. This straightforward route proceeded from the commercially available 1,2-benzenedithiol **135** and ketone **119**. Dithioketal **136** was isolated in sufficient purity to be treated directly with tellurium tetrachloride in dichloromethane, affording compound **137**, albeit in only 13% isolated yield. An analogous procedure enabled the four - step synthesis of the thienyl analogue **141** (Scheme 2.8). The thiophene-3,4-dithiol **139** required for this route was obtained by lithium - bromine exchange on 3,4-dibromothiophene **138**, followed by sulfur insertion.¹¹⁶ We chose not to purify either dithiol **139** or dithioketal **140**, since the reaction mixtures were extremely malodorous. Target molecule **141** was obtained as a purple solid in 19% overall yield based on 3,4-dibromothiophene **138**.

In an attempt to introduce selenium atoms into the framework of these donor systems, the synthesis of **144** was proposed *via* benzene-1,2-diselenol **143**. Since this is not commercially available, we attempted to generate it *in situ* from 1,2-dibromobenzene **142** using the protocol previously employed to produce **139**¹¹⁶ (Scheme 2.9).

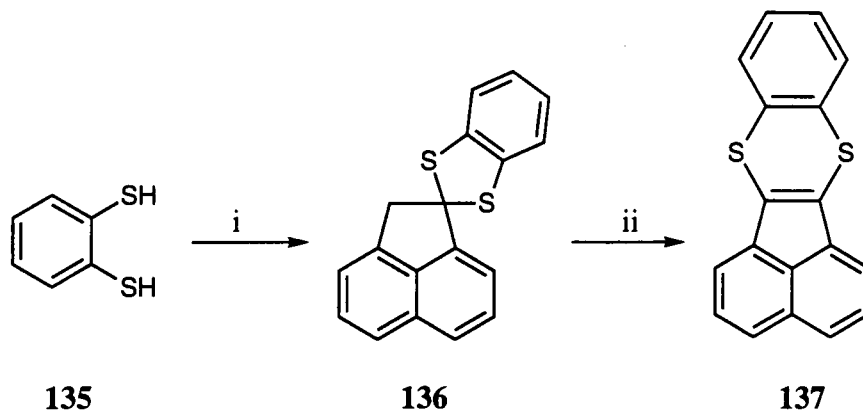

Scheme 2.7 Reagents and conditions: i, **119**, PhH, *p*-TsOH, heat, ca. 98%; ii, TeCl₄, dichloromethane, 13%

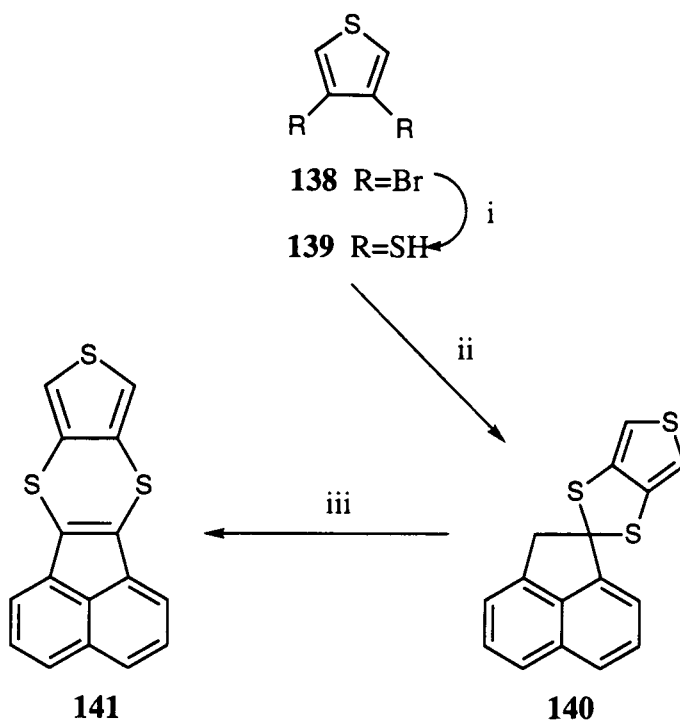

Scheme 2.8 Reagents and conditions: i, 2 x ^tBuLi, S₈, -78°C, Et₂O; ii, **119**, PhH, *p*-TsOH, heat; iii, TeCl₄, dichloromethane, 19% (based on **138**)

Only one product, a red crystalline solid, was isolated from the reaction sequence, and spectroscopic and analytical data clearly showed that it was not the expected benzodiselenine derivative **144**. Instead, the product proved to be dibenzo[*c,e*][1,2]diselenine **145**, which had been synthesised previously by different routes.¹¹⁷ In the present case, **145** was presumably formed during the attempted preparation of **144** from 1,2-dibromobenzene; indeed, aromatic diselenides have

recently been prepared by an analogous lithiation and selenium insertion sequence from the corresponding aryl bromides, followed by oxidative work-up.¹¹⁸

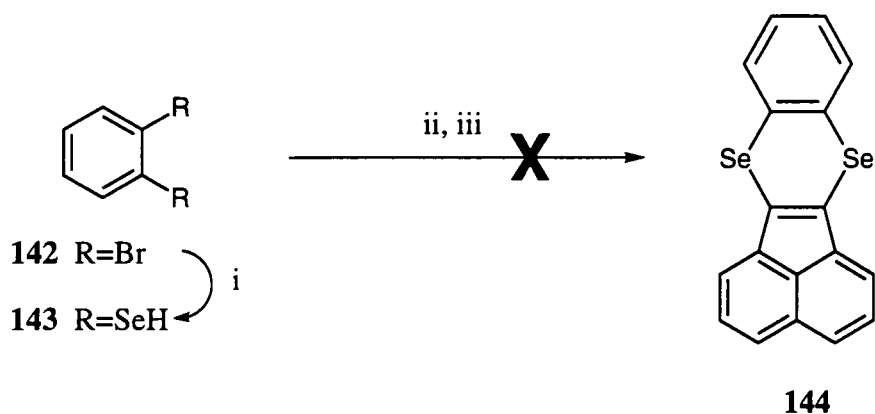

Scheme 2.9 Reagents and conditions: i, 2 x Bu^tLi, 2Se, -78°C, Et₂O, then HCl; ii, **139**, PhH, *p*-TsOH, heat; iii, TeCl₄, dichloromethane

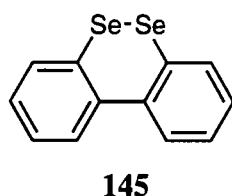

We also attempted to generate 4,5-dimethoxybenzene-2,3-dithiol **147** from 2,3-dibromo-4,5-dimethoxybenzene **146** by lithiation and sulphur insertion (Scheme 2.10). It was hoped that we could employ this dithiol in the previously described synthesis (Scheme 2.1) to generate a donor **149** analogous to **137** but incorporating methoxy substituents. Instead we isolated a yellow crystalline solid whose analytical data clearly indicated it to have the structure of compound **148a**.

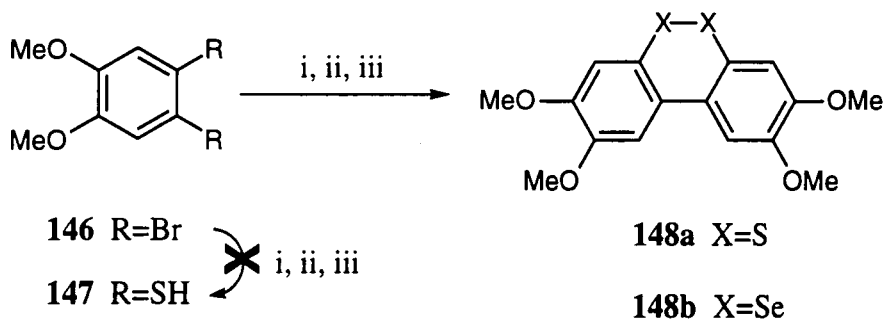

Scheme 2.10 Reagents and conditions: i 2 x ⁿ-BuLi, Et₂O, -78°C; ii S₈; iii HCl(aq)

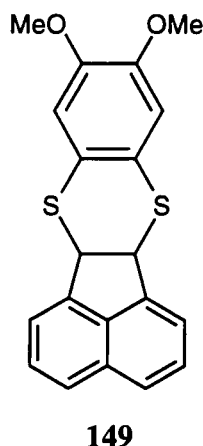

Compound **148a** is a known material which has itself been used as an electron donor in an electrically conducting iodine complex.¹¹⁹ The original synthesis involved the action of disulphur dichloride on 3,3',4,4'-tetramethoxybiphenyl to give 1,2-dithiin **148a** (Scheme 2.11), but the synthesis of the selenium analogue is much closer in style to that in Scheme 2.10.^{119a} Dibromo- compound **146** was lithiated by *t*-butyl lithium and reacted with elemental selenium, the selenium insertion product being finally oxidised by air to give the product, the diselenide **148b**. Our synthesis of **148a** probably occurs in a similar fashion, with oxidation by air occurring during workup.

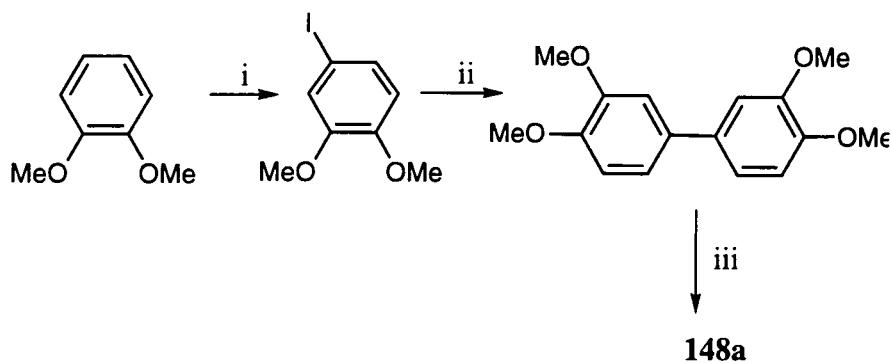

Scheme 2.11^{119a} Reagents . i ICl, ii Cu, iii S₂Cl₂.

Another interesting modification of the original donor **117**, is to substitute one of the sulphur atoms in the 1,4-dithiin ring system for an oxygen atom to create the 1,4-oxathiin **150**. We accomplished this by utilising 2-mercaptoethanol in the diazo mediated ring expansion synthesis previously described in Scheme 2.12.

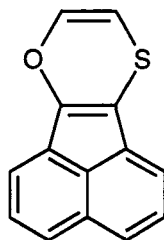
**150**

To accomplish this, 2-mercaptoethanol was refluxed in benzene with acenaphthenequinone **125**, with azeotropic removal of residual water, to give the oxothioketal **151** in 85% yield. Compound **151** was reacted with hydrazine hydrate in methanol to afford the hydrazone derivative **152** in 68% yield, which was then treated with activated manganese dioxide to give a solution of the unstable diazo compound **153**. This solution rapidly converted to a bright red solution of dihydro-1,4-oxathiin **154** on the addition of a small amount of aqueous acid in 72% yield based on **152**.

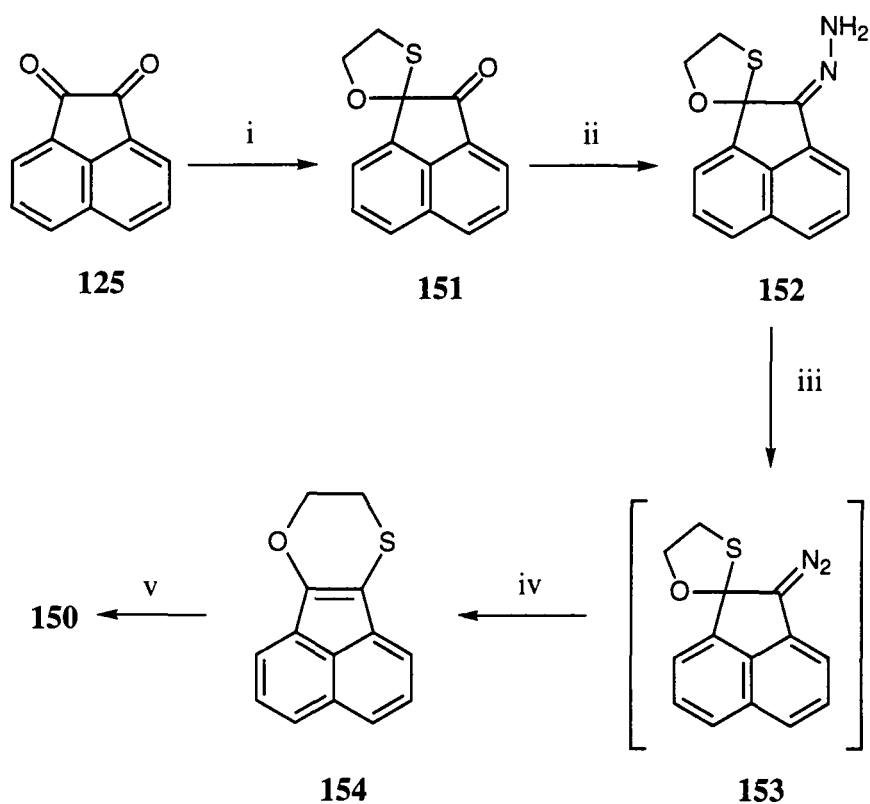

Scheme 2.12 Reagents and conditions: i, HOCH₂CH₂SH, PhH, heat, 85%; ii, H₂NNH₂, MeOH, heat, 68%; iii, MnO₂, KOH, EtOH, 20°C; iv, HCl, 72% based on **152**; v, DDQ, PhH, reflux, 6%.

This compound was then treated with DDQ in refluxing benzene to give the target compound **150**, albeit in low yield (6%). Despite the poor yield of the final step, the ease and good yields of the previous steps make compound **150** available in reasonable quantities (250mg). Compound **150** is a highly soluble powder in all common solvents, from methanol to hexane. This fact contributed to the failure to obtain single crystals of **150** suitable for an X-ray structure determination.

2.2.3.1 SINGLE-CRYSTAL X-RAY ANALYSIS OF **137**

Benzo-fused donor **137** was analysed by single-crystal X-ray diffraction.¹⁰² The molecular structure of **137** (Figure 2.1a) shows that the molecule is folded along the S(1)...S(2) vector by 48°, with both parts of the molecule being planar to within ± 0.04 Å. This conformation is similar to that of 1,4,2-dithiazine derivatives in which the heterocycle folds by 48—50°,¹²⁰ but is in sharp contrast to the conformation of bis(acenaphtho)[1,2-*b*:1,2-*e*]-1,4-dithiine **155**,¹²¹ which, remarkably for an uncharged 1,4-dithiine derivative, is planar. The crystal packing of **137** (Figure 2.1b and c) is dominated by stacks of molecules (related via the glide plane *c*), with their acenaphthene moieties parallel to within 1.3° and with interplanar separations of *ca.* 3.54 Å.

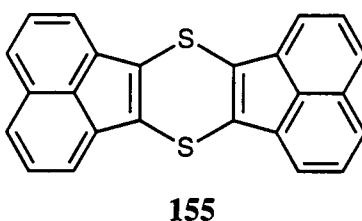

2.3 ELECTROCHEMICAL STUDIES AND CHARGE TRANSFER COMPLEXES

2.3.1 ELECTROCHEMICAL STUDIES

The electrochemical redox properties of the new donors **137**, **141** and **150** have been studied by cyclic voltammetry in acetonitrile solution. The cyclic voltammograms of all three compounds showed a reversible one-electron oxidation wave to form the cation radical species, **137**⁺, **141**⁺ and **150**⁺, respectively. Compounds **137** and **141**

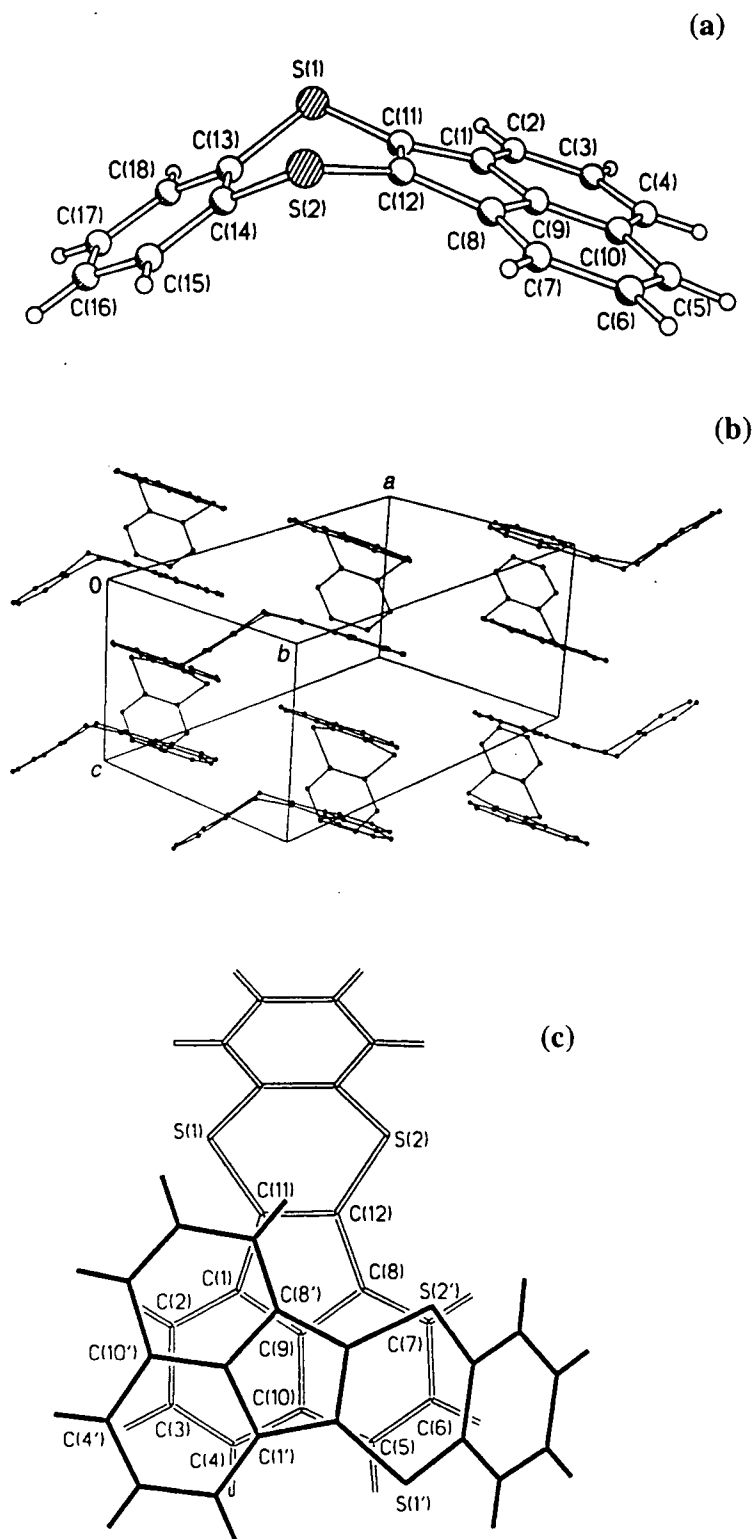
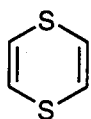
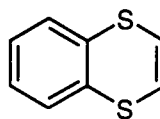

Figure 2.1 Crystal structure of compound 137

have an identical oxidation potential ($E_1^{1/2} = +0.83\text{V}$) which is inconsistent with the known trend that thienyl compounds usually have lower ionisation potentials than the analogous aromatic hydrocarbons.¹²² Compound **150** shows a lower oxidation potential ($E_1^{1/2} = +0.72\text{V}$). For all three compounds an irreversible second oxidation wave was observed at $E_2^{1/2} = ca. 1.5\text{V}$. Thus, **137**, **141** and **150**, are slightly harder to oxidise than the parent system **117** ($E_1^{1/2} = +0.68\text{V}$).¹⁰⁰ The attempted electropolymerisation of compound **141** did not afford any discernible deposition of material on a platinum electrode (dichloromethane, 20°C, 10-12 μA). However, this compound proved to be stable at high constant current (unlike many other organic donor molecules) presumably due to the high second oxidation potential of this system.

The cyclic voltammogram of the parent 1,4-dithiin **156** exhibits two one-electron oxidation waves ($E_1^{1/2} = +0.69$ and $E_2^{1/2} = +1.16$ V vs. SCE);¹²³ this first oxidation potential is very similar to that of the acenaphthene fused 1,4-dithiin system **117** ($E_1^{1/2} = +0.68\text{V}$). Fusion of a benzene ring to 1,4-dithiin anodically shifts the cyclic voltammogram (*cf.* compound **157**: $E_1^{1/2} = +0.80$ and $E_2^{1/2} = +1.34$ V vs. SCE).¹²³ These oxidation potentials are very similar to those found for compound **137**, which also possesses a benzene ring fused to a 1,4-dithiin ring. It is apparent from these data that fusion of a 1,4-dithiin ring to an acenaphthylene moiety does not in itself alter the first oxidation potential of the system, which seems to be centred on the heterocycle. A limited conclusion that we may draw is that the first oxidation potential is more dependant on the bond order of the substituted 1,4-dithiin (see Appendix 2 for ESR corroboration of this conclusion). This may also explain the almost identical oxidation characteristics of compounds **137** and **141**.

**156****157**

2.3.2 CHARGE-TRANSFER SALTS

Both donors **137** and **141** formed 1:1 complexes with 7,7,8,8-tetracyano-*para*-quinodimethane (TCNQ) which were electrical insulators (two-probe compressed pellet method).¹²⁴ The presence of a nitrile absorption peak at 2215 cm^{-1} (**137**:TCNQ) and 2217 cm^{-1} (**141**:TCNQ) suggested that there was a small degree of charge-transfer from the donor to TCNQ within the complexes.¹²⁵ The use of the more powerful electron acceptor 2,5-dibromo-TCNQ also afforded a 1:1 complex with donor **137**, although all

attempts to form an analogous salt with **141** failed. The complex **137**: Br₂TCNQ was also an insulator although a greater degree of charge-transfer was suggested by the shift of the nitrile absorption peak to 2209 cm⁻¹. Donor **150** failed to form complexes with both TCNQ and Br₂TCNQ, which may be due to the high solubility of this compound and any salts which may have formed.

2.3.2.1 SINGLE-CRYSTAL X-RAY STUDY OF **137**:Br₂TCNQ

In the structure of the complex **137**: Br₂TCNQ (1:1 stoichiometry) molecules of **137** and Br₂TCNQ form mixed stacks parallel to the *x* axis and symmetrically generated by the translation along that axis (Figure 2.2a). This stacking motif explains the low conductivity of this complex (see Section 1.3.2). The folding of the donor molecule is reduced significantly to 17° (*cf.* 48° in pure compound **137**, Figure 2.1) and the π-π conjugation in the dithiine ring is increased, as indicated by a contraction of the S-C(phenylene) and S-C(acenaphtho) bonds to 1.765(5) and 1.730(4) Å, respectively, compared to 1.780(2) and 1.747(2) Å in the crystal of **137** (*cf.* 1.745 Å in the planar molecule **146**).¹²¹ However, other bond distances in the complex **137**: Br₂TCNQ do not differ significantly from those in the pure components, **137** and Br₂TCNQ.¹²⁶ It is difficult to estimate the degree of charge-transfer in **137**: Br₂TCNQ from an analysis of the bond lengths, as the only fully reported structures containing Br₂TCNQ anions of definite charges, (DEM)(Br₂TCNQ)_n (where DEM = 4,4-diethylmorpholinium cation, and n=1 or 2) were studied on very imperfect crystals and are of limited accuracy.¹²⁷

Distortion of the cyano groups in the positions *syn*- to the bromine atoms, observed both in **137**: Br₂TCNQ and in Br₂TCNQ (see Table 2.1), can be attributed to secondary Br...C bonding, rather than to Br...N repulsion. While the neutral Br₂TCNQ molecule is perfectly planar,¹⁰¹ in **137**: Br₂TCNQ it is folded in a boat fashion along the C(02)...C(06) and C(03)...C(05) vectors by 4.5 and 7°, respectively. The direction of folding is the same as in both adjacent dithiine moieties, *i.e.* 'polar' throughout the stack. The main planar moieties of the **137** and Br₂TCNQ molecules are parallel to within 1°, with nearly uniform interplanar separations of 3.31 and 3.36 Å, and the shortest contacts are C...C 3.32-3.35, and S...C 3.20-3.31 Å, which imply substantial π-π overlap along the stack. The S and Br atoms, which will bear δ+ and δ- charges, respectively, form intrastack contacts of 3.66-3.82 Å (*cf.* the normal Van der Waals distance¹²⁸ of 3.75 Å), but surprisingly no short interstack contacts exist. On the other hand, the moieties related *via* a crystallographic translation along the [1 1 0] axis, are linked into an infinite chain (Figure 2.2b) by pairs of roughly linear contacts Br(2)...N(81) 3.17 and Br(5)...N(72) 2.95 Å (*cf.* 3.12 Å in Br₂TCNQ).¹⁰²

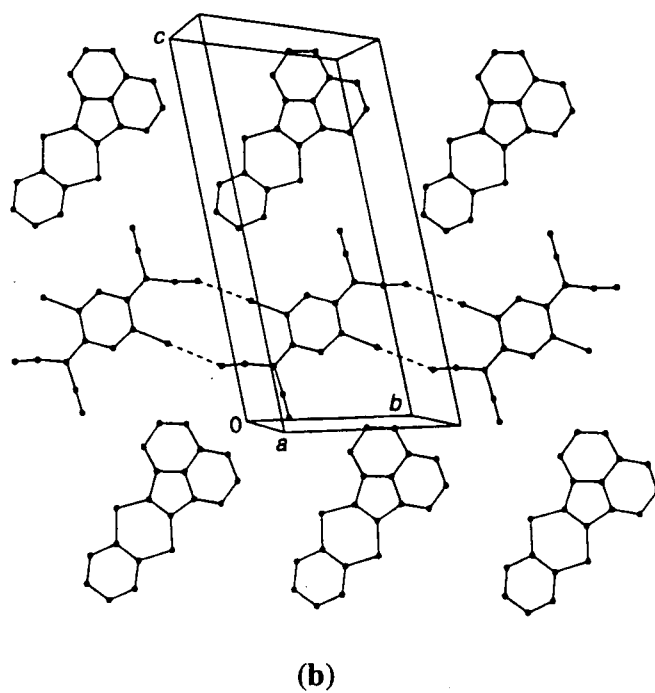
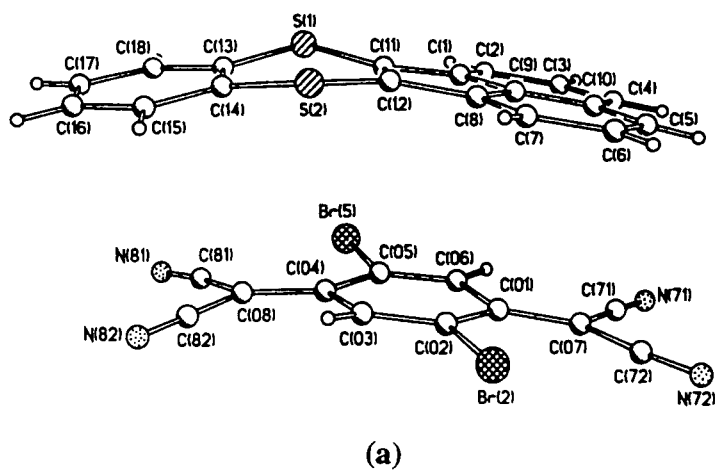
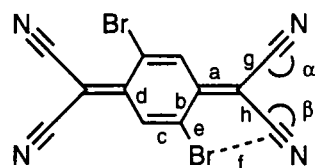

Figure 2.2 Crystal structure of complex 137: Br₂TCNQ

Table 2.1 Selected bond lengths (Å) and angles (°) in dibromo-TCNQ moieties (mean of chemically equivalent bonds)

	25: Br ₂ TCNQ	Br ₂ TCNQ
a	1.389(6)	1.378(6)
b	1.454(6)	1.446(6)
c	1.350(6)	1.344(6)
d	1.450(6)	1.460(6)
e	1.879(4)	1.874(6)
f	3.016(4)	3.011(6)
g	1.429(6)	1.439(6)
h	1.439(6)	1.432(6)
C-N	1.149(6)	1.141(7)
α	177.7(5)	177.9(5)
β	170.6(5)	171.0(4)



2,5-Br₂-TCNQ

2.3.3 RADICAL-CATION SALTS

Both donors **137** and **141** formed salts on combination with I₂ under slow diffusion conditions. Donor **137** formed lustrous gold needles which analysed for a 1:4 / donor:iodine stoichiometry. Single crystal, two probe conductivity measurements showed an unstable conductivity of $2.4 \times 10^{-2} \text{ Scm}^{-1}$ at room temperature for this salt. Single crystal X-ray diffraction analysis is also being undertaken. Donor **141** formed a dark, metallic tinted, microcrystalline solid which also analysed for a 1:4 stoichiometry. Compressed pellet, two probe conductivity measurements¹²⁴ showed a room temperature conductivity in the order of 10^{-3} Scm^{-1} . Donor **150** failed to give a salt under these conditions.

The formation of radical cation salts of **137**, **141** and **150**, with closed shell counter anions, has been attempted using electrocrystallisation techniques. So far, no crystalline salts have been obtained.

2.4 CONCLUSIONS

Derivatives of the basic π -electron donor **117** have been synthesised using existing and novel ring expansion methodologies. Compound **137** has been studied in detail as an electron donor for the formation of charge-transfer complexes. The X-ray

crystal structures of **137**, and its 1:1 charge-transfer complexed with the electron acceptor 2,5-dibromo-TCNQ have been obtained. The X-ray analysis of its 1:4 radical-cation salt with iodine is ongoing at the time of submission of this thesis. The mixed stacking motif of the charge-transfer complex explains its low conductivity and the radical-cation salt has a moderate conductivity. The relatively low oxidation potentials of compounds **137** and **141** ($E_1^{1/2} = +0.69$ and $+0.80$ V, respectively) makes them promising π -donors for further studies on charge-transfer complexes with strong π -electron acceptors, and for electrocrystallisation with inorganic anions, which may yield highly-conducting radical ion salts.

Chapter Three

*1,4-Dithiin derivatives via Nucleophilic
attack of 1,2-dithiolate anions*

3.1 INTRODUCTION

Commensurate with our project to synthesise new acenaphtho-[1,2-b][1-4]-dithiin based π -electron donor compounds, we sought new methods for their synthesis. Conceptually, one of the simplest ways to synthesise a 1,4-dithiin ring system is *via* the nucleophilic attack of an unsaturated *cis*-1,2 dithiolate dianion on a *cis*-1,2-dihalogenoalkene. This approach has been previously used with some success, for example by heating disodium *cis*-ethylenedithiolate **158** with *cis*-1,2-dichloroethylene **159** in DMSO, the parent 1,4-dithiin **160** can be synthesised although in very low yield (Scheme 3.1).¹²⁹

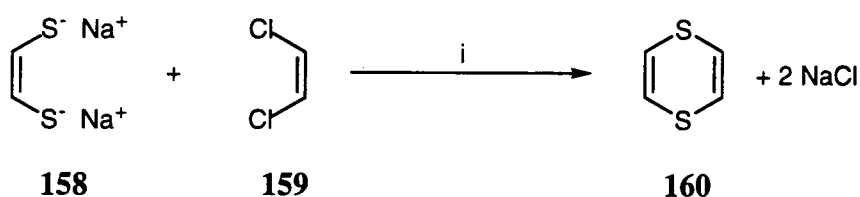

Scheme 3.1 Reagents and Conditions. i, DMSO, heat.

In addition to this basic example there are several cases where the more complex, heterocyclic, 1,3-dithiole-thione-4,5-dithiolate species **161** has been reacted with various *cis*-1,2-dihalogeno-alkenes to form multi-heterocyclic compounds containing the 1,4-dithiin ring system **160**. Shown below are a number of examples (Scheme 3.2). The simplest case is the reaction of species **161**, which is generated *in situ*, in THF, with *cis*-1,2-dichloroethylene to afford the parent compound **162**.¹³⁰ Further examples are the reaction of **161** with 2,3-dichloro-1,4-naphthoquinone to give compound **164**,¹³¹ with dichloromaleic anhydride to give compound **163**,¹³² and with 2,3-dichloroquinoxaline to give compound **165**.¹³³ These compounds were all synthesised as half units en route to a final TTF electron donor system by self coupling reactions. For example, compound **165** was coupled to afford the extended TTF **166**.¹³³ The electronic contacts of the peripheral heteroatoms may help in overcoming, within a charge-transfer or radical-cation salt, the Peierls instability or transition from a metallic state to either a semiconducting or insulating one at low temperatures (see Section 1.3.3).

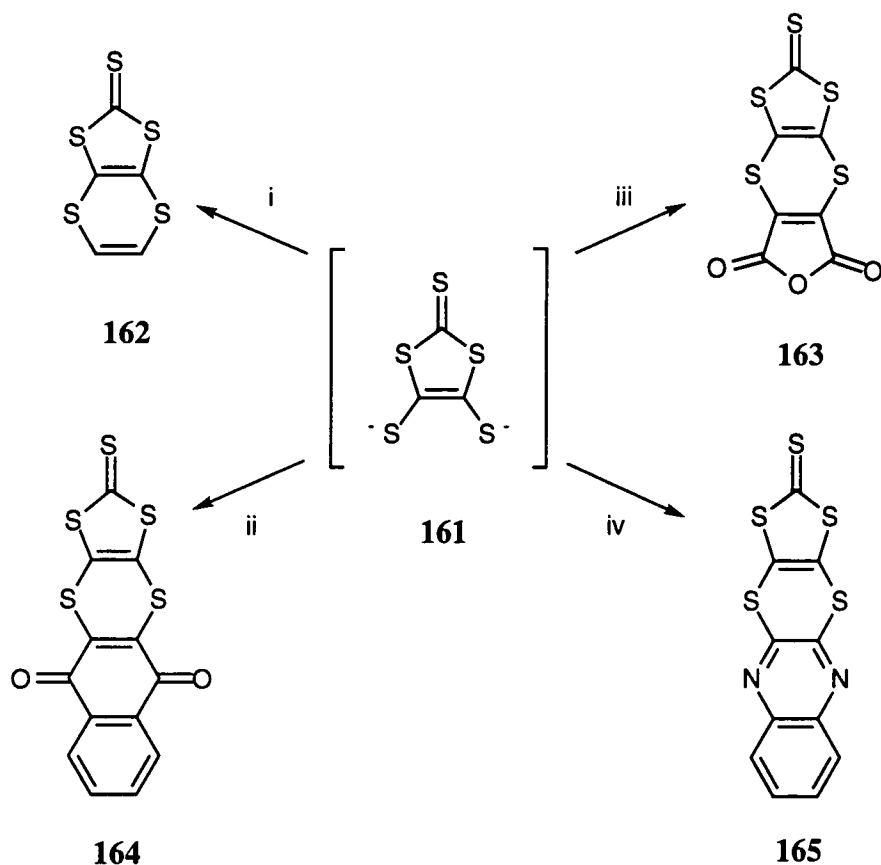

Scheme 3.2 *Reagents and Conditions.* i, *cis*-1,2-Dichloroethane, THF; ii, 2,3-Dichloro-1,4-naphthoquinone, Benzene, 4h, 20°C, 65%; iii, Dichloromaleic anhydride ; iv, 2,3-Dichloroquinoxaline, THF, 20°C, 16h, 95%.

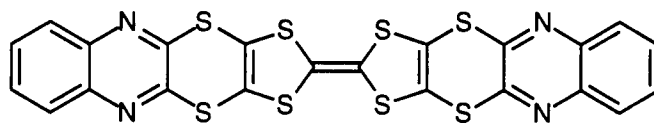

166

Dithiolate systems other than compounds **158** and **161** have been shown to perform this type of *bis*-nucleophilic reaction with unsaturated 1,2-dihalogeno systems. In 1994, Martí *et.al.*¹³⁴ demonstrated that two equivalents of 1,2-benzenedithiol **167**, when treated with sodium bicarbonate in refluxing DMF, would undergo nucleophilic attack upon 1,2,4,5-tetrachlorobenzene **168** to form 5,7,12,14-tetrathiapentacene **170**, in 37% yield (Scheme 3.3). A similar reaction was also observed with 2,3,5,6-tetrachloropyridine **169** to give 6-aza-5,7,12,14-tetrathiapentacene **171** in 67% yield.¹³⁴ Compound **170** and **171** were both synthesised as potential organic electron donors with polarizable heteroatoms, in the style of those described in Chapter 1

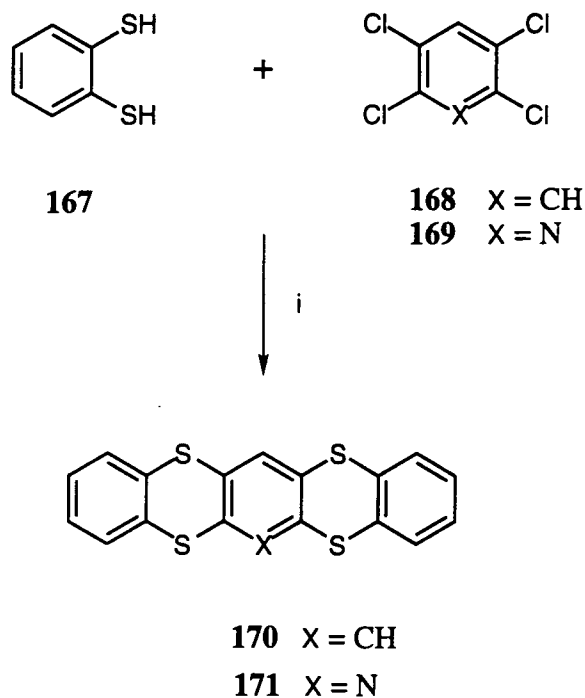

Scheme 3.3. Reagents and conditions. i, DMF, NaHCO₃, reflux, 23h, 37%.

In an attempt to synthesise novel acenaphtho-1,4-dithiin electron donor molecules, of the type described in Chapter 2, we elected to investigate synthetic approaches based on this methodology. We envisioned that this new approach would enable us to synthesise compounds, based on the parent system **117**, which would incorporate novel substituents that may enhance their donor and stacking properties which would be difficult to incorporate using the synthetic procedures previously described (Section 2.1.2).

3.2 SYNTHESIS

3.3.1 SYNTHESIS VIA 1,2-DIBROMOACENAPHTHYLENE

Two important facts determined the applicability of such a synthetic route to the synthesis of compounds based on system **117**;

i) Bechgaard *et. al.* had reported the synthesis of 1,3,5,7-tetrathia-*s*-indacene-2,6-dione **172**,¹³⁵ and described the reaction of this system with either two or four equivalents of alkoxide to form the di-thiolate **173** and tetra-thiolate anions **174**, respectively (Scheme 3.4). Two equivalents of alkoxide can nucleophilically attack the carbon centre of the dithiocarbonate functionality to liberate an alkyl carbonate and two thiolate anions.

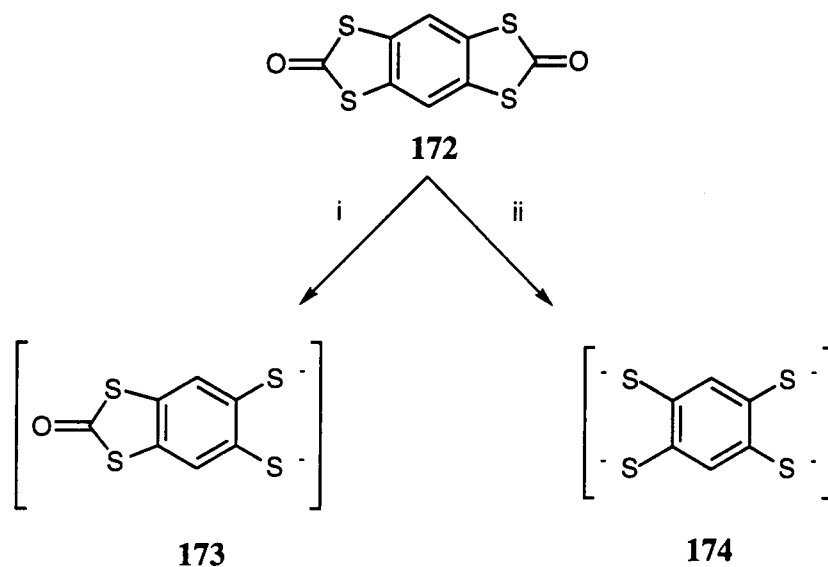

Scheme 3.4 Reagents and Conditions. i, 2 ⁻OR, THF; ii, 4 ⁻OR, THF.

ii) Previously Trost *et. al.* had described the convenient synthesis, in good yield, of 1,2-dibromoacenaphthylene **176**,¹³⁶ by the reaction of acenaphthene with four equivalents of *N*-bromosuccinimide. A postulated rationale to the unsaturated nature of the product involves the formation of the 1,1,2-tribromoacenaphthylene **175** which loses HBr probably by a free-radical pathway as depicted in Scheme 3.5.¹³⁶

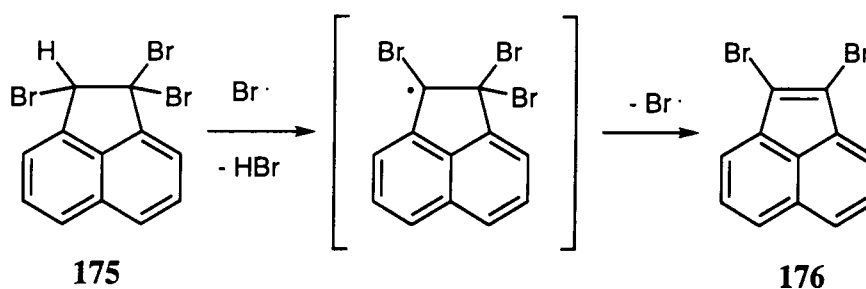

Scheme 3.5

The nucleophilic substitution reactions between the unsaturated dibromo compound **176** and the dithiolate **173** and tetrathiolate **174** anions derived from **172** were attempted (Scheme 3.6).

Compound **172** was stirred in dry DMF and treated with four equivalents of potassium *t*-butoxide to generate the tetra-anion **174** as a deep red solution. Two equivalents of compound **176** were then added and the mixture heated at 130°C for 20 h to yield the highly insoluble tetrathiaarene compound **177** as red microcrystals in 21% yield.

In a similar procedure, compound **172** was treated with two equivalents of potassium *t*-butoxide to give the dithiolate anion **173** and then one equivalent of the dibromo compound **176**. The mixture was stirred at 90°C for 15 hours and the product purified by column chromatography to give compound **178** in 25% yield as an orange powder.

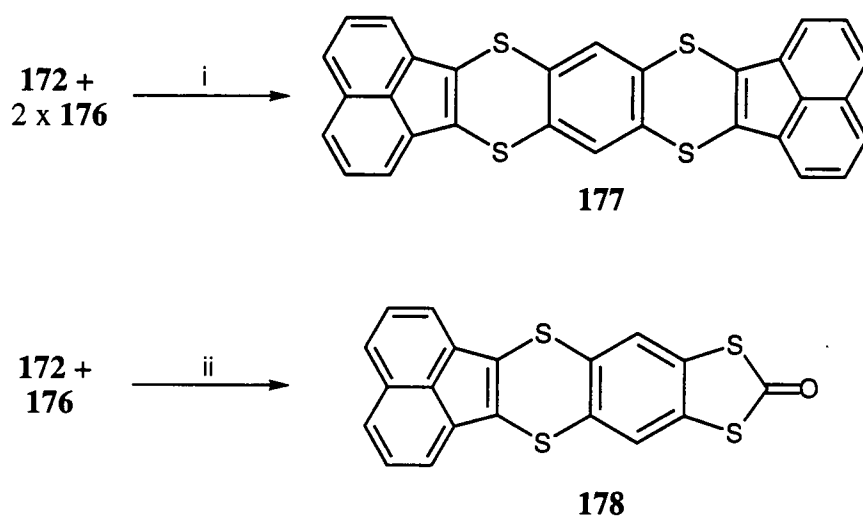

Scheme 3.6 *Reagents and Conditions.* i, 2 *t*-BuOK, DMF, 20°C, 10 min, 90°C, 15h; ii, 4 *t*-BuOK, DMF, 20°C, 15 min, 130°C, 20h.

Compound **178** has utility in that it still possesses a dithiocarbonate function which can be treated with two equivalents of alkoxide to liberate the dithiolate dianion intermediate **179** (Scheme 3.7). This may subsequently be quenched with two equivalents of methyl iodide to give the dithiomethyl derivative **180**, or with one equivalent of 1,2-dibromoethane to give the ethane bridged system **181**.

Compounds **180** and **181** are both substituted derivatives of π -electron donor compound **117**, described in Chapter 2, and were synthesised in expectation of emulating the good donor and salt formation properties of this compound.

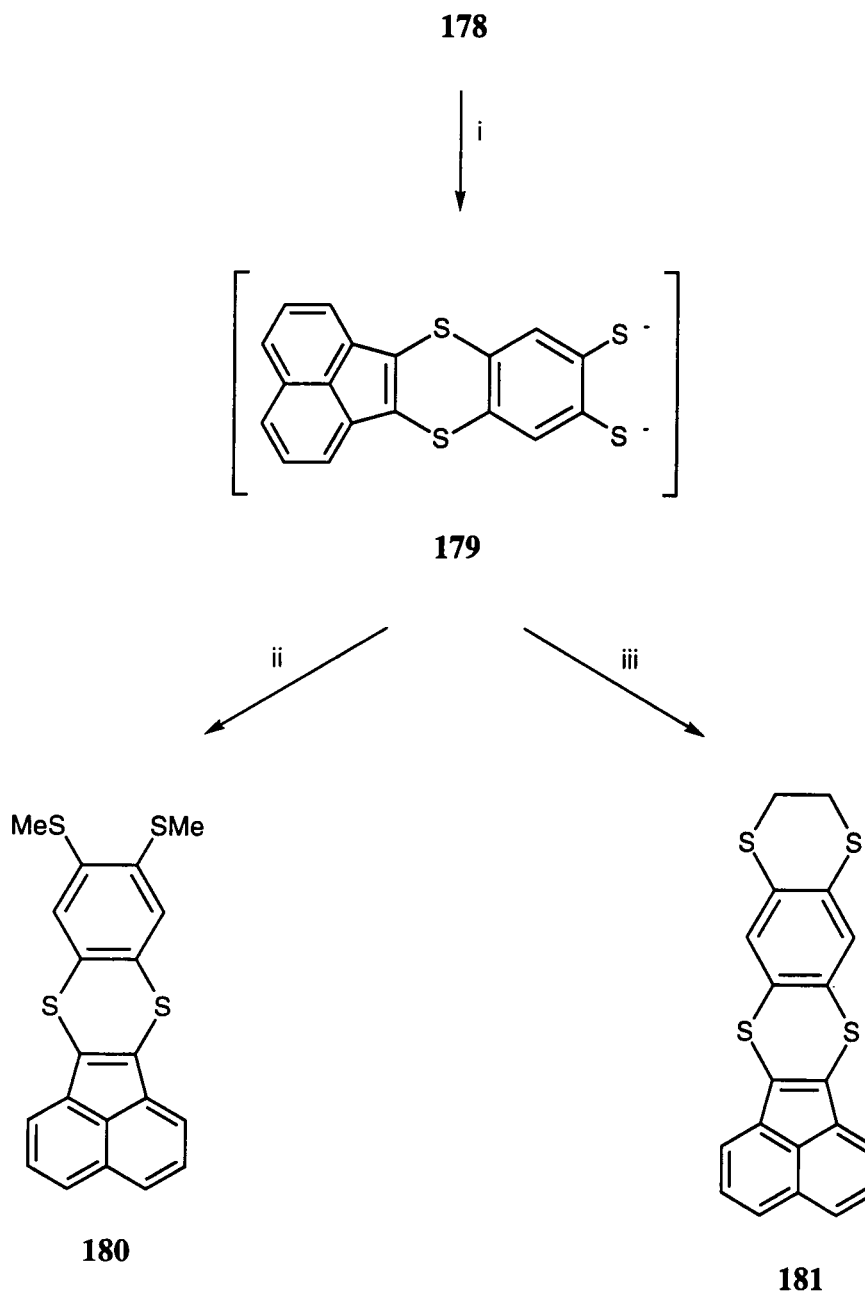

Scheme 3.7 Reagents and Conditions. i, 2 ^tBuOK, THF, 1h, 20°C; ii, 2MeI, THF, 15h, 20°C, 44%; iii, BrCH₂CH₂Br, THF, 15h, 20°C, 55%.

3.2.2 ACENAPHTHYLENE-1,2-DITHIOLATE DIANION

During the progress of this work, we attempted to synthesise the acenaphthylene-1,2-dithiolate dianion **183**, as it was envisaged that this species would facilitate the synthesis of a wide variety of substituted acenaphthylene-1,4-dithiin systems by analogy with the previously described 1,4-dithiin synthesis.

The initial approach to system **183** was to employ the methodology which we had previously implemented successfully in the synthesis of compound **172** from 1,2,4,5-tetrachlorobenzene¹³⁵ and apply it to 1,2-dibromoacenaphthylene **176** (Scheme 3.8).

Thus compound **176** was heated in DMF with sodium isopropylthiolate (generated *in situ* from *iso*-propanethiol and sodium hydride) to afford the *bis*-substituted compound **182**, as an orange oil, in excellent yield. The isopropyl groups in compound **182** were removed by heating with sodium in pyridine to give the dithiolate intermediate **183** as a deep red solution. The dithiolate anions of **183** are, however, highly reactive and handling the *bis*-sodium salt proved difficult. To avoid this, and to afford a stable compound which could act as a latent source of **183**, we elected to protect the thiolate functionalities. Previous workers had reported the use of phosgene to generate compound **172**;¹³⁵ however, our attempts to emulate this reaction (using triphosgene as a more easily handled alternative to phosgene) and generate the dithiocarbonate **184** failed. We suspect that the basic conditions, which prevail in the initial stages of work up, deprotected the thiolate groups and regenerated intermediate **183** which subsequently decomposed. Attempts to protect the thiolate anions using benzoyl chloride to generate the *bis*(thiolester) **185**, an approach which has previously been successfully used in dithiolate anion protection,¹³⁷ were equally disappointing, yielding only intractable products. Compound **184** has been previously synthesised by Cava *et. al.* by a longer more involved route.¹³⁸

Due to the failure of the previous thiolate anion protection reactions, a second approach was attempted. Zinc chloride and tetrabutylammonium bromide were reacted with the intermediate **178** whilst in DMF solution, to yield the zincate salt **186** which was isolated as a light blue powder in 10g quantities in 56% yield. The zincate salt **186** decomposes slowly in air over one to two days and was, therefore, used immediately upon preparation. It was subsequently shown that when sealed under dry argon gas and stored below 0°C zincate salt **186** was stable indefinitely.

We envisaged that the new zincate salt **186** could serve in an analogous manner to the widely investigated zincate salt **188**.^{137,139,140} Because of the poor stability of salt **186** a stable substitute was investigated. Benzoyl chloride had already been utilised in an attempt to trap the dithiolate dianion **183**. This protecting group has previously been used to protect the ligating thiolate functionalities in zincate salt **188**.^{137,139,140} This reaction is simple to perform and proceeds in good yield to afford the dibenzoyl protected compound **187** from which the dithiolate dianion **161** may be generated by *trans* esterification with sodium methoxide anions (Scheme 3.9). When **186** was reacted with benzoyl chloride in acetone, compound **185** was isolated albeit in disappointingly low yield (36%) (Scheme 3.10). Compound **185** is a stable microcrystalline yellow substance which when treated with sodium methoxide

regenerates the dithiolate intermediate **183** which has the potential to then react with electrophiles such as those utilised in Scheme 3.2.

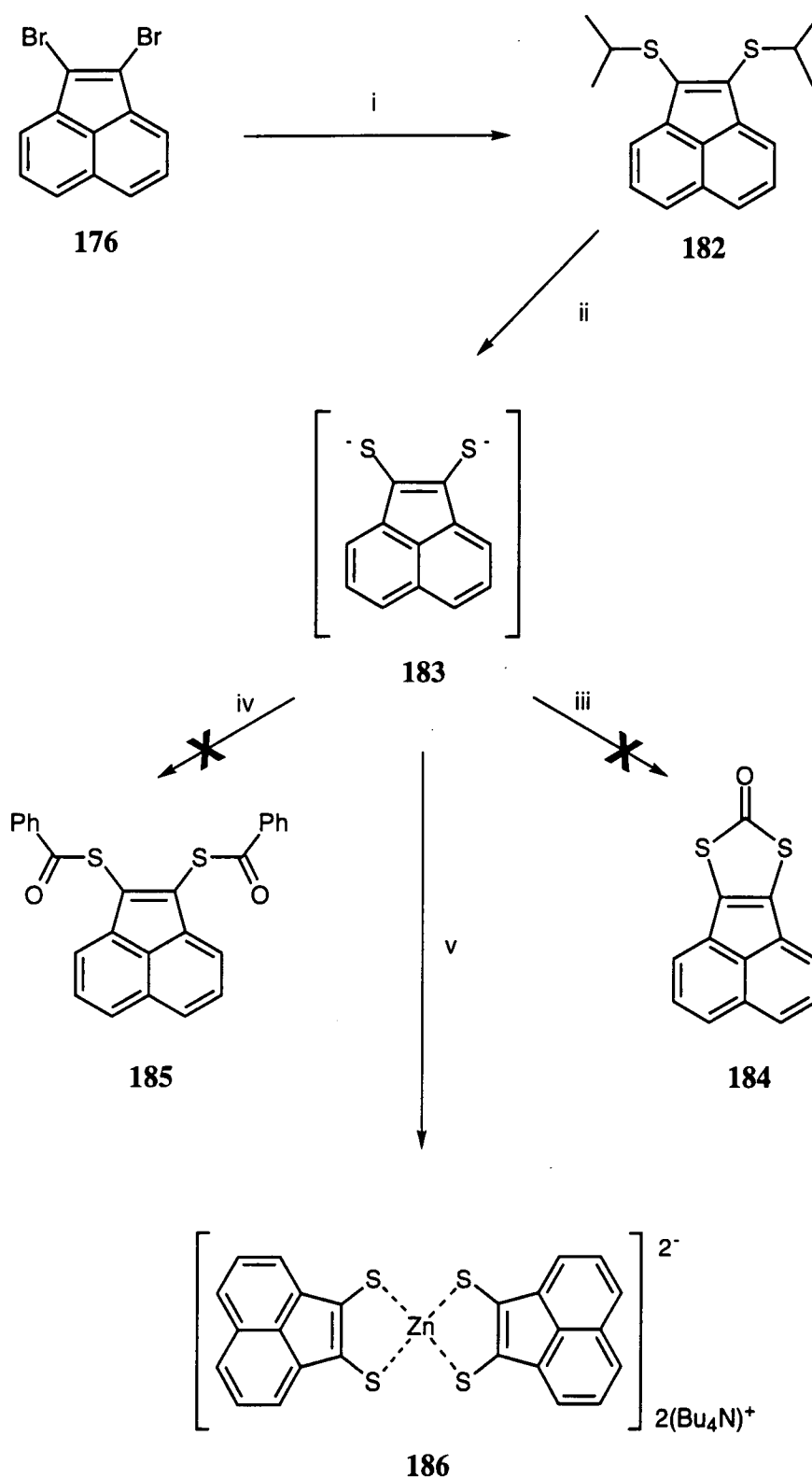

Scheme 3.8 Reagents and Conditions. i, 2 $i\text{PrSH}$, 2 NaH , DMF, 100°C , 2h, 90%; ii, 2Na, Pyridine, 100°C , 1.5h; iii, ClC(O)C(O)COCl ; iv, 2 PhCOCl ; v, $1/2 \text{ZnCl}_2$, Bu_4NBr , $\text{MeOH} / \text{H}_2\text{O} / \text{Pyridine}$, 20°C , 56%;

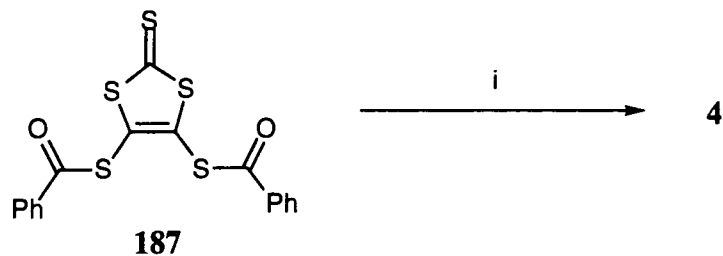

Scheme 3.9 Reagents and Conditions. i, NaOMe, MeOH, 87%.

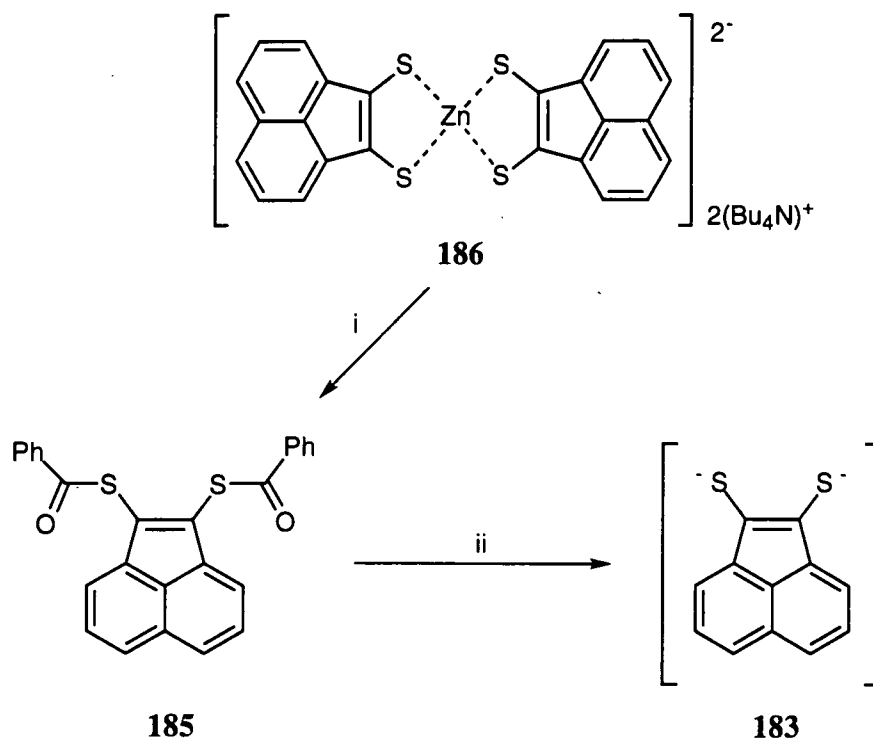

Scheme 3.10 Reagents and Conditions. i, 2 PhCOCl, acetone, 20°C, 0.5h, 36%; ii, 2 NaOMe, THF.

3.3 ELECTROCHEMICAL STUDIES OF COMPOUNDS 180 AND 181 AND SALT SYNTHESIS

3.3.1 ELECTROCHEMICAL STUDIES

The electrochemical redox properties of donors **180** and **181** were studied by cyclic voltammetry.

The cyclic voltammogram of donor **180** showed two, reversible one-electron oxidation waves to form the radical cation species **180**^{•+} and the dication species **180**²⁺, respectively ($E_1^{1/2} = +0.73\text{V}$ and $E_1^{1/2} = +1.24\text{V}$). The cyclic voltammogram of donor **181** showed a single reversible one-electron oxidation wave to form the radical cation species **181**^{•+} and a quasi-reversible wave to form the dication species **181**²⁺ ($E_1^{1/2} = +0.78\text{V}$ and $E_2^{1/2} = +1.27\text{V}$).

Both systems exhibit similar oxidation values and characteristics. They both show lower oxidation potentials than the parent system **117** ($E_1^{1/2} = +0.83\text{V}$ reversible, and $E_2^{\text{ox}} = +1.39\text{V}$ irreversible) and oxidation to the dication shows significantly more reversibility. These differences may be explained by the cation stabilising effects of the *bis*-SMe and SCH₂CH₂S bridge substituents in **180** and **181**.

3.3.2 SALTS

Donor **180** formed a complex with Br₂TCNQ (although we were unable to get satisfactory elemental analysis, we suspect this complex has a 1:1 stoichiometry) as small black needles. This complex was an electrical insulator (two-probe compressed pellet method)¹²⁴ and the presence of a nitrile absorption at 2205 cm⁻¹ suggests some degree of charge-transfer.

Donor **181** failed to give a complex with Br₂TCNQ and both donors **180** and **181** failed to give a complex with TCNQ.

The formation of radical cation salts of **180** and **181** by electrocrystallisation with closed shell counter anions and by slow diffusion of I₂ vapour failed to give any salts.

3.4 CONCLUSIONS

Compounds **172** and **176** have been successfully utilised, in a new methodology, to generate three new thia-arenes (**177**, **180** and **181**). These are S-alkyl derivatives of the interesting organic electron donor **137**. Compound **180** formed an insulating 1:1 charge-transfer complex with Br₂TCNQ. Attempts to form other radical-cation and charge-transfer salts from these new electron donors were unsuccessful, in spite of their favourable electron donor properties

A novel 1,2-thiolatoacenaphthylene zincate salt (**186**) has been prepared, which may have some utility in the synthesis of other 1,2-thiolatoacenaphthylene complexes and derivatives of compound **117**.

Chapter Four

1,4-Dithiin Derivatives from Oligo(1,3-dithiole-2,4,5-trithione)

4.1 INTRODUCTION

In 1989 Neilands *et al.* succeeded in preparing and characterising¹⁴¹ the oligomer oligo(1,3-dithiole-2,4,5-trithione) **189**, by iodine oxidation of the zincate salt $(\text{NEt}_4)_2\text{Zn}(\text{dmit})_2$ **188** which is readily available by the reduction of carbon disulphide with sodium (Scheme 4.1). This reaction affords **189** as a yellow / orange amorphous insoluble substance, in 97% yield, that analyses correctly for the oligomer **189**. Independently Rauchfuss *et al.*¹⁴² reported that $(\text{NEt}_4)_2\text{Zn}(\text{dmit})_2$ **188** when treated with SO_2Cl_2 in acetonitrile at -40°C produces an orange compound from which the dimer **190** could be isolated in 46% yield, the remainder being compound **189**. It could be speculated that substance **189** is actually a mixture of compounds that are higher analogues of the dimer **190**, *i.e.* trimers, tetramers *etc.*, either cyclic or linear in character.

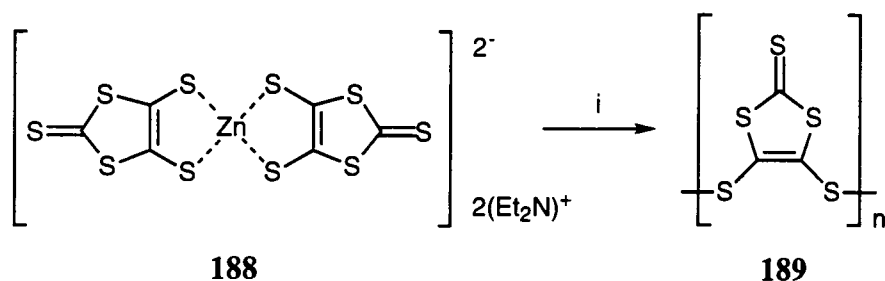

Scheme 4.1 Reagents and conditions. *i*, I_2 , EtOH acetone, -50°C , 2h, 97%.

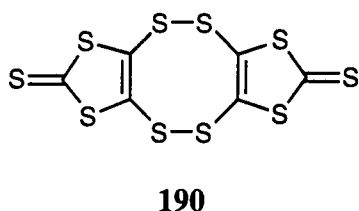

It is interesting to note that traditional oxidising compounds are not the only reagents which effect the transformation of $(\text{NEt}_4)_2\text{Zn}(\text{dmit})_2$ **188** into oligo(1,3-dithiole-2,4,5-trithione) **189**. When reacted with certain 1,2-dihaloalkanes compound **188** is converted immediately and in high yield into substance **189**. This type of reaction has been observed when using 4,5-dichloro-1,3-dioxolan-2-one,¹⁴³ 3,4-dibromofuran-2,5-dione¹⁴⁴ and 3,4-dibromo-1-phenylpyrrole-2,5-dione.¹⁴⁴ This transformation has also been observed with disodium dimercaptomaleonitrile¹⁴⁵ and the mechanism is

believed to involve the initial nucleophilic attack of a thiolate functionality onto a halogen atom (Scheme 4.2).¹⁴⁶

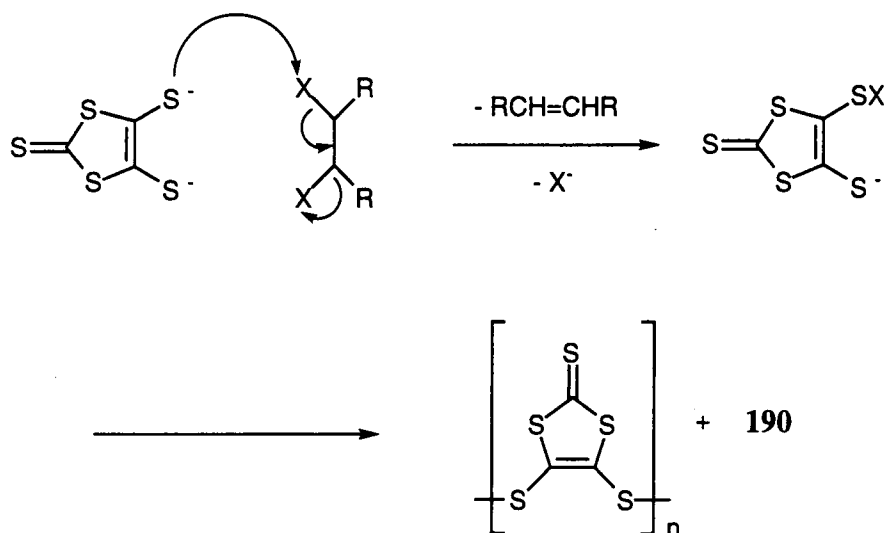

Scheme 4.2

An extremely interesting and useful property of compound **189** is that it undergoes thermally induced Diels-Alder type pericyclic reactions with both electron-rich and electron-poor dienophiles.¹⁴¹ Monomeric units of 1,3-dithiole-2,4,5-trithione may be generated *in situ* from **189** by thermal depolymerisation at temperatures between 80-120°C in a variety of solvents such as toluene, benzene, dioxane and thiophene. This species then undergoes cycloadditions with certain dieneophiles.

An example of this cycloaddition is the synthesis of 4,5-(*cis*-1,2-cyclohexylenedithio)-1,3-dithiole-2-thione **191**,¹⁴⁷ which was performed by heating substance **189** and cyclohexene **192**, at 85°C, in benzene for 5 hours (Scheme 4.3).

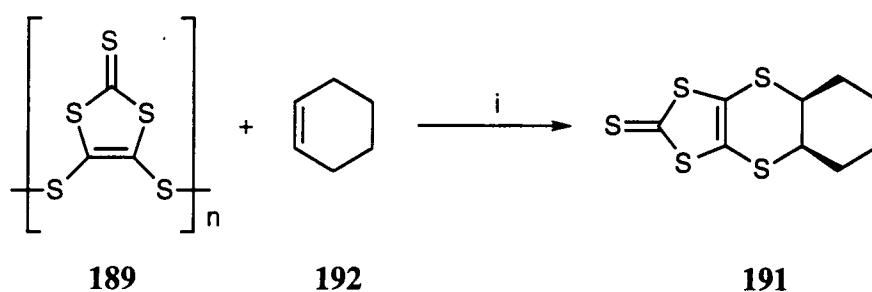

Scheme 4.3 Reagents and conditions. i, Benzene, 85°C, 5h, 45%.

Compound **189** has been shown to be a particularly good Diels-Alder eneophile in that it will react with the 4,5-double bond of tetrathiafulvalene (TTF) (Scheme 4.4).¹⁴⁸ This double bond had previously been known for its very low reactivity towards nucleophiles as well as electrophiles.

Thermal depolymerisation is not the only method that has been used to effect reactions of this type. Rauchfuss *et al.*¹⁴² have shown that both compounds **189** and **190**, when treated with a catalytic amount of PBU_3 in dichloromethane at room temperature, react with dimethyl acetylenedicarboxylate (DMAD) to give the bis-ester **194** in 65% yield (Scheme 4.4).

Scheme 4.4 illustrates further reactions in which the eneophile **189** has been exploited.

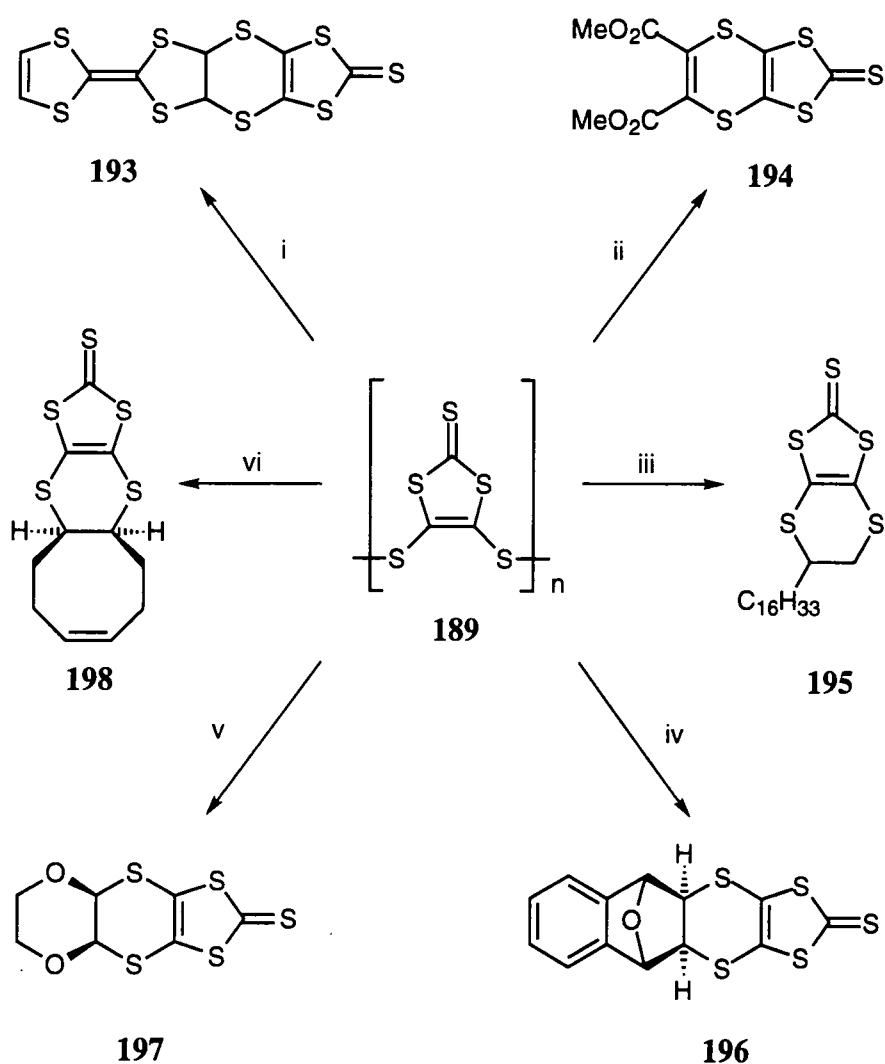

Scheme 4.4 Reagents and conditions. i, TTF, thiophene, reflux, 4h; then, 20°C, 12h, 45%;¹⁴⁸ ii, DMAD, CH_2Cl_2 , PBU_3 , 20°C, 2h, 65%;¹⁴² iii, Octadec-1-ene, dioxane, reflux, 5h, 57%;¹⁴¹ iv, 1,4-Dioxene, dioxane, 90°C, 10h, 25%;¹⁴⁹ v, *cis,cis*-1,5-Cyclooctadiene, dioxane, reflux, 1.5h, 51%;¹⁴⁴ vi, 1,4-dihydronaphthalene-1,4-endoxide, toluene, reflux, 0.5h, 65%.¹⁴⁴

Diels-Alder reactions of this type provide an excellent method for the preparation of 4,5-ethylenedithio-1,3-dithiole-2-thione derivatives of general structure **199**. It is also seen that these reactions show a remarkable control of the stereochemistry (as would be expected from a Diels-Alder reaction).

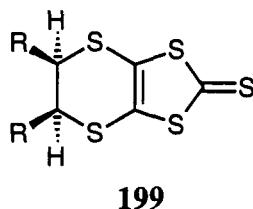

We recognised that there was potential in compounds of type **199** for the preparation of 1,4-dithiin ring systems from the substituted dihydro-1,4-dithiin. We therefore sought to apply this idea to the synthesis of 1,4-dithiin π -electron donor molecules of the type described in Chapter 2.

4.2 SYNTHESIS OF ACENAPHTHO-1,4-DITHIIN DERIVATIVES

Acenaphthylene **200** is known to act as an electron rich dienophile in Diels-Alder cycloaddition reactions,¹⁵⁰ eg, its reaction with sorbic acid to give tetrahydro-7-methylfluoranthene-10-carboxylic acid **201** (Scheme 4.5).¹⁵⁰

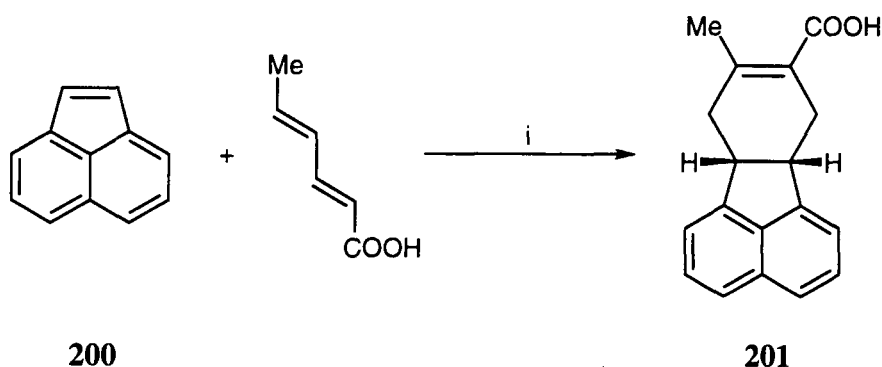

Scheme 4.5 Reagents and conditions. i, 200°C, 20h, 30%.

Acenaphthylene **200** and oligo(1,3-dithiole-2,4,5-trithione) **189** were heated together in refluxing toluene and within 0.5 hours the suspended oligo(1,3-dithiole-2,4,5-trithione) completely disappears from the reaction mixture and the cycloaddition product **202** appeared in good yield (80%) as bright yellow microcrystals which were easily isolated by simple filtration (Scheme 4.6). Compound **202** was dehydrogenated by refluxing it overnight in toluene with 2,3-dichloro-5,6-dicyano-1,4-benzoquinone

(DDQ) to furnish the dehydrogenated compound **203** (75%) as orange microcrystals. Treatment of the 1,3-dithiole-2-thione **203**, in a mixture of chloroform / glacial acetic acid (3:1 v/v) with mercury acetate effected a transchalcogenation¹⁵¹ to give the 1,3-dithiole-2-one **204** as salmon pink hair-like crystals. Compound **203** was also treated in the same way to afford the 1,3-dithiole-2-one **205**.

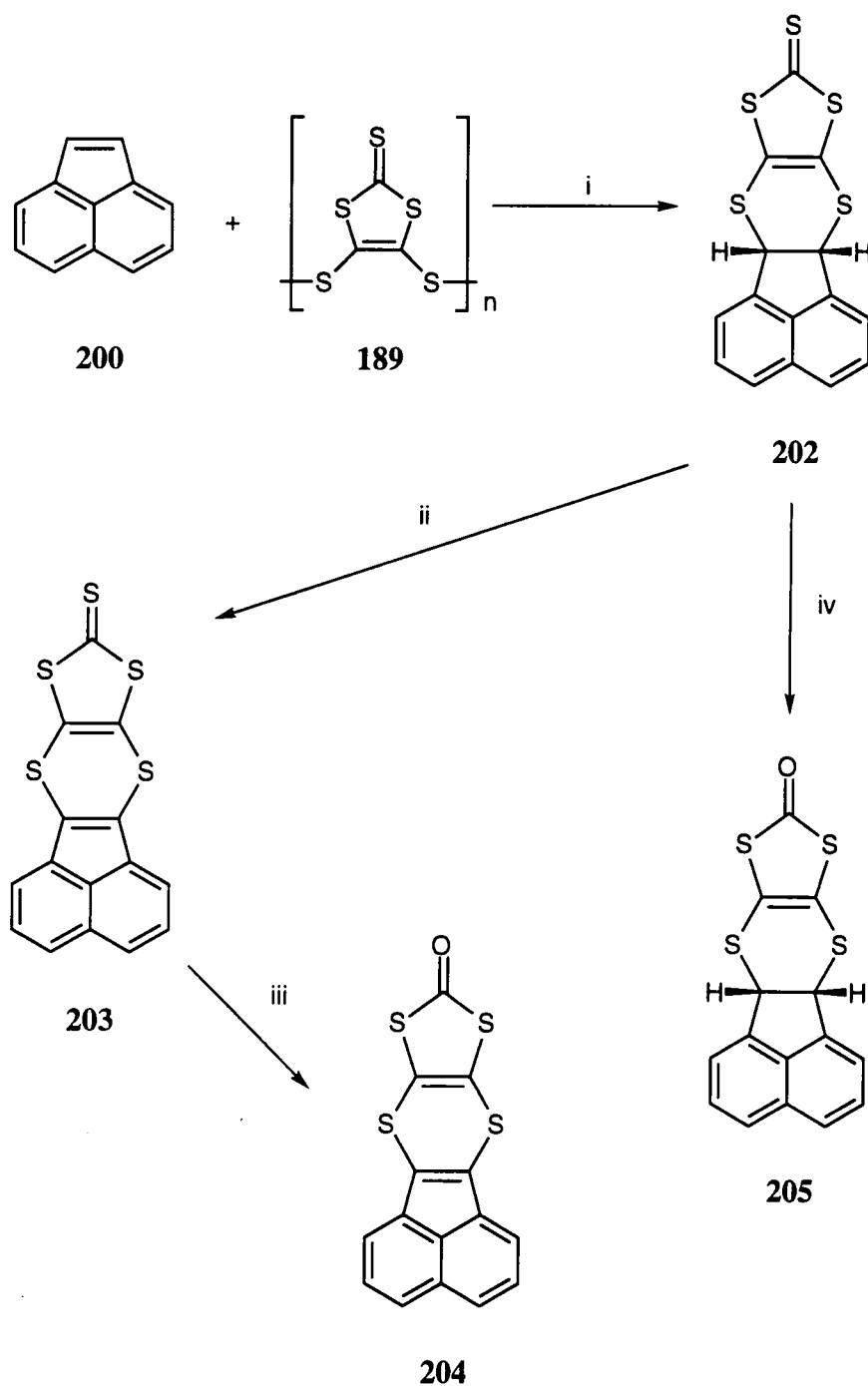

Scheme 4.6 Reagents and conditions. *i*, Toluene, reflux, 0.5h, 80%; *ii*, DDQ, Toulene, reflux, 16h, 75%; *iii*, Hg(OAc)₂, CCl₄ / AcOH 3:1 v/v, 60%; *v*, Hg(OAc)₂, CCl₄ / AcOH (3:1 v/v), 40%.

It is known that 1,3-dithole-2-ones are sensitive to nucleophilic ring opening.¹⁵² Compound **204** was treated with two equivalents of potassium t-butoxide in THF to give the dithiolate intermediate **206** which was immediately reacted with an excess of methyl iodide to give the desired product **207** in 80% yield as bright red plates (Scheme 4.7). Formation of intermediate **206** with various bases (potassium t-butoxide, sodium methoxide and sodium ethoxide) and in various solvents (THF, methanol, ethanol) at different temperatures (20°C, 0°C and -78°C), failed to give the bridged compound **208** on reaction with 1,2-dibromoethane (Scheme 4.7).

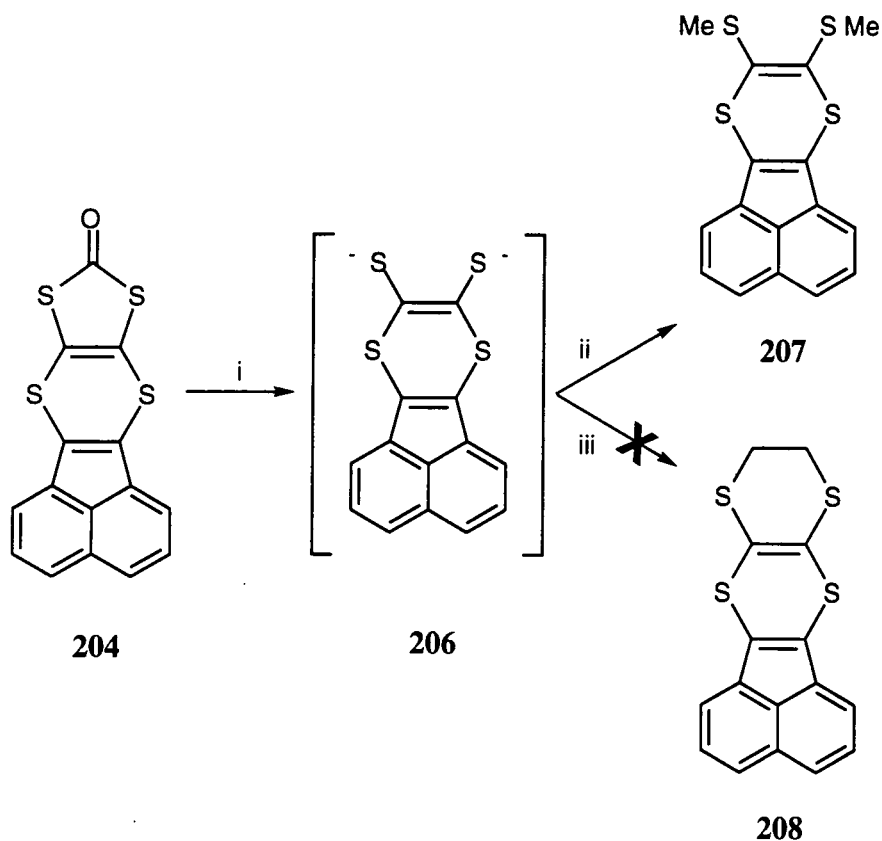

Scheme 4.7 Reagents and Conditions. i, 2 ^tBuOK, THF, 0.5h; ii, 2MeI, THF, 0.5h; iii) BrCH₂CH₂Br, various conditions.

The bis-SMe and -SCH₂CH₂S- substitutions to the basic acenaphtho[1,2-b][1,4]-dithiine (**117**) structure were chosen as these modifications, when applied to the TTF structure, give electron donors from which interesting charge transfer salts have been synthesised.¹⁵³ The failure of the ethane bridge substitution was surprising as this synthetic procedure has been used with success in similar examples.¹⁵⁴ Starting material is not recovered from this reaction so it is possible a mechanism somewhat like that illustrated in Scheme 4.2 is occurring.

The self-coupling reaction of compound **204** was also accomplished by heating in triethylphosphite to afford the highly insoluble TTF based system **209** in high yield (Scheme 4.8).

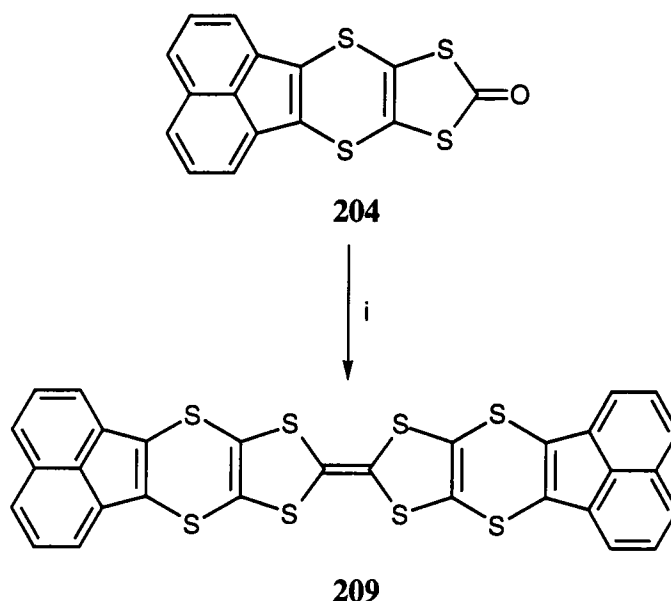

Scheme 4.8 Reagents and conditions. i, P(OEt)₃, heat, 1h, 90%.

Coupling of **203** with the cyanoethyl-protected 1,3-dithole-2-one compound **210**, which is readily available¹⁵⁵ from the zinc salt **188**, was also undertaken in triethyl phosphite (Scheme 4.9) to give the unsymmetrical TTF derivative **211**, albeit in low yield (17%). The propionitrile groups that feature in **211** were removed by treatment with caesium hydroxide¹⁵⁵ to give the dithiolate intermediate **212** which was reacted with methyl iodide to give the dithiomethyl substituted unsymmetrical TTF derivative **214** in excellent yield (96%). The attempted synthesis of the ethane bridged compound **213**, by the addition of 1,2-dibromoethane to intermediate **212**, failed under various conditions, as in the attempted synthesis of compound **208**.

4.2.1 SINGLE-CRYSTAL X-RAY ANALYSIS OF **207** AND **214**

Both donors **207** and **214** were analysed by single crystal X-ray diffraction.

The crystal structure of **207** (Fig. 4.1a,b) is characterised by pseudo-dimers with overlapping parallel acenaphtho moieties (interplanar separation of 3.58Å).

Molecule **214** adopts a boat conformation (Fig. 4.2a), folding by 46.5° along the S(1)...S(2) vector and by 17.0° along the S(5)...S(6) vector. The fused dithiole ring has an envelope-like distortion, the S(3) corner tilting out-of-plane by 6°. Molecules pack into a 'fir-tree' stack, in which acenaphtho moieties overlap with TTF ones, and vice versa (Fig. 4.2b).

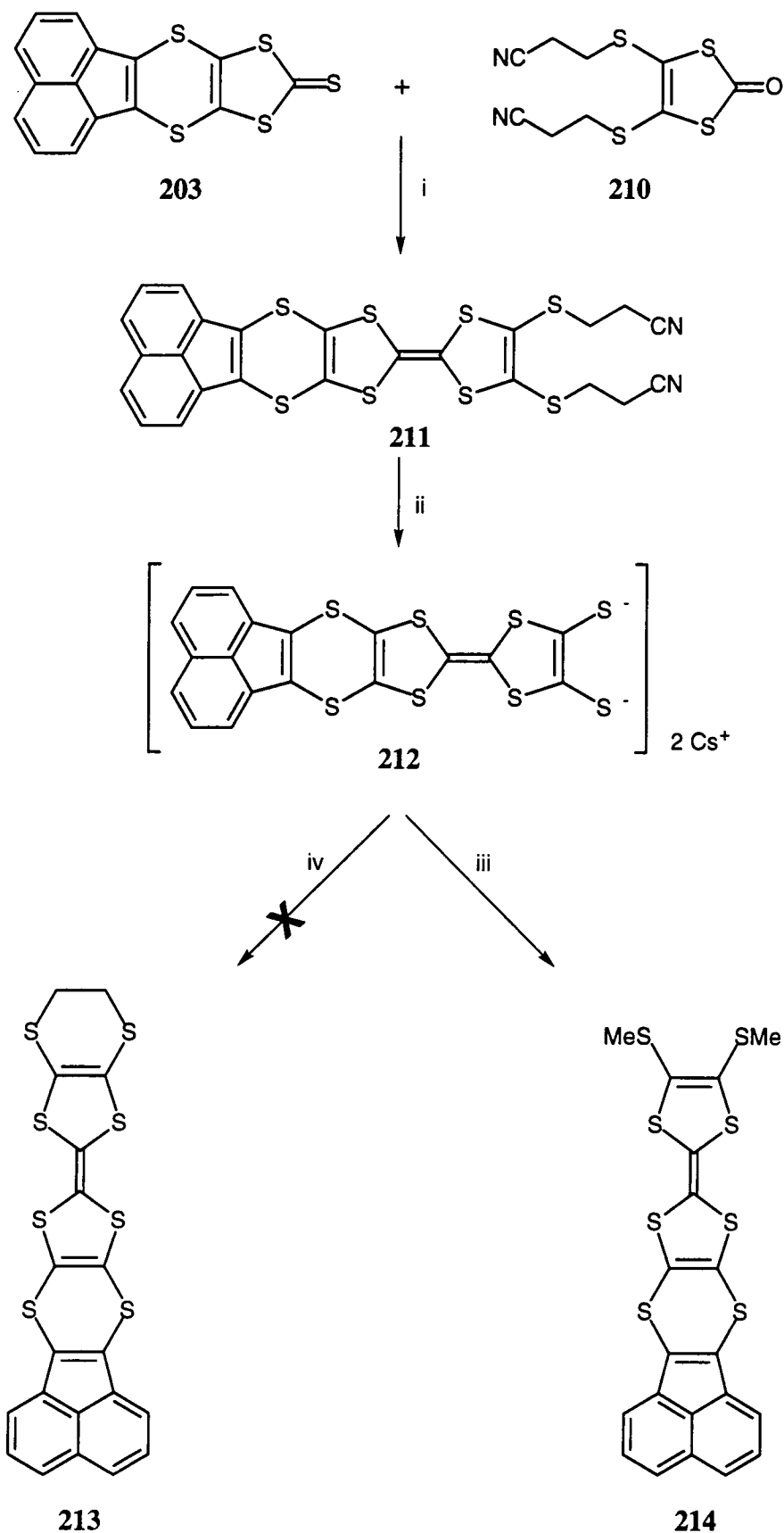

Scheme 4.9 Reagents and conditions. i, P(OEt)₃, reflux, 15h, 17%; ii, 2CsOH, THF / MeOH 5:1 v/v, 15min; iii, MeI, 96%; iv, BrCH₂CH₂Br, various conditions.

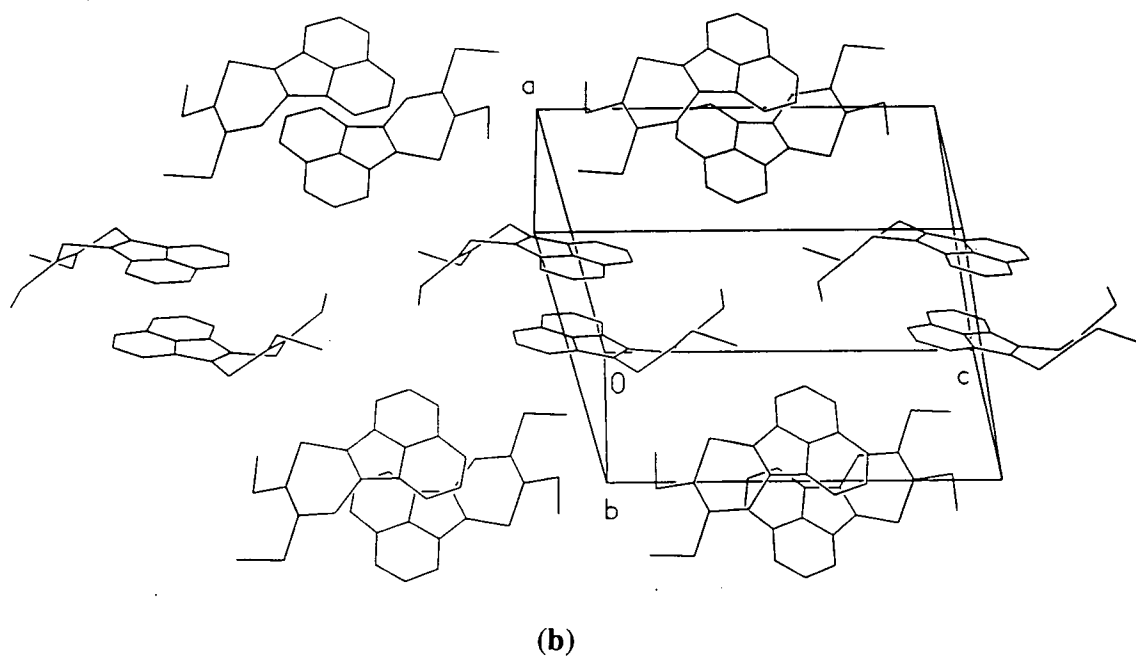
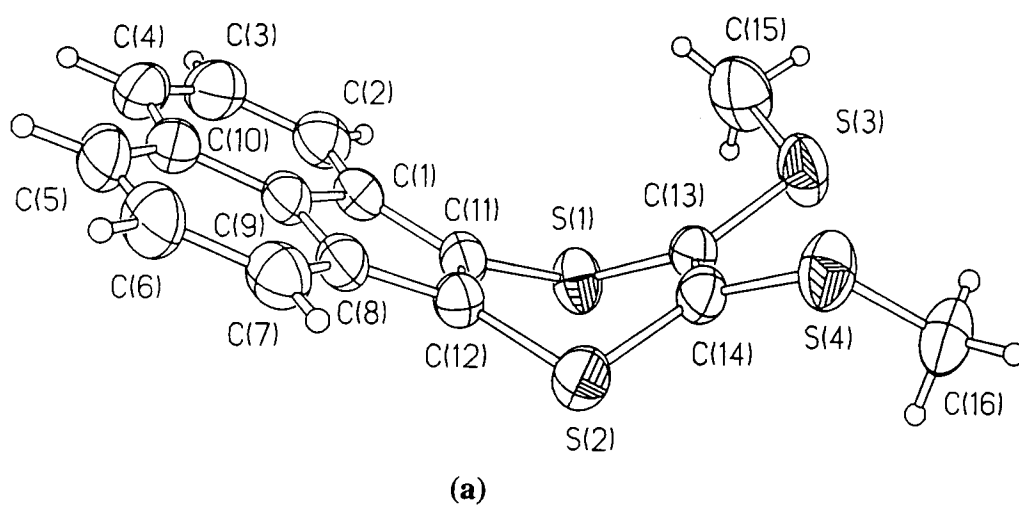
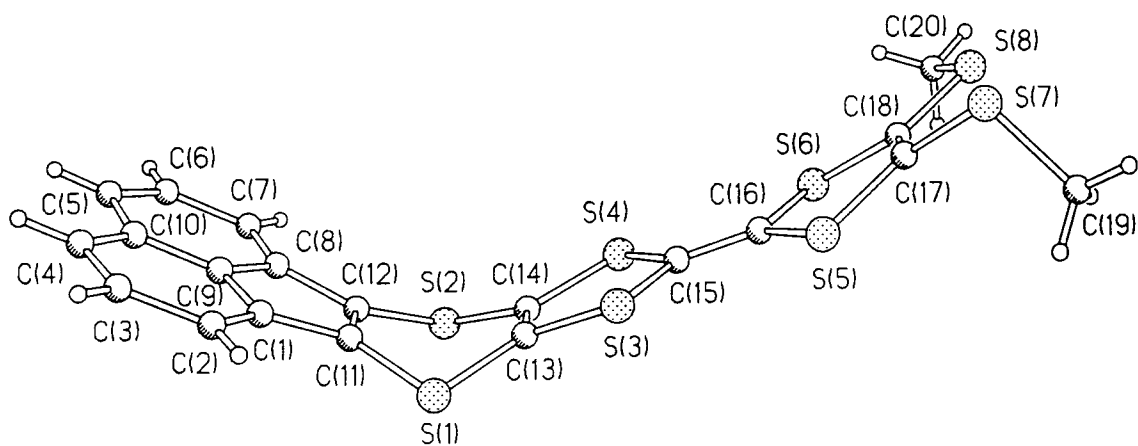
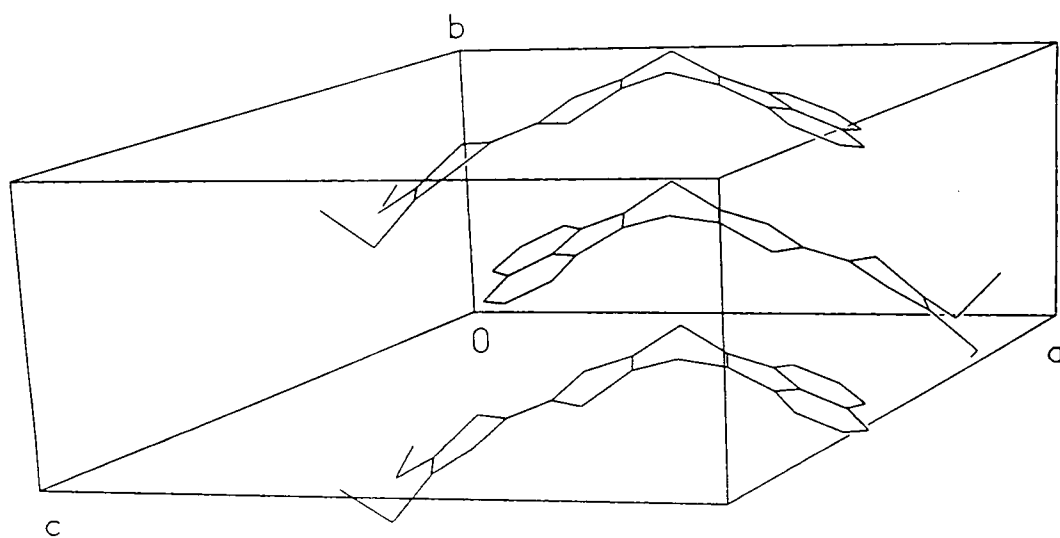

Figure 4.1 Crystal structure of compound **207**



(a)



(b)

Figure 4.2 Crystal structure of compound 214

4.2.2 ELECTROCHEMICAL STUDIES OF **207** AND **214**

The electrochemical redox properties of the donors **207** and **214** were studied by cyclic voltammetry. The cyclic voltammogram of donor **207** showed two, reversible one-electron oxidation waves to form the radical cation species **207**^{+•} and the dication species **207**²⁺, respectively ($E_1^{1/2} = +0.75$ V and $E_2^{1/2} = +1.07$ V). Thus donor **207** is initially slightly harder to oxidise than the parent system **117** ($E_1^{1/2} = +0.68$ V)¹⁰⁰ but where as that compound showed an *irreversible* second oxidation potential ($E_2^{1/2} = +1.42$ V) donor **207** shows a second *reversible* wave at much lower potential. This may be due to the cation stabilising effect of the -SMe substituents

The cyclic voltammogram of the TTF based donor **214** showed two, reversible one-electron oxidation waves to form the radical cation species **214**^{+•} and the dication species **214**²⁺, respectively ($E_1^{1/2} = +0.48$ V and $E_2^{1/2} = +0.74$ V), which is typical of the TTF system (TTF; $E_1^{1/2} = +0.34$ V and $E_2^{1/2} = +0.71$ V). An irreversible third oxidation wave was also observed ($E_3^{ox} = +1.38$ V).

4.2.3 SALTS OF DONORS **207** AND **214**

Donor **207** formed crystalline 1:1 charge-transfer complexes with both TCNQ and Br₂TCNQ and a crystalline radical cation salt with I₇⁻. Both the **207**:TCNQ and **207**:Br₂TCNQ salts were electrical insulators (two-probe compressed pellet method),¹²⁴ the **207**:(I₂)₂I₃⁻ salt showed a very low conductance (< 10⁻⁸ Scm⁻¹).

Single crystal X-ray diffraction studies of these salts have been performed.

The structural motif of **207**(TCNQ) is a mixed stack of **207** and TCNQ molecules (Fig. 4.3a). Both lie on a crystallographic mirror plane, passing in the donor through the C(5), C(6) atoms and the midpoints of the C(7)-C(7') and C(8)-C(8') bonds, and in the TCNQ through the midpoints of the C(11)-C(11') and C(12)-C(12') bonds. The donor molecule is folded by 54.6°, in the same way as in pure **207**, so that only its acenaphtho part is actually participating in the stack (Fig. 4.3b). This moiety and the two adjacent TCNQ molecules are parallel within 5.4°, mean interplanar separations between them are 3.26 and 3.44 Å.

The structure of **207**(Br₂TCNQ) also contains mixed stacks, running parallel to the crystal axis *a*, and comprising folded **207** (or rather their acenaphtho moieties) and Br₂TCNQ (Fig. 4.4a,b). However, the relative orientations between donor and acceptor in a stack are quite different from **207**(TCNQ). In **207**(Br₂TCNQ), the principal axis of the TCNQ (i.e. the C(07)...C(08) vector) and the (local) *m* plain of the donor molecule along the S(1)...S(2) vector is nearly the same (48.1°), besides this, the

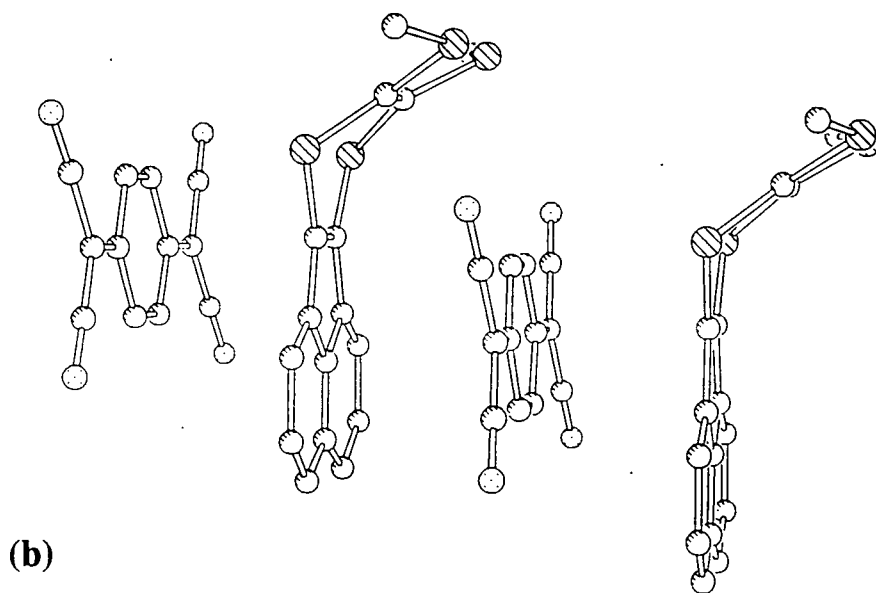
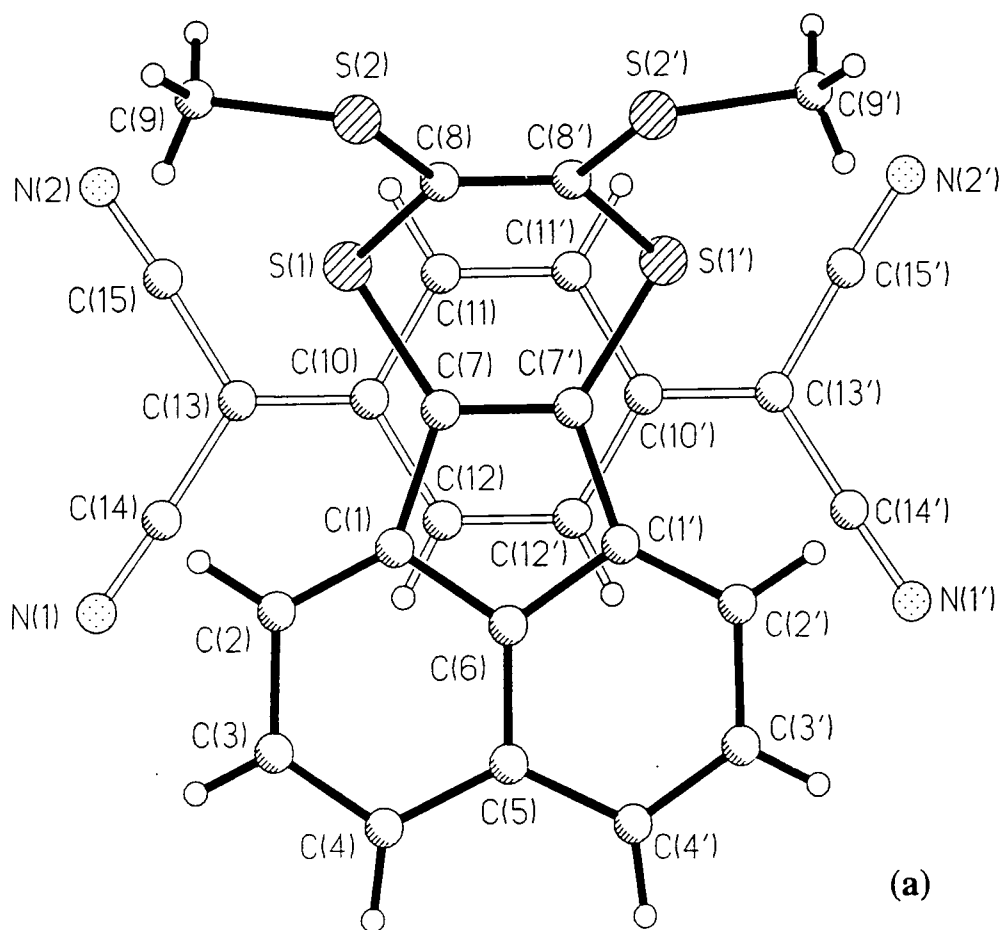

Figure 4.3 Crystal structure of complex **207**:TCNQ

S(3)-C(15) and S(4)-C(16) bonds are tilted out of the S(1)C(13)C(14)S(2) plane by ca. 6°. The Br₂TCNQ molecule is planar within ±0.03 Å but for the C(71)N(71) and C(81)N(81) cyano groups, tilted out of the plane by 7.6 and 9.0°. The acenaphtho moiety and two adjacent TCNQ planes in a stack are parallel within 2.4°, with interplanar separations of 3.27 and 3.36 Å.

The bond distances (see Appendix 3) in the acenaphtho systems in **207**(TCNQ) and **20**(Br₂TCNQ) show small (in fact, on the limits of statistical significance) perturbation compared with pure **207**, which can be attributed to charge transfer.

The asymmetric unit of **207**(I₇⁻) comprises one cation of [207]⁺, two I₂ molecules and one I₃⁻ anion (Fig. 4.5a). The cation, in contrast with the structures of **207**, **207**(TCNQ) and **207**(Br₂TCNQ), has all non-H atoms nearly coplanar, with the biggest deviation of 0.1 Å and the average one of 0.05 Å. The dithiine ring shows a minor boat-like distortion, S(1) and S(2) deviating by 0.06 and 0.08 Å from the plane of the four carbon atoms. The bond distances in the ring change (Appendix 3) from the pattern of localised C=C and single C-S bonds to a substantially conjugated one. The cations, nearly parallel to the crystallographic (1 $\bar{1}$ 0) plane, form a stepwise stack, parallel to the *b* axis (Fig. 4.5 b).

Iodine species form an infinite zig-zag chain, running in the general direction of the *c* axis, i.e. normal to the stacks (Fig. 4.5c). The intermolecular I...I contacts are linear with respect to the I₂ molecules but normal to the anion. The latter has a usual linear configuration.

4.3 OTHER 1,4-DITHIINS FROM OLIGO(1,3-DITHIOLE-2,4,5-TRITHIONE)

As outlined in sections 4.1 and 4.2, when oligo(1,3-dithiole-2,4,5-trithione) **2** is reacted with alkynes or alkenes followed by dehydrogenation the product is a substituted derivative of type **215**. These 1,3-dithiole-2-thione compounds may be converted to the 1,3-dithiole-2-ketone derivatives **216** by reaction with mercuric acetate, and these compounds may be self coupled in hot triethylphosphite to give the 1,4-dithiin containing tetrathiafulvalene derivatives of type **217**.

Other workers have synthesised compounds of type **217** by employing other entirely different methods, where R= H, Me, SMe and SeMe.¹⁵⁶

Donors of type **217** have 1,4-dithiin rings whose sulfur atoms may participate in S---S interactions in the solid state. The π orbitals in the peripheral double bond may exhibit π---π interactions with other molecules in the solid state.

We have investigated the reaction of **189** with various dieneophiles in the hope of synthesising compounds of type **217** which would show good π-electron donor properties and interesting charge-transfer / radical-cation salts.

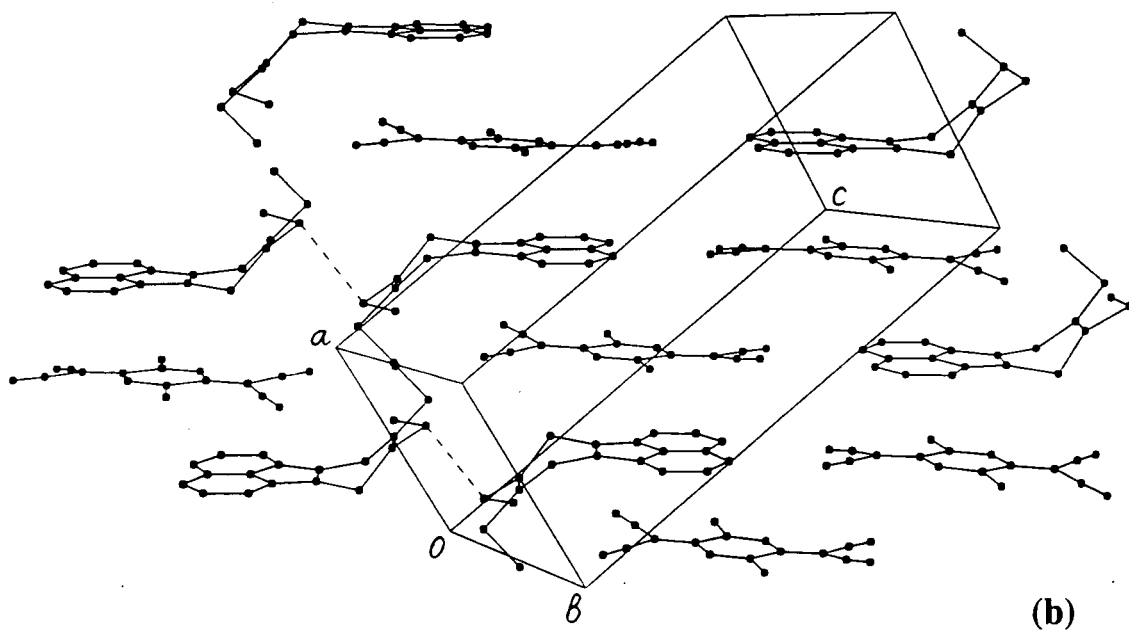
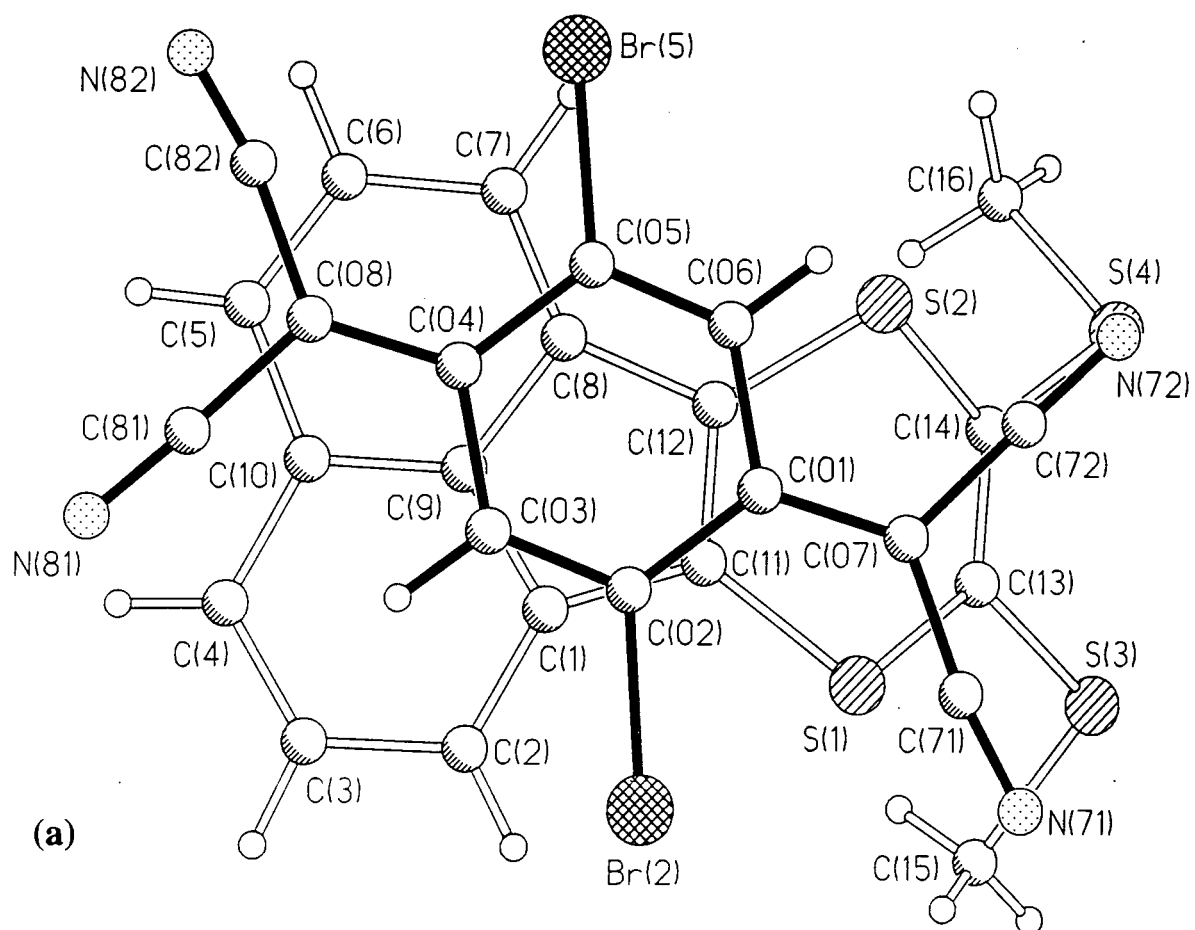

Figure 4.4 Crystal structure of complex 207:Br₂TCNQ

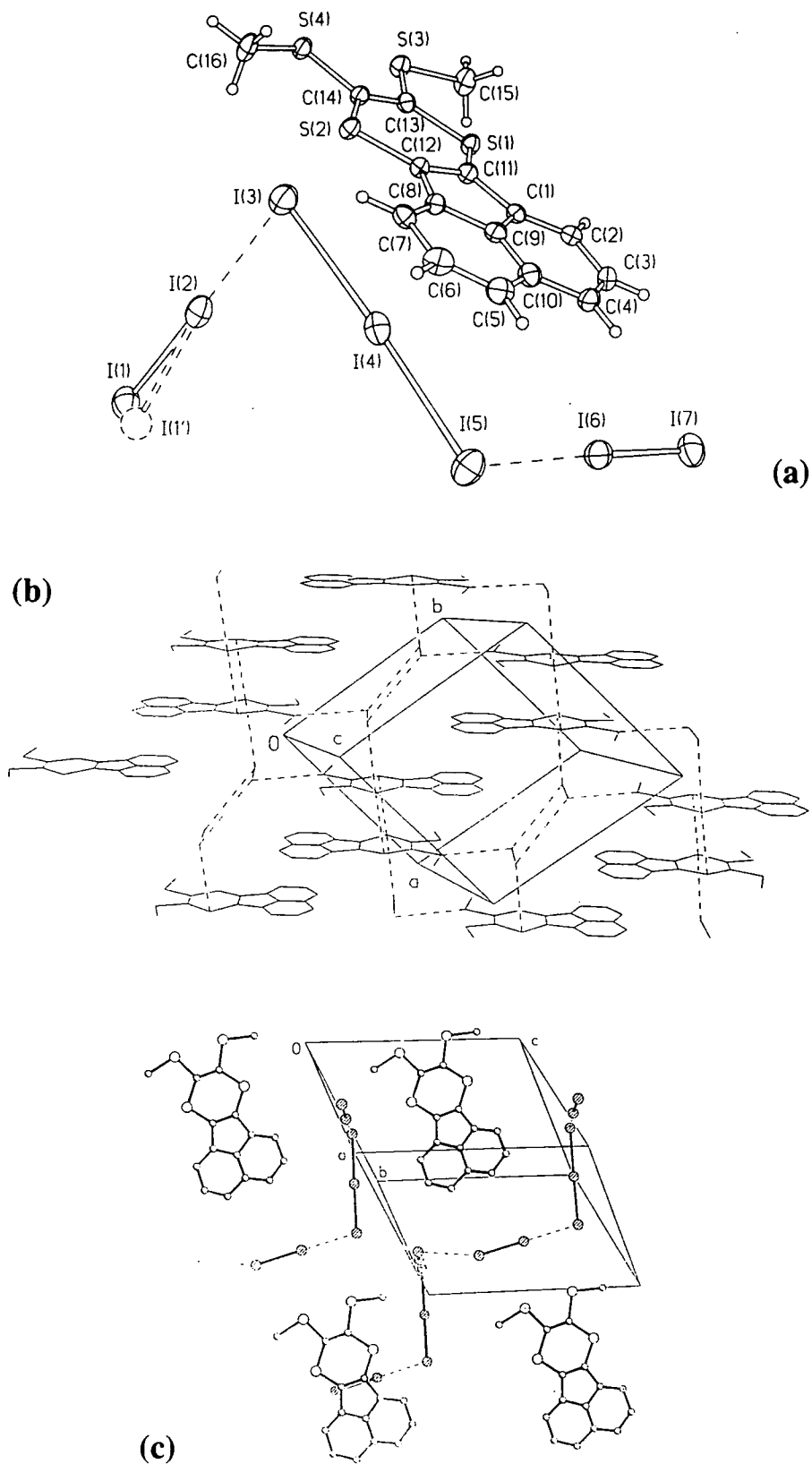
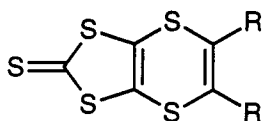
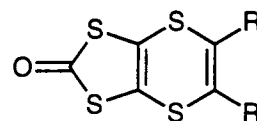

Figure 4.5 Crystal structure of complex **207**:I⁻



215



216

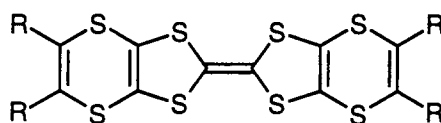

217

When compound **189** is heated in toluene with bis-(trimethylsilyl)acetylene a cycloaddition occurs and compound **218** is isolated in 65% yield (Scheme 4.10). Compound **218** was dissolved in THF and treated with a solution of tetrabutylammonium fluoride to give compound **219**. 4,5-(Vinylenedithio)-1,3-dithiole-2-thione (**219**) is a known compound^{156a} but this new synthetic route is simpler and more expedient. We initially aimed to replace the silyl groups in compound **218** with iodine, thus facilitating substitution reactions by nucleophilic species to generate new compounds. We tried many different reagents (ICl, TosCl / CsF, 2CF₃(CF₂)CF₂I / TBAF, *N*-iodosuccinimide) with many different conditions (temperatures: -78°C, 0°C, 20°C, solvents: THF, DCM, DMF) to effect this transformation, but all failed to give the desired product **220** (Scheme 4.10).

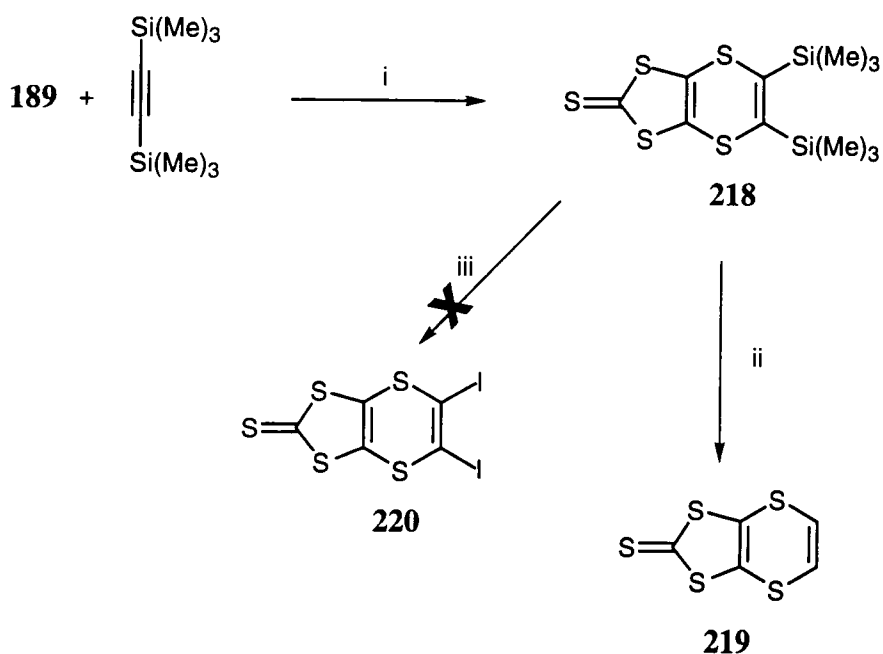

Scheme 4.10 Reagents and conditions. i, Toluene, 90°C, 4h, 65%; ii, 2 TBAF, THF, 20°C, 0.5h, ; iii, various reagents and conditions.

Many interesting multi-redox systems have been synthesised by incorporating ferrocene moieties into a TTF system.¹⁵⁷ We aimed to synthesise the novel tetraferrocene substituted system **224** (Scheme 4.11) by using a cycloaddition reaction between compound **189** and bis-ferrocenyl ethylene **221** (mixture of *cis* and *trans* isomers).¹⁵⁸ Compound **189** was refluxed in toluene with compound **221** to give compound **222**, as a mixture of stereoisomers, in 32% yield. Compound **222** was then refluxed in toluene with DDQ to yield the dehydrogenated product **223** (38%). The attempted self-coupling of compound **223** in hot triethylphosphite to generate compound **224** failed. Other coupling procedures have not yet been attempted.

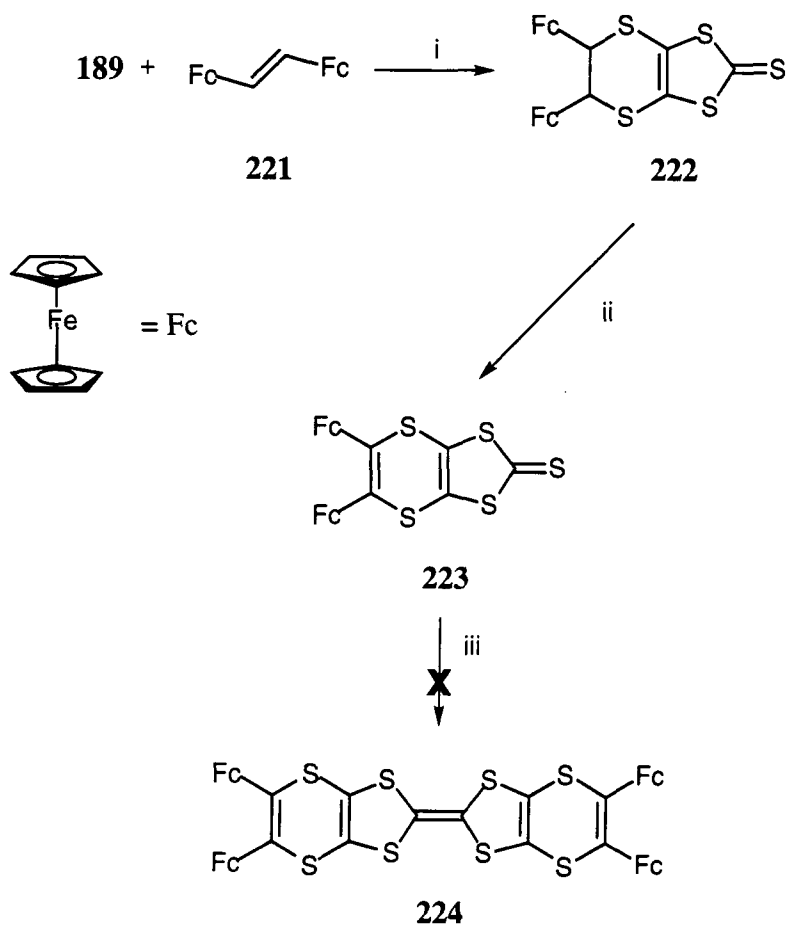

Scheme 4.11 Reagents and conditions. i, Toluene, reflux, 1.5h, 32%; ii, DDQ, Toluene, reflux, 1h, 38%; iii, $P(EtO)_3$, reflux.

A tactic which has been employed in the synthesis of novel TTF systems with useful properties, is that of incorporating annelated heterocycles *eg.* thiophene, selenophene and pyrrole units (**225**, **226** and **227**).¹⁵⁹ The thinking behind this approach is the same as that for compounds of type **217**, namely, that peripheral heteroatoms and π -orbitals may interact together within the solid state packing of any salt and form a

network of close contacts. We attempted to incorporate both these ideas by synthesising compounds **228-230** which exhibit a 1,4-dithiin ring and a 5-membered heterocycle on each side of the TTF core.

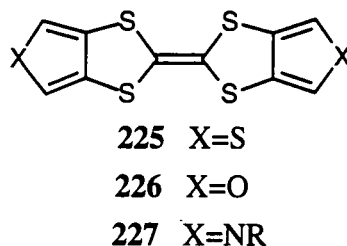

We heated compound **189** in refluxing toluene with the diketone **231**¹⁶⁰ to obtain compound **232** in 85% yield (Scheme 4.12). It was anticipated that we could apply the Paal / Knorr¹⁶¹ methodology to this 1,4-diketone and thus synthesise compounds **233**, **234** and **235**. But unfortunately this methodology failed to give the desired products. We suspect that the heat necessary to perform the Paal / Knorr heterocycle forming reactions caused the decomposition of compound **232**, possibly via a retro Diels-Alder reaction, (t.l.c. evidence)

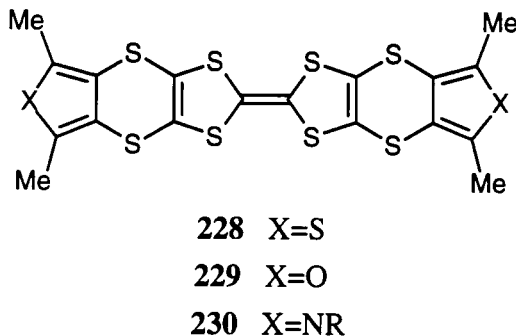

4.4 CONCLUSIONS

The oligomeric compound **189** has been utilised in a range of syntheses, including those of the organic electron donor compounds **207** and **214**. Electrically Insulating TCNQ and Br₂TCNQ charge-transfer and I₇ radical-cation salts of **207** have been synthesised and analysed by X-ray diffraction.

Compound **189** shows much promise for use in the synthesis of 2,3-dithio substituted 1,4-dithiin compounds.

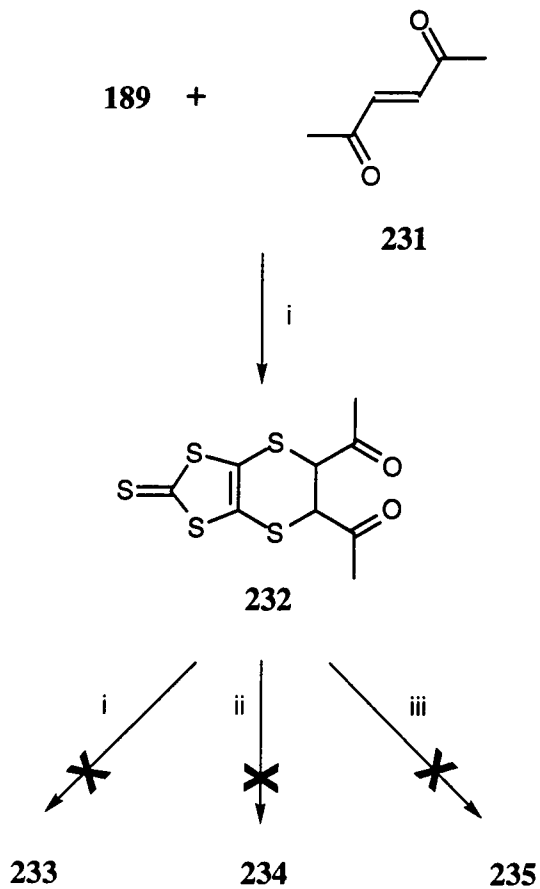

Scheme 4.12 *Reagents and Conditions.* i, Toluene, reflux, 2h, 85%; i, P₄S₁₀ or Lawesson's reagent, Toluene, heat; ii, P₂O₅ or H₂SO₄, Toluene, heat; iii) NH₃ or MeNH₂, Toluene, heat.

Chapter Five

Experimental Procedures and Analytical Data

5.1 GENERAL PROCEDURES

Melting points were recorded on a Reichert-Kofler hot stage microscope apparatus and are uncorrected.

Infra-red spectra were obtained on a Perkin-Elmer 1720 FT-IR spectrophotometer operating a Gramms 1600 program, with samples embedded in KBr discs.

Proton NMR spectra were recorded on Varian Gemini-200, XL-200 or Varian VXR-200 spectrometer operating at 199.9 MHz. ¹³C NMR spectra were recorded on a Varian-400 spectrometer operating at 100.582 MHz. Chemical shifts are quoted in parts per million (ppm) relative to tetramethylsilane an internal reference (0 ppm), *J* values are given in Hz.

Mass spectra were recorded on a VG7070E instrument with ionising modes as indicated; ammonia was used as impinging gas in chemical ionisation mode. Molecular ion and major peaks are reported

Elemental analyses were obtained on a Carlo-Erba Strumentazione instrument.

UV-VIS spectra were recorded using a Kontron instruments UVIKO 930 spectrophotometer with 1cm quartz cells.

Column chromatography was carried out using either Merck or Prolabo silica gel (70-230 mesh) or Merck alumina (activity I to III 70-230 mesh); the latter was neutralised by pre-soaking basic alumina in ethyl acetate for 24 h.. Solvents were distilled prior to use for chromatography, with the exception of dichloromethane, trichloromethane and tetrachloromethane which were used as supplied. All reactions which were performed under an inert atmosphere used gas (nitrogen or argon) which was pre-dried by passing over a column of phosphorus pentoxide.

Reaction solvents were dried over, and distilled from, the following reagents under an inert atmosphere. Diethyl ether, tetrahydrofuran and toluene (sodium metal / benzophenone), acetonitrile, dichloromethane and benzene (calcium hydride), acetone (potassium carbonate), methanol (magnesium methoxide) triethylamine (3 Å molecular sieves). All other reagents were reagent grade and used without further purification.

Cyclic voltammetry experiments were performed in a one-compartment cell with platinum working and counter electrodes. The reference electrode was Ag/Ag⁺, internal resistance (iR) compensation was used in each case and values were corrected versus ferrocene/ferrocenium⁺ as $E^{1/2} = +3.6V$ (SCE). Electrochemical measurements were carried out using a BAS 50 electrochemical analyser and were compensated for internal resistance. The cell concentrations consisted of test compound ($1 \times 10^{-5}M$) with dry tetrabutylammonium perchlorate as supporting electrolyte ($1 \times 10^{-1}M$) in dry acetonitrile (*ca.* 15 ml). The sweep rate = 200 mV/s except for compound **207** where the

sweep rate = 100mV/S. All solutions were purged with argon prior to measurements being taken. Figures 5.1 and 5.2 show cyclic voltamograms of compounds 137 and 214 respectively, and are included to illustrate typical experiments of this type performed in the course of this study.

Two-probe compressed pellet d.c. conductivity measurements were performed using the procedure and equipment described in reference 124. The cross-sectional area of our samples $a = 0.0137 \text{ cm}^2$ and the width l was typically = 0.5 mm.

DDQ = 2,3-Dichloro-5,6-Dicyano-1,4-Benzoquinone

THF = Tetrahydrofuran

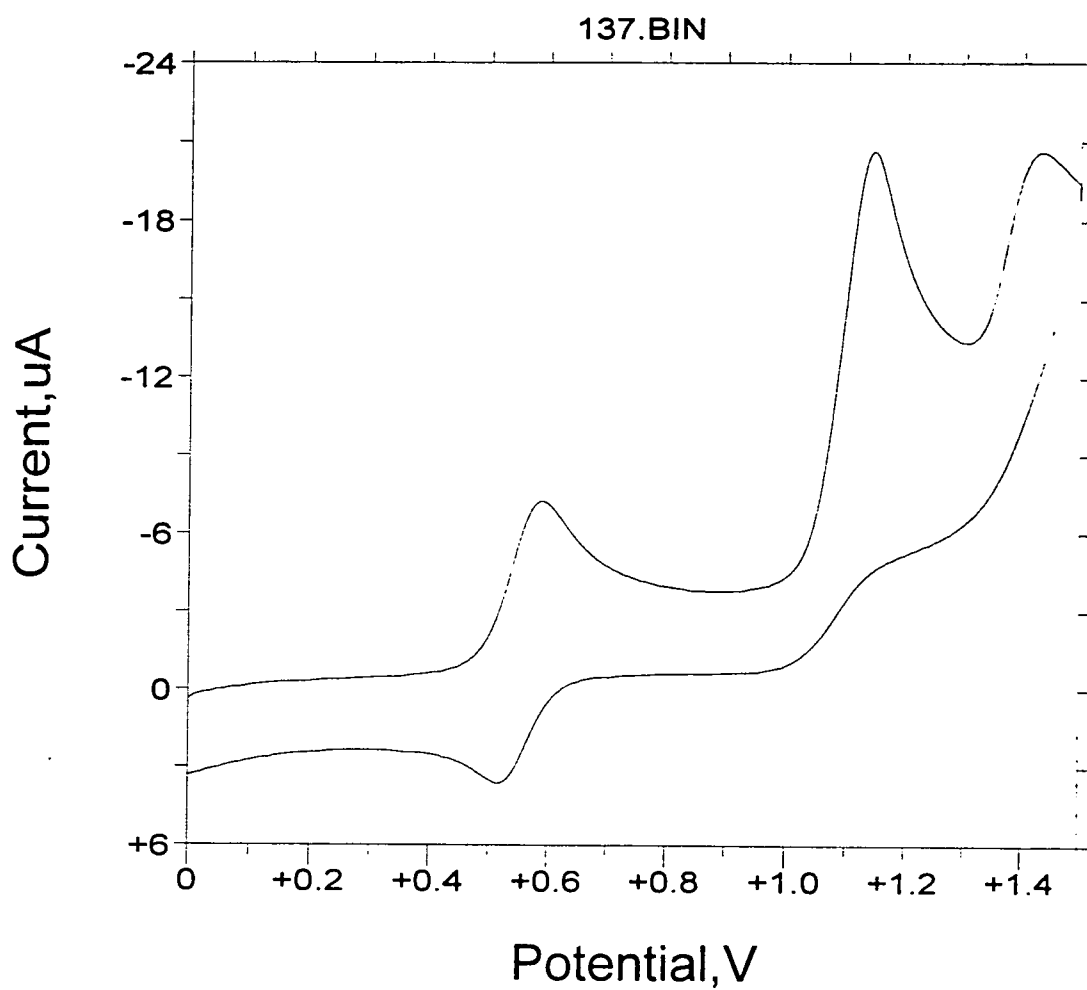

22-Sep-97

14:56:56

Mode: CV

Compound 137

Init E (mV) = 0

High E (mV) = 1500

Low E (mV) = 0

Init P/N = P

V (mV/s) = 200

Sweep Segments = 2

Smpl Int (mV) = 1

Quiet T (s) = 2

Sens (A/V) = $1\text{E-}5$

Segment 1:

Ep (mV) = +589

ip (A) = $-6.4537\text{E-}6$

Ep (mV) = +1146

ip (A) = $-1.6803\text{E-}5$

Ep (mV) = +1431

ip (A) = $-7.2248\text{E-}6$

Segment 2:

Ep (mV) = +520

ip (A) = $+3.9906\text{E-}6$

Figure 5.1 Cyclic voltametric study of compound 137

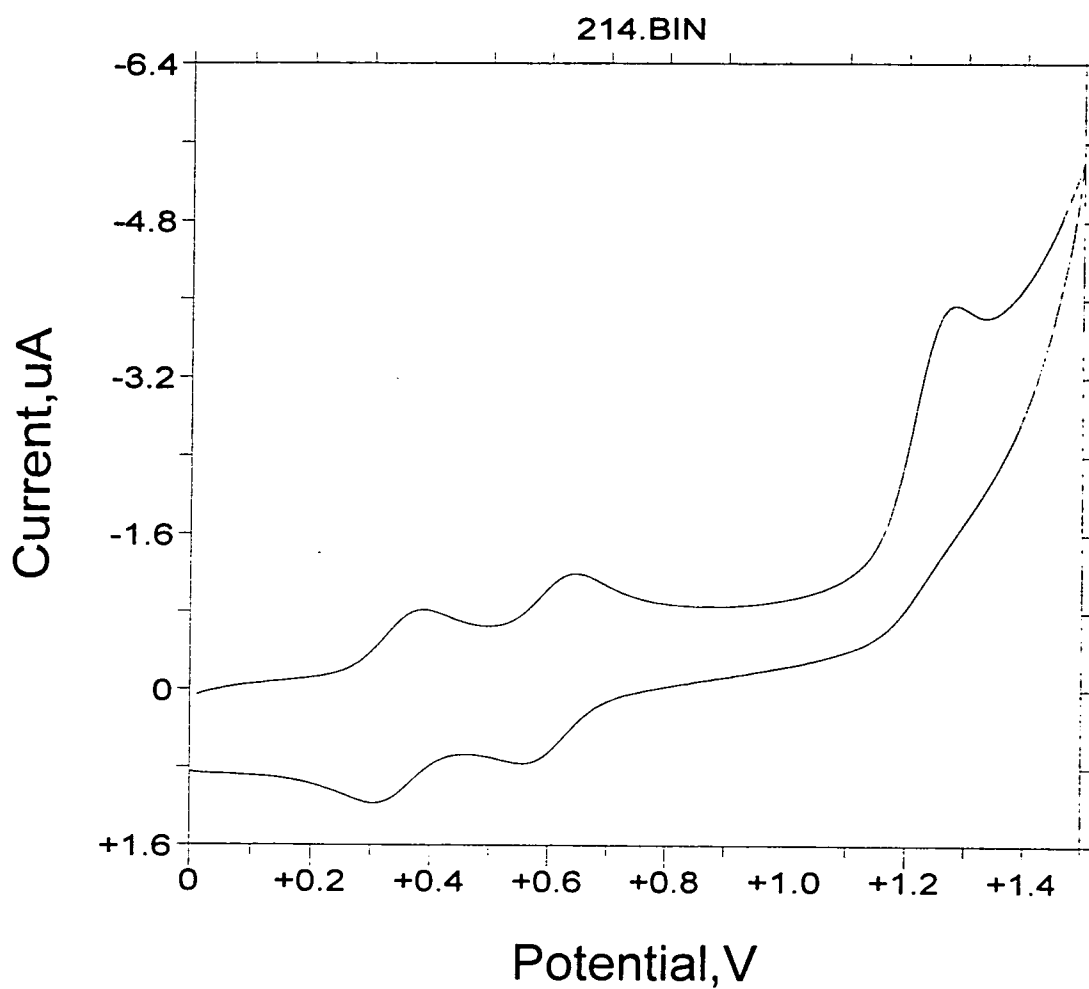

13-Aug-97

15:07:58

Mode: CV

214.BIN

Init E (mV) = 0

High E (mV) = 1500

Low E (mV) = 0

Init P/N = P

V (mV/s) = 100

Sweep Segments = 2

Smpl Int (mV) = 10

Quiet T (s) = 2

Sens (A/V) = 1E-6

Segment 1:

Ep (mV) = +380

ip (A) = -5.5517E-7

Ep (mV) = +650

ip (A) = -5.4500E-7

Segment 2:

Ep (mV) = +310

ip (A) = +5.0005E-7

Figure 5.2 Cyclic voltametric study of compound 214

5.2 EXPERIMENTAL PROCEDURES FOR CHAPTER 2

5.2.1 EXPERIMENTAL FOR SECTION 2.1.2

Acenaphtho[1,2-b][1,4]dithiin (117)

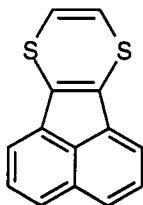

This compound was prepared by the literature method¹⁰⁰ from **121** (1.0 g, 4 mmol). For a successful reaction it was essential that the DDQ was recrystallised from hot benzene and dried under vacuum prior to use. The product **117** (0.27 g, 28%) was obtained as a purple solid, m.p. 91-93°C (Lit¹⁰⁰ 92 - 94°C).

1-Acenaphthanone (119)

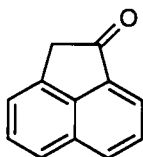

1-Acenaphthanol **118** (25 g, 148 mmoles) was suspended in a mixture of ethanol / dichloromethane (1:1 v/v) (200 ml) and stirred at 0°C. Chromic acid (0.66 M, 150 ml) was added dropwise over 10 min, after which the mixture was stirred for a further 5 min. The aqueous layer was removed and washed with dichloromethane (2 x 100 ml). The organic layers were combined and washed with 10% aqueous sodium- bicarbonate solution (2 x 50 ml) and water (100 ml) and then dried (magnesium sulphate). Removal of the solvent *in vacuo* gave **119** (20.12 g, 81%) as a white solid, m.p. 115-117°C (lit.¹⁷⁰ 119°C).

Acenaphthenone ethylenedithioactal (120)

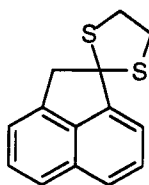

To a solution of ketone **119** (4.05 g, 23.78 mmoles) in benzene (200 ml) was added ethanedithiol (2.4 ml, 28.67 mmoles) and a catalytic quantity of *p*-toluene-sulphonic acid. A Dean-Stark trap was fitted and the mixture refluxed for 12 h, during which time the solution turned orange. The mixture was diluted with dichloromethane (200 ml), washed with water (100 ml) and dried (magnesium sulphate). Removal of the solvent *in vacuo* afforded **120** m.p. 54-55°C (lit¹⁰⁰; 57-58°C) which was pure enough for use in the next reaction.

1,2-Ethylenedithioacenaphthylene (121)

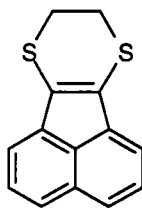

Dithioacetal **120** (5.8 g, 23.80 mmol) was dissolved in dichloromethane (200 ml) under an argon atmosphere with stirring, and tellurium tetrachloride (7.7 g, 28.52 mmol) was added portionwise over 5 mins. After 30 min at room temperature, a black precipitate was observed which was removed by filtration. The solution was washed with saturated aqueous sodium bicarbonate solution (2 x 50 ml) and water (2 x 50 ml). The organic layer was dried (magnesium sulphate) and the solvent removed *in vacuo* to afford a brown residue. Column chromatography [silica, cyclohexane/dichloromethane (1:1 v/v)] and recrystallisation from hexane, gave **121** as a red crystalline solid (2.5 g, 45% based on **119**); m.p. 130-132°C (lit¹⁰⁰ 135-137°C); the ¹H NMR spectrum was identical with the literature.¹⁰⁰

Spiro[1,2-dihydroacenaphthylene-1,2'-(1',3'-dithiolane)-2-one] (126)

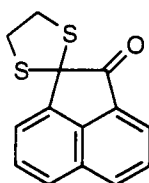

To a suspension of acenaphthenequinone **125** (5.0 g, 27.5 mmol) in benzene (200 ml) was added ethanedithiol (2.3 ml, 27.4 mmol) and a catalytic quantity of *p*-toluenesulphonic acid. The mixture was refluxed under Dean-Stark conditions for 2 h during which time the solid dissolved. The mixture was cooled and the solvent removed *in vacuo* to afford a brown waxy solid, repeated recrystallisation of which from methanol afforded **126** as colourless needles, (5.15 g, 73%) m.p. 141-145°C (from methanol); (Found: C, 65.1; H, 3.8; C₁₄H₁₀OS₂ requires C, 65.1; H, 3.9%); ν_{\max} (KBr)/cm⁻¹ 2929, 1712 (C=O), 1001, 970, 829, 775, 541; δ_{H} (CDCl₃) 8.10 (1 H, d, *J* = 7.3, Ar-*H*), 8.00 (1 H, d, *J* = 7.5, Ar-*H*), 7.80-7.65 (4 H, m, Ar-*H*), 4.04-3.89 (2 H, m, SCHHCHHS) and 3.82-3.67 (2 H, m, SCH \dot{H} CHHS); *m/z*: (EI) 258 (M⁺, 40%), 230 (100).

Spiro[1,2-dihydroacenaphthylene-1,2'-(1',3'-dithiolane)-2-hydrazone] (127)

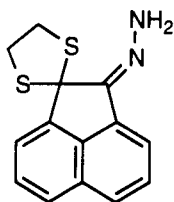

To a solution of compound **126** (3.0 g, 11.6 mmol) in methanol (75 ml) was added hydrazine hydrate (15 ml of 85% aqueous solution) and the resultant mixture was refluxed overnight, cooled and filtered to afford compound **127** (1.75 g, 55%) as colourless prisms, m.p. 188-191 °C (from methanol); (Found: C, 61.4; H, 4.4; N, 10.0. C₁₄H₁₂N₂S₂ requires C, 61.7; H, 4.44 N, 10.3 %); ν_{\max} (KBr)/cm⁻¹ 1489, 1416, 809, 773, 717, 673, 581, 546; δ_{H} [(CD₃)₂CO] 8.27 (1 H, d, *J* = 7.2, Ar-*H*), 8.00

(1 H, d, $J = 8.4$, Ar- H), 7.95 (1 H, d, $J = 7.2$, Ar- H), 7.92 (1 H, d, $J = 8$, Ar- H), 7.70 (2 H, m, Ar- H), 6.02 (2 H, br s, NH_2), 4.15 (2 H, m, $SCHHCHHS$) and 3.90 (2 H, m, $SCHHCHHS$); m/z (EI) 272 (M^+ , 40%); 196 (100).

1,2-Ethylenedithioacenaphthylene (121): Alternative Synthesis.

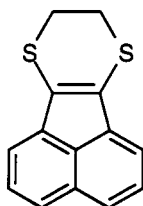

A mixture of compound **127** (0.5 g, 1.8 mmol) and activated manganese dioxide (1.6 g, 18 mmol) in ether (200 ml) was treated with saturated ethanolic potassium hydroxide (0.13 ml) and stirred for 1 h at 20°C. Filtration afforded a pale red/purple filtrate which was shaken with 2 M aqueous hydrochloric acid (2 cm³), whereupon the solution turned bright red. This solution was washed with water (2 x 50 cm³), dried (magnesium sulphate) and the solvent removed *in vacuo* to yield a red oil which was purified by chromatography (silica, hexane/dichloromethane, 1:1 v/v) to afford compound **121** (0.31 g, 71%) whose m.p. and ¹H NMR spectrum were identical to a sample of **121** synthesised from **119**, as described above.

5.2.2 EXPERIMENTAL FOR SECTION 2.2.2

1-Methylsulfonyl-2-[1-(1-propynyl)sulfanyl]-acenaphthylene (134a)

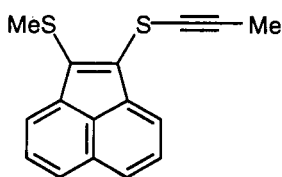

Compound **117** (0.05 g, 0.21 mmoles) was dissolved in dry THF (50 ml) under argon and stirred at room temperature. ⁿBuLi (1.6 M, 0.3 ml, 0.48 mmoles) was slowly syringed into the solution, the colour of which changed from purple to red during 15 min. Methyl iodide (0.1 ml, 0.84 mmoles) was added and the solution stirred for 30 min, whereupon hydrochloric acid (0.5 M, 50 ml) was added and the mixture washed with water (3 x 25 ml), dried (magnesium sulphate) and the solvent removed *in vacuo*. The resulting residue was chromatographed [silica, dichloromethane] to afford **134a** as a yellow oil (21 mg, 38%); ν_{max} (KBr)/cm⁻¹ 2250, 1430, 1245, 1039, 908, 734, 651; δ_H (CDCl₃) 8.10-8.30 (1H, m, Ar- H), 7.70-7.80 (2H, m, Ar- H), 7.50-7.60 (4H, m), 2.62 (3H, s, $CCSCH_3$) and 2.02 (3H, s, $-SCH_3$); δ_C (CDCl₃) 15.03, 26.14, 80.11, 84.29, 123.81, 123.92, 125.82, 127.91, 128.13, 128.54, 128.72, 129.02, 129.68, 133.40, 135.63 and 137.40.

1-Carboethoxysulfanyl-2-[2-carboethoxy-1-ethynylsulfanyl]-acenaphthylene (134b)

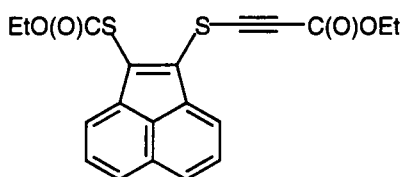

This compound was prepared as described for **134a** using ethylchloroformate (0.1 ml, 0.84 mmoles). The residue was chromatographed [silica, hexane / dichloromethane (4:1 v/v)] to afford **134b** as a yellow oil (48 mg, 65%); ν_{\max} (KBr)/ cm^{-1} 2253, 2154, 1702, 1426, 1242, 1034, 911, 728, 651; δ_{H} (CDCl_3) 8.25-8.40 (1H, m, Ar-H), 7.5-8.0 (6H, m, Ar-H), 4.2-4.4 (4H, m, $\text{C(O)CH}_2\text{CH}_3$) and 1.3-1.4 (6H, m, $\text{C(O)CH}_2\text{CH}_3$); δ_{C} (CDCl_3) 14.06, 14.25, 61.98, 64.88, 79.67, 88.09, 123.81, 124.92, 125.62, 127.91, 128.03, 128.34, 128.74, 129.12, 129.68, 135.50, 136.27, 137.40, 152.72 and 166.73 ; m/z (EI) 384 (M^+ , 20%), 239 (100).

5.2.3 EXPERIMENTAL FOR SECTION 2.2.3

Acenaphthenone benzenedithioacetal (136)

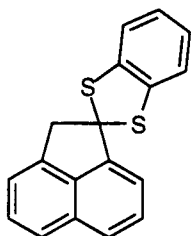

To a solution of acenaphthone **119** in benzene (125 ml), was added benzenedithiol (1 g, 7.0 mmoles) and a catalytic amount of *p*-toluene-sulphonic acid. A Dean-Stark trap was placed on the flask and the mixture refluxed under argon for 2 days. The benzene was removed under reduced pressure, but due to the malodorous nature of the product mixture, the residue containing **136** was used crude in the subsequent reaction.

7,12-Dithia-benzo[k]fluoranthene (137)

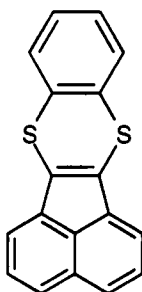

Crude compound **136** (4.0 g, 13.7 mmoles) was dissolved in dichloromethane (200 ml) and stirred under argon. Tellurium tetrachloride (3.8 g, 14.1 mmoles) was added portionwise, and the solution turned dark brown. After 2 h at 20°C, aqueous sodium bicarbonate solution (50 ml) was added and the mixture filtered through celite. The organic layer was separated and washed with water (3 x 50 ml), dried (magnesium sulphate) and the solvent removed *in vacuo* to afford a brown oil which was chromatographed [silica, hexane/dichloromethane (5:1 v/v)] to yield **137** as red crystals. (0.53 g, 13%). m.p. 117-120°C; (Found: C, 74.3; H, 3.1. $\text{C}_{18}\text{H}_{10}\text{S}_2$ requires C, 74.45; H, 3.5 %); λ_{\max}

(dichloromethane)/nm ($\epsilon/\text{dm}^3 \text{ mol}^{-1} \text{ cm}^{-1}$) 316 (9300), 332 (9800), 347 (10900) and 481 (500); δ_{H} (CDCl_3) 7.15-7.25 (2H, m, Ar-H), 7.35-7.45 (2H, m, Ar-H) 7.45-7.55 (2H, m, Ar-H), 7.6-7.65 (2H, m, Ar-H) and 7.7-7.8 (2H, m, Ar-H); m/z (CI) 291 ($\text{M}^+ + \text{H}$, 100%)

Complex of 137 and TCNQ. A complex was prepared by mixing hot solutions of **137** (0.05 mmol) and TCNQ (0.05 mmol) each dissolved in anhydrous acetonitrile (15 ml) and filtering the solid which formed upon cooling. Analysis for 1:1 complex (Found: C, 73.1; H, 2.6; N, 11.4. $\text{C}_{30}\text{H}_{14}\text{N}_4\text{S}_2$ requires C, 72.9; H, 2.85; N 11.3 %); ν_{max} (KBr)/ cm^{-1} 2215.

Complex of 137 and 2,5-dibromo TCNQ. A complex was prepared by mixing hot solutions of **137** (0.05 mmol) and 2,5-dibromo TCNQ (0.05 mmol) each dissolved in anhydrous acetonitrile (10 ml) and filtering the solid which formed upon cooling. Analysis for 1:1 complex (Found: C, 54.7; H, 1.9; N, 8.0. $\text{C}_{30}\text{H}_{12}\text{N}_4\text{S}_2\text{Br}_2$ requires C, 55.2; H, 1.85; N 8.6 %); ν_{max} (KBr)/ cm^{-1} 2209.

Complex of 137 and I_4 . A complex was prepared by slow diffusion of I_2 vapour into a solution of **137** (10mg) in dry dichloromethane (5ml). Long, lustrous gold needles formed over a period of 4 days and were subsequently filtered and washed with a small amount of dichloromethane. Analysis for 1:4 complex (Found: C, 27.1; H, 1.2. $\text{C}_{18}\text{H}_{10}\text{I}_4\text{S}_2$ requires C, 27.1; H, 1.3 %).

7,11-Dithia-thiopheno(c)fluoranthene (141)

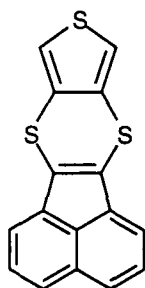

A solution of 3,4-dibromothiophene **138** (1.09g, 4.5 mmoles, 0.5 ml) in dry ether (30 ml) under argon, was cooled to -78°C and treated with $^n\text{BuLi}$ (1.6 M in hexanes, 4.5mmoles, 2.8 ml). After stirring at -78°C for 30 min, sulfur (144 mg, 4.5 mmoles) was added and stirring continued for a further 1 h. The above lithiation and sulfur addition sequence was repeated and the solution allowed to warm to ambient temperature. A solution of hydrogen chloride in diethyl ether (1 M, 10 ml) was added, whereupon the reaction turned black. Filtration and removal of the ether *in vacuo* afforded a malodorous solution containing thiophene-3,4-dithiol **139** which was immediately dissolved in benzene (125 ml) containing acenaphthone **119** (0.75 g, 4.5 mmoles) and a catalytic amount of *p*-toluene-sulphonic acid. The resultant mixture was refluxed for 3 h with the removal of water (Dean-Stark) and was then reduced *in vacuo* to yield a viscous brown oil containing dithioketal **140**. The oil was dissolved in dichloromethane (50 ml) and tellurium tetrachloride (1.4 g, 5.4 mmoles) was added in one portion with stirring, whereupon the solution began to darken slowly. After 16 h at room temperature, a black precipitate was observed and aqueous sodium bicarbonate (10%, 50 ml) was added and the solution filtered through celite. The organic phase was separated, washed with water (2 x 50 ml) and dried



(magnesium sulphate). Removal of the solvent *in vacuo* afforded a dark red oil which was purified by column chromatography [silica, hexane/dichloromethane (10:1 v/v)] to afford compound **141** (0.25 g, 19%) as a purple solid; m.p. 125-127°C; (Found C, 64.6; H, 2.8. C₁₄H₈S₃ requires C, 64.8; H, 2.7 %); λ_{\max} (dichloromethane)/nm ($\epsilon/\text{dm}^3 \text{ mol}^{-1} \text{ cm}^{-1}$) 318 (18400), 347 (17100), 486 (1390); δ_{H} (CDCl₃) 7.7-7.8 (2H, m, Ar-H), 7.5-7.6 (4H, m, Ar-H) and 7.08 (2H, s, thiophene); m/z (CI) 297 (M⁺+H, 100%).

Complex of 141 and TCNQ. A complex was prepared by mixing hot solutions of **141** (0.05 mmol) and TCNQ (0.05 mmol) each dissolved in anhydrous acetonitrile (15 ml) and filtering the solid which formed upon cooling. Analysis for 1:1 salt (Found C, 66.8; H, 2.5; N, 10.7. C₂₈H₁₂N₄S₃ requires C, 67.2; H, 2.4; N 11.2 %); ν_{\max} (KBr)/cm⁻¹ 2217.

Complex of 141 and I₄ A complex was prepared by slow diffusion of I₂ vapour into a solution of **141** (10 mg) in dry dichloromethane (5 ml). Silvery black microcrystals formed over a period of 4 days and were subsequently filtered and washed with a small amount of dichloromethane. Analysis for 1:4 complex (Found: C, 23.9; H, 1.0. C₁₆H₈I₄S₃ requires C, 23.9; H, 1.0 %).

Dibenzo[c,e]-[1,2]diselenin (**145**)

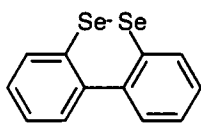

A solution of 1,2-dibromobenzene **142** (1.4 g, 6 mmoles, 0.72 ml) in dry tetrahydrofuran (30 ml) under argon, was cooled to -78°C and treated with ⁿBuLi (1.6M in hexanes, 6 mmoles, 3.0 ml). After stirring at -78°C for 30 min, grey selenium powder (240 mg, 6 mmoles) was added and stirring continued for a further 1h. The above lithiation and selenium addition sequence was repeated and the solution allowed to warm to ambient temperature. A solution of hydrogen chloride in diethyl ether (1 M, 10 ml) was added, whereupon the reaction turned dark brown. Filtration and removal of the ether *in vacuo* afforded a malodorous oil which was immediately dissolved in benzene (125 ml) containing acenaphthone **119** (1.2 g, 6 mmoles) and a catalytic amount of *p*-toluenesulphonic acid. The resultant mixture was refluxed for 3 h with the removal of water (Dean-Stark) and was then reduced *in vacuo*. The viscous brown oil produced was dissolved in dichloromethane (50 ml) and tellurium tetrachloride (2.0 g, 7.1 mmoles) was added in one portion with stirring. After 16 h at room temperature, a black precipitate was observed and aqueous sodium bicarbonate (10%, 50 ml) was added and the solution filtered through celite. The organic phase was separated, washed with water (2 x 50 ml) and dried (magnesium sulphate). Removal of the solvent *in vacuo* afforded a dark red oil which was purified by column chromatography [silica, hexane/dichloromethane (10:1 v/v)] to afford **145** (0.15 g, 7%) as an orange solid; m.p. 104-105°C (lit¹¹⁷ 110-111°C); (Found C, 46.2; H, 2.4. C₁₂H₈Se₂ requires C, 46.2; H,

2.6 %); δ_{H} (CDCl_3) 7.75-7.8 (2H, d, $J = 6.7$, Ar-H) 7.65-7.7 (2H, d, $J = 6.7$, Ar-H) and 7.1-7.2 (4H, m, Ar-H); m/z (EI) 312 (M^+ , ^{80}Se , 60%), 232 (100).

2,3,8,9-Tetramethoxydibenzo[c,e][1,2]dithiin (148a)

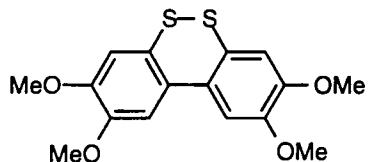

2,3-Dibromo-5,6-dimethoxybenzene **146** (1.00 g, 3.38mmol) in tetrahydrofuran (50 ml) at -78°C under argon, was treated dropwise with *n*-butyl lithium (4.45 ml, 1.6 M in hexanes) and stirred for 0.5 h. Under a positive pressure of argon, sulphur (0.23 g, 7.17 mmol) was added in one portion and the mixture was stirred at -78°C for 1.5 h and then warmed to room temperature. Water (100 ml) was added and the mixture stirred. The organic layer was removed and extracted with aqueous sodium hydroxide (2 x 100 ml, 1 M). The aqueous layers were combined and slowly acidified with aqueous hydrochloric acid (1 M) until a white precipitate formed. The aqueous layer was extracted with diethyl ether (2 x 100 ml), these organic layers were combined, dried (magnesium sulphate) and evaporated *in vacuo* to yield a yellow oil. This oil was dissolved in dichloromethane (50 ml) treated with hexane (200 ml) and cooled in fridge until **148a** appeared as yellow crystals 0.23g (40%). m.p. $185\text{-}186^\circ\text{C}$ (lit¹¹⁹ 214°C); ν_{max} (KBr)/ cm^{-1} 2989, 2953, 2906, 2832, 1596, 1503, 1253, 1039, 848, 779; δ_{H} (CDCl_3) 3.9 (6H, s, OCH_3), 3.95 (6H, s, OCH_3), 7.0 (2H, s, aromatic) and 7.1 (2H, s, aromatic) (lit¹¹⁹ δ_{H} (CDCl_3) 7.10 (s, 2H, Ar-H), 6.98 (s, 2H, Ar-H), 3.95 (s, 6H, OCH_3), and 3.90 (s, 6H, OCH_3)); m/z (EI) 337 (M^+ , 3.2%), 35 (100).

Acenaphthylene[1,2-*b*][1,4]oxathiin (150)

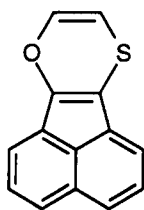

Compound **154** (4.00 g, 17.7 mmol) and DDQ (6.00, 26.5 mmol) were stirred in dry dioxane (150 ml) at reflux under a blanket of argon gas, for 24h. The solvent was evaporated *in vacuo* and the residue was purified by column chromatography [silica, hexane-dichloromethane (9:1 v/v)] to afford the first band as a purple solution. The solvent was evaporated *in vacuo* to yield **150** (0.23 g, 6%) as a purple microcrystalline solid, m.p. $96\text{-}98^\circ\text{C}$ (from hexane / dichloromethane) (Found: C, 75.0; H, 3.6. $\text{C}_{14}\text{H}_8\text{OS}$ requires C, 75.0; H, 3.6 %); ν_{max} (KBr)/ cm^{-1} 3075, 2924, 2853, 1631, 1537, 1459, 1433, 1344, 1289, 1218, 1096, 1004, 969, 817, 766, 712, 702; λ_{max} (CH_2Cl_2) / nm ($\epsilon/\text{dm}^3 \text{ mol}^{-1} \text{ cm}^{-1}$) 530 (510), 311 (10 700), 240 (14 300), 212 (2730); δ_{H} (200 MHz; CDCl_3) 5.11 (1H, d, $J = 6.3$, SCHCH), 6.43 (1H, d, $J = 6.4$, OCHCH), 7.33 (1H, m, Ar-H), 7.47 (3H, m, Ar-H) and 7.72 (2H, m, Ar-H); δ_{C} (200 MHz; CDCl_3)

94.48, 103.85, 119.90, 120.81, 124.41, 126.82, 126.90, 127.23, 127.53, 127.60, 131.27, 134.25, 139.11 and 147.70; m/z (EI) 224 (M^+ , 100%), 196 (28), 170 (99).

Spiro[1,2-dihydroacenaphthylene-1,2'-(1'-3'-oxathiolane)-2-one] (151)

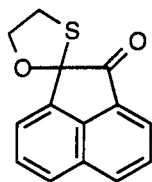

Acenaphthenequinone **125** (15.0 g, 82.3 mmol) and 2-mercaptoethanol (5.75 ml, 82.0 mmol) were azeotroped in benzene (500 ml) at reflux until all the suspended solid dissolved and then for a further 1 h. The solution was cooled and the solvent evaporated *in vacuo*. The residue was dissolved in the minimum of boiling methanol which was then left to cool and the fine colloidal material that initially formed was removed by filtration. Large pale yellow slabs crystallised from the cooled solution, these were recrystallised from hot methanol to give **151** (16.8 g, 85%) as large yellow crystals, m.p. 83-85°C (from methanol) (Found: C, 69.1; H, 4.0. $C_{14}H_{10}O_2S$ requires C, 69.4; H, 4.2 %); ν_{max} (thin solid film)/ cm^{-1} 2951, 2884, 1715 (C=O), 1605, 1433, 1261, 1063, 1015, 994, 919, 829, 775, 707, 677, 625, 594, 539; δ_H (200 MHz; $CDCl_3$) 3.44 (1H, m, SCHHCH₂), 3.65 (1H, m, SCHHCH₂), 4.57 (1H, m, OCHHCH₂), 4.81 (1H, m, OCHHCH₂) and 7.54-7.97 (6H, m, Ar-H); δ_C (50 MHz; $CDCl_3$) 31.34, 73.64, 92.83, 122.26, 122.83, 126.64, 128.90, 129.35, 129.96, 130.68, 132.23, 136.56, 141.40 and 201.25; m/z (CI) 243 ($M^+ + H$, 7%), 200 (9).

Spiro[1,2-dihydroacenaphthylene-1,2'-(1'-3'-oxathiolane)-2-hydrazone] (152)

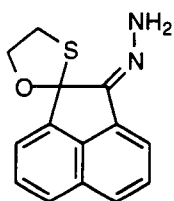

Hydrazine hydrate (80% in water, 15 ml) and **151** (2.50 g, 10.3 mmol) were stirred in methanol (50 ml) at reflux for 3 h. The solution was cooled in a fridge for 16 h and the resulting crystalline precipitate filtered and washed with cold methanol (50 ml) and then recrystallised from the minimum of hot ethanol to give **152** (1.80 g, 68%) as yellow crystals, m.p. 164-167°C (from ethanol) (Found: C, 65.5; H, 4.65; N, 10.9. $C_{14}H_{12}N_2OS$ requires C, 65.6; H, 4.7 N, 10.9 %); ν_{max} (KBr)/ cm^{-1} 3355, 3286, 3202, 3044, 2945, 1636, 1488, 1175, 1037, 927; δ_H (200 MHz; $CDCl_3$) 3.57 (2H, m, SCH₂CH₂), 4.58 (1H, m, OCHHCH₂), 4.75 (1H, m, OCHHCH₂), 6.09 (2H, br s, NNH₂), 7.66 (3H, m, Ar-H) and 7.86 (3H, m, Ar-H); δ_C (50 MHz; $CDCl_3$; Me₄Si) 35.03, 71.94, 95.43, 121.19, 121.96, 125.78, 126.79, 127.90, 128.54, 128.99, 130.58, 136.43 and 141.31 and 153.45; m/z (CI) 257 ($M^+ + H$, 81%), 197 (90).

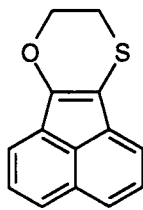
9,10-Dihydroacenaphthylene[1,2-*b*][1,4]oxathiin (154)

Compound **152** (0.26 g, 1.00 mmol), activated manganese dioxide (0.87 g, 10.0 mmol) and ethanol saturated with potassium hydroxide (0.15 ml) were stirred for 1 h in diethyl ether (125 ml). The mixture was filtered to give a bright orange solution which was washed with water (3 x 50 ml) and dried (magnesium sulphate).

The organic solvent was evaporated *in vacuo* to yield a bright red oil which was purified by column chromatography [silica, hexane-dichloromethane (1:1 v/v)] to afford a fast running red band. Evaporation of the solvent yielded **154** (0.16 g, 72%) as a bright red crystalline solid, m.p. 62-64°C (from hexane / dichloromethane) (Found: C, 74.1; H, 4.5. C₁₄H₁₀OS requires C, 74.3; H, 4.5 %); ν_{\max} (KBr)/cm⁻¹ 3039, 2967, 2928, 2871, 1541, 1475, 1461, 1433, 1309, 1105, 818, 760; δ_{H} (200 MHz; CDCl₃) 3.20 (2H, t, *J* = 4.2, OCH₂CH₂), 4.62 (2H, t, *J* = 4.2, SCH₂CH₂), 7.45 (4H, m, Ar-*H*) and 7.67 (2H, m, Ar-*H*); δ_{C} (50 MHz; CDCl₃) 25.51, 67.80, 104.58, 119.22, 119.83, 125.31, 126.12, 127.31, 127.76, 127.87, 128.25, 134.27, 137.30 and 150.91; *m/z* (CI) 257 (M⁺+H, 61%), 227 (35), 197 (78).

5.3 EXPERIMENTAL PROCEDURES FOR CHAPTER 3

5.3.1 EXPERIMENTAL FOR SECTION 3.3.1

1,2-Dibromoacenaphthylene (176)

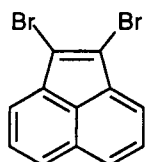

This compound was prepared by the literature method¹³⁶ from acenaphthene and *N*-bromosuccinimide. The product **17** was obtained as golden yellow plates (61%) m.p. 112-113°C (lit.,¹³⁶ 114-115°C).

1,3,5,7-Tetrathia-*s*-indacene-2,6-dione (172)

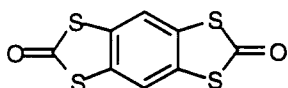

This compound was obtained from the group of Prof. K. Bechgaard (Risø, Danish National Research Centre) who prepared it by the literature method.¹³⁵

Diacenaphtheno[1,2-*e*:1',2'-*e'*]benzobis[1,2-*b*:4,5-*b'*]dithiin (177)

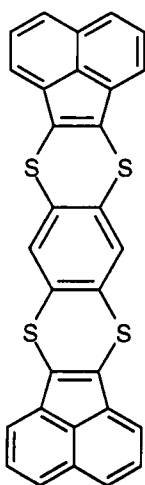

1,3,5,7-Tetrathia-*s*-indacene-2,6-dione **172** (0.22 g, 0.85 mmol) and **176** (0.50 g, 1.60 mmol) were stirred under a blanket of argon in dimethylformamide (50 ml). To this suspension was added potassium *t*-butoxide (0.44 g, 3.90 mmol) in one portion. The solution turned clear yellow which rapidly darkened to black, this was stirred at 130°C for 20 h. The solvent was then evaporated *in vacuo* and the black residue extracted with boiling chlorobenzene (150 ml) and filtered, whilst hot, through a short plug of silica gel to give a red solution. This solution was evaporated *in vacuo* until its volume was ca. 20-30 ml. This yielded **177** (0.089 g, 21%) as red microcrystals which were washed with cold chlorobenzene (25 ml), m.p. >250°C (from chlorobenzene) ν_{\max} (KBr)/cm⁻¹ 1475, 1456, 1426, 1299, 1116, 880, 816, 765; λ_{\max} (PhCl) / nm ($\epsilon/\text{dm}^3 \text{ mol}^{-1} \text{ cm}^{-1}$) 485 (1 370), 367 (34 200), 351 (38 600), 349 (38500), 339 (39 700), 281 (20700); *m/z* (MALDI-TOF) 502 (M⁺, 100 %), HRMS found 502.00049, C₃₀H₁₄S₄ requires 502.00460.

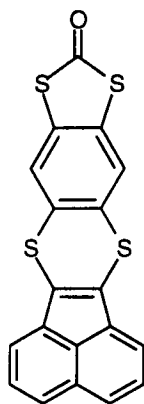
Acenaphthylene[1,2-*b*][1,3]dithiolo[4,5-*g*][1,4]benzodithiine-10-one (178)

1,3,5,7-Tetrathia-*s*-indacene-2,6-dione **172** (0.65 g, 2.52 mmol) was stirred under argon in dry dimethylformamide (100 ml). Potassium *t*-butoxide (0.56 g, 5.00 mmol) was added in one portion and the suspension stirred for 15 min during which time the solution turned clear yellow. **176** (0.75 g, 2.41 mmol) was then added in one portion and the mixture stirred at 90°C for 15h. The solution was cooled and the solvent removed *in vacuo*. The red residue was purified by column chromatography [silica, hexane-dichloromethane (3:1 v/v)] to afford **178** (0.23 g, 25%) after recrystallisation as a red solid, m.p. 170°C dec' (from dichloromethane/hexane) (Found: C, 60.2; H, 2.1. C₁₉H₈OS₄ requires C, 60.0; H, 2.1 %); ν_{\max} (KBr)/cm⁻¹ 3054, 3034, 1717, 1684 (C=O), 1654, 1638, 1457, 1425, 1318, 891, 814, 763; δ_{H} (250 MHz; CDCl₃) 7.53 (2H, s, Ar-*H*), 7.58 (2H, m, Ar-*H*), 7.69 (2H, d, *J* = 6.9, Ar-*H*) and 7.84 (2H, d, *J* = 8.1, Ar-*H*); *m/z* (EI) 380 (M⁺, 49%), 352 (31), 57 (100).

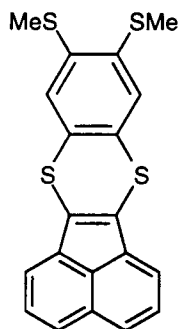
9,10-Di(methylsulfanyl)acenaphthylene[1,2-*b*][1,4]benzodithiine (180)

Compound **178** (0.09 g, 0.24 mmol) was stirred under argon in dry tetrahydrofuran (40 ml) at room temperature. To this solution a solution of sodium *t*-amylate in dry toluene (0.80 ml, 1.25 M) was added. The red solution darkened and after 1min a brown precipitate was seen. This suspension was stirred for 0.5 h whereupon iodomethane (0.05 ml, 0.80 mmol) was added. The solution slowly turned red, the precipitate dissolved and the mixture was stirred for 1 h. The solvent was removed *in vacuo* the residue was dissolved in dichloromethane and filtered through a short plug of silica gel using dichloromethane as an eluent. Evaporation of the solvent yielded **180** (0.04g, 44%) as an orange solid, m.p. 196-199°C (from dichloromethane / hexane) (Found: C, 62.8; H, 3.5. C₂₀H₁₄S₄ requires C, 62.8; H, 3.7 %); ν_{\max} (KBr)/cm⁻¹ 2916, 1457, 1424, 1299, 817, 765; λ_{\max} (CH₂Cl₂) / nm (ϵ /dm³ mol⁻¹ cm⁻¹) 480 (462), 347 (11 600), 328 (12 600), 239 (33 600); δ_{H} (400 MHz; CDCl₃) 2.48 (6H, s, SCH₃), 7.20 (2H, s, Ar-*H*), 7.53 (2H, dd, *J* = 7.0 and 8.2, Ar-*H*), 7.63 (2H, d, *J* = 6.8, Ar-*H*) and 7.78 (2H, d, *J* = 8.0, Ar-*H*); δ_{C} (100 MHz; CDCl₃) 16.2, 120.7, 126.2, 127.5, 127.6, 127.8, 129.1, 130.7, 132.2, 136.2 and 137.0; *m/z* (EI) 382 (M⁺, 100 %), 334 (23), 271 (24).

Complex of 180 and 2,5-Br₂TCNQ. A complex was prepared by mixing hot solutions of **180** (0.05 mmol) and 2,5-Br₂TCNQ (0.05 mmol) each dissolved in anhydrous acetonitrile (10 ml) and filtering the small black crystals which formed upon cooling.

Analysis for 1:1 complex (Found: C, 51.5; H, 2.1; N, 8.7. $C_{32}H_{16}Br_2N_4S_4$ requires C, 51.6; H, 2.2; N 7.5 %); ν_{\max} (KBr)/ cm^{-1} 2205.

9,10-(Ethylenedithio)acenaphthylene[1,2-*b*][1,4]benzodithiin (181)

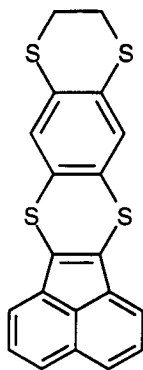

Compound **178** (0.20 g, 0.52 mmol) was stirred, under a blanket of argon, in dry tetrahydrofuran (100 ml) at room temperature. Potassium *t*-butoxide (0.12 g, 1.07 mmol) was added in one portion, the solution turned deep red and was stirred 1 h. Dibromoethane (0.045 ml, 0.52 mmol) was added dropwise and the solution stirred for 15 h. The solvent was removed *in vacuo* and the residue dissolved in dichloromethane (100 ml), washed with water (2 x 100 ml) and dried (magnesium sulphate). The mixture was then purified by column chromatography [silica, hexane-dichloromethane (1:1 v/v)] to afford **181** (0.11 g, 55%) as red crystals after recrystallisation, m.p. 121-123°C (from hexane-DCM) (Found: C, 63.1; H, 3.1. $C_{20}H_{12}S_4$ requires C, 63.1; H, 3.2 %); ν_{\max} (KBr)/ cm^{-1} 1474, 1455, 1429, 1297, 1116, 882, 867, 816, 765; λ_{\max} (CH_2Cl_2) / nm ($\epsilon/dm^3 mol^{-1} cm^{-1}$) 483 (295), 348 (8 700), 328 (9 460), 257 (15 400), 240 (16 100); δ_H (250 MHz; $CDCl_3$) 3.26 (4H, s, SCH_2CH_2S), 7.21 (2H, s, *Ar-H*) 7.54 (2H, m, *Ar-H*), 7.63 (2H, d, $J = 6.7$, *Ar-H*) and 7.79 (2H, d, $J = 8.0$, *Ar-H*); δ_C (63 MHz; $CDCl_3$) 29.46, 121.21, 128, 128.14, 128.34, 128.58, 129.56, 130.41, 131.27, 132.46 and 136.88; m/z (CI) 381 (M^++H , 100 %).

5.3.2 EXPERIMENTAL FOR SECTION 3.2.2

1,2-Bis(2-propylsulfanyl)acenaphthylene (182)

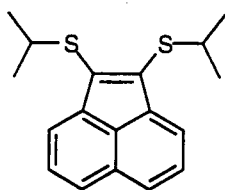

Isopropanethiol (4.90 ml, 52.76 mmol) was stirred in dry dimethylformamide (200 ml) under a blanket of argon. Sodium hydride (60% in mineral oil, 2.11 g, 52.75 mmol) was added quickly and the mixture stirred for 1.5 h **176** (7.50 g, 24.05 mmol) was then added and the mixture turned deep red and warmed slightly. This mixture was heated at 120°C for 2 h after which it was cooled to room temperature and poured onto 1 l of crushed ice. This was stirred until the ice melted and then the aqueous solution was extracted with dichloromethane (4 x 100 ml). The organic layers were combined, washed with brine (100 ml) and dried (magnesium sulphate). The solvent was evaporated *in vacuo* to yield **182** (7.34 g, 90%) as an orange / red oil which was not purified further, ν_{\max} (thin film)/ cm^{-1} 3061, 3041,

2959, 2622, 2860, 1479, 1457, 1428, 1381, 1364, 1238, 1179, 1153, 1135, 1049, 821, 770, 619; δ_{H} (250 MHz; CDCl_3) 1.39 (18H, d, $J = 6.7$, SCHCH_3), 3.88 (2H, sp, $J = 6.7$, SCHCH_3), 7.59 (2H, m, Ar-H) and 7.83 (4H, m, Ar-H); δ_{C} (50 MHz; CDCl_3) 23.54, 38.87, 122.48, 127.27, 127.59, 127.64, 128.20, 138.6 and 139.79; m/z (EI) HRMS found 300.10377, $\text{C}_{18}\text{H}_{20}\text{S}_2$ requires 300.10402.

Bis(tetrabutylammonium)-bis(1,2-thiolatoacenaphthylene)zincate (186)

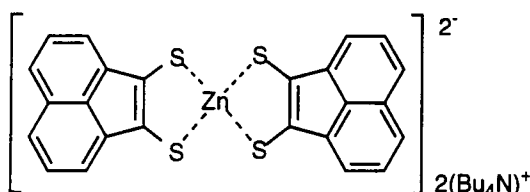

Compound **186** (3.50 g, 11.65 mmol) was stirred, under a blanket of argon, in dry pyridine (100 ml) at 100°C. Divided sodium (0.80 g, 34.80 mmol) was added and the mixture stirred at

100°C for 1.5 h during which time the solution turned dark purple. The mixture was cooled to 20°C using an ice bath and methanol (5 ml) was added turning the solution blue. A degassed (with argon for 15 min) mixture of water (100 ml) and methanol (80 ml) was added to the stirred mixture. Zinc chloride (1.2 g, 8.80 mmol) in concentrated aqueous ammonia (50 ml) and methanol (50 ml), was added to the mixture. Tetrabutylammonium bromide (5.60 g, 17.4 mmol) in water (25 ml) was added slowly to the stirred reaction mixture and a blue precipitate appeared. This was filtered off and washed with water (100ml), isopropyl alcohol (150 ml) and diethyl ether (300 ml) to yield **186** (3.18, 56%) as a moderately air sensitive blue powder, which was used without further purification, m.p. (dec.) > 120°C.

1,2-dibenzoylsulfanylacenaphthylene (185)

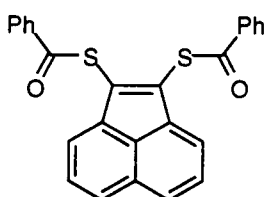

Compound **186** (7.50 g, 7.66 mmol) was dissolved in dry acetone (250 ml) under a blanket of argon. To this stirred blue solution was slowly added benzoyl chloride (4.50 ml, 38.77 mmol) which caused a colour change to orange and the formation of a yellow precipitate. This precipitate was removed by filtration, washed with a small amount of acetone and then dried *in vacuo*. The solid was dissolved in the minimum volume of hot chloroform and this solution was filtered and cooled. The volume of this solution was reduced to approximately 20 ml by evaporation and then cold methanol was added in small portions until crystallisation took place. The solution was cooled in a fridge for 20 h and the resulting **185** (2.44 g, 38%) was filtered as yellow crystals, m.p. 255°C (from chloroform / methanol) ν_{max} (KBr)/ cm^{-1} 3049, 1666 (C=O), 1446, 1425, 1204s, 1175, 895, 821, 747,

686, 666; δ_{H} (250 MHz; CDCl_3) 7.48 (4H, m, Ar-*H*), 7.65 (4H, m, Ar-*H*), 7.81 (2H, d, $J = 6.9$, Ar-*H*), 7.96 (2H, d, $J = 8.1$, Ar-*H*), 8.13 (4H, m, Ar-*H*); δ_{C} (50 MHz; CDCl_3) 124.64, 127.85, 127.92, 128.19, 128.78, 128.95, 129.00, 133.80, 133.86, 135.43, 138.21, 188.47; m/z (CI) 425 (M^++H , 38 %), 303 (100), HRMS found 424.06214, $\text{C}_{26}\text{H}_{16}\text{O}_2\text{S}_2$ requires 424.06255.

5.4 EXPERIMENTAL PROCEDURES FOR CHAPTER 4

5.4.1 EXPERIMENTAL FOR SECTION 4.2

Bis(tetraethylammonium)bis(1,3-dithiole-2-thione-4,5-dithiolato)zincate (188)

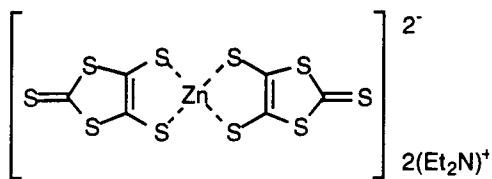

This compound was prepared by a modification of the literature method.¹³⁷ Carbon disulphide (240 ml, 4 mol) and DMF (480 ml) were stirred in a dried,

thick walled, 2 l, glass conical flask fitted with a side arm (through which an atmosphere of argon gas was maintained) and a rubber bung. This was cooled to 0°C using a water/ice bath and finely divided sodium (20 g, 0.87 mol) was added. The solution rapidly turned red and was stirred for 48 h at room temperature. After this time the mixture was cooled to 0°C and the remaining sodium was destroyed by treatment with small amounts of methanol. Solutions of tetraethylammonium bromide (92 g, 0.44 mol) in water (500 ml) and zinc chloride (30 g, 0.22 mol) in concentrated aqueous ammonia (400 ml) were then added in small alternate portions. A crystalline precipitate was seen to form and the mixture was stirred for a further 12 h at room temperature. The suspension was then filtered through a glass sinter and washed with propan-2-ol until the washings were colourless and then with diethyl ether (250 ml). The solid was dried *in vacuo* to yield **188** (112 g) as a red microcrystalline solid m.p. 200-203°C (lit.¹³⁷ 200-205°C).

Oligo(1,3-dithiole-2,4,5-trithione) (189)

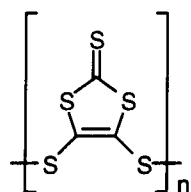

This compound was prepared by the literature method¹⁴¹ from **188**. The Product **189** was obtained as an orange powder (97%) m.p. 127°C dec. (lit.¹⁴¹ 130°C dec.).

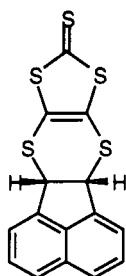
6b,11a-Dihydroacenaphthylene[1,2-*b*][1,3]dithiolo[4,5-*e*][1,4]dithiin-9-thione (202)

Compound **189** (10.0 g, 50.9 mmol) and acenaphthylene **200** (80%) (10.0 g, 65.7 mmol) were stirred in toluene (250 ml) at reflux for 0.5 h. During this time **189** was consumed and **202** formed as yellow crystals. The suspension was cooled to room temperature, filtered and washed with hot ethanol (150 ml) to yield **202** (14 g, 79%) as yellow needles, m.p. 235-240°C; (Found: C, 51.6; H, 2.2. C₁₅H₈S₅ requires C, 51.7; H, 2.3%); ν_{\max} (KBr)/cm⁻¹ 1065, 1041, 821, 775, 505; δ_{H} (400MHz; CS₂ / CDCl₃ 5:1) 5.74 (2H, s, *benzylic*), 7.45 (2H, d, *J* = 6.8, Ar-*H*), 7.57 (2H, m, Ar-*H*) and 7.72 (2H, d, *J* = 8.4, Ar-*H*); *m/z* (EI) 348 (M⁺, 100%), 152 (89).

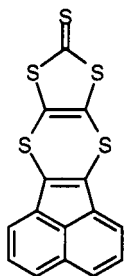
Acenaphthylene[1,2-*b*][1,3]dithiolo[4,5-*e*][1,4]dithiin-9-thione (203)

202 (5.00 g, 14.4 mmol) and DDQ (6.50 g, 28.6 mmol) were refluxed in toluene (200 ml) under a blanket of dry argon gas, for 16 h. The mixture was cooled to room temperature and the precipitate which formed was filtered off and washed with hot toluene (100 ml) and hot acetone until the eluents were colourless. The remaining orange solid was recrystallised from hot chlorobenzene to afford **203** (4.65 g, 94%) as orange microcrystals, m.p. > 250°C, (Found: C, 51.7; H, 1.8. C₁₅H₆S₅ requires C, 52.0; H, 1.75%); ν_{\max} (KBr)/cm⁻¹ 1423, 1073, 1032, 816, 763; δ_{H} (400 MHz; CS₂ / CDCl₃ 5:1) 7.61 (4H, m, Ar-*H*) and 7.86 (2H, d, *J* = 7.6, Ar-*H*); *m/z* (EI) 347 (M⁺+H, 6%), 185 (100).

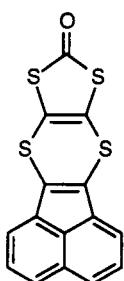
Acenaphthylene[1,2-*b*][1,3]dithiolo[4,5-*e*][1,4]dithiin-9-one (204)

A suspension of mercury (II) acetate (5.50 g, 17.3 mmol) and **203** (2.00 g, 5.77 mmol) in a mixture of chloroform and acetic acid (200 ml, 3:1 v/v), was stirred for 15 h under dry argon gas. The resulting pale pink suspension was filtered through a bed of celite and eluted with hot chloroform. The solution was washed with sodium bicarbonate solution until neutral and then with brine (100 ml). The organic solution was dried (magnesium sulphate) and evaporated *in vacuo* to afford **204** (1.45 g, 76%) as salmon pink needles, m.p. 222°C dec. (from toluene) (Found: C, 54.75; H, 1.8. C₁₅H₆OS₄ requires C, 54.5; H, 1.8 %); ν_{\max} (KBr)/cm⁻¹ 1687 (C=O), 1659, 1423, 816, 765; δ_{H} (400 MHz; CDCl₃) 7.58 (2H, m,

Ar-H), 7.66 (2H, d, $J = 7.7$, Ar-H) and 7.86 (2H, d, $J = 8.0$, Ar-H); m/z (CI) 331 ($M^+ + H$, 39 %), 185 (100).

6b,11a-Dihydroacenaphthylene[1,2-*b*][1,3]dithiolo[4,5-*e*][1,4]dithiin-9-one (205)

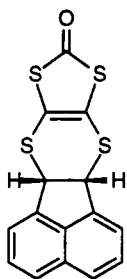

A suspension of mercury (II) acetate (43.3 g, 135.9 mmol) and **202** (15.8 g, 45.3 mmol) in a mixture of chloroform and acetic acid (600 ml, 3:1 v/v), was stirred for 15 h under dry argon gas. The resulting colourless suspension was filtered through a bed of celite and eluted with hot chloroform. The solution was washed with sodium bicarbonate solution until neutral and then with brine (100 ml). The organic solution was dried (magnesium sulphate) and evaporated *in vacuo* to afford **205** (6.60 g, 40%) as colourless hairs, m.p. 200°C dec. (from toluene); (Found: C, 53.9; H, 2.4. $C_{15}H_8OS_4$ requires C, 54.2; H, 2.4 %); ν_{max} (KBr)/ cm^{-1} 1669 (C=O), 1612, 913, 821, 778, 749; δ_H (400 MHz; $CDCl_3$) 5.73 (2H, s, SCH(Ph)CH(Ph)S), 7.44 (2H, d, $J = 7.4$, Ar-H), 7.55 (2H, m, Ar-H) and 7.71 (2H, d, $J = 8.0$, Ar-H); δ_C (100 MHz; $CDCl_3$) 60.52, 120.92, 124.86, 128.20, 128.62, 130.46, 136.94, 140.42 and 189.80; m/z (EI) 332 (M^+ , 5 %), 152 (100).

8,9-Di(methylsulfanyl)acenaphthylene[1,2-*b*][1,4]dithiin (207)

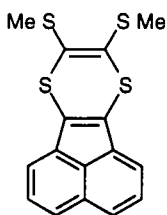

Under a positive pressure of argon, potassium *tert*-butoxide (510 mg, 4.54 mmol) was added in one portion to a stirred suspension of **204** (500 mg, 1.51 mmol) in dry tetrahydrofuran (100 ml). This mixture was stirred at room temperature for a further 0.5 h, during which time the solution became milky brown. Iodomethane (0.29 ml, 4.66 mmol) was added dropwise causing the solution to quickly turn rapidly milky red, the solution was stirred for a further 0.5 h whereupon the solvent was evaporated *in vacuo*. The residue was dissolved in dichloromethane and filtered through a short plug of silica gel eluting with dichloromethane to afford **207** (0.40 g, 80%) as red plates, m.p. 102-104°C (from methanol) (Found: C, 57.6; H, 3.5. $C_{16}H_{12}S_4$ requires C, 57.8; H, 3.6%); ν_{max} (KBr)/ cm^{-1} 2918, 1456, 1422, 1176, 1135, 1061, 841, 818, 767, 615; λ_{max} (CH_2Cl_2) / nm ($\epsilon/dm^3 mol^{-1} cm^{-1}$) 496 (260), 328 (11 900), 238 (25 500); δ_H (400 MHz; $CDCl_3$) 2.5 (6H, s, CH_3), 7.54 (2 H, dd, $J = 7.2$ and 7.2, Ar-H), 7.63 (2 H, d, $J = 6.8$, Ar-H) and 7.80 (2 H, d, $J = 8.0$, Ar-H); δ_C (100 MHz; $CDCl_3$) 135.8, 133.2, 129.6, 128.8, 128.0, 127.9, 127.8, 121.4 and 18.1; m/z (EI) 332 (M^+ , 41%), 285 (100).

Complex of 207 and TCNQ. A complex was prepared by mixing hot solutions of **207** (0.05 mmol) and TCNQ (0.05 mmol) each dissolved in anhydrous acetonitrile (15 ml) and filtering the black needles which formed upon cooling. Analysis for 1:1 complex (Found: C, 61.6; H, 2.8; N, 10.5. $C_{28}H_{16}N_4S_4$ requires C, 62.7; H, 3.0; N, 10.4 %); ν_{\max} (KBr)/ cm^{-1} 2219.

Complex of 207 and 2,5-dibromo TCNQ. A complex was prepared by mixing hot solutions of **207** (0.05 mmol) and 2,5-dibromo TCNQ (0.05 mmol) each dissolved in anhydrous acetonitrile (15 ml) and filtering the black needles which formed upon cooling. Analysis for 1:1 complex (Found: C, 48.2; H, 1.9; N, 8.25. $C_{28}H_{14}Br_2N_4S_4$ requires C, 48.4; H, 2.0; N, 8.1 %); ν_{\max} (KBr)/ cm^{-1} 2210.

Complex of 207 and $(I_2)_2 I_3^-$. A complex was prepared by slow diffusion of I_2 vapour into a solution of **207** (12.5 mg) in dry dichloromethane (5 ml). Black prisms formed over a period of 4 days and were subsequently filtered and washed with a small amount of dichloromethane. Analysis for 1:7 complex (Found: C, 15.9; H, 0.9. $C_{16}H_{12}I_7S_4$ requires C, 15.7; H, 1.0 %).

Bis-(acenaphthylene-1,2-dithio)tetrathiafulvalene (**209**)

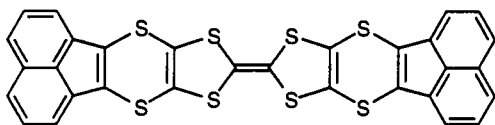

Compound **204** (0.10 g, 0.30 mmol) was heated in triethylphosphite (50 ml) at reflux for 15 h. The solution was then

cooled and the precipitate which formed was filtered off and washed with methanol (100 ml). Recrystallisation gave **209** (0.09 g, 95%) as light yellow / orange microcrystals, m.p. $>270^\circ C$ dec. (from *o*-dichlorobenzene) (Found: C, 57.0; H, 1.8. $C_{30}H_{12}S_8$ requires C, 57.3; H, 1.9%); ν_{\max} (KBr)/ cm^{-1} 1473, 1457, 1177, 1135, 1059, 897, 813, 759 vs, 610; λ_{\max} (CH_2Cl_2) / nm ($\epsilon/dm^3 mol^{-1} cm^{-1}$) 350 (49 600), 284 (26 000).

4,5-Bis(2'-cyanoethylthio)-1,3-dithiol-2-one (**210**)

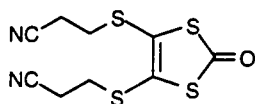

This compound was prepared by the literature method¹⁵⁵. The product **210** was obtained as pale yellow needles (94%) m.p. $64-65^\circ C$ (lit.¹⁵⁵ $64-65^\circ C$).

9-[4,5-Di(1-sulfanyl-2-cyanoethane)-1,3-dithiol-2-ylidene]acenaphthylene[1,2-*b*][1,3]dithiolo[4,5-*e*][1,4]dithiine (211)

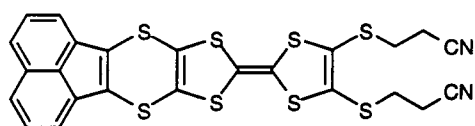

Compound **203** (2.00 g, 5.77 mmol) and **210** (3.33 g, 1.55 mmol) were heated in triethylphosphite (100 ml) at reflux for 15

h. The solution was cooled to room temperature and diluted with methanol (200 ml). The precipitate which formed was removed by filtration and washed with methanol (100 ml). The precipitate was purified by column chromatography on silica gel eluting with DCM, to afford **211** (0.57 g, 17%) as dark purple needles, m.p. 174-177°C (from toluene) (Found: C, 48.8; H, 2.3; N, 4.5. $C_{24}H_{14}N_2S_8$ requires C, 49.1; H, 2.3; N, 4.5 %); ν_{\max} (KBr)/ cm^{-1} 2922, 2248 (CN), 1475, 1457, 1425, 1133, 892, 816, 764; δ_H (200 MHz; $CDCl_3$) 2.75 (4H, t, $J = 7.7$, SCH_2CH_2), 3.09 (4H, t, $J = 7.1$, CH_2CH_2CN), 7.57 (4H, m, Ar-*H*) and 7.84 (2H, dd, $J = 9.52$ and 1.42 , Ar-*H*); m/z (CI) 587 ($M^+ + H$, 5%), 365 (100).

9-[4,5-Di(sulfanylmethyl)-1,3-dithiol-2-ylidene]acenaphthylene[1,2-*b*][1,3]dithiolo[4,5-*e*][1,4]dithiine (214)

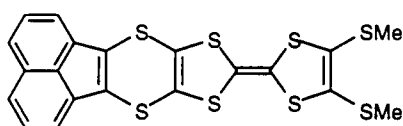

Compound **211** (0.10 g, 0.17 mmol) was stirred at room temperature under argon gas, in a mixture of dry methanol (10 ml) and dry tetrahydrofuran (100 ml). Caesium hydroxide monohydrate (0.10 g, 0.59 mmol) was dissolved in dry methanol (10 ml) and added dropwise to the reaction. The mixture was stirred for 15 min whereupon iodomethane (0.05 ml, 0.80 mmol) was added dropwise.

After a few seconds the mixture turned from dark to light red and was stirred for a further 15 min. The solvent was removed *in vacuo* and the residue dissolved in DCM and filtered through a short plug of silica gel eluting with DCM to afford **214** (84.0 mg, 96%) as dark red needles, m.p. 187-190°C (from CS_2 / hexane); ν_{\max} (KBr)/ cm^{-1} 1424, 894, 815, 764 vs; λ_{\max} (CH_2Cl_2) / nm ($\epsilon/dm^3 mol^{-1} cm^{-1}$) 346 (19 400), 340 (18 600), 333 (17 400), 257 (10 300), 239 (23 300); δ_H (400 MHz; $CDCl_3$) 2.44 (6H, s, SCH_3), 7.54 (2H, dd, $J = 7.0$ and 8.0 , Ar-*H*), 7.59 (2H, d, $J = 6.4$, Ar-*H*) and 7.82 (2H, dd, $J = 8.8$ and 0.4 , Ar-*H*); m/z (CI) 509 ($M^+ + H$, 21 %), 185 (57).

5.4.2 EXPERIMENTAL FOR SECTION 4.3

bis-(Trimethylsilyl)-4,5-(Vinylenedithio)-1,3-dithiole-2-thione (218)

Bis(trimethylsilyl)-acetylene (2.50 g, 14.7 mmol) and compound **189** (2.90 g, 14.8 mmol) were heated in toluene (250 ml) at 90°C for 4 h. The resulting red solution was refluxed for 10 min with activated charcoal (2 g) and then filtered through a bed of celite to yield an orange solution. The solvent was evaporated *in vacuo* to give a solid which when recrystallised from ethanol gave **218** (3.50 g, 65%) as yellow needles, mp 89-90°C (from ethanol) (Found: C, 35.4; H, 4.9. C₁₁H₁₈S₅Si₂ requires C, 36.0; H, 4.9 %); ν_{\max} (KBr)/cm⁻¹ 2945, 1466, 1249, 1067, 843; δ_{H} (200 MHz; CDCl₃) 0.36 (18H, s, Si(CH₃)₃); m/z (EI) 366 (M⁺, 15%), 155 (100).

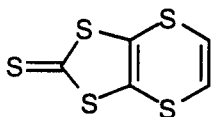
4,5-(Vinylenedithio)-1,3-dithiole-2-thione (219)

Compound **218** (0.10 g, 0.27 mmol) was stirred in THF (50 ml) and tetrabutylammonium fluoride (0.75 ml, 1.1 M in THF) was added dropwise. The solution turned dark red and was stirred for a further 0.5 h after which time 5 ml of water was added and the mixture stirred for a further 0.5 h. The solvent was removed *in vacuo* and the residue was dissolved in DCM (100 ml) and washed with water (3 x 50 ml) and dried (magnesium sulphate). The organic solution was evaporated *in vacuo* and the residue purified by column chromatography on silica gel (dichloromethane / hexane, 1:1 v/v). The major yellow band was isolated and solvent removed to yield yellow powders which were recrystallised from hot ethanol to give **219** as long yellow / orange needles (0.021g, 35%), mp 123-124°C (lit.^{156a} m.p. 143-144°C); δ_{H} (200 MHz; CDCl₃) 6.65 (s, SCHCHS) (lit.^{156a} δ_{H} (CS₂) 6.63 (s)).

(cis/trans)-1,2-diferrocenylethene (221)

This compound was prepared by the literature method,¹⁵⁸ but isolated as a mixture of *trans*- contaminated with the *cis*- isomer (¹H NMR evidence). The product **221** was obtained as an orange powder (60%), mp 130-133°C then resolidifies 140-170°C and m.p. (dec.) >250°C (lit.¹⁵⁸ *trans*- 265-267°C, *cis*- 195-198°C)

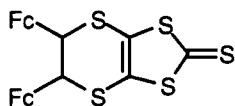
bis-Ferrocenyl-4,5-(ethanedithio)-1,3-dithiole-2-thione (222)

Compound **221** (1.00 g, 2.52 mmol) and compound **189** (0.54 g, 2.75 mmol) were stirred in toluene (100 ml) at reflux for 1.5 h. The solution was evaporated *in vacuo* and the residue purified by column chromatography on silica gel (dichloromethane / hexane, 3:1 v/v). The yellow solution obtained was evaporated *in vacuo* to give **222** (0.48 g, 32%) as a yellow powder, m.p. 167-170°C (Found: C, 50.6; H, 3.35. C₂₅H₂₀Fe₂S₅ requires C, 50.7; H, 3.40 %); ν_{\max} (KBr)/cm⁻¹ 3079, 1483, 1295, 1106, 1063 (C=S), 999, 86, 931, 818, 487; m/z (CI) 593 (M⁺+H, 4%), 397 (100), 167 (100).

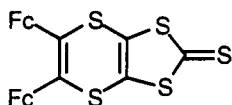
bis-Ferrocenyl-4,5-(Vinylenedithio)-1,3-dithiole-2-thione (223)

DDQ (0.55 g, 2.43 mmol) and **222** (0.48 g, 0.81 mmol) were stirred under argon gas, in toluene (250 ml) at reflux for 2 h. Whilst the mixture was still hot it was filtered through a plug of silica gel and eluted with hot toluene (100 ml). The solution was evaporated *in vacuo* until 10ml remained and then diluted with cold hexane (100 ml). **223** (0.18 g, 38%) appeared slowly as dark red microcrystals, m.p. >240°C dec. (from toluene / hexane) (Found: C, 50.7; H, 3.1. C₂₅H₁₈Fe₂S₅ requires C, 50.9; H, 3.1 %); ν_{\max} (KBr)/cm⁻¹ 3091, 1488, 1264, 1106, 1065 (C=S), 1047, 1001, 818, 493; δ_{H} (200 MHz; CDCl₃) 4.17 (6H, m, *cp*) and 4.24 (2H, m, *cp*); m/z (CI) 591 (M⁺+H, 3%), 485 (2), 395 (9).

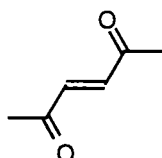
trans-3-hexene-2,5-dione (231)

This compound was prepared by the literature method¹⁶⁰ from dimethylfuran. The product **231** was obtained as colourless crystalline plates (*trans*- isomer) (99%); m.p. 73-74°C (lit¹⁶⁰ 76-77°C).

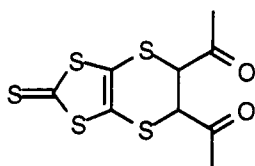
4,5-(hexane-2,5-dione-3,4-dithio)-1,3-dithiole-2-thione (232)

Compound **231** (2.42g, 21.6mmol) and compound **189** (5.10 g, 26.0 mmol) were stirred in toluene (250 ml) at reflux for 2 h. The solution was cooled to room temperature and filtered through a bed of celite which was then washed

with hot ethanol (100 ml). The resulting organic solution was evaporated *in vacuo* and the residue dissolved in boiling ethanol (200 ml), treated with activated charcoal (0.5 g) and then filtered rapidly through a bed of celite. The ethanolic solution was cooled to give **232** (5.66 g, 85%) as yellow plates, m.p. 128-132°C (from ethanol) (Found: C, 34.8; H, 2.5. $C_9H_8O_2S_5$ requires C, 35.0; H, 2.6 %); ν_{\max} (KBr)/ cm^{-1} 1697 (C=O), 1415, 1354, 1259, 1206, 1163, 1052 (C=S), 917, 777, 587, 510; δ_H (200 MHz; $CDCl_3$) 2.40 (6H, s, CH_3CO) and 4.73 (2H, s, $SCH(CH)CO$); δ_C (50 MHz; $CDCl_3$) 28.24, 55.75, 130.07, 199.61 and 208.24; m/z (EI) 308 (M^+ , 37%), 265(57), 223 (23), 120 (28).

References

1. Reviews: (a) M. R. Bryce, *Chem. Soc. Rev.*, 1991, **20**, 355; (b) H. J. Kraus, *J. Am. Chem. Soc.*, 1913, **34**, 1732.
2. (a) H. N. McCoy, W. C. Moore, *J. Am. Chem. Soc.*, 1911, **33**, 273. (b) H. J. Kraus, *J. Am. Chem. Soc.*, 1913, **34**, 1732.
3. H. Akamatu, H. Inokuchi, Y. Matsunga, *Nature*, 1954, **173**, 168.
4. L. R. Melby, R. J. Harder, W. R. Hertler, R. E. Benson, W. E. Mochel, *J. Am. Chem. Soc.*, 1962, **84**, 3374.
5. J. Ferraris, D. O. Cowan, V. Walatka, J. H. Perlstein, *J. Am. Chem. Soc.*, 1973, **95**, 948.
6. K. Bechgaard, C. S. Jacobsen, K. Mortensen, H. J. Pederson, N. Thorup, *Solid State Commun.*, 1980, **33**, 1119.
7. K. Bechgaard, K. Carneiro, M. Olsen, B. Rasmussen, C. S. Jacobsen, *Phys. Rev. Lett.*, 1981, **46**, 852.
8. A. M. Kini, U. Geiser, H. H. Wang, K. D. Carlson, J. M. Williams, W. K. Kwok, K. G. Vandervoort, J. E. Thompson, D. L. Stupka, D. Jung, M. -H. Whangbo, *Inorg. Chem.*, 1990, **29**, 2555.
9. J. M. Williams, A. M. Kini, H. H. Wang, K. D. Carlson, U. Geiser, L. K. Montgomery, G. J. Pyrka, D. M. Watkins, J. K. Kommers, S. J. Boryschuk, A. V. Crouch, W. K. Kwok, J. E. Schirber, D. L. Overmyer, D. Jung, M. -H. Whangbo, *Inorg. Chem.*, 1990, **29**, 3274.
10. H. Shirakawa, E. J. Louis, A. G. MacDiarmid, C. K. Chiang, A. J. Heeger, *J. Chem. Soc., Chem. Commun.*, 1977, 578.
11. M. M. Labes, P. Lowe, L. F. Nichols, *Chem. Rev.*, 1979, **79**, 1.
12. (a) A. E. Underhill, D. M. Watkins, *Chem. Soc. Rev.*, 1980, **9**, 429; (b) P. I. Clemenson, *Coord. Chem. Rev.*, 1990, **106**, 171.
13. A. J. Epstein, J. S. Miller, *Sci. Am.*, 1979, 48.

14. H. Fröhlich, *Proc. R. Soc. London, Ser. A*, 1954, **223**, 296.
15. R. E. Peierls, 'Quantum Theory of Solids', Oxford University Press, London, 1955.
16. (a) D. Jérôme, H. J. Schultz, *Adv. Phys.*, 1982, **31**, 299; (b) P. M. Chaikin, R. L. Greene, *Physics Today*, 1986, **39**, 24.
17. V. D. Parker, *J. Am. Chem. Soc.*, 1976, **98**, 98.
18. J. Kommandeur, F. R. Hall, *J. Chem. Phys.*, 1961, **34**, 129.
19. H. P. Fritz, H. Gebauer, P. Friedrich, P. Ecker, R. Artes, U. Schubert, *Z. Naturforsch.*, 1978, **B 33**, 498.
20. C. Kröhnke, V. Enkelmann, G. Wegner, *Angew. Chem. Int. Ed. Engl.*, 1980, **19**, 912.
21. R. R. Chance, L. W. Shacklette, G. G. Miller, D. M. Ivory, J. M. Sowa, R. L. Elsenbaumer, R. H. Baughman, *J. Chem. Soc. Chem. Commun.*, 1980, 348.
22. (a) G. Heywang, S. Roth, *Angew. Chem. Int. Ed. Engl.*, 1991, **30**, 176; (b) G. Heywang, L. Born, S. Roth, *Synth. Met.*, 1991, 1073.
23. (a) T. Ishiguro, K. Yamaji, 'Organic Superconductors', Springer-Verlag, Berlin, 1990; (b) J. M. Williams, A. J. Schultz, U. G. Geiser, K. D. Carlson, A. M. Kini, H. H. Wang, W. K. Kwok, M. -H. Whangbo, J. E. Schriber, *Science*, 1991, **252**, 1501.
24. (a) R. Lapouyade, J. P. Morand, D. Chasseau, J. Amiell, P. Delhaes, *Synth. Met.*, 1986, **16**, 385; (b) R. Lapouyade, J.-P. Morand, *J. Chem. Soc., Chem. Commun.*, 1987, 223.
25. H. Tani, K. Nii, K. Masumoto, N. Azuma, N. Ono, *Chem. Lett.*, 1993, 1055.
26. H. Tani, *Bull. Chem. Soc. Jpn.*, 1995, **68**, 661.
27. (a) A. Krief, *Tetrahedron*, 1986, **42**, 1209; (b) G. Schukat, E. Fanghänel, *Sulfur Rep.*, 1993, **14**, 245.

28. A. J. Moore, M. R. Bryce, *Synthesis*, 1997, 407.
29. Y. A. Jackson, C. L. White, M. V. Lakshmikantham, M. P. Cava, *Tetrahedron Lett.*, 1987, **28**, 5635.
30. M. D. Mays, R. D. McCullough, D. O. Cowan, T. O. Poehler, W. A. Bryden, T. J. Kistenmacher, *Solid State Commun.*, 1988, **65**, 1089.
31. J. P. Ferraris, T. O. Poehler, A. N. Bloch, T. O. Cowan, *Tetrahedron Lett.*, 1973, 2553.
32. J. M. Williams, M. A. Beno, H. -H. Wang, T. J. Emge, P. T. Copps, N. L. Hall, K. D. Carlson, G. W. Crabtree, *Philos. Trans. R. Soc. London, Ser. A*, 1985, **314**, 83.
33. K. Tanigaki, K. Prassides, *J. Mater. Chem.*, 1995, **5**, 1515.
34. M. Mizuno, A. F. Garito, M. P. Cava, *J. Chem. Soc., Chem. Commun.*, 1978, 18.
35. (a) V. Y. Lee, E. M. Engler, R. R. Schumaker, S. S. Parkin, *J. Chem. Soc., Chem. Commun.*, 1983, 235; (b) R. Kato, H. Kobayashi, A. Kobayashi, *Chem. Lett.*, 1986, 785.
36. H. H. Wang, L. K. Montgomery, U. Geiser, L. C. Porter, K. D. Carlson, J. R. Ferraro, J. M. Williams, C. S. Cariss, R. L. Rubenstein, J. R. Whitworth, *Chem. Mater.*, 1989, **1**, 140.
37. (a) E. B. Yagubskii, I. F. Schegolev, V. N. Laukin, P. A. Karatsovnik, M. V. Karatsovnik, A. V. Zvarykina, L. I. Buravov, *J.E.T.P. Lett. (Engl. Trans.)*, 1984, **39**, 12; (b) J. E. Schriber, L. J. Azevedo, J. K. Kwak, E. L. Venturini, P. C. W. Leung, M. A. Beno, H. H. Wang, J. M. Williams, *Phys. Rev. B.*, 1986, **33**, 1987.
38. K. Murata, M. Tokumoto, H. Anzai, H. Bando, K. Kajimura, T. Ishiguro, *Synth. Met.*, 1986, **13**, 3.

39. P. J. Nigrey, B. Morosin, J. F. Kwak, E. L. Venturini, R. J. Baughman, *Synth. Met.*, 1986, **16**, 1.
40. (a) G. C. Papavassiliou, G. A. Mousdis, J. S. Zambounis, A. Terzis, A. Hountas, B. Hilti, C. W. Mayer, J. Pfeiffer, *Synth. Met.*, 1988, **B27**, 379; (b) A. M. Kini, M. A. Bono, D. Son, H. H. Wang, K. D. Carlson, L. C. Porter, U. Welp, B. A. Vogt, J. M. Williams, D. Jung, M. Evain, M. -H. Whangbo, D. L. Overmyer, J. E. Schriber, *Solid State Commun.*, 1989, **69**, 503.
41. K. Kikuchi, Y. Honda, Y. Ishikawa, K. Saito, I. Ikemoto, K. Murata, H. Anzai, T. Ishiguro, K. Kobayashi, *Solid State Commun.*, 1988, **66**, 405.
42. Z. Yoshida, T. Kawase, H. Awaji, I. Sugimoto, T. Sugimoto, S. Yoneda, *Tetrahedron Lett.*, 1983, **24**, 3469.
43. Z. Yoshida, T. Kawase, H. Awaji, S. Yoneda, *Tetrahedron Lett.*, 1983, **24**, 3473.
44. (a) T. Kawase, H. Awaji, S. Yoneda, Z. Yoshida, *Heterocycles*, 1982, **18**, 123; (b) M. R. Bryce, *Chem. Soc. Rev.*, 1991, **20**, 355; (c) V. Yu. Khodorkovskii, L. N. Veselova, O. Ya. Neiland, *Khim. Geterotsykl. Soedin.*, 1990, 130; *Chem. Abstr.*, 1990, **113**, 22868t; (d) T. K. Hansen, M. V. Lakshikantham, M. P. Cava, R. M. Metzger, J. Becher, *J. Org. Chem.*, 1991, **56**, 2720; (e) A. J. Moore, M. R. Bryce, D. J. Ando, M. B. Hursthouse, *J. Chem. Soc., Chem. Commun.*, 1991, 320.
45. M. R. Bryce, A. J. Moore, M. A. Coffin, G. J. Marshallsay, G. Cooke, P. J. Skabara, A. S. Batsnov, J. A. K. Howard, W. Clegg, *Phosphorus, Sulfur, and Silicon*, 1993, **74**, 279.
46. Y. Misaki, T. Ohta, N. Higuchi, H. Fujiwara, T. Yamabe, T. Mori, H. Mori, S. Tanaka, *J. Mater. Chem.*, 1995, **5**, 1571, and references therein.
47. A. J. Moore, M. R. Bryce, *J. Chem. Soc. Perkin Trans. 1*, 1991, 157, and references therein.
48. H. Awaji, T. Sugimoto, Z. Yoshida, *J. Phys. Org. Chem.*, 1988, **1**, 47.

49. M. R. Bryce, A. J. Moore, M. Hasan, G. J. Ashwell, A. T. Frazer, W. Clegg, M. B. Hursthouse, A. I. Karaulov, *Angew. Chem. Int. Ed. Engl.*, 1990, **29**, 1450.
50. T. Otsubo, K. Takimiya, *Reviews on Heteroatom Chemistry*, 1997, **16**, 69.
51. For a review on TTT and TST, see I. F. Schegolev, E. B. Yagubskii, *Extended Linear Chain Compounds*, Ed. J. S. Miller, Plenum Press, New York, 1982, Vol 2, 385.
52. (a) J. Riga, J. J. Verbist, C. Lamotte, J. -M. Andre, *Bull. Soc. Chim. Belg.*, 1978, **87**, 163; (b) D. J. Sandman, G. P. Ceaser, P. Nielson, A. J. Epstein, T. J. Holmes, *J. Am. Chem. Soc.*, 1978, **100**, 202; (c) T. A. Chibisova, V. V. Redchenko, S. G. Semenov, S. S. Kramarenko, T. I. Solomentseva, V. I. Rogovik, V. S. Bannikov, V. F. Traven, *Zh. Obshch. Khim.*, 1990, **60**, 421.
53. For a review of 1,2-dithiole compounds, see C. Th. Pedersen, *Sulfur Rep.*, 1980, **1**, 1.
54. D. J. Sandman, J. S. Stark, B. M. Foxman, *Organometallics*, 1982, **1**, 739.
55. H. Miyamoto, K. Takimiya, Y. Aso, T. Otsubo, F. Ogura, *Synth. Met.*, 1991, **42**, 2389.
56. (a) L. I. Buravov, G. I. Zvereva, V. F. Kaminskii, L. P. Rozenberg, M. L. Khidekel, R. P. Shibaeva, E. B. Yagubskii, *J. Chem. Soc. Chem. Commun.*, 1976, **18**, 720; (b) R. P. Shibaeva, V. F. Kaminskii, *Kristallografiya*, 1978, **23**, 499.
57. B. Hilti, C. W. Mayer, G. Rihs, *Helv. Chim. Acta*, 1978, **61**, 1462.
58. T. Maruo, M. T. Jones, M. Singh, N. P. Rath, *Chem. Mater*, 1991, **3**, 630.
59. H. Miyamoto, Y. Aso, T. Otsubo, F. Ogura, *Bull. Chem. Soc. Jpn.*, 1990, **63**, 2441.
60. S. Ohnishi, T. Nogami, H. Mikawa, *Tetrahedron Lett.*, 1983, **24**, 2401.

61. H. Enders, H. J. Keller, J. Queckbörner, J. Veigel and D. Schweitzer, *Mol. Cryst. Liq. Cryst.*, 1982, **86**, 111.
62. S. Ohnishi, T. Nogami, H. Mikawa, *Chem. Lett.*, 1982, 1841.
63. T. Nogami, H. Tanaka, S. Ohnishi, Y. Tasaka, H. Mikawa, *Bull. Chem. Soc. Jpn.*, 1984, **57**, 22.
64. (a) K. Takimiya, H. Miyamoto, Y. Aso, T. Otsubo, F. Ogura, *Chem. Lett.*, 1990, 567; (b) K. Takimiya, Y. Aso, T. Otsubo, F. Ogura, *Bull. Chem. Soc. Jpn.*, 1991, **64**, 2091.
65. (a) K. Takimiya, A. Ohnishi, Y. Aso, T. Otsubo, F. Ogura, K. Kawabata, K. Tanaka, M. Mizutani, *Bull. Chem. Soc. Jpn.*, 1994, **67**, 766; (b) M. Yanai, K. Kawabata, T. Sambongi, Y. Aso, K. Takimiya, T. Otsubo, *Synth. Met.* 1996, **79**, 155; (c) M. Nakata, A. Kobayashi, T. Saito, H. Kobayashi, K. Takimiya, T. Otsubo, F. Ogura, *J. Chem. Soc., Chem. Commun.*, 1997, 593.
66. (a) J. Meinwald, D. Dauplaise, J. Clardy, *J. Am. Chem. Soc.*, 1977, **99**, 255; (b) D. Dauplaise, J. Meinwald, J. C. Scott, H. Temkin, J. Clardy, *J. Am. Chem. Soc.*, 1977, **99**, 7743; (c) D. Dauplaise, J. Meinwald, J. C. Scott, H. Temkin, J. Clardy, *Ann. N. Y. Acad. Sci.*, 1978, **313**, 382.
67. J. Meinwald, D. Dauplaise, J. Clardy, *J. Am. Chem. Soc.*, 1977, **99**, 1977.
68. K. Yui, Y. Aso, T. Otsubo, F. Ogura, *Bull. Chem. Soc. Jpn.*, 1988, **61**, 953.
69. F. Wudl, D. E. Schafer, B. Miller, *J. Am. Chem. Soc.*, 1976, **98**, 252.
70. T. Nogami, H. Tanaka, S. Ohnishi, Y. Tasaka, H. Mikawa, *Bull. Chem. Soc. Jpn.*, 1984, **57**, 22.
71. (a) A. Yamahira, T. Nogami, H. Mikawa, *J. Chem. Soc., Chem. Commun.*, 1983, 904; (b) J. C. Stark, R. Reed, L. A. Acampora, D. J. Sandman, S. Jansen, M. T. Jones, B. M. Foxman, *Organometallics*, 1984, **3**, 732.
72. (a) T. Otsubo, N. Sukenobe, Y. Aso, F. Ogura, *Chem. Lett.*, 1987, 315; (b) T. Otsubo, N. Sukenobe, Y. Aso, F. Ogura, *Synth. Met.*, 1988, **27**, B509.

73. Y. Aso, K. Yui, T. Miyoshi, T. Otsubo, F. Ogura, J. Tanaka, *Bull. Chem. Soc. Jpn.*, 1988, **61**, 2013.
74. L. -Y. Chiang, J. Meinwald, *Tetrahedron Lett.*, 1980, **21**, 4565.
75. H. Miyamoto, K. Yui, Y. Aso, T. Otsubo, F. Ogura, *Tetrahedron Lett.*, 1986, **27**, 2011.
76. T. Otsubo, H. Miyamoto, Y. Aso, F. Ogura, *Synth. Met.*, 1987, **19**, 595.
77. K. Takimiya, Y. Shibata, A. Ohnishi, Y. Aso, T. Otsubo, F. Ogura, *J. Mater. Chem.*, 1995, **5**, 1539.
78. For a review Weitz type donors, see: K. Deuchert, S. Hünig, *Angew. Chem., Int. Ed. Engl.*, 1978, **17**, 875.
79. T. Otsubo, *Synlett.*, 1996, 544, and references therein.
80. K. Nakasuji, H. Kubota, T. Kotani, I. Murata, G. Saito, T. Enoki, K. Imaeda, H. Inokuchi, M. Honda, C. Katayama, J. Tanaka, *J. Am. Chem. Soc.*, 1986, **108**, 3460.
81. K. Nakasuji, M. Sasaki, T. Kotani, I. Murata, T. Enoki, K. Imaeda, H. Inokuchi, A. Kawamoto, J. Tanaka, *J. Am. Chem. Soc.*, 1987, **109**, 6970.
82. A. Kawamoto, J. Tanaka, A. Oda, H. Mizumura, I. Murata, K. Nakasuji, *Bull. Chem. Soc. Jpn.*, 1990, **63**, 2137.
83. J. B. Christensen, I. Johannsen, K. Bechgaard, *J. Org. Chem.*, 1991, **56**, 7055.
84. Y. Morita, T. Ohmae, J. Toyoda, S. Matsuda, F. Toda, K. Nakasuji, *Chem. Lett.*, 1993, 443.
85. B. D. Tilak, *Indian Acad. Sci., Sect. A*, 1951, **33A**, 71.
86. (a) N. Thorup, G. Rindorf, C. S. Jacobsen, K. Bechgaard, I. Johannsen, K. Mortensen, *Mol. Cryst. Liq. Cryst.*, 1985, **120**, 349; (b) K. Bechgaard, *Mol. Cryst. Liq. Cryst.*, 1985, **125**, 81.

87. K. Nakasuji, *Pure and Appl. Chem.*, 1990, **62**, 477.
88. J. -P. Buisson, P. J. Demerseman, *J. Heterocycl. Chem.*, 1990, **27**, 2213.
89. N. Thorup, M. Hjorth, J. B. Christensen, K. Bechgaard, *Synth. Met.*, 1993, 2069.
90. F. Wudl, R. C. Haddon, E. T. Zellers, F. B. Branwell, *J. Org. Chem.*, 1979, **44**, 2491.
91. K. Nakasuji, A. Oda, J. Toyoda, I. Murata, *J. Chem. Soc., Chem. Commun.*, 1990, 366.
92. K. Nakasuji, A. Oda, I. Murata, K. Imaeda, H. Inokuchi, *J. Chem. Soc., Chem. Commun.*, 1989, 1553.
93. Fischer, J. Larsen, J. B. Christensen, M. Fourmigué, H. G. Madsen, N. Harrit, *J. Org. Chem.*, 1996, **61**, 6997.
94. M. Mizuno, M. P. Cava, A. F. Garito, *J. Org. Chem.*, 1976, **41**, 1485.
95. K. S. Varma, N. Sasaki, R. A. Clark, A. E. Underhill, O. Simonsen, J. Becher, S. Bøwadt, *J. Heterocycl. Chem.*, 1988, 783.
96. T. Sugimoto, I. Sugimoto, A. Kawashiman, Y. Yamamoto, Y. Misaki, Z. -I. Yoshida, *Heterocycles*, 1987, **25**, 83.
97. N. Okada, G. Saito, T. Mori, *Chem. Lett.*, 1986, 311.
98. S. Nakatsuji, Y. Amano, H. Kawamura, H. Anzai, *J. Chem. Soc., Chem. Commun.*, 1994, 841.
99. R. L. Meline, R. L. Elsenbaumer, *Synthesis*, 1997, 617.
100. H. Tani, Y. Kawada, N. Azuma, N. Ono, *Tetrahedron Lett.*, 1994, **35**, 7051.
101. H. Tani, Y. Kawada, N. Azuma, N. Ono, *Mol. Cryst. Liq. Cryst.*, 1996, **278**, 131.

102. M. R. Bryce, A. Chesney, A. K. Lay, A. S. Batsanov, J. A. K. Howard, *J. Chem. Soc., Perkin Trans. 1*, 1996, 2451.
103. B. S. Ong, *Tetrahedron Lett.*, 1980, **21**, 4225.
104. H. Tani, T. Inamasu, R. Tamura, H. Suzuki, *Chem. Lett.*, 1990, 1323.
105. H. Yoshino, Y. Kawazoe, T. Taguchi, *Synthesis*, 1974, 713.
106. C. G. Francisco, R. Freire, R. Hernandez, J.A. Salazar, E. Suarez, *Tetrahedron Lett.*, 1984, **25**, 1621.
107. S. J. Chang, B. K. Ravi Shankar, H. Shechter, *J. Org. Chem.*, 1982, **47**, 4226.
108. (a) D. C. Green, *J. Org. Chem.*, 1979, **44**, 1476; (b) M. R. Bryce, G. Cooke, A. S. Dhindsa, D. Lorcy, A. J. Moore, M. C. Petty, M. B. Hursthouse, A. I. Karaulov, *J. Chem. Soc., Chem. Commun.*, 1990, 818; (c) A. J. Moore, M. R. Bryce, G. Cooke, G. J. Marshallsay, P. J. Skabara, A. S. Batsanov, J. A. K. Howard and S. T. A. K. Daley, *J. Chem. Soc., Chem. Commun.*, 1993, 1403; (d) J. Garín, J. Orduna, S. M. Uriel, A. J. Moore, M. R. Bryce, S. Wegener, D. S. Yufit, and J. A. K. Howard, *Synthesis*, 1994, 489; (e) A. S. Batsanov, M. R. Bryce, J. N. Heaton, A. J. Moore, P. J. Skabara, J. A. K. Howard, E. Ortí, P. M. Viruela and R. Viruela, *J. Mater. Chem.*, 1995, **5**, 1689.
109. (a) M. Schoufs, J. Meier, P. Vermeer and L. Brandsma, *Recl. Trav. Chim. Pays-Bas*, 1977, **96**, 259; (b) For a review of 1,4-dithiin chemistry see: K. Kobayashi and C. L. Gajurel, *Sulfur Rep.*, 1986, **7**, 123. See also: ref. 98.
110. Jutz, *Adv. Org. Chem.*, 1976, **9** pt.1, 225.
111. W. E. Parham, T. M. Roder and W. R. Hasek, *J. Amer. Chem. Soc.*, 1953, 1647.
112. W. E. Parham, in *Organic Sulfur Compounds*, N. Kharasch. ed., Pergamon Press, 1961, vol. 1, p. 248.

113. (a) C. A. Hunter, *Angew. Chem., Int. Ed. Engl.*, 1993, **32**, 1548; (b) C. A. Hunter, *Chem. Soc. Rev.*, 1994, **23**, 101.
114. Y. F. Khobragade and M. C. Gupta, *J. Macromol. Sci. - Pure and Appl. Chem.*, 1995, **A32**, 155.
115. H.P. Welzel, G. Kossmeril, H. Stein, J. Schneider and W. Plieth, *Electrochim. Acta*, 1995, **40**, 577.
116. L. Y. Chiang, P. Shu, D. Holt, D. Cowan, *J. Org. Chem.*, 1983, **48**, 4713.
117. (a) S. Murata, T. Suzuki, A. Yanagisawa, S. Suga, *J. Heterocycl. Chem.*, 1991, **28**, 433; (b) L. Engman, *J. Heterocycl. Chem.*, 1984, **21**, 413.
118. T. Wirth, *Angew. Chem. Int. Ed. Engl.*, 1995, **34**, 1726.
119. (a) J. Behrens, W. Hinrichs, T. Link, C. Schiffing, G. Klar, *Phosphorus, Sulfur and Silicon*, 1995, **101**, 235; (b) W. Hinrichs, J. Kopf, K.-W. Stender, G. Klar, *Z. Naturforsch.*, 1984, **40b**, 39; K. Stender, G. Klar, M. Peo, W. Bauhofer, S. Roth, *Mol. Cryst. Liq. Cryst.*, 1985, **120**, 277.
120. M. R. Bryce, G. R. Davison, A. S. Batsanov, J. A. K. Howard, *J. Chem. Soc. Perkin Trans. 1*, 1992, 2295.
121. A. Orahovatz, M. I. Levinson, P. J. Carroll, M. V. Lakshmikantham, M. P. Cava, *J. Org. Chem.*, 1985, **50**, 1550.
122. (a) Y. Kono, H. Miyamoto, Y. Aso, T. Otsubo, F. Ogura, T. Tanaka and M. Sawada, *Angew. Chem. Int. Ed. Engl.*, 1989, **28**, 1222; (b) F. Wudl, R. C. Haddon, E. T. Zellers, F. B. Bramwell, *J. Org. Chem.*, 1979, **44**, 2491.
123. W. Schroth, R. Borsdorf, R. Herzsuh, J. Seidler, *Z. Chem.*, 1970, **10**, 147.
124. F. Wudl, M. R. Bryce, *J. Chem. Ed.*, 1990, **67**, 717.
125. J. S. Chappel, A. N. Bloch, W. A. Bryden, M. Maxfield, T. O. Poehler and D. O. Cowan, *J. Am. Chem. Soc.*, 1981, **103**, 2442.

126. M. R. Bryce, A. M. Grainger, M. Hasan, G. J. Ashwell, P. A. Bates and M. B. Hursthouse, *J. Chem. Soc., Perkin Trans. 1*, 1992, 611.
127. (a) M. R. Bryce, J. A. K. Howard, *Tetrahedron Lett.*, 1982, **23**, 4273; (b) M. R. Bryce, J. A. K. Howard, *Tetrahedron Lett.*, 1983, **24**, 1205.
128. (a) A. Gavezzotti, *J. Amer. Chem. Soc.*, 1983, **105**, 5220; (b) G. Filippini and A. Gavezzotti, *Acta Crystallogr., Sect. B*, 1993, **49**, 868.
129. J. Russell, *Org. Magn. Reson.*, 1972, **4**, 433.
130. (a) K. S. Varma, N. Sasaki, R. A. Clark, A. E. Underhill, O. Simonsen, J. Becher, S. Bøwadt, *J. Het. Chem.*, 1988, 783. (b) K. Inoue, Y. Tasaka, O. Yamazaki, T. Nogami, H. Mikawa, *Chem. Lett.*, 1986, 781.
131. T. Knieß, R. Mayer, *Z. Naturforsch.*, 1996, **51 b**, 901.
132. T. K. Hansen; M. Sc. Thesis, Odense University, 1989.
133. K. S. Varma, S. Edge, A. E. Underhill, J. Becher, G. Bojesen, *J. Chem. Soc. Perkin Trans. 1*, 1990, 2563.
134. C. Martí, J. Iurre, A. Alvarez-Larena, J. F. Piniella, E. Brillas, L. Fajarí, C. Alemán, L. Juliá, *J. Org. Chem.*, 1994, **59**, 6200.
135. J. Larsen, K. Bechgaard, *J. Org. Chem.*, 1987, **52**, 3285.
136. B. M. Trost, D. R. Brittelli, *J. Am. Chem. Soc.*, 1967, **32**, 2620.
137. G. Steimecke, H-J. Sieler, R. Krimse, E. Hoyer; *Phosphorus and Sulfur*, 1979, vol.7, pp49-55.
138. A. Orahovatz, M. I. Levinson, P. J. Carroll, M. V. Lakshmikantham, M. P. Cava, *J. Org. Chem.*, 1985, **50**, 1550.
139. G. Steimecke, R. Kirmse, E. Hoyer, *Z. Chem.*, 1975, **15**, 28.
140. N. Svenstrup, J. Becher, *Synthesis*, 1995, 215.

141. O. Ya. Neilands, Ya. Ya. Katsens, Ya. N. Kreitsberga, *Zh. Org. Khim.*, 1989, **25**, 658.
142. X. Yang, T. B. Rauchfuss, S. Wilson, *J. Chem. Soc., Chem. Commun.*, 1990, 34.
143. S. K. Kumer, H. B. Singh, J. P. Jasinski, E. S. Paight, R. J. Butcher, *J. Chem. Soc., Perkin Trans. I*, 1991, 3341.
144. N. Svenstrup, M.Sc Thesis, Odense, 1994.
145. H. E. Simmons, D. C. Blomstrom, R. D. Vest, *J. Am. Chem. Soc.*, 1962, **84**, 4756.
146. H. E. Simmons, D. C. Blomstrom, R. D. Vest, *J. Am. Chem. Soc.*, 1962, **84**, 4772.
147. R. S. Medne, Ya. Ya. Katsens, I. L. Kraupsha, O. Ya. Neilands, *Khim. Geterotsikl. Soedin*, 1991, 1317.
148. V. Y. Khodorkovsky, J. Y. Becker, J. Bernstein, *Synthesis*, 1992, 1071.
149. A. I. Kotov, C. Faulmann, P. Cassoux, E. B. Yagubskii, *J. Org. Chem.*, 1994, **59**, 2626.
150. N. C. Deno, *J. Am. Chem. Soc.*, 1950, 4057.
151. K. Hartke, T. Kissel, J. Quante, R. Matusch, *Chem. Ber.*, 1980, **113**, 1898.
152. N. Svenstrup, J. Becher, *Synthesis*, 1995, 215.
153. J. M. Williams, A. J. Schultz, U. Geiser, K. D. Carlson, A. M. Kini, H. Hau Wang, W. -K. Kwok, M. -H. Whangbo, J. E. Schirber, *Science*, 1991, **252**, 1501, and references therein.
154. For example see reference 12 and references cited therein
155. N. Svenstrup, K. M. Rasmussen, T. K. Hansen, J. Becher, *Synthesis*, 1994, 809.

156. (a) T. Nakamura, S. Iwasaka, H. Nakano, I. Kazuhiko, T. Nogami, H. Mikawa, *Bull. Chem. Soc. Jpn.*, 1987, **60**, 365. (b) H. Nakano, T. Nakamura, T. Nogami, Y. Shirota, *Chem. Lett.*, 1987, 1317. (c) H. Nakano, T. Nogami, Y. Shirota, *Bull. Chem. Soc. Jpn.*, 1988, **61**, 2973.
157. P. J. Skabara, Ph.D. Thesis, University of Durham, 1994.
158. P. L. Pauson, W. E. Watts, *J. Chem. Soc.*, 1963, 2990.
159. (a) P. Shu, L. Chiang, T. Emge, D. Holt, T. Kistenmacher, M. Lee, J. Stokes, T. Poehler, D. Cowan, *J. Chem. Soc., Chem. Commun.*, 1981, 920. (b) D. O. Cowan, L. -Y. Chiang, P. Shu, D. Holt, *J. Org. Chem.*, 1983, **48**, 473. (b) R. Ketchwan, A. -B. Hornfeldt, S. Gronowitz, *J. Org. Chem.*, 1984, **49**, 1117. (d) K. Zong, W. Chen, M. P. Cava, R. D. Rogers, *J. Org. Chem.*, 1996, **61**, 8117.
160. P. D. Williams, E. LeGoff, *J. Org. Chem.*, 1981, **46**, 4143.
161. C. Paal, *Chem. Ber.*, 17, 2757 (1884); L. Knorr, *Chem. Ber.*, 17, 2863 (1884).
162. G. Steimecke, H.-J. Sieler, R. Kirmse, W. Dietzch, E. Hoyer, *Phosphorus Sulfur*, 1982, **12**, 237.
163. A. Bondi, *J. Phys. Chem.*, 1964, **68**, 441.
164. (a) G. Casalone, A. Mugnoli, *J. Chem. Soc. B*, 1971, 415; (b) P. T. Beurskens, W. P. J. H. Bosman, J. A. Cras, *J. Cryst. Mol. Struct.*, 1972, **2**, 183; (c) W. Winter, H. Buhl, H. Meier, *Z. Naturforsch. Teil B*, 1980, **35**, 1015; (d) U. Kunze, P. Merkel, W. Winter, *Chem. Ber.*, 1982, **115**, 3653; (e) F. Bigoli, M. A. Pellinghelli, G. Crisponti, P. Deplano, E. F. Trogu, *J. Chem. Soc. Dalton Trans.*, 1985, 1349.
165. I. P. Mellor, S. C. Nyburg, *Acta Crystallogr. Sect. B*, 1971, **27**, 1959.
166. M. Kim, G. I. Birnbaum, R. C. Hynes, W. Neugebauer, P. R. Carey, *J. Amer. Chem. Soc.*, 1993, **115**, 6230; and references therein.

167. (a) H. B. Bürgi, *Angew. Chem. Int. Ed.*, 1975, **14**, 460 (review); (b) Yu. Wang, M. J. Chen, C. H. Wu, *Acta Crystallogr. Sect. B*, 1988, **44**, 179; (c) Yu. Wang, S. Y. Wu and M. J. Cheng, *Acta Crystallogr. Sect. B*, 1990, **46**, 850 and references therein.
168. J. Sletten, *Acta Chem. Scand.*, 1973, **27**, 229; *ibid. Sect. A*, 1974, **28**, 499, and references therein.
169. V. Galasso, *Mol. Phys.*, 1976, **31**, 65.
170. T. Ewen, J. B. Cohen, *J. Chem. Soc.*, 1889, **55**, 580.

Appendix One

A Novel 1,2,4-Trithiolane

A.1 A NOVEL 1,2,4-TRITHIOLANE

In the course of our investigations we synthesised the known compound 4,5-dithiomethyl-1,2-dithiole-3-thione **236**.¹⁶² In the process of characterising **236** the compound was dissolved in deuterated chloroform, placed in a standard NMR tube and left in sunlight for 1-2 days. After this period small, shiny, black crystals were noticed on the interior walls of the NMR tube. The melting point and mass spectrum of these crystals led us to believe that they were not the original compound **236**. The crystals were insoluble in a range of common solvents and only very small quantities (< 1 mg) were obtained. Two portions of compound **236** (5mg) were separately dissolved in dichloromethane (7ml) and placed in standard NMR tubes. One of these tubes was placed in sunlight the other was kept in darkness. After 1 day the tube in the sunlight showed black crystals forming on its inside walls. The tube in darkness was left for 10 days after which no crystals were observed. We thus concluded that the formation of the unknown compound was initiated by light.

The black crystals were submitted for single crystal X-ray structure analysis the results of which revealed the unusual 1,2,4-trithiolane structure **237** (Figure A.1).

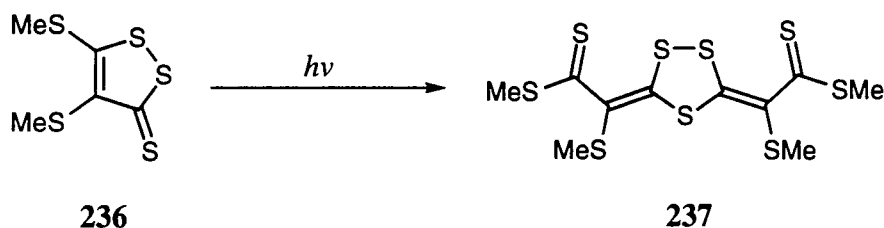

The structure (Figure A.1) shows that the molecule is essentially planar but for the out-of-plane orientations of the two methyl groups, C(34) and C(54), lying at 1.75 and 1.77 Å from the mean plane. Intramolecular distances S(1)...S(52) 2.775 Å and S(2)...S(32) 2.765 Å are much shorter than twice the Van der Waals radius of sulfur (1.80 Å).¹⁶³ The S(1)-S(2) bond (2.191 Å) is longer than that found in 1,2,4-trithiolane derivatives which have no additional S...X interactions (2.04-2.07 Å)¹⁶⁴ or in **238** (2.10 Å) where short intramolecular S...O contacts of 2.51 Å exist.¹⁶⁵ Bonds C(32)=S(32) and C(52)=S(52) are longer than those usually found in dithioesters (average 1.62 Å)¹⁶⁶ and the C-C bonds between them and the ring show π -delocalisation.

Compound **237** thus shows both types of bond delocalization which are characteristic of derivatives of thiathiophthene **239**,¹⁶⁷ viz. a hypervalent bonding or bond / no-bond resonance in the linear S-S-S chain and π -delocalization in a 'fused' system of 5-membered ring and pseudo-ring. The degree of delocalization in **237** is lower than in asymmetric thiathiophthenes, where the difference between the 'long' and the 'short' S-S distances does not exceed 0.4 Å. However, similar compounds with a linear tetra- (rather than tri-) sulfur chain S...S-S...S, reported earlier,¹⁶⁸ show even

larger differences. Thus system **237** is actually a thiathiophene-like S_3 chain plus one weaker contact with an extra S atom **240**, rather than a more symmetrically delocalized one as depicted in **237**.

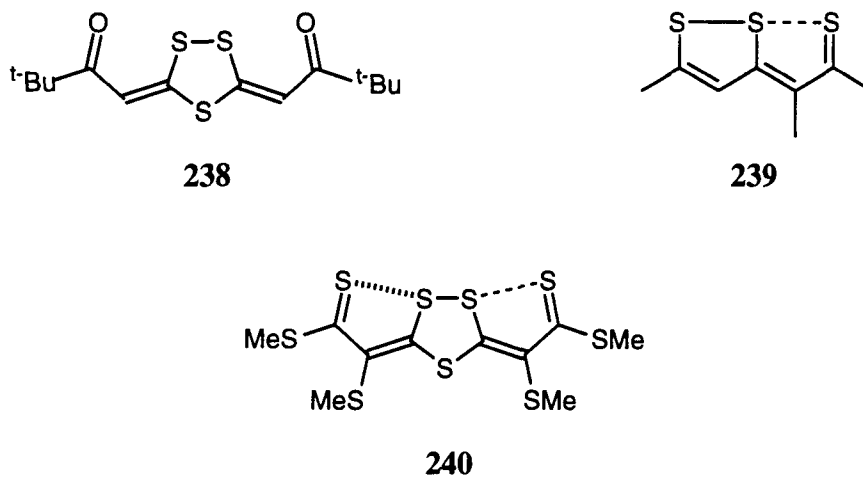

We have postulated a mechanism for the formation of compound **237** from **236** (Scheme A.1). This mechanism involves the rearrangement of **236** to the dipolar species **241** which subsequently undergoes a 1,3-dipolar addition to the thiocarbonyl group of another molecule of **236** to generate the spiro-intermediate **242**, which then rearranges as shown and expels a sulfur atom to form compound **237**.

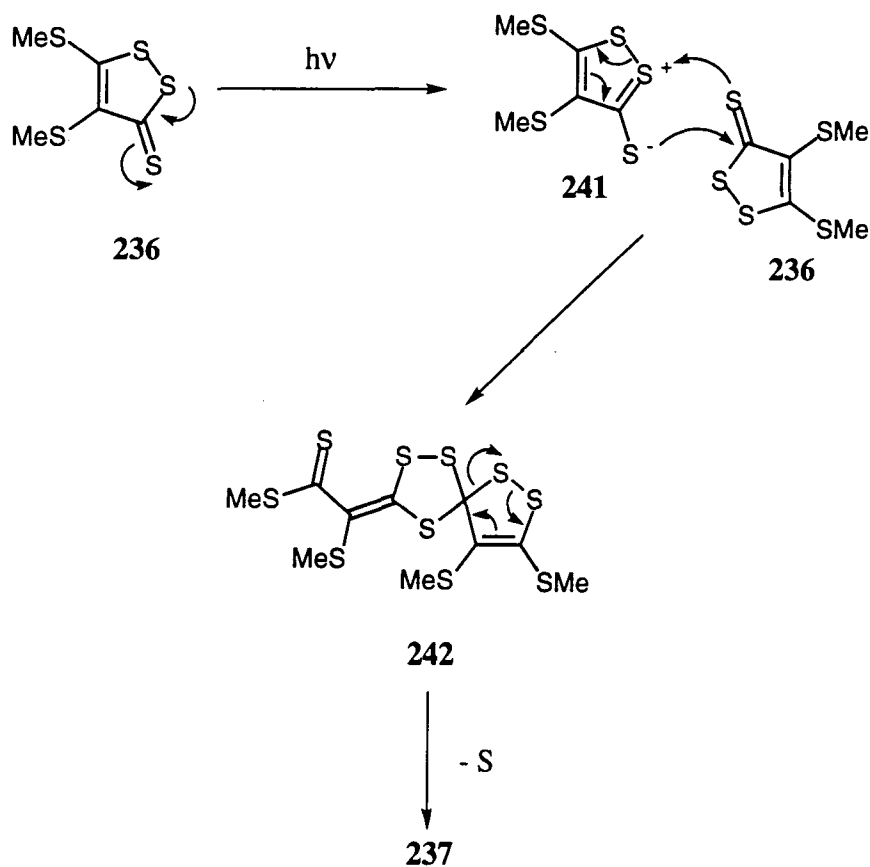

Scheme A.1

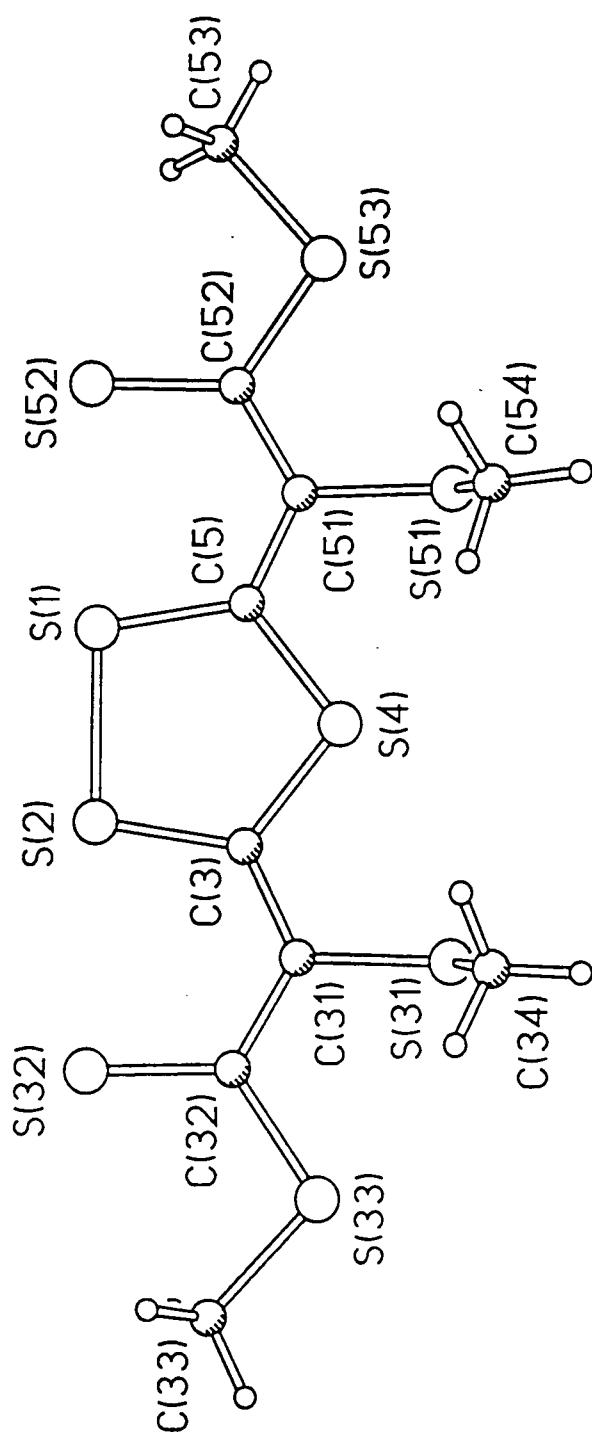

Figure A.1 Crystal structure of compound 237

Experimental

1,2,4-Trithiolane compound **237**

Compound **236**¹⁶² (10mg, 0.02mmoles) was dissolved in CDCl₃ (ca. 0.75ml) and placed in a standard NMR tube, which was then placed in sunlight for a week. After this time small black crystals of **237** formed on the tube sides and were removed by filtration. m.p. 167°C, m/z (CI) 389 (M⁺-2S+1, 100%). The structure was elucidated by X-ray analysis.

Appendix Two

Electron Spin Resonance Studies

A.2 ESR STUDIES

ESR studies of the cations and anions of certain donor compounds described in this thesis, were performed and interpreted by Prof. Fabian Gerson and his group at the University of Basel (Switzerland).

The radical ions were generated from their neutral precursors at 195 K, the cations with aluminium chloride in dichlorormethane and the anions with potassium mirror in 1,2-dimethoxyethane. They gave rise to well-resolved EPR spectra which were taken in the range 200-260 K. Analysis of their hyperfine patterns was carried out with the use of ^1H -coupling constants derived from the corresponding ENDOR spectra.

CATIONS

Coupling Constants in mT

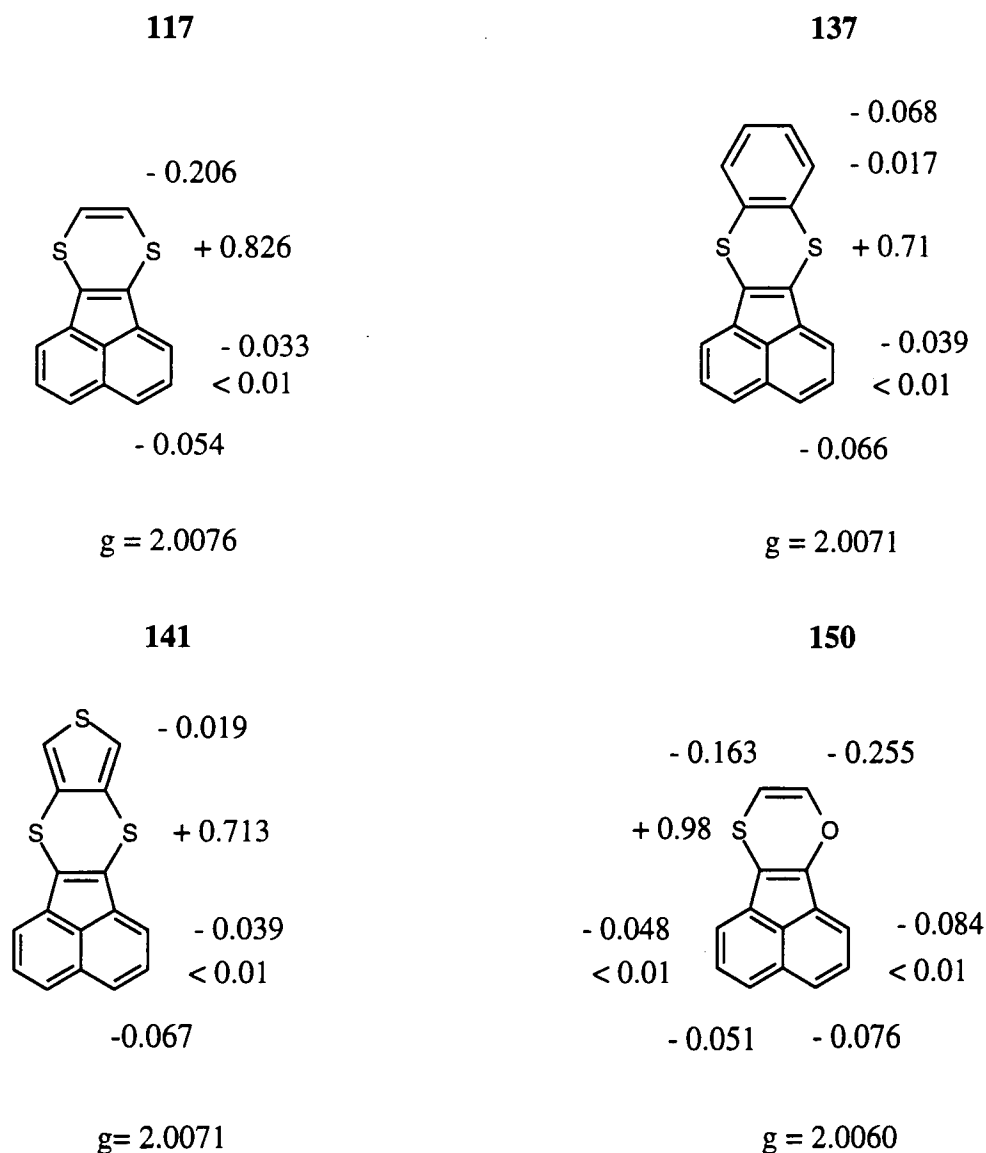

The π -spin densities of the cations of these compounds reveal that these species may be considered as "S-centred radicals". The bulk of the π -spin population is located at the heteroatoms and the S-containing ring. Accordingly, the ESR spectra (without the ^{33}S satellites) have a spectral width of only 0.4-0.6 mT.

ESR studies of the simple 1,4-dithiin (**160**) have also shown that in the radical cation a large spin density is located at the sulfur atoms.¹⁶⁹

ANIONS

Coupling Constants in mT

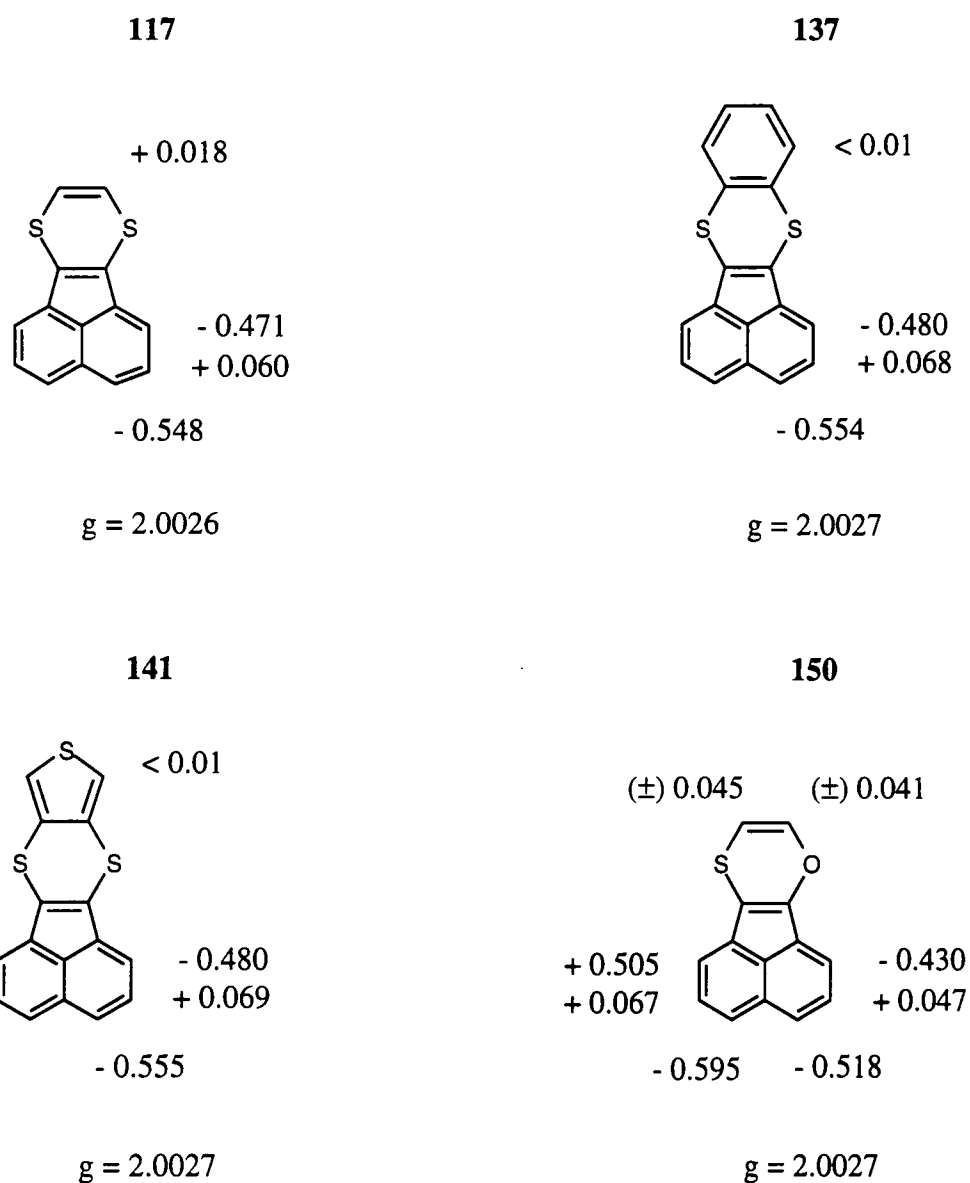

The π -spin densities of the anions of these compounds reveal that these species may be considered as "hydrocarbon radicals", structurally related to that of acenaphthylene. Accordingly, the ESR spectra have a spectral width of over 2.2mT.

As an example, the ESR spectra of the radical ions of the least symmetric compound (**150**) are shown below (fig. A.2). The different spectral widths and structure are apparent.

Cation

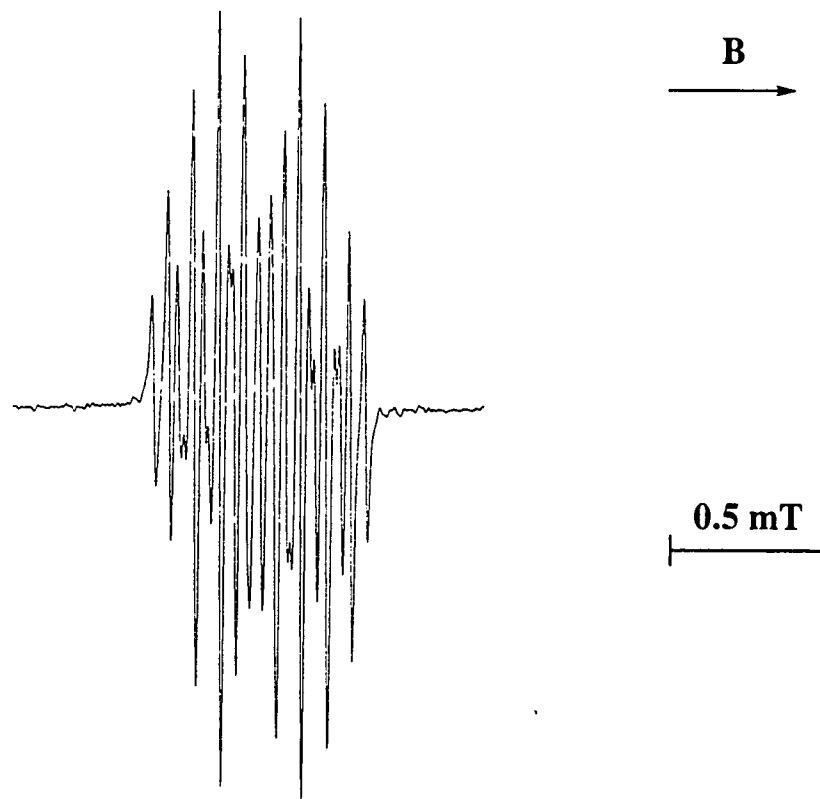

Anion

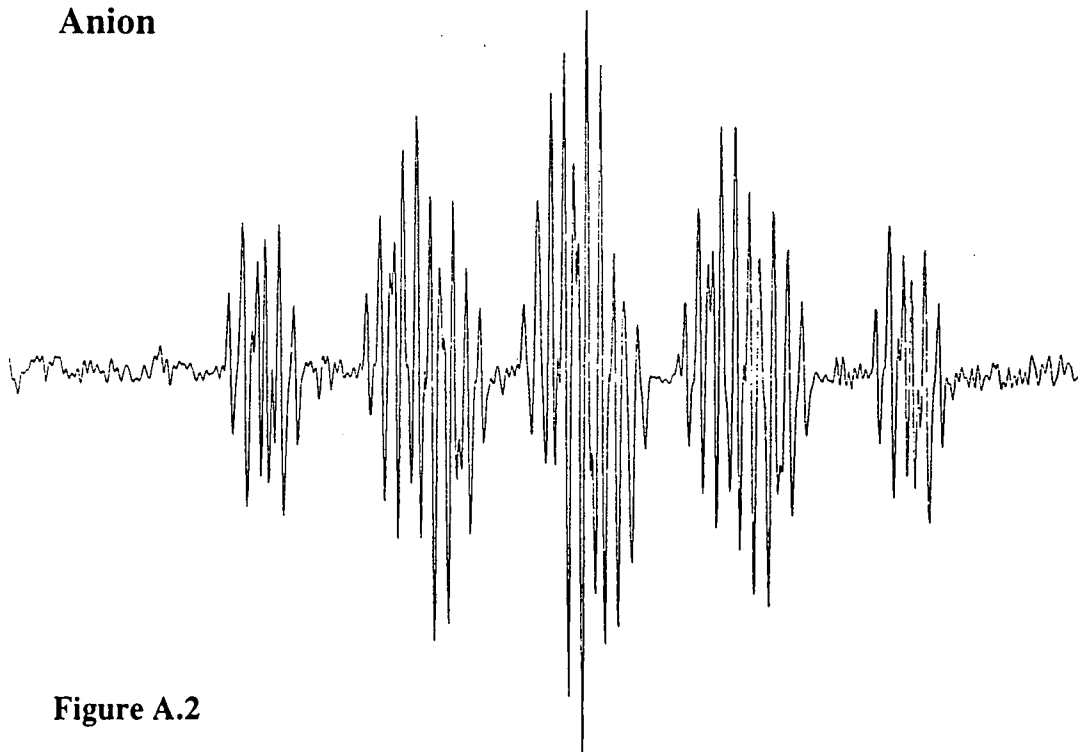
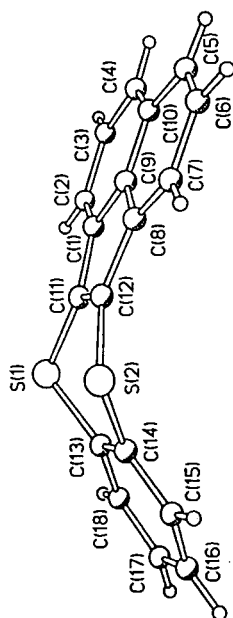

Figure A.2

Appendix Three
X-Ray Crystallographic Data

A3.1 7,12-Dithia-benzo[k]fluoranthene (137)



Crystal data and Structure refinement

Formula	C ₁₈ H ₁₀ S ₂	Scan mode	ω
<i>M</i>	290.38	2θ _{max} , °	46.5
<i>T</i> , K	293	Data total	4957
Radiation	Mo-Kα	Data unique	1915
λ, Å	0.71073	Data observed, I>2σ	1771
Symmetry	monoclinic	Rint(F ²)	0.034
<i>a</i> , Å	16.562(8)	Refined variables	222
<i>b</i> , Å	10.664(4)	Absorption corr.	none
<i>c</i> , Å	7.645(3)	Crystal size, mm	0.4×0.3×0.3
α, °	90	Extinction ^a , x	0.027(2)
β, °	94.55(3)	wR(F ²), all data	0.076
γ, °	90	Goodness-of-fit	1.09
<i>U</i> , Å ³	1346(1)	R(F), obs. data	0.029
Reflection/unit cell	317	Weights ^b , A, B	0.029, 0.59
θ range, °	2–20	Δρ _{max} , eÅ ⁻³	0.18
Space group	P2 ₁ /c	μ, cm ⁻¹	3.8
<i>Z</i>	4	<i>D</i> _c , g cm ⁻³	1.43
F(000)	600		

Bond lengths [Å] and angles [deg]	
S(1)–C(11)	1.747(2)
S(1)–C(12)	1.781(2)
S(2)–C(13)	1.778(2)
S(2)–C(14)	1.416(3)
C(1)–C(2)	1.371(3)
C(1)–C(3)	1.470(3)
C(2)–C(3)	1.428(3)
C(3)–C(4)	1.369(3)
C(4)–C(5)	1.370(3)
C(5)–C(6)	1.416(3)
C(6)–C(7)	1.410(3)
C(7)–C(8)	1.387(3)
C(8)–C(9)	1.391(3)
C(9)–C(10)	1.393(3)
C(10)–C(11)	1.374(3)
C(11)–C(12)	1.385(3)
C(12)–C(13)	1.385(3)
C(13)–C(14)	1.386(3)
C(14)–C(15)	1.394(3)
C(15)–C(16)	1.394(3)
C(16)–C(17)	1.385(3)
C(17)–C(18)	1.385(3)
C(11)–S(1)–C(12)	99.5(1)
C(2)–C(1)–C(3)	136.1(2)
C(3)–C(1)–C(2)	118.6(2)
C(4)–C(3)–C(2)	105.3(2)
C(5)–C(4)–C(3)	122.8(2)
C(6)–C(5)–C(4)	120.4(2)
C(7)–C(6)–C(5)	118.6(2)
C(8)–C(7)–C(6)	136.3(2)
C(9)–C(8)–C(7)	124.5(2)
C(10)–C(9)–C(8)	111.1(2)
C(11)–C(10)–C(9)	115.8(2)
C(12)–C(11)–C(10)	109.1(2)
C(13)–C(12)–C(11)	126.7(1)
C(14)–C(13)–C(12)	124.2(2)
C(15)–C(14)–C(13)	119.6(2)
C(16)–C(15)–C(14)	122.8(2)
C(17)–C(16)–C(15)	117.7(2)
C(18)–C(17)–C(16)	120.3(2)
C(11)–C(12)–C(13)	128.6(2)
C(12)–C(13)–C(14)	124.1(2)
C(13)–C(14)–C(15)	109.3(2)
C(14)–C(15)–C(16)	126.4(2)
C(15)–C(16)–C(17)	117.7(2)
C(16)–C(17)–C(18)	119.5(2)
C(17)–C(18)–C(17)	122.8(2)
C(18)–C(17)–C(18)	120.2(2)
C(17)–C(18)–C(17)	120.4(2)

A3.2 7,12-Dithia-benzo[k]fluoranthene (137) / 2,5-Dibromo-tetracyano-*p*-quinodimethane

Crystal data and structure refinement

Bond lengths [Å] and angles (deg)		Identification code	
Br(2)-C(02)	1.876(4)	21. Br ₂ TcNQ	
C(01)-C(07)	1.388(6)	C30 H12 Br ₂ N ₄ S ₂	
C(01)-C(02)	1.454(6)	652.38	
C(03)-C(04)	1.453(6)	150(2) K	
C(04)-C(05)	1.424(6)	1.54184 Å	
C(07)-C(71)	1.153(6)	Triclinic	
C(07)-C(72)	1.433(6)	P-1	
C(08)-C(82)	1.433(6)	a = 7.0648(8) Å	alpha = 97.337(8)°
C(08)-C(81)	1.148(6)	b = 10.2871(12) Å	beta = 98.577(8)°
C(11)-C(11)	1.734(4)	c = 18.822(2) Å	gamma = 109.071(8)°
S(2)-C(12)	1.726(4)	1255.4(2) Å ³	
C(1)-C(12)	1.375(6)	Z	
C(1)-C(11)	1.473(6)	Density (calculated)	1.726 Mg/m ³
C(3)-C(4)	1.366(8)	Absorption coefficient	5.884 mm ⁻¹
C(5)-C(6)	1.381(8)	F(000)	644
C(5)-C(7)	1.425(7)	Crystal size	0.56 x 0.17 x 0.04 mm
C(8)-C(9)	1.426(6)	Theta range for data collection	4.63 to 74.97 deg.
C(9)-C(10)	1.398(6)	Index ranges	-8<h<=8, -9<k<=12, -23<l<=23
C(13)-C(14)	1.394(7)	Reflections collected	6696
C(14)-C(15)	1.403(6)	Independent reflections	4568 [R(int) = 0.0531]
C(16)-C(17)	1.386(9)	Absorption correction	Semi-empirical from psi-scans
C(07)-C(03)	117.9(4)	Max. and min. transmission	1.0000 and 0.5084
C(03)-C(02)	115.2(4)	Refinement method	Full-matrix least-squares on F ²
C(03)-C(01)	116.9(3)	Data / restraints / parameters	4564 / 0 / 392
C(02)-C(03)	122.5(4)	Goodness-of-fit on F ²	1.114
C(08)-C(04)	117.5(4)	Final R indices [I>2sigma(I)]	R1 = 0.0463, WR2 = 0.1338
C(06)-C(05)	120.9(4)	R indices (all data)	R1 = 0.0557, WR2 = 0.1422
C(04)-C(05)	122.3(3)	Extinction coefficient	0.0030(4)
C(01)-C(07)	120.6(4)	Largest diff. peak and hole	.922 and -1.595 e.Å ⁻³
C(71)-C(07)	111.8(4)		
N(72)-C(72)	170.4(5)		
C(04)-C(08)	126.2(4)		
N(81)-C(81)	170.8(5)		
C(11)-S(1)	103.1(2)		
C(2)-C(1)	118.9(4)		
C(9)-C(1)	105.4(4)		
C(4)-C(3)	123.3(5)		
C(6)-C(5)	120.2(4)		
C(8)-C(7)	117.3(5)		
C(7)-C(8)	135.9(4)		
C(10)-C(9)	110.9(4)		
C(13)-C(11)	115.4(5)		
C(12)-C(11)	109.5(4)		
C(11)-C(11)	122.2(3)		
C(14)-C(13)	119.2(4)		
C(18)-C(13)	113.7(4)		
C(13)-C(14)	126.6(3)		
C(16)-C(15)	121.0(5)		
C(16)-C(17)	119.7(5)		
C(07)-C(03)	126.9(4)		
C(03)-C(02)	121.6(4)		
C(01)-C(02)	121.4(3)		
C(08)-C(04)	126.6(4)		
C(05)-C(04)	115.9(4)		
C(06)-C(05)	116.7(3)		
C(05)-C(06)	123.5(4)		
C(01)-C(07)	127.6(4)		
N(71)-C(71)	177.9(5)		
C(04)-C(08)	121.2(4)		
C(82)-C(81)	112.6(4)		
N(82)-C(82)	177.4(5)		
C(12)-S(2)	103.1(2)		
C(2)-C(1)	135.7(4)		
C(9)-C(1)	117.5(5)		
C(3)-C(4)	120.2(5)		
C(5)-C(6)	123.6(5)		
C(7)-C(8)	118.8(4)		
C(9)-C(8)	105.3(4)		
C(10)-C(9)	124.4(4)		
C(13)-C(11)	118.8(5)		
C(12)-C(11)	128.3(3)		
C(8)-C(7)	122.8(3)		
C(14)-C(13)	127.1(3)		
C(18)-C(13)	119.3(4)		
C(15)-C(14)	120.2(5)		
C(15)-C(16)	120.2(5)		
C(17)-C(16)	120.6(5)		

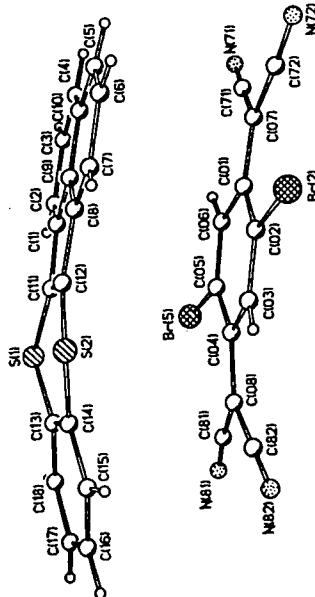

A3.3 8,9-Di(methylsulfanyl)acenaphthylene[1,2-b][1,4]dithiane (207)

Crystal data and structure refinement

Identification code 97srvi51
 Empirical formula C16 H12 S4
 Formula weight 332.50
 Temperature 295(2) K
 Wavelength 0.71073 Å
 Crystal system Monoclinic
 Space group P2(1)/n
 Unit cell dimensions
 $a = 11.928(1)$ Å $\alpha = 90$ deg.
 $b = 8.302(1)$ Å $\beta = 103.34(1)$ deg.
 $c = 15.736(1)$ Å $\gamma = 90$ deg.
 Volume 1516.2(2) Å³
 Z 4
 Density (calculated) 1.457 g/cm³
 Absorption coefficient 0.612 mm⁻¹
 F(000) 688
 Crystal size 0.40 x 0.18 x 0.08 mm
 Theta range for data collection 1.94 to 27.49 deg.
 Index ranges -15<h<16, -10<k<11, -22<l<15
 Reflections collected 9795
 Independent reflections 3472 [R(int)] = 0.0361
 Observed reflections, I>2sigma(I) 2533
 Absorption correction Integration
 Max. and min. transmission 0.9576 and 0.8319
 Refinement method Full-matrix least-squares on F²
 Data / restraints / parameters 3382 / 0 / 230
 Goodness-of-fit on F² 1.106
 Final R indices [I>2sigma(I)] R1 = 0.0466, wR2 = 0.0829
 R indices (all data) R1 = 0.0763, wR2 = 0.1048
 Extinction coefficient 0.0025(5)
 Largest diff. peak and hole 0.250 and -0.378 e.Å⁻³

Bond lengths [Å] and angles [deg]

S(1)-C(11)	1.753(3)	S(1)-C(13)	1.780(3)
S(2)-C(12)	1.749(3)	S(2)-C(14)	1.782(3)
S(3)-C(13)	1.767(3)	S(3)-C(15)	1.774(4)
S(4)-C(14)	1.765(3)	S(4)-C(16)	1.807(4)
C(1)-C(2)	1.374(4)	C(1)-C(9)	1.418(4)
C(1)-C(11)	1.473(4)	C(2)-C(3)	1.424(4)
C(2)-H(2)	0.94(3)	C(3)-C(4)	1.371(5)
C(3)-H(3)	0.95(3)	C(4)-C(10)	1.426(5)
C(4)-H(4)	0.93(3)	C(5)-C(6)	1.362(5)
C(5)-C(10)	1.323(5)	C(5)-H(5)	0.91(3)
C(6)-C(7)	1.322(4)	C(6)-H(6)	0.95(3)
C(7)-C(8)	1.371(4)	C(7)-H(7)	0.95(3)
C(8)-C(9)	1.314(4)	C(8)-C(12)	1.476(3)
C(9)-C(10)	1.357(4)	C(11)-C(12)	1.364(4)
C(13)-C(14)	1.341(4)	C(15)-H(15)	0.92(5)
C(15)-H(152)	0.96(4)	C(15)-H(153)	0.98(6)
C(16)-H(161)	0.94(4)	C(16)-H(162)	0.89(5)
C(16)-H(163)	0.97(4)		
C(11)-S(1)-C(13)	99.0(1)	C(12)-S(2)-C(14)	100.5(1)
C(13)-S(3)-C(15)	105.7(2)	C(14)-S(4)-C(16)	103.7(2)
C(2)-S(1)-C(11)	119.2(3)	C(15)-S(3)-C(14)	135.7(3)
C(9)-C(1)-C(11)	105.1(2)	C(1)-C(2)-C(3)	117.8(3)
C(11)-C(1)-C(2)	123.1(2)	C(3)-C(2)-H(2)	119(2)
C(4)-C(3)-C(2)	122.8(3)	C(4)-C(3)-H(3)	121(2)
C(2)-C(3)-H(3)	116(2)	C(3)-C(4)-C(10)	120.6(3)
C(3)-C(4)-H(4)	122(2)	C(10)-C(4)-H(4)	118(2)
C(6)-C(5)-C(10)	121.0(3)	C(16)-C(5)-H(5)	121(2)
C(10)-C(5)-H(5)	118(2)	C(5)-C(6)-C(7)	122.5(3)
C(5)-C(6)-H(6)	120(2)	C(7)-C(6)-H(6)	120(2)
C(8)-C(7)-C(6)	118.6(3)	C(7)-C(8)-C(9)	118.1(3)
C(7)-C(8)-H(7)	121(2)	C(9)-C(8)-C(12)	105.2(2)
C(8)-C(9)-C(10)	136.7(3)	C(10)-C(9)-C(11)	124.0(3)
C(9)-C(10)-C(5)	111.2(2)	C(9)-C(10)-C(4)	115.0(3)
C(10)-C(11)-C(1)	115.6(3)	C(15)-C(11)-C(4)	129.4(3)
C(11)-C(11)-C(1)	109.3(2)	C(11)-C(11)-S(1)	123.5(2)
C(11)-C(12)-S(2)	127.1(2)	C(8)-C(12)-S(2)	109.2(2)
C(14)-C(12)-S(2)	123.4(2)	C(14)-C(12)-C(11)	127.3(2)
S(3)-C(13)-S(1)	120.0(2)	C(13)-C(13)-S(1)	125.3(2)
S(3)-C(13)-S(4)	117.3(2)	C(13)-C(14)-S(4)	125.3(2)
S(4)-C(14)-S(2)	123.7(2)	S(4)-C(14)-S(2)	110.8(2)
S(3)-C(15)-H(151)	101(3)	S(3)-C(15)-H(152)	103(2)
H(151)-C(15)-H(152)	102(4)	S(3)-C(15)-H(153)	112(4)
H(151)-C(15)-H(153)	120(5)	H(152)-C(15)-H(153)	118(4)
S(4)-C(16)-H(161)	106(2)	S(4)-C(16)-H(162)	110(3)
H(161)-C(16)-H(162)	108(4)	S(4)-C(16)-H(163)	108(3)
H(161)-C(16)-H(163)	111(3)	H(162)-C(16)-H(163)	115(4)

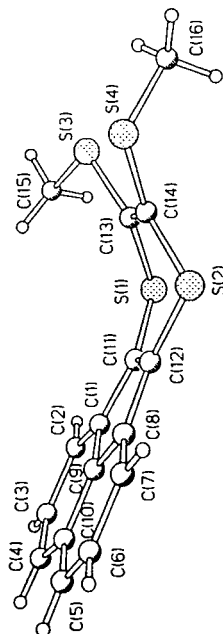

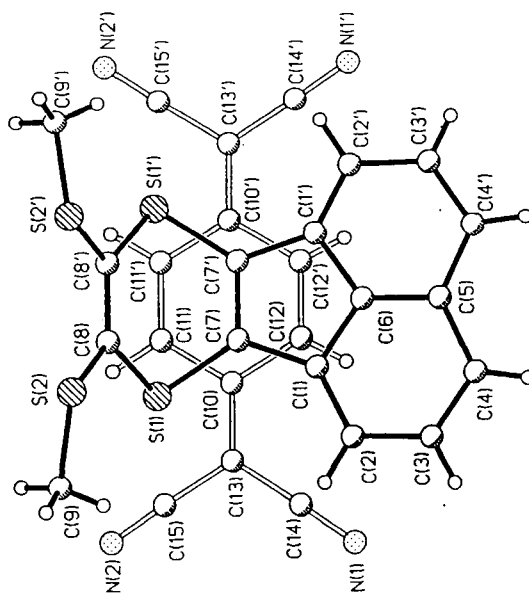
A3.4 7,12-Dithia-benzo[k]fluoranthene (207) / Tetracyano-*p*-quinodimethane

Bond lengths [Å] and angles [deg]

S(1)-C(7)	1.749(4)	S(1)-C(8)	1.787(4)
S(2)-C(8)	1.753(4)	S(2)-C(9)	1.804(5)
C(1)-C(2)	1.381(5)	C(1)-C(6)	1.417(5)
C(1)-C(7)	1.470(5)	C(2)-C(3)	1.415(6)
C(2)-H(2)	0.95(5)	C(3)-C(4)	1.376(6)
C(3)-H(3)	0.91(4)	C(4)-C(5)	1.439(4)
C(4)-H(4)	0.94(4)	C(5)-C(6)	1.387(8)
C(5)-C(4)	1.429(4)	C(6)-C(1)	1.416(5)
C(7)-C(8)	1.365(7)	C(8)-C(9)	1.355(7)
C(9)-H(9)	0.97(5)	C(9)-H(92)	0.94(5)
C(10)-H(93)	0.85(5)	C(10)-C(11)	1.373(5)
C(11)-C(12)	1.446(5)	C(11)-C(13)	1.447(5)
C(12)-C(11)	1.345(7)	C(12)-H(11)	1.02(2)
C(13)-C(12)	1.334(8)	C(13)-H(12)	0.88(4)
C(13)-C(14)	1.427(6)	C(13)-C(15)	1.447(6)
C(14)-N(1)	1.147(5)	C(15)-N(2)	1.141(5)
C(7)-S(1)	100.2(2)	C(8)-S(2)	104.1(2)
C(2)-C(1)	118.4(4)	C(2)-C(9)	136.2(3)
C(6)-C(1)	105.4(3)	C(1)-C(2)	118.3(4)
C(1)-C(2)	121(3)	C(3)-C(2)	121(3)
C(4)-C(3)	122.7(4)	C(4)-C(3)-H(2)	120(3)
C(2)-C(3)	117(3)	C(3)-C(4)	120.3(4)
C(3)-C(4)	117(2)	C(5)-C(4)	123(2)
C(6)-C(5)	115.7(3)	C(5)-C(4)-H(4)	115.7(3)
C(4)-C(5)	128.7(5)	C(6)-C(5)	124.6(2)
C(5)-C(6)	109.2(2)	C(1)-C(6)	110.8(5)
C(7)-C(7)	127.7(3)	C(7)-C(7)-S(1)	123.04(12)
C(11)-C(7)	122.43(12)	C(8)-C(7)	119.14(12)
S(2)-C(8)	115(4)	S(2)-C(8)-S(1)	117.8(2)
H(91)-C(9)	108(4)	S(2)-C(9)	109(3)
C(13)-C(9)	121.5(4)	H(92)-C(9)	115(5)
C(12)-C(10)	117.6(3)	C(13)-C(10)	120.9(4)
C(11)-C(11)	121(2)	C(11)-C(11)-C(10)	121.0(2)
C(12)-C(12)	121.3(2)	C(10)-C(11)-H(11)	118(2)
C(10)-C(12)	121(2)	C(12)-C(12)-H(12)	118(2)
C(10)-C(13)	121.8(4)	C(14)-C(13)	123.4(4)
N(1)-C(14)	177.9(4)	N(2)-C(15)	177.4(4)

Symmetry transformations used to generate equivalent atoms
(primed): x, -y+3/2, z

Crystal data and structure refinement

Identification code	97srvi55
Empirical formula	C ₂₈ H ₁₆ N ₄ S ₄
Formula weight	536.69
Temperature	150(2) K
Wavelength	0.71073 Å
Crystal system	Orthorhombic
Space group	Pnma
Unit cell dimensions	a = 19.451(1) Å b = 18.738(1) Å c = 6.883(1) Å alpha = 90 deg. beta = 90 deg. gamma = 90 deg.
Volume	2508.7(4) Å ³
Z	4
Density (calculated)	1.421 g/cm ³
Absorption coefficient	0.405 mm ⁻¹
F(000)	1104
Crystal size	0.44 × 0.16 × 0.06 mm
Theta range for data collection	2.17 to 25.00 deg.
Index ranges	-22<h<=17, -23<k<=24, -8<l<=6
Reflections collected	8339
Independent reflections	2185 [R(int) = 0.0547]
Observed reflections, I>2sigma(I)	1693
Absorption correction	Semi-empirical
Max. and min. transmission	0.978 and 0.759
Refinement method	Full-matrix least-squares on F ²
Data / restraints / parameters	2153 / 1 / 198
Goodness-of-fit on F ²	1.128
Final R indices [I>2sigma(I)]	R1 = 0.0580, wR2 = 0.1275
R indices (all data)	R1 = 0.0827, wR2 = 0.1444
Largest diff. peak and hole	0.614 and -0.417 e.Å ⁻³

A3.5 7,12-Dithia-benzo[k]fluoranthene (207) / 2,5-Dibromo-tetracyano-p-quinodimethane

Bond lengths [Å]	and angles [deg]
Br(2)-C(02)	1.892(2)
C(01)-C(07)	1.385(3)
C(03)-C(06)	1.455(3)
C(03)-C(04)	1.450(3)
C(04)-C(08)	1.387(4)
C(05)-C(06)	1.350(4)
C(07)-C(71)	1.444(4)
C(08)-C(81)	1.439(4)
C(71)-N(71)	1.146(4)
C(81)-N(81)	1.150(4)
S(1)-C(11)	1.747(3)
S(2)-C(12)	1.749(3)
S(3)-C(13)	1.763(3)
S(4)-C(14)	1.762(3)
C(1)-C(2)	1.381(4)
C(1)-C(11)	1.473(4)
C(2)-H(2)	0.94(3)
C(3)-H(3)	0.97(4)
C(4)-H(4)	0.95(4)
C(5)-C(10)	1.430(4)
C(6)-C(7)	1.422(4)
C(7)-C(8)	1.373(4)
C(8)-C(9)	1.422(4)
C(9)-C(10)	1.395(4)
C(13)-C(14)	1.338(4)
C(15)-H(152)	0.93(6)
C(16)-H(161)	1.00(4)
C(16)-H(163)	0.99(4)
C(07)-C(01)-C(02)	126.7(2)
C(01)-C(02)-Br(2)	115.2(2)
C(03)-C(02)-Br(2)	116.1(2)
C(02)-C(03)-C(04)	123.0(2)
C(04)-C(03)-H(03)	115.2(2)
C(08)-C(04)-C(05)	126.6(2)
C(06)-C(05)-C(04)	120.9(2)
C(04)-C(05)-Br(5)	121.8(2)
C(05)-C(06)-H(06)	121(2)
C(01)-C(07)-C(71)	128.0(2)
C(71)-C(07)-C(72)	112.0(2)
C(04)-C(08)-C(81)	127.4(2)
N(71)-C(71)-C(07)	171.4(3)
N(81)-C(81)-C(08)	177.2(3)
C(11)-S(1)-C(13)	99.58(13)
C(13)-S(1)-C(15)	104.0(2)
C(2)-C(1)-C(9)	118.9(2)
C(1)-C(2)-H(2)	105.1(2)
C(1)-C(2)-H(2)	123(2)
C(2)-C(3)-H(3)	123.2(3)
C(3)-C(4)-H(4)	115(2)
C(3)-C(4)-H(4)	121(2)
C(6)-C(5)-C(10)	120.5(3)
C(10)-C(5)-H(5)	118(2)
C(15)-C(6)-H(6)	118(2)
C(16)-C(6)-H(6)	118.3(3)
C(7)-C(8)-C(9)	120(2)
C(7)-C(8)-C(12)	136.2(3)
C(10)-C(9)-C(8)	124.4(3)
C(11)-C(9)-C(8)	111.4(2)
C(9)-C(10)-C(5)	115.8(3)

Br(5)-C(05)	1.888(2)
C(01)-C(02)	1.453(4)
C(02)-C(03)	1.353(4)
C(03)-H(03)	0.96(3)
C(04)-C(05)	1.455(3)
C(06)-H(06)	0.91(3)
C(07)-C(72)	1.447(4)
C(08)-C(82)	1.444(4)
C(72)-N(72)	1.148(4)
C(82)-N(82)	1.143(3)
S(1)-C(13)	1.788(3)
S(2)-C(14)	1.788(3)
S(3)-C(15)	1.789(4)
S(4)-C(16)	1.813(4)
C(1)-C(9)	1.417(4)
C(2)-C(3)	1.429(4)
C(3)-C(4)	1.373(4)
C(4)-C(10)	1.433(4)
C(5)-C(6)	1.382(5)
C(5)-H(5)	0.97(3)
C(6)-H(6)	0.96(4)
C(7)-H(7)	0.98(3)
C(8)-C(12)	1.475(4)
C(11)-C(12)	1.369(4)
C(15)-H(151)	0.88(6)
C(15)-H(153)	0.86(5)
C(16)-H(162)	0.95(4)
C(07)-C(01)-C(06)	118.1(2)
C(03)-C(02)-C(01)	121.5(2)
C(01)-C(02)-Br(2)	122.3(2)
C(02)-C(03)-H(03)	122(2)
C(08)-C(04)-C(05)	117.6(2)
C(03)-C(04)-C(05)	115.8(2)
C(06)-C(05)-Br(5)	117.2(2)
C(05)-C(06)-C(01)	123.5(2)
C(01)-C(06)-H(06)	115(2)
C(01)-C(07)-C(72)	119.9(2)
C(04)-C(08)-C(81)	121.0(2)
C(81)-C(08)-C(82)	111.5(2)
N(72)-C(72)-C(07)	178.1(3)
N(82)-C(82)-C(08)	170.1(3)
C(11)-S(2)-C(14)	99.74(12)
C(14)-S(2)-C(16)	101.1(2)
C(2)-C(1)-C(11)	136.0(2)
C(1)-C(2)-C(3)	117.7(3)
C(1)-C(2)-H(2)	119(2)
C(2)-C(3)-H(3)	122(2)
C(3)-C(4)-C(10)	120.0(3)
C(10)-C(4)-H(4)	119(2)
C(6)-C(5)-H(5)	122(2)
C(15)-C(6)-C(7)	122.5(3)
C(7)-C(6)-H(6)	120(2)
C(8)-C(7)-H(7)	122(2)
C(7)-C(8)-C(9)	118.9(3)
C(9)-C(8)-C(12)	104.8(2)
C(10)-C(9)-C(8)	124.2(3)
C(11)-C(9)-C(8)	115.6(3)
C(9)-C(10)-C(5)	128.6(3)

Crystal data and structure refinement

Identification code	97SRV156
Empirical formula	C ₂₈ H ₁₄ Br ₂ N ₄ S ₄
Formula weight	694.49
Temperature	150(2) K
Wavelength	0.71073 Å
Crystal system	Triclinic
Space group	P-1
Unit cell dimensions	a = 7.848(1) Å alpha = 77.29(1) deg b = 10.285(1) Å beta = 83.47(1) deg c = 17.309(1) Å gamma = 89.59(1) deg
Volume	1355.1(2) Å ³
Z	2
Density (calculated)	1.702 g/cm ³
Absorption coefficient	3.326 mm ⁻¹
F(000)	688
Crystal size	0.36 x 0.13 x 0.08 mm
Theta range for data collection	2.03 to 30.53 deg.
Index ranges	-11<h<=10, -14<k<=14, -23<l<=22
Reflections collected	13741
Independent reflections	7147 [R(int) = 0.0287]
Observed reflections, I>2sigma(I)	5664
Absorption correction	Semiempirical (SADABS)
Max. and min. transmission	0.9065 and 0.5911
Refinement method	Full-matrix least-squares on F ²
Data / restraints / parameters	7121 / 0 / 400
Goodness-of-fit on F ²	1.108
Final R indices [I>2sigma(I)]	R1 = 0.0344, wR2 = 0.0671
R indices (all data)	R1 = 0.0540, wR2 = 0.0809
Extinction coefficient	0.0104(5)
Largest diff. peak and hole	0.490 and -0.522 e.Å ⁻³

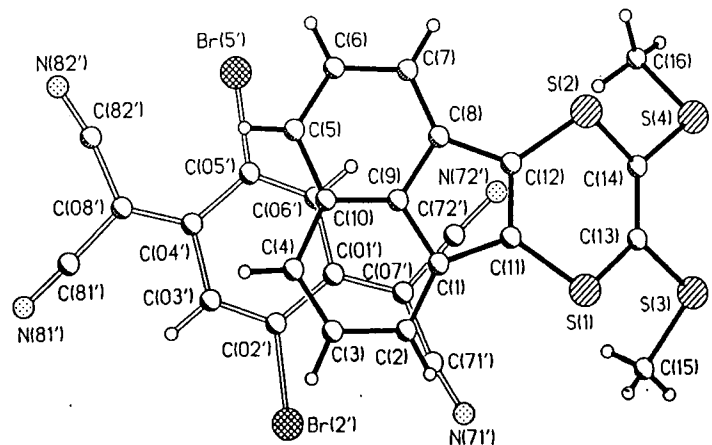

A3.6 7,12-Dithia-benzo[k]fluoranthene / (I₂)₂ I₃

Crystal data and structure refinement

Identification code	98srv001
Empirical formula	C ₁₆ H ₁₂ I ₇ S ₄
Formula weight	1220.80
Temperature	150(2) K
Wavelength	0.71073 Å
Crystal system	Triclinic
Space group	P-1
Unit cell dimensions	a = 10.420(1) Å alpha = 54.76(1) deg b = 11.263(1) Å beta = 78.50(1) deg c = 13.087(1) Å gamma = 79.74(1) deg
Volume	1354.9(2) Å ³
Z	2
Density (calculated)	2.992 g/cm ³
Absorption coefficient	8.330 mm ⁻¹
F(000)	1086
Crystal size	0.30 × 0.17 × 0.15 mm
Theta range for data collection	1.74 to 30.25 deg.
Index ranges	-14<h<=13, -15<k<=15, -17<l<=18
Reflections collected	17175
Independent reflections	7267 [R(int) = 0.0346]
Observed reflections, I>2sigma(I)	5770
Absorption correction	Semi-empirical
Max. and min. transmission	0.4191 and 0.2586
Refinement method	Full-matrix least-squares on F ²
Data / restraints / parameters	7262 / 0 / 252
Goodness-of-fit on F ²	1.104
Final R indices [I>2sigma(I)]	R1 = 0.0395, wR2 = 0.0881
R indices (all data)	R1 = 0.0569, wR2 = 0.0992
Largest diff. peak and hole	1.152 and -1.886 e.Å ⁻³

Bond lengths (Å) and angles (deg)

I(1)-I(2)	2.780(1)	I(1)-I(2)	2.789(7)
I(2)-I(3)	3.162(1)	I(3)-I(4)	2.965(1)
I(4)-I(5)	2.891(1)	I(5)-I(6)	3.313(1)
I(6)-I(7)	2.745(1)	I(7)-I(1) #1	3.630(1)
I(7)-I(1) #1	3.482(7)	S(1)-C(11)	1.718(6)
S(1)-C(11)	1.742(6)	S(2)-C(12)	1.719(6)
S(2)-C(12)	1.729(6)	S(3)-C(13)	1.750(6)
S(3)-C(13)	1.802(7)	S(4)-C(14)	1.763(6)
S(4)-C(14)	1.804(6)	C(1)-C(2)	1.383(8)
C(1)-C(2)	1.421(8)	C(1)-C(11)	1.468(8)
C(2)-C(3)	1.426(9)	C(3)-C(4)	1.385(10)
C(3)-C(4)	1.441(9)	C(5)-C(6)	1.385(10)
C(4)-C(5)	1.419(9)	C(6)-C(7)	1.418(8)
C(5)-C(6)	1.390(8)	C(8)-C(9)	1.414(8)
C(6)-C(7)	1.461(8)	C(9)-C(10)	1.391(8)
C(7)-C(8)	1.388(8)	C(13)-C(14)	1.371(8)
C(8)-C(9)	1.388(8)	I(1)-I(2)	168.7(1)
C(9)-C(10)	177.84(2)	I(3)-I(4)	177.32(2)
C(10)-C(11)	89.37(2)	I(5)-I(6)	177.99(2)
C(11)-C(12)	102.86(2)	I(7)-I(6)	165.5(1)
C(12)-C(13)	157.80(2)	I(7)-I(1) #1	97.5(2)
C(13)-C(14)	94.33(2)	I(7)-I(1) #1-I(2) #1	104.3(3)
C(14)-C(1)	103.9(3)	C(12)-S(2)-C(14)	103.5(3)
C(1)-C(2)	104.2(3)	C(12)-S(2)-C(11)	135.7(6)
C(2)-C(3)	119.3(5)	C(2)-C(1)-C(11)	117.9(6)
C(3)-C(4)	122.8(6)	C(1)-C(2)-C(3)	120.2(6)
C(4)-C(5)	120.6(6)	C(3)-C(4)-C(10)	122.9(6)
C(5)-C(6)	117.0(6)	C(5)-C(6)-C(7)	119.6(5)
C(6)-C(7)	135.5(5)	C(7)-C(8)-C(9)	104.9(5)
C(7)-C(8)	124.0(6)	C(9)-C(8)-C(12)	124.2(6)
C(8)-C(9)	111.9(5)	C(10)-C(9)-C(11)	115.9(6)
C(9)-C(10)	115.8(6)	C(9)-C(10)-C(5)	128.3(6)
C(10)-C(11)	108.7(5)	C(5)-C(10)-C(4)	128.6(4)
C(11)-C(12)	122.6(4)	C(12)-C(11)-S(1)	109.6(5)
C(12)-C(13)	127.2(4)	C(11)-C(12)-C(8)	123.2(4)
C(13)-C(14)	116.0(3)	C(8)-C(12)-S(2)	116.7(4)
C(14)-C(1)	116.0(3)	C(14)-C(13)-S(3)	128.3(4)
S(1)-C(11)-S(3)	116.2(4)	C(13)-C(14)-S(2)	115.4(3)
S(2)-C(12)-S(4)		S(2)-C(14)-S(4)	

Symmetry transformations used to generate equivalent atoms:
#1 x, y+1, z-1

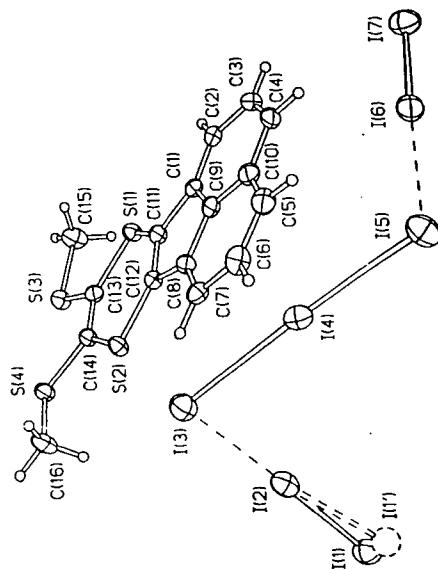

A3.7 9-[4,5-Di(sulfanylmethyl)-1,3-dithiol-2-ylidene]acenaphthylene[1,2-*b*][1,3]dithiolo[4,5-*e*][1,4]dithine (214)

Crystal data and structure refinement

Identification code	978rv140
Empirical formula	C ₂₀ H ₁₂ S ₈
Formula weight	508.78
Temperature	150(2) K
Wavelength	0.71073 Å
Crystal system	Monoclinic
Space group	P2(1)/c
Unit cell dimensions	a = 17.166(1) Å b = 7.714(1) Å c = 16.897(1) Å
Volume	2016.0(3) Å ³
Z	4
Density (calculated)	1.676 g/cm ³
Absorption coefficient	0.892 mm ⁻¹
F(000)	1040
Crystal size	0.38 x 0.28 x 0.02 mm
Theta range for data collection	2.4 to 30.5 deg.
Index ranges	-24<=h<=24, -9<=k<=10, -22<=l<=22
Reflections collected	15561
Independent reflections	5502 [R(int) = 0.0406]
Observed reflections, I>2sigma(I)	4329
Absorption correction	Integration
Max. and min. transmission	0.9860 and 0.7606
Refinement method	Full-matrix least-squares on F ²
Data / restraints / parameters	5452 / 0 / 301
Goodness-of-fit on F ²	1.175
Final R indices [I>2sigma(I)]	R1 = 0.0407, wR2 = 0.0748
R indices (all data)	R1 = 0.0635, wR2 = 0.0958
Largest diff. peak and hole	0.469 and -0.437 e.Å ⁻³

Bond lengths [Å] and angles [deg]

S(1)-C(11)	1.753(2)	S(1)-C(13)	1.762(2)
S(2)-C(12)	1.762(3)	S(2)-C(14)	1.768(2)
S(3)-C(13)	1.755(2)	S(3)-C(15)	1.762(3)
S(4)-C(14)	1.763(2)	S(4)-C(16)	1.767(3)
S(5)-C(15)	1.763(2)	S(5)-C(17)	1.762(3)
S(6)-C(16)	1.759(3)	S(6)-C(18)	1.766(3)
S(7)-C(17)	1.751(3)	S(7)-C(19)	1.808(4)
S(8)-C(18)	1.753(3)	S(8)-C(20)	1.805(3)
C(1)-C(11)	1.374(4)	C(1)-C(9)	1.413(3)
C(1)-C(12)	1.477(3)	C(2)-C(3)	1.434(4)
C(1)-C(13)	0.93(3)	C(3)-C(4)	1.376(4)
C(1)-C(14)	0.96(4)	C(4)-C(10)	1.425(4)
C(1)-C(15)	0.96(4)	C(5)-C(6)	1.377(4)
C(1)-C(16)	0.96(4)	C(5)-H(5)	0.93(3)
C(1)-C(17)	1.431(4)	C(6)-H(8)	0.90(3)
C(1)-C(18)	1.428(4)	C(7)-H(7)	0.89(3)
C(1)-C(19)	1.373(4)	C(8)-C(12)	1.482(3)
C(1)-C(20)	1.416(4)	C(11)-C(12)	1.363(3)
C(9)-C(10)	1.393(3)	C(11)-C(16)	1.349(3)
C(13)-C(14)	1.337(3)	C(15)-C(16)	0.95(4)
C(17)-C(18)	1.351(4)	C(19)-H(19)	0.95(4)
C(19)-H(19)	0.94(4)	C(19)-H(19)	0.95(4)
C(20)-H(20)	0.94(4)	C(20)-H(20)	1.00(4)
C(20)-H(20)	0.95(4)	C(12)-S(2)-C(14)	98.5(1)
C(11)-S(1)-C(13)	97.9(1)	C(14)-S(4)-C(16)	94.5(1)
C(13)-S(3)-C(15)	94.2(1)	C(18)-S(8)-C(20)	94.7(1)
C(16)-S(5)-C(17)	101.5(2)	C(18)-S(8)-C(12)	103.4(1)
C(17)-S(7)-C(19)	101.5(2)	C(21)-C(1)-C(11)	135.3(2)
C(2)-C(1)-C(9)	109.6(2)	C(11)-C(1)-C(13)	117.4(3)
C(9)-C(1)-C(11)	105.1(2)	C(11)-C(1)-C(15)	121(2)
C(1)-C(2)-H(2)	121(2)	C(1)-C(2)-H(3)	117(3)
C(2)-C(3)-H(3)	122.9(3)	C(3)-C(4)-H(4)	130.9(2)
C(3)-C(4)-H(4)	120(2)	C(10)-C(4)-H(4)	117(3)
C(4)-C(5)-H(5)	120(2)	C(5)-C(6)-H(6)	122.5(3)
C(5)-C(6)-H(6)	123(2)	C(7)-C(6)-H(6)	119.5(3)
C(6)-C(7)-H(7)	118.6(3)	C(8)-C(7)-H(7)	123(2)
C(7)-C(8)-H(8)	119(2)	C(9)-C(8)-C(12)	118.1(2)
C(8)-C(9)-C(10)	136.5(2)	C(10)-C(9)-C(12)	105.3(2)
C(9)-C(10)-C(11)	123.8(2)	C(10)-C(9)-C(18)	125.0(2)
C(10)-C(9)-C(18)	111.2(2)	C(11)-C(10)-C(4)	116.4(2)
C(11)-C(10)-C(4)	115.7(2)	C(12)-C(11)-S(1)	125.1(2)
C(12)-C(11)-S(1)	109.7(2)	C(11)-C(12)-C(8)	108.7(2)
C(11)-C(12)-C(8)	125.3(2)	C(14)-C(13)-S(2)	126.9(2)
C(14)-C(13)-S(2)	124.4(2)	C(14)-C(13)-S(1)	125.6(2)
S(3)-C(13)-S(1)	118.1(2)	C(13)-C(14)-S(2)	117.4(2)
S(3)-C(13)-S(1)	116.3(1)	C(13)-C(14)-S(4)	117.9(1)
C(13)-C(14)-S(2)	124.6(2)	C(16)-C(15)-S(2)	122.6(2)
C(16)-C(15)-S(3)	121.2(2)	C(15)-C(16)-S(5)	114.2(1)
S(3)-C(15)-S(4)	115.1(1)	C(18)-C(17)-S(5)	117.6(2)
C(18)-C(17)-S(7)	124.0(2)	C(17)-C(18)-S(8)	121.5(2)
S(7)-C(17)-S(5)	118.3(2)	C(18)-C(18)-S(6)	109(2)
S(7)-C(17)-S(5)	116.8(2)	S(8)-C(18)-S(6)	113(2)
S(7)-C(18)-S(6)	107(2)	S(7)-C(19)-H(19)	109(2)
S(7)-C(19)-H(19)	12(3)	H(19)-C(19)-H(19)	109(2)
H(19)-C(19)-H(19)	108(3)	S(8)-C(20)-H(20)	111(2)
S(8)-C(20)-H(20)	107(2)	S(8)-C(20)-H(20)	111(2)
H(20)-C(20)-H(20)	108(3)	H(20)-C(20)-H(20)	108(3)
H(20)-C(20)-H(20)	110(3)		

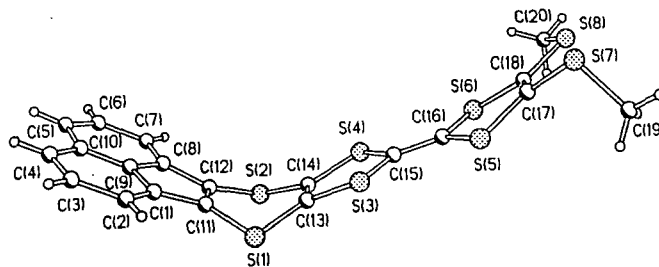

A3.8 1,2,4-Trithiolane Compound (237)

Crystal data and Structure refinement

Formula	$C_{10}H_{12}S_9$	Crystal size, mm	0.06x0.10 x0.56
<i>M</i>	420.7	$2\theta_{max}$	55
<i>T, K</i>	295	$2\theta_{min}$	55
Symmetry	triclinic	Data total	3680
<i>a, Å</i>	8.245(1)	Data unique	3502
<i>b, Å</i>	8.344(1)	Data observed, $>2\sigma(I)$	2438
<i>c, Å</i>	13.250(1)	R_{int}	0.019
$\alpha, ^\circ$	108.10(1)	Absorption correction	none
$\beta, ^\circ$	102.38(1)	Transmission min, max	0.894, 0.936
$\gamma, ^\circ$	98.55(1)	No. of variables	244
<i>U, Å³</i>	823.2(1)	wR(F ²), all data	0.085
Space group	P $\bar{1}$	Goodness-of-fit	0.98
<i>Z</i>	2	R(F), obs. data	0.032
μ, cm^{-1}	11.9	max, min $\Delta\rho, e\text{Å}^{-3}$	0.39/-0.40
<i>D_s, g cm⁻³</i>	1.70		

Bond lengths [Å] and angles [deg]

S(1)-C(5)	1.722(2)	S(1)-S(2)	2.191(1)
S(2)-C(3)	1.722(2)	S(4)-S(2)	1.746(2)
S(4)-C(3)	1.752(3)	S(31)-C(31)	1.777(3)
S(31)-C(34)	1.803(4)	S(32)-C(32)	1.658(3)
S(33)-C(32)	1.742(3)	S(51)-C(51)	1.793(3)
S(51)-C(52)	1.781(2)	S(52)-C(52)	1.804(3)
S(53)-C(53)	1.660(3)	C(31)-C(32)	1.750(2)
C(51)-C(51)	1.793(3)	C(31)-C(31)	1.381(3)
C(51)-C(52)	1.386(4)	C(31)-C(32)	1.435(4)
C(5)-S(1)-S(2)	99.2(1)	C(3)-S(2)-S(1)	99.1(1)
C(32)-S(33)-C(33)	103.1(1)	C(31)-S(31)-C(34)	109.6(2)
C(31)-C(3)-S(4)	102.4(2)	C(51)-S(51)-C(54)	101.2(1)
C(51)-C(5)-S(1)	103.1(2)	C(31)-S(31)-S(2)	125.5(2)
S(1)-C(5)-S(4)	115.3(2)	S(2)-C(3)-S(4)	119.2(1)
C(31)-C(3)-S(4)	125.0(2)	C(31)-C(5)-S(4)	115.6(2)
S(1)-C(5)-S(4)	119.4(2)	C(31)-C(31)-S(33)	122.8(2)
C(31)-C(31)-S(33)	117.9(2)	C(31)-C(32)-S(33)	119.3(2)
C(31)-C(32)-S(33)	123.6(2)	C(51)-C(51)-C(52)	123.1(2)
S(32)-C(32)-S(33)	123.5(2)	C(52)-C(51)-S(51)	119.5(2)
C(51)-C(51)-S(51)	117.4(2)	C(51)-C(52)-S(53)	114.6(2)
S(52)-C(52)-S(53)	122.1(2)		
S(52)-C(52)-S(53)	123.3(2)		

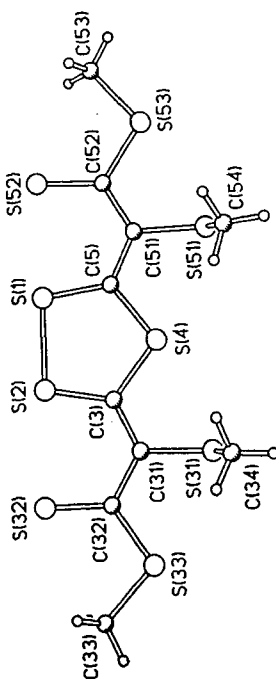

^aBefore and after absorption correction
^b36 ψ -scans of 1 reflection, TEXSAN software
^cSHELXTL software, *d* on Laue equivalents

Appendix Four

*Research Colloquia, Seminars, Lectures
and Conferences*

A.4.1 COLLOQUIA, LECTURES AND SEMINARS ATTENDED

There follows a list of research colloquia, seminars and lectures that have been addressed by external speakers and arranged by the Department of Chemistry during the period of the author's residence as a postgraduate student and have been attended by the author.

1994

- November 3 Prof. B. F. G. Johnson, Edinburgh University
Arene-metal Clusters
- November 9 Dr G. Hogarth, University College, London
New Vistas in Metal-imido Chemistry
- November 16 Prof. M. Page, University of Huddersfield
Four-membered Rings and β -Lactamase
- November 23 Dr J. M. J. Williams, University of Loughborough
New Approaches to Asymmetric Catalysis

1995

- January 11 Prof. P. Parsons, University of Reading
Applications of Tandem Reactions in Organic Synthesis
- February 8 Dr D. O'Hare, Oxford University
Synthesis and Solid-state Properties of Poly-, Oligo- and Multidecker
Metallocenes
- February 22 Prof. E. Schaumann, University of Clausthal
Silicon- and Sulphur-mediated Ring-opening Reactions of Epoxide
- March 1 Dr M. Rosseinsky, Oxford University
Fullerene Intercalation Chemistry
- April 26 Dr M. Schroder, University of Edinburgh

Redox-active Macrocyclic Complexes : Rings, Stacks and Liquid Crystals

- May 4 Prof. A. J. Kresge, University of Toronto
The Ingold Lecture Reactive Intermediates : Carboxylic-acid Enols and Other Unstable Species
- October 18 Prof. A. Alexakis, Univ. Pierre et Marie Curie, Paris,
Synthetic and Analytical Uses of Chiral Diamines
- November 1 Prof. W. Motherwell, UCL London
New Reactions for Organic Synthesis
- November 8 Dr. D. Craig, Imperial College, London
New Strategies for the Assembly of Heterocyclic Systems
- November 17 Prof. David Bergbreiter, Texas A&M, USA
Design of Smart Catalysts, Substrates and Surfaces from Simple Polymers

1996

- January 24 Dr Alan Armstrong, Nottingham University
Alkene Oxidation and Natural Product Synthesis
- February 14 Dr J. Rohr, Univ Gottingen, FRG
Goals and Aspects of Biosynthetic Studies on Low Molecular Weight Natural Products
- February 21 Dr C R Pulham , Univ. Edinburgh
Heavy Metal Hydrides - an exploration of the chemistry of stannanes and plumbanes
- March 6 Dr Richard Whitby, Univ of Southampton
New approaches to chiral catalysts: Induction of planar and metal centred asymmetry
- March 7 Dr D.S. Wright, University of Cambridge
Synthetic Applications of Me₂N-p-Block Metal Reagents

- March 12 RSC Endowed Lecture - Prof. V. Balzani, Univ of Bologna
Supramolecular Photochemistry
- October 14 Professor A. R. Katritzky, University of Gainesville, University of
Florida, USA
Recent Advances in Benzotriazole Mediated Synthetic Methodology
- October 16 Professor Ojima, Guggenheim Fellow, State University of New York
at Stony Brook
Silylformylation and Silylcarbocyclisations in Organic Synthesis
- October 23 Professor H. Ringsdorf (Perkin Centenary Lecture), Johannes
Gutenberg-Universität, Mainz, Germany
Function Based on Organisation
- November 12 Professor R. J. Young, Manchester Materials Centre, UMIST
New Materials - Fact or Fantasy?
Joint Lecture with Zeneca & RSC
- November 13 Dr G. Resnati, Milan
Perfluorinated Oxaziridines: Mild Yet Powerful Oxidising Agents
- November 18 Professor G. A. Olah, University of Southern California, USA
Crossing Conventional Lines in my Chemistry of the Elements
- November 19 Professor R. E. Grigg, University of Leeds
Assembly of Complex Molecules by Palladium-Catalysed Queuing
Processes
- November 27 Dr Richard Templar, Imperial College, London
Molecular Tubes and Sponges
- December 3 Professor D. Phillips, Imperial College, London
"A Little Light Relief" -
- December 11 Dr Chris Richards, Cardiff University
Stereochemical Games with Metallocenes

1997

- January 15 Dr V. K. Aggarwal, University of Sheffield
Sulfur Mediated Asymmetric Synthesis
- January 16 Dr Sally Brooker, University of Otago, NZ
Macrocycles: Exciting yet Controlled Thiolate Coordination
Chemistry
- January 22 Dr Neil Cooley, BP Chemicals, Sunbury
Synthesis and Properties of Alternating Polyketones
- February 4 Dr A. J. Banister, University of Durham
From Runways to Non-metallic Metals - A New Chemistry Based on
Sulphur
- February 26 Dr Tony Ryan, UMIST
Making Hairpins from Rings and Chains
- March 4 Professor C. W. Rees, Imperial College
Some Very Heterocyclic Chemistry

A.4.2 LIST OF CONFERENCES ATTENDED

There follows a list of conferences attended by the author during the period of the author's residence as a postgraduate student.

- May 1997 21st Century Heterocyclic Chemistry Symposium, University
of Sunderland
- July 1997 Engineering and Physical Sciences Research Council, Graduate
School (C.R.A.C), University of Stirling.
- July 1997 RSC 3rd International Conference on Materials Chemistry,
University of Exeter

Appendix Five

Publications and Presentations

A.5.1 PUBLICATION

Part of the work contained in this thesis has been reported in the following publication.

M. R. Bryce, A. Chesney, **A. K. Lay**, A. S. Batsanov, J. A. K. Howard, *J. Chem. Soc., Perkin Trans. 1*, 1996, 2451.

A.5.2 PRESENTATION

Poster: " Novel 1,4-Dithiin Electron Donor Systems", presented at the I.C.I Poster Competition December 1996, University of Durham.

