

Durham E-Theses

Syllabification and phonological rule application in Tashlhiyt Berber

Karima Soutsane

How to cite:

Soutsane, Karima (2008) Syllabification and phonological rule application in Tashlhiyt Berber.
Doctoral thesis, Durham University.

Use policy

The full-text may be used and/or reproduced, and given to third parties in any format or medium, without prior permission or charge, for personal research or study, educational, or not-for-profit purposes provided that:

- a full bibliographic reference is made to the original source
- a <https://etheses.durham.ac.uk/id/eprint/2543/> is made to the metadata record in Durham E-Theses
- the full-text is not changed in any way

The full-text must not be sold in any format or medium without the formal permission of the copyright holders.

Please consult the [full Durham E-Theses policy](#) for further details.



University of Durham

Department of Linguistics

The copyright of this thesis rests with the author or the university to which it was submitted. No quotation from it, or information derived from it may be published without the prior written consent of the author or university, and any information derived from it should be acknowledged.

Syllabification and phonological rule application in Tashlhiyt Berber

By Karima Soutsane
Supervisor: Dr. S J Hannahs

A thesis submitted in fulfilment of the requirements for
the degree of Doctor of Philosophy

2008



25 MAR 2009

ABSTRACT

Tashlhiyt variety of Berber, spoken in the southern part of Morocco has drawn particular attention from phonologists for its admittance of complex consonant sequences and of vowelless phonological words. The way words should be analysed into syllable constituents in these cases is by no means trivial and depends on which segments are identified as nuclear. Dell & Elmedlaoui raised the question at the heart of the problem: 'are there languages in which any segment can occur as a syllable nucleus?' One such a language is the variety of Tashlhiyt Berber where even a voiceless stop may act as a syllable nucleus. The fact that any segment can form the nucleus of a syllable causes potential ambiguity in syllabification. The purpose of this thesis is to investigate the process of syllabification through various phonological and morphological processes which are affected by the results drawn from the syllabification algorithm in the language.

ACKNOWLEDGEMENTS

I would like to express my gratitude to Dr SJ Hannahs whose help and patience have been greatly appreciated and will not be forgotten.

I also wish to thank David Page for his support and encouragement over the final stages of writing this thesis.

Last but not least, I would like to express my gratitude to my parents and my family who gave me this opportunity and without whom this work would not have been accomplished. I would also like to thank all my friends for always being there.

I dedicate this thesis to my grandfather who has been an inspiration.

Syllabification and phonological rule application in Tashlhiyt Berber

Abstract	i
Acknowledgments.....	ii
Content.....	iii
Introduction.....	1
Chapter 1 Background.....	4
1.1 Introduction.....	5
1.2 About the Berber language.....	5
1.2.1 The origin of Berber.....	7
1.3 Tashlhiyt Berber.....	7
1.3.1 Inventory of segments.....	7
1.3.1.1 The vowels of Tashlhiyt.....	8
1.3.1.2 The consonants of Tashlhiyt.....	9
1.4 The syllable and syllabicity.....	10
1.4.1 Vocality and syllabicity.....	11
1.4.2 Sonority and syllabicity.....	15
1.4.3 The basis for Tashlhiyt syllabification.....	19
1.4.4 Syllable weight.....	20
1.4.5 Phonetic Vs Phonological vowels and consonants.....	22
1.4.6 Other Berber languages	23
1.4.6.1 Tarifit Berber.....	23
1.4.6.2 Tamazight Berber.....	29
1.4.6.3 Taqbaylit Berber.....	41
1.5 Conclusion.....	48
Chapter 2 Tashlhiyt Syllable and Syllabification.....	50
2.1 Introduction.....	51

2.2	Syllable configuration in Tashlhiyt.....	51
	2.2.1 Syllable patterns in Tashlhiyt.....	55
	2.2.2 Tashlhiyt Syllabicity.....	57
2.3	Syllabification procedure.....	59
	2.3.1 Dell & Elmedlaoui's Core Syllabification.....	60
	2.3.2 Coleman's Syllabification Algorithm.....	69
	2.3.3 Optimality Theory Account of Tashlhiyt.....	76
	2.3.3.1 OT Structure, Principles and Constraints.....	71
	2.3.3.2 Prince & Smolensky's Analysis.....	77
2.4	Conclusion.....	85
Chapter 3	Passive Verb.....	87
3.1	Introduction.....	88
3.2	The structure of passive verb	88
3.3	Syllabification of the passive verb.....	91
3.4	Conclusion.....	121
Chapter 4	Glide formation.....	123
4.1	Introduction.....	124
4.2	Phonological status of glides.....	124
4.3	Vowel/glide alternation.....	131
	4.3.1 Moroccan Arabic.....	131
	4.3.2 French.....	136
	4.3.3 Malay.....	142
	4.3.4 Other Berber languages.....	144
	4.3.4.1 Tamazight.....	145
	4.3.4.2 Taqbaylit.....	152
	4.3.4.3 Tarifit.....	155
	4.3.5 Tashlhiyt.....	159
4.4	Conclusion.....	169

Chapter 5	Gemination and syllable structure	171
5.1	Introduction	172
5.2	Tashlhiyt geminates	172
5.3	The representation of geminates	173
5.4	Types of geminates	182
5.4.1	True geminates	182
5.4.2	Derived geminates	183
5.4.2.1	Geminates derived through morphological rules	183
5.4.2.1	Geminate derived through assimilation	185
5.5	Imperfective gemination	189
5.5.1	Internal gemination	198
5.5.2	<i>tt</i> -prefixation	190
5.5.3	Imperfective syllabification	193
5.5.4	Geminate syllabification	202
5.5.5	Degemination	207
5.6	Gemination in other Berber languages	209
5.7	Conclusion	211
Chapter 6	Summary and discussion	213
References		221

Introduction

The Tashlhiyt dialect of Berber has been subject to a series of studies. The language has consonant-only sequences, which cannot be broken up into syllables using the Vocalic Hypothesis, because of the absence of a vowel. The latter occupies the nucleus position in most languages. The most famous finding, in this respect, is that in this language any segment - consonant or vowel, obstruent or sonorant - can form the nucleus of a syllable. The purpose of this thesis is to look at the various phonological activities that go hand in hand with morphological operations in the various derivations analysed and to account for the implications of the findings in these analyses.

The thesis is organised as follows:

In chapter 1, we will first give an overview of the facts about the language that we see are relevant to this study. We will then show that the key element in the syllabification algorithm follows from its reference to sonority in the determination of syllable nuclei. The algorithm scans the string to be syllabified and builds a CV syllable when a sonority peak is encountered. We thus expect to encounter difficulties when the algorithm has to syllabify a string containing no single sonority peak. We will also look, in this chapter, into the syllable and syllabicity of Tashlhiyt and give some preliminary facts relevant to the analyses in the subsequent chapter. Finally, we will analyse data from other Berber languages.



In chapter 2 we will address the questions raised in section 1.4 concerning the syllabicity of segments. A basic procedure employed by several theories of linguistic structure for determining the syllabicity of a segment consists of marking its relative sonority prominence with respect to its neighbouring segments. The more sonorous a segment, the more likely it is to be syllabic. We will, therefore, consider how various linguistic descriptions converge on this issue of the role of sonority in determining syllable structure, and then specify its fundamental role in segment organisation in Tashlhiyt. The discussion will, then proceed to give an overview of previous analyses of Tashlhiyt by Dell & Elmedlaoui, Coleman and Prince & Smolensky.

In chapter 3, the next step, from the analysis in the previous chapter is to incorporate the insights of the approach used into the analysis of one of the morphological forms, namely in the characterisation of the structure of passive verbs. The aim of this chapter is two-fold: first to present a syllabification procedure which results in the attested alternations in the forms of the passive verbs. Second, to give an alternative analysis to the template for the passive verb.

Chapter 4 will investigate the phonological status of glides with respect to the corresponding vowels. We will address the question of whether glides can be considered as independent underlying segments or if they are always allophones of the corresponding vowels. We will look at the characterisation of vowel/glide alternation in Berber and explore the two approaches adopted in the literature, namely, the functional approach and the lexical approach. The former makes the claim that there is no underlying difference between a high vowel and a glide. The realization of an underlying high vowel as a vowel or a corresponding glide depends

on the syllable structure. The lexical approach, on the other hand, claims that some cases necessitate an underlying contrast between high vowels and glides.

In Chapter 5 we will look at the treatment of geminates in some languages before looking at the case of Tashlhiyt. With regards to geminates in Tashlhiyt, we will show that they are never broken up by epenthesis. We will also deal with gemination resulting from a morphological process and analyse in particular the case of the imperfective.

In chapter 6 we will give a summary of our analyses and discuss the findings and outcomes of the analyses addressed in the thesis.

Chapter 1

Background

Chapter 1

1.1 Introduction

In this chapter, we aim to pave the ground for the discussions of various phonological and morphological processes in Tashlhiyt which call for syllabification information. We will start by presenting some factual information about Berber languages in general before looking specifically at Tashlhiyt variety, which is the main focus of this thesis. We will, then, introduce basic facts and assumptions which will be discussed in greater detail in the chapters to follow. Finally, we give an overview of other varieties of Berber in order to highlight the uniqueness of Tashlhiyt in terms of dealing with consonant clusters.

1.2 About the Berber Language

Berber (also referred to as Tamazight) is spoken in an area stretching from Egypt, Libya and Algeria to Morocco and from the Mediterranean coast to south of the Sahara. The area includes numerous large Arabic-speaking regions, yet speakers of the various Berber languages make up approximately 50% of the population in Morocco as well as about 25% in Algeria.

Along with the Semitic, Egyptian, Cushitic, and Chadic languages, the Berber languages form one of the main branches of the Afro-Asiatic (formerly known as

Hamito-Semitic) language family, the principal language family found in northern Africa and the Middle East.

The areas where Berber is spoken are not contiguous. Rather, they constitute more or less large islands distant from one another, interrupted by large arabised zones. As a result, Berber has survived mostly in somehow naturally 'protected' areas. The zones where it is spoken today are either desertic or mountainous while most of the plain zones were arabised. The lack of contact between these areas has led to an important dialectalisation process. However, the nature of the dialectical variation is more phonological and lexical than syntactic (grammatical).

Berber divides into the following major groupings:

In Algeria: Taqbaylit, also referred to as Kabyle, (spoken in Kabylie, in Northern Algeria, along the Mediterranean coast), Tashawit (Aures mountains)

In Libya: Ghadamsi (Ghadames area), Nefusi (Jbel Nefusa)

In the Sahara: Tuareg (Southern Algeria, Mali and Niger)

In Morocco: there are three important Berber-speaking areas. The variety spoken in the Riffian mountainous area (including Ayt Werrayghel, Beni Zennasen, El Hoceima, etc.) is referred to as Tarifit. This variety also includes the form spoken in

Melilla and Ceuta. Another important Berber-speaking area is in central Morocco, stretching all along the mountainous Middle Atlas zone. Further south and west Tashlhiyt is spoken, occupying the Anti-Atlas mountain area and the plains from Sous, stretching from Agadir down to Ifni on the western coast, going as far east as the Draa.

1.3 Tashlhiyt Berber

1.3.1 Inventory of segments

This study will focus on the Tashlhiyt dialect, spoken in Agadir and surrounding regions. Tashlhiyt Berber, like Afro-Asiatic languages in general, has a very rich consonantal system and a poor vocalic one. It has 41 basic sounds, 3 vowels and 38 consonants. Except from the Tuareg varieties which have developed some extra long and short vowels, Berber has a basic triangular system (the three vowels are *i*, *u*, *a*)

1.3.1. 1 The vowels of Tashlhiyt

Although the vowel system of Berber is one of the simplest (Prasse, 1972; Basset, 1956; Cohen, 1988; Galland, 1953; Elmoujahid, 1979; Boukous, 1982; 1987a), it remains one of the least studied aspects of the language.

The phonemic vowels in Tashlhiyt are *i*, *u* and *a*. it is a basic triangular system:

(1)

i u
 a

	A	i	u
syll	+	+	+
high	-	+	+
low	+	-	-
front	-	+	-
back	-	-	+
round	-	-	+

The high vowels contrast on the basis of the features [back] and [round] with *i* being [-back , -round] and *u* [+back, +round]. The remaining vowel *a* is considered to be the unmarked vowel of the system. Tashlhiyt does not have mid nor long vowels. Besides these vowels, almost all varieties have introduced the allophone schwa ə.

The status of schwa has been disputed in the literature on Berber. Prasse (1975) included it in the repertoire of Tashlhiyt vowels, stating that it is an auxiliary vowel with no phonemic value. Its role is limited to easing the pronunciation of consonant clusters. Galland (1988) asserts that schwa is not a phoneme. Basset (1952) also asserts that full vowels have a morphological value, whereas reduced vowels have a

purely phonetic one. Finally, Boukous (1987a) states that schwa does not exist either at the underlying level or at the phonetic level. We will adopt the latter position.

1.3.1.2 The Consonants of Tashlhiyt

The consonantal system is richer than the vocalic one. This is represented in the following table where place of articulation is represented horizontally and manner of articulation is represented vertically:

(2)

	Labials	Coronals	Velars	Glottals
Stops	b	t, T, d, D	k, g, k ^w , g ^w	q, q ^w
Fricatives	f	s z ʒ ʃ	x, γ, x ^w , γ ^w	ħ, ʕ, h
Sonorants	m	n l r		
Glides	w	j		

The transcriptions used conform with the standard International Phonetic Alphabet except for emphatic (pharyngealized) consonants which are represented using ‘!’ before the consonant. Coronals, with the exception of /j/ have a corresponding

emphatic counterpart. Emphasis is a secondary articulation produced by retracting the tongue and constricting the pharynx during the articulation of the sound.

The articulatory similarities between the high vowels [i] and [u] and the glides [j] and [w] has long been observed. Further more, it has long been noted that the difference between high vowels and glides is a difference in affiliation within the syllable, that is, high vowels occur as syllabic peaks and glides occur in non-peak positions. In a language like Berber, glides must be present underlyingly, and these underlying glides can alternate with high vowels. We will look closely at this issue in chapter 4.

1.4 Syllable and syllabicity

In this section we examine the syllable in phonological theory, in particular some of the assumptions underlying syllabicity and syllable structure. As we shall see, the characteristics of Tashlhiyt, specifically the presence of syllabic obstruents, require a reassessment of the assumption that vowels- or at least some sort of sonorant segment- are a necessary occupant of the nucleus position in a syllable. After looking briefly at syllables and syllabicity in phonological theory in French and English, we will discuss Tashlhiyt, showing first of all why Tashlhiyt poses a problem for notions of syllabification and syllabicity which rely crucially on vowels, then examine analyses which deal with syllabicity and Berber syllabification in the absence of vowels.

The sonority of a segment is measured on a sonority scale in order to determine the syllabicity of such a segment. This consists of marking its relative sonority prominence with respect to its neighbouring segments. The more sonorous the segment is, the more likely it is to be syllabic. We will, therefore, consider how various linguistic descriptions converge on this issue of the role of sonority in the syllabification procedure.

1.4.1 Vocality and syllabicity

In the earliest forms of generative phonology, the syllable played no formal role. Indication of this is that in *The Sound Pattern of English* (SPE) (Chomsky and Halle, 1968) where the term 'syllable' doesn't even appear in the index. Instead, words were held to consist of sequences of consonants and vowels with no higher structure. The syllable was reintroduced to the phonological theory particularly following Fudge (1969), Khan (1976) and Selkirk (1982).

Syllables are important in phonological theory for at least three reasons: first, a great many phonotactic constraints which govern the possible sequences of sounds in a language tend to be defined at the level of syllable structure. Second, syllable structure also plays an important role in the organisation of the phonological processes of a language. Finally, it is sometimes the case that a phonological process can best be understood as operating at the level of the syllable or some constituent of the syllable. For instance, a rule might affect a consonant but only if it is in the onset

of a syllable. In other cases, it may be the rhyme constituent which is the locus of a phonological process. An understanding of syllable structure is, therefore, essential for an understanding of the phonological organisation of a language.

The absence of vowels is often taken to mean that there is no syllable. This also implies that consonants and semi-vowels will not occur in the nucleus position which is reserved for vowels. The vowel is then seen as the core element in a syllable.

This is the case in French for instance where vowels are seen to be obligatory elements in the syllable structure as shown in the examples under (4) (the dot represents the syllable boundary):

- (4) [lu] ‘rent’
 [kɔ.l.ɔ.ni] ‘colony’
 [sta.bi.li.ze] ‘stabilise’

The underlined vowels are syllable nuclei which indicate the number of syllables we have in each sequence, given that French allows only vowels as syllabic nuclei.

Despite the normal assumption that only vowels can be syllabic nuclei, some languages allow other segment types to head a syllable. In English, for example, the

only consonants that can head a syllable are the sonorants (nasals and liquids) as in the following examples where the capital letter shows the syllable nuclei:

(5)

/bɒtl/	Bottle
/sætɪn/	'Satin'
/kæpɪn/	'Captain'

While it may be the normal case that nucleus = vowel, the statement above that only vocalic segments occupy syllable nuclei is clearly too restrictive crosslinguistically.

Kenstowicz (1994:278) notes that in most languages, segments can be divided into three categories:

- sounds that always form the syllable nucleus,
- sounds that never occupy the nucleus,
- sounds that alternate between nuclear and non-nuclear positions depending on the context.

The table in (6) shows how this applies to French and English:

(6)

	English	French
Always in nucleus	Non-high vowel	Non-high vowels
Never in nucleus	Obstruents	Consonants
Alternating	High vowels/sonorants	High vowels

(Kenstowicz, 1994:278)

As we see from the table in (6), English non-high vowels are always nuclear segments, whilst obstruents never appear in the nucleus position in English. High vowels and sonorants, on the other hand alternate: high vowels (/i/ and /u/) surface as vowels if they are in nucleus position but they surface as glides ([j] and [w]) if they appear in a margin. Sonorant consonants, too, alternate in English, in that English permits syllabic sonorants in nucleus position, but sonorants in margins function as non-nuclear segments. All nuclei in the language are sonorants, whether vowels or consonants.

French, however, differs from English in that only vowels are allowed as syllabic nuclei. Non-high vowels only appear in nucleus position. High vowels, much as in English, surface as vowels in nuclear position, but are realised as glides in non-nuclear position. Consonants, as shown, never appear in the nucleus in French, regardless of whether or not they are sonorant.

Given that French and English behave differently with regard to which segment types are permitted in syllable nuclei, two questions arise: 1) how do the segments behave with regard to syllabicity in the language under investigation, Tashlhiyt, and 2) what are the implications of any behaviour we find that differs from French and English? As mentioned above, complex sequences of consonants in Tashlhiyt are a common occurrence not only at the underlying level but also at the phonetic level. In fact, there are utterances which even phonetically do not contain a single vowel and it is also common to have obstruent-only sequences. Can we apply the same division between nuclear and non-nuclear sequences of segments in this language? We will turn to this question immediately.

1.4.2 Sonority and syllabicity

Although some languages rely on schwa epenthesis to break up consonant clusters, it does not occur in the data in (7). The capitalised segments are syllable nuclei.

(7)

tRgLt	‘you locked’
tSkRt	‘you did’
tXzNt	‘you stored’
tRkSt	‘you hide’
tMsXt	‘you transformed’

(Dell & Elmedlaoui, 1985: 106)

This raises a number of questions:

- Can the vocalic hypothesis discussed above i.e. that nucleus = sonorants account for the data above?
- How are these vowel-less sequences syllabified?
- Where are the syllable boundaries located in the obstruent-only words, which are common in Tashlhiyt?
- What type of segment may function as a 'nucleus' or syllable nucleus in such words?
- Are there any syllables in such languages? If so, are they fundamentally different from those in French and English?

Let us consider the first question. The vocalic hypothesis connects syllable nuclei with vowels- vowels are expected to be the only type of segment permitted to occur in the nucleus of a syllable. The number of vowels in a sequence is, therefore, an indication of the number of syllables.

The vocalic hypothesis as it stands- the nucleus of a syllable is a vocalic segment i.e. in Tashlhiyt this would be *i, a, u* -cannot account for data from Tashlhiyt given that the latter has many vowelless words.¹

Consider the following examples:

¹ Note also that a strict interpretation of the vocalic hypothesis would disallow the occurrence of syllabic sonorants in English.

(8)

zr 'look'
gzm 'cut'
snfl 'exchange'
mrmd 'wallow'

The vocalic hypothesis cannot syllabify the examples in (8) as they do not contain vowels yet they are syllabified as:

(9)

zr 'look'
g.zm 'cut'
sn.fl 'exchange'
mr.md 'wallow'

One way of dealing with this, is to call on the *Sonority Hierarchy* (Selkirk 1984) which organises phonetic segments on a scale showing their relative resonance in relation to other segments. This is shown in (10). Syllabification is carried out through Sonority Sequencing Generalisation: segments are syllabified in such away that sonority increases from the margin to the peak. Which means that segments are organised according to their degree of sonority with the least sonorant segment occupying the initial position (syllable margin) followed by the next sonorant segments. The segments are organised in the reverse order with the least sonorant

segment occupying the final position (syllable margin). Syllables with high-sonority peaks are favoured over syllables with low-sonority peaks.

The Sonority Hypothesis enables us to account for the data in (7). According to this hypothesis, any segment can occupy the nucleus position if it is the most sonorous in a sequence of segments. The underlined segments in (7) are the nuclei of the syllables where they occur, because they are the most sonorous segments in the cluster. These will be analysed below.

According to the universal sonority scale, low vowels have the highest sonority index whereas voiceless stops have the lowest. This is shown in (10):

(10)

Low V; High V; Liquids; Nasals; +v Fricatives; -v Fricatives; +v stops; -v stops

8 7 6 5 4 3 2 1

In sequences where we have sonorant segments, these occupy the nucleus positions depending on their sonority index relative to the sonority index of neighbouring segments. For a sound to occupy the nucleus position, its sonority index and the sonority indices of its neighbouring sounds are important. The most sonorous sound in the string acts as the nucleus of a syllable. This entails that any such segment can acquire the status of syllabicity independently of the class to which it belongs (Dell & Elmedlaoui 1985).

According to the sonority hypothesis, the more to the left of the scale a class of segments is the more sonorous its members are. With an example like *tRgLt* 'you locked' we see that in the sequence *trg* the sonorant *r* is more sonorous than either of the stops *t* and *g*. In that sequence the *r* would be the nucleus of the syllable. Likewise, in the sequence *glt* the *l* is the most sonorous and therefore the nucleus of the syllable. In the sequence *tsk* in *tSkRt* 'you did', *s* is more sonorous than *t* and *k* while in the sequence *krt*, *r* is more sonorous than *k* and *t*. Therefore, *s* and *r* occupy the nucleus position.

In the example *tXzNt* 'you stored', *x* and *n* occupy the nucleus position as we can see that *x* is more sonorous than *t* and *z* in the sequence *txz*, while *n* is more sonorous than *z* and *t* in the sequence *znt*. *r* is more sonorous than *t* and *k* in the sequence *trk* while *s* is more sonorous than *k* and *t* in the example *tRkSt* 'you hid'. *r* and *s*, therefore, occupy the nucleus position. In the example *tMsXt* 'you changed', *m* is more sonorous than *t* and *s*, while *x* is more sonorous than *s* and *t*. Therefore, *m* and *x* occupy the nucleus position.

1.4.3 The Basis for Tashlhiyt Syllabification

The organisation of phonetic units into syllables with an internal constituency of onset, nucleus and coda form the basis of phonological structure of a language. The syllabification of these constituents is based on them meeting conditions of well-formedness specific to the language in being analysed.

Tashlhiyt syllabification gives a central role to the sonority relationship between adjacent segments. The empirical generalisations adopted in this study are drawn from Dell & Elmedlaoui (1985; 1988). In a nutshell, syllable nuclei must have the highest degree of sonority compatible with other requirements such as the prohibition of hiatus. The analysis operates within a rule-and-constraint framework. Starting from representations devoid of any syllabic structure, syllables are built step by step through the operation of sequentially-ordered rules.

Our analysis in this thesis will be based on the following assumptions which will form the basis of the discussions in the subsequent chapter:

- a. All segments are susceptible to occupy the syllable peak position
- b. No two contiguous segments can be syllable peaks
- c. No segment can belong to two syllables
- d. Geminates are considered as a sequence of two identical segments
- e. High vocoids i.e. /i, u, j, w/ are realised as /i/ and /u/ when they occupy syllable peak position; otherwise they appear as /j/ and /w/ respectively.
- f. Syllables are formed by a simple mechanism of *Core Syllabification* (CS)²

² *Core Syllabification*: associate a core syllable with any sequence (Y) Z, where Y can be any segment and Z a segment of type T, where T is a variable to be replaced by certain set of feature specifications

Syllable Building Conventions are largely complementary to the basic assumption above. They consist of 5 successive steps, and they apply in turn to any unsyllabified string of segments.

1.4.4 Syllable Weight

Syllable weight is one of the most debated problems in phonology. Two questions have usually been address:

(11)

- a. How can the notion of syllable weight be best represented?
- b. How can we express the fact that some syllable types (especially CVC) may have a different status in different languages?

In CV Theory, long segments, geminates and long vowels alike, are represented by a single melody units linked to the two (C/V or X) skeletal slots (Clements and Keyser, 1983; Levin, 1985).

(12)

a. Low vowel



b. Geminate consonant



This basic assumption about phonological length has been carried over in works on feature geometry, where a root node is assumed to take the place of a single melody unit.

In Moraic Theory, on the other hand, a long segment is represented as a single root node linked to two different positions in a syllable/mora structure, as in (13):

(13)

a. Long vowel



b. Geminate consonant

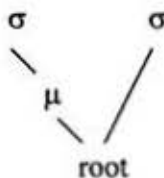

A mora is defined as unit of phonological length which determines syllable weight. The weight of a syllable is measured by counting the number of moras it contains: if the syllable contains one mora, it is light. If, on the other hand, it contains two moras it is heavy.

The moraic theory is conceived of as a universal theory of length (McCarthy & Prince, 1993b; Hayes, 1989). They further assume that length is reflected directly in underlying forms. Accordingly, vowels, long or short, are inherently moraic. An underlying geminate consonant differs from a simple consonant in terms of a mora.

Following (Jebbour, 1996) we will use the moraic framework in chapter 5 to account for geminates in imperfective syllabification.

1.4.5 Phonetic Vs Phonological vowels and consonants

In order to achieve a an exact phonological and phonetic description of any given segment, it is best to use different the different terms for each representation following Pike (1943) who uses the term *vocoid* and *contoid* for phonetic vowels and consonants respectively. *Syllabic* and *non-syllabic* are used for vowels and consonants in the phonological sense from the point of view of their function in the syllable. The phonetic description remains constant, while the phonological description may vary from language to language and in some cases from context to context within the same language. A phonetic vowel is, therefore, a vocoid. When a phonetic vowel corresponds with a phonological vowel, this is referred to as a syllabic vocoid.

In English, the normal vowels are syllabic vocoids. Sometimes, however, a phonetic vowel behaves phonologically like a consonant and then we have a non-syllabic vocoid such as /j/ and /w/. By the same token, a phonetic consonant is a contoid. Normally a contoid is also a phonological consonant, and so we have a non-syllabic contoid. There are, however, phonetic consonants behaving as a phonological vowel and these are referred to as syllabic contoids like /l/ and /n/ for instance.

Establishing a similar distinction to account for these segments is crucial for the analysis of Tashlhiyt syllabification we will discuss in chapter 5.

1.4.6 Other Berber languages

In this section, we will analyse the other Berber dialects to highlight how they differ from Tashlhiyt in dealing with consonant clusters and how these are syllabified.

1.4.4.1 Tarifit Berber

Like Tashlhiyt, Tarifit has two underlying glides /y, w/ and three underlying full vowels /a, i, u/. Besides glides and full vowels, the surface forms in Tarifit also contain short voiced vocoids. There is, however, a difference between the two in that the voiced transitional vocoids in Tashlhiyt are not segments, some of the short voiced vocoids of Tarifit are epenthetic vowels as we will see below.

The analysis proposed to account for Tashlhiyt syllable structure, where schwa does not exist and where consonants occur in the nucleus position, is not applicable to the data available from Tarifit³ (Chtatou 1982; 1991). Insertion of schwa is the means by which a potential violation of syllable structure is avoided. Schwa is not only inserted to break inadmissible clusters, but most importantly it is epenthesized to serve as the nucleus of a given peakless syllable. This is illustrated in the

³ This dialect, also known as Rifan Berber, is spoken in the Rif mountains of Northern Morocco.

syllabification of the examples given in (14). These data indicates that onsets are not required, unlike in Tashlhiyt:

(14)

a. /z/	[əz]	‘to leave behind’
b. /ns/	[əns]	‘to spend the night’
c. /nq/	[nəq]	‘to kill’
d. /hsb/	[əhsəb]	‘to count’
e. /sk/	[sək]	‘to send’
f. /znz/	[zənz]	‘to sell’

(Chtatou 1991: 44)

The data in (14) is accounted for using schwa insertion rules of Tarifit formulated by Chtatou as follows:

$$(15) \quad \emptyset \rightarrow \emptyset / \# \left[\begin{array}{c} \sigma \\ _ C \end{array} \right] \left[\begin{array}{c} \sigma \\ _ \end{array} \right]$$

$$(16) \quad \emptyset \rightarrow \emptyset / [C _ C] \{ [_ \#] \}$$

$$(17) \quad \emptyset \rightarrow \emptyset / \left(C _ \left\{ \begin{array}{c} C \\ CC \\ NO \end{array} \right\} \right)$$

$$(18) \quad \emptyset \rightarrow \emptyset / \left(_ \left\{ \begin{array}{c} C \\ NO \end{array} \right\} \right)$$

(Chtatou 1991: 43)

In (15) – (18) C stands for geminate consonants, CC for non-homorganic clusters and NO for non-homorganic nasal + obstruent coronal cluster. These intrinsically ordered schwa insertion rules apply to the data in (14) as follows:

(19)

a. /z/ [əzz] ‘to leave behind

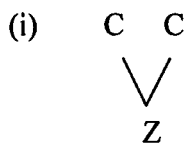

(ii) Rule (18) applies to insert a schwa before a the geminate

(iii) Syllabification

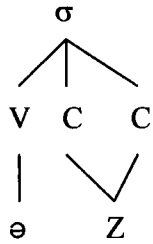

b. /ns/ [əns] 'to spend the night'

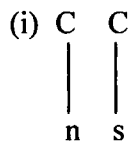

(ii) Rule (18) applies to insert the schwa before the non-homnorganic nasal and the obstruent.

(iii) Syllabification

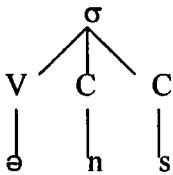

c. /nq/ [nəq] 'to kill'

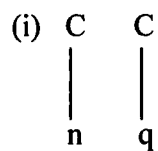

(ii) Rule (16) applies to break the consonant cluster

(iii) Syllabification

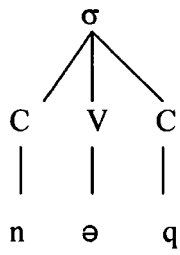

d. /hsb/ [ɛhɛb] 'to count'

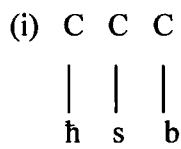

(ii) Rule (16) applies to break the consonant cluster

(iii) Syllabification

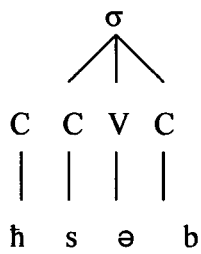

(iv) Rule (15) applies

(v) Syllabification

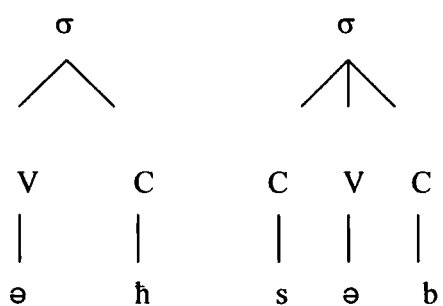

e. /sk/ sək 'to send'

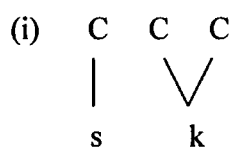

(ii) Rule (17) applies to insert a schwa between a single consonant followed by a geminate

(iii) Syllabification

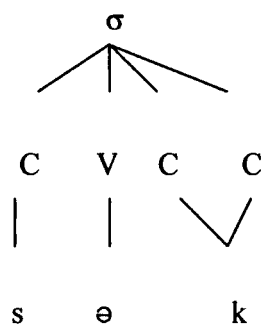

f. /znz/ zənz 'to sell'

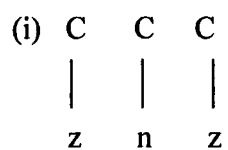

(ii) Rule (17) applies to insert a schwa between a consonant and non-homorganic nasal + obstruent.

(iii) Syllabification

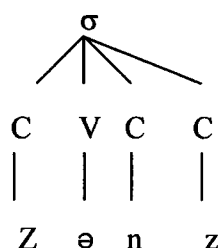

The rules formulated by Chtatou to account for the syllabification of Tarifit yield the right output without reference to directionality. Some consonants can be syllabic in environments devoid of vocalic peaks, as is the case in Tashlhiyt. In the case of Tarifit, however, schwa is inserted to occupy the peak position. We will now look at the analysis of Tamazight Berber.

1.4.4.2 Tamazight Berber

In Ayt Ndhir Tamazight (Saib, 1976; Penchoen, 1973), schwa epenthesis is predictable and only occurs in the following environments:

(20)

- a. Between a consonant and a word-final consonant C__C#

- b. Between C1 and C2 of a C1C2C3 cluster C__CC
- c. Between a consonant and a geminate C__C:
- d. Before a word-initial CC cluster #__CC
- e. Before a word-initial geminate #__C:

In forms without geminates, the surface pattern of epenthesis can be derived from underlying forms lacking schwa by the following rule, applying from left to right:

(21)

$$\emptyset \rightarrow \text{ə} / \left\{ \begin{array}{c} \text{C} \\ \# \end{array} \right\} \text{---} \text{C} \left\{ \begin{array}{c} \text{C} \\ \# \end{array} \right\}$$

(Saib 1976:128)

[əxðəm] 'to work' is, therefore, derived from underlying /xðm/ as follows:

(22)

- a. xðm
- b. xðəm C__C#
- c. əxðəm #__CC

It is important to note at this stage that a) consonant clusters never occur word-initially or word finally, and triconsonantal clusters do not occur medially, b) schwa never occurs before CV or at the end of the word. Schwa, therefore, predictable and

is inserted when the absence of a vowel would lead to a sequence which could not be broken up into syllables. Consider the following:

(23)

CVC	.əm.lil.	'to be white'
CV	.sa.	'something'
VC	.um.lil.	'white'
V	.i.ni.	'to say'

(Saib 1976:125)

The examples in (23) are instances of surface syllables in Ayt Ndir Tamazight, excluding forms with geminates. Schwa is inserted to allow a full syllabification when the absence of a vowel would lead to a sequence which could not be broken up into syllables. A similar analysis is given in Bader (1984, 1985) and Dell and Tangi (1992). In both accounts, an ordered set of syllabification rules are applied to underlying strings of consonants and vowels where there is no schwa. When a string contains #CC, CC# or CCC clusters, the rules build structures in which the nuclei of some syllables lack vowels; where such a syllable occurs, schwa is inserted to satisfy the lack.

Guerssel's analysis of Ait Seghrouchen⁴ (Guerssel 1985) follows the same assumptions and defines the maximal syllable as CCVC. The nucleus is the only obligatory element, while the consonantal positions may or may not be filled. He proposes the following syllabification algorithm consisting of a set of ordered rules.

R stands for rime and O stands for onset. The analysis assumes underlyingly specified nuclei:

(24)

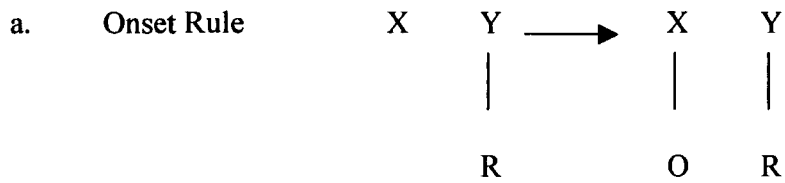

This rule applies to the string to attach the onset node.

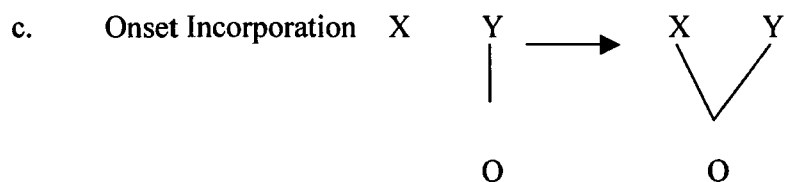
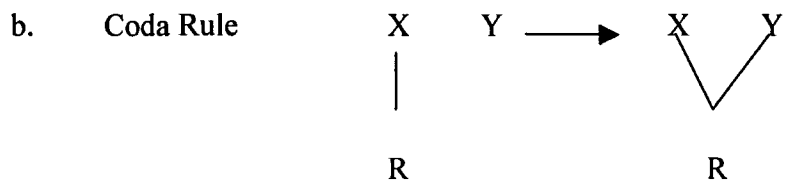

Rule (24c) is necessary in order to avoid unattested syllabification of the sequence VCCV.

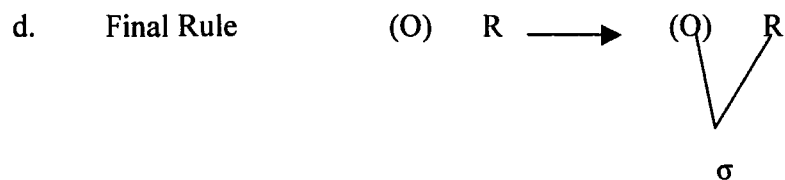

(Guerssel 1985: 84)

⁴ Ait Seghrouchen a dialect of Tamazight spoken in the Middle Atlas mountains in Morocco.

The order of the rules in (24) is important in order to derive the correct pattern. The *Coda Rule* (24.b) should be applied before (24.c) to lead to the syllabification of the sequence VCCV as VC.CV not *V.CCV. The application of the rules in (24) is illustrated in the syllabification of /*absrur*/ 'bunch':

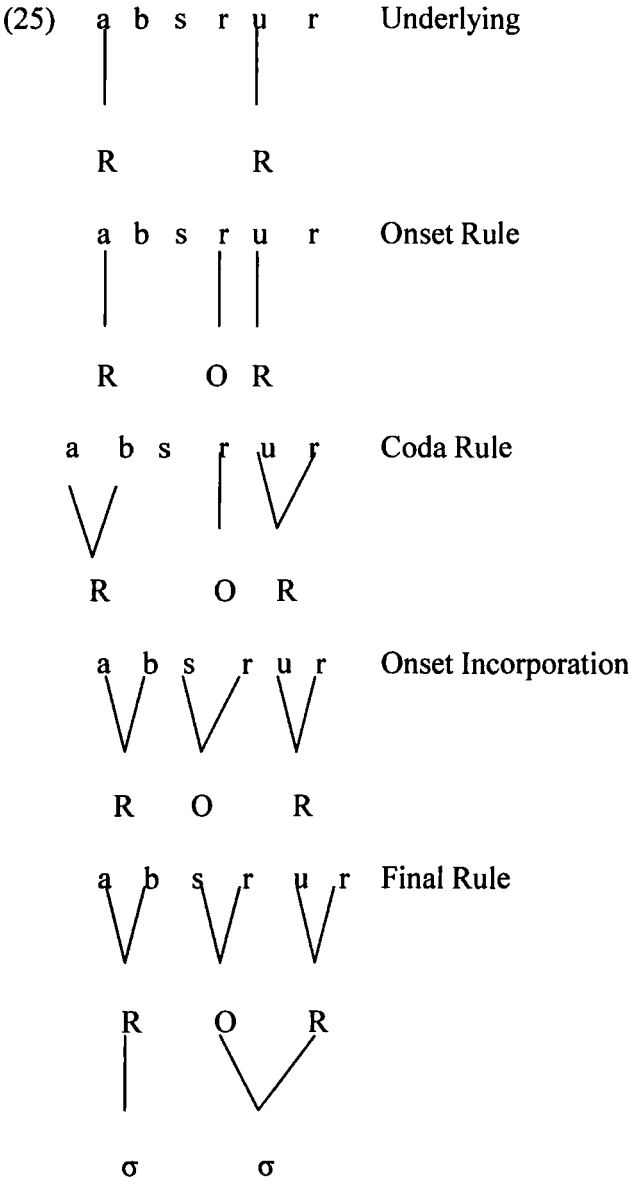

(Guerssel 1985: 84)

In order to derive the correct pattern, both rules *a.* and *b.* are necessary and *c.* must be ordered before the two. Failure to do that will result in syllabifying the cluster VCCV as V.CCV. instead of VC.CV.

In the case of sonorant syllabification, Guerssel follows Selkirk's Sonority Sequencing Generalisation formulated as follows:

(26) Sonority Sequencing Generalisation:

In a given syllable, there is a segment constituting a sonority peak that is preceded and or followed by a sequence of segments with progressively decreasing sonority values.

(Selkirk 1984:116)

Following this generalization, Guersell proposes a *Rime Rule* ordered before the rules in (24):

(27) *Rime Rule:*

Assign an unlinked sonorant to a rime provided it is not adjacent to a more sonorant segment

(Guerssel 1985: 90)

This rule states that a sonorant is not assigned to a rime node when it is adjacent to a more sonorous segment as illustrated bellow:

(28) a s r d u n Underlying

| | |
R O R

a s r d u n Rime Rule

| | | |
R R O R

a s r d u n Onset Rule

| | | | |
R O R O R

a s r d u n Coda Rule

| | | | ✓
R O R O R

a s r d u n Final Rule

| | | | ✓
R O R O R
| ✓ ✓
σ σ σ

(Guerssel 1985: 91)

Sonorants are not assigned to a rime node when adjacent to a more sonorous segment. The syllabification rules in (24) used to account for sonorants fail in syllabifying obstruents. When applied to the forms in (29), some segments remain unsyllabified.

(29)

<u>fs</u> .lax	'lets untie'
<u>cf</u> .nax	'lets shroud'
<u>tf</u> .si	'it melted'
am. <u>sf</u> .lid	'listener'
<u>xt</u> .fi.di	'on the wound'
<u>bd</u> .hl	'rave'
jx .tn	'I do them'
jb .dax	'let's pull'
ɣf .lax	'let's surprise'
xz .nax	'let's store'

(Adapted from Guerssel 1985: 94)

In consonant only syllables, syllabicity is indicated in bold and the segments which remain unsyllabified are indicated by the underscore. The Rime Rule formulated to account for the sonorant segments does not give the same result with the data in (29). A sonorant is linked to rime provided it is adjacent to a segment of equal or lesser sonority. In (29), however, it is the rightmost of two obstruents that constitutes the syllable peak regardless of sonority.

Sonorant syllabification is the first rule applied, thus creating the input to the onset and the coda rules. In the case of obstruents, it seems that their syllabification must come after the coda rule has applied, as the example *is.tir* ‘he protected me’ indicates. If obstruent syllabification is applied before the coda rule, one would expect *istri* to surface as **i.st.ri*, where *st* is syllabified in the same manner as analogous stings in (29) are. But *istri* is disyllabic, not trisyllabic; as a consequence of these observations, Guerssel (1985) proposes that obstruents are to be syllabified by a rule other than Rime Rule (27). This calls for the following rule:

(30)

$$\begin{array}{rcc}
 \text{Onset Rime Rule :} & x' y' & \rightarrow & x & y \\
 & & & | & | \\
 & & & O & R & \text{Right -to-left}
 \end{array}$$

(Guerssel 1985: 96)

The rules are given in order of application. The *Onset Rime Rule* (30) is ordered before *Onset Incorporation* (24c) on the basis of the example *am.sf.lid* given in (29). If the rule were ordered after it, the segment *f* would be incorporated into the onset. But phonetically, /f/ in this instance occupies the nucleus position, not the first onset position of the following syllable.

(31)

Core Syllabification Rules

- a. Rime Rule (17)
- b. Onset Rule (14a)

Adjunction Rules

- c. Coda Rule (24b)
- d. Onset-Rime Rule (29)
- e. Onset Incorporation (24c)
- f. Final Rule (24d)

(Adapted from Guerssel 1985:96)

Guerssel's analysis shows that the unsyllabified stops are not treated in the same way as the sonorants and the fricatives discussed. The former are subject to Onset-Rime Rule (29) as well as to a schwa insertion rule due to the fact that in Ait Sghrouchen, stops do not constitute syllable peaks unlike sonorants and fricatives which do (Guerssel 1985). We note here that it appears that voiceless stops may be syllabic in certain examples (e.g. *ttett* 'eat (imperfective)', *ttekk* 'pass (imperfective)' etc. However, according to Guerssel, it seems that these examples contain voiceless schwas, not syllabic stops.

(32)

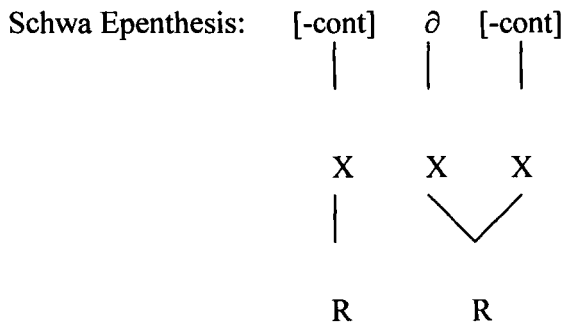

(Guerssel 1985:98)

This is illustrated by the examples in (33)

(33)

<u>Underlying</u>	<u>Phonetic</u>	
bddl	bəddl	'change'
zgga	zəgga	'when'
ttggx	tətggx	'I am doing'
ckkint	cəkint	'you (m.s)'

(Guerssel 1985:98)

Correct syllabication is achieved by sonorants and fricatives becoming syllabic by rule while schwa is inserted before stops and cannot be syllabified.

The Rime Association Convention proposed by Guerssel is challenged by Taqbaylit Berber where a segment that is lower on the sonority scale than its neighbours is seen to be associated with the rime instead of an adjacent segment which happens to be more sonorous.

1.4.4.3 Taqbaylit Berber

Bader (1985, 1989) and Dell and Tangi (1992) propose similar analyses. In both accounts, an ordered set of syllabification rules are applied to underlying strings of consonants and vowels containing no schwa. When a string contains #CC, CC#, or CCC clusters, the rules build structures in which the nuclei of some syllables lack vowels; where such a syllable occurs, schwa is inserted.

Taqbaylit syllable structure is simple and consists of Onsets and Rimes:

(34)

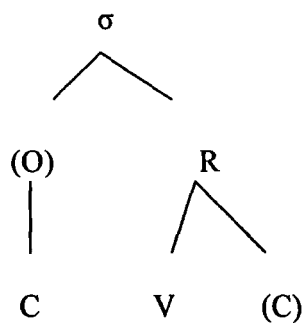

The basic schema in the language is CVC and the syllable-building rules are a rime rule, an onset rule and a coda rule:

(35)

- a. Assign a vowel to a Rime
- b. Assign a prevocalic consonant to an Onset
- c. Assign a string of one or more unassigned consonants to alternating Rime and Onset position starting from the right end of the string
- d. Join under the Rime node two consecutive Rime nodes, and
- e. Final syllabification is obtained by grouping together Rime and Onset nodes into a syllable

(Bader 1985: 228)

These syllable-building rules when applied to forms that do not contain a schwa, result in the correct syllabification for forms like *agur*, *argaz* and *ruħ*:

(36)

a g u r	a r g a z	r u ħ
VC VC	VC CVC	C V C
R R	R R	R

Rule (a)

a g u r	a r g a z	r u ħ
VC VC	VC CVC	CVC
R O R	R O R	O R

Rule (b)

a g u r	a r g a z	r u ħ
VC VC	VC CVC	CVC
R O R R	R R O R R	O R R

Rule (c)

a g u r	a r g a z	r u ħ
VC VC	VC CVC	CVC
\	\ \	\
R O R	R O R	O R

Rule (d)

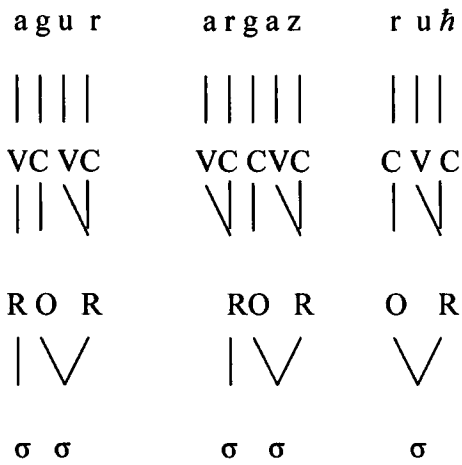

Rule (e)

(Bader 1985:229)

Taqbaylit differs from Ait Seghrouchen in that it does not contain an onset incorporation rule in its grammar but like in Ait Seghrouchen, schwa is not an underlying segment in Taqbaylit. Underlying strings from the two languages are compared in (37):

(37)

a. Ait Seghrouchen	b. Taqbaylit	
wltma → ultma	wltma → weltma	‘my sister’
ymjr → imjr	ymgr → yemger	‘he reaped’
crz → cṛz	krz → ekrez	‘plow’
sfdas → sf̣das	sfdas → sefdas	‘wipe for him’

(Guerssel 1985:102)

Ait Seghrouchen allows certain consonants to be syllabic, these are indicated in (37) by an underscore, while Taqbaylit does not allow syllabic sonorants nor syllabic obstruents instead it exhibits a schwa before those consonants.

In Taqbaylit schwa insertion is used to avoid the occurrence of unacceptable syllable structures. For instance, if a syllable structure arises which lacks a Rime dominating V-slot, i.e., a syllable which does not conform to the template in (34) above like a string of four consonants, rule (35c) will assign them to alternating Rime and Onset positions starting from the right end. However, when we come to the final syllabification, we are left with unacceptable syllable shapes, namely, syllables without vowels. To avoid the generation of these forms, schwa insertion rule is formulated:

(38)

- a. If a rime node fails to dominate a vowel slot, adjoin a V-slot to the Rime
- b. Spell out a V-slot that is unlinked to a segment in the phonemic core as a schwa

(Bader 1985: 231)

This schwa insertion is governed by the syllabification algorithm in that it is only inserted before consonants assigned to syllable rimes, i.e. it is ordered after rule (36d) of the syllable-building rules specific to the language preventing its occurrence prepausally.

Taking the new schwa rule into account the syllable-building rules are listed below in the relevant order with the schwa rule renamed rule (e) and (f) whereas final syllabification has been entitled rule (g):

(39)

- a. Assign a vowel to a Rime
- b. Assign a prevocalic consonant to an Onset
- c. Assign a string of one or more unassigned consonants to alternating Rime and Onset positions starting from the right end of the string
- d. Join under one Rime node two consecutive Rime positions
- e. If a Rime node fails to dominate a vowel slot, adjoin a V-slot to the Rime
- f. Spell out a V-slot that is unlinked to a segment in the phonemic core as schwa
- g. Final syllabification is obtained by grouping together Rime and Onset nodes into a syllable

(Bader 1985: 231)

The syllable-building rules above derive the correct form of the following words containing schwa *jen* 'sleep', *ǎdǎm* 'work' and *agurǎn* 'moons' from underlying /jn/, /xdm/ and /agurn/ respectively:

(40)

j n	x d m	a g u r n
C C	C C C	V C V C C
		R R

inappl. rule (a)

j n	x d m	a g u r n
C C	C C C	V C V C C
O R	R O R	R O R O R

rules (b) and (c)

rule (d) inappl.

j n	x d m	a g u r n
C V C	V C C V C	V C V C V C
O R	R O R	R O R O R

rule (e)

j ∂ n	∂ x d ∂ m	a g u r ∂ n
C V C	V C C V C	V C V C V C
O R	R O R	R O R O R

rule (f)

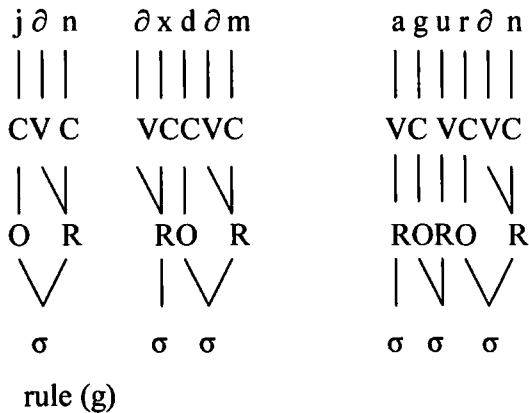

(adapted from Bader 1985: 231)

Schwa never occurs in open syllables (i.e. before CV or prepausally) it only occurs before CC or prepausal C:. The absence of schwa in open syllable is accounted for by first assigning consonants to particular syllable positions before schwa insertion.

1.5 Conclusion

It has been shown that Tashlhiyt has vowelless words which cannot be syllabified using the vocalic hypothesis alone. The sonority hypothesis is called for to account for the syllabification of strings of consonants. Applying the sonority hypothesis to the language allows any consonant, either obstruent or sonorant, to be the nucleus of the syllable.

The sonority hypothesis, however, does not account for the stray consonants left

unsyllabified in the Northern Berber languages Tarifit, Tamazight and Taqbaylit which call for schwa epenthesis to avoid any violations in the syllable structure of the language. Schwa is inserted not only to break the consonant clusters but also to serve as the peak of the syllable. Syllable-building rules in combination with schwa epenthesis are imposed on the strings of segments to result in the correct syllabification of these languages.

Chapter 2

Tashhiyt Syllable and Syllabification

Chapter 2

2.1 Introduction

In this chapter, we will show more evidence in support of the syllable structure and syllabification of Tashlhiyt introduced in the previous chapter. We will first give an overview of the previous accounts of Tashlhiyt syllabification by looking closely at Core Syllabification by Dell & Elmedlaoui (1985; 1988), then, we will show how their analysis is dealt with by Coleman's (1996; 2001) Syllabification Algorithm and by the Optimality Theoretic account in Prince & Smolensky (1993). The general aim is to submit these analyses to a critical evaluation, within their aims and assumptions, in the interest of placing our analysis, which goes hand in hand with Dell & Elmedlaoui's analysis, on the firmest grounds possible.

2.2 Syllable configuration in Tashlhiyt

In an early study by Halle and Vergnaud (1979), the number of segments in a syllable in Berber is limited to four. The onset in this syllable pattern consists of one optional non-syllabic segment, and the rime is composed of one obligatory nucleus plus an optional branching coda. In other words, the number of permissible syllables is restricted to six possible patterns: CVCC as the maximal expansion where all the possible slots are filled- CVC, CV, VCC, VC, and finally V- as the minimal

expansion of a syllable, where only the obligatory segment is realised. The following template gives the possible expansions:

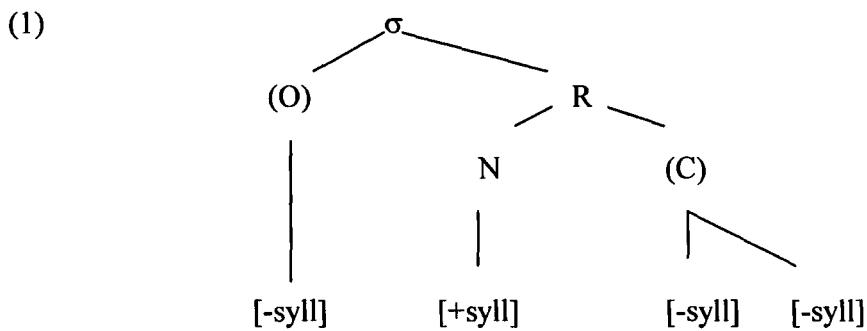

It is important to note that this template excludes a number of other possibilities, namely those which contain a branching onset i.e. CCV, CCVC and CCVCC. Instantiations of these excluded possibilities are quite abundant in the language. Consider, for example, the items in (2):

- (2)
- | | | |
|-------|-------|--------------------------|
| sti | CCV | 'choose' |
| klan | CCVC | 'they (m) spent the day' |
| zlint | CCVCC | 'they (f) are isolated' |

Therefore, an alternative template, which gives all the possible expansions, is required:

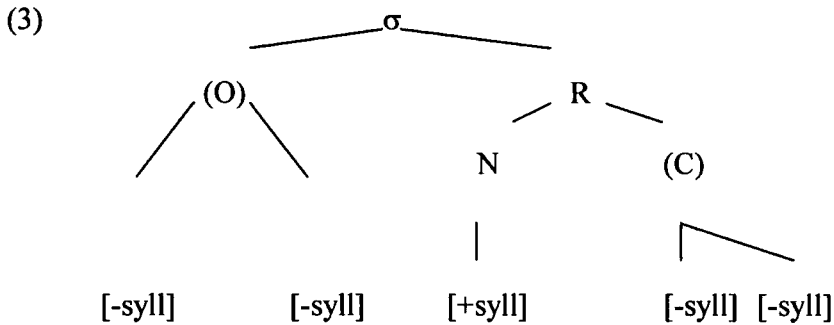

The template (3) represents the general syllable of Tashlhiyt and it includes all the possibilities attested (the elements in brackets are the optional elements). Tashlhiyt syllable types given show that in the language syllables can contain a maximum of five elements and a minimum of one. This also shows that syllables may have a branching onset, a simple onset, or no onset. Within the rhyme constituent, the nucleus is obligatory and the coda, which is realised either as C or CC, is optional.

Guerssel's (1985) analysis of the Ait Seghrouchen dialect also recognised the existence of branching onsets. The maximal expansion assumed is CCVC. The nucleus in this syllable pattern is obligatory, and the other consonantal positions may or may not be filled. The instantiations of the possible patterns are given below:

(4)

i 'to'
da 'here'
fli 'crack'
fsi 'melt'
zdi 'link'
af 'find'
tus 'is fit'
stin 'they filtered'

This canonical syllable differs from Halle and Vergnaud (1979) in that the latter exclude two pre-nuclear positions while Guerssel includes two post-nuclear positions. However, a number of constraints are postulated on pre- and post nuclear material. It is argued that biconsonantal clusters could be permitted word-finally but only with the condition that they be members of linked feature matrices:

(5)

ixf 'self'
anasf 'half way'
wajb 'answer!'

The post nuclear clusters in the examples above agree in their voicing feature value. There are, however, some forms which consist of post-nuclear biconsonantal clusters

which do not have the same voicing feature value examples of which are: /ils/ ‘tongue’ and /zdint/ ‘they linked’.

We deduce from this procedure that for any post nuclear clusters, we would have to look for at least one feature in common, and there will always be a feature in common as long as they belong to the [+cons] set. This in our view could be dealt with by opting for a simpler alternative to treat the issue of syllable patterns in Tashlhiyt.

2.2.1 Syllable patterns in Tashlhiyt

The position held in this study goes along the lines of that expressed in Boukous (1987a). In other words, to avoid the deficiencies in both procedures, it is assumed that the syllable in Tashlhiyt is maximally /CCVCC/ and minimally /V/. This entails a number of assumptions:

(6)

a. The canonical template allows for nine possible expansions:

V- VC – VCC – CV - CCV- CVC – CCV – CVCC – CCVCC

b. It excludes non-syllabified tri-consonantal clusters on either margin.

c. Following from (b) is the observation that syllables may have a branching onset, a simple onset, or no onset. Within the rime constituent, the nucleus is obligatory and the coda, which is realised either as C or CC is optional

Instantiations of the canonical syllable patterns are given in (7). It is, however, important to note that Tashlhiyt Berber exhibits a wealth of segment sequences which contain no vowels. These consonantal clusters are syllabified according to the *Relative Sonority Prominence* principle. In the examples in (7a) a vowel is at the nucleus position. In (7b) instantiations of the canonical syllable patterns equivalent to those in (7a) are given with example containing no vowels. Here the symbol V is taken as an abstract unit marking any segment which is syllabic (while elsewhere V represents vowel and C represents consonant).

(7)

(7a)	Vocoid nucleus		(7b)	non-vocoid nucleus	
V	i	‘to’	V	n	‘of’
VC	ut	‘hit’	VC	rz	‘break’
VCC	lls	‘tongue’	VCC	rzt	‘break it’
CV	γl	‘here’	CV	fl	‘leave’
CCV	slI	‘touch’	CCV	sy r	‘harden’
CVC	sul	‘still’	CVC	krf	‘tie’
CCVC	bdan	‘they began’	CCVC	sfld	‘listen’
CVCC	fast	‘give it to him’	CVCC	srst	‘put it down’
CCVCC	gllxt	‘I guided him’	CCVCC	tsrst	‘you put it down’

(Adapted from Moktadir 1989: 63-64)

2.2.2 Tashlhiyt syllabicity

Tashlhiyt allows any segment - including non-continuant obstruents - to occur as syllable nuclei. This can be seen in the table in (8) which shows that as opposed to French and English, in Tashlhiyt consonants and vowels occur in the third category as alternating segments:

(8)

	English	French	Tashlhiyt
Always in nucleus	Non-high vowel	Non-high vowels	Non-high vowels
Never in nucleus	Obstruents	Consonants	
Alternating	High vowels/Sonorants	High vowels	Vowels/ Consonants

The fact that in Tashlhiyt consonants and vowels belong to the third category the syllabicity of a segment depends on its position within the syllable template. Importantly, the C-V distinction is underlyingly neutralised and it is the syllable building conventions which determine the ultimate function of a segment as C or V. Determining the syllabicity of a segment consists of comparing its relative sonority prominence with respect to its neighbouring segments.

Any segment, which is a syllabic peak in a syllable configuration, is said to be a syllabic segment. This entails that any such segment can acquire the status of syllabicity regardless of the class of segment type to which it belongs. The role of a syllable configuration is, therefore, crucial in determining the relative syllabicity of a segment.

The following examples from Dell & Elmedlaoui (1985:112, 1988: 1) illustrate the various instances. The syllable edges are marked by a dot and the nucleus of the syllable is indicated in bold.

(9)

Nucleus type	Example	
Vowels	.il.di.	‘he pulled’
	.rat.lult.	‘you’ll be born’
Liquids	.tr.glt.	‘you locked’
Nasals	.tzmt.	‘it (f) is stifling’
Fricatives	.tf.tkt.	‘you suffered a strain’
	.tx.znt.	‘you stored’
	.txz.nakk .	‘she even stored’
Stops	.bd.dl.	‘exchange’
	.ma.ra.tgt.	‘what will you be?’
	.ra.tk.ti.	‘she will remember’

We note from the data above that even words consisting entirely of voiceless stops, like *tf.tkt* ‘you suffered a sprain’, are fully syllabifiable without resource to epenthesis or deletion.

Another language which allows syllabic obstruents is Bella Coola, a Salish language spoken on the central coast of British Columbia (Bagemihl 1991). Long sequences of consonants as well as vowelless words are permitted in the language:

(10)

<i>lq</i>	‘wet’
<i>tx̣t</i>	‘stone’
<i>χ_{sec}</i>	‘I’m now fat’
<i>lχ</i>	‘you spat on me’

(Bagemihl 1991:589)

2.3 Syllabification procedure

Tashlhiyt Berber syllabification is described in two publications by Dell & Elmedlaoui (1985, 1988). In their account, Tashlhiyt Berber has a set of rules collectively referred to as Core Syllabification (CS) which apply serially to construct CV (or ‘core’) syllables over unsyllabified input strings. Subsequent rules gather the remaining unsyllabified material into codas, and adjust syllabifications created by the

CS rules in pre- and postpausal position. In the next section, we will look closely at Dell & Elmedlooui's analysis.

2.3.1 Dell & Elmedloui's Core Syllabification

Dell & Elmedlaoui (1988) define the canonical syllable as CVCC where only V is obligatory and argue for a set of rules which if applied suffices to yield the right syllabification. In this analysis, V is used to refer to the nucleus of the syllable. Their analysis shows that for a sound to occupy the syllable peak depends on its sonority index and the sonority indices of neighbouring sounds. The most sonorous sound in a string, undergoing syllabification, is the sound that acts as the nucleus. This procedure, however, allows many possibilities which leads to the introduction of the following constraints:

(11)

- a. Prohibition of Hiatus:* identical syllable peaks are not allowed to occur in the phonetic representation.
- b. Core Syllabification:* associate a core syllable with any sequence (Y) Z, where Y can be any segment and Z a segment of type T, where T is a variable to be replaced by certain set of feature specifications.

Core syllables are therefore of the form CV, where C and V are single segments and V (consonant or vowel) represents the syllable peak. Individual rules are derived

from it by replacing T with feature specifications corresponding to each of the sonority classes.

The constraint in (11b) prevents the occurrence of onsetless syllables by assigning an onset to any syllable peak selected. Furthermore, in a situation YZ where Y and Z have equal sonority indices, Y is assigned the peak status according to the directionality of syllabification, namely left-to-right. In addition, when certain segments are still unsyllabified, even after application of the *Core Syllabification*, the *Well-formedness Conditions* are introduced: every segment must be associated to an S-node, a segment must be associated to at most one S-node.

Consider the examples in (12):

- (12) tf.tkt ‘you suffered a sprain’
 tfk.tst ‘you gave it’

Taking into consideration these issues of sonority, directionality and well-formedness, Dell & Elmedlaoui propose a syllabification algorithm where obstruents may potentially be syllabic:

- (13) ‘Associate a core (onset-nucleus) syllable with any sequence (Y)Z, where Z is a low vowel, a high vocoid, a liquid, a nasal, a fricative, a stop.’

(Dell & Elmedlaoui 1988: 4)

In spite of its tolerance of typologically unusual syllable peaks, Tashlhiyt syllabification obeys strict principles. One fundamental principle stated in Dell & Elmedlaoui (1985:113) as follows:

(14) Onset Principle: All syllables must have an onset.

This constraint is strictly obeyed everywhere except in postpausal position where onsetless syllables are freely tolerated. Syllabification is carried out according to principles that favour syllables with high-sonority peaks over syllables with low-sonority peaks. This is noted in the following generalisation from Dell & Elmedlaoui (1985:109):

15)

Peak Preference

When a string ... PQ ... could conceivably be syllabified either as ... P'Q ...

Or as ... PQ' ... (i.e. when either syllabification would involve only syllable types which, taken individually, are possible in Tashlhiyt, the only

syllabification allowed by Tashlhiyt is the one that takes as a syllable peak the more sonorous of the two segments.

A key element of the Dell & Elmedlaoui's algorithm, then, is its reference to sonority in the determination of syllable nuclei. The algorithm scans the string to be syllabified and builds a CV syllable when a sonority peak is encountered. We, thus, expect to encounter difficulties when the algorithm has to syllabify a string

containing no single sonority peak¹ or exhibiting a progressive drop in sonority, for the following reason: the first, most sonorous segment in the string is not eligible as a syllable nucleus, since this would form an onsetless syllable in violation of the onset constraint.

The examples in (16) are then syllabified as follows (capital letters in these examples refer to syllable nuclei):

(16)

	[t-FtK-t]	[t-Fkt-S-t]
a) low vowel	t-ftk-t	t-fkt-s-t
b) high vowel	t-ftk-t	t-fkt-s-t
c) liquid	t-ftk-t	t-fkt-s-t
d) nasal	t-ftk-t	t-fkt-s-t
e) fricative	(tF)tk-t	(tFk)(tSt)
f) stop	(tF)(tKt)	(tFk)(tSt)

In (16a-f) the sequence is scanned from left to right first for vowels which are the segments with the highest sonority index, then for liquids, which are next in the sonority scale, followed by nasals. In the absence of these, the fricatives /f/ and /s/ are assigned the nucleus position as they are the most sonorous in the sequences and finally the stop /k/ is the last to be assigned the nucleus position.

¹ A sonority peak is defined as follows: “un maximum local de sonorité est une suite qui remplit les deux conditions suivantes: (i) aucun de ses termes n’est adjacent a un segment plus sonore que lui et (ii) elle n’est pas contenue dans une suite plus longue qui remplit la condition (i.). (D & E 1997:28)

The syllabification of /tftkt/, where /k/ and /t/ have an equal sonority index, as (tF)(tkT) is excluded by left-to-right application of the CS which, by scanning inputs it takes the longest expansion of the expression (Y)Z first. In the input /tkt/ The sequence that matches (Y)Z is /tk/. CS, therefore, creates the core syllable (tk) and the leftover [t] is subsequently attached by the Coda Rule.

Under Dell & Elmedlaoui's analysis, syllabification in Tashlhiyt proceeds according to the stages as shown in the syllabification of underlying [t-IzrUal-In] in (17) where *I* and *U* represent the high vocoids which will surface as either vowels or the corresponding glides depending on whether the segment in question appears in a nucleus or a margin (capitalisation here indicates underspecification).

The example in (17) is syllabified by using various rules of core syllabification derived from the Core syllabification constraint introduced in (15). The principle of core syllabification starts with a low vowel, where present, grouped together with an onset. This yields t-Izr(wa)l-In as shown in (17a). The next step is to syllabify the next most sonorous segment, here two instances of the high vowel *I*, shown in (17b). The next most sonorous segments are then syllabified as shown in (17c) and (17d):

(17)

a - CS(*a*): associate a core syllable with any sequence (Y)Z, where Z is an *a*
(low vowel) /t-lzr(wa)l-ln/

b - CS(HV): associate a core syllable with any sequence (Y)Z, where Z is a
high vowel /((t-i)zr(wa)(l-i)n/

c - CS(L): associate a core syllable with any sequence (Y)Z, where Z is a
liquid /((t-i)(zr)(wa)(l-i)n/

d - CS(N): associate a core syllable with any sequence (Y)Z, where Z is a
nasal consonant /((t-i)(zr)(wa)(l-i)(n)/

(adapted from Dell & Elmedlaoui 1988: 4)

According to this algorithm, then, the form /tiUntas/ will have the following
core syllabification (* marks a syllable nucleus):

(18)

t i U n t a s
x x x x x x x
* *
\\ | \\ |
σ σ

How is the medial sequence /Un/ to be syllabified? The constraint HNUC (Prince
and Smolensky 1993), which states that "a higher sonority nucleus is more harmonic

than one of lower sonority," identifies /U/ as a better nucleus than /n/, and thus predicts /tiUntas/ to surface as *[t_i.u_n.t_{as}]. However, this result is incorrect, as the surface form is [t_i.w_n.t_{as}] as predicted by Dell & Elmedlaoui's CS algorithm. Another problem example is /su.ʒd.di/ (Dell & Elmedlaoui 1988:6) which surfaces as [s_u.ʒ_d.d_ig] and not [su.ʒd.dig] as determined by the scansion of the line in which the string appears:

(19)

H	L	L	L	L	H	L	L	H
luh	su	ʒd	di	ga	tal	wr	(t)tn	mar(s)

This line represents a line from Berber poetry, in which a line is characterized, among other things, by a certain sequencing of light and heavy syllables. The pattern for this piece is HLLLLHLLH. The line above is broken into chunks corresponding to a metrical syllable.

In both syllabifications, [s_u.ʒ_d.d_ig] and *[su.ʒd.dig], all syllables have the same edges. The syllable nucleus must be determined by the sonority constraint. In this case however, although [ʒ] is the more sonorous, which would make it a better syllable nucleus than [d], the prediction is wrong because the requirement to have an onset overrides the sonority requirements on nuclei and syllable edges. The same applied to [t_i.w_n.t_{as}] which is better than *[t_iw.n.t_{as}]. In both these examples, the

medial syllable has an onset in the correct syllabification while it lacks one in the incorrect syllabification.

Let us consider more examples:

(20)

	One syllable		two syllables	
1.	a. /krm/	k <u>r</u> m	b. /g ^w mr/	g ^w . <u>m</u> <u>r</u>
2.	a. /smd/	s <u>m</u> <u>d</u>	b. /zdm/	<u>z</u> . <u>d</u> <u>m</u>
3.	a. /krz/	k <u>r</u> z	b. /rks/	<u>r</u> . <u>k</u> <u>s</u>
4.	a. /xng/	x <u>n</u> <u>g</u>	b. /ngd/	<u>n</u> . <u>g</u> <u>d</u>

The forms on the left are each comprised of one heavy syllable, i.e. a syllable with a coda; those on the right are sequences of two light syllables, the first lacking an onset. All the segments in (20) which have the highest sonority index are syllabified as nuclei which is in keeping with their sonority. The segments with the highest sonority index are indicated in bold type in the underlying representations in (20). *R* is, for instance, the highest in sonority in *krm* (20-1a) because the adjacent segments *k* and *m* are lower on the sonority scale; *r* also has the highest sonority index in *g^wmr* (20-1b) and the preceding segment *m* is less sonorous. We note, however, that not all syllable nuclei have the highest sonority index in a string e.g. *g^w* (20-1b) is a nucleus although it does not have the highest sonority index in the string, and the same is true of *d* in *n.gd* (20-4b). This is accounted for by postulating that

syllabification cannot rely solely on sonority, the latter goes hand in hand with the claim that any consonant can be a syllable nucleus in the absence of a vowel.

This analysis is rejected by Coleman (2001) who stipulates that where no vowel occurs, it can be regarded as hidden by the following consonants according to a gestural overlap model. Coleman agrees with Dell and Elmedlaoui's analysis that Tashlhiyt has syllables which do not contain any discernible vocoid, but he disputes their interpretation of the facts. While they hold that the nucleus of such syllables is a consonant, his view is that where no epenthesis is evident, it can be realised as hidden by the following consonant. In the framework of the co-production model, Coleman interprets the syllabic consonants as the co-produced realisation of phonological vowel and consonant. We will first look at how his analysis applies to English before looking at data from Tashlhiyt.

2.3.2 Coleman's Syllabification Algorithm

Coleman (1996) gives as evidence for the presence of syllabic consonants in English the complementary relationship between vowel reduction and syllabicity of the consonant. This means that if the vowel is unreduced, the consonant will not be syllabic, whereas when the consonant is syllabic, the vowel is always reduced.

(21)

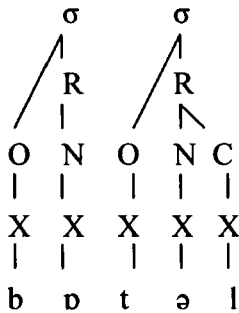

(Coleman 1996:179)

He puts forward two proposals to for the reduction of /ə/ and the development of the syllabicity of /l/: a) a phonological account involving reorganisation of the syllable structure and b) a phonetic account in which (21) is not altered.

The phonological evidence is given using the notation and rules of nonlinear phonology. The deletion is determined by a simple rule which removes the /ə/ from the nucleus position accompanied by spreading of the /l/ into the empty nucleus position which results. Coleman proposes that the spreading occurring here need not be determined by a rule, but might be regarded as a consequence of a repair strategy which intervenes to make sure the obligatory nucleus of the second syllable is filled with the nearest sonorant segment available to it. This spreading is similar to several accounts of compensatory lengthening in the nonlinear phonology literature.

The phonetic interpretation, on the other hand, is based on the temporal arrangement of the segments in a word. The extent of duration of the vowel is longer than that of the inter-consonant duration: owing to the overlap of consonants on vowels, the duration of the vowel is commensurate with the whole syllable (Coleman 1996:181). When a syllable is spoken faster, it is the vowel which is compressed. The consonants may be compressed as well but because their duration is typically much less than that of vowels, the main consequence of syllable compression is that the interval between the onset consonant(s) and coda consonants(s) is shortened. As a result, less of the vowel will be audible. The duration between the consonants is reduced until a point is reached at which the coda consonant begins as soon as the onset consonant is released. In English, this results in unstressed syllabic sonorants as in *bottle*, *cousin* and *rhythm* as well as fast-speech syllabic obstruents as in e.g. *Bob'd buy it*.

Coleman uses the analysis outlined above as an alternative to account for some of the consonant-only words in Tashlhiyt, such as [tXzNt] which have the two capitalised consonants as syllable nuclei. These words are analysed as having vocalic nuclei in their phonological representations so [tXzNt] would be /təxzənt/ and similarly the pronunciation of [txZNt] could be phonologically represented as /txəzənt/.

Now consider the first syllable of *t-sti* 'she selected', which is pronounced [ts]. Dell and Elmedlaoui analyse this syllable as containing only two segments /t/ and /s/,

while Coleman's analysis states that it actually is *təʊs* in which the vowel is subject to the process of reduction. .

According to Coleman, all the occurrences of /ə/ are epenthetic, they are introduced by syllabification. /ə/ is an empty nucleus and it is a phonetic implementation that specifies its vowel quality, which depends on the surrounding segments, and its duration. This duration may be too short for the vocoid to be discerned as a distinct segmentation of time in the phonetic record. In [tsti], for instance, the syllabicity of [s] is simply due to the fact that the realization of the nucleus /ə/ is completely obscured by that of the following /s/.

Coleman (2001) and Dell and Elmedlaoui's (1985; 1988) analyses agree on the representations which are inputs to syllabification. In Dell and Emedlaoui's analysis, however, the distribution of /ə/ is accounted for entirely by phonetic implementation while in Coleman's account this is done jointly by the phonological component, which inserts /ə/, and by phonetic implementation, which eclipses it in certain instances.

Consider the analysis of the following example *t-sbɪ-t* 'you painted':

(22)

Underlying representation /t-sbɣ-t/

Pronunciation

Coleman

Dell and Elmedlaoui

/tsəbɣt/

/təsb.ɣət/

/t͡s.bɣt/

In /təsb.ɣət/, which is the phonetic representation under Coleman's analysis, the two occurrences of /ə/ are not reflected in the pronunciation but are in fact eclipsed by the surrounding consonants in both syllables in (22).

A short vocoid is pronounced between [s] and [b], but these segments are not separated by /ə/ in the phonetic representation. Dell and Elmedlaoui's analysis suggests that the short vocoid which is heard between [s] and [b] in the pronunciation of t-sbɣ-t is not the realisation of a distinct segment in the phonetic representation but rather a transition between [s] and [b].

We will now turn to the implications of Coleman's analysis for the syllable and syllabification of Tashlhiyt.

Coleman develops a grammar of Tashlhiyt Syllable structure which is almost entirely composed of constraints on syllable structure that are provided by Universal Grammar and claims that every Tashlhiyt syllable contains a phonological vowel as

its nucleus with consonants restricted to marginal positions. This grammar is referred to as Functional Logic Grammar, and is context-free yet the language defined by its rules is regular, as there is only one-sided application. Words are treated as syllable sequences defined by the following context free rules which define the unit sequence and any length sequence of syllables with right-branching structure of the form:

(23)

Sylls → Syll
 Sylls → Syll Syll

The internal structure of each syllable may be defined by the phrase structure rules in

(24)

Syll → Onset Rime
 Rime → Nucleus Coda
 Onset → X
 Nucleus → X
 Coda → X

(Coleman, 1996:195)

The grammar represented by Coleman defines the syllables of Tashlhiyt as having the form (C)V(C(C)), where V stands for *a*, *i*, *u* or the epenthetic vowel /ə/. Unlike Dell and Elmedlaoui's analysis, that account allows VCC rimes in which CC is not a geminate, e.g. /t-a-frux-t/ 'girl' is parsed by Coleman as two syllables [taf.ruxt], with

a final rime [uxt], but Dell and Elmedlaoui parse this example as three syllables: [taf.ru.xt]. In CC codas the second C may not be more sonorous than the first, but otherwise the sonority of consonants does not play any role in syllabification in Coleman's analysis.

The grammar allows sequentially empty nuclei with (C)V as the minimum syllable template. This template generates arbitrarily long consonant sequences where V may be empty or its phonetic interpretation eclipsed by a neighbouring consonant. The syllabifications which result may not be attested as the number of syllables predicted by the theory does not correspond to the native-speaker judgements. For instance, the (C)V parse of /txzntnt/ in (25) has seven syllables, though native speakers judge it to have three syllables.

(25)

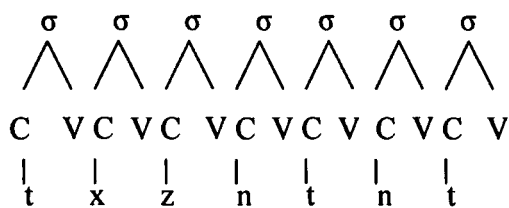

(Coleman 1996:199)

If the maximal syllable template is (C)V, there must be at least one syllable for each consonant in a word. In consonant-only words in Tashlhiyt, there are fewer syllables than consonants, which means there we may find consonant clusters in onset or coda.

In general, however, the bigger the template, the greater the number of possible analyses there will be for any given string. For example, the (C)V syllable grammar has a single parse for any four-consonant string, whereas a (C)V(C) syllable grammar allows for up to five parses for a four string:

(26)

CV.CV.CV.CV

CVC.CV.CV

CV.CVC.CV

CV.CV.CVC

CVC.CVC

(Coleman 1996:199)

The two grammars above are not adequate for syllabifying /txzntnt/. Coleman proposes allowing either the onset or coda node to branch but not both. He opts for a branching coda for two reasons: a) there are too many clear cases of CVCC monosyllabic words while instances of CCV words may be analysed as CəVC (e.g. /bdu/ 'start'). b) Dell & Elmedlaoui (1988) present data on syllable weight showing that e.g. [lNt] is heavy, whereas [dN] is light. This distinction is easily stated as a contrast between branching and non-branching codas: /lənt/ vs /dən/.

We will now move to the Optimality Theory account of Tashlhiyt in Prince and Smolensky (1993).

2.3.3 Optimality Theory Account of Tashlhiyt

Launched by Prince & Smolensky (1993) and departing in significant ways from the serialism lying in the heart of SPE phonology (Chomsky & Halle, 1968), Optimality theory (OT) (Prince & Smolensky, 1993; McCarthy & Prince, 1993b) embodies a new conception of Input-Output relation. Instead of assuming that the relation of the input to the phonological component and its output is governed by the application of a set of serially ordered rule, as in SPE phonology, OT claims that the relation is rather governed by the interaction of potentially violable universal constraints on output well-formedness. Prince and Smolensky consider Tashlhiyt Berber syllabification as a prime example of a case where treating grammar as optimisation due to ranked constraints rather than rule application as in the original analysis by Dell & Elmedlaoui can lead to a deeper explanation of the facts. In the next section we will highlight the main principles of OT before looking closely at Prince and Smolensky's analysis of Tashlhiyt data.

2.3.3.1 OT Structure, Principles and Constraints

In OT, the grammar had the following organisation:

(27)

Input → Gen → {Cand 1, Cand 2, ...} → Eval → Output

There are crucial principles that underlie OT, summed up under five headings in McCarthy & Prince (1994: 336):

(28)

1. *Universality*: Universal Grammar provides a set of Con constraints that are universal and universally present in all grammars
2. *Violability*: Constraints are violable; but violation is minimal
3. *Ranking*: The constraints of Con are ranked on language-particular basis; the notion of minimal violation is defined in terms of this ranking. A grammar is a ranking of the constraint set.
4. *Inclusiveness*: The constraint hierarchy evaluates a set of candidate analyses that are admitted by very general considerations of structural well-formedness.
5. *Parallelism*: Best satisfaction of the constraint hierarchy is computed over the whole hierarchy and the whole candidate set. There is no serial derivation.

Gen, the generator of OT grammar, is claimed to be part of Universal Grammar and to be the same in every language (Prince & Smolensky, 1993; McCarthy & Prince 1993b, McCarthy, 2000). For a given input this component generates an infinite set of candidate analyses. Having access to the basics of phonological representation and having “freedom of analysis” (McCarthy & Prince, 1993b), *Gen* may posit for an input any amount of structure.

Eval, the evaluator component of OT grammar, assess the well-formedness of the set of candidates against a hierarchy of constraints *Con*, which often have conflicting demands. The candidate which best satisfies *Con* (or equivalently that has the minimal violations of the constraints) is the optimal candidate. The well-formedness of the output candidate is assessed taking into consideration the input.

The three important components of OT grammar are the Lexicon, which gives the input structure, the Generator function, whose role is to associate candidate analyses with the input, and Evaluator function, which assesses the well-formedness of the candidate set against a constraint hierarchy (Kager, 1999).

The constraints of *Con* are universal and have a general formulation. Different kinds of constraints have been investigated. For example, markedness constraints assess the featural, segmental, and prosodic well-formedness of candidates associated with the input, while faithfulness constraints assess the extent to which the input and output correspond. For example, a constraint such as *LABIAL will assign a violation mark to any output candidate that contains a labial consonant. In a similar way, the markedness constraint *CORONAL will rule out all output candidates containing coronal segments.

The task of the linguist is to find out which constraints belong to the grammar of the language under study and to rank them on the language-particular basis. Different grammars emerge as a result of re-ranking the constraints. Taken individually, the

constraints do not decide on the optimality of a candidate. They simply tell whether the candidate satisfies or violates them. The optimality of a candidate is determined only on the basis of (a) a global assessment of the constraint violations the candidate incurs against a hierarchy of ranked constraints and (b) a comparison with the violations incurred by the other competing candidates. The ranking of the constraints shows which violations are more serious than others. Only the candidate that incurs the least serious violations with respect to the hierarchy of constraints is considered optimal.

Constraints in OT can be ranked with respect to one another in two different ways. First, if constraint A dominates constraint B, then we have a case of direct ranking. Suppose we have two constraints A and B whose ranking has not been established yet. We need two candidates Cand1 and Cand2 that will show the violation of which constraint is more serious. If Cand1 satisfies constraint A and violates constraint B and is still the well-formed candidate, that constitutes an argument for ranking constraint A over constraint B, so long as Cand2 violates constraint A and satisfies constraint B.

Second, if constraint A dominates constraint B, and constraint B dominates constraint C, then A dominates C. This is a case of indirect ranking which is a constraint interaction which lies at the heart of OT.

To visualise the different interactions between the different constraints on output well-formedness as well as the optimality of a given candidate is determined, OT uses the constraint tableau method, an example of which is given in (29):

(29)

Input: X	A	B
☞ Can1		*
Can2	*!	

The input X is given at the top of the left-hand column and the candidate set generated by Gen appears underneath the input. The constraint hierarchy is represented in the top row, where the constraint on the left is higher in the hierarchy than one(s) to its right. A solid line (|) separating the constraints indicates hierarchical order (in the text symbol “ » ” expresses the domination relation, hence A » B means ‘constraint A dominates constraint B’). The star “*” indicates violation of a constraint and the exclamation mark in front of the star “*!” fatal violation. A blank cell shows that the candidate has not incurred any violation(s) of the constraint in question. The optimal candidate is pointed at by the pointing hand “☞”. Tableau (29) is an example of a ranking argument which shows that violating a higher-ranked constraint is far more serious than violating a lower-ranked one.

If no hierarchical dominance relation can be established between two constraints, these are separated in the tableau by a dotted line (|) (in the text we simply separated two constraints in question by a coma, B, C):

(30)

Input: X	A	B	C
☞ Can1		*	
Can2	*!		
Can3	*!		*

2.3.3.2 Prince and Smolensky's OT Analysis

Dell & Elmedlaoui show that their CS, a conceptually simple framework correctly describes a wide range of complex phonological data. As their description relies crucially on rule ordering, it offers a challenge to non-derivational models of phonology. Prince and Smolensky address this challenge directly, assigning Tashlhiyt a central illustrative role in their presentation of OT. Their main goal is to establish that the notion of optimality is, as claimed, indispensable to grammar and they argue this point from the results of Dell & Elmedlaoui's study of Tashlhiyt syllabification.

Prince & Smolensky propose to show that a non-derivational version of OT can provide a superior account of the facts and generalisations noted by Dell &

Elmedlaoui. They point out that any theory, which makes available a rule like CS suffers from formal arbitrariness. Even if this rule is empirically well supported, any formal system which can allow its expression will also allow the expression of countless rules with undesirable properties. In contrast, OT incorporates general principles of harmony directly into grammatical theory in the form of universal, violable constraints whose language-specific rankings determine the phonological patterns of each language.

Prince & Smolensky develop their syllabification of Tashlhiyt by a method of successive approximation. Their analysis introduces the two constraints: ONSET and HNUC (Prince & Smolensky, 1993:11-21). ONSET is stated as follows:

(31) The Onset Constraint (ONS): Syllables must have onsets (except phrase-initially)

Like Dell & Elmedlaoui's Onset Principle (14), which it generalises, it allows exceptions in initial syllables. The Nuclear Harmony Constraint (HNUC) states that higher-sonority nuclei are preferred to lower-sonority nuclei, and thus captures Dell & Elmedlaoui's Peak Preference generalisation (15). HNUC generates a list of all the nuclei (=peaks) in each candidate syllabification, presented from most to least sonorous; evaluation proceeds by comparing the sonority of the sets of syllable peaks displayed in the HNUC column and eliminating candidates with less sonorous peaks than those of another candidate.

The following tableau represents a number of the more plausible syllabifications of the form [txznt] ‘you sg. stored’ (Dell & Elmedlaoui 1985: 106):

(32)

/t-xzn-t	ONSET	HNUC
☞ a. tX.zNt		n x
b. Tx.zNt		n t!
c. T.xZ.nT		z! t t
d. txZ.nT		z! t
e. txZ.Nt	*!	n z
f. tXz.Nt	*!	n x

Here candidate (a) represents the correct syllabification, even though (e) better satisfies HNUC. This demonstrates that ONSET must be ranked above HNUC in the constraint hierarchy. Of the candidates that satisfy ONSET, candidate (a) has the most harmonic set of syllabification peaks, and is therefore selected as the output form.

Prince & Smolensky further introduce a revised analysis, which differs from this preliminary one as it replaces the graded constraint HNUC with a complex of binary constraints governing the affinity of segments to particular syllable positions according to their sonority rank. One of these constraints governs the nucleus position (*P/α), the other the syllable margins (*M/β).

(33) Peak Hierarchy: *P/t >> *P/d >> *P/s >> *P/z >> *P/n >> *P/r >> *P/i >> *P/a

(Prince and Smolensky 1993:132)

Each *P/α is interpreted as the statement ‘α must not be parsed as a syllable peak.’

For instance, any syllabic voiceless stop violates *P/t, any syllabic voiced stop violates *P/d etc.

The Margin Hierarchy also has the same properties as the Peak Hierarchy but the segments in the former are ranked in the opposite order as the latter.

(34) Margin Hierarchy: *M/a >> *M/i >> *M/r >> *M/n >> *M/z >> *M/s >> *M/d >> *M/t

(Prince & Smolensky 1993:163)

The fundamental claim in this revised analysis is that all members of the Peak Hierarchy are ranked below members of the Margin Hierarchy. Prince & Smolensky offer two examples in support of their claim:

(35)

/tkt/ (invented)	*M/t	*P/t
a. T.k.T	K	t t
b. tKt	t t!	K

The tableau shows that the candidate (b) incurs two violations and candidate (a) only incurs one. However, the form generated by Dell & Elmedlaoui's CS is not (a) but (b).

Prince & Smolensky's final analysis of Tashlhiyt no longer expresses Dell & Elmedlaoui's Peak Generalisation (15), according to which syllabification proceeds by comparison of syllable peaks, but expresses the view that syllabification involves comparison of syllable margins. In this respect, Prince & Smolensky's insight into the basic mechanism underlying Tashlhiyt syllabification is fundamentally different from Dell & Elmedlaoui's.

2.4 Conclusion

We have shown in this chapter that Dell & Elmedlaoui's CS successfully accounts for the syllabification of the problematic date in Tashlhiy. The analysis gives a central role to the sonority relationships between adjacent segments. As far as sonority is concerned, the empirical generalisations which are accounted for are: syllable nuclei must have the highest degree of sonority compatible with other requirements such as the prohibition of hiatus. Starting from representations devoid of any syllabic structure, syllabification is built in a stepwise fashion through the operation of sequentially-ordered rules. The rules failed to apply when their operation would have created adjacent nuclei (a hiatus).

Coleman's Syllabification Algorithm suggests that Tashlhiyt syllables that do not contain any discernible vocoid have in fact a nucleus which is a vowel and that this vowel is phonetically overlapped by adjacent consonants. He accounts for this by having a schwa epenthesis rule. His analysis, however, results in unattested syllables.

Prince & Smolensky view Tashlhiyt as a case where treating grammar as optimisation rather than rule (or constraint) application can lead to a deeper explanation of the facts. But they have not successfully developed convincing non-derivational analysis of materials that previously seemed to require an ordered-rule. While Prince & Smolensky suggest the direction that a full analysis of Tashlhiyt might take, they do not discuss much of the evidence that presents a potentially severe challenge to the theory. This evidence includes the regular surface exceptions to the CS rules found at the edges of the syllabification domain, treated by Dell & Elmedlaoui in terms of 'annexation rules' and the interaction between Tashlhiyt syllabification and word formation (in later chapters).

Chapter 3

Passive Verb

Chapter 3

3.1 Introduction

In this chapter, we will show how the constraints on segment organisation in the syllable are reflected in the prosodic structure of passive verbs and argue for an alternative template for the passive verb. We argue that the canonical template involves too many complications and needs to be reformulated as a syllable template.

3.2 The structure of passive verb

An essential characteristic of passive verbs in Tashlhiyt is that they all seem to follow a definite pattern which regulates the distribution of vowels and consonants in passive constructions. Consider the template (1) presented in chapter 2 (section 2.2) which generates all the observed patterns of segment organization in Tashlhiyt, and onto which the observed instances could be represented as:

(1)

CCVC /+seg/ (/+seg/) (/+seg/) (C)

The template as it stands also allows unattested forms to be derived. We will address this issue later in this section. The patterns represented by this template are given below:

(2)

1. CCVCVCVC
2. CCVCVCV
3. CCVCCVC
4. CCVCVC
5. CCVCV

These patterns correspond to the following representative types of the passive verbs:

- (3)
- | | | | |
|----|------------|---------|----------|
| a. | ttu-ha-sab | /hasb/ | ‘count’ |
| | ttu.zr.raf | /zrrf/ | ‘cheat’ |
| | ttu.kr.fas | /krfs/ | ‘damage’ |
| b. | ttu.dr-ra | /drr+u/ | ‘harm’ |
| | ttu-sm.ma | /smm+u/ | ‘name’ |
| | ttu.rb.ba | /rbb+u/ | ‘raise’ |
| c. | ttu.kraz | /krz/ | ‘plow’ |
| | ttu.ssan | /ssn/ | ‘know’ |
| | ttu.staj | /stI/ | ‘filter’ |
| d. | tta-maz | /amz/ | ‘hold’ |
| | tta-gal | /agwl/ | ‘hang’ |
| | tta.kar | /akwr/ | ‘steal’ |
| e. | ttb.ga | /bg+u/ | ‘pierce’ |
| | ttz.da | /zd/ | ‘grind’ |
| | tff.ka | /fk/ | ‘give’ |

We can note from the data above that the items exhibit two main processes:

(4)

1. *The prefix /ttu-/ is realised as /tt-/ when attached to vowel-initial bases and bi-consonantal bases*
2. *The vowel /a/ is suffixed to bi-consonantal roots and infixes in the penultimate position in tri-segmental roots.*

This rule states that the segment /u/, is deleted in two specific environments:

- a) When the affix is attached to a root containing a vowel in initial position as in /amz/ which becomes /ttamaz/ instead of */tuamaz/.
- b) When it is attached to a bi-consonantal root whereby the root vowel is marked as optional; this is the case in /fk(a)/ which is /tffka/ instead of */ttufka/.

The root segments in tri-segmental roots can be vowels or consonants as is shown in the following examples:

(5)

/amz/	/tt-am(a)z/
/krz/	/ttu-kr(a)z

In bi-consonantal roots, on the other hand, it can consist of either two simple consonants as in /fk/ which becomes /tffka/ or they may consist of a simple consonant and a geminate consonant as in /drr-u/ which becomes /tuddra/.

The template as it stands allows unattested forms to be derived. It is, therefore, necessary to posit the following constraints:

(6)

- a. No passive verb can have a branching coda
- b. No passive verb can have a final syllable which has a branching onset and no coda

These constraints restrict the right edge of the template since it exhibits a lot of variation. The left edge is constant in all forms. These constraints disallow the following expansions:

(7)

- a. CCV.CCVCC
- b. CCVCC
- c. CCV.CCV

In the next section, I will address the syllable structure of the passive verbs.

3.3 The syllabification of the passive verb

In this section we will proceed to the analysis of each one of the five possible expansions in (2) beginning with the longest expansion and ending with the shortest one. For this purpose I will apply the SBC to each one of the expansions. Examples illustrating (2.1) are given below along with their base forms:

(8)

/CCVCVCVC/

	Derived form	<u>Base form</u>
a.	ttuhasab	hasb 'count'
	ttugabal	gabl 'guard'
	ttu?awad	?awd 'repeat'
b.	ttubrzat	brzt 'disturb'
	ttukrfas	krfas 'mistreat'
	ttuyndaf	γndf 'fool'
c.	ttufssar	fssr 'explain'
	ttuyllaf	γllf 'cover'
	ttusljad	sljd 'fish/hunt/

The verbs differ in form. The set in (8a) contains vowels in the base forms. The verbs in (8b) contain four consonants but no vowels and those in (8c) have four consonants with a medial geminate cluster. We will see that by the application of SBC, they will all be included in the same set which explains their similar behaviour with respect to the passive derivation. Let us take the form /ttuhasab/ as a representative of the set (a):

(9)

SBC 1: t t u h a s a b



SBC 2: t t u h a s a b

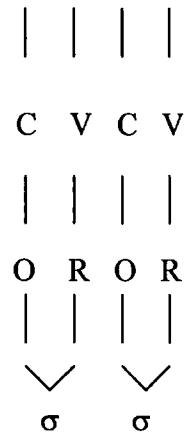

SBC 3: t t u h a s a b

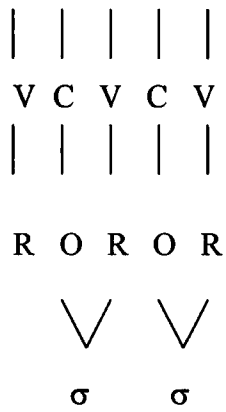

SBC 2: t t u h a s a b

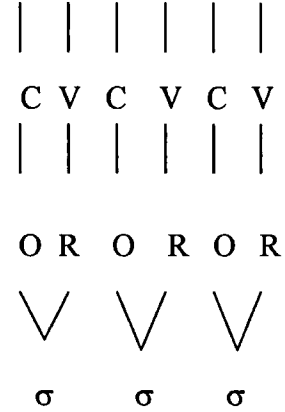

SBC 4: t t u h a s a b

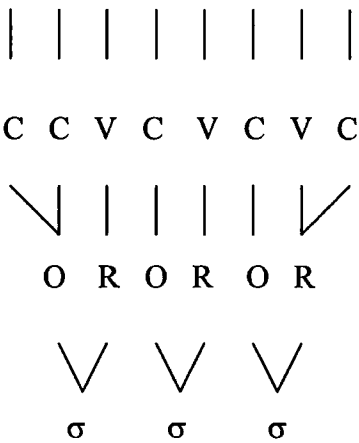

In step 1, CS marks /a/ -the segment with the highest sonority index- as a syllable peak, and since there are two such segments, they are both marked as syllable peaks. Step 2 consists of associating the available onsets to these peaks. CS then reapplies in step 3 because there are more than two segments to the right of the first syllable peak. After scanning that string, it marks /u/ - with the next higher SI – as the syllable peak. Onset association is then associated to the new peak. The final step adjoins the first consonant as a second member of the onset on its right, and links the last consonant as a coda to its neighbouring syllable.

Another example from set (8b) would be syllabified as follows:

(10)

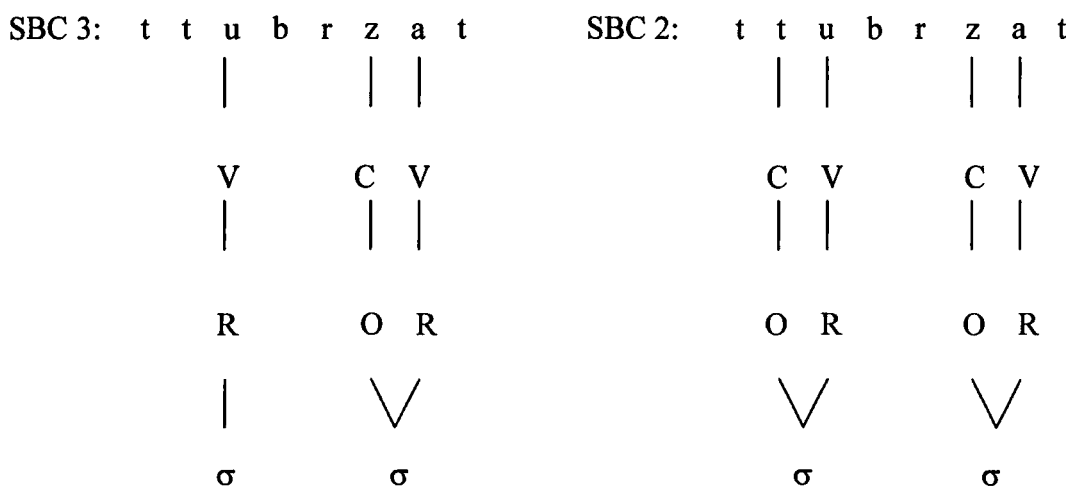
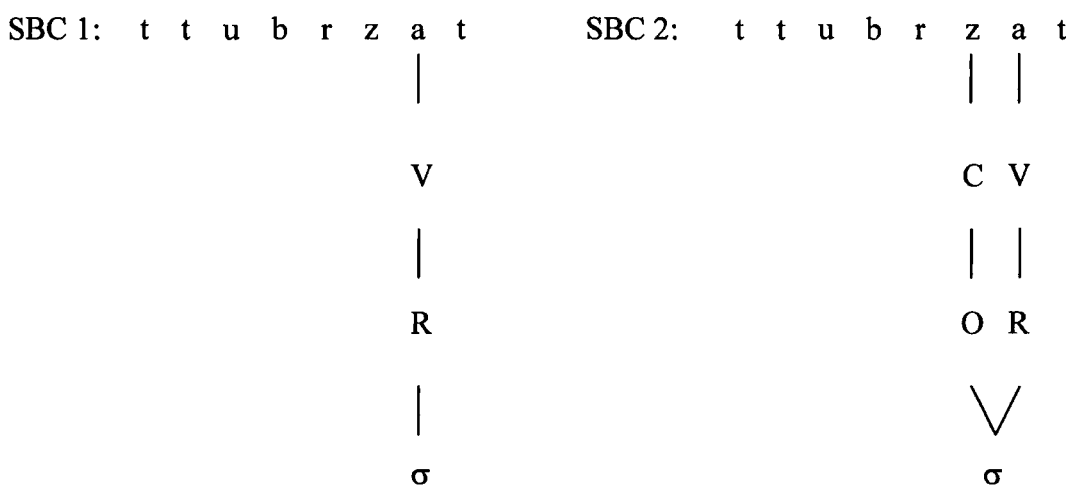

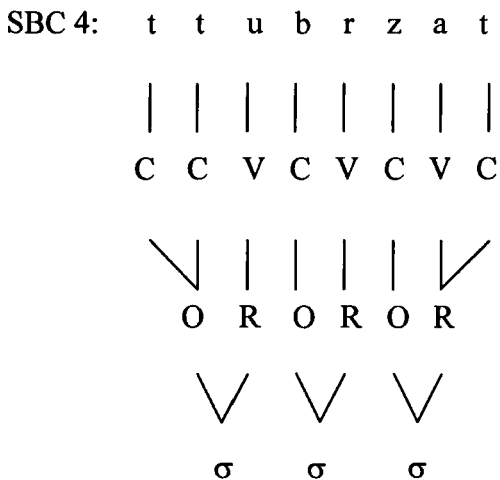
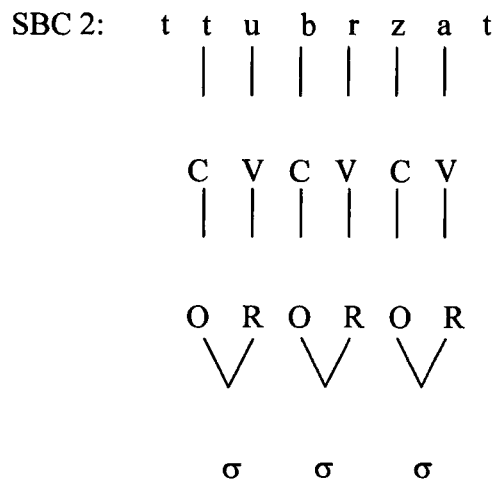
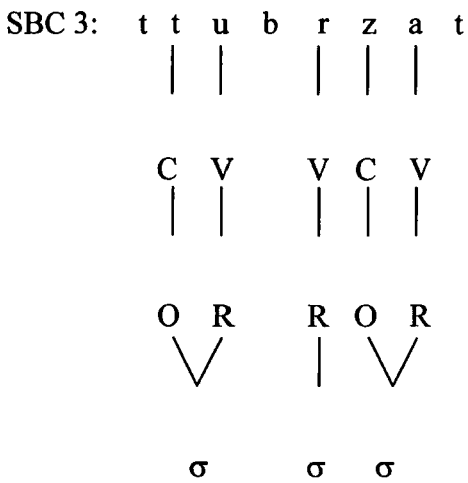

The syllabification in (10) involves one more application of SBC3. This is due to the presence of more than two consonants to the right of the nucleus /a/ -a situation which is ruled out by the canonical syllable template of the dialect. SBC3 thus scans that string and associates /r/ - the segment with the next higher SI to a nuclear position. SBC 2 and SBC 4 finish the procedure and associate the remaining unsyllabified segments either as onsets or codas. The final result is a syllable pattern exactly identical to the one in (9).

An example from (8c) would be syllabified as follows:

(11)

SBC 1: t t u f s s a r
 |
 V
 |
 R
 |
 σ

SBC 2: t t u f s s a r
 | |
 C V
 | |
 O R
 ∨
 σ

SBC 3: t t u f s s a r
 | | |
 V C V
 | | |
 R O R
 | ∨
 σ σ

SBC 2: t t u f s s a r
 | | | |
 C V C V
 | | | |
 O R O R
 ∨ ∨
 σ σ

SBC 3: t t u f s s a r
 | | | | |
 C V V C V
 | | | | |
 O R R O R
 ∨ | ∨
 σ σ σ

SBC 2: t t u f s s a r
 | | | | | |
 C V C V C V
 | | | | | |
 O R O R O R
 ∨ ∨ ∨
 σ σ σ

SBC 4: t t u f s s a r

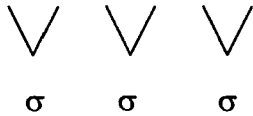

The syllabification procedure in (11) is basically like that in (3) except that the RSP of /t/ in relation to /b/ is greater in /ttubrzat/ than that between /f/ and /s/ in /ttufssar/.

In this example the geminates are heterosyllabic as they are members of different syllables. We will discuss this in more detail in chapter 5.

Another example in set (8c) exhibits a different type of segment organisation. I will argue in chapter 4 that the underlying form of /i-j/ and /u-w/ is respectively I and U i.e. high vocoids. Therefore, the passive verb /ttUsIIad/ had three segments with the same SI; two of which are contiguous.

In spite of this derivation from the other patterns, the SBC 3 will ensure that this form is treated in the same way as the previous ones. As a result, after /a/ has been associated as a nucleus, the preceding high vocoid will be associated as an onset and will, therefore, surface as /j/. The rest of the syllabification procedure is straight forward. The result is actually a CCV.CV.CVC pattern which is identical to the ones developed earlier.

It is worth noting that without the SBC the verbs in (8) would have been considered as belonging to three different classes. This would have led to an increasing number of subsets in the passive canonical pattern, and more importantly it would have led to missing an important generalisation, namely that they all pattern in the same way with respect to the passive form.

The next longer expansion contains 7 segmental slots and involves two types of passive verbs.

(12) CCVCVCV
 CCVCCVC

These two types have the first four segments in common but they differ in the rest of their composition. Examples illustrating the first pattern are given in (13 a-d) and those corresponding to the second expansion are given in (13 e-h):

(13)

	Derived form	Basic form
a.	ttudrra	drru 'harm'
b.	ttusmma	smmu 'name'
c.	ttuʃkka	ʃkku 'doubt'
d.	ttuslla	slla 'listen'
e.	ttuzday	zdy 'live'
f.	ttusrad	srd 'send'
g.	ttuʃmat	ʃmt 'strick'
h.	ttustaj	stI 'choose'

The syllabification of the verbs in (13 a-d) would go along the following lines:

(14)

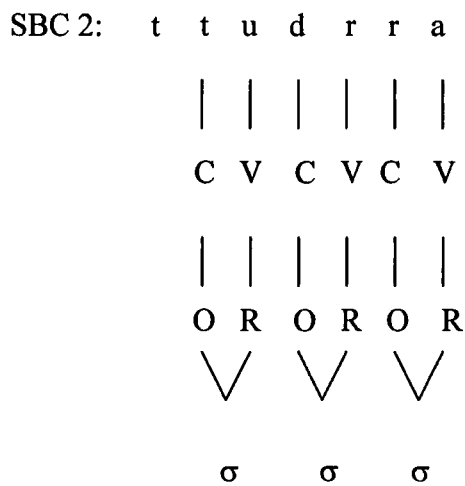
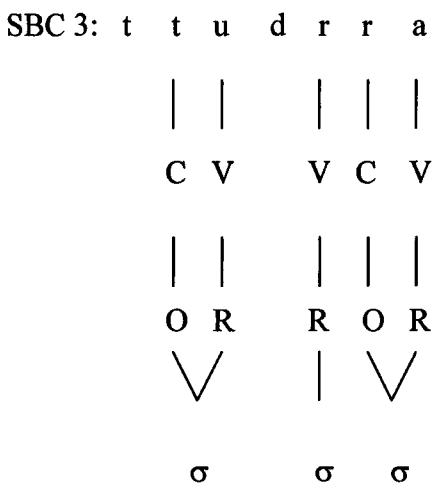
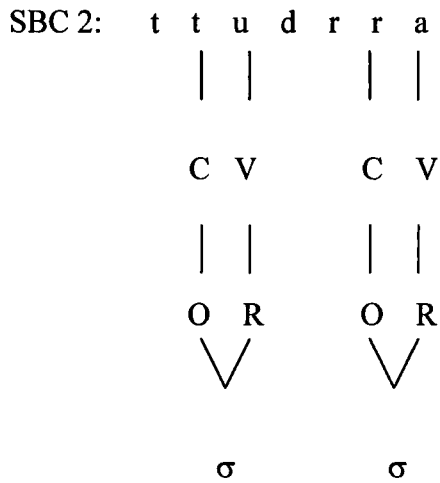
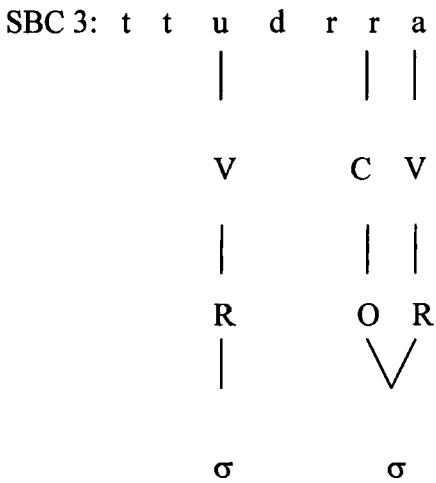
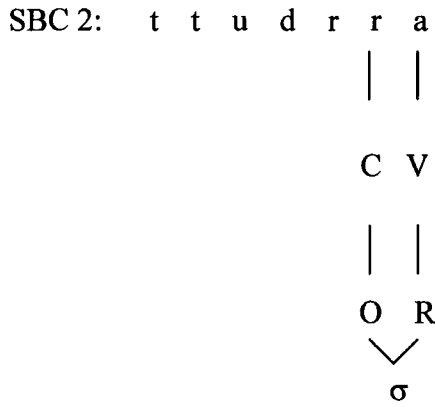
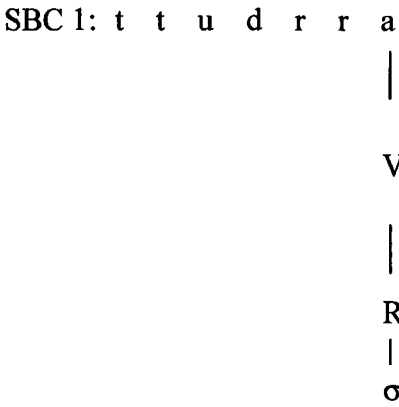

SBC 4: t t u d r r a

| | | | | | |
 C C V C V C V

\ | | | | | |
 O R O R O R

∨ ∨ ∨
 σ σ σ

This procedure can be trivially extended to the other examples in (13a-d), except perhaps for /tuʃkka/, where it is /k/ which makes a syllable peak although /ʃ/ has a greater sonority index. This is due to two reasons. First, no onset can possibly be loaded with three segments; this excludes the possibility of adjoining /ʃ/ and /k/ to the following syllable. Second, /u/ is syllabified well before /ʃ/ by virtue of its sonority index, and thus the prohibition against hiatus¹, a constraint imposed on the operation of CS, comes in to prevent /ʃ/ from acquiring the syllable peak position. This is illustrated below:

¹ 'Only at the beginning of a syllabification domain can CS create onsetless core syllables'. Dell & Elmedlaoui 1988:5). See also chapter 2.

(15)

SBC 1: t t u ∫ k k a

|

V

|

R

|

σ

SBC 2: t t u ∫ k k a

|

|

C

V

|

|

O

R

∨

σ

SBC 3: t t u ∫ k k a

|

|

|

V

C

V

|

|

|

R

O

R

|

∨

σ

σ

SBC 2: t t u ∫ k k a

|

|

|

|

C

V

C

V

|

|

|

|

O

R

O

R

∨

∨

σ

σ

SBC 3: t t u ∫ k k a

|

|

|

|

|

C

V

V

C

V

|

|

|

|

|

O

R

R

O

R

∨

|

∨

σ

σ

σ

SBC 2: t t u ∫ k k a

|

|

|

|

|

|

C

V

C

V

C

V

|

|

|

|

|

|

O

R

O

R

O

R

∨

∨

∨

σ

σ

σ



SBC 4: t t u ʃ k k a

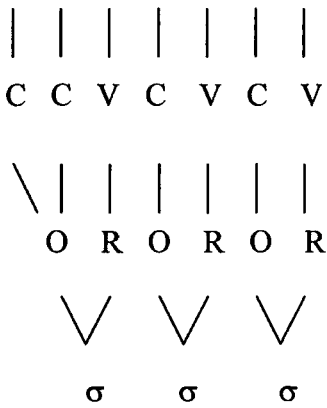

It may be argued, however, that after CS has affected /u/ and after the subsequent onset adjunction, /ʃ/ would be assigned as a coda to the first syllable and the first member of the geminate cluster be adjoined as a second member of the onset to the second syllable. In this case, we would have the following representation:

(16)

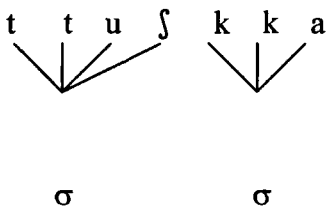

This implies that there are two syllables of the form CCVC.CCV i.e. two syllable patterns which do not violate the canonical syllable template. Nevertheless, this syllable division does not reflect what is phonetically observable, namely the native speaker's realization of the first CCV sequence as an independent syllable. In fact, SBC 3 ensures that this syllable is independently represented. Let us recall what SBC 3 says:

‘If after step 1 i.e. CS, there remain more than two segments to the right or the left of nucleus, then CS reapplies to that string and marks the next higher sonority index as a syllable peak’.

This is actually the case here since after CS and onset adjunction, we have the following unsyllabified sequence /ʃk/, CS reapplies to account for this sequence.

The next subset which also involves verbs with seven segmental slots constitutes the largest part of verbs which allow the passive form. These verbs have three segments in their base form and they invariably have the passive infix /a/ inserted between the second and third segment. Below are some examples:

(17)

	Derived form	Base form	
a.	ttuxdam	xdm	‘work’
	ttuzgar	zgr	‘cross’
	ttuydar	γdr	‘cheat’
	ttuʔdal	ʔdl	‘mend’
	ttuʔrad	ʔrd	‘invite’
	ttuskar	skr	‘make’
b.	ttustaj	stI	‘filter’
	ttubraj	brI	‘injure’
	ttuktaj	ktI	‘remember’
	ttuzdaj	zdI	‘link’
	ttuzlaj	zlI	‘separate’

The verbs in (17a) consist of three consonantal slots while those in (14b) have a vowel in final position. This vowel is invariably the front high vocoid (I). It is also worth noting that this vowel is not in its syllable peak position in the passive form. SBC 4 makes the right prediction since the segment is assigned to the coda of the last syllable. I will now represent an example from (17b) and another one from (17a).

(18)

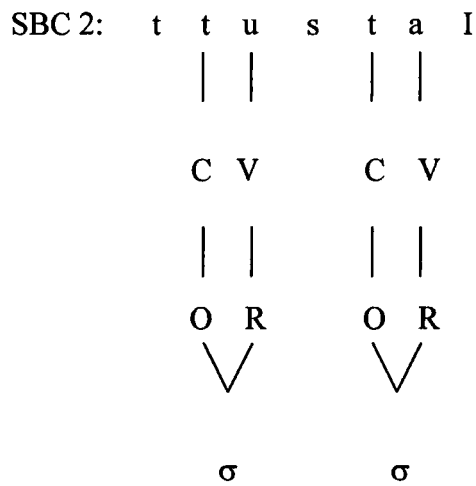
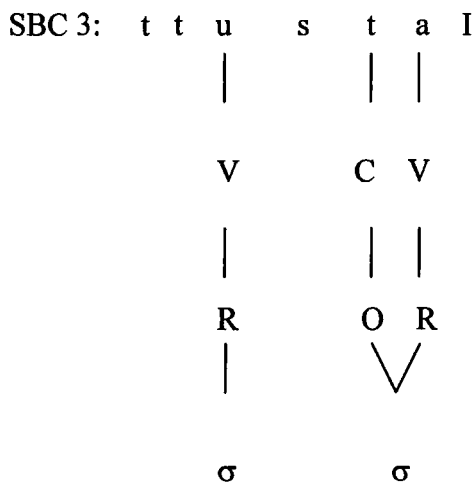
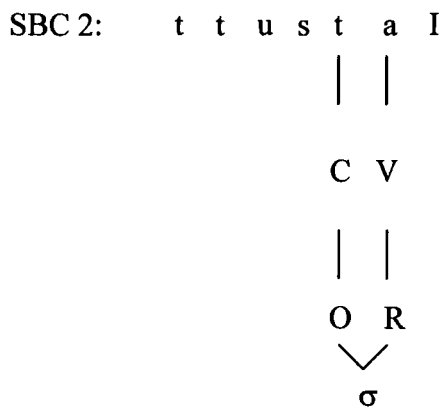
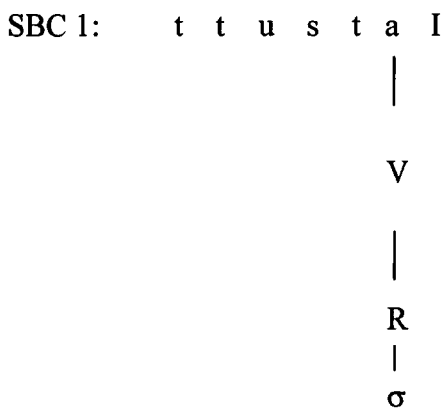

SBC 4: t t u s t a j

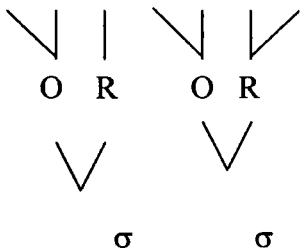

We can note that SBC 3 cannot affect /l/ since it is the only segment to the left of the nucleus. Note also that the high vocoid surfaces as /j/ only after it is attached to the coda.

The syllabification of the passive forms in (17a) is straightforward. Let's consider this example:

(19)

SBC 1: t t u s k a r



SBC 2: t t u s k a r



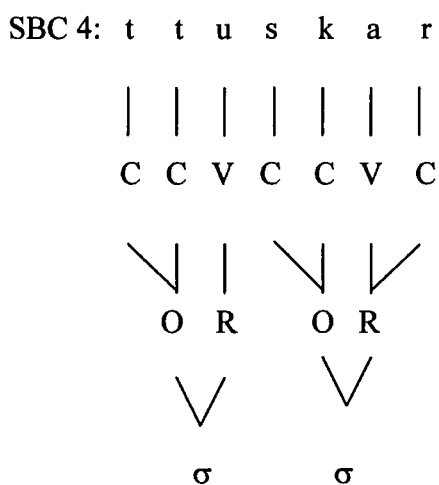
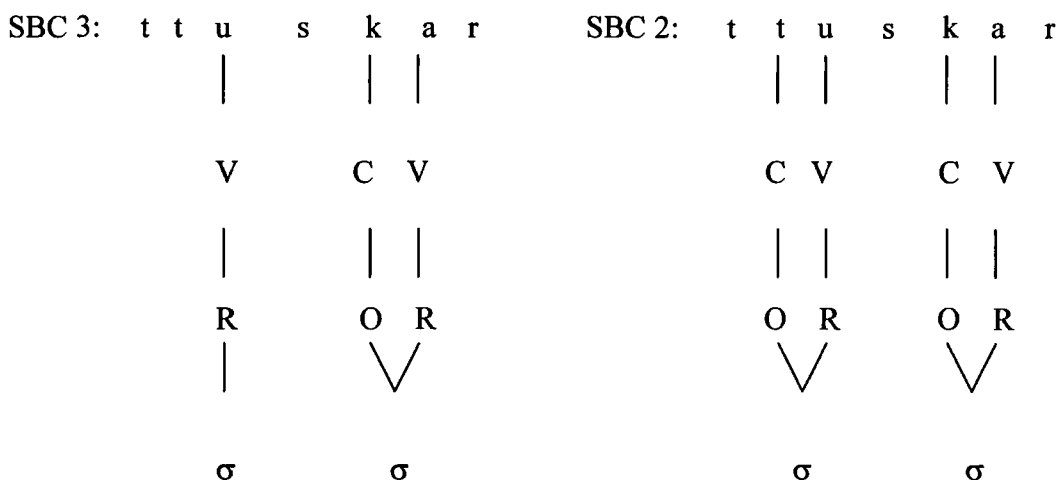

This shows that there is a choice to associate the /s/ either with the rime of the first syllable or the onset of the second syllable, but by virtue of the Onset Priority Principle this segment is associated as a second member of the onset of the following syllable. The other segments pose no problem.

A further type of verbs which fill the seven segmental slots in the canonical template for passives involves verbs with a geminate cluster initially and one final consonant. Some examples are given below:

(20)

Derived form

Basic form

ttussan

ssn

ttukkas

kks

ttuzzag

zzg

ttuggar

ggr

The syllabification of this type of verbs follows the same procedure shown in (19)

above:

(21)

SBC 1: t t u s s a n

|

V

|

R

|
σ

SBC 2: t t u s s a n

| |

C V

| |

O R

∨
σ

SBC 3: t t u s s a n

|

| |

V

C V

|

| |

R

O R

|

∨

σ

σ

SBC 4: t t u s s a n

| | | | | | |

C C V C C V C

∨ | ∨ ∨

O R

O R

∨

∨

σ

σ

We can deduce from the above that the sequential treatment of geminates which has been assumed so far, allows for some generality to be achieved. Although the latter type of verbs contains a geminate cluster, it patterns exactly like those which have a sequence of different consonants. The treatment of geminates as long single segments in this context will not lead to the same result. In fact, it would increase the number of permissible patterns in the template in (1) repeated here in (22). We will look closely at the treatment of geminates in chapter 5.

(22)

CCVC /+seg/ (/+seg/) (/+seg/) (C)

In other words, we would have a new form /CCVCVC/ which we would have to include in the canonical pattern for passive verbs, increasing thereby the complexity of this canonical pattern. This leads us to conclude that the sequential treatment of geminates allows for the right generalisations to be drawn. All the verbs considered so far have a consonant in the initial position, and they all have the prefix in its full form i.e. /CCV/. This is not the case with verbs belonging to the fourth possible expansion of the template in (23). The characteristic feature of these verbs is that they all have a vowel in initial position and this vowel is constantly /a/ - the segment with the highest sonority index. Consider some examples in (23) below:

(23)

/amz/ 'catch'

/ag^wl/ 'hang'

/asI/ 'take'

/ak^wr/ 'steal'

/als/ 'cut off'

What happens when the prefix /CCV-/ is attached to these forms?

There are two possibilities expected in this situation. Either the high vocoid in the prefix will be converted into a glide since it happens to be the neighbouring segment to the one with the highest sonority index, in which case the resulting form would be */ttwamaz/; or one of the vowels will be deleted to avoid the hiatus which is not allowed by the phonotactic constraints of the language. Indeed, this is exactly what happens so that the form which is attested in /ttamaz/. The unattested form is actually ruled out by the canonical syllable template of the dialect. The syllable template postulates that the maximum number of segments in an onset is two; the unattested form has a triconsonantal onset.

These verbs show a regular behaviour: the infix vowel is located between the second and the third segment (i.e. in the penultimate position). The passive form of the verbs in (24) is given below:

(24)

/ttamaz/	/amz/	'catch'
/ttagal/	/ag ^w l/	'hang'
/ttasaj/	/asI/	'take'
/ttakar/	/ak ^w r/	'steal'
/ttalas	/als/	'cut off'

The syllabification of these verbs is quite simple:

(33)

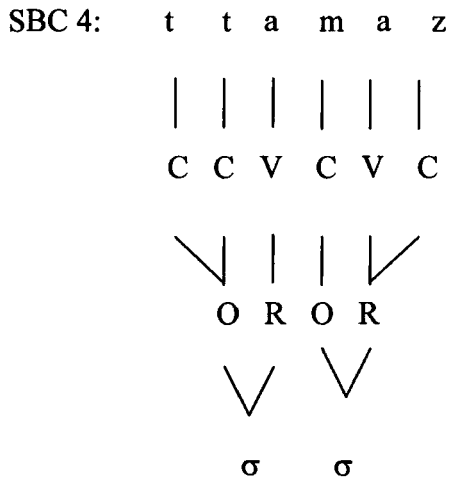
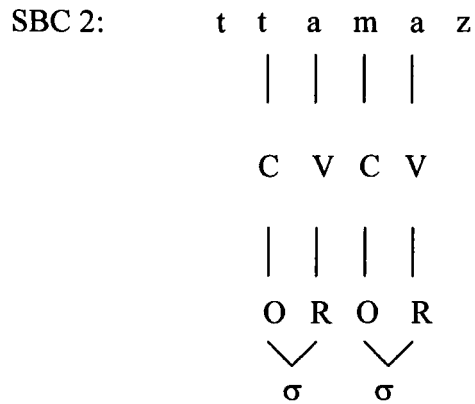
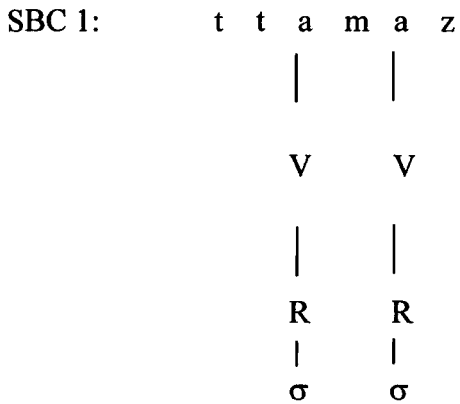

SBC 3 does not need to apply since the number of segments in the nucleus boundaries does not exceed that established by the canonical syllable template.

The last possible expansion of the canonical template in (22) involves the least number of segmental slots i.e. 5 slots. The irregularity attested in the set of verbs corresponding to this expansion is similar to that in the previous set; the prefix loses its vowel but not for the same reason. Notice how these verbs behave in the passive:

(26)

Basic form	Derived form
/ls/ 'wear'	/tlsa/
/gn/ 'sleep'	/tgna/
/yz/ 'dig'	/tyza/
/ml/ 'show'	/tmla/
/fk/ 'give'	/tfka/

The question that one may ask at this stage is why such forms as the ones below are not attested.

(27)

- *ttulsa
- *ttugna
- *ttuyza
- *ttumla
- *ttufka

This is due to the constraint proposed in (6b) and the constraint in (4a) which states that the prefix /ttu-/ is realised as /tt-/ when attached to vowel-initial bases and bi-consonantal bases. Let us recall that the constraint says:

'no passive verb can have a final syllable which has a branching onset and no coda.'

The absence of the prefix vowel becomes a natural consequence of the constraint on possible syllable structure in passive verbs. Notice that the constraint does not mention any particular segment, but it is stated on a higher level of representation of the structure which excludes the representation like the one below:

(28)

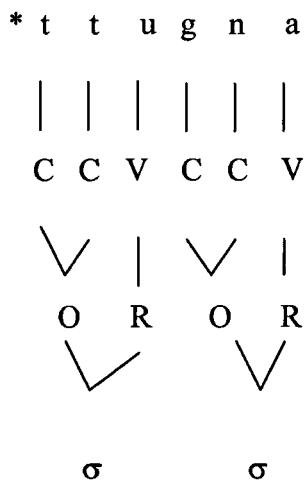

Instead the pattern which this set of verbs obeys is a CCV.CV pattern. Let us now see whether the SBC make the right prediction:

(29)

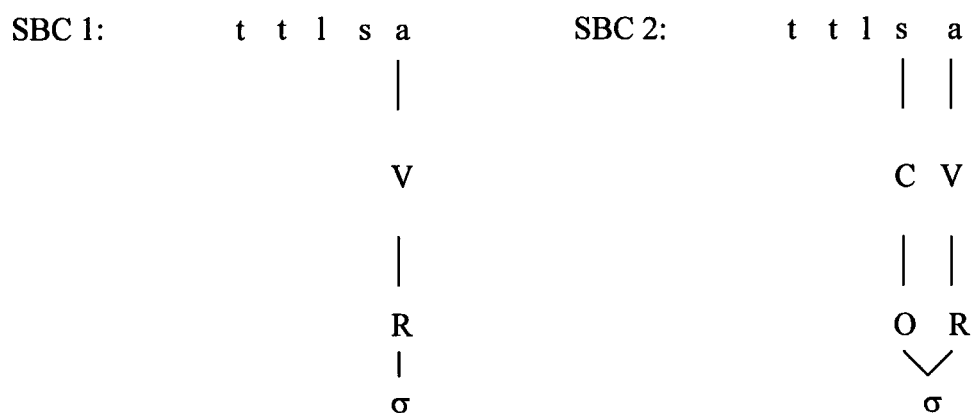

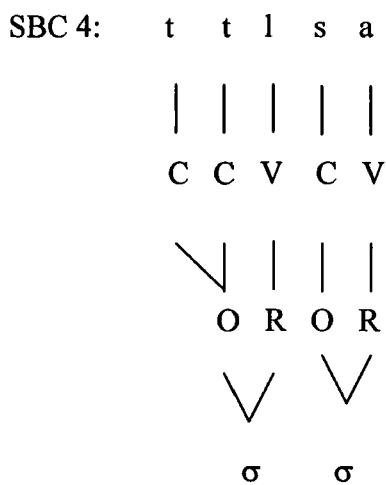
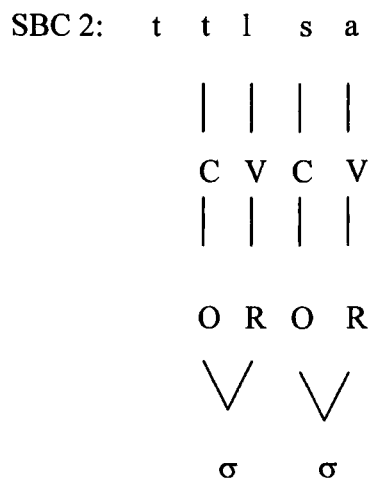
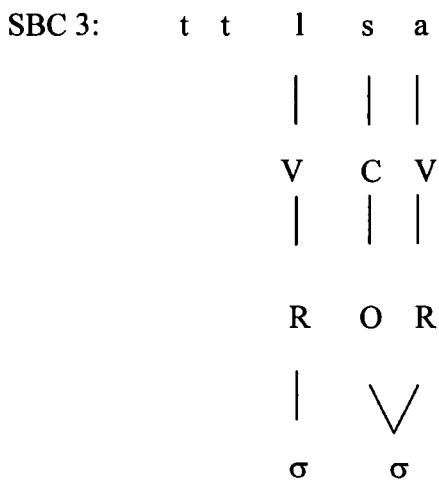

This procedure can apply to the other members of the set without any further complications. However there are a few other verbs which resist this procedure. These verbs have an initial voiceless consonant, namely /k/, which by virtue of the sonority scale has exactly the same sonority index as its neighbouring /t/.

(30)

- ttkfa ‘give
- ttksa ‘graze’
- ttkba ‘pierce’

It is quite apparent that after SBC 1 has assigned /a/ to a nuclear node and after SBC 2 has adjoined the neighbouring segment as an onset, SBC 3 will find its domain of application. This is however not straight forward because CS is faced with three other segments which have exactly the same sonority index.

At this stage we call upon SBC 5 which says that a string of segments is syllabified from right-to-left. In this way, /k/ would be marked as a peak, since by applying SBC 5 it happens to be the first candidate for that position. SBC 2 and SBC 4 will then apply to adjoin the remaining segments as members of an onset. (31) illustrates this procedure:

(31)

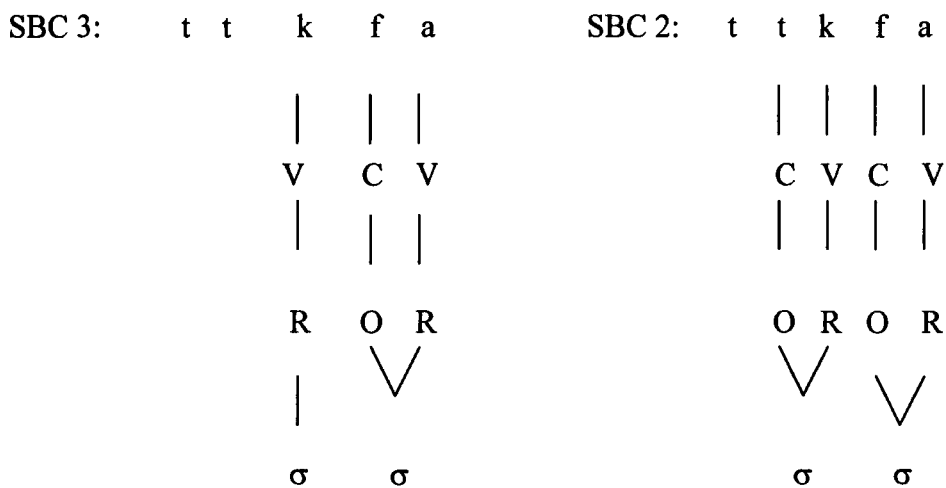
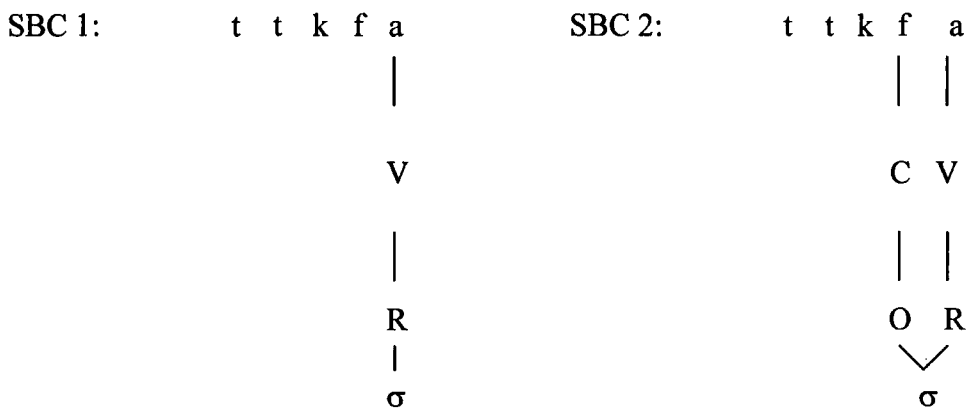

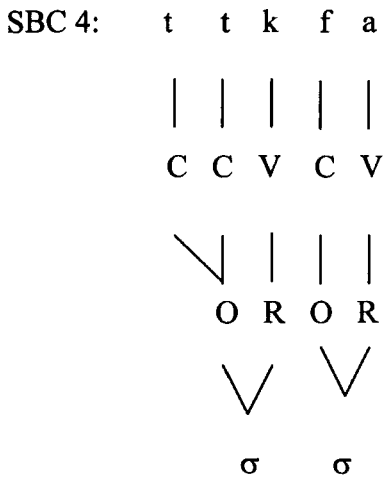

Although the canonical template in (22), as it stands, has worked to account for the passive verb forms illustrated, it needs to be constrained to deal with a number of flaws that it involves:

- a. There is no way to deduce that the first syllable actually has a CCV shape – a pattern which the native speaker produces and which the SBC confirms. It could, therefore, be wrongly interpreted as CCVC or CCVCC or even CCVCCC
- b. The template has to account for 8 segments which is a large number causing many complications
- c. The template contains three optional segments and there is no way to predict when they would cease to be optional and in what manner.
- d. There are slots which are marked /+seg/ which could be realised either as consonants or vowels and there is no way of predicting which one occurs where.
- e. The template does not express the generalisation that the passive verb can contain at least two syllables and at most three syllables

This, therefore, calls for the need to develop a template which would avoid all the previous deficiencies. This template would have to express the generalization that all passive verbs begin with a syllable that has a definite pattern i.e. /CCV/ and would have to state the syllable structure of passive verbs. Segment organization would be a way of formulating this template since it would have nodes which are marked either as C or V and where /+seg/ notation is avoided. This template is represented below:

(32)

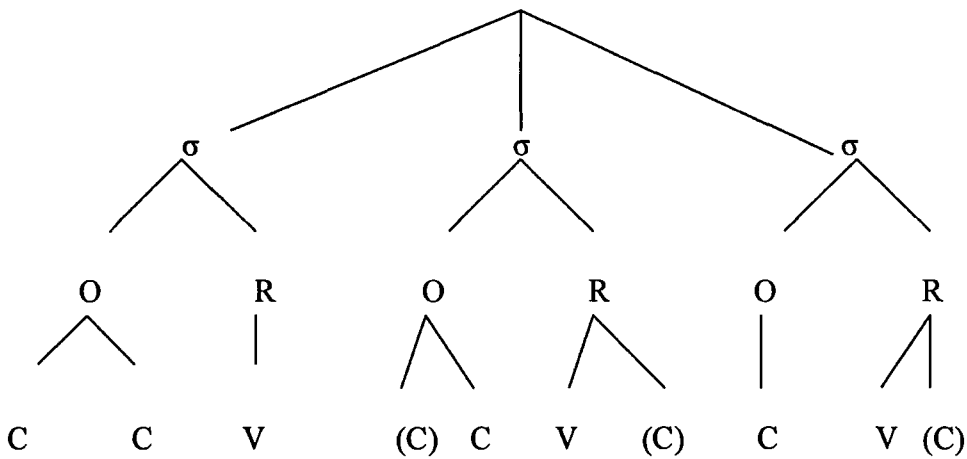

Although this template accounts for all the generalization stated above, it overgenerates unattested forms. For instance, a form like CCV.CCVC.CVC is not attested yet this is the maximal expansion of the template. A constraint is needed to supplement the template and the following constraint was proposed by Moktadir (1989):

(33)

‘If the second syllable is fully realised then the third syllable is not realised’

This constraint marks the whole of the third syllable as optional and excludes unattested forms such as *CCV.CCVC.CVC and *CCV.CCVC.CV and ensures that a form like CCV.CCVC is permitted. Examples of the latter are /tukraz/ ‘plow’ and /tustaj/ ‘filter’. The constraint needs further specifications to avoid the occurrence of other patterns and is best formulated as follows:

(34)

‘The third syllable is not realised if one of the constituents of the second syllable is branching’

This constraint gives the following permissible CCV.CV.CVC and CCV.CV.CV which correspond to verbs like /tuhasab/ and /tudrra/ while excluding the following unattested forms:

(35)

*CCV.CCVC.CVC

*CCV.CCVC.CV

*CCV.CVC.CVC

*CCV.CVC.CV

*CCV.CCVC.CVC

*CCV.CCVC.CV.

Similar results have been found by Moktadir (1989) in his analysis of the causative prefix which appears as a geminate /ss-/ before nuclear segments and as a single consonant /s-/ elsewhere. The relevant examples are reproduced here:

(36)

- | | | |
|----|--------|---------------|
| a. | ss-ajl | 'fly' |
| | ss-IrI | 'want' |
| | ss-Udm | 'kiss' |
| b. | ss-myI | 'grow' |
| | ss-ngI | 'guide' |
| | ss-rhl | 'move' |
| d. | s-naqs | 'decrease' |
| | s-kuʃm | 'paralyse' |
| | s-blDD | 'stand up' |
| e. | s-krfs | 'treat badly' |
| | s-gn | 'sleep' |
| | s-qrbl | 'disturb' |

(Moktadir 1989: 93)

Moktadir shows that the causative forms in Tashlhiyt favours an initial /CCV-/ sequence. This is apparent in (36a and 36c). The verbs in (36b and 36d) have a different type of segment organization and might belong to a different class of verbs. The application of SBC 3 shows otherwise; all the verbs in (36) follow the same pattern i.e. they all have the initial /CCV/ sequence. These are then syllabified as follows:

(37)

SBC 1:

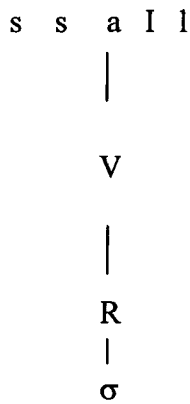

SBC 2:

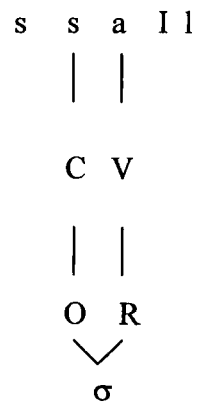

SBC 4:

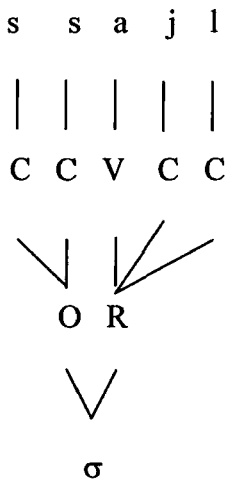

SBC 1 first marks /a/ as syllable peak. This excludes the eligibility of the high vocoid /I/ to become a syllable peak given the prohibition against hiatus. Second SBC 2 supplies an onset to the nucleus, there is no need for SBC 3 to apply. Finally, SBC 4 adjoins the remaining segments as onsets or codas. This same procedure could also be applied to verbs in (36b).

We will apply SBC 3 to the examples in (36b) and (36d) to see whether it will yield a unified treatment:

(38)

SBC 1:

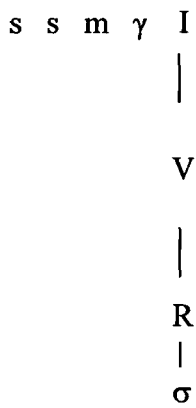

SBC 2:

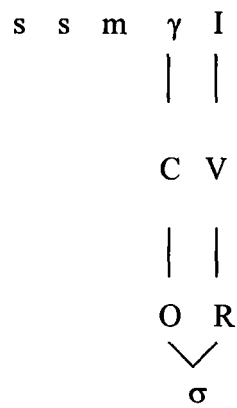

SBC 3:

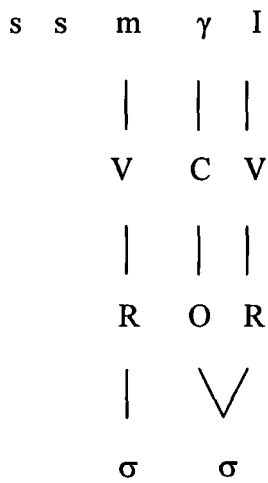

SBC 2:

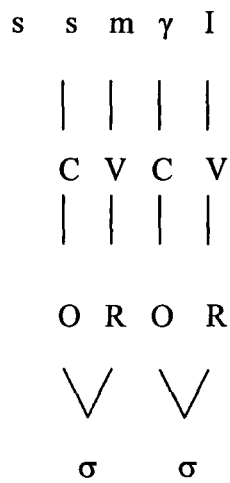

SBC 4:



We can see that after SBC 2 has adjoined an onset to the nucleus, there remain three other unsyllabified segments to the left of the nucleus. SBC 3 searches for the next highest sonority index and marks /m/ as syllable peak. SBC 2 and SBC 4 apply and

the result is a CCV initial pattern just like verbs which contain vowels in third position. An example of verbs without a vowel in (36) is syllabified as follows:

(39)

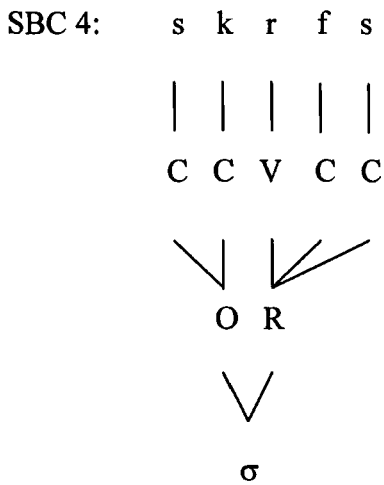
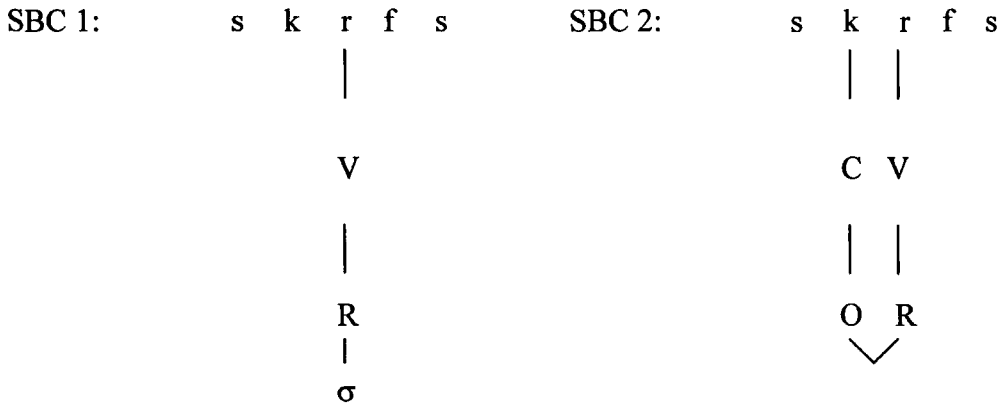

/skrfs/ and /ssajl/ are treated in essentially the same manner by the SBC 3 and the resulting pattern is the same i.e. /CCVCC/.

This syllable based approach outlined above allows for some generalisations to be drawn. Thus, instead of having to admit a large number of passive verb classes, we actually had to recognise a minimum number. Moreover, the various instantiations of prefix form have been circumscribed without recourse to any further set of rules. Furthermore, the constraints which were postulated on permissible segment sequences

did not affect particular segments but they were stated as restrictions on the general structure of passive verbs. Another significant generalisation which we have drawn from this analysis is that derivational affixes are sensitive to the overall make up of the input forms.

3.5 Conclusion

In this chapter, we have discussed one of the issues of relevance of syllable and syllabification procedures to morphological structure. We showed that the sonority principle plays an important role in determining syllable structure in Tashlhiyt. It was shown how the constraints on segment organization in the syllable were largely reflected in the prosodic structure of passive verbs.

In addition, we have given an alternative template for the passive verb to account for all the attested expansions excluding the unattested forms.

Chapter 4

Glide formation

Chapter 4

4.1 Introduction

In this chapter we will investigate the phonological status of glides with respect to the corresponding vowels. The question of whether glides can be considered as independent underlying segments or if they are always allophones of the corresponding vowels has been the center of debate for decades. Traditionally, glides have been seen as non-syllabic vowels, although Maddieson & Emmorey (1985) actually show that, at least phonetically, they are something more than that, since they show different formant patterns and greater stricture. We will, first, give an overview of glides and their properties with reference to the problem of their phonological status and their behaviour with regards to the syllable structure and syllabification in Tashlhiyt. Second, we will look at the treatment of glides in other languages before looking at the glides in Tashlhiyt.

4.2 Phonological statues of Glides

In the *Sound Pattern of English* (SPE) the two sets of sounds were distinguished by means of the binary feature [syllabic]. By adopting a metrical approach, such a feature can be obviated, since syllabicity is incorporated in the metrical representation itself, i.e. it is independently represented on the syllabic tier. A segment is, therefore,

syllabic or not by virtue of its position in the syllable and the quality of adjacent segments; based on this, glides and vowels can be assigned the same feature structure, differing only in terms of syllabic position. Nevertheless, the question remains of whether glides can be underlyingly distinct from vowels. This in turn raises the question of underlying syllabification.

High vowels and glides are often in complementary distribution where the former appear between consonants and the latter between vowels. The complementary distribution of high vowels and glides naturally leads to one set of high vocoids being posited in the underlying representation with the surface distribution determined by independently required rules of syllabification rather than rules that convert vowels into glides (Steriade 1984, Levin 1985, Guerssel 1986). Furthermore, since syllabic affiliation determines the distribution of high vocoids, it has been proposed by Steriade (1984) that underlying high vocoids need not be specified for some major class features. This follows from the fact that the subsyllabic constituents provide the information contained in some major class features. Chomsky and Halle (1968) implicitly recognise the relation between complementary distribution and the representation of high vocoids in the markedness convention for [vocalic].

Besides the obvious case where a [+cons] must also be [-vocalic], this marking convention captures the basic pattern of the complementarity of vowels and glides. From one representation, a vocoid becomes [+vocalic] when following a consonant and it becomes [-vocalic] when following a vowel.

In many analyses of vocoid distribution, underspecification of the major class features is a consequence of the procedural nature of syllabification, which is viewed as a process by which segments are grouped into their constituents. For this purpose, high vocoids are not specified for [syllabic]. Steriade's (1984) theory of syllabification exemplifies this point.

Steriade's basic syllabification rules are the *CV Rule*, which groups a consonant and a following vowel into a syllable, and the *Onset Rule*, which forms onsets from consonants (subject to language specific restriction).

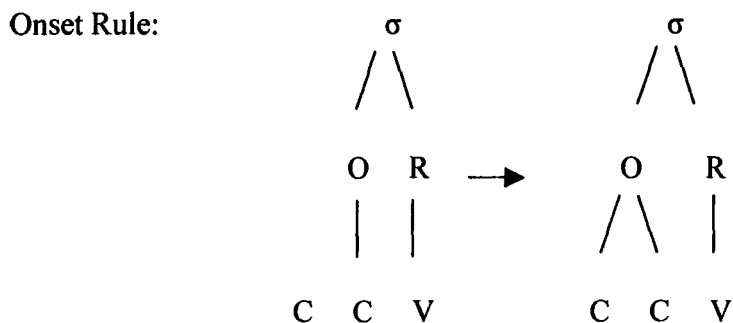
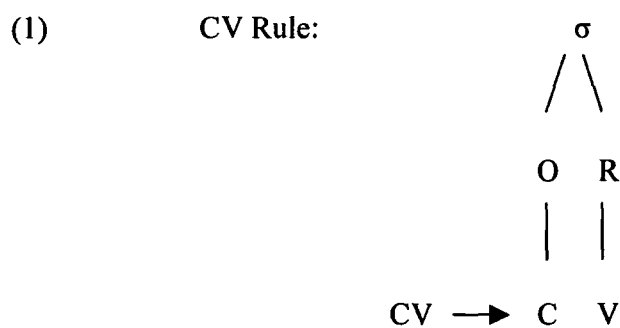

The CV Rule applies freely in the syllabification of CV sequences. Problems emerge, however, when a high vocoid precedes a vowel, as in /Cia/. By the CV rule, the vocoid must be dominated by a C on the CV tier so it should surface as a glide. If a high vocoid occurs between consonants, it must be dominated by a V on the CV tier.

The pattern of Cs and Vs on the CV tier is predictable from the major class features of the segments. Any [-syllabic] segment must be dominated by a C and any [+syllabic] segment must be dominated by a V. To capture the variable surface forms of high vocoids, Steriade claims that high vocoids are not specified for [syllabic] although the nonhigh vocoids are specified as [+syllabic]. Since high vocoids lack a specification for [syllabic], the CV Rule applies regardless and high vocoids receive their specification from the CV tier. Consider the following examples from Latin:

(2)

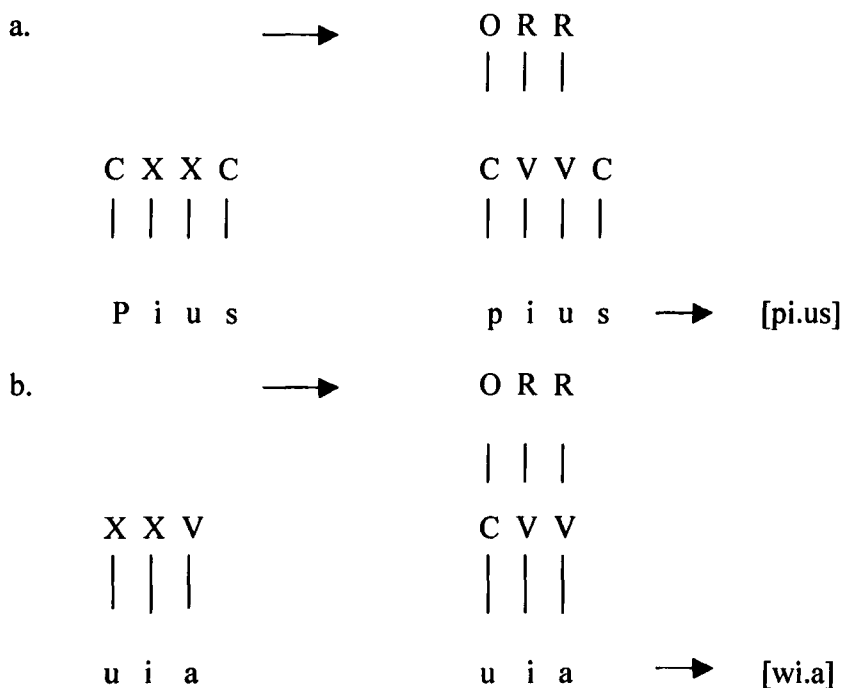

In (2a), the CV Rule, applying from left-to-right, dictates that the high vocoid must be dominated by a V since it follows a C. In (2b), the Onset Rule ensures that the high vocoid must be dominated by a C and so it surfaces as a glide.

The underspecification of [syllabic] follows from the application of the syllabification algorithm. If high vowels are specified as [+syll], the CV Rule will always syllabify them as vowels. Since the vowel/glide alternation is a matter of syllabicity, their distribution should follow from the independently required syllabification algorithm.

Levin (1985) proposes an enriched theory of syllable structure that makes the feature [syllabic] redundant and so eliminates the [+syll]/[-syll] partition of the vowels used by Steriade. According to Levin, vowels are specified as [-consonantal] and syllabic affiliation for all vocoids is determined by a nucleus (an N node) dominating a vocoid. The syllabification of vocoids is accomplished by three possible rules of N-placement.

(3)

Redundancy Rule: obligatory syllable head

Phonological Rule: syllabic head if unsyllabified

Lexically Marked: allows for underlying distinction of syllabicity

Hyman (1985), like Levin, eliminates [syllabic] but proposes a syllable structure that only contains an X-tier. Since [syllabic] is redundant and all segments have weight underlyingly, vowels and consonants are distinguished by [cons]. According to

Hyman, weight units can be removed because onsets neither contribute syllabic weight nor do they bear tones. This generalisation is the basis of Hyman's syllabification algorithm and is called the *Onset Creation Rule (OCR)* which removes the weight unit of a prevocalic consonant. According to the OCR, the syllabification organises [+cons] and [-cons] segments by placing them under one weight unit. The reliance on [cons] for this organisation has specific consequences for high vocoids which can surface as either [+cons] or [-cons], but their underlying specification is not known. Hyman proposes that glides are always [+cons] on the surface and vowels are always [-cons].

Hyman's [+cons] specification of glides suggests that since all segments have weight underlyingly, there are no lexically marked vowels. Hyman proposes that the alternating vocoids in Berber (4a) must involve [+cons] glides and the OCR.

(4)

a. /j+ari/ → [jari] 'he writes'

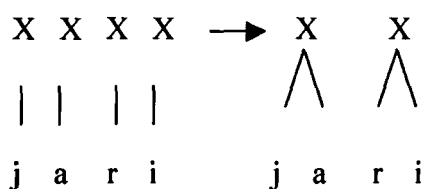

b. /j+ru/ → [iru] 'he cried'

X	X	X	→	X	X
					^
j	r	u		j	r u

In (4a), the OCR applies as it would to any other [+cons] segment so the high vocoid surfaces as a glide. In (4b), the OCR cannot apply, therefore, the [+cons] glide surfaces linked to its own weight unit. According to Hyman, this is the representation of a syllabic segment just like a nasal linked to its own weight unit is a syllabic nasal. A syllabic [j] is equivalent to [i]. Hyman's proposal eliminates marking, but it encounters complications with respect to the specification of [cons] and adds that underspecification of high vocoids might be necessary to account for other types of glide formation.

Hyman proposes that there are two types of glides: Glides that are derived from underlying vowels and those derived from underlying consonants. He further proposes that the two types of segment are distinguished on the basis of the feature [cons]. Only when the underlying representation of a surface glide is a vowel are both glide and high vowel referred to as underlying [-cons] segments. Otherwise, the glide is rather [+cons], these segments are turned into onsets when followed by a vowel, giving as an example /kia/ becoming [kja]. Being specified underlyingly as [+cons], glides may still alternate with vowels.

4.3 Vowel/glide alternation

We will now look at the treatment of vowel/glide alternation in other languages before looking at this alternation in Tashlhiyt.

4.3.1 Moroccan Arabic

We will look at vowel/glide alternation involved in the formation of *nisba adjectives*¹ in Moroccan Arabic.

The nisba formation is characterised by the affixation of the morpheme [i] to the base.

Consider the following examples:

(5)

Base	Nisba	
fas	fasi	‘from Fez’
rbaT	rbaTi	‘from Rabat’

The derivation of the items in (5) is not problematic, the nisba suffix is always realised as the high vowel [i] which occupies the nucleus position in a syllable.

¹ Nisba refers to a class of adjectives formed from nouns by adding the suffix /i/ in the masculine. These adjectives generally indicate origin or affiliation, especially in reference to a place.

(6)

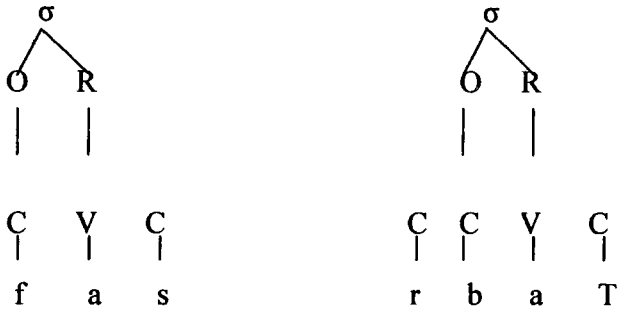

Underlying form

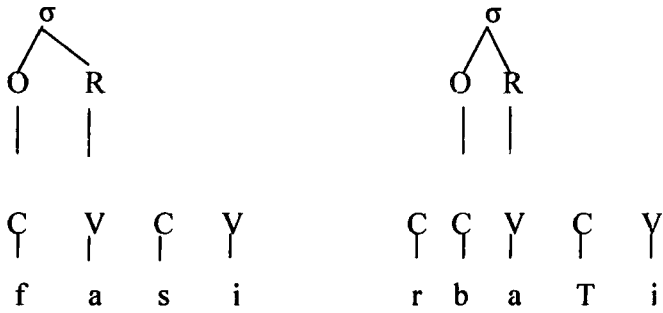

Affixation

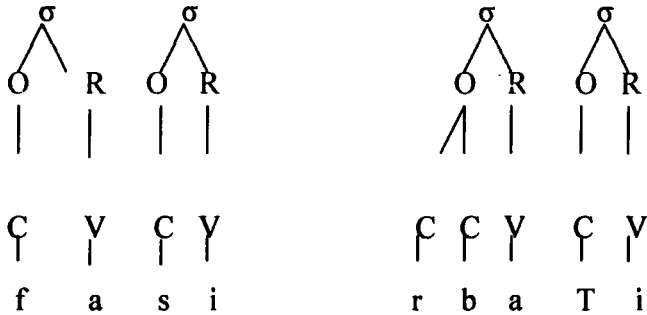

Syllabification

The more interesting cases of nisba adjectives are those ending in a vowel, which is most of the time the low vowel [a]. When the nisba suffix is attached to these bases, glide insertion takes place.

(7)

Base	Nisba	
sla	slawi	‘from Salé’
Dra	Drawi	‘from Dra plain’

In (7) glide insertion takes place to provide an onset to a syllable whose nucleus is the nisba suffix. However, there are cases where the glide insertion does not take place in spite of the fact that the base ends in a vowel. Instead the vowel of the base is deleted when the nisba suffix is attached:

(8)

Base	Nisba	
Swira	Swiri	‘from Essaouira’
qniTra	qniTri	‘from Kenitra’

Comparing the two sets of examples one would conclude that nisba formation imposes a prosodic constraint which requires that the output be disyllabic. If the vowel deletion were to apply in (7) but not in (8), this would result in the followed unattested forms:

(9)

- | | | | |
|----|------|----|-----------|
| a. | *sli | b. | *Swirawi |
| | *Dri | | *qniTrawi |

This conclusion does not hold because there are disyllabic bases whose final vowel is retained even after the suffixation of the nisba morpheme, thus resulting in trisyllabic forms:

(10)

Base	Nisba	
Tanja	Tanjawi	‘from Tangier’
səhra	səhrawi	‘from Sahara’
tadla	tadlawi	‘from Tadla’

The vowel [a] in (7) and (10) is part of the base while that in (8) is the feminine suffix. The derivation of [Tanjawi] and [Swiri] would be as follows:

(11)

- Base	[Tanja]	[Swira]
- Suffixation	[Tanja+i]	[Swira+i]
- a- deletion	not applicable	[Swir+i]
- Syllabification	[Tan.ja.i]	[Swi.ri]
- Glide Insertion	[Tan.ja.wi]	not applicable
- Nisba	[Tanjawi]	[Swiri]

But why is it that [Swira] drops the [a] in nisba formation while [Tanja] does not?

[a] is a feminine suffix attached to the feminine singular morpheme found in the items below:

(12)

Masculine singular	Feminine singular	
dərri	dərrija	'boy/girl'
mæss	mæsssa	'he-cat/she-cat'

When the suffix is attached to the base, the noun gets the feature [+fem]². In (12), the bases that the feminine suffix is attached to are attested independent words i.e. the masculine singular form. The bases in (13) on the other hand are not independent words in Moroccan Arabic:

(13)

fərd+a	'one of a pair'
geff+a	'basket'
qəhw+a	'coffee'
mid+a	'table'

These words only occur in combination with the suffix [a] but the peculiarity of this affix is that it is always attached to bases that are inherently feminine.

Now let us turn to the nisba in which the glide [w] is inserted between the final vowel of the base and the nisba suffix. Consider some of the forms that behave in the same way as those presented in (7):

(14)

Base	Nisba	
fRanSa	fRanSawi	'French'
ma	mawi	'watery'
TaTa	TaTawi	'from TaTa'

The final [a] in these items is not analysed as the feminine singular suffix, rather it is part of the base that is to say that the feature [+fem] is not obtained through derivation, it is simply a segment that happens to be in a position normally occupied by the feminine suffix [a]. When [a] is part of the base, glide insertion takes place; when it is the feminine suffix, insertion does not take place.

4.3.2 French

Hannahs (1998b) states that the feature [syllabic] is superfluous because the syllabicity of a segment depends on its position with respect to a syllable nucleus, he argues that French nonderived glides (Gs) can be distinguished from high vowels (Vs) by means of the feature [+cons].

Hannahs (1995a, b; 1998a, b) analyses the problem of French glides and *Glide Formation*³ (GF) in a Prosodic Phonology framework, a theory of phonological

² See Al Ghadi (1990) for a detailed analysis of gender and number in Moroccan Arabic.

³ A phonological process in French by which the high vowels /i, y, u/ become the corresponding glides

domains which was proposed by Selkirk (1978; 1980) and developed by Nespor & Vogel (1982; 1986).

According to this theory, phonological constituents are a hierarchically arranged set of phonological domains represented by the following constituents:

(15)

Phonological Utterance (U)

Intonational Phrase (I)

Phonological Phrase (ϕ)

Clitic Group (C)

Phonological Word (ω)

Foot (Σ)

Syllable (σ)

Nespor & Vogel give four principles which regulate the construction of prosodic trees:

[j, ɥ, w] when followed by another vowel.

(16)

- 1- A given nonterminal unit of the prosodic hierarchy, X, is composed of one or more units of the immediately lower category.
- 2- A unit of a given level of the hierarchy is exhaustively contained in the superordinate unit of which it is part (Strict Layer Hypothesis)
- 3- The hierarchical structures of prosodic phonology are n-ary branching.
- 4- The relative prominence defined for sister nodes is such that one node is assigned the value strong (s) and all the other nodes are assigned the value weak (w).

Nespor & Vogel show that each constituent is formed by means of rules which make use of different types of grammatical information, and how it constitutes the domain of application of prosodic rules. Two different kinds of processes are distinguished: *mapping rules*, which define the various constituents on the basis of phonological, syntactic, morphological or semantic notions, and *phonological rules proper*, which apply once the different domains have been formed. These rules can apply either within a constituent, or at the juncture between two constituents of the same kind, or at the edge of a constituent:

(17)

a- Domain Span

$$A \longrightarrow B / [\dots X _ Y \dots] D$$

b- Domain Limit

$$A \longrightarrow B / [\dots X _ Y] D$$
$$A \longrightarrow B / [X _ Y \dots] D$$

c- Domain Juncture

$$A \longrightarrow B / [\dots [\dots X _ Y] D [Z \dots] D \dots] D$$
$$A \longrightarrow B / [\dots [\dots X]_d [Y _ Z \dots] D \dots] D$$

(Selkirk 1980:111)

Domain span rules, (17a), are rules which apply whenever their structural descriptions are met within a given prosodic constituent. Domain limit rules (17b), are those which apply when their structural descriptions are met at the edge of a given constituent. Domain juncture rules (17c), are those which apply when their structural descriptions are met at the juncture between two constituents of the same type.

In order to justify the existence of the ω in French, Hannahs (1995a,b) shows that Glide Formation has this constituent as its domain of application. In fact, the rule does not apply between certain prefixes and the stem nor between the two members

of a compound, all of which can be seen as independent ω s. Therefore, GF in French is a ω -span rule:

(18)

$$\left(\begin{array}{c} +\text{syll} \\ +\text{high} \end{array} \right) \rightarrow [-\text{syll}] / [\dots _ V \dots] \omega$$

Hannahs (1995a, b) further argues that this process is better presented in terms of prosodic phonology rather than in terms of lexical phonology. In the former, the GF can be seen as an unmarked rule, while in a lexical phonology it would be restricted to the lexicon since its domain of application (or blocking) could only be referred to by recurring to morphological operations such as prefixation and compounding (Hannahs 1995a).

Hannahs (1998b) shows that there is a good reason to distinguish derived glides – those arising from a regular process of GF – from underlying glides. For this purpose, earlier phonological frameworks were relying on the features [+/- syllabic] and [+/- consonantal] to distinguish between consonants, vowels and glides as [-syll, +cons], [+syll, -cons] and [-syll, -cons] respectively. However, it has been argued (e.g. Levin, 1985) that the feature [syllabic] is superfluous and that the syllabicity of a segment derives from whether or not it appears in a syllable nucleus, not on it being labeled [+syllabic]. Hannahs suggests that a reasonable way to distinguish between

vowels and glides is by characterising underlying glides as [+consonantal]. The analysis of glides in French is used in support of this argument.

(19)

[j] as in *pied* [pje] ‘foot’ *yeux* [jø] ‘eyes’

[w] as in *pois* [pwa] ‘pea’ *oui* [wi] ‘yes’

(20)

[si] *scie* ‘saw’ vs. [sje] *scier* ‘to saw’

[sy] *sue* ‘(I) sweat’ vs. [sɥã] *suant* ‘sweating’

[ʒu] *joue* ‘(I) play’ vs. [ʒwabɪ] *jouable* ‘playable’

(Hannahs 1998b:2)

GF is blocked:

(21)

[ʃwɛt] *chouette* ‘owl’ vs. [bʁwɛt] *brouette* ‘wheelbarrow’

[dɥɛl] *duel* ‘duel’ vs. [kʁɥɛl] *cruel* ‘cruel’

[bjɛ̃] *bien* ‘well’ vs. [tʁiɛdʁ] *trièdre* ‘trihedron’

The examples in (22) below show glides surfacing in environments where GF is blocked which shows that these must be underlying glides not derived ones (GF in French is blocked following a sequence of obstruent + liquid):

(22)

[bʁwajɛ]	broyer	'grind'
[tʁwa]	trois	'three'
[tʁɥit]	truite	'trout'
[fʁɥi]	fruit	'fruit'

(Hannahs 1998b:3)

Minimal pairs such as the example below are more evidence to suggest that there are minimal pairs contrasting derived glides and the underlying ones:

(23)

[tʁwa]	<i>trois</i>	'three'	~	[tʁua]	<i>troua</i>	'perforated'
--------	--------------	---------	---	--------	--------------	--------------

(Hannahs 1998b: 6)

Hannahs 1998 after reminding the reader that the feature [syllabic] is superfluous because the syllabicity of a segment depends on its position with respect to a σ -nucleus, argues that French non-derived Gs can be distinguished from high Vs by means of the feature [+cons].

4.3.3 Malay

McCarthy and Prince (1993) and Cohn (1989) show that homorganic glides and consonantal epenthesis can be in complementary distribution in different

morphological environments. This is seen in Malay⁴ where a glottal stop not only occurs in a phonologically defined environment i.e. when the first vowel is low, but it also appears between all prefixes and stems. Homorganic glides occur after high vowels within morphemes and between stems and suffixes (Durand 1987):

(24)

- | | | | |
|----|-------------|-------------|---------------|
| a. | /tiap/ | [tiyap] | ‘every’ |
| | /buah/ | [buwah] | ‘fruit’ |
| b. | /bantu+an/ | [bantuwan] | ‘aid, relief’ |
| | /uji+an/ | [ujiyan] | ‘test’ |
| c. | /di+ukir/ | [diʔukir] | ‘to carve’ |
| | /di+angkat/ | [diʔangkat] | ‘to lift’ |

In the examples in (24), there is a process of GI which epenthesises a (homorganic) semi-vowel in intervocalic position after a high vowel (/i/ or /u/). In (24a) the glide is inserted within the morpheme while in (24b) it is inserted across morphemes. Durand postulates an onset node which is obligatorily filled when the preceding σ ends in a V, whether by a G or by a [ʔ], in complementary distribution. Two possible representations of the phenomenon are given: 1) as the copying of a rhyme-final high V into the free onset of the following σ ; 2) as a reassociation within the same configuration. GI is seen as a case of GF, since for the former, Durand postulates the UR /CiiV/ or /CuuV/ for the latter the UR /CiV/ or /CuV/.

⁴All glides in Malay appear to be derived (Durand 1987)

In (24c) *?-insertion* operates between identical vowels, whatever the morpheme structure and between vowel-final prefix and vowel-initial stem. On the other hand, intervocalically, within a morpheme or before a vowel-initial suffix if the first vowel is high then we have *Semi-vocalisation*, if it is non-high then *?-insertion* operates. *Semi-vocalisation* is a term adopted by Durand to refer to two analyses: a. high vowel copying a process which copies a rhyme-final high vowel into the free onset of the next syllable. b. high vowel re-association when there is simple re-association within the same configuration.

Malay exhibits an unmarked pattern of homorganic glide distribution in that high vowels are followed by homorganic glides, but low vowels are not. The distribution is similar to the distribution of other typological variations as other nonmoraic vocoids.

4.3.4 Berber languages

There are two approaches to the characterization of high vowel/glide alternation in Berber. The first approach makes the strong claim that there is no underlying difference whatsoever between a high vowel and a glide. The realization of an underlying vowel as a vowel or corresponding glide depends on syllable structure (Applegate, 1970; Boukous, 1987b; Dell and Elmedlaoui, 1985). The second approach, on the other hand, claims that some cases necessitate an underlying

contrast between high vowels and glides. Proponents of this standpoint analysed data from dialects of Berber other than Tashlhiyt. In their view, an underlying vowel always surfaces as a vowel, whereas an underlying glide alternates between a vowel and a glide (Bynon, 1978; Guerssel, 1986). We will now look at how these phenomena are dealt with in Berber languages.

4.3.4.1 Tamazight

We have seen in chapter 1 that all consonants in Berber can be vocalised⁵ and glides are no exception. The analysis of vocalised glides in Berber assumes that there are underlying glides in the language. Basset (1952) and Applegate (1971) claim that the distribution of high vocoids can be accounted for with only two vocoids. This is born out given that the surface distribution is the usual complementary distribution of vowels occurring adjacent to consonants and nonmoraic vocoids occurring adjacent to vowels. Bynon (1978) notes that even though Berber exhibits this complementary distribution, there must be an underlying contrast between vowels and glides. The sources of evidence are based on the Ait Hadidu dialect of Tamazight.

Evidence is provided for this conclusion: a) there are geminate glides, but no geminate vowels and b) there are no vowel sequences, but there are consonant sequences containing glides.

Bynon further classifies the semivowels along with the consonants. He shows that a distinction between consonant and vowel can in fact be made on the basis of two simple criteria: first, consonants may form clusters whereas a sequence of two vowels is excluded; secondly, consonants may exist in one or other of two phonemically opposable forms, non-geminate and geminate whereas vowels are not susceptible to any comparable opposition.

The environments in which each may occur are restricted by rules which concern vowels and non-geminate semivowels: (1) a vowel may occur in any environment except next to a vowel; (2) a non-geminate semivowel may occur in any environment next to a vowel and after any segment before pause. It may not occur initially before a consonant nor medially between consonants. There are therefore two environment in which vowel and semivowel are in complementary distribution and cannot contrast, namely initially before a consonant and medially between consonants. In final position after a consonant, however, either may occur and in this position they do contrast phonemically. They may also contrast when a sequence vowel-semivowel or semivowel-vowel occurs medially between consonants.

⁵By vocalised here we mean that they function as a nucleus.

(25)

a-	/ini/	'say, tell!'	/inj/	'he rode'
	/isli/	'bridegroom'	/islj/	'it curdled'
	/iddu/	'...and he went'	/iddw/	'he displaced himself'
	/ssu/	'spread (carpet, etc)'	/ssw/	'give to drink'
b-	/attswim/	'you (m. pl.) will drink'	/attsujm/	'you(m.pl.)will dip/dunk'
	/attswimt/	'you (f. pl.) will drink '	/attsujmt/	'you(f.pl.) will dip/dunk'

(Adapted from Bynon 1974: 294-295)

At the morphophonemic level, the underlying system comprises four segments, which are labelled I, J, U and W. At the phonemic level, the system also comprises four opposable segments, /i/, /j/, /u/ and /w/. The two systems are related at the phonemic level following two rules: (1) underlying I and U are always realised as phonemic /i/ and /u/, that is to say an underlying vowel is invariably realised as a surface vowel; underlying J and W, on the other hand, are realised either as surface /j/ and /w/ or as surface /i/ and /u/ depending upon the environment. (2) they are realised as semivowels in those environments in which the phoneme distribution rules permit the occurrence of a semivowel, namely next to a vowel and in final position after a consonant, whereas (3) in all other positions they are realised as vowels.

Guerssel's (1986) analysis of Ait Segrouchen Berber leads to the same conclusion.

He shows that an underlying vowel/glide contrast is necessary to account for the

distribution of high vocoids, which does deviate from complementary distribution. Bynon and Guerssel noted that in Berber underlying glides alternate with vowels, while underlying vowels do not alternate with nonmoraic counterparts.

According to Guerssel, postvocalic vocoids always surface as vowels. This is exemplified in (26) with the demonstrative suffix /-u/ and the first person singular object clitic /-i/ which always surface as [u] and [i] respectively. The intervocalic glide in (26b) is epenthetic:

(26)

- | | | | |
|----|------------|-----------------|----------|
| a. | arjaz-u | ‘this man’ | |
| | tessim-i | ‘she raised me’ | |
| b. | arba-j-u | ‘this boy’ | *arbaw |
| | afa-j-u | ‘this fire’ | *afaw |
| | tenna-j-i | ‘she told me’ | *tennaj |
| | tebgha-j-i | ‘she wants me’ | *tebghaj |

The glide is not inserted in (26a) where the stems ends in a consonant. In these examples the suffix *u* and *i* are syllabified into CV syllables with the last consonant of each stem. In (26b) on the other hand, the stems end in a vowel resulting in a succession of two rimes when the suffix is added. This hiatus is broken by the insertion of the glide.

Unlike the suffixes in (26), the third person subject marker and the construct state prefixes, which consists of a high vocoid, shows an alternation between high vowels and glides, the former occurs when the stem starts in a consonant and the latter when the stem starts in a vowel:

- (27)
- | | |
|---------|-------------|
| i-ru | ‘he cried’ |
| j-ari | ‘he writes’ |
| u-mazan | ‘messenger’ |
| w-ansa | ‘place’ |

The underlying contrast for vowels and glides is visible when vocoids are adjacent otherwise high vocoids appear to be in complementary distribution. This is seen in (28), where vocoids in the final position in a root surface as a vowel regardless of the underlying specification. This occurs before consonant-initial suffixes:

- (28)
- | | | | |
|----|-----------|---------|----------------------------|
| a- | turi-ten | /turi/ | ‘she wrote them’ |
| | tini-ten | /tini/ | ‘she tells them’ |
| | tebdu-ten | /tebdu/ | ‘she divided them’ |
| | tessu-ten | /tessu/ | ‘she made them into a bed’ |
| b- | tusi-ten | /tusj/ | ‘she carried them’ |
| | tuli-ten | /tulj’ | ‘she ascended them’ |
| | tendu-ten | /tendw/ | ‘she crossed them’ |
| | tessu-ten | /tessw/ | ‘she made them drink |

Let us now look at the form of reciprocal suffixed *m-* when added to the base. *m-* is subject to alternations depending on the constituents of the root to which it is affixed.

The prefix exhibits three different allomorphs shown in (29):

(29)

- | | | |
|----|------------------|----------------------------------|
| a. | <i>m-xənfar</i> | ‘to grab each other’ |
| | <i>m-sərbas</i> | ‘to follow each other in a line’ |
| | <i>m-hərtak’</i> | ‘to beat up on each other’ |
| | <i>m-səllam</i> | ‘to greet each other’ |
| | <i>m-bəddal</i> | ‘to exchange’ |
| b. | <i>mm-rjam</i> | ‘to insult each other’ |
| | <i>mm-rdal</i> | ‘to loan to each other’ |
| | <i>mm-xbac</i> | ‘to scratch each other’ |
| | <i>mm-jbar</i> | ‘to protect each other’ |
| | <i>mm-rzam</i> | ‘to divorce each other’ |
| c. | <i>mj-adar</i> | ‘to chase each other’ |
| | <i>mj-away</i> | ‘to marry each other’ |
| | <i>mj-azan</i> | ‘to send each other’ |
| | <i>mj-ussan</i> | ‘to know each other’ |
| | <i>mj-ukkas</i> | ‘to take away from each other’ |

(Guerssel 1992: 19)

The data in (29) shows that the shape of the reciprocal morpheme is determined by the segmental make up of the base. (29c) shows that the prefix *mj-* always appears

when the base begins with a phonetic vowel. *m-* is however used when the base begins with a CV syllable whose nucleus is realised as a full vowel or as a short vowel, while the reciprocal morpheme is geminated when it is prefixed to a base whose first syllable contains an empty nucleus in the rime position. Going back to the reciprocal morpheme *mj-*, Guerssel shows that it is present when there is a succession of two rimes namely the two rimes that are separated by no segmental material. This absence of segmental material between two rimes is not tolerated in the language and is therefore avoided by insertion of the glide as shown in (30):

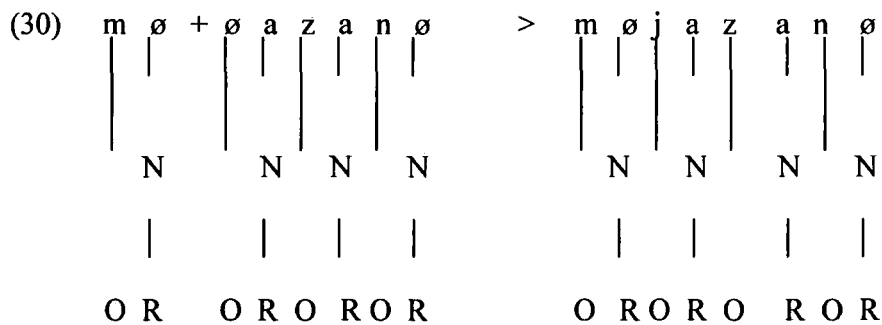

(Guerssel 1992: 22)

Consider the example in (31):

(31)

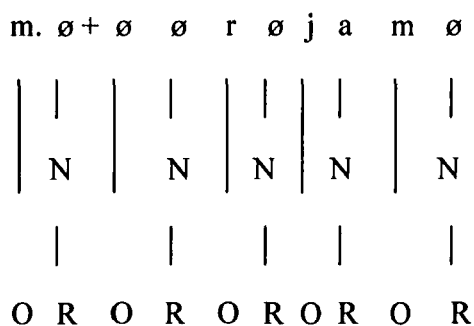

The sequence yields a string containing two successive rimes that are separated by no segmental material this would normally trigger a glide insertion which would result in (32) below:

(32)

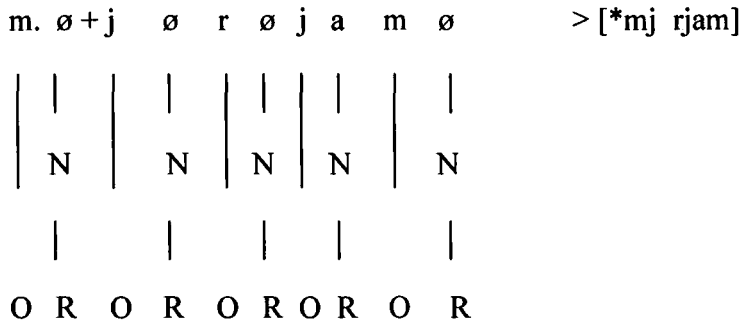

The same procedure cannot apply and the glide formation is therefore blocked. This is the case because in (30) the second rime in the succession of rimes not separated by an onset is a full vowel but in (32) it is an empty nucleus. Guerssel accounts for this by suggesting that the glide that appears in an onset position must be followed by a segment phonetically realised as a full vowel. Since the second rime in (32) is empty, the default glide may not be inserted in the appropriate onset position, since it would not satisfy the condition stating that it needs to be followed by a full vowel.

4.3.4.2 Taqbaylit

In Taqbaylit, like in Ait Sheghrouchen, glides alternate with high vowels the contexts shown in the examples below:

(33)

Ait Seghrouchen

j-uf 'he found'	jø-ru > i-ru 'he cried'
j-asi 'he carries'	jø-sal > i-sal 'he asked'
w-udi 'butter' (construct state)	wø-fus > u-fus 'hand' (construct state)
w-adu 'wind' (construct state)	wø-dar > u-dar 'foot' (construct state)

Taqbaylit

y-ufa 'he found'	yø-ru > i-ru 'he cried'
y-usad 'he arrived'	yø-wala > i-wala 'he asked'
w-udi 'butter' (construct state)	wø-fus > u-fus 'hand' (construct state)
w-adu 'wind' (construct state)	wø-dar > u-dar 'foot' (construct state)

(Guerssel 1992:35)

The data in (33) shows that a glide may not appear in the onset position of a CV syllable whose nucleus is empty. Consonants however may occur in this position as illustrated by the feminine marker *t* compared with the masculine marker *y/i* in (34):

(34)

tø-ru [tru] 'she cried'	jø-ru [iru] 'he cried'	not [*jru]
tø-lul [tlul] 'she was born'	jø-lul [ilul] 'he was born'	not[*jlul]

These examples show that the glide occupies the nucleus position of a CV syllable whose onset is empty. The explanation given by Guerssel for this glide/vowel

alternation is that glides must be followed by a rime. The rime in turn needs to be preceded by an onset provided the nucleus in the rime is occupied by a vowel.

In Taqbaylit, the bound state prefix and the third person singular prefix surface as high vowels only when the root has an initial CV sequence as in (35b). The initial CC sequences, as in (35c), have a glide followed by an epenthetic schwa (Kenstowicz, Bader and Benkeddache 1985):

(35)

- | | | | |
|----|-------------------------|-------------------|--------------|
| a. | w- <i>adu</i> ‘wind’ | j- <i>usad</i> | ‘he arrives’ |
| b. | u- <i>fus</i> ‘hand’ | i- <i>dhudhan</i> | ‘fingers’ |
| | u- <i>kursi</i> ‘chair’ | i- <i>ruh</i> | ‘he left’ |
| c. | wərgaz ‘man’ | jəfrax | ‘birds’ |
| | wəmsis ‘cat’ | jəfka | ‘he gave’ |

In both Taqbaylit and Ait Seghrouchen, the prefixes are [+cons] (Bader, 1984). If the prefixes were underlyingly vocalic, the surface form for /frax/ would be [ifrax]. The occurrence of schwa epenthesis in this example is an evidence that the prefixes in (35) must be [+cons] vocoids alternating with vocalised glides.

Bader (1984) shows that vocalised glides are never followed by two consonants and schwa is always followed by two consonants as shown in the examples below. The prefix /th/ is a feminine marker while the prefixes /w, j/ are masculine markers:

(36)

a.	th+qsisth	[thəqsisth]	‘girl’	
	th+zrivth	[thəzrivth]	‘stress’	
b.	/th+mazigth/	[əthmazigth]	‘Berber woman’	*thəmazigth
	/th+sasith/	[əthsasith]	‘hat’	*thəsasith
c.	/w+kursi/	[ukursi]	‘chair’	*wəkursi
	/j+ruh/	[iruh]	‘he left’	*jəruh

In (36a) schwa appears after the first consonant in trisegmental obstruent clusters. In bisegmental clusters, however, the glide is vocalized. Taqbaylit allows a glide in the onset position when it is followed by an epenthetic schwa unlike Ait Seghrouchen. All underlying glides in Ait Seghrouchen vocalise, whereas only underlying glides that precede a single consonant vocalise in Taqbaylit. In both languages, however, glide epenthesis is used to break vowel sequences.

4.3.4.3 Tarifit

According to Dell and Tangi (1992), in the Ath-Sidhar dialect of Tarifit, a cluster of four consonants constituting an affix and trisegmental root is syllabified as two closed syllables:

(37)

/th+xzn/	[thəxzən]	‘to store’
/dhhn+th/	[dhəhnəth]	‘rub’

These examples are compared with the roots in (38) containing glides. The latter have the same distribution of schwa as the roots in (37). This indicates that the glides are consonantal and to show that the glides contrast with [-cons] high vocoids, Dell and Tangi provide examples of roots containing high vowels. These roots, do not have epenthetic schwas:

(38)

a.	/th+wzn/	[thəwzən]	*thuzən	‘weigh’
	/th+jma/	[thəyma]	*thima	‘grow’
	/th+zwr/	[thəzwər]	*thəzur	‘redden’
	/thdhw+th/	[thdhwith]	*thədhuth	‘snap’
b.	/th+udhf/	[thudhəf]		‘enter’
	/th+ira/	[thira]		‘play’
	/th+mun/	[thmun]		‘accompany’
	/thu+dhth/	[thudhuth]		‘overtake’

The forms in (38a) have a schwa which shows that the consonantal glides are considered as glides rather than vocalised glides and epenthesis only occurs in closed syllables. Trisegmental clusters containing obstruents and glides are also syllabified in the same way with the epenthesis between the second two segments. Dell and Tangi state that there are no word-final consonant clusters in Tarifit, but word-initial clusters are permitted.⁶

⁶ In Taqbaylit, the opposite occurs, final clusters are allowed but no initial clusters are allowed (Bader 1984).

(39)

a.	/xzn/	[xʒən]	*əxzən	‘store’
b.	/wzn/	[wzən]	*əwzən, *uzən	‘weigh’
	/jma/	[jma]	*əjma, *ima	‘grow’

The examples show that there is no word-initial epenthesis in Tarifit. Dell and Tangi show that based on the syllabification of roots, Tarifit does not appear to have an alternation between underlying glides and vowels, however, the third person masculine prefix /j-/ does alternate.

(40)

a.	/j+xzn/	[jəx.zən.]	‘store’
	/j+wzn/	[jəw.zən.]	‘weigh’
b.	/j+mun/	[i.mun.]	‘collect’

The data in (40) shows that the environment for vocalised glides in Tarifit is identical to Taqbaylit, that is, vocalised glides never appear before two consonants but they occur before single consonants.

There is another environment in Tarifit in which vocalised glides appear. Let us consider the following examples:

(41)

/fsj/	[fəs.jəth.]	[thəf.si.]	*thəf.sj.	‘open’
/qdhw/	[qəd.h.wəth.]	[thə.dhu.]	*thəq.dhəw	‘go’

The examples above show that the phrase-final glides surface as a vowel rather than as a glide preceded by an epenthetic schwa. The vocalised glides in this environment are not expected given that the glides are like other consonants. These word-final glides are seen as a consequence of the preference of prosodic words to end in an open syllable (Dell and Tangi 1992).

4.3.5 Tashlhiyt

Before looking at the vowel/glide alternation we will first look at the status of glides in Tashlhiyt and a case of glide epenthesis.

As seen in chapter 2, syllabification in Tashlhiyt operates in conformity with the sonority scale. The sonority scale set forth by Selkirk (1984) does not mention the glide values, for they are assumed to be contextual variants of their corresponding vowel counterparts. Therefore, as far as sonority is concerned, they have the same index as /i/ and /u/, namely 9. Similarly, the sonority scale figuring in Dell & Elmedlaoui (1985) makes no reference to the special value of the glides. They assume, following Selkirk, that glides in Tashlhiyt are as sonorous as the vowels they alternate with.

Boukous (1987), for his part, argues for the zero sonority value of the glides on distributional grounds: glides can never occur in the peak position, a position that can

be occupied by any obstruent. And since obstruents have the lowest sonority values, it means that they are more sonorous than the glides.

Following the footsteps of Boukous, we shall look at stress related evidence to join Boukous in arguing against Selkirk's position with regards to the value of glides in Tashliyt. Although this analysis cannot establish the exact sonority of the glides, it will show that granting the glides the same value as that of high vocoids is erroneous.

Consider the following examples

(42)

ajlullu	'a kind of plant'
ajdi	'dog'

These data allow two different syllable scansions. If glides have indeed the same sonority index as their vowel alternates, the syllabification algorithm is going to yield the forms in (43a); whereas, if the glides have the least sonority value, the scansion procedures are going to result in (43b):

(43)

a.	aj.lu.llu
	aj.di
b.	a.ju.llu
	aj.di

The template permits both syllabifications and any statement trying to favour one instead of the other would be ad hoc. However, when stress is taken into consideration, it yields the following stress patterns:

(44)

- a. *a' j.lu.llu`
*a' j.di`
- b. a` .jlu.llu'
a.jdi'

The syllabification in (44a) results in unattested stress patterns. The glides are, therefore, analysed as having a very low sonority index, at least lower or equal to 2 as the syllabification of *ajdi* shows. In the following examples, however, adopting either syllabification (45a) or (45b) does not change the stress pattern of the words:

(45)

- a. a'jt 'prefix added to surname'
a.wti'l 'hare'
a.ha'jk 'piece of cloth'
- b. a'jt
aw.ti'l
a.ha'jk

We will now look at an environment where a glide is inserted in Tashlhiyt which differs from the glide insertion cases seen in the other Berber languages previously analysed.

Glide epenthesis occurs in Abnakli-Derivatives, a type of derivative words which can function either as nouns or as adjectives. These derivatives denote persons with a certain occupation or habitual activity. For example, from *agrtil* ‘carpet’ we obtain *agratli* ‘the person who sells and/makes carpets’. All Abnakli-Derivatives are of the form **a-(C)CCcaCC-i.**, i.e. they are minimally **a-CcaCC-i**, and maximally **a-CCCaCC-i**.

Jebbour (1999) distinguishes between the following cases:

(46)

- a. if the base provides more than 4 consonants, the result is:
a-CCCaCC-i (e.g. *afrskil* → *afrsakli*)
- b. if the base provides 4 consonants the resulting derivation has the form:
aCCaCC-i. (e.g. *abnkāl* → *abnkali*)
- c. if the base provides 3 consonants, the result is:
a-CcaGC-i. (G is the epenthetic glide [j]) (e.g. *hlas* → *ahlajsi*)

(Jebbour 1999:101)

The examples in (46) show that a glide is inserted in some cases and not in others. To account for the differences, Jebbour assumes following Dell & Elmedlaoui (1992) that the vowel of these derivatives is an independent affix, and so the stem is what remains if we subtract this vowel from the whole derivative. Further, he proposes that a well-formed Abnakli-Stem must respect the following constraint:

(47)

All Abnakli-Stems must be LHL

This constraint is based on the relation between syllable weight and the nature of the syllable nuclei. The weight of a closed syllable depends on the segmental nature of its nucleus: OVC is heavy (H) but OCC is light (L). Here C refers to a consonantal nucleus.

The constraint in (46) leads to the prediction that glide insertion will occur only with bases which do not provide enough consonants to ensure a LHL stem. The prediction is supported by the following examples from Jebbour (1999):

(48)

	Base	without j-epenthesis	with j-epenthesis
a.	<i>af-rskil</i>	<i>fr.sak.li</i> (LHL)	* <i>fr.sa.jk.li</i> (LLLL)
b.	<i>a-grtil</i>	<i>g.rat.li</i> (LHL)	* <i>g.ra.jt.li</i> (LLLL)
c.	<i>skr</i>	* <i>s.ka.ri</i> (LLL)	<i>s.kaj.ri</i> (LHL)

In (47a) the consonantal material provided by the base is sufficient to ensure LHL.

Further more, j-epenthesis will always lead to incorrect stems. In (47b) the

consonantal material provided by the base is also sufficient to ensure LHL. However, the language does not trigger *j*-epenthesis even in the case where it may produce a correct stem (e.g. *gr.taj.li). The consonantal material provided by the base in (47c) is not sufficient to ensure LHL, therefore, *j*-epenthesis is unavoidable.

This shows that glide epenthesis in Abnakli-Derivatives appears to be prosodically motivated in that it occurs only to provide a coda for the second syllable which must be heavy.

Let us now turn to vowel/glide alternation. Former attempts at the characterization of this phenomenon in Tashlhiyt adopt a functional approach to the issue which claims that there is no underlying difference between high vowels and glides. The realization of an underlying high vowel as a vowel or a corresponding glide depends on the syllable structure.

Boukous (1987), for example, argues that glides and high vowels are not distinct in underlying representation. These can be represented as *U* and *I* whose feature matrices do not include the feature [syllabic]. The realization of the segment as a high vowel or a glide depends on the position of the segment in question in a syllable: vowels appear in the nuclear position of the syllable whereas glides occur in marginal positions, a complementary distribution situation. Boukous notes, however, that certain cases remain that are better accounted for by maintaining an underlying contrast between high vowels and glides. The clearest example is the phonetic form

[rwl] ‘to flee’, which if represented underlyingly as /rUl/ would yield the incorrect output *rul, the form predicted by the established syllabification algorithm.

We will show that the vowel/glide alternation in Tashlhiyt necessitates an underlying contrast between high vowels and glides.

Hyman (1984) proposed that representing vocalised glides as moraic [+cons] segments makes them identical to any other syllabic segment, such as a syllabic nasal or syllabic liquids, since all of these segments are [+cons] and moraic. In relation to Tashlhiyt, any segment can serve as syllable peak as shown by the following classic examples from Dell & Elmedlaoui (1985). The syllabic consonants are indicated by a capital:

(49)

tR.gLt.	‘lock’
tZ.dMt.	‘gather wood’
tF.tKt.	‘you suffered a sprain’
ra.tK.ti.	‘she will remember’

The syllable nuclei are chosen based on application of CS. The syllabification algorithm scans the string of segments and chooses the most sonorous for the syllable peak and the surrounding segments are syllabified as syllable margins. For instance, for the underlying form /trgl/, the algorithm assigns /r/ and /l/ to the nucleus position as they are the most sonorous of the string.

This aspect of Tashlhiyt marks its difference from the other varieties of Berber discussed. In the examples in (49), there is no vowel epenthesis and there is no consonant epenthesis. It has been assumed that Tashlhiyt has only one set of underlying high vocoids that takes the nucleus position. If we adopt the commonly-held assumption that glides have the same feature content as the corresponding high vowels, and that the difference between them only has to do with their different positions within the syllable structure, then, [u] is an occurrence of U which occurs as a syllable nucleus, and [w] is an occurrence of U which occurs as a syllable margin. Similarly, the feature bundle I is notated as [i] when it is syllabic, and as [j] when it is not. This conclusion is, however, challenged by the following examples:

(50)

- | | | | | | |
|----|--------|----------------|----|--------|------------------|
| a. | suj | ‘let pass!’ | b. | zwi | ‘beat down’ |
| | lur | ‘give back’ | | lwr | ‘run away |
| | turtit | ‘garden (fem.) | | twRtat | ‘kind of feline’ |

(50b) shows that there are some morphemes that have high vocoids that must be consonantal and do not show up as peaks in contexts where CS predicts they should. This is explained by the fact that high vocoids [-cons] or [+cons], occupy the same position on the sonority scale and a high vowel syllable peak is preferred to vocalised segments. Dell & Elmedlaoui, however, show that constraint interaction can lead to choosing a less sonorous syllable peak, therefore violating the sonority peak.

In (50a), the high vocoids are nuclei, as is to be expected on account of the fact that they are sonority peaks. In (50b) on the other hand, /w/ in /lwr/ is an onset and the following /r/ is syllabic.

Consider the possible syllabification for the underlying form /haul-tn/ ‘make them plentiful’ which surfaces as [ha.wL.tN]

(51)

- a. ha.ul.tN.
- b. hau.lTn.
- c. ha.wL.tN.

(51a) has the more sonorous nucleus but it is discarded as it violates the constraint stating that all syllables in Tashlhiyt must have an onset⁷ (Dell & Elmedlaoui 1985:111). (51c) is the preferred syllabification where the less sonorous liquid is the preferred nucleus.

More evidence in support of vowel/glide alternation in Tashlhiyt is drawn from the vocalisation of the final vowel exhibited by some verb forms that occur in two morphological classes namely the imperative and perfective.

⁷ This constraint does not apply to postpausal syllables. Tashlhiyt allows onsetless syllables but these can occur only immediately after a pause.

Verb roots can be subdivided into two classes, consonant final verb roots and vowel final ones:

(52)

C-final verbal roots

/dl/ 'cover'

/gn/ 'sleep'

/mDl/ 'bury'

/krf/ 'tie'

/arw/ 'give birth'

/ttw/ 'forget'

/asj/ 'take/lift'

/fsj/ 'melt/loosen'

V-final verbal roots

/afa/ 'find'

/fka/ 'give'

/kla/ 'spend the day'

/rZa/ 'break'

/knu/ 'bend'

/gru/ 'pick up'

/gnu/ 'sew'

/rufu/ 'be thirsty'

In the imperative, underlying glides surface as vowels in the final position as shown in the data in (53):

(53)

Underlying	Imperative	
/arw/	aru	‘give birth’
/ttw/	ttu	‘forget’
/asj/	asi	‘carry’
/atj/	ati	‘outdo’
/fsj/	fsi	‘loosen’
/ittj/	itti	‘move to the side’

Let us now look at the perfective formation. Consider the data in (53):

(54)

Root	Perfective	
a. /mgr/	mgr	‘harvest’
/krf/	krf	‘tie’
b. /bbj/	bbi	‘cut’
/zrj/	zri	‘pass’
c. /lsa/	lsi/a	‘wear’
/nxa/	nxi/a	‘kill’
d. /hbu/	hbi/a	‘hide’
/gnu/	gni/a	‘sew’

In consonant final verbs in (54a), there is no change to the base. Glide vocalisation is shown in the glide final roots in (54b). (54c) and (54d) there is an alternation between *i/a* at the end of the perfective forms. This case of vowel ablaut is unique to the perfective and it is sensitive to person: *i* is used for the first and second person singular while *a* is realised with the remaining persons. The vowel alternating with the underlying glide is not subject to vowel ablaut.

The vowel/glide alternation in the verb forms shown in the imperative and the perfective are explained on the basis of the syllabification of the language. Glides are required to change into vowels when occupying the nucleus position.

4.4 Conclusion

In this chapter we have shown that in Berber, there is an alternation between vowels and glides that can only be attributed to underlying glides surfacing as high vowels. These vocalised glides are a consequence of rules leading to the insertion of glide as the syllable peak. The underlying glides which behave like other consonants with respect to epenthesis, are vocalised when epenthesis results in unattested forms.

The analysis of Tamazight, Taqbaylit and Tarifit require an underlying vowel/glide contrast based on Hyman's different specifications for [cons]. The alternation between vowels and glides is the result of glide vocalization accompanied by schwa

epenthesis. We have also shown that the distribution of epenthetic schwa in Taqbaylit and Tarifit shows that underlying glides pattern like other consonants.

Tashlhiyt also has vowel/glide alternation, contrary to what was assumed in some of the previous analyses of the language. This alternation can only be attributed to underlying glides surfacing as high vowels. These vocalised glides are reliant on evidence from syllabification. Schwa epenthesis, a process found in the other Berber languages is not attested in the language.

Chapter 5

Gemination and syllable structure

Chapter 5

5.1 Introduction

The consonant system of Berber opposes a series of single consonants to geminates. Berber scholars disagree with regards their representation and their phonological behaviour. The aim of this chapter is to, first, look at the nature of geminates then at their relevance to the morphological processes in Tashlhiyt. We propose an alternative analysis to geminate syllabification, which takes into account the prosodic weight of a syllable to yield into attested syllable.

5.2 Tashlhiyt geminates

The phonemic inventory of Tashlhiyt has both single consonants and geminate counterparts (Boukous 1982, 1987; Elmedlaoui 1985; Dell & Elmedlaoui 1985, 1988, 1996). Furthermore, Tashlhiyt makes use of gemination as a morphophonemic process. Underlying geminates contrast with single consonants in all positions and are presented here by double consonant:

(1)

	Singleton		Geminate	
a.	ks	'shepherd'	kks	'take (sth.)off'
	ls	'wear'	lls	'dirty'
	dr	'go'	ddr	'be alive'
b.	ili	'be'	illi	'daughter'
	imi	'mouth'	immi	'mother'
	frk	'be aware'	frrk	'boast'
c.	ns	'stay overnight'	nss	'deflate'
	ad	'this'	add	'press'

The minimal pairs in (1) show the contrastive nature of geminate consonants in Tashlhiyt, which contrast in initial position, medial position and final position.

5.3 The representation of geminates

The characterisation of the geminates has been a long-standing issue in phonological theory. Early models of generative phonology (Kenstowicz and Pyle, 1973; Saib, 1977; Guerssel 1977, 1978) all consider geminates as consisting of two sounds.

The autosegmental model conceived of geminates as consisting of a single melody, while length is represented by two positions on the skeleton (Leben, 1980; Broselow, 1995). Within the SPE model, geminates are represented in one

of two ways a) as single segments with a feature specification [+long] or [+tense] or b) as a sequence of two short segments i.e. CC versus C.

In a study of many varieties of Berber¹, Louali & Maddieson (1999) analysed the productions of 8 subjects with 4 Berber dialects. The acoustic closure duration of stops was measured for 8 speakers, 4 of non-spirantising dialects, 3 of spirantising dialects, and 1 of an assibilating dialect. The dialects of Berber under investigation vary in whether they have been affected by a historical process of spirantisation of singleton plosives, changing for instance /t/ into /θ/ while /tt/ and /dd/ remain as stops. In some, velar stops are least often affected by spirantisation.²

Taking this transformation into consideration, Louali & Maddieson expect the original geminate stops to lose the durational characteristics of geminates, since greater length is redundant when the distinction is transferred to consonant manner. Recordings were made of 8 speakers of a variety of Berber dialects producing 6 repetitions of words embedded in a carrier sentence.

The *Acoustic Closure Duration* (ACD) was measured for all word-medial stops using simultaneous displays of spectrograms and the waveform in the Kay Elemetrics Multispeech program. The ACD is defined as the interval from the

¹ Touareq (Tayirt, Tawellemmet), Tashlhiyt (Tanalt, Tiznit, Anezi), Tamazight (Ait Sadden) and Tarifit (kabledana, Tamsamane)

² Antilla (1972) defines spirantisation as: 'the spirantisation of stops can often be viewed as assimilation to a neighbouring continuant sound (elimination of stoppedness). A very frequent type is assibilation, a stop becoming a sibilant, namely an s-sound (e.g. Greek *t* > *s* in some environments, compare *osmosis* and *osmotic*.'

acoustic offset of the preceding vowel, marked by a sharp drop in amplitude and loss of visible formant structure, to the release burst of the stop. The acoustic interval is assumed to closely reflect the duration of the articulatory gestures which produce these stops.

The results show that singleton and geminate are distinguished by very large differences in ACD, with the ratio between singleton and geminate durations being greater than 1:2. Besides this large difference, there are smaller variations in duration attributable to the effects of voicing, place of articulation, and individual speaker's habits.

Goldsmith (1990) considers the two positions accounting for the representation of geminates to establish whether they are single segments specified as [+long] or they are two successive segments. In support of the feature notation, he shows that rules sensitive to syllable weight treat geminates as single elements; as is the case of stress in English. Second, geminates can occur in certain environments where sequences of two different consonants are not permissible. Third, the integrity of geminates is shown by their resistance to being broken by rules of epenthesis. Finally, separate halves of a geminate resist rules changing segmental quality which suggests that a geminate is not a string of two items.

Evidence in support of the sequence notation is provided by postulating that if a sound associates to two timing slots, it is a geminate; and if it associates to a single slot it is then a simple sound.

(2)

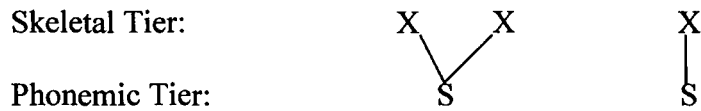

Clearly, a geminate lasts more than a simple consonant. Goldsmith assumes that syllabification operates on the timing tier and given that geminates on that tier consist of two separate slots, they are allowed to syllabify separately.

The postulation of this tier for Tashlhiyt gives a sequence notation for geminates. Such a tier indeed exists as the annexation state of nouns reveals. The annexation state consists of either turning the singular marker /a/ into /u/ or inserting a glide before that marker:

(3)

- a. /yan argaz/ —————> yawwrgaz ‘one man’
b. /yan asif/ —————> yawwasif ‘one river’

The underlined /w/ is the result of assignment of syllable structure; the prohibition of hiatus disallows that both /a/ and /u/ be peaks. Thus, /a/ being more sonorous than /u/ keeps the nucleus status, whereas /u/ turns into a glide. Although the two examples have the same form they result in different forms. To account for this variation, Adnor (1995) proposes the following analysis which yields the correct results.

(4)

UR	/y a n/	/a r g a z/	/y a n/	/a s i f/
	XXX	XXXXX X	XXX	XXXX

Association	y a n	a r g a z	y a n	a s i f
	XXX	XXXXX X	XXX	XXXX

One to one rightward association is applied to associate phonemic elements to their timing slots.

/a/ → /u/	y a n	u r g a z	inapplicable
	XXX	XXXXX X	

The singular marker /a/ in *argaz* is turned into /u/ but this rule does not apply to *asif*.

/n/ → ∅	y a	u r g a z	y a	a s i f
	XXX	XXXXX X	XXX	XXXXX

The final /n/ in the article *yan* is deleted in both examples

$\emptyset \rightarrow /w/$ inapplicable y a w a s i f

/w/ is inserted to break the hiatus in the second example.

Left Spreading	y a u r g a z	y a w a s i f
Syllabification	XXX XXXX X	XXX XXXX X
PR	ya.wwr.gaz	ya.wwa.sif

Saib (1976; 1977) and Guerssel (1978) argue that a feature representation for geminates must be rejected in favour of a sequential representation. They consider geminates as two identical segments that have the features [+long] as opposed to simple consonants which are [-long]. Saib argues that evidence in support of the sequential analysis is drawn from a productive process of schwa insertion.

(5)

/bdu/	→	[əbdu]	‘to start’
/gnu/	→	[əgnu]	‘to sew’
/rzu/	→	[ərzu]	‘to look for’

The form in (5) are a result of the application of a schwa epenthesis rule:

(6)

$\emptyset \rightarrow \text{ə} / \text{___CCV}$

This same rule applied to bases where a geminate is followed by a vowel.

(7)

/kku/	[əkku]	'to mow'
/ddu/	[əddu]	'to go'
/rru/	[ərru]	'to add'

Saib argues that for rule (6) to apply to forms in (7) it is necessary to interpret these forms as beginning with two consonants which in this case happen to be identical segments. He states that his analysis is supported by the results of the application of syncope formulated by Guerssel (1976) as follows:

(8)

$\text{ə} \rightarrow \emptyset / \text{___CV}$

Note that if geminates are treated as one segment, syncope should be expected to apply to the forms in (9):

(9)

bəddəl	'to change'
əmbərraz	'to hit one's head against someone else's'
ur təzzir	'she did not pluck'

After syncope, the ill-formed sequences shown in (10) will result:

(10)

*bddəl

*əmbrraz

*urtzzir

For Guerssel, the wrong outputs obtained in (10) may be avoided only if geminates are treated as two identical segments, in which case syncope would not be applicable. Guerssel concludes that on the basis of gemination and its relation to other phonological processes, the sequential analysis must be favoured and proposes the following constraint:

(11) The Adjacency Identity Constraint (AIC):

Given a string $A^1 A^2$ where $A^1 = A^2$ then a rule can alter the adjacency of $A^1 A^2$ if and only if it alters the identity of A^1 or A^2 .

Dell & Elmedlaoui conceive of geminates as a sequence of two separate segments. The evidence they put forward to support their claim is the fact that geminates occurring prepausally are subject to the prepausal annexation.

Prepausal annexation is a rule applying after Core Syllabification to change a final core syllable into a coda to the preceding Syllable:

(12)

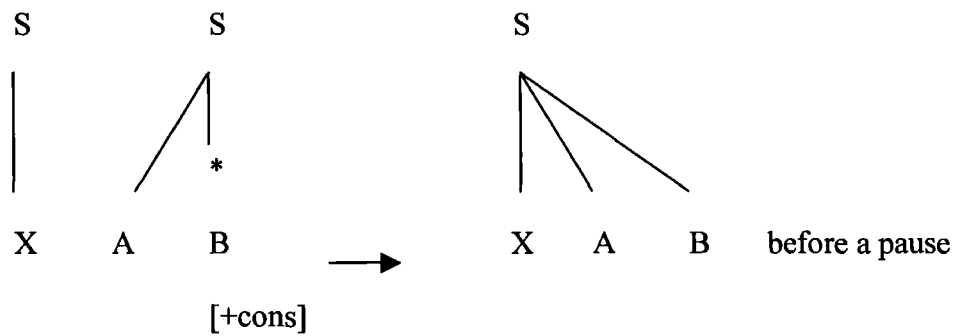

(Dell & Elmedlaoui 1985:119)

The application of such a rule necessitates that the word does not end in a vocoid and that the prepausal syllable be open:

(13)

a. i.gi.dR	b. I.gI.dR	'eagle'
R.gL	R.gI	'lock'

(13b) illustrates the prepausal environment, while (13a) presents an environment in which the following word begins with a nonsyllabic segment.

/rgl/ can be monosyllabic or disyllabic as in (13a) and (13b), respectively, /ʔukrr/ 'he drags' can only be disyllabic because the syllabification procedures devised by Dell & Elmedlaoui predict that the first half of the geminate functions as the syllable peak and the second half the coda to it. The prepausal annexation rule does not apply because the prepausal syllable is checked. Unless a geminate consists of a sequence of two discrete segments, it will not be able to syllabify

separately as peak and coda at a rime resulting in the blockage of the rule for annexation from applying.

Taking these facts into consideration, let us now turn to the imperfective formation which is one of the morphological categories in Tashlhiyt to undergo gemination.

5.4 Types of geminates

After looking at the representations of geminates, I will sketch out the geminate types that Tashlhiyt exhibits. These are two types, a) true geminates and b) derived geminates.

5.4.1 True geminates

These are also called underlying, lexical or tautomorphemic geminates because they are contrastive and do not result from any phonological or morphological process (Hayes 1989).

(14)

ddu	‘to go’
bæddu	‘to stand’
akəššud	‘wood/stick’
ssən	‘to know’
illi	‘my daughter’
kker	‘to kick’
kkes	‘to remove’

5.4.2 Derived geminates

They can be a result of either morphological rules or assimilatory processes.

5.4.2.1 Geminates derived through morphological rules

This type of geminate is best exemplified by the causative, the intensive or habitual, and plural formation. Here are some examples:

(15)

a. The causative formation:

Base	Causative	
<u>ff</u> y	ss- <u>uf</u> y	‘go out’
<u>dd</u> r	ss- <u>ud</u> r	‘live’
ggz	zz- <u>ug</u> z	‘descend’

Initial geminates alternate with a sequence of a vowel and a consonant as the items in (15a) show (the causative morpheme is separated from the stem by a hyphen, and the corresponding geminate and CV constituents are underlined in both of the first columns of 15a).

b. The habitual formation

Basic form		Intensive form	
ləs		ləssa	‘to wear’
kəs		kəssa	‘to watch over sheep’
gen		ggan	‘to sleep’
rzəm		rəzzəm	‘to open’

The habitual or intensive form shown in (15b) is used to express the present continuous. It is the imperfect aspect which is morphologically marked. This is derived by the process of gemination of one of the consonants. The consonant which undergoes gemination depends on the type of verbs.

c. Plural formation

Singular	plural	
afud	ifaddn	‘knees’
asif	isaffn	‘rivers’
afus	ifassn	‘hands’

The singular forms presented in (15c) belong to one of the two groups of nouns in Tashlhiyt: a) those that start with the prefix /t-/ which is the feminine and diminutive marker and b) those that begin with a vowel or sometimes a consonant i.e. masculine nouns. The plural of the latter is formed by the application of two processes:

(16)

a) Ablaut of the second vowel

i, u → a

b) Gemination of the second consonant

Plural is formed two processes, the first one change the root vowels /i/ and /u/ into /a/ and the initial root vowel from /a/ to /i/

5. 4.2.1 Geminates derived through assimilation

In their definition of assimilation, Chomsky and Halle (1968) refer to situations where a given segment is affected in its feature value in such a way that it becomes similar to an adjacent segment. However, the theory of autosegmental phonology, as developed by Goldsmith (1976; 1979) offers a very different conception of this process which may be expressed by spreading rules. The latter expand the temporal domain of autosegments by adding association lines.

This second type of geminates within the derived geminates class is that resulting through assimilatory processes. It takes place when consonantal affixes are attached to roots ending in or beginning with a consonant that has the same place of articulation as the one which makes up the affix. This is illustrated by the following:

(17)

t+agøllid+t	tagøllitt	‘queen’
t+afud+t	tafutt	‘knee’ (diminutive)
n+lalla	llalla	‘of my eldest sister’
ut+t	utt	‘hit him/her’
sfed+t	sføtt	‘wipe it’

Assimilation may be either total or partial. The two types are illustrated in what follows.

Total Assimilation

In the case of total assimilation, the sound undergoing assimilation assimilates all the features of the adjacent sound. Instances of this type of assimilation are illustrated by the possessive /n-/, the future marker /ad-/ and the definite article assimilation.

(18)

a. /n-/ assimilation

/n+lalla/	llalla	‘of my sister’
/n+l-barud/	llbarud	‘of the powder’
/n+rqiyya/	rrqiyya	‘of Rqia’
/n+l+bhr/	llbher	‘of the sea’

b. /ad-/ assimilation

/ad+t+ask+t/	attaskt	‘you will arrive’
/ad+t+asi+t	attasit	‘you will take’

c. /l-/ assimilation

/l+suq/	ssuq	‘the market’
/l+rabuz/	rrabuz	‘the billows’

As can be seen from the examples above, /n-/ and *d* of /ad-/ and /l-/ assimilate to the following segments.

Partial assimilation

Partial assimilation refers to cases where the assimilating sound does not take all the features and this is illustrated in the voicing assimilation exemplified below.

This type of assimilation does not, however, result in gemination.

(19)

Voicing Assimilation

/is+dark/	/izdark/	‘do you have?’
/zrir+t/	/zrix/	‘I saw it’
/kkir+t/	/kkix/	‘I went through it’

To sum up this sub-section, we can say that assimilation is a prominent phonological process in Tashlhiyt. Two types of assimilation have been defined and discussed.

5.5 Imperfective gemination

The imperfective formation in Tashlhiyt consists of affixation which is realised by alternating between a) gemination of a root consonant or b) the prefixation of a geminate consonant *tt*. The following section describes in detail relevant data.

5.5.1 Internal gemination

A class of imperfective forms is obtained by geminating a radical consonant. This class is homogenous in that its members are roots that share the following characteristics (Dell and Elmedlaoui, 1991; Iazzi, 1991; Jebbour, 1996 among others):

(20)

a. They consist of three or less segments

- b. They do not contain a geminate segment
- c. They do not contain initial/medial vowel
- d. They form the majority of native forms

This class of imperfective items, which is subject to gemination, contains forms obtained from trisegmental roots. These can further be divided into those that geminate the initial radical and those that geminate the second:

(21)

Geminating trisegmental roots

a. *First radical element geminated:*

krz	kkrz	‘plow’
frd	ffrd	‘graze’
hrt	hhrt	‘go ashore’ (of a boat)
xmz	xxmz	‘scratch’
krf	kkrf	‘tie’
hlb	hhlb	‘eat sth. with milk’

b. *Second radical element geminated*

kla	klla	‘spend the day’
nya	nqqa	‘kill’
gnu	ggnu	‘sew’
ftu	fttu	‘go’
mgr	mggr	‘harvest’
rgl	rggl	‘lock’
mdj	mddi	‘await’

fsj fssi ‘unfasten’

(Bensoukas 2001: 129)

5.5.2 *tt*-prefixation

The second major process of imperfective formation is the prefixation of a form *tt-* to the root. There are five classes of roots which take this prefixation. These are summarized by Bensoukas as follows:

(22)

- a. Vowel initial roots
- b. Geminate initial roots
- c. Trisegmental roots with a medial vowel
- d. Long roots, irrespective of whether vowel initial or geminate initial
- e. Loan words

Vowel initial roots

af	ttaf	‘be better than’
akr	ttakr	‘steal’
amz	ttamz	‘catch’
ili	ttili	‘be’
umu	ttumu	‘contain’

Geminate-initial roots

kka	tkka	‘pass’
gga	tgga	‘do the laundry’
ddu	tddu	‘go’
ssu	ttssu	‘lay’
ffj	tffi	‘pour’
bbj	ttbbi	‘cut’
ffɣ	tffɣ	‘go out’

Trisegmental roots with a medial vowel

mun	ttmun	‘accompany’
lal	ttlala	‘be born’
rar	ttrar	‘return’
hul	tthul	‘disturb/worry’

Long roots

knkr	tknkar	‘pick a bone’
ffrtl	ttfrrtal	‘escape’
rfufn	ttrfufun	‘go through hardships’
ktitf	ttktitif	‘shiver’
mmattj	ttmattaj	‘get up’
bbaqqj	ttbaqqaj	‘explode’
azzl	ttazzal	‘run’
attuj	ttattuj	‘be high’

Loan words

Arabic	Sbr	ttSbar	‘endure’
	hgR	tthgaR	‘despise’
	γlb	ttγlab	‘win’
	fDr	ttfDar	‘have breakfast’
French	kksiri	ttksiri	‘accelerate’
	grisi	ttgrisi	‘grease’
	drisi	ttdrisi	‘redress’
	kalifi	ttkalifi	‘qualify’

(Bensoukas 2001: 130)

Capital letters in the Arabic data is used to indicate emphatic consonants.

5.5.3 Imperfective syllabification

Tashlhiyt imperfective gemination presents very complex facts and earlier treatments of the phenomenon relied crucially on the idea that prior syllabification is necessary for the explanation of the phenomenon. The segment which undergoes gemination in the imperfective is either the first or the second, never the third. The following generalisation is drawn from Dell & Elmedlaoui's analysis:

(23)

The segment which is geminated in the imperfective stem is that segment which is syllabified as an onset by Core Syllabification (CS)

Dell and Elmedlaoui (1985) argue that the mechanisms which syllabify a string in Tashlhiyt operate in two stages. During the first stage an algorithm CS builds core syllable. Core syllables consist of a nucleus (one segment) preceded by an onset (one segment), except at the beginning of a syllabification domain, where core syllable may have no onset. During the second stage segments not yet syllabified are attached to neighboring syllables and various readjustments give rise to complex onsets and complex codas.

Dell and Elmedlaoui (1985) show that Tashlhiyt has length contrast for both consonants and vowels and give two sources. Some are the phonetic reflexes of underlying long segments, while others arise when identical segments happen to occur on both sides of a morphological boundary e.g. /lgr-a-nn/ 'that field' and

/Igran-n/ ‘lofts’ are homophonous. In order to syllabify these words, the occurrences of a long segment is regarded as a sequence of two units. For instance, [gru] and [grru] are the perfective and imperfective form of a verb meaning ‘to pick up’. The perfective has a regular *r* and is monosyllabic, whereas the imperfective has a long *r* and is disyllabic. Core syllabification syllabifies /grrU/ as gR.ru, the first half of the geminate is realised as the nucleus of an onsetless syllable, while the second half is the onset of the following syllable.

More evidence is given in support of the idea of considering tautomorphemic geminates as sequences of two units. Words which end in a syllabic tautomorphemic geminate are not subject to prepausal annexation. For example:

(24)

a. /I-mI/ ‘show, 3sg.’	i.mL	iml
b. /I-Ukr/ ‘he stole’	yu.kR	yukr
c. /skr-n/ ‘they (m) are doing’	ska.rN	skarn
d. /Imll/ ‘a place name’	i.mLl	*i.mll
e. /I-Ukrr/ ‘he drags’	yu.kRr	*yukrr
f. /skar-nn/ ‘do over there!’	ska.rNn	*skarnn

(24a, b, c) Can be either disyllabic or monosyllabic whereas in the same context,

(24 d, e, f) can only be disyllabic.

At the end of prepausal /Imll/, /I-Ukrr/ and /skar-nn/ there is a long steady-state

syllabic consonant. Dell and Elmedlaoui conclude however that their

syllabification rules show that the first half in the geminate functions as syllabic peak and the second as a coda.

Bensoukas's analysis of the same phenomenon is based on the hypothesis that the two processes of root gemination and *tt*-prefixation are in complementary distribution and can be summarized to a conception of imperfective formation in Tashlhiyt as a morphological operation that consists of prefixing a prosodic element that consists of a consonantal mora. The *tt*-prefixation/gemination are variant realisations of the morpheme and can be approached by considering the imperfective in Tashlhiyt as involving attaching a prosodic constituent, a consonantal mora with no featural content. Taking into consideration the facts of the language, Bensoukas shows that the first strategy is for this mora to be realised as a geminated segment of the base.

The second strategy is for the prefixal mora to take on the form of *tt*- prefix, which is a phonetic realisation of the consonantal mora as the least marked consonant in the language. The choice of either strategy is determined on the basis of the interaction of independently motivated constraints on well-formedness. The following forms show how the hypothesis is instantiated by the various verb classes:

(25) **Geminating roots:**

a-/ μ +krz/

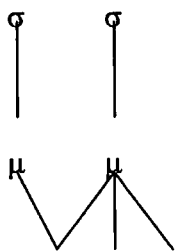

K r z

[kkrz]/[*tkraz]

b-/ μ +mrg/

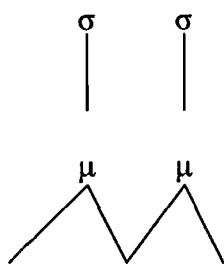

m g r

[mggr]/[*ttmgar]

Following Jebbour (1996) the above assumes that the coda of a syllable whose peak is a consonant does not project a mora, and the syllable as such is light (25a and 25b). Moreover, geminates standing alone as a syllable, with the first half occupying the onset position and the second the nucleus position, are considered ill-formed (see Dell and Elmedlaoui 1988; Jebbour 1996). The analysis reveals that the representation consistent with the facts is given in (26), in which geminates can project a syllable.

(26)

***tt*-prefixing**

a-/ μ +ag l/

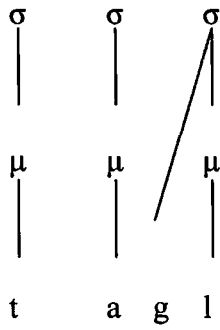

[ttag l]/[*agg l]

b-/ μ +ggr/

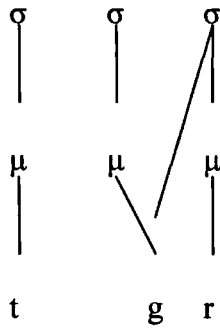

[ttggr]/[*ggrr]

c-/ μ +mun/

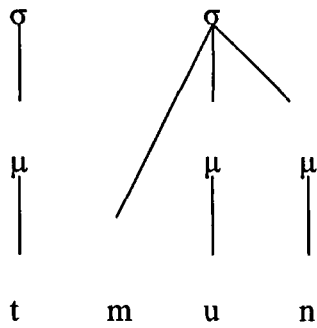

[ttmin]/[*mmun]

d-/ μ +knkr/

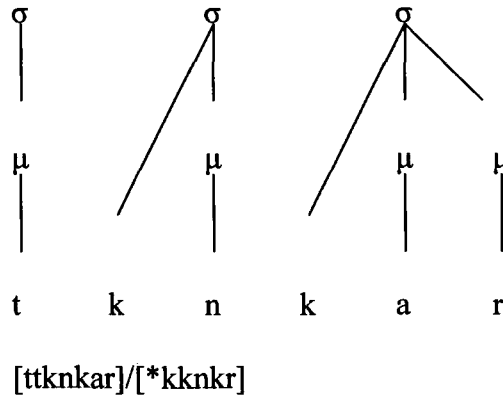

(Bensoukas 2001:133)

(25) shows the class consisting of geminating roots while (26) shows tt-prefixing ones.

Dell and Elmedlaoui (1988; 1991) base their analysis on two elements. First, they propose two conditions, which define what a potential geminating base may be (Dell and Elmedlaoui 1991, p.85). These are repeated here in (27):

(27)

“if a verbal base is to be subject to gemination in the imperfective it must:

- a. not contain any geminate in stem I³
- b. not contain syllabic vocoids in non final position.”

³ Stem I is the perfective form of the verb.

Second, the authors suggest a rule which describes the changes accomplished by Onset-gemination rule in the bases satisfying the condition (27). This rule is formulated in (28):

(28)

Onset-gemination = geminate that segment which is a syllable onset. (Dell and Elmedlaoui 1991, p. 86)

It is important to note that rule (28) needs the information provided by the syllabification algorithm; otherwise, it would be impossible to identify the targeted onset. The statement in (27) is a formulation of surface characteristics of geminating bases, in addition, it needs to make reference both to the segmental and the syllabic make-up of the base. Dell and Elmedlaoui make a remark about this in what follows:

(29)

“Conditions (27b) simultaneously takes into account the feature content of segments (it refers to the value of the feature [cons]) and their location within syllables (it refers to syllabicity). It is not possible to reformulate that condition so as to refer to one only of these two factors. [...] On the other hand, condition (27b) cannot be reformulated so as to prohibit gemination in the imperfective of all the verbs which contain a syllable peak in non final position, for as a result it would incorrectly prohibit it in all those verbs where the syllable peak in question is a contoid, as in !hrf (!hhrf), rgm (rggm) [...]”

(Dell and Elmedlaoui 1991, pp. 85-86)

These problems are a direct consequence of their model of syllabification which does not distinguish between OCC syllables and OVC syllables. In their model CVC and CCC verbal bases for example have exactly the same syllabic structure. It is possible to propose an account which avoids the anomalies described in (29).

First, the claim put forward in this analysis is that Tashlhiyt generally prohibits the contiguity of homomorphic geminates, so Onset-gemination cannot apply to bases which already contain a geminate. Second, a close examination of all imperfectives obtained by Onset-gemination from trisegmental bases reveals a striking property of these imperfectives: they are all composed of two light syllables. In this section, we restrict the discussion to the behaviour of trisegmental bases which do not contain a geminate.

The weight of a syllable is measured by counting the number of moras it contains: if the syllable contains one mora it is L(light) and if it contains two moras it is H(heavy). This is represented as follows:

(30)

Light syllable

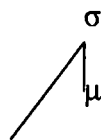

Heavy syllable

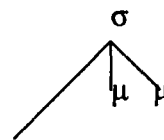

Let us assume that the result of the Onset-gemination rule must respect the following rule:

(31) Apply Onset-gemination rules to two light syllables.

Given this rule and given that contiguous homomorphemic geminates are prohibited, it becomes easy to account for the behaviour of trisegmental bases with Onset-gemination, without making reference to (27). The only thing we need to say is: geminate the onset if the resulting imperfective is LL.

The triconsonantal bases which apparently have the same syllable structure (e.g. CCC vs. CVC, C.CC vs. V.CV and V.CC) behave differently. This can be accounted for following the proposed analysis above, which makes the right predictions:

- OCC, C.OC and C.OV bases can undergo Onset-gemination since the resulting imperfective has the prosodic structure LL. (e.g (32a))
- By contrast, OVC, V.OC and V.OV bases cannot undergo Onset-gemination because the resulting imperfective would not be LL (e.g. (32b)).

(32)

a.	Onset-gemination	syllable structure	Syllable type
	<i>ffrs</i>	<i>f.frs</i> <u>C.OCC</u>	LL
	<i>fssr</i>	<i>fs.sr</i> <u>OC.OC</u>	LL
	<i>grru</i>	<i>gr.ru</i> <u>OC.OV</u>	LL
b.	*mmun	m.mun <u>C.OVC</u>	*LH
	*ammr	am.mr <u>VC.OC</u>	*HL
	*arru	ar.ru <u>VC.OV</u>	*HL

The results in (32) cannot be achieved in Dell and Elmedlaoui's model. The analysis presented here gives a difference between (32a) and (32b) which is a logical result of the syllable structure. This constitutes a strong argument for the model presented here which distinguishes between OCC and OVC syllables by assigning them different weights.

5.5.4 Geminate syllabification

We assume, following Dell and Elmedlaoui (1985; 1997), that the first member of a geminate is never syllabified in the onset of a syllable. In this section, we give a new argument in favour of this assumption.

Tirrugza-Nouns (Dell and Elmedlaoui 1992) are a type of derivative noun that denotes a state or a property. For example, *irrugza* (from *argaz* 'man') means 'manhood'. Tirrugza-Nouns can take one of the following forms, depending on the base from which they are derived:

(34)

ti-C1C1uC2C3a: timmuzya (from *amaziy* "free man")

ti-C1C2C2uC3C4a: tinmmuyra (from *anmyur* "notability")

ti-C1C1uC2C2C3a: timmukksa (from *imkkisi* "heir")

The initial **ti-** is made of two independent morphemes, and consequently the stem is constituted of the vowels i and a together with the consonants surrounding

them. A well-formed stem of Tirrugza-Nouns must contain the vowel [u] preceded by a geminate and must end in the vowel [a].

The appearance of one of the stems given in (34) depends on the consonantal make-up of the base. We can identify the following situations:

(35)

1) Case 1: The base does not contain a geminate.

a. if it contains 3 consonants: C1 is geminated and the stem of resulting derivative is C1C1uXa (we use X here to refer to the remaining consonants of the base)

E.g.

Base	Tirrugza-Noun	Stem	Shape
<i>frk</i>	<i>tiffurka</i>	<i>ffurka</i>	C1C1uC2C3a ‘sharing’
<i>rgaz</i>	<i>tirrugza</i>	<i>rrugza</i>	C1C1uC2C3a ‘manhood’

b. if it contains 4 consonants or more: C2 is geminated and the stem is

C1C2C2uXa

E.g.

Base	Tirrugza-Noun	Stem	Shape
<i>nmɣur</i>	<i>tinmmuɣra</i>	<i>nmmuɣra</i>	C1C2C2uC3C4a ‘growing’
<i>nflus</i>	<i>tinffulsa</i>	<i>nffulsa</i>	C1C2C2uC3C4a ‘wealth’

2) Case 2: The base contains one geminate. This geminate is always transferred to the resulting derivative noun under the following conditions:

a. when C1 is the geminate in the base, no additional gemination occurs and the stem is C1C1uXa

E.g.

Base	Tirrugza-Noun	Stem	Shape
<i>ʃʃrif</i>	<i>tiʃʃurfa</i>	<i>ʃʃurfa</i>	C1C1uC2C3a ‘nobility’
<i>ttalb</i>	<i>tittulba</i>	<i>ttulba</i>	C1C1uC2C3a ‘being in charge of the mosque’

b. when C2 is the geminate in the base,

i. if the base contains 3 different consonants, then C1 is geminated and the stem is C1C1uC2C2C3a

E.g.

Base	Tirrugza-Noun	Stem	Shape
<i>mkkisi</i>	<i>tim mukksa</i>	<i>mmukksa</i>	C1C1uC2C2C3a ‘heir’
<i>mazzal</i>	<i>tim muzzla</i>	<i>mmuzzla</i>	C1C1uC2C2C3a ‘duty’

ii. if the base contains 4 different consonants, then no additional gemination occurs and the stem is C1C2C2uC3C4a

E.g.

Base	Tirrugza-Noun	Stem	Shape
<i>nqqarfu</i>	<i>tinqqurfa</i>	<i>nqqurfa</i>	C1C2C2uC3C4a ‘skinniness’
<i>nttaifu</i>	<i>tinttufa</i>	<i>nttufa</i>	C1C2C2uC3C4a ‘lost soul’

Examination of the data above raises the following questions:

a. Why does gemination affect sometimes the initial consonant and sometimes the second consonant?

b. Why do bases which already contain a geminate sometimes undergo additional gemination and sometimes they do not?

The answer to these questions relies on the assumptions that the stem of *Tirrugza-Noun* must be LHL and that the first and second syllables must share a segment (the onset of the second syllable must be linked to the last segment of the first syllable).

To illustrate, we consider all the possibilities for *argaz* ‘a man’:

(36)

- a. **r.gu.za*
- b. **rg.gu.za*
- c. **rug.za*
- c. *r.rug.za*

We observe that (36a) does not satisfy the conditions in that the stem is LLL and the first syllable and the second syllable do not share a segment.

(36b) is also incorrect because although the first and second syllables share a segment, the stem is LLL.

The stem in (36c) is HL and the first and second syllables do not share a segment and, therefore, is not correct.

We can see from (36d) that the only way to get a well formed Turrugza-noun from *argaz* is to geminate C1 because it is the only way to ensure that both conditions are met.

Let us now consider the possibilities for *anm ʁur* ‘grow up’:

(37)

- a. *n.muʁ.ra
- b. nm.muʁ.ra
- c. *n.nu.mʁ.ra
- d. *nn.muʁ.ra

By contrast to (36), the possibilities in (37) show that C1 cannot be geminated because this gemination will produce a form which does not satisfy the conditions which is why gemination skips to C2.

We will now turn to clarifying why the behaviour of Turrugza-Nouns constitute evidence for the constraint stating that the first member of a geminate is never syllabified in the onset of a syllable. The relevant observation is as in (38):

(38)

- i. C1C1uC2C2C3 are possible Turrugza-stems
- ii. *C1C1uC2C3C3 are not possible Turrugza-stems

This is exactly the situation expected under the assumption that Tashlhiyt does not allow a geminate to form a syllable by itself. In (38ii) C2C3 can form a syllable,

this gives a form with four light syllables **C1.C1u.C2C3.C4a** which cannot be a Tirrugza-stem (recall that the stem must be LHL). In (38i), the sequence **C2C2** cannot be syllabified as **OC**. Thus, the whole geminate is syllabified with the preceding syllable, this gives us a form with three syllables **C1.C1uC2C2.C3a**, a perfect Tirrugza-Stem since it is LHL.

5.5.5 Degemination

The reason for including degemination in the discussion is that it provides additional support for the analysis of imperfective formation in terms of syllabification.

Certain verbal bases have their initial geminate degeminated when the imperfective prefix *tt-* is attached. (39a) shows that when the root contains a geminate, the geminate is degeminated when *tt-* is affixed. However, degemination affects the root initial geminates only, sparing any other geminate that the root may contain (39b):

(39)

a.	ggawr	tt-gawar	‘sit down’
	mmay	tt-may	‘fight’
b.	mmuddu	tt-muddu	‘travel’
	ddullu	tt-dullu	‘be mean’
	bbaqqj	tt-baqqaj	‘exploded’

Data in (40) reveals that roots that have a non-initial geminate are not subject to degemination. Therefore, degemination is a contact phonological process. The items in (40) also show that it is enough for just one segment, either a consonant or a vowel to intervene between the two geminates to block degemination:

(40)

ass	ttass	'fasten'
all	ttall	'lift'
azzl	ttassal	'run'
frrk	ttfrak	'boast'

The generalization which accounts for the degemination above does not account for the examples in (40) and needs to be reformulated:

(41)

ddu	tt-ddu	'go'
ffj	tt-ffi	'pour'
ssu	tt-ssu	'lay'
llj	tt-lli	'roam'

The shorter the base, the more unlikely degemination is. This shows that there is a prosodic minimum requirement on stems in Tashlhiyt. As far as the items subject to degemination are concerned, the stem always consists of two syllables which leads us to posit a disyllabic minimum. Jebbour (1996) accounts for the same phenomenon by formulating the degemination rule in (42) that is specific to the class of imperfectives, this rule is coupled with the constraint in (43) on the prosodic shape of imperfective stems. CRN here stands for consonant root node.

(42)

Imperfective degemination rule

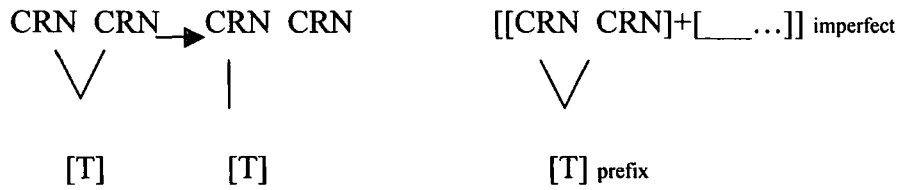

(Jebbour, 1996:161)

(43)

Minimality constraint on imperfective stems

Imperfective stem = [μμ...]

(Jebbour, 1996: 171)

The first geminate consonant of the base is subject to degemination as long as the leftover radical string is not shorter than two moras.

5.6 Gemination in other Berber languages

Geminates exist in Tamazight Berber and their distribution is different from nongeminate CC clusters. Clusters consisting of a geminate followed by a singleton consonant exist, as do word-initial geminates.

(44)

- a. annili 'brain
θimnəqqsin 'women's shoes'
əkksən 'they (m) took off/away'
- b. imlall 'gazelles'
əkk 'to pass by'
- c. afəddis 'belly'
asəkka 'tomorrow'
bəddu 'to start'

(Saib 1976: 54)

The examples show that geminates occur as codas but never as onsets and cannot be separated by a schwa. This is the case for underlying geminates, and geminates derived through assimilation. This process is explained through coronal voicing assimilation (Guerssel 1976) in Ait Seghrouchen Tamazight which leads to the formation of geminates and clusters of geminate followed by singleton clusters. Assimilation turns two coronal obstruents into a geminate if they differ in voicing:

(45) að+θ+ddu attəddu 'she will go'

When the underlying consonants differ in voicing, the surface geminate always maintains the voicing of the second consonant of the underlying cluster. It is important to note at this stage that nonstrident obstruents in Berber are fricatives

when single and stops when geminate, though some processes can create singleton stops. This process occurs in the two dialects of Tamazight.

Ait Seghrouchen differs from from Ayt Ndhir Tamazight with respect to gemination, specifically in the optionality of word-initial epenthesis: /xðm/ can surface either as [əxðəm] or [xðəm]. Ayt Ndhir has a second process where /n/ assimilates completely to a preceding or following /l/ or /t/:

(46)

n+lxuðrθ	əllxuðərθ	* nəlxuðərθ	‘vegetables’
kkɾ+n	əkkrɾ	*əkkrən	‘they (m) stand’

(Penchoen, 1973:8)

C:C and C:# clusters arise also in other contexts where assimilation does not take place namely when a geminate arises through the occurrence of underlying identical elements. The behaviour of geminates, both derived and underlying, in Tamazight is a consequence of two factors: acceptability of geminate codas and restriction on the co-occurrence of similar consonants.

5.7 Conclusion

Although all Berber scholars agree on the acoustic behaviour associated with geminates, they do not agree when it comes to their representation and their phonological behaviour. In this chapter, we have discussed the treatment of geminates in Berber languages, which have both underlying and derived

geminates. In Tashlhiyt an analysis is given with respect to imperfective derivation. The discrepancies observed in the behaviour of Tarrugza-Nouns are straightforwardly accounted for by taking syllable weight into consideration.

In Ait Seghrouchen and Ayt Ndhir dialects of Tamazight gemination is presented through processes of assimilation.

Chapter 6

Conclusion

Conclusion

Research into the syllabification of Berber shows that the different dialects described can be classified into two major categories: those that only accept vocalic segments in the nucleus position and those that allow any segment in the nucleus position (vowels or consonants). In chapter 1, we have shown that Tashlhiyt Berber, which is the primary focus of this study, falls within the second category which allows any segment at the nucleus position. Complex consonant clusters occur in Tashlhiyt both at the underlying level and the phonetic level. The vocalic hypothesis cannot account for the vowel-less sequences; the Sonority hypothesis is, therefore, called for to syllabify these consonant clusters. Following a universal sonority scale, low vowels are said to have the highest sonority index whereas voiceless stops have the lowest. Sequences are scanned for sonority and the most sonorous segments in a string occupy the nucleus position.

Sonority is a basic procedure employed by several theories for determining the syllabicity of a segment. This consists of marking its relative sonority prominence with respect to its neighbouring segments. The more sonorous the segment is, the more likely it is to be syllabic. In Tashlhiyt, any segment, which is a syllabic peak in a syllable configuration, is said to be a syllabic segment. This entails that any such segment can acquire the status of syllabicity regardless of the class of segment type to which it belongs. The role of a syllable configuration is, therefore, crucial in determining the relative syllabicity of a segment. This

procedure, however, allows many possibilities which leads to the introduction of two constraints of syllabification: prohibition of hiatus and core syllabification. The ordering of core syllabification rules in combination with the constraints lead to the correct syllabification of Tashlhiyt data.

We have shown that in the other Berber languages analysed, schwa insertion is used to in the syllabification to prevent unattested syllabification. The discussion in this chapter allowed us to highlight certain features by which Tashlhiyt differs from the other Berber dialects. We have provided evidence that Berber dialects with very similar morphologies may differ significantly in their syllable structure when the domain of syllabification is the stem or some larger unit.

In Tarifit, schwa insertion is governed by the syllabification algorithm in that it is only inserted before consonants assigned to syllable rimes, preventing its occurrence prepausally, and a prevocalic consonant is always assigned to an onset. Schwa epenthesis in Ayt Ndhir Tamazight is predictable and it occurs to break initial consonant clusters and triconsonantal clusters occurring medially. In addition it is never inserted when the absence of vowel would lead to a sequence which could not be broken up into syllables. In Ait Seghrouchen, sonority sequencing generalization is used to syllabify sonorants. This syllabification rule, however does not account for obstruents which remain unsyllabified. These are not treated in the same way as the sonorants and the fricatives discussed, they are subject to Onset-Rime Rule due to the fact that in Ait Seghrouchen, stops do not constitute syllable peaks unlike sonorants and fricatives. In addition, penthetic

schwa is present before stops that cannot be syllabified. In Taqbaylit, a set of syllabification rules are applied to underlying strings of consonants and vowels containing no schwa. When a strings of consonants, that lack vowels, occur schwa is inserted.

We conclude from Chapter 1 that applying the sonority hypothesis to in Tashlihyt Berber allows any consonant, either obstruent or sonorant, to be the nucleus of the syllable. Schwa epenthesis, which is a process used in other Berber dialects is not used to account for vowel-less clusters.

In Chapter 2, we have seen that analyses account for the syllable structure of Tashlihyt by assuming that any segment can occupy the nucleus position of the syllable and by drawing no distinction between syllables with a vocalic nucleus and syllables with a consonantal nucleus. These two types of syllable are supposed to have exactly the same structure and they are treated equally by phonological or morphological phenomena which make reference to syllabic structure. That is to say that syllabic structures which are possible with a vowel as the nucleus are equally possible with a consonant as the nucleus. We have also discussed the issue of relevance of the syllables and syllabification procedures to the morphological structure and argued that the sonority principle plays a fundamental role in determining the syllable structure in general and Tashlihyt in particular. It was shown how the constraints on segment organisation in the syllable were largely reflected in the prosodic structure of passive verbs.

The syllabification procedure proposed relied crucially on the language-particular constraints on permissible syllables, with the sonority principle remaining as an option to be called on when those constraints are violated. We also argued that this syllabification procedure allowed for the classification of passive verbs on the basis of their prosodic structure. The outcome of this procedure is a significant reduction of verb classes into five major classes, which are distinguished by particular behaviour in the passive derivation. The conclusion reached in Chapter 2 is that this syllable-based approach has helped to determine the structure of the passive template, which avoided many of the unattested forms produced by the segment based template.

In chapter 3, we have seen that the characterization of vowel/glide alternation in Berber has been subject to many analyses. Two approaches have been adopted in the literature, the functional approach and the lexical approach. The former makes the claim that there is no underlying difference between a high vowel and a glide. The realization of an underlying high vowel as a vowel or a corresponding glide depends on the syllable structure. The lexical approach, on the other hand, claims that some cases necessitate an underlying contrast between high vowels and glides. Proponents of this standpoint analyse data from Berber other than Tashlhiyt.

In the northern Berber languages, an underlying vowel/glide contrast is necessary to account for the distribution of high vocoids, which does deviate from complementary distribution. Underlying glides alternate with vowels, while

underlying vowels do not alternate with nonmoraic counterparts. We have seen that in Ait Seghrouchen, with regards to affixation of the demonstrative pronoun and the object clitic these are suffixed to both vowel-final and consonant-final bases. When attached to consonant-final bases, the glide is not inserted and the suffixes are syllabified into CV syllables with the last consonant of each stem. When attached to stems ending in a vowel, on the other hand, they result in a succession of two rimes when the suffix is added.

We have also seen the process of glide vocalization and how it applies differently in all the Berber languages. Taqbaylit allows a glide in the onset position when it is followed by an epenthetic schwa unlike Ait Seghrouchen. All underlying glides in Ait Seghrouchen vocalise, whereas only underlying glides that precede a single consonant vocalise in Taqbaylit. In both languages, however, glide epenthesis is used to break vowel sequences. As for Tarifit, the vocalised glide and schwa distribution are seen in terms of the syllabification of consonant sequences. We have seen that in a cluster of four consonants, a prefix plus a trisegmental root is syllabified as two closed syllables. In forms with a schwa, consonantal glides are considered as glides rather than vocalised glides and epenthesis only occurs in closed syllables. Trisegmental clusters containing obstruents and glides are also syllabified in the same way with the epenthesis between the second two segments.

In Tashlhiyt evidence in support of vowel/glide alternation in is drawn from the vocalisation of the final vowel exhibited by some verb forms that occur in two morphological classes namely the imperative and perfective. This is explained on

the basis of the syllabification of the language. Glides are required to change into vowels when occupying the nucleus position.

Our position is that, contrary to what was assumed in some of the previous analyses of the language, Tashlhiyt also has vowel/glide alternation. This alternation can only be attributed to underlying glides surfacing as high vowels. These vocalised glides are reliant on evidence from syllabification.

Chapter 4 we have first looked at the treatment of geminates in some languages before looking at the case of Berber. We have shown that geminates in Berber are never broken up by epenthesis; C:C clusters are possible on the surface, while CCC clusters are not. Geminate inseparability is common across languages and various mechanisms have been devised to explain it both in Berber and generally. This is the case of not only underlying geminates but also geminates formed by assimilation. This chapter also deals with the morphological gemination which some verb roots undergo in the imperfective. One of the basic aims of the treatment is to define the underlying morpheme involved in the formation of Tashlhiyt imperfective forms. The imperfective formations in consists of affixation which is realised by alternating between gemination of a root consonant and the the prefixation of a geminate. We have shown that the distribution of these two processes. If a base does not start with a sibilant, gemination takes, and if it is not a geminate base then it is subject to *tt*-prefixation. We have also considered a process of degemination that operates when two contiguous geminates co-occur as a result of affixation. We have concluded in this chapter that the

discrepancies observed in the behaviour of Tarrugza-Nouns are straightforwardly accounted by taking the syllable weight into consideration and that degemination is motivated by a markedness constraint against two contiguous geminate consonants. Degemination is shown to follow from the interaction of the constraint against contiguous geminates with the constraints responsible for Tashlhiyt imperfective gemination.

Taken as a whole, this examination of Berber syllabification and phonological processes related to the syllable have shown that the phenomena addressed are motivated not only by phonology but by morphology as well. In addition, a simplified analysis of some of the phenomena dealt with is given by taking into account the syllable weight. Finally, we've shown that the analyses dealing with the data for Tashlhiyt differ from the other Berber dialects.

REFERENCES

- Abdel-Massih, E. T. 1968. *Tamazight Verb Structure: A Generative Approach*.
Bloomington: Indiana University Publications.
- Abu-Mansour, M. H. 1990. 'Epenthesis, gemination and syllable structure'. *Current Issues in Linguistic Theory, 72: Perspective on Arabic Linguistics II* ed. By Eid M. & J. McCarthy. Philadelphia: John Benjamins Publishing Company.
- Al Ghadi, A. 1990. *Moroccan Arabic Plurals and the Organisation of the Lexicon*.
D.E.S. Thesis, Faculty of Letters, University of Rabat, Morocco.
- Adnor, A. 1995. *Stress Assignment in Idaw Tanane Tashlhit: a metrical approach*.
D.E.S. Dissertation. Mohamed V University, Morocco.
- Anass, K. 1994. *A study of Deverbal Nominals in Ayt Mzal Tashlhit Berber (A Non-concatinative Approach)*. D.E.S. thesis, Mohammed V University, Faculty of Letters, Rabat.
- Anttila, Raimo. 1972. *An Introduction to Historical and Comparative Linguistics*.
New York: The Macmillan Company.
- Applegate, J. R. 1970. The Berber Languages. In Sebeok, T. (ed). *Current Trends in Linguistics*. Vol. 6: *Linguistics in South West Asia and North Africa*, 586-661. The Hague: Mouton.
- Bader, Y. 1984. *Kabyle Berber phonology and morphology: outstanding issues*.
University of Illinois at Urbana-Champaign dissertation.
- Bader, Y. 1985. Schwa in Berber. *Lingua* 67: 225-249.
- Bader, Y. 1989. Consonant sandhi phenomena and syllable structure in Kabyle Berber. *Lingua* 78: 295-311

- Bader, Y. and M. Kenstowicz. 1984. Syllables and case in Kabyle Berber. *Lingua* 73: 279-299.
- Bagemihl, B. 1991. Syllable structure in Bella Coola. *Linguistic Inquiry*, vol. 22. no. 4. 589-646
- Basset, A. 1952. *La Langue Berbère. Morphologie. Le Verbe- Etude de Thème*. Paris: Librairie Ernest Leroux.
- Basset, A. and A. Picard. 1948. *Eléments de grammaire berbère*. Typo-Litho: Algiers.
- Bensoukas, K. 2001. *Stem Forms in The Nontemplatic Morphology of Berber*. Doctorat d'Etat Thesis. Mohammed V University, Faculty of Letters, Rabat.
- Boukhris, F. 1986. *Le Verbe en Tamazight: Lexique et Morphologie. (Parler des Zemmours)*. Third Cycle Thesis, Université Paris III, Ecole Pratique des Hautes Etudes (4ème Section).
- Boukous, A. 1982. Les contraintes de structure segmentale en berbère (dialecte Tachlhit). *Langues et Litteratures*, II:9-27. Publications de la Faculte des lettres et des Sciences Humaines. Rabat: Maroc.
- Boukous, A. 1985. Variation phonique et competence globale: Le cas du parler amazigh d'Agadir. *Langues et Litteratures*, IV: 69-96. Publications de la Faculte des lettres et des Sciences Humaines. Rabat: Maroc.
- Boukous, A. 1987a. Syllabe et Syllabation en Berbère. *Awal* 3:67-81.
- Boukous, A. 1987b. Phonotactique et domaines prosodique berbère (parler tachlhit d'Agadir, Maroc). Thèse de Doctorat d'Etat, Université de Paris VIII.

- Boukous, A. 1990. Vocalité, sonorité et syllababilité. *Awal* 4: 203-218.
- Boukous, A. 1995. Phonologie comparée dans le domaine Tamazight: le Consonantisme. *Dialectologie et Sciences Humaines au Maroc*, 43-49. Publications de la Faculté des lettres et des Sciences Humaines. Rabat: Maroc.
- Broselow, E. 1995. Skeletal positions and moras. In Goldsmith, J. (ed.). *The Handbook of Phonological Theory*, 175-205. Cambridge, MA.: Blackwell.
- Bynon, J. 1978. The internal reconstruction of Berber vowels and semivowels. In *Atti Del Secondo Congresso Internazionale Di Linguistica Camito-Semita, Firenze, 16-19 aprile 1974*. Istituto Di Linguistica E Di Lingue Orientali: Università Di Firenze.
- Chabot, J.B., 1940. - *Recueil des inscriptions libyques*, Imprimerie Nationale, Paris.
- Chomsky, N. & M. Halle. 1968. *The Sound Pattern of English*. New York : Harper and Row.
- Chtatou, M. 1982. *Aspects of the Phonology of a Berber Dialect of the Rif*. Ph.D. dissertation. The School of Oriental and African Studies: University of London.
- Chtatou, M. 1991. Syllable structure in Tatifit Berber. *Langues et Litteratures* 9: 27-60. Publications de la Faculté des lettres et des Sciences Humaines. Rabat: Morocco.
- Clements, G. N. 1990. The role of the sonority cycle in core syllabification. In Kingston J. & M. Beckman (eds.) *Papers in Laboratory Phonology: Between the Grammar and Physics of Speech*. Cambridge: CUP, 283-333.

- Clements, G. N. 1997. Berber syllabification: derivations or constraints?. In Rocca I (ed.) *Derivations and Constraints in Phonology*. Oxford: Clarendon Press, 289-330.
- Clements, G. N. & S. J. Keyser. 1983. *CV Phonology: a Generative Theory of the Syllable*. Cambridge, Massachusetts: MIT Press.
- Cohen, D. 1988. Le Chamito-Sémitique. In Perrot, J. (ed). *Les Langues dans le Monde Ancien et Moderne*. Troisième Partie- *Les Langues Chamito-Sémitiques* (Textes Réunis par David Cohen), 9-30. Paris: Editions du CNRS.
- Cohn, A. C. 1989. Stress in Indonesian and Bracketing Paradoxes. *Natural Language and Linguistics Theory* 7: 167-216.
- Coleman, J. 1996. Declarative syllabification in Tashlhiyt Berber. *Current Trends in Phonology*. Durand J. and B. Laks (eds.) vol. 1. CNRS: Paris. 175-216.
- Coleman, J. 2001. The phonetics and phonology of Tashlhiyt Berber syllabic consonants. *Transactions of the Philological Society* vol. 99. 1 : 29-64.
- Crystal, D. 1980. *A First Dictionary of Linguistics and Phonetics*. Andre Deutsch, London.
- Dell F. & M. Elmedlaoui. 1985. Syllabic consonants and syllabification in Imdlawn Tshlhiyt Berber. In *Journal of African Languages and Linguistics* 7: 105-130.
- Dell, F. & M. Elmedlaoui. 1988. Syllabic consonants in Berber: some new evidence. In *Journal of African Languages and Linguistics* 10: 1-17.

- Dell, F. & M. Elmedlaoui. 1991. Clitic ordering, morphology and phonology in the verbal complex of Imdlawn Tashlhiyt Berber. *Langue Orientales Anciennes: Philologie et Linguistique* 3, Part II: 77-104.
- Dell, F. & M. Elmedlaoui. 1992. Quantitative transfer in the nonconcatenative morphology of Imdlawn Tashlhiyt Berber. *Journal of Afroasiatic Languages* 3: 89-125
- Dell, F. & M. Elmedlaoui. 1997. La syllabation et les géminées dans la poésie Berbère du Maroc (dialecte Chleuh). *Cahiers de Grammaire*, 22: 1-95.
- Dell, F. & A. Jebbour. 1991. Phonotactique des nons à voyelle initiale en Berbère (Chleuh de Tiznit, Maroc). *Linguistic Analysis* 21: 119-147.
- Dell, F. & A. Jebbour. 1995. Sur la morphologie des noms en Berbère (chleuh de Tiznit, Maroc). *Langue Orientales Anciennes: Philologie et Linguistique* 5-6: 211-232.
- Dell, F. & O. Tangi. 1992. Syllabification and empty nuclei in Ath-Sidhar Rifan Berber. *Journal of African Languages and Linguistics* 13: 125-162.
- Durand, J. 1987. On the phonological status of glides: the evidence from Maly. In Durand J. & J. Anderson (eds.) *Explorations in Dependency Phonology*. Dordrecht: Foris. 79-107.
- Elmedlaoui, M. 1995. *Aspects des représentations phonologiques dans certaines langues chamito-semitiques*. Publications de la Faculté des Lettres et des Sciences Humaines, Rabat: Maroc.
- Elmoujahid, E. 1979. Presentation des phonèmes de la langue Tamazight: la Tachlhiyt d'Igherm (Sous). *Traces Linguistiques et Semiotiques* 2: 53-78.

- Elmoujahid, E. 1982. Un aspect morphologique du non en Tamazight: l'état d'annexion. *Langue et Littérature* 2: 47-62.
- Fudge, E. C. 1969. Syllables. *Journal of Linguistics* 5: 253-286.
- Galland, L. 1988. Le Berbère. In Perrot, J (ed.). *Les Langues dans le Monde Ancien et Moderne. Troisième Partie- Les Langues Chamito-Sémitiques* (Textes Réunis par David Cohen): 207-242. Paris: Editions du CNRS.
- Gimson, A. C. 1989. *An Introduction to Pronunciation of English*. London: Arnold.
- Goldsmith, J. 1976. An overview of autosegmental phonology. *Linguistic Inquiry* 2: 23-68.
- Goldsmith, J. 1979. *Autosegmental Phonology*. New York: Garland Press.
- Goldsmith, J. 1990. *Autosegmental and Metrical Phonology*. Oxford: Basil Blackwell.
- Guerssel, M. 1977. A constraint on phonological rules. *Linguistic Analysis* 3: 267-305.
- Guerssel, M. 1978. A condition on assimilation rules. *Linguistic Analysis* 4: 225-254.
- Guerssel, M. 1985. The role of sonority in Berber syllabification. *Awal* 1: 81-110.
- Guerssel, M. 1986. Glides in Berber and syllabicity. *Linguistic Inquiry* 17, no. 1: 1-12.
- Guerssel, M. 1987. The status of lexical category preposition in Berber: implications for the nature of the construct state. In Guerssel M. and K. Hale (eds.). *Studies in Berber Syntax*, 159-190. *The Lexicon Project Working Papers 14*, Center for Cognitive Studies, MIT.

- Guerssel, M. 1992. The phonology of Berber derivational morphology by affixation. In *Linguistic Analysis*, vol. 22, no 1-2: 3-60.
- Halle, M. and J. R. Vergnaud. 1979. Metrical structure in phonology. Ms., MIT.
- Halle, M. and J. R. Vergnaud. 1980. Three dimensional phonology. *Journal of Linguistic Research* 1:83-105.
- Hannahs, SJ. 1995a. Glide formation, prefixation and the phonological word in French. *Contemporary research in Romance linguistics*, ed. by J. Amastae, G. Goodall, M. Montalbetti and M. Phinney, 13-14. Amsterdam: John Benjamins.
- Hannahs, SJ. 1995b. The phonological word in French. *Linguistics* 33:1125-1144.
- Hannahs, SJ. 1995c. *Prosodic Structure and French Morphology*. Tübingen: Niemeyer.
- Hannahs, SJ. 1998a. Unexceptional exceptions and French glides. LSRL 28, Penn State University, May 1998. Ms., University of Durham.
- Hannahs, SJ. 1998b. Characterizing French glides. Ms., University of Durham.
- Harris, J. 1994. *English Sound Structure*. Oxford: Blackwell.
- Hayes, B. P. 1989. Compensatory lengthening in moraic phonology. *Linguistic Inquiry* 20 :253-306.
- Hieke A. E. 1984. Linking Marker of fluent speech. *Language and Speech* 27/4: 343-354.

- Hyman, L. 1985. *A Theory of Phonological Weight*. Dordrecht : Foris.
- Iazzi, E. 1991. Morphologie du Verbe en Tamazight-(Paler des Ait Attab, Haut Atlas Central)-Approche Prosodique. D.E.S. Thesis, Mohammed V University, Faculty of Letters, Rabat.
- Jebbour, A. 1996. *Morphologie et contraintes prosodiques en bèrbère (Tachelhit de Tiznit) Analyse linguistique et traitement automatique*. Thèse pour le Doctorat d'Etat. Université Mohamed V, Faculté des lettres et des Sciences Humaines. Rabat: Maroc.
- Jebbour, A. 1999. Syllable weight and syllable nuclei in Tachelhit Berber of Tiznit. In *Cahiers de Grammaire* 24: 95-116.
- Kager, R. 1999. *Optimality Theory*. Cambridge University Press: Cambridge.
- Kahn, D. 1976. *Syllable-Based Generalization in English Phonology*. Bloomington, Indiana: Indiana University Linguistics Club.
- Kaye, D. and J. Lowenstamm. 1981. De la syllabicite. Ms, Université du Québec a Montreal and Tel Aviv University.
- Kenstowicz, M. J. 1994. *Phonology in Generative Grammar*. Blackwell Publishers: Oxford, UK
- Kenstowicz, M. , Y. Bader & R. Benkeddache. 1983. The phonology of state in Kabyle Berber. *African Linguistics: Essays in Momory of M. W. K. Semikenke*. (eds) Didier L Goyvaerts. John Benjamins Publishing: Amsterdam.
- Kenstowicz, M. & C. Pyle. 1973. On the integrity of geminate clusters. In

- Kenstowicz, M & C. W. Kisseberth (eds.). *Issues in Phonological Theory*, 27-43. The Hague: Mouton.
- Leben, W. 1980. A metrical analysis of length. *Linguistic Inquiry* 11, 497-509.
- Levin, J. 1985. *A Metrical Theory of Syllabicity*. MIT: doctoral dissertation.
- Louali, N. & I. Maddieson. 1999. Phonological contrast and phonetic realisation: the case of Berber stops. *Proceedings of The 14th International Congress of Phonetic Sciences, San Francesco*: 603-606.
- Maddieson, I. & K. Emmorey. 1985. Relationship between semivowels and vowels: cross-linguistic investigations of acoustic difference and coarticulation. *Phonetica* 42/4: 163-174.
- McCarthy, J. 2000. *The Fundamentals of Optimality Theory*. Ms. University of Massachusetts, Amherst.
- McCarthy, J & A. Prince. 1993a. Generalised Alignment. *Yearbook in Morphology*. Ed. By M. Eid and J. McCarthy, Amsterdam: Benjamins.
- McCarthy, J & A. Prince. 1993b. Prosodic morphology. Part 1: Constraint Interaction and Satisfaction. MS, University of Massachusetts, Amherst, and Rutgers University.
- McCarthy, J & A. Prince. 1994. The Emergence of the Unmarked: Optimality in Prosodic Morphology. *North East Linguistics Society* 24:333-379.
- Moktadir, K. 1989. *The Passive Form in Tashlhiyt Berber: A Prosodic Approach*. D.E.S dissertation. Mohamed V University, Faculty of Letters & Human Sciences, Rabat: Morocco.
- Nespor, M. & I. Vogel. 1982. Prosodic domain of external sandhi rules. In H. van

- der Hust & N. Smith (eds.) *The Structure of Phonological Representations (Part I)*. Dordrecht: Foris: 225-255
- Nespole, M. & I. Vogel. 1986. *Prosodic Phonology*. Dordrecht: Foris .
- Norris, H. T. 1982. *The Berbers in the Arabic Literature*. Beirut: Librairie du Liban.
- Ouakrim, O. 1994. 'Un parametre acoustique distinguant la gemination de la tension consonantique'. *Etudes et Documents Berbères* 11: 197-203.
- Penchoen, T. G. 1973. *Tamazight of the Ait Ndir*. Undena Publications, Los Angeles, California.
- Piggott, G. L. 1995. Epenthesis and syllable weight. *Natural Language and Linguistic Theory* 13, 283-326.
- Pike, K. L. 1943. *Phonetics*. Ann Arbor : University of Michigan Press.
- Prasse, K. G. 1972. *Manuel de Grammaire Touarègue (tahggart) I-III: Phonétique, écriture, pronom*. Copenhague: Edition de l'Université de Copenhague.
- Prasse, K. G. 1975. The Reconstruction of Proto-Berber Short Vowels. In Bynon, J. and T Bynon eds. *Hamito-Semitic* 1975: 215-231.
- Prince, A and P. Smolensky. 1993. *Optimality Theory: Constraint Interaction in Generative Grammar*. Rutgers U. and U. of Colorado, Boulder.
- Rea, J. A. 1979. The problem of the French semivowels. I. Rauch and G.F. Carr (eds.) *Linguistic Method Essays in Honor of Herbert Penzl*. The Hague: Mouton Publishers, 353-361.
- Rosenthal, S. 1994. *Vowel/Glide Alternation in a Theory of Constraint Interaction*. Ph.D. dissertation, University of Massachusetts, Amherst.

- Saib, J. 1976. A phonological study of Tamazight Berber: dialect of Ayt Nahir.
Ph.D. dissertation, University of California, Los Angeles.
- Saib, J. 1977. The Treatment of Geminates: Evidence from Berber. *Studies in African Linguistics* 8, 299-316.
- Saib, J. 1982. Initial vowel syncope and reduction in Tamzight-Berber nouns.
Langues et Litterature, II:159-183. Publications de la Faculté des lettres et des Sciences Humaines. Rabat, Maroc.
- Selkirk, E. 1978. On prosodic structure and its relation to syntactic structure. In T. Fretheim (ed.), *Nordic Prosody II*. Trondheim: TAPIR.
- Selkirk, E. 1980. The role of prosodic categories in English word stress. *Linguistic Inquiry* 11 (3): 563-605.
- Selkirk, E. 1982. The Syllable. In Hulst, H and N. Smith (eds.) *The Structure of Phonological Representations*, Part II. Dordrecht: Foris.
- Selkirk, E. 1984. *Phonology and Syntax*. Cambridge, Mass.: MIT Press.
- Sobkowiak, W. 1990. Hiatus-breaking glide insertion in English and Polish. In J. Fisiak (ed.). *Further Insights into Contrastive Analysis*. Amsterdam: John Benjamins, 225-275
- Spencer, A. 1996. *Phonology*. Blackwell Publishers Ltd, Oxford.
- Steriade, D. 1984. Glides and vowels in Romanian. *Berkley Linguistics Society* (BLS), 14: 47-64.