

Durham E-Theses

Synthesis and characterisation of hyperbranched polymers

BRUNELLA MARANESI

How to cite:

MARANESI, BRUNELLA (2017) Synthesis and characterisation of hyperbranched polymers. Doctoral thesis, Durham University.

Use policy

The full-text may be used and/or reproduced, and given to third parties in any format or medium, without prior permission or charge, for personal research or study, educational, or not-for-profit purposes provided that:

- a full bibliographic reference is made to the original source
- a <https://etheses.durham.ac.uk/id/eprint/12216/> is made to the metadata record in Durham E-Theses
- the full-text is not changed in any way

The full-text must not be sold in any format or medium without the formal permission of the copyright holders.

Please consult the [full Durham E-Theses policy](#) for further details.



Synthesis and characterisation of hyperbranched polymers.

Brunella Maranesi

Department of Chemistry
Durham University

September 2016

Thesis submitted in fulfilment for the degree of Doctor of Philosophy

Synthesis and characterisation of hyperbranched polymers.

Abstract

Hyperbranched polymers are a subclass of dendritic molecules characterised by a highly branched architecture. Such polymers are usually prepared in an easy and affordable one-pot synthesis and therefore are considered suitable for industrial large-scale applications such as coating and resins formulation.

Hyperbranched poly(ester amine)s (PEAs) and poly(amido amine)s (HPAMAMs) were synthesised by the double monomer methodology (DMM) with multifunctional monomers. The Michael addition reaction was used with an $A_2 + B_4$ methodology. The use of an $A_2 + B_4$ system has the advantage of producing hyperbranched polymers with a high number of functional terminal groups but also the disadvantage of (potentially) undergoing gelation due to the use of monomers with symmetric functionalities. Therefore a key project aim was the development of novel, simple, versatile and cost-efficient synthetic strategies to exclusively synthesise soluble (gel-free) hyperbranched polymers via the $A_2 + B_4$ system. It was also an objective of this work to (i) further modify/functionalise the chemical structure of the resulting hyperbranched polymers, (ii) understand the long-term (storage) stability of the synthesised polymers and (iii) explore potential industrial applications.

PEAs and HPAMAMs were synthesised by selecting suitable pairs of monomers (A_2 and B_4) with a molar ratio of $A_2:B_4$ which was higher than 1:1 ($A:B (>2):4$). The reactions studied show susceptibility to gelation and at long reaction times the formation of a cross-linked product or alternatively a sol-gel product was observed in many cases. In this latter case the relative amount of gel and soluble (sol) fraction was found to be dependent on the reaction conditions used such as monomer molar ratio, temperature and monomer solution concentration. A first strategy to produce exclusively soluble branched polymers involved the use of a large stoichiometric excess of A_2 monomer with respect to B_4 monomer and quenching the polymerisation after a certain time. It was observed that at a molar ratio $A_2:B_4$ of 3:1, highly branched and gel-free polymers were formed and after 24 hours (i) for HPAMAMs, a polymer with M_n 620 g/mol, M_w 10550 g/mol, \bar{D} 17.7 and degree of branching (DB) 0.98 was obtained in methanol/water at 40°C while (ii) for PEAs, a polymer with M_n 620 g/mol, M_w 1150, \bar{D} 1.8 and DB 0.45 was formed at 60°C in DMF. A novel alternative strategy was developed with the above-mentioned requirements, that enabled the synthesis of soluble branched polymers without the need to monitor and stop the reaction at a certain conversion of functional groups above which gelation occurs. Moreover, a variety of effective and versatile strategies for the modification of the basic polymer skeleton of HPAMAMs were explored.

The stability of PEAs was studied in methanol and evidence of degradation was found both by SEC analysis and NMR spectroscopy. It was shown that degradation occurred via cleavage of the ester group of the polymer catalysed by the amine groups within the same structure. The stability of HPAMAMs towards degradation was instead studied in water and a good long-term stability both in dilute and in concentrated solution was observed by SEC analysis and NMR spectroscopy. However, HPAMAMs underwent chain-coupling in water which did lead in some cases to gelation. Polymers were hence modified in order to reduce the risk of gelation.

The properties of the HPAMAMs polymers synthesised by $A_2 + B_4$ system were finally investigated and proved to be of potential commercial utility in certain industrial applications.

Acknowledgements

I would like to express my sincere gratitude and special thanks to my supervisor Prof Lian Hutchings for giving me the wonderful opportunity of coming to Durham and conducting my PhD research under his instruction. The guidance, support and patience in repeating explanations and most of all inspiration on both a personal and professional level were invaluable.

I thank Croda, in particular my industrial supervisor Dr David Freeman for the opportunity to undertake this research and allowing me to spend time at Croda. I would also like to thank other people from Croda who were part of this project: Dr Stuart Little, Dr Simon Hodgson and Dr Kathryn Knight. Further thanks go to Caroline Freier for her kind help during my visits to Croda Cowick and Mathew Fazakerley, Emma Bullough and Natalie Hodgson who helped me during the sample testing.

I would like to express thanks to Durham University academic and non-academic staff in the Department of Chemistry, in particular Dr Alan M. Kenwright and Dr David Apperley of the Solution State NMR and the Solid State NMR services respectively for the numerous explanations and advice in the interpretation of my data. I would also like thank Dr Juan A. Aguilar Malavia, Mrs Catherine Hefferman and Dr Raquel B. Vidal from the Solution State NMR service for their kindness and help in analysing my samples and above all for their friendship.

Thanks to all present and past members of the Hutchings research group including Paul, Serena, Gabriele, Tatiana, Matthew, Roberto, Oliver, Jonathan and Natasha, and all my friends from office CG156 and CG162 for the good times spent together. I also thank all my Italian friends in Durham for the marvellous time together and our social Sunday dinners, my best friend Fabiana and all my Durham friends in the Department of Chemistry and outside the university that have contributed to make my experience in Durham unforgettable.

Special thanks also go to my family: Lino, Anna, Emidio and Paolo whose great enthusiasm for what I do, and what I have done, has been a great help despite not understanding what I am working on most of the time!

Memorandum

The work reported in this thesis was carried out in the Department of Chemistry, Durham University, between October 2012 and December 2015. This work has not been submitted for any other degree in Durham and is the original work of the author except where acknowledged by means of appropriate reference.

Signed: _____

Date: _____

Statement of Copyright

The copyright of this thesis rests with the author. No quotation from it should be published without the author's prior written consent and information derived from it should be acknowledged.

Financial Support

I gratefully acknowledge Corda Int. for their funding of this research.

Table of contents

Abstract	i
Acknowledgments	ii
Memorandum	iii
Statement of Copyright	iii
Financial Support	iii
Contents	iv
List of Abbreviations	viii

CHAPTER 1 1

1.1 Polymer: definitions and synthesis'	2
1.1.1 Step-growth polymerisation: molecular weight control and multi-chain polymerisation	5
1.2 Hyperbranched Polymers.....	10
1.2.1 Synthetic strategies	11
1.2.1.1 Hyperbranched polymers using the single monomer method (SMM)	13
1.2.1.1.1 Step-growth polycondensation and polyaddition reactions.....	13
1.2.1.1.2 Chain-growth polymerisation.....	15
1.2.1.1.2.1 Self-condensing vinyl polymerisation (SCVP)	15
1.2.1.1.2.2 Self-condensing ring-opening polymerisation	16
1.2.1.1.2.3 Proton-transfer polymerisation	16
1.2.1.2 Synthesis of hyperbranched polymers using a double monomer method	17
1.2.1.2.1 Polymerisation via Michael Addition reactions	21
1.2.1.3 Synthetic strategies to control of the structure and the molecular weight of hyperbranched polymers	24
1.2.2 Structural Characterisation of Hyperbranched Polymers	28
1.2.2.1 Degree of Branching	28
1.2.2.2 Molar mass and molar mass distribution	30
1.2.3 Functionalisation of hyperbranched polymers: synthetic strategies.....	33
1.2.4 Properties and applications of hyperbranched polymers	36
References.....	38

CHAPTER 2 42

2.1 Aim of the project.....	43
References.....	44

CHAPTER 3 45

3.1 Hyperbranched poly(ester amine)s by double monomer methodology (DMM) via aza-Michael addition reaction: state of art.	46
3.2 Rationale and aim of the study	51
3.3 Experimental part	53

3.3.1	Materials and reagents.....	53
3.3.2	Characterisation techniques.....	54
3.3.3	Synthesis of the hyperbranched poly(ester amine)s.....	55
3.3.4	Stability Tests.....	61
3.4	Results and Discussion.....	61
3.4.1	Synthesis of hyperbranched poly(ester amine) by “A ₂ +B ₄ ” strategy.....	62
3.4.1.1	Hyperbranched poly(ester amine) from PEGDA and HDA/EDA monomers: structural characterisation.....	63
3.4.1.2	Hyperbranched poly(PEGDA-HDA) - PEA1: effect of A ₂ :B ₄ molar ratio. ...	69
3.4.1.3	Synthesis of PEA1-1.5: effect of temperature.	74
3.4.1.4	Synthesis of PEA1-1.5: effect of solution concentration.....	75
3.4.1.5	Hyperbranched poly(PEGDA-EDA) – PEA2: effect of a shorter aliphatic spacer.....	77
3.4.2	Synthesis in solution (DMF) of hyperbranched poly(ester amine) by “A ₂ +A+B ₄ ” strategy.	81
3.4.2.1	A-monomer introduced post-polymerisation.....	83
3.4.2.2	A-monomer introduced as starting monomer.	84
3.4.2.2.1	Synthesis of hyperbranched poly(ester amine) with methyl methacrylate (MMA) monomer as A-monomer.....	85
3.4.2.2.2	Synthesis of hyperbranched poly(ester amine) with methyl acrylate (MA) monomer as A-monomer.....	87
3.4.3	Hyperbranched PEAs: stability.	93
3.4.3.1	Stability in methanol: hyperbranched and linear PEAs.....	93
3.4.3.2	Synthesis and stability of hydrochloride poly(ester amine)s – PEA5.	98
3.4.3.2.1	Synthesis of PEA5.....	100
3.4.3.2.2	Stability in methanol of the PEA5.....	104
3.5	Conclusions.....	105
	References.....	109

CHAPTER 4 111

4.1	Hyperbranched poly(amido amine) via Michael addition reaction: state of art...112
4.2	Aims of the current work117
4.3	Experimental part.....118
4.3.1	Materials and reagents.....118
4.3.2	Characterisation techniques.....119
4.3.3	Synthesis of hyperbranched poly(amido amine)s.121
4.3.4	Stability test.....125
4.4	Results and Discussion.....126
4.4.1	Synthesis of hyperbranched poly(MBA-EDA)s HPAMAM 1 via aza-Michael addition.....127
4.4.1.1	Structure and characterisation of the polymer128
4.4.1.2	Effect of the molar feed ratio on the polymerisation reaction130
4.4.1.3	Polymerisation MBA-EDA (HPAMAM 1) with molar ratio 3:1137
4.4.1.3.1	Synthesis of HPAMAM 1.5, HPAMAM 1.8 and HPAMAM 1.10: effect of the temperature.....137
4.4.1.3.2	Synthesis of HPAMAM 1 with molar ratio A ₂ :B ₄ of 3:1: effect of the time and reproducibility of the reactions.140
4.4.1.3.3	Synthesis of HPAMAM 1.9 with Arlasolve™ as solvent.....146
4.4.1.4	Stability of the HPAMAM 1.7 upon storage.149

4.4.1.4.1	Stability of the polymer in aqueous solutions.	149
4.4.1.4.2	Stability of the bulk polymer in vacuo.	155
4.4.1.4.3	Stability of the bulk polymer in desiccator at different relative humidity.....	156
4.4.2	Modifying the structure of the B ₄ monomer to tailor the chemical properties of the hyperbranched poly(amido amine) polymers.	159
4.4.2.1	EOBEA as B ₄ monomer	159
4.4.2.2	Priamine™ as B ₄ monomer.....	162
4.5	Conclusions	171
	References.....	173

CHAPTER 5 175

5.1	Modification of hyperbranched poly(amido amine)s-the current state of the art.	176
5.2	Aims of the current work	178
5.3	Experimental	181
5.3.1	Materials.....	181
5.3.2	Characterisation techniques.....	181
5.3.3	Polymer synthesis.....	183
5.4	Results and Discussion.....	187
5.4.1	Synthesis of end-capped hyperbranched poly(amido amine)s by A ₂ +A+B ₄ strategy	187
5.4.1.1	Structure and characterisation.....	189
5.4.1.2	Synthesis of HPAMAMs 1.A: effect of the mole fraction of the A-monomer on the molecular weight of the polymer.....	193
5.4.1.3	Stability of the end-capped polymers HPAMAMs 1.A in water.....	195
5.4.2	Functionalisation of the hyperbranched poly(amido amine)s via the A ₂ +B ₄ +C strategy	198
5.4.3	Synthesis of cationic hyperbranched poly(amido amine).	205
5.4.3.1	Direct polymerisation: A ₂ +B ₄ ·2HCl strategy	206
5.4.3.2	Post-polymerisation: amine alkylation reaction.....	209
5.5	Conclusions	212
	References.....	213

CHAPTER 6 215

6.1	Introduction: properties and potential applications of hyperbranched poly(amido amine)s.	216
6.2	Aim	217
6.3	Experimental part	218
6.3.1	Materials.....	218
6.3.2	Methods.....	219
6.4	Results and discussion	222
6.4.1	Hyperbranched poly(3MBA-1EDA)–HPAMAM1:properties and application	223
6.4.1.1	Crop Care Application	227
6.4.1.1.1	<i>Effect of the HPAMAM 1 polymer on droplet formation</i>	228
6.4.1.1.2	<i>Coating for seeds</i>	229
6.4.1.2	Personal care	231
6.4.1.2.1	<i>Co-surfactant agent</i>	231
6.4.2	Hyperbranched poly(3MBA-1Priamine™) – HPAMAM 3: properties and applications.....	232

6.4.2.1 Geo Technologies	233
6.4.2.1.1 Demulsifying agent	234
6.4.2.1.2 Flow improver	236
6.4.2.1.3 Asphaltene dispersant and inhibitors.	239
6.4.2.2 Lubricants	242
6.5 Summary of the results.....	247
Reference	248
CHAPTER 7	251
<hr/>	
6.1 Summary and conclusion of the work.....	252
6.2 Future work	255
Reference	257
APPENDIX A	258
<hr/>	
APPENDIX B	263
<hr/>	
APPENDIX C	267
<hr/>	

List of Abbreviations

A _i	monomer with i functional groups A-type
AAIs	agrochemical active ingredients
A _x B _y	monomer or polymer specie with x functional groups A-type and y functional groups B-type
ADs	asphaltene dispersants
AEPZ	1-(2-aminoethyl) piperazine
AIs	asphaltene inhibitors
AMPZ	4-(aminomethyl)piperidine
APD	3-amino-1,2-propanediol
API	1-(3-aminopropyl) imidazole
ATRP	atom transfer radical polymerisation
B	branched unit
B _i	monomer with i functional groups B-type
BA	n-butylamine
BAP	N,N'-bisacryloylpiperazine
BDDA	1,4-butanediol diacrylate
BHT	butylated hydroxytoluene
Bis-MPA	2,2-bis(hydroxymethyl)propionic acid
BPGE	bisphenol diglycidyl ether
c	concentration
CA	contact angle
CBA	N,N'-cystaminebisacrylamide
CC	conventional calibration
CDCl ₃	deuterated chloroform
CHCl ₃	chloroform
CMM	coupled monomer methodology
COF	coefficient of friction
CP	cross polarisation
cP	centipoise
CYST	cystamine
δ	chemical shift
Đ	dispersity
DCM	dichloromethane
DEA	dimethylamine
DED	N,N-dimethylethylenediamine
DETA	diethylenetriamine
DMA	dimethylacetamide
DMAP	4-(dimethylamino)pyridine
DMDPTA	N,N-dimethyldipropylenetriamine
DMF	N,N-dimethylformamide
DMI	dimethyl isosorbide
DMM	double monomer methodology
DMSO	dimethyl sulfoxide
DMSO-d ₆	deuterated dimethyl sulfoxide
DNA	deoxyribonucleic acid
dn/dc	specific refractive index increment
D ₂ O	deuterium oxide
ΔT	transmittance variation
EDA	ethylenediamine
EEDA	N-ethylethylenediamine
EGDA	ethylene glycol diacrylate
EOBEA	2,2'-(ethylenedioxy)bis(ethylamine)
f _i	number of functional groups of the i-monomer
φ	volume fraction occupied by the polymer in solution
F _N	nominal load
GMO	glycerol mono-oleate
GTA	glycerol triacrylate
GTEMPO	4-glycidol-2,2,6,6-tetramethyl-piperidin-1-oxyl
η	intrinsic viscosity

HCl	hydrochloric acid
HDA	hexamethylenediamine
HDDA	1,6-hexanediol diacrylate
HDCC	hexamethylenediamine dihydrochloride
HEDA	N-hexylethylenediamine
HFRR	high frequency reciprocating rig
HMBA	N,N'-hexamethylenebisacrylamide
HMBC	heteronuclear multiple bond correlation
HMW	high molecular weight
HPAMAMs	hyperbranched poly(amido amine)s
HPAMAM 1	hyperbranched poly(MBA-EDA)
HPAMAM 2	hyperbranched poly(MBA-EODEA)
HPAMAM 3	hyperbranched poly(MBA-Priamine™)
HPAMAM 4	hyperbranched poly(MBA-HDDC)
HPAMAM 5	alkylated hyperbranched poly(MBA-EDA)
HPAMAM 1.A	hyperbranched poly(MBA-EDA-MPAM)
HPAMAM 1.C	hyperbranched poly(MBA-EDA-Glissopal)
HSQC	heteronuclear single quantum coherence
HYD	hydrazine
Hz	hertz
ID	interrupted decoupling
IFT	interfacial tension
IV	intrinsic viscosity detector
L	linear unit
λ	wavelength of incident light
LC-MS	liquid chromatography–mass spectroscopy
LiBr	lithium bromide
LiCl·H ₂ O	lithium chloride hydrate
LLDPE	linear low density polyethylene
LS	light scattering
M _i	molar mass of the i-monomer unit
M _n	number-average molecular weight
M _p	peak molecular weight
M _w	weight-average molecular weight
MA	methyl acrylate
MAA	methacrylic acid
MALLS	multiangle light scattering
MBA	N,N'-methylene bisacrylamide
MEDA	N-methylethylenediamine
MEHQ	monomethyl ether hydroquinone
MeOH	methanol
MeP	2-methylpiperazine
Mg(NO ₃) ₂ ·6H ₂ O	magnesium nitrate hexahydrate
MMA	methyl methacrylate
MTM	mini traction machine
MW	molecular weight
n	refractive index
N _A	Avogadro's number
N _i	number of mole of the i-monomer
N-Gal	galactosamine
NMP	N-methyl-2-pyrrolidone
NMR	nuclear magnetic resonance
p	extent of the reaction
PAMAM	polyamidoamine
PAO	poly(alpha olefine)
PEAs	poly(ester amine)s
PEA1	hyperbranched poly(PEGDA-HDA)
PEA2	hyperbranched poly(PEGDA-EDA)
PEA3	hyperbranched poly(PEGDA-MMA-HDA)
PEA4	hyperbranched poly(PEGDA-MA-HDA)

PEA5	hyperbranched poly(PEGDA-MA-HDDC)
PEG	polyethylene oxide
PEGDA	poly(ethylene glycol) diacrylate
PEI	polyethylenimine
PEO	polyethylene oxide
PET	poly(ethylene terephthalate)
PIB	polyisobutylene
PIBSA	polyisobutylene succinic anhydride
P ₂ O ₅	phosphorus pentoxide
PP	pour point
PS	polystyrene
PTP	proton-transfer polymerisation
r	stoichiometric ratio
R _g	radius of gyration
R _θ	Rayleigh factor
RAFT	reversible addition–fragmentation chain transfer
RALS	right angle light scattering
RH	relative humidity
RI	refractive index detector
ROMP	ring-opening metathesis polymerization
RT	room temperature
σ	surface tension
SCROP	self-condensing ring-opening polymerisation SMM single monomer methodology
SCVP	self-condensing vinyl polymerisation
SEC	size exclusion chromatography
SPA	magic-angle spinning
SRR	slide roll ratio
T	terminal unit
t	time
TAEA	tris(2-aminoethyl)amine
TD	triple detectors (RI-IV-LS) calibration
TDA	trimethylene diamine
TEA	triethylamine
TEPA	tetraethylenepentamine
TETA	triethylenetetramine
THF	tetrahydrofuran
TMA	tricarboxylic acid
TMPETA	trimethylolpropane ethoxylate triacrylates
TMPTA	trimethylolpropane triacrylate
TT	triacrylamide
UV	ultraviolet
V	sliding velocity
X	degree of polymerization

Chapter 1

Introduction

1.1 Polymer: definitions and synthesis^{1,2}

The term polymer refers to a macromolecule constructed from monomeric units which are covalently bonded together through a process of polymerization. The number of units in a polymer chain is defined by the degree of polymerization (X):

$$X = \frac{M}{M_0} \quad \text{Equation 1.1}$$

where M is the polymer molar mass and M_0 the molar mass of the monomer units. The degree of polymerisation is hence related to the chain length and the molecular weight of the polymer. Since the growth of the chains is often complex and uncontrolled, polymers contain chains of varying length; in this way the average degree of polymerization (\bar{X}) is used. Consequently, polymers do not have an exact molar mass but a distribution of molar masses; hence it is possible to express statistically the molecular weight as either;

- i. number-average molecular weight (M_n)

$$\langle M \rangle_n = \frac{\sum N_i M_i}{\sum N_i} \quad \text{Equation 1.2}$$

- ii. weight average molecular weight (M_w)

$$\langle M \rangle_w = \frac{\sum N_i M_i^2}{\sum N_i M_i} \quad \text{Equation 1.3}$$

where N_i is the number of molecules of species i of molar mass M_i . A schematic distribution of molar masses is reported in Figure 1.1.

The breadth of a molecular weight distribution is described by the dispersity, \mathcal{D} , defined as follows:

$$\mathcal{D} = \frac{M_w}{M_n} \quad \text{Equation 1.4}$$

This parameter provides an idea about the heterogeneity in molar mass of a polymer. Polymer samples whose chains all have the same length are called monodisperse polymers. In this case, $M_w = M_n$ and therefore $\mathcal{D} = 1$. On the other hand, polymers whose chains have different lengths are called polydisperse polymers. For these polymers, $M_w > M_n$ and therefore $\mathcal{D} > 1$. In general, biopolymers, such as proteins, are more homogeneous than synthetic polymers and \mathcal{D} is usually unity and such polymers can be considered monodisperse. For synthetic polymers, M_w is always greater than M_n and therefore the \mathcal{D} is always greater than one. In this latter case, the dispersity varies according to the mechanism of the polymerisation used.

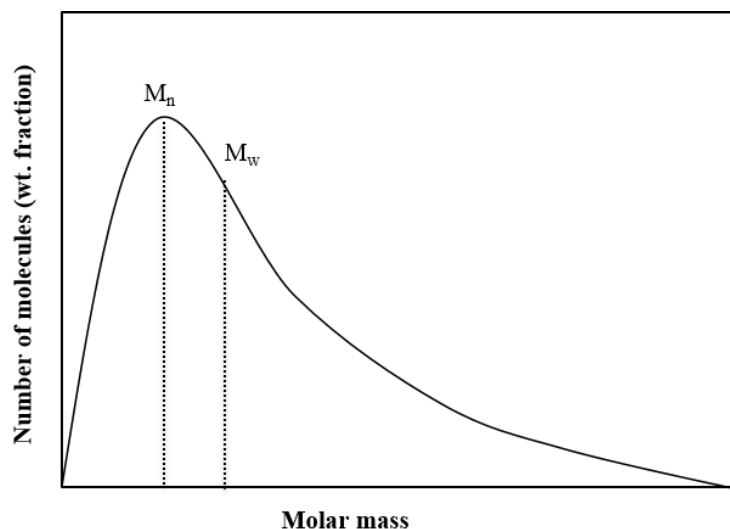

Figure 1.1 Schematic distribution of molecular weight for a synthetic polymer.

It is possible to classify polymerization reactions into two groups: chain-growth and step-growth polymerizations. The former involves the growth of a polymer chain by a chain reaction while the latter is a stepwise reaction of polyfunctional monomers. Both reactions may lead to the formation of linear polymer, branched or polymer networks since the architecture of the polymer is established by the number of reactive entities per monomer.

Chain-growth polymerisation

Chain-growth polymerization usually involves monomer molecules having a double bond with the general structure $\text{H}_2\text{C}=\text{CR}_1\text{R}_2$. The opening of the double bond, commonly by the activation of free-radical or ionic initiators makes these monomers bifunctional. The complete chain-growth reaction proceeds through three steps:

- i. Initiation – involving the formation of the active centre (radical, anion or cation) from the reaction between the initiator or catalyst with the first monomer unit.

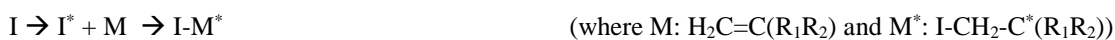

- ii. Propagation – describing the growth of the chain through the successive addition of monomers to the active centre which is exclusively carried at the chain end.

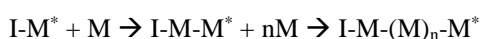

- iii. Termination – where the growth of the chain is terminated by the deactivation of the propagating centre.

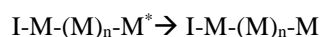

In general, the chain growth polymerisation reaction is called free-radical polymerization when it proceeds via reaction of radicals; anionic or cationic polymerization when it proceeds via reaction with ions and coordination polymerization when the monomer adds to a growing chain

through an organometallic active centre. Coordination polymerization includes metallocene, Ziegler-Natta and ring-opening metathesis polymerization (ROMP).

Numerous polymers are prepared by a chain-growth mechanism and common examples include; (high and low density polyethylene, poly(vinyl chloride), polystyrene, poly(ethylene oxide), polyisoprene and poly(methyl methacrylate)

Step-growth polymerisation

In contrast to chain-growth polymerisation in which the monomer (usually) contains an unsaturated bond, in step-growth polymerisation, each monomer must have at least two functionalities since the polymerisation involves successive reactions between mutually reactive functional groups on the monomers. Thus, two monomers react to form a dimer; a dimer similarly may react with a monomer to form a trimer or combine with another dimer to form a tetramer:



The reaction proceeds without the use of an initiator but often a catalyst is required. Each reaction of this process is carried out essentially at the same reaction rate and with the same mechanism until a mixture of polymer chains of high molecular weight is produced. Consequently the growth of chains is random and slow.

Step-growth polymerization can occur by:

(i) using two polyfunctional monomers, each of which has only one type of functional group:

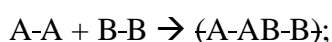

(ii) using a single monomer with more than one type of functional group: $nA-B \rightarrow \{AB\}_n$.

Moreover, the number of reactive sites per monomer dictates the final architecture of the polymer; therefore bifunctional monomers lead to the formation of linear polymers while multi-functional monomers to branched or crosslinked polymers.

The reactions in a step-growth polymerization can be either condensation (with the elimination of a by-product) or addition reactions (without the elimination of by-product).

Commercial step-growth polymers include: Nylon-11, Nylon-6,6, poly(ether ether ketone), poly(ethylene terephthalate), polycarbonate and polyurea.

Step-growth polymerisation differs from chain-growth polymerisation in the relationship between polymer molecular weight and monomer conversion. For instance, radical chain-growth polymerizations forms polymers with high molecular weight at low monomer

conversion while by step-growth polymerisation, high molar masses can be obtained only near the very end of the reaction (>99% conversion) (Figure 1.2). Thus both polymer size and the amount of polymer are dependent on conversion in step polymerization.

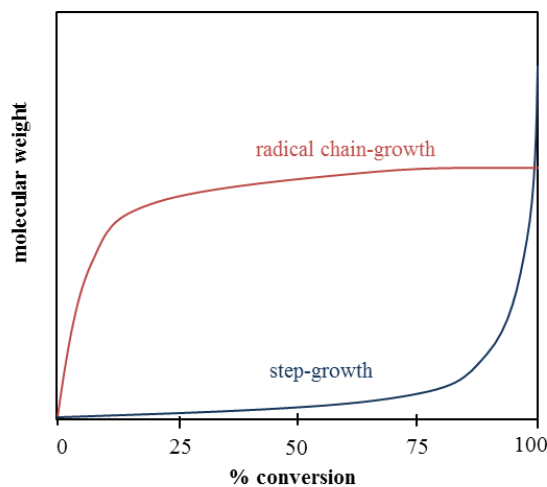

Figure 1.2 Variation of molecular weight with conversion by radical chain-growth polymerization (red trace) and step polymerization (blue trace).

1.1.1 Step-growth polymerisation: molecular weight control and statistical approach to gelation

The molecular weight of a polymer is an important parameter because it determines, to a large extent, the final properties. Polymers with high molecular weight can only be obtained by step-growth polymerisation (i) at high monomer conversion (>99 %, Figure 1.2); (ii) in the absence of side reactions (e.g. cyclization); (iii) when the functional groups A and B are accessible and the ratio of A:B is equal to 1.0 and (iv) with high degree of monomer purity³.

The number-average degree of polymerization (\bar{X}_n) in a step-growth polymerisation, defined as the average number of structural units per polymer chain, is related to the extent of reaction (p) by Carothers' equation. For a linear polymer obtained from the reaction of two difunctional monomers in equimolar quantities^{2,3};



the extent of the reaction (p) can be defined as the ratio of the number of reacted molecules at a given stage of the polymerisation (N) to the initial total number of molecules (N_0 , where $N_0 = N_A + N_B$):

$$p = \frac{N_0 - N}{N_0} \quad \text{Equation 1.5}$$

$$N = N_0(1-p) \quad \text{Equation 1.6}$$

The degree of polymerisation defined in Equation 1.1 can be also described as the ratio between the initial number of molecules and the remaining number of molecule:

$$\bar{X}_n = \frac{N_0}{N} \quad \text{Equation 1.7}$$

Thus, for a linear polymer the Carothers equation is:

$$\bar{X}_n = \frac{N_0}{N_0(1-p)} = \frac{1}{1-p} \quad \text{Equation 1.8}$$

This equation proves numerically, the trend of the molecular weight with monomer conversion in Figure 1.2. In fact a value of $p = 0.98$ is required to obtain a polymer with $\bar{X} = 50$ and p of 0.99 is required for $\bar{X}_n = 100$; therefore a high monomer conversion is required to achieve a high degree of polymerization.

The situation undergoes a change and Carothers equation needs to be modified, when linear polymers are synthesised with a stoichiometric imbalance of monomers A-A and B-B. In this case, the stoichiometric ratio (r) of the two reactants has to be taken into account (the excess reactant is conventionally the denominator so that $r < 1$) and Equation 1.8 becomes:

$$\bar{X}_n = \frac{1+r}{1+r-2rp} \quad \text{Equation 1.9}$$

This equation reduces to the equimolar case above when neither monomer is an excess and $r = 1$. The stoichiometric imbalance can be used strategically to control the degree of polymerisation. When the limiting reagent monomer is fully converted $p \rightarrow 1$ and:

$$\bar{X}_n \rightarrow \frac{1+r}{1-r} \quad \text{Equation 1.10}$$

With a monomer excess of 1%, $r = 0.99$ and $\bar{X}_n = 199$, instead of infinity for the equimolar case. Alternatively, the degree of polymerisation and hence the molecular weight can be controlled by introducing a mono-functional monomer bearing a single A or B functional group. In this case, the stoichiometric ratio is defined according to the Equation 1.11 if the mono-functional end group has the same functionality of B-B monomer.

$$r = \frac{N_{AA}}{N_{BB} + 2N_B} \quad \text{Equation 1.11}$$

In order to obtain end-capped polymers with a B-monomer, the total number of moles of B functional groups must be equal to the number of moles of A functional groups:

$$N_{BB} + N_B = N_{AA} \quad \text{Equation 1.12}$$

Branched polymers can be produced when one of the two monomers has a number of functional groups greater than two per molecule^{2,4}; e.g. the systems (A-A + B_f), (A-A + B-B + B_f) and (A_f + B_f) with A_f, B_f > 2. However, the use of such polymerisation systems is also able to generate a cross-linked structure. Therefore the polymerisations would not only lead to the formation of a soluble branched polymer (sol fraction) but also to a cross-linked and hence insoluble polymer (gel fraction). The point in the polymerisation at which the polymer starts forming a cross-linked structure and one can observe the formation of an insoluble gel is called the gel point. As the polymerisation proceeds beyond the gel point, the sol fraction decreases in favour of the gel fraction and eventually only a gel product can be recovered as the final product.

In order to prevent the cross-linking reaction, it is important to understand the relationship between gelation and the extent of reaction. In this case, the degree of polymerisation takes into account the average functionality f_{avg} of the system chosen for the polymerisation and the Carothers equation becomes^{2,5}:

$$\bar{X}_n = \frac{2}{2-p \cdot f_{avg}} \quad \text{Equation 1.13}$$

Equation 1.13 is only valid for systems with a stoichiometric ratio of functional groups; $N_A f_A = N_B f_B$ (N is the number of moles and f the number of functional groups). A negative value of \bar{X}_n in the calculation corresponds to the situation in which the system is past the gel point at that conversion.

The average functionality is defined as the average number of functional groups per monomer molecule:

$$f_{avg} = \frac{\sum N_i \cdot f_i}{\sum N_i} \quad \text{Equation 1.14}$$

where N_i is the number of molecules of monomer i with functionality f_i .

The extent of the reaction p for a system containing equivalent numbers of A and B groups can be instead defined as the fraction of functionalities lost:

$$p = \frac{2(N_0 - N)}{N_0 \cdot f_{avg}} \quad \text{Equation 1.15}$$

where $(N_0 \cdot f_{avg})$ is the ratio between the initial total number of functional groups and $2(N_0 - N)$ the number of functional groups that have reacted (2 functional groups are consumed for each

reaction). Rearranging equations 1.14 and 1.16 allows the extent of the reaction to be described as:

$$p = \frac{2}{f_{\text{avg}}} - \frac{2}{\overline{X}_n \cdot f_{\text{avg}}} \quad \text{Equation 1.16}$$

At the gel point, the number-average degree of polymerization (\overline{X}_n) becomes infinite and the equation 1.17 can be simplified as:

$$p_c = \frac{2}{f_{\text{avg}}} \quad \text{Equation 1.17}$$

where p_c is the critical extent of the reaction at the gel point for a system with a stoichiometric ratio of functional groups. For instance, for the system $A_2 + B_3$ (e.g. phthalic acid and glycerol) with a molar ratio $A_2:B_3$ of 3:2, a critical extent of the reaction of 0.833 can be calculated. More complex is the case of a non-stoichiometric reactant mixture: $N_A f_A \neq N_B f_B$ (e.g. $A_2 + B_3$ with molar ratio $A_2:B_3$ of 5:1). In this case, a large stoichiometric imbalance leads to the formation of low molecular weight species and the polymerisation ends up with a large number of unreacted functional groups of the reactant in excess. Therefore, for such mixtures, the deficient reactant dictates the value of the extent of polymerization (Equation 1.17). Pinner in 1956 deduced the average functionality of non-stoichiometric mixtures, as shown in Equation 1.18⁶ where for a system with monomers A and B in which B is the limiting reagent, f_{avg} can be defined as:

$$f_{\text{avg}} = \frac{2(N_B \cdot f_B)}{N_A + N_B} \quad \text{Equation 1.18}$$

For the system $A_2 + B_3$ with molar ratio $A_2:B_3$ of 5:1, a f_{avg} of 1.00 (6/6) can be calculated using Equation 1.18. It is worth noting that the calculation of f_{avg} using Equation 1.14 would lead for such system to an overestimation ($f_{\text{avg}} = 2.17$) because the reactant in excess is also taken into account in this case. The low f_{avg} (equal to 1.00) obtained for the $5A_2 + 1B_3$ system with the Equation 1.18 is indicative of a low degree of polymerisation. In fact from the Equation 1.16, for $p = p_B = 1$ (full conversion of B groups with B defined as the reactant not in excess), a degree of polymerisation, $\overline{X}_n = 2$ can be calculated. Therefore, the $5A_2 + 1B_3$ system never reaches gelation and the Equation 1.17, used for the estimation of the critical extent of the reaction, is never satisfied.

The stoichiometric imbalance of the two monomers is a further strategy which can be used to inhibit gelation by shifting the gel point to a higher extent of reaction. For an $A_2 + B_3$ system, it has been found that when the ratio of functional groups A/B is 2:3 i.e. a stoichiometric ratio of

the two monomers, gelation results at a critical conversion of A groups of 0.833 while for the same $A_2 + B_3$ system, when the ratio of functional groups A/B equals 1:2 (analogous to an AB_n system) gelation is avoided up to a conversion of $0.950^{2,4}$.

Another approach to predict the extent of reaction at the gel point is based on the models proposed by Flory and Stockmayer. This model considers the \overline{X}_w (weight-average molecular weight, $\overline{X}_w = \frac{M_w}{M_0}$) that approaches infinite size. In a nonlinear polymerisation system such as $A_2 + B_3$ a branching coefficient, α , is defined as the probability that a given functional group of a branch unit (B_3) is linked to another branched unit. In general, α can be calculated from the ratio of A and B functional groups and the extent of reaction at a given time. In the case of an $A_2 + B_3$ polymerisation, $\alpha = r \cdot p_A^2 = p_B^2 / r$, where r is the ratio of A to B functional groups (r must be always less than or equal to 1), p_A and p_B are the probability that the fractions of A (or B) groups have reacted with B (or A) groups. Another important parameter is the critical branching coefficient α_c which defines the branching coefficient at the gel point. For a give r value, α increases as a function of the extent of reaction reaching α_c . The critical branching coefficient α_c can be calculated as follow: $\alpha_c = 1 / (f-1)$, where f is the functionality of the monomer with greater functionality, when there are only two monomers taking part in the polycondensation reaction; so, if $f = 3$ then $\alpha = 0.5$; if $f = 4$ then $\alpha = 0.33$, etc. When $\alpha = 0$ there is no reaction and when $\alpha \geq 1$ the system never gels. For the most general case of a polycondensation system in which are present (1) monomers bearing reactive functional groups A with a degree of functionality between 1 and i and (2) monomers bearing functional groups B with a degree of functionality between 1 and j , the degree of conversion at the gel point is given by the following equation: $p_{gel} = \frac{1}{\sqrt{r(f_A-1)(f_B-1)}}$ where f_A and f_B are the weight average

functionalities of the reactive molecules A and B given by respectively ($f_A = \frac{\sum f_{Ai} \cdot N_{Ai}}{\sum f_{Ai} \cdot N_{Ai}}$ and $f_B = \frac{\sum f_{Bj} \cdot N_{Bj}}{\sum f_{Bj} \cdot N_{Bj}}$). It should be noted that the Flory and Stockmayer theory is based on the following

assumptions: (i) all groups have the same reactivity and they cannot react with each other, i.e. A can only react with B and vice versa (ii) the reactivity of all identical functional groups is the same and independent of molecular size and (iii) no intramolecular reactions occur between functional groups on the same molecule i.e. no cyclisation reactions.

A comparison between the Carothers and the Flory-Stockmayer equations for the calculation of the extent of reaction at the gel point, reveals that the Carothers's equation yields a value of p_c which is too large, by taking into account when the number-average degree of polymerization

\overline{X}_n becomes infinite. In reality, polymer molecules larger than \overline{X}_n are present in the reaction mixture and the system will reach the gel point earlier than predicted by assuming that gelation occurs when \overline{X}_n becomes infinite. The statistical treatment adopted by Flory-Stockmayer, theoretically overcomes this error, since it predicts the extent of reaction at which the polymer size distribution curve first extends into the region of infinite size. However, while the Carothers equation predicts values of p_c which are too high, the Flory-Stockmayer approach always underestimates such values compared to the experimental results, by disregarding the occurrence of intramolecular cyclization and unequal functional group reactivity. Experimentally, the gel point is usually determined as that point in the reaction at which the reacting mixture loses fluidity, and experimental observations of the gel point in a number of systems have shown that the observed p_c values fall approximately midway between the two theoretical values calculated by the Carothers equation and the Flory-Stockmayer approach⁴.

In this section it has been described the effect of the ratio of reactants, monomer functionality and conversion on the polymerisation reaction and the resulting final product, other parameters such as the solubility of the resulting product (linear or branched) and the polymerisation solvent, if used, can influence the molecular weight of the polymer produced. Thus, polymer chains must not precipitate from the reaction mixture during polymerisation if the desired molecular weight is to be reached. Premature precipitation effectively removes the growing polymer molecules from the reaction and further growth is prevented. On the other hand the choice of solvent may impact upon the rate of polymerization and resulting molecular weights because of the solvation or other specific interactions with either the reactants or transition state of the reaction or both. In particular, polar solvents enhance the rate of a polymerization with a transition state more polar than the reactants and vice versa.

1.2 Hyperbranched Polymers

Polymers can be classified into three groups according to their molecular architecture; (i) linear, (ii) branched and (iii) cross-linked⁷. In this section, only a sub-set of branched polymers, namely dendritic polymers, will be discussed. Dendritic macromolecules are three-dimensional polymers with successive branching units and this class of polymer includes dendrons, dendrimers and hyperbranched polymers. These molecules show higher solubility and a lower solution viscosity compared to their linear analogues⁸. Moreover, the large number of functional end-groups offers the possibility of further modifications and the opportunity to tune polymer properties for special applications. However, whereas dendrons and dendrimers are

monodisperse polymers with perfectly-controlled structures, prepared by multi-step reaction schemes, hyperbranched polymers are highly disperse ($\mathcal{D} > 2$) polymers with a broad molar mass distribution, isomerism, and an elliptical, randomly-branched structure obtained in a one-pot reaction⁹.

The structure of dendritic polymers can be described by defining three structural units⁹:

- branched units (B): with no remaining, unreacted functional groups;
- linear units (L): semi-reacted units with at least one unreacted functional group;
- terminal units (T): with all the functional groups unreacted.

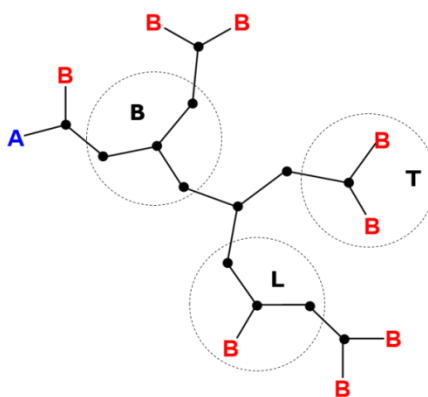

Figure 1.3 Structural units in hyperbranched polymers.

Dendrimers and dendrons possess only the B and T units while hyperbranched polymers have also L units. The structural units of a hyperbranched polymer synthesised from an AB_2 monomer are shown in Figure 1.3. The linear unit therefore represents a structural defect that distinguishes hyperbranched polymers from dendrimers. Determination of the percentage of branched, terminal, and linear units is fundamental for calculating the degree of branching (DB) – a key characteristic of dendritically branched polymers – and a topic that will be discussed in more detail in section 1.2.2.1. By definition, the degree of branching is 100% for dendrimers and dendrons and less than 100% for hyperbranched structures¹⁰.

Hyperbranched polymers are described in more detail below as they are the main focus of this work. The synthetic strategies used to prepare them, their structural characterisation and potential applications are discussed. Moreover, step-growth polymerisation via aza-Michael addition is presented as a useful strategy for the synthesis of hyperbranched polymers.

1.2.1 Synthetic strategies

Hyperbranched polymers can be prepared by (i) by a single monomer method, either by step-growth or chain-growth polymerisation, for example using an AB_x monomer or (ii) by a double

monomer approach via the direct polymerisation of two suitable monomers (e.g. $A_2 + B_n$). Scheme 1.1 illustrates the difference between the use of a single AB_2 functional monomer and the use of a pair of multifunctional $A_2 + B_3$ monomers. In the former case, assuming no cyclisation, the final polymer has a single A-group and multiple B groups while in the latter case, the resulting polymer has both multiple A and B functional groups. This feature makes the use of two monomers more susceptible to side reactions such as intramolecular cyclization and intermolecular coupling leading to gelation.

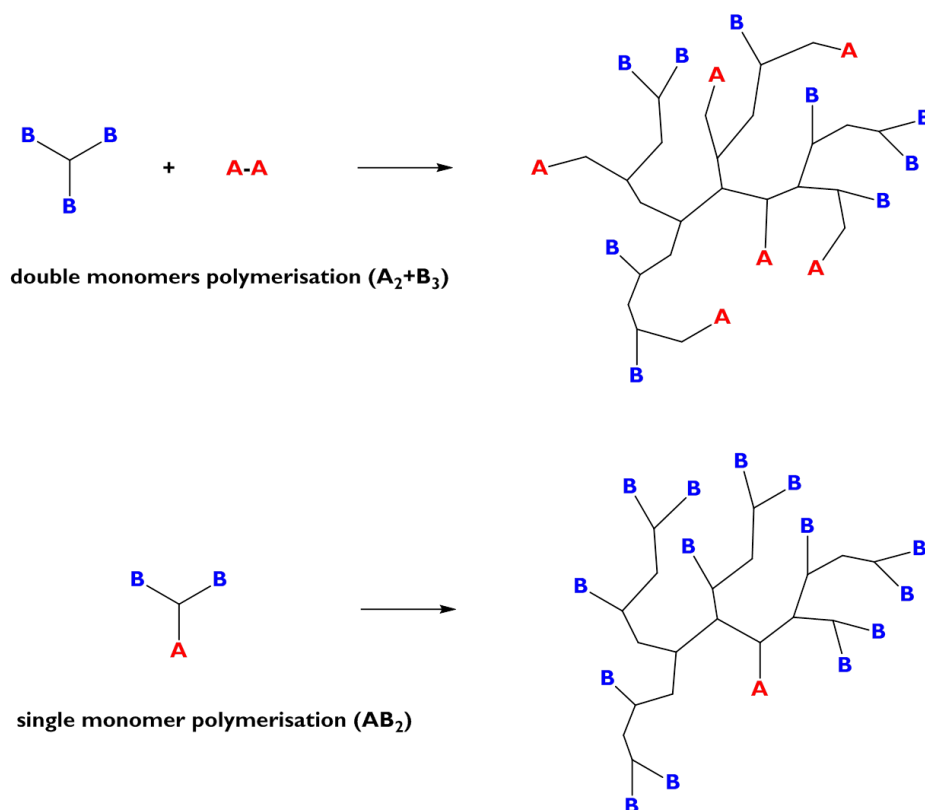

Scheme 1.1 Schematic representation of the polycondensation (or polyaddition) of an $A_2 + B_3$ monomer mixture (top) or an AB_2 monomer (bottom) for the synthesis of a hyperbranched polymer.

For the synthesis of hyperbranched polymers, the commercial availability of the starting monomers is an important consideration and the use of functionally symmetric monomer pairs such as A_2 and B_n with $n \geq 3$ represents a significant advantage over the use of a AB_n monomer since the former are widely commercially available and various combinations are possible (A_2 and B_4 , A_3 and B_3 , A_2 and B_3). The limited commercial availability of AB_n monomers limits their use for industrial applications. The availability or the easy synthesis of A_2 and B_n monomers allows tailoring of the polymer structure and properties and provides a facile route for the synthesis of many families of hyperbranched polymers. However, as already mentioned, the use of a pair of multifunctional monomers increases the risk of gel formation. Therefore a

crucial consideration of this approach is how to avoid gelation and obtain soluble, branched polymers. Such side reactions do not occur when a single monomer approach is used.

In subsequent sections an overview of the main methods used for the synthesis of hyperbranched polymers via a one-pot reaction is discussed.

1.2.1.1 Hyperbranched polymers using the single monomer method (SMM)

The synthesis of hyperbranched polymers with an AB_n -type monomer can proceed via: (i) step-growth polymerisation (polycondensation or polyaddition) and (ii) chain-growth polymerisation via self-condensing vinyl polymerisation (SCVP), self-condensing ring-opening polymerisation (SCROP) and proton-transfer polymerisation (PTP)⁷. In this section these methods are only briefly discussed and a key example presented for each of them. More details on the synthesis of hyperbranched polymers by using a single monomer methodology are provided in the detailed review of Voit and Lederer¹¹.

1.2.1.1.1 Step-growth polycondensation and polyaddition reactions

Polycondensation of an AB_n -type monomers is the most widely used method for the synthesis of hyperbranched polymers. The monomer contains one A functional group and two or more B functional groups having equal reactivity and capable of reacting selectively with A (Scheme 1.2). The success of the synthesis requires intermolecular coupling reactions to dominate over intramolecular cyclisation in order to achieve polymers with the desired molar masses¹².

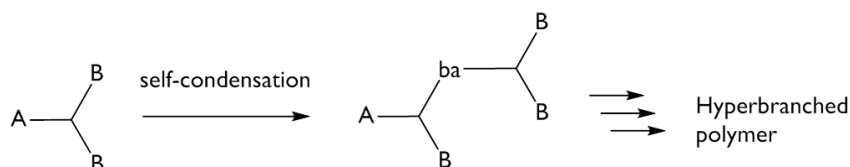

Scheme 1.2 Schematic representation of self-condensation reaction of the AB_2 monomer.

The AB_2 -type monomer is the most widely used in polycondensation reactions; but AB_3 , AB_4 and AB_6 monomers have also been reported in an attempt to regulate the branching pattern¹³. Kim and Webster reported the first example of an AB_2 polycondensation by using (3,5-dibromophenyl)boronic acid via a modified Suzuki coupling in a mixture of organic solvent/aqueous sodium carbonate in the presence of a Pd catalyst¹⁴. The reaction scheme and resulting hyperbranched polyphenylene are shown in Scheme 1.3 (i).

Hyperbranched polymers produced via polyaddition reactions, follow a similar reaction scheme to the polycondensation reactions (Scheme 1.2) except that in this case the functional groups A and B react by addition reactions without the formation of byproducts. An example of

polyaddition reaction of a AB_2 molecule is the aza-Michael addition for the synthesis of hyperbranched poly(amido amine)s similar to PAMAM dendrimers reported by Hobson and Feast¹⁵ (Scheme 1.3 (ii)).

(i) Example of polycondensation reaction

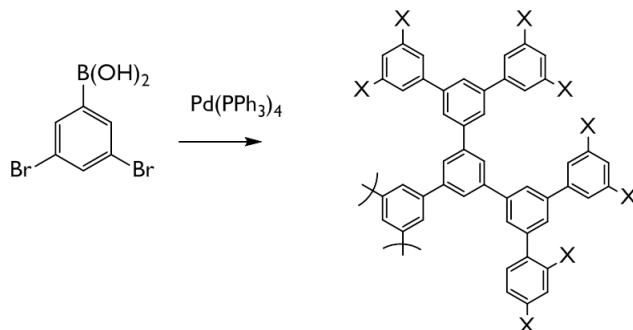

(ii) Example of polyaddition reaction

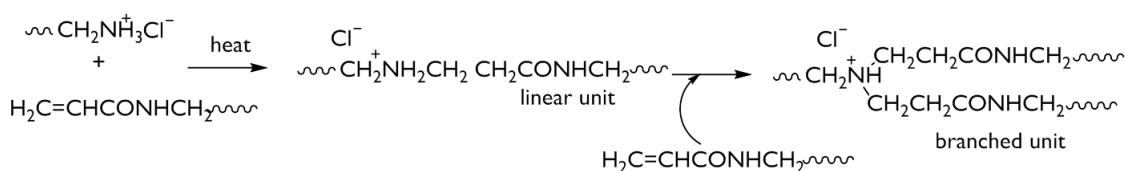

Scheme 1.3 Examples of step growth polycondensation and polyaddition reactions using a single AB_2 monomer.

Both polycondensation and polyaddition reactions involve the typical features of a step-growth polymerisation of a multifunctional monomer, such as a broad molecular weight distribution and high molar mass only at high conversions, but without risk of gelation¹⁶. In order to reduce the dispersity of hyperbranched polymers, chain-growth mechanisms can be used. These mechanisms are discussed in the next section. Moreover, polyaddition and in particular, polycondensation reactions are generally not suitable for the polymerisation of vinyl monomers unless activated by an adjacent group (e.g. an electron-withdrawing group for the conjugate polyaddition). By polyaddition reaction, $CH_2=CHR$ monomers bearing only a vinyl group can be polymerised only using a catalyst. Lu *et al.* for instance polymerised via ruthenium catalysed addition, the 4-acetylstyrene AB_2 monomer where A = vinyl group and B = C-H in *ortho*-position to the acetyl group¹⁷. However, polymerisation of vinyl monomers proceeds generally via chain-growth polymerisation.

1.2.1.1.2 Chain-growth polymerisation

1.2.1.1.2.1 Self-condensing vinyl polymerisation (SCVP)

In 1995, Fréchet *et al.* introduced self-condensing vinyl polymerisation for the one-pot synthesis of hyperbranched vinyl polymers. SCVP is a chain growth polymerisation mechanism of AB monomers characterised by a polymerisable vinyl group (A) and an initiating moiety (B) that is capable of being activated to B^* . Such monomers are hence called inimers (initiator + monomer). Examples include inimers based on acrylate, methacrylate and styrene. The initial step of the SCVP mechanism is the activation of the B^* group which transforms the inactive B group into a radical, cationic or anionic active centre. The activated group of an inimer can, at this point, attack the vinyl group of another inimer to produce a dimer as shown in the Scheme 1.4 for the polymerisation of 3-(1-chloroethyl)-ethenylbenzene, an AB monomer in which A is styrene and B is 1-chloroethylbenzene¹⁸.

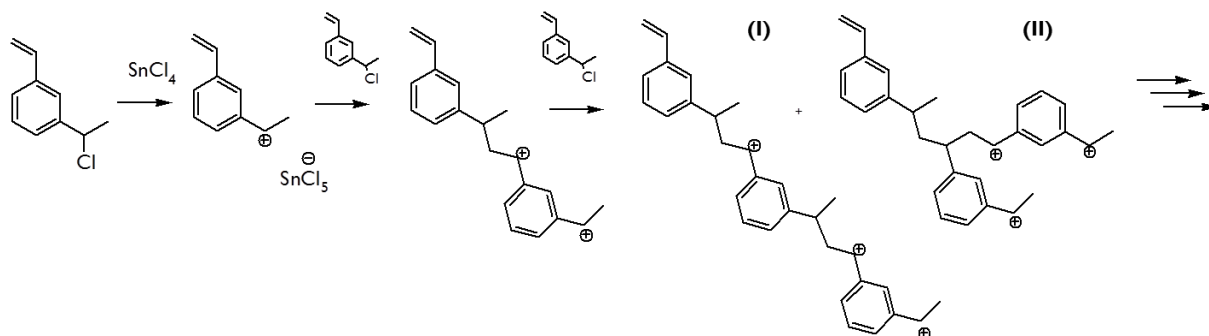

Scheme 1.4 Schematic representation of a cationic SCVP process for 3-(1-chloroethyl)-ethenylbenzene.

The resulting dimer now possesses two active groups, the activated vinyl group (propagating centre) and B^* (initiating centre), both of which are capable of propagation through reaction with double bonds. The SCVP can be initiated by a cationic initiator as shown in Scheme 1.4 or alternatively by a radical initiator. In this latter case the polymerisation begins for example with by thermolysis of the initiator¹⁹. The big advantage of this method is the extension of the concept of hyperbranched polymer towards vinyl monomers and chain growth processes. Moreover, the approach is very versatile, since the use of several AB inimers such as styrene and substituted styrenes, permit the synthesis of a variety of architectures in a one-pot polymerisation. However the SCVP method has some disadvantages including (i) the molecular weight distribution is generally very broad ($\mathcal{D} > 2$) because of the multiplicity of the latent AB^* monomers (I and II in Scheme 1.4) and (ii) side reactions may lead to gelation.

1.2.1.1.2.2 Self-condensing ring-opening polymerisation

AB-type monomers having B as a cyclic moiety can generate branch points upon ring opening during the polymerization reaction; this type of monomer is called “latent AB_m monomers” and they are employed in self-condensing ring opening polymerization SCROP. An example of SCROP is shown in Scheme 1.5, where hyperbranched polyesters are formed from inimers containing a caprolactone group (propagating site) and an alcohol functionality (initiating site)²⁰. The primary alcohol of the AB monomer, at 110 °C and in presence of a catalytic amount of stannous octoate, initiates the polymerisation by ring opening of the caprolactone ring of another AB monomer. The AB monomer is hence transformed in a AB₂ monomer that polymerises to produce hyperbranched polymers. Therefore, propagation and initiation proceed entirely through one type of reactive nucleophile: a primary alcohol.

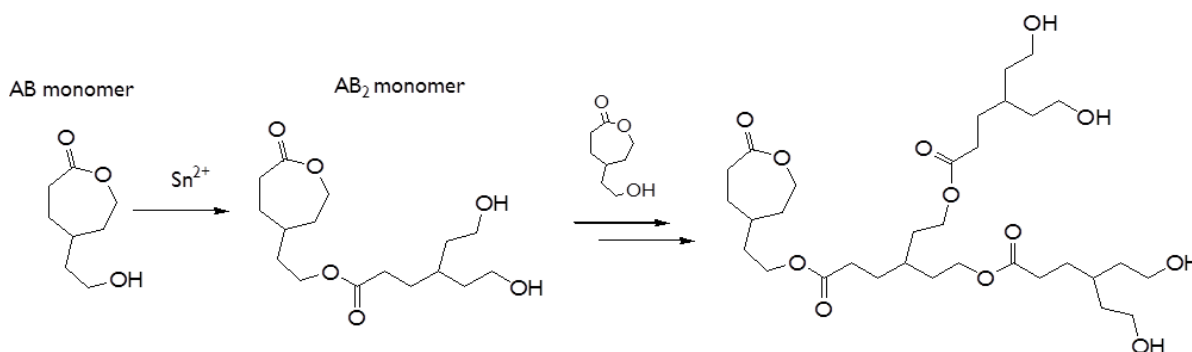

Scheme 1.5 Scheme of polymerization by catalytic SCROP of hydroxyl-functionalised caproactone in bulk conditions

In this case the initiation step involves the use of a catalyst and therefore the SCROP polymerisation is classified as catalytic. However, the reaction can occur via cationic initiation^{21,22}, when electron-deficient initiators (Bronsted or Lewis acid) react with electron-rich cyclic monomers containing heteroatoms, generating a positively charged propagating site or anionic^{23,24} when basic (nucleophilic) initiators (e.g. NaNH₂, alkoxides, cyanides, or organometallic compounds) react with electron-deficient monomers generating a negative charge.

The main advantage of this approach is that SCROP results in a reduced dispersity since branching points can be generated only upon ring opening of the cyclic moiety. Therefore, the simultaneous chain growth from all the chain ends, controlled by the level of the initiator, leads to a $\bar{D} < 1.5$ and DB c.a. 0.5.

1.2.1.1.2.3 Proton-transfer polymerisation

Proton transfer polymerization (PTP) represents another method to yield hyperbranched polymers in which an activated monomer is involved²⁵. The monomer can be represented as H-

AB_x type (see Scheme 1.6) where a proton is removed by a strong base, acting as initiator, to generate a reactive nucleophile. The activated monomer can, in this way react with another monomer $H-AB_x$ to form a dimer having a negatively charged B group. The activated dimer however, is not able to propagate directly, but undergoes a proton exchange with another monomer $H-AB_x$ giving rise to the reactive nucleophile and a neutral dimer (Scheme 1.6 (a)). In order to avoid undesired side reactions, the activation of the $H-AB_x$ monomer has to be significantly faster than the nucleophilic propagation step. Examples of monomers reported for the PTP method are shown in Scheme 1.6 (b).

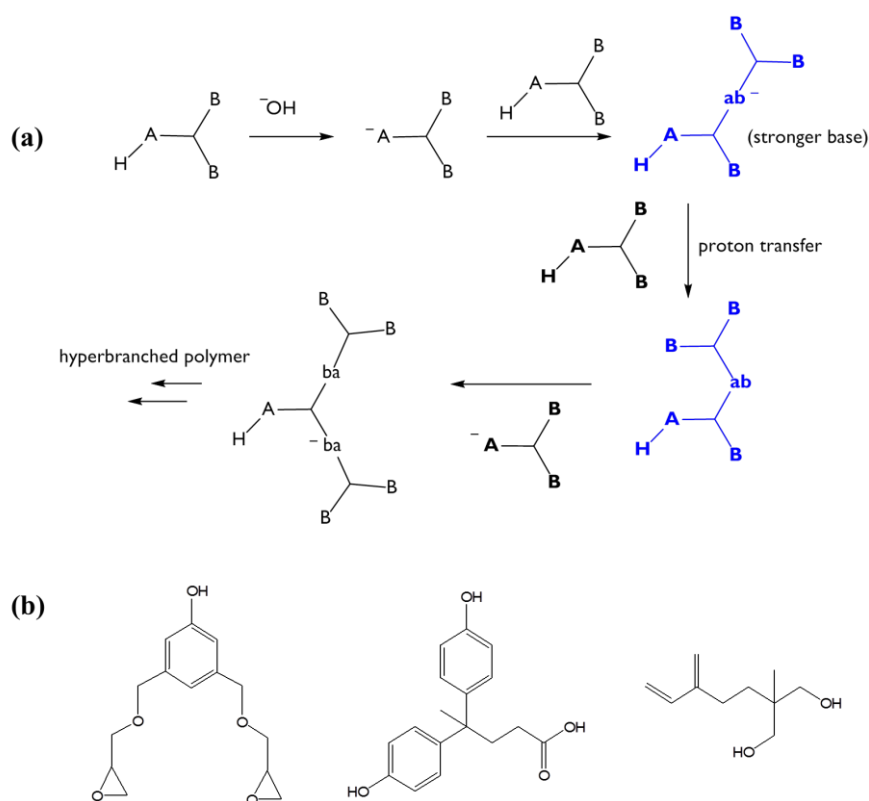

Scheme 1.6 (a) Generalised mechanism reaction of proton transfer polymerization; (b) examples of monomers used in PTP.

1.2.1.2 Synthesis of hyperbranched polymers using a double monomer method

Besides the use of an AB_n monomer, hyperbranched polymers can also be synthesised by using two monomers in which the A and B functional groups are located on separate molecules (e.g. A_n and B_m). The use of two mutually reactive monomers precludes the synthesis of the AB_n monomer, due to the wide commercial availability of multi-functional monomers. This represents a significant advantage over the AB_n single monomer method, permitting the preparation of the desired hyperbranched polymers in a faster and less costly way. This

approach can be divided in two sub-classes: (i) the A_n+B_m methodology also called double-monomer methodology (DMM) and (ii) the couple-monomer methodology (CMM)⁷.

The $A_n + B_m$ method is very susceptible to the formation of cross-linked polymers, in fact it was originally used as strategy to synthesise gels (e.g. $A_2 + B_3$ system)². In contrast to the use of a single monomer method (SMM), in which the macromolecules formed have at most one A group, in the DMM, the reaction between monomer pairs with symmetric functionality leads to the formation of A_xB_y species (where $x, y \geq 2$) that are able to form a cross-linked network (Scheme 1.1). Thus, gelation is the main problem with the $A_n + B_m$ approach and many attempts have been made to overcome this challenge, to obtain soluble, branched macromolecules. The formation of insoluble, cross-linked product can be avoided by (a) quenching the reaction (e.g. by precipitation) just before the predicted gel point (defined in the section 1.1.1)²⁶; (b) end-capping the polymer with a specific mono-functional monomer²⁷; (c) slow addition of one monomer²⁸ and (d) formation of cyclic products by intramolecular reactions²⁹. The control of reaction parameters such as time, temperature and concentration is crucial when the reaction has to be stopped before the gel point since such parameters permit some control over the rate of the reaction. Moreover, further approaches have been used to prevent the formation of gel products such as the use of a high stoichiometric imbalance and highly diluted solutions of monomer. The former case leads to the formation of a product with low molecular weight which is fully soluble and branched, while the latter case encourages cyclisation reactions that consequently help to avoid gelation¹¹. It is worth noting that, although both strategies ensure the solubility of the resulting polymer, it is not possible using these methods to obtain a high degree of branching.

Typical examples of A_n and B_m monomers are shown in Figure 1.4. Often the polymerisation between A_n and B_m leads to a mixture of the soluble branched polymer and gel and in this case the separation of the two products is necessary. Moreover, the resulting soluble branched polymer is characterised by a higher structural variation compared to the polymer synthesised from a AB_n monomer. Therefore, the product of the $A_n + B_m$ synthesis has a higher distribution of isomers (irregularly branched products which may differ in shape, molar mass, degree of branching and internal structural) compared to the product of the AB_x synthesis⁹. The higher number of isomers occurs because of the formation of the intermediate A_xB_y in the $A_n + B_m$ approach.

The gelation theory for such systems, established by Flory is based on three assumptions⁴; (1) the polymerization is restricted to reaction between A and B groups without side reactions, (2)

the reactivity between A and B does not change at any stage of the reaction and (3) the absence of intramolecular cyclization reactions. Any deviation from these assumptions may inhibit gelation and help generate fully soluble, hyperbranched products with high molar mass. On the basis of these considerations Yan and Gao developed the CMM approach by using monomers with unequal reactivity, thereby deviating from assumption 2 of Flory's theory^{27,30}. The method is based on the formation of AB_n intermediates from monomer pairs having functional groups of different reactivity such as $AA' + B_3$, $A_2 + B'B_2$ or $AA' + B'B_2$ ^{31,32,33}. Scheme 1.7 demonstrates this concept where for example A' and B' have higher reactivity than A and B respectively. Once formed, the AB_n -type intermediate can further react to form a core molecule with four B groups (Scheme 1.7) from the reaction of the AB_2 -intermediate with another $B'B_2$ -monomer. This strategy offers the possibility to avoid gelation even at high monomer conversion and in addition, the in-situ formation of a B_4 -core intermediate narrows the molecular weight distribution of the resulting polymer (see section 1.2.1.3) in comparison to the classical $A_n + B_m$ methodology discussed above in which the functional groups have equal reactivity. More details and discussion on the CMM strategy is provided in the review of Gao and Yan³⁴

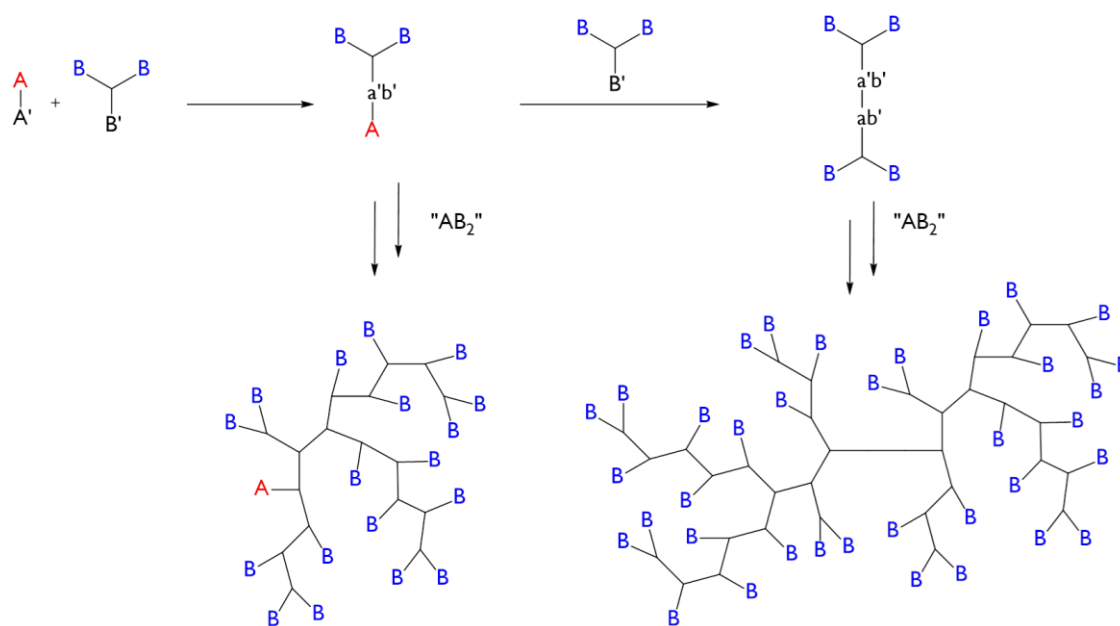

Scheme 1.7 Schematic representation of the CMM approach; the functional groups A' and B' have higher reactivity than A and B.

The DMM and CMM methods have been used for the synthesis of a variety of hyperbranched polymers (see Figure 1.4) including aromatic polyesters (Ia-Ib)³³, aromatic polyamides (IIa-IIb)³⁵, aliphatic polyethers (IIIa-IIIb)²⁶, poly(aspartamide) (IVa and IVb)³⁶, poly(ester amine)s (Va and Vb)^{37,38,39} polyphenylenes (VIa and VIb)⁴⁰ and polytriazoles (VIIa and VIIb)⁴¹.

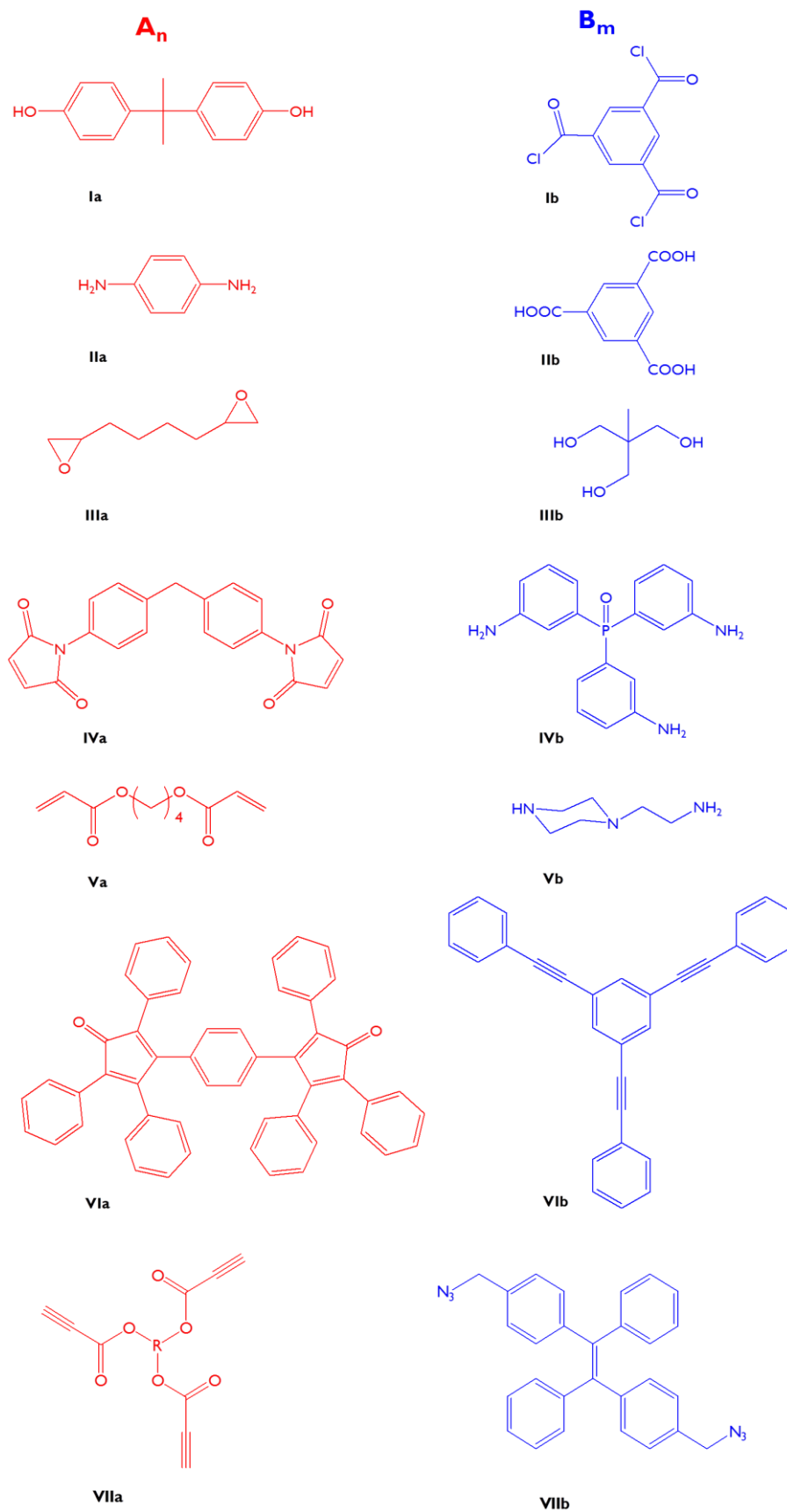

Figure 1.4 Examples of monomers used for the synthesis of hyperbranched polymers via DMM and CMM of a A_n coupled with B_m monomers.

1.2.1.2.1 Polymerisation via Michael Addition reactions

The Michael addition reaction is a base-catalysed, conjugate addition (1,4-addition) of a nucleophile (Michael donor) to an activated olefin such as α,β -unsaturated carbonyl compounds (Michael acceptor). It proceeds under mild conditions, often at room temperature, with high conversions and favourable reaction rates⁴². It is not particularly sensitive to oxygen and is characterized by high selectivity and hence high functional group tolerance. This last feature permits the use of a large range of functional precursors for the synthesis⁴³. This reaction has been used for the synthesis of linear, graft, hyperbranched, dendritic and network polymers by step growth⁴⁴ polymerisation and for the modification of polymers by post-polymerisation reactions⁴⁵.

Typical Michael donors are enolate anions or their analogues, generated by using a base as catalyst. Nevertheless, a wide range of non-carbon functional groups can also act as a donor in this reaction such as amines (aza-Michael reaction), thiols, alcohols and phosphines. The Michael acceptors are alkenes and alkynes having an electron-withdrawing group (e.g. -COR, -COH, -COOR, -CONR₂, -CN, -NO₂, -SO₂R) beta to the double/triple bond, which is capable of stabilizing the carbanionic intermediate. The presence of electron rich (such as alkyl, aryl, vinyl ethers, etc.) and bulky substituents in α and β positions decreases the reactivity of the acceptor. Commercially available Michael acceptors include acrylate esters, acrylonitrile, acrylamides, maleimides, alkyl methacrylates, cyanoacrylates and vinyl sulfones⁴⁶.

The aza-Michael addition reaction will be exploited in this work for the synthesis of hyperbranched poly(ester amine)s and hyperbranched poly(amido amine)s from a diacrylate or diacrylamide (aza-Michael acceptor) and primary diamine (aza-Michael donor). The reaction conditions of this reaction are discussed in more detail below.

In Scheme 1.8 depicts the general scheme of the reaction between a secondary amine (dimethylamine) and an acrylate (ethyl acrylate). The rate determining step is the attack of the amine upon the acrylate group and the reaction rate is therefore second order and depends upon the concentration of both the acrylate selected and the amine:

$$\text{Rate} = k_1[\text{amine}][\text{acrylate}] \quad \text{Equation 1.19}$$

The nucleophilic amine attacks the vinyl group to create an adduct that rapidly leads to the formation of the product by proton transfer. The higher stability of the product, associated with the formation of a σ -bond from a π -bond, makes the conjugate addition enthalpically favorable and drives the reaction to completion.

with a primary amine:

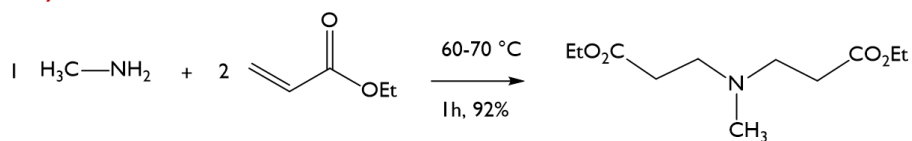

with a secondary amine:

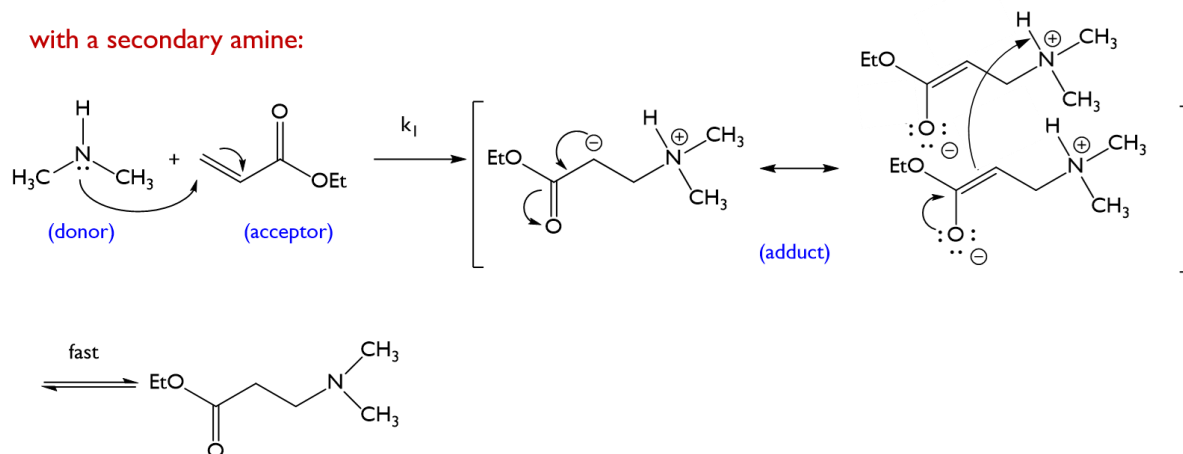

Scheme 1.8 Aza-Michael addition between ethyl acrylate (aza-Michael acceptor) and dimethylamine or methyl amine (aza-Michael donor).

A primary amine as aza-Michael donor can react with two equivalents of acceptor to form tertiary amines e.g. reaction of methyl amine with ethyl acrylate Scheme 1.8⁴⁶. The second addition can in some cases modify the kinetics of the reaction with an increase of the concentration of the secondary amine.

The polymerisation by aza-Michael addition does not require the use of additional base because of the ability of amines to act as both nucleophile and base. The reaction occurs at temperatures between 15°C and 60°C, in protic solvents and may proceed for hours or days. Protic solvents such as water and alcohols enhance the rate of the aza-Michael addition reaction and consequently the formation of polymers with high molecular weight⁴⁷. For instance, water can promote the aza-Michael polyaddition through hydrogen bond formation with both the donor and acceptor compounds as shown in Scheme 1.9. In this way water increases (i) the electrophilic character at the β -carbon of the acceptor compound through hydrogen bond formation with its carbonyl oxygen atom and (ii) the nucleophilic character of the N atom of the amine via hydrogen bond formation between the oxygen atom of water and the H-atom of the amine donor⁴⁸. Similar mechanisms can be supposed when alcohols are used as the reaction solvent.

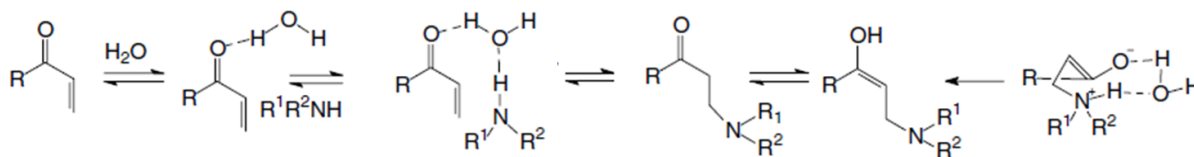

Scheme 1.9 Dual action of the water during the aza-Michael addition⁴⁸.

However, protic solvents are not so useful when side reactions such as hydrolysis occurs in parallel with the polymerisation e.g. for the synthesis of poly(ester amine)s. In this case it is preferable choosing an aprotic solvent and accept a reduced reaction rate, in order to preserve the stability of the polymer.

The rate of the reaction is also influenced by the nature of the amine. It is known that the reactivity of a secondary amine is higher than a primary amine because of the inductive effect of the alkyl groups that make the nitrogen atom more nucleophilic. Moreover, the reactivity sequence of primary and secondary amines is also affected by the electronic and steric environment as reported by Wu *et al.*⁴⁹. In particular, they studied the role of steric hindrance on the reactivity of different trifunctional amines with an equimolar ratio of 1,4-butanediol diacrylate (BDDA) (see Scheme 1.10). In this way, three types of amines are involved in the reaction: a primary amine, the secondary amine originally present in the monomer (original) and the secondary amine formed after partial reaction of the primary amine (formed). Wu and co-workers showed that when the original secondary amine is not sterically obstructed (e.g. 1-(2-aminoethyl)piperazine - AEPZ or N-methylethylenediamine - MEDA) the reactivity sequence is $2^\circ(\text{original}) > 1^\circ \gg 2^\circ(\text{formed})$ (Scheme 1.10). In this case, it has been further noted that the “formed” secondary amine does not take part in the reaction until all the secondary (original) and primary amine are consumed, because of its lower reactivity induced by the high steric hindrance of the polymer backbone. In such circumstances, the formation of a linear polymer is dominant. Increasing the hindrance on the original secondary amine (e.g. N-ethylethylenediamine - EEDA or N-hexylethylenediamine HEDA) results in a change in the reactivity sequence such that $1^\circ > 2^\circ(\text{original}) \geq 2^\circ(\text{formed})$ and in this case the “formed” secondary amine can participate in the polymerization reaction leading to branched polymers with DB of 0.33-0.37 (Scheme 1.10).

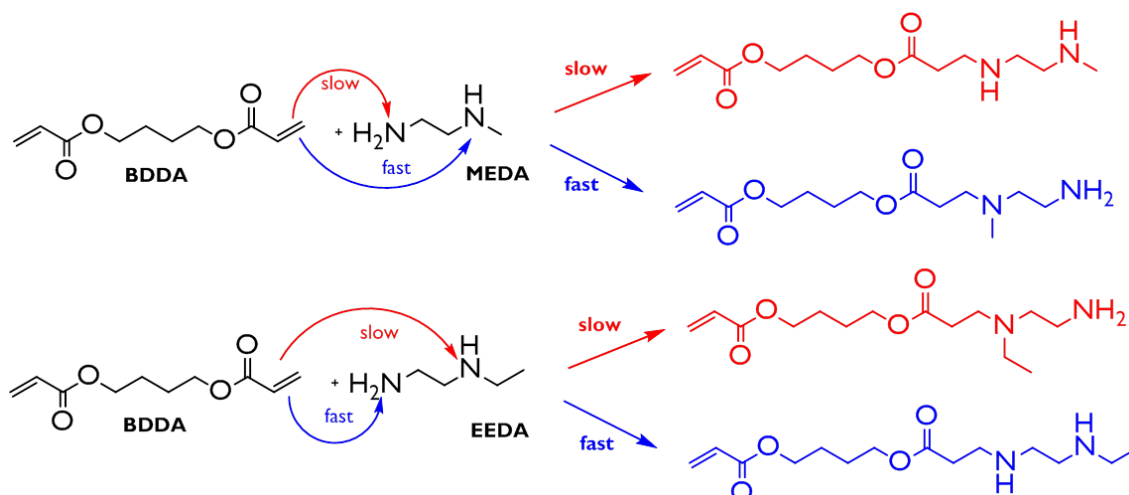

Scheme 1.10 Substituent effect of reactivity of amine in Michael addition

Alternatively, the reactivity of the secondary amine formed can be enhanced by increasing the temperature. Hong *et al.*⁵⁰ investigated the effect of the temperature on the polymerization via Michael addition of a disulphide-based diacrylate with an equimolar amount of N-methyl ethylenediamine, at temperatures equal to and lower than 40°C and a temperature higher than 48°C. From this work it emerged that the secondary amine formed is inactive at and below 40°C, due to high steric hindrance, and resulted in a linear polymer. Nevertheless, the reactivity of the secondary amine formed can be enhanced by increasing the temperature (> 48 °C) and in this way the amine can actively participate in the reaction and a hyperbranched polymer was obtained. Hyperbranched poly(ester amine)s with a M_n of 21,000 ($\mathcal{D} = 2.1$), 40,400 ($\mathcal{D} = 1.4$), 32,000 ($\mathcal{D} = 2.2$), and 65,500 g/mol ($\mathcal{D} = 2.0$) and DB of 0.21, 0.38, 0.52, and 0.69 respectively were obtained by working at 48, 55, 60, and 65 °C respectively.

Supplementary details about the reaction conditions for the synthesis of hyperbranched polymers via aza-Michael addition will be discussed in Chapter 3 and 4 in which the synthesis of hyperbranched poly(ester amine)s and poly(amido amine)s is respectively discussed.

1.2.1.3 Synthetic strategies to control of the structure and the molecular weight of hyperbranched polymers

In the previous sections it has been shown that hyperbranched polymers can be synthesised via a one-pot polymerisation of AB_n -type monomers, AB^* inimers and $A_n + B_m$ monomers. The main synthetic mechanisms used are step-growth polycondensation or polyaddition, self-condensing vinyl polymerisation, self-condensing ring-opening polymerisation and proton transfer polymerisation. These one-pot polymerizations lead to a broad dispersity (\mathcal{D}) at high

conversion, intramolecular cyclization and a degree of branching (DB) not higher than 0.50 for AB₂-type or AB* -type monomers^{51,52,53}. Higher DB (> 0.50) can instead be obtained by using a monomer pair (A_n + B_m), in particular with unequal reactivity (e.g. A₂ + B'B₂), but in this case the risk of gelation has to be considered.

Hyperbranched polymers with a narrower Đ and higher DB can also be obtained by slow monomer addition (SMA), whereby the monomer takes part in the polymerisation reaction at a rate comparable to the rate of addition and only the reaction between monomer with the growing polymer is permitted. The resulting low instantaneous monomer concentration allows the growth of a polymer with a structure which is more ordered and characterised by higher DB and higher molecular weight. This result would not be possible when all monomers are mixed together at the same time. The SMA for a AB_n system was considered theoretically by Frey *et al.* who predicted an increase of the DB from 50% up to 66%^{53,55}.

For an AB_n system, the control of molecular weight, a narrower Đ and increased DB can all be achieved by the slow addition of such a monomer to a core molecule with multiple B functionalities, B_f^{53,54,55}. In fact, the core molecule reduces the directions of propagation of the polymer while the slow addition avoids the coupling of growing molecules. Moreover, the use of a core molecule in the polymerisation (AB_n + B_f) reduces the possibility of intramolecular cyclisation by reaction between the core molecule and the focal point – A functional group (see Scheme 1.1). In the synthesis of hyperbranched poly(phenylacetylene), the slow addition of 3,5-diiodophenylacetylene (AB₂-monomer) in presence of 1-(3,5-diiodophenyl)-3,3-diethyltriazene as a B₂ core molecule (monomer:core of 17.5) results in a M_w of 8220 g/mol and Đ 1.28 (Scheme 1.11)⁵⁶. Moreover, by varying the ratio of monomer:core during the slow addition polymerization, it is possible to control the molar mass of the resulting polymer; in particular an increase of the ratio monomer:core from 17.5 to 560 leads to polymers with molecular weight of between 8220 and 90600 g/mol and Đ of 1.3 to 8.5. It is worth noting that the same reaction (AB₂ = 3,5-diiodophenylacetylene) without addition of the core, leads to a polymer with M_w of 490000 g/mol and Đ 33.3 by slow monomer addition and M_w 35300 g/mol and Đ 2.4 by the one-pot polymerisation. The slow monomer addition leads to a significantly higher molecular weight and dispersity compared to the one-pot reaction as the low concentration of the monomer in solution reduces the possibility of intramolecular reactions (cyclisation), promoting intermolecular reaction between polymer chains. Intramolecular cyclisation would limit the polymerisation by eliminating the focal point A functional group; this feature explains the lower M_w and Đ obtained in one-pot reaction⁵⁶.

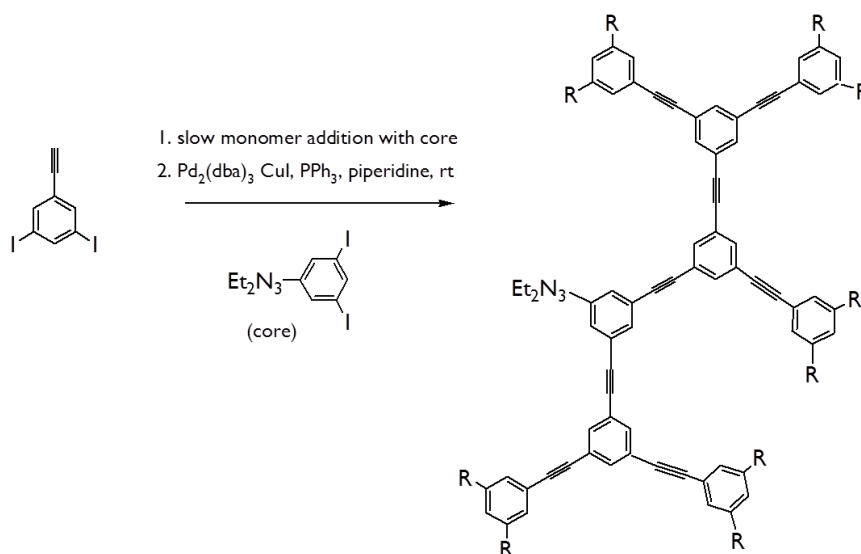

Scheme 1.11 Schematic representation of hyperbranched phenylacetylene polymers prepared by slow monomer addition.

The slow monomer addition can also be applied to the $A_n + B_m$ systems in which case, the use of a core molecule is not required because one of the two monomers can play this role. Experimental results have shown that the monomer molar ratio and the sequence of monomer addition can have a strong impact on the DB and on the dispersity. For instance Schmaljohann and Voit⁵⁷ showed for a $A_2:B_3$ system (molar ratio 1:1) that an increase of the DB from 0.65 to 0.91 could be achieved by adding B_3 slowly to an A_2 solution, instead of adding A_2 to B_3 . Unal *et al.* observed that in the preparation of hyperbranched poly(ether ester), a cross-linked product was obtained by adding a solution of B_3 to A_2 while a branched polymer with narrow dispersity was synthesized by adding A_2 to a solution of B_3 ⁵⁸. The former case in fact produced a highly branched polymer as an initial product, while in the latter case the excess of B_3 lead to the formation of a linear polymer initially, then to a slightly branched structure and finally to a highly branched product.

For systems which are particularly sensitive to gelation, the introduction of a mono-functional monomer together with the starting building blocks has been also considered in order to control the molecular weight of the polymer and inhibit gelation. The preparation of hyperbranched poly(ethylene terephthalate) (PET) by adding a mono-functional monomer (A) in the three component system $A_2 + B_2 + A_3$ was first reported by Manaresi *et al.* in 1986 where A_3 introduces branching points⁵⁹. In the $A_2 + B_2 + A_3$ system, even relatively small amounts (c.a. 1% mol) of the A_3 -monomer results in gel formation. Thus, in order to avoid this unwanted outcome and control at the same time the structure and the molecular weight of the resulting polymer, a monomer with a single A functionality was introduced. The A-monomer acts as an end-capping agent by stopping the growth of the polymer's chains. In the polymerisation $A_2 +$

$B_2 + A_3 + A$ the molar ratio $A:A_3$ is crucial for the fate of the reaction. In particular, gelation still occurs when the molar ratio $A:A_3$ is lower than 3 while the onset of gelation is delayed to longer reaction times when the molar ratio $A:A_3$ approaches 3. These results were in agreement with the theoretical treatment of branching, formulated by Flory and Stockmayer^{60,61}, in which they observed that the addition of a monofunctional monomer (A) to a system containing a trifunctional monomer (A_3) as branching agent results in (a) a shift in the gel point to higher conversion and (b) no gelation when the molar ratio monofunctional monomer to trifunctional monomer is higher than 3⁵⁹. Hudson *et al.* in 2000 reported the synthesis of branched poly(ethylene terephthalate) (PET)-type polymers by the polycondensation of the $A_2 + B_4 + B$ system and they observed that the polymer produced with 0.125% w/w of B_4 monomer in the absence of monofunctional monomer had an absolute M_w of 361000 $\text{g}\cdot\text{mol}^{-1}$ (calculated by LS) and the addition of 0.0312-1.0 % w/w of B-monomer dramatically reduced the M_w from 133000 to 36000 $\text{g}\cdot\text{mol}^{-1}$ ⁶². In such work the mono-functional monomer was used in the condition in which the polycondensation $A_2 + B_4$ does not lead to gelation. The results obtained are evidence of the ability of the monofunctional monomer to adjust and narrow the molecular weight distribution of the product. A similar strategy to those described above has been reported by Rosu *et al.*⁶³ for the synthesis of branched PET by using a $A_2 + B_2 + B_3$ (or B_4) + B system and Maruyama *et al.*⁶⁴ for the synthesis of branched polyesters with terminal methacryloyl groups by using the $A_2 + B_3 + B$ system (Scheme 1.12). Despite the examples mentioned, the use of a monofunctional monomer has been predominately used for the functionalization of hyperbranched polymers, as discussed in the section 1.2.3.

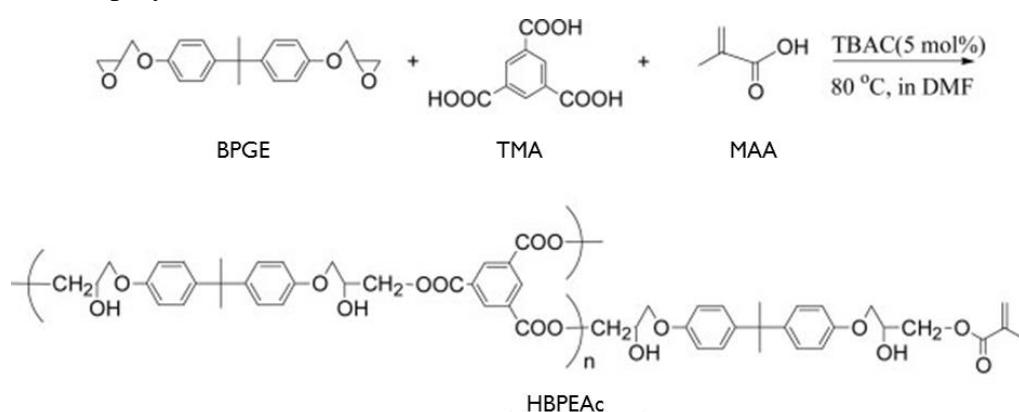

Scheme 1.12 Polyaddition of bisphenol diglycidyl ether (BPGE, A_2), tricarboxylic acid (TMA, B_3) and methacrylic acid (MAA, B) for the synthesis of photocrosslinkable hyperbranched polyester⁶⁴.

In this section methods to enhance the DB of a hyperbranched polymer by slow monomer addition have been discussed. Moreover, the use of a core (multifunctional) molecule or a monofunctional co-monomer in the AB_x and $A_n + B_m$ systems respectively represents a strategy to

obtain some control over the synthesis of hyperbranched polymers; in particular a reduction of the molecular weight and consequently of the dispersity of the polymer can be obtained.

1.2.2 Structural Characterisation of Hyperbranched Polymers

1.2.2.1 Degree of Branching

Hyperbranched polymers are macromolecules composed of linear units (L), branched (B) and terminal (T) units. For an AB₂ system, a linear unit is defined as a unit with one B group unreacted, a branched unit arises when both B groups have reacted and the terminal units have both B groups unreacted.

The different structural units are generally identified/quantified by both direct and indirect methods. The direct methods include (i) NMR spectroscopy (1D and 2D-NMR)^{65,66,67} and (ii) chromatographic analysis of the degraded subunits of the polymer^{68,69}. Solution viscometry represents instead an indirect method to evaluate the DB and is based on the Mark–Houwink equation⁷⁰ (Equation 1.25).

The degree of branching (DB) is an important parameter which can be used to compare the structure of dendritic macromolecules - dendrimers, dendrons and hyperbranched. The DB defines the ratio of terminal, linear and branched units in the polymer. Thus by definition, the DB is 100% for dendrimers as they possess only terminal and branched units, DB is 0% for linear polymers and between 0 and 100% for hyperbranched polymers. The value for hyperbranched polymers is commonly 40-60%. In the case of an ideal random polymerisation of an AB₂ monomer and assuming equal reactivity of all B groups and no side reactions (e.g. intramolecular cyclisation), the DB of the resulting hyperbranched polymer statistically approaches the value of 0.50⁵².

In 1991, Fréchet *et al.* defined the DB for an AB₂-type of hyperbranched polymer as follows⁶⁵:

$$DB_{\text{Fréchet}} = \frac{B + T}{B + L + T} \quad \text{Equation 1.20}$$

For dendritic structures such as hyperbranched polymers, a relationship exists between the number of terminal units and the number of branched units since for every B unit formed from a L unit a new T unit is formed; in particular for a AB₂ system, $T = B + 1$ ^{52,71}. By taking into account this relationship, Equation 1.20 gives a $DB > 0$ even for linear polymers. This equation can only accurately describe the DB for polymers with high degree of polymerisation in which the approximation $T = B$ is valid. Frey *et al.* subsequently proposed for an AB₂ system, an

alternative equation (Equation 1.21), in which only the branched and linear units are taken into account, overcoming the limitation related to the degree of polymerisation of the polymer⁵².

$$DB_{\text{Frey}} = \frac{2B}{2B + L} \quad \text{Equation 1.21}$$

The determination of the DB becomes more complex for the product of an $A_2 + B_3$ polymerisation, as there are a number of possible monomer combinations to consider for NMR characterisation, in order to determine the linear, branched and terminal units. To demonstrate this added complexity, the potential building blocks for an ideal $A_2 + B_3$ system are shown in Scheme 1.13, where b_3 represents a branched unit with all three B groups reacted; Bb_2 represents a linear unit with two reacted B groups and the B_2b is the terminal unit¹¹.

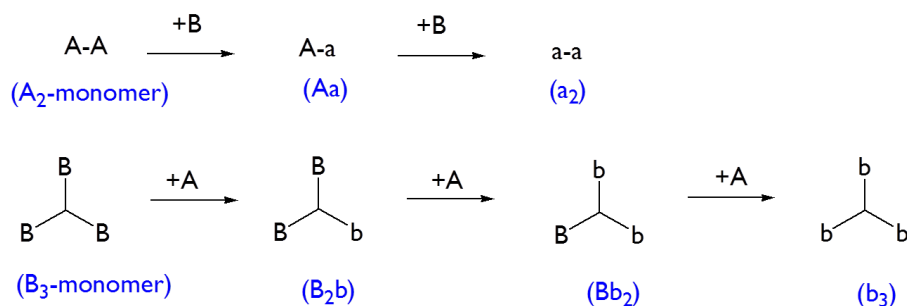

Scheme 1.13 Possible monomer combination for the determination of terminal (B_2b), linear (Bb_2) and branched (b_3) units in a hyperbranched polymer based on A_2+B_3 system¹¹.

Although Equations 1.21 and 1.22 have been obtained from topological considerations based on AB_2 monomer, such equations are also applicable and are used for hyperbranched polymers based on the double-monomer system⁷². Therefore, from Scheme 1.13, the DB of the product of the $A_2 + B_3$ polymerisation can be calculated as:

$$DB = \frac{2(b_3)}{2(b_3) + (Bb_2)} \quad \text{Equation 1.22}$$

Since A_2 acts as linker-monomer in the structure of the polymer, the calculation of the DB (Equation 1.22) only takes into account the structural units formed by the B_3 monomer. The determination/characterisation of the structural units for the calculation of the DB can be further complicated by the occurrence of side reactions such as cyclisation^{73,74}. For this reason, model compounds are often used and via their ^1H or ^{13}C NMR or 2D-NMR the identification of such units is possible^{75,76}.

The ability to control of the DB is fundamental in the synthesis of hyperbranched polymers as the DB modulates the intrinsic properties of the polymer such as radius of gyration, free volume, chain entanglements, solution viscosity and glass transition temperature. Strategies to increase

the DB have already been discussed in the section 1.2.1.3. For an AB_n system the SMA in combination with a core molecule is the most efficient way to enhance the DB⁷⁷, other methods include the polycondensation of dendrons⁷⁸ or an increase of the reactivity of the B group (e.g. use of a ABB' monomer)⁷⁹. On the other hand, for the $A_2 + B_y$ system, parameters such as molar ratio and sequence of monomer addition have proved crucial to increase DB⁵⁷.

1.2.2.2 Molar mass and molar mass distribution

Hyperbranched polymers often exhibit a very broad molecular weight distribution due to the random nature of the polymerisation reaction. In particular, it has been reported that the molar mass distribution of statistically hyperbranched polymers depends on the degree of polymerisation (X) as $M_w/M_n \sim X/2$ when prepared via AB_n polycondensation/polyaddition and as $M_w/M_n \sim X$ for polymers prepared via SCVP¹¹. As a comparison, it is worth noting that linear polymers obtained via step growth polycondensation reactions have a statistically likely dispersity of $M_w/M_n = 2^4$. For hyperbranched polymers obtained from AB_n monomers, it has been seen that the final molar mass distribution can be significantly affected by the different reactivity of the functional groups or by using the slow monomer addition method in the presence of a multifunctional core molecule⁵³. For $A_2 + B_n$ systems, the molar mass and dispersity also depend on the functionality conversion, the ratio of A:B, the formation of cycles and sequence of monomer addition.

The molar mass of polymers is commonly determined by size exclusion chromatography (SEC), however for hyperbranched polymers it is difficult to determine accurately the absolute molecular weight. Moreover, the densely-branched structure of the hyperbranched polymer decreases the hydrodynamic radius in a good solvent in comparison to an analogous linear polymer and SEC analysis results in significant errors when using only a differential refractive index (DRI) detector or UV-detector and a calibration curve constructed with linear polymer standards. The magnitude of the error in the molecular weight has been investigated for fractionated hyperbranched poly(ether amide) samples by using: (i) SEC with RI detection and linear poly(ethylene oxide) standards; (ii) SEC with RI detection and poly(styrene) standards (iii) SEC-viscosity detection and a universal calibration and (iv) SEC with MALLS (static light scattering detection), the results of which are shown in Figure 1.5⁸⁰.

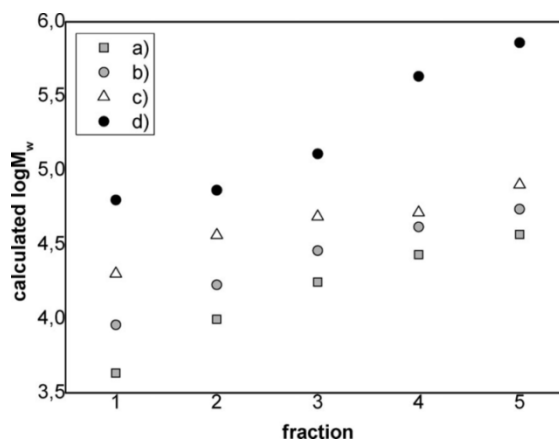

Figure 1.5 Deviation of the values of molecular weight for hyperbranched poly(ether amide) obtained by: (a) SEC-DRI, PEO standards; (b) SEC-DRI, PS standards; (c) SEC-DRI-viscosity, universal calibration; (d) SEC-MALLS⁸⁰.

Figure 1.5 shows that these various SEC analytical methods lead to a significant variation between the values obtained for the different polymer fractions. It is clear that there is strong deviation between the molar mass calculated using a calibration curve constructed from linear standards of either PS or PEO and molar mass calculated using light scattering. Branched polymers have a smaller hydrodynamic radius in solution than linear polymers and therefore the calculation of their molecular weights using linear standards leads to a significant underestimation of the actual value. Therefore SEC-RI with linear standards – case (a) and (b) in Figure 1.5, does not represent an accurate method. In order, to obtain a more reliable value, a specific calibration with standards similar in both architecture and chemical composition to the hyperbranched polymer sample would need to be used. However, for hyperbranched polymers, there are no suitable commercially available standards. The molecular weight of polymers can also be calculated using SEC-viscosity (universal calibration) and SEC-MALLS (light scattering). In particular, in the universal calibration the molecular weight is calculated according the hydrodynamic volume and intrinsic viscosity of the polymer therefore such method has the potential to be more accurate than SEC with RI detection and linear standards. The Flory-Fox equation (Equation 1.24) describes the relationship between such parameters.

$$[\eta] = \phi \left(\frac{R_g^3}{M_p} \right) \quad \text{Equation 1.23}$$

where $[\eta]$ is the intrinsic viscosity, R_g the radius of gyration, defined as the average squared distance of any point of the polymer coil from its centre of mass, ϕ defines the volume fraction occupied by the polymer in solution and M_p is the peak molecular weight related to a given retention volume. For linear and long chain branched polymers, the structural parameters (e.g. ϕ , R_g) are defined and constant therefore a linear relation exists between the intrinsic viscosity and the molecular weight as described by the Mark-Houwink equation;

$$[\eta] = K \cdot M^\alpha \quad \text{Equation 1.24}$$

where K and α are the Mark-Houwink constants. In general, α depends upon the shape and the compactness of a polymer in a particular solvent. It is in the range 0.5 to 1 for flexible linear polymers and less than 0.5 for hyperbranched polymers⁸¹. Equations 1.23 and 1.24 therefore well-describe the solution behaviour of linear polymers and long-chain branched polymers and the molecular weight can be hence calculated with good accuracy by using the universal calibration. However, hyperbranched polymers deviate from the relationship described by Equation 1.23 and 1.24 as ϕ is no longer a constant but varies with polymer's compactness and topology. Therefore such polymers do not obey the linearity described by the Mark-Houwink equation and the universal calibration is inaccurate for the calculation of the molecular weight of hyperbranched polymers^{11,80}.

In order to exclude the effect of the polymer structure, molecular weights can also be calculated by SEC with a light scattering detector (Equation 1.25). However, this method is subject to some limitations; namely, for hyperbranched polymers with a broad dispersity, the fraction of the polymer with a lower molecular weight (< 5000 g/mol) results in little or no light scattering signal, even if the polymer solution has a high dn/dc or high concentration in the solvent in question (Equation 1.26).

$$R_\theta = \frac{4\pi^2 n_0^2 \left(\frac{dn}{dc}\right)^2}{\lambda_0^4 N_A} c M_w \quad \text{Equation 1.25}$$

Equation 1.25 describes the light scattered from a polymer in solution, correlating the amount of light scattered, R_θ (Rayleigh factor) with the weight-average molecular weight, M_w . The intensity of the light scattered is proportional to both the concentration and molar mass of the polymer. In Equation 1.25, n_0 is the refractive index of the solvent, λ_0 the wavelength of incident light, N_A Avogadro's Number, c the concentration of the solution and dn/dc the specific refractive index increment for the polymer-solvent system (in dilute conditions it approximates $\Delta n/c$, where Δn is the difference between the refractive index of the solution (n) and the pure solvent (n_0). Although light scattering data can lead to reliable information about the higher molar mass fraction and hence weight-average molecular weight, the combination of a RI detector along with a light scattering detector (e.g. MALLS) is necessary to determine with accuracy the dn/dc of the hyperbranched polymer. The light scattering detector certainly represents the most accurate and powerful detection method for such polymers and does not require calibration of the column.

1.2.3 Functionalisation of hyperbranched polymers: synthetic strategies

The functionalisation of hyperbranched polymers is one of the strategies used to tailor the thermal, rheological and solution properties of hyperbranched polymers. In particular, the number, type and location of functional groups can impact upon the solubility, reactivity, adhesion to various surfaces, self-assembly, electrochemical and luminescence properties of the resulting product. Therefore, the introduction of specific functionalities on the polymer can result in the synthesis of novel functional polymeric materials for a wide variety of applications. Many functionalisation strategies have been reported (Figure 1.4), including (A) click chemistry of alkynyl terminated polymers to functionalise the polymer with PEG groups for example⁸²; (B) thiol-ene click reaction of allyl-terminated hyperbranched polymers with a variety of thiols such as octadecanethiol to introduce hydrocarbon solubility⁸³; (C) aza-Michael addition of amino- or acrylamido-terminated polymers^{84,85}; (D) epoxidation of an amine-terminated polymer (e.g. hyperbranched poly(ethylene imine) with epoxy groups e.g. 4-glycidol-2,2,6,6-tetramethyl-piperidin-1-oxyl (GTEMPO)⁸⁶.

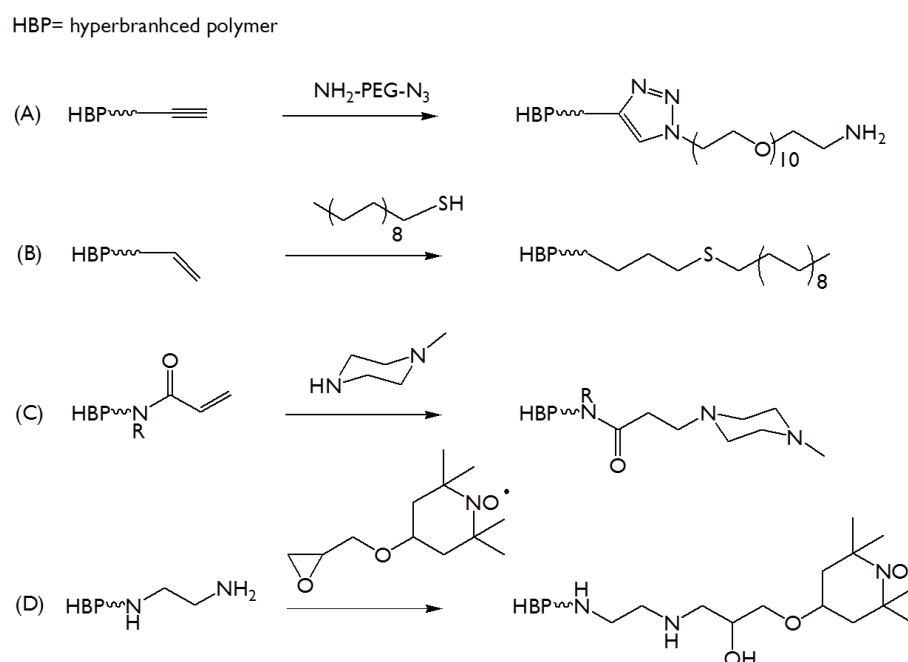
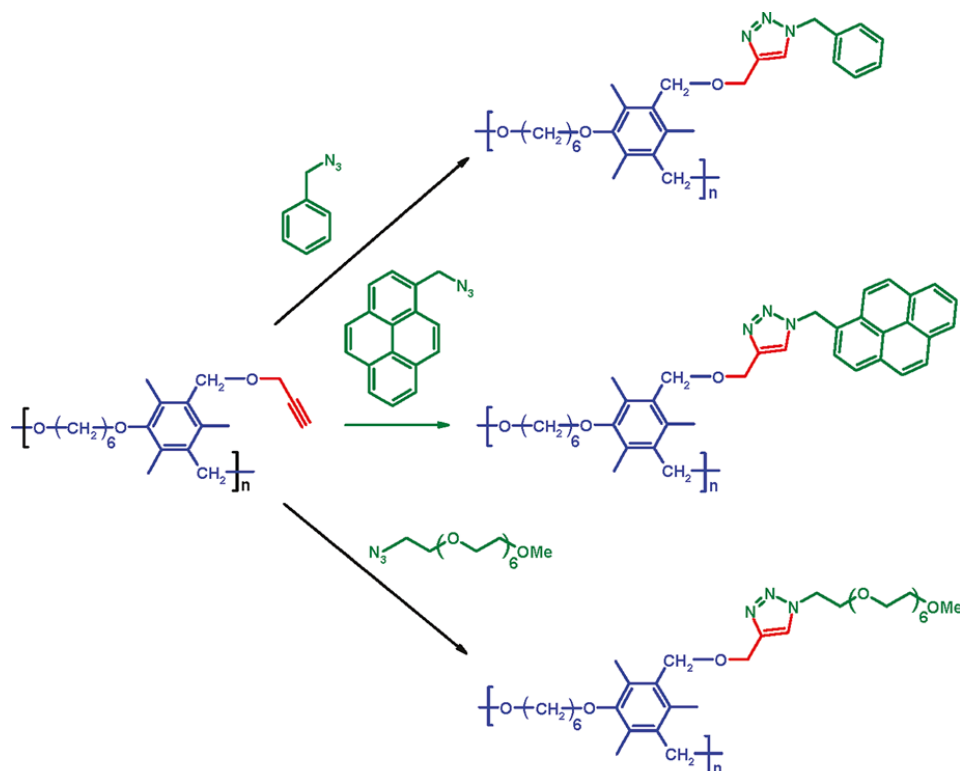

Figure 1.6 Examples of typical strategies used for the post polymerisation functionalisation of hyperbranched polymers.

The functionalisation of the polymer is generally carried out post-polymerisation but in a few cases, depending on influence of the desired functionality on the polymerisation reaction, functionalisation can take place during the polymerisation reaction. For example Saha *et al.* synthesised by melt-transetherification of an AB_2 monomer (where A is a hydroxyl group and

B two propargylbenzyl ether groups) “clickable” hyperbranched polyethers bearing propargyl groups in the periphery (see Scheme 1.14)⁸⁷.



Scheme 1.14 Post-polymerisation modification of “clickable” hyperbranched polyethers⁸⁷.

The alkyne functionalities were then reacted post-polymerisation with a range of organic azides under standard click reaction conditions to introduce fluorophores or PEG chains onto the polymer (Scheme 1.14). The same authors proposed a further method for the functionalisation of the periphery of hyperbranched polymers, based on the copolymerisation of an $AB_2 + A-R_1 + A-R_2$ system, where A are hydroxyl groups, B methoxy groups, R_1 and R_2 are PEG chains with a terminal methoxy group and propargyl group respectively. The copolymerisation was carried out with a molar ratio $AB_2:A-R_1:A-R_2$ of 1.0:0.1:0.9⁸⁸. $A-R_1$ and $A-R_2$ were used in this work to confer hydrophilic characteristics to the polymer and introduce functionality which could be further modified (propargyl group) by post-polymerisation reactions. Similarly, the use of an equimolar amount of A_2 (A are hydroxyl groups) and B_2 with a pendant propargyl group (B methoxy groups) within the $AB_2 + A-R$ and $AB_2 + A-R_1 + A-R_2$ systems enabled both the functionalisation of the interior backbone of the polymer and the periphery of the hyperbranched polymer with clickable units (Scheme 1.15).

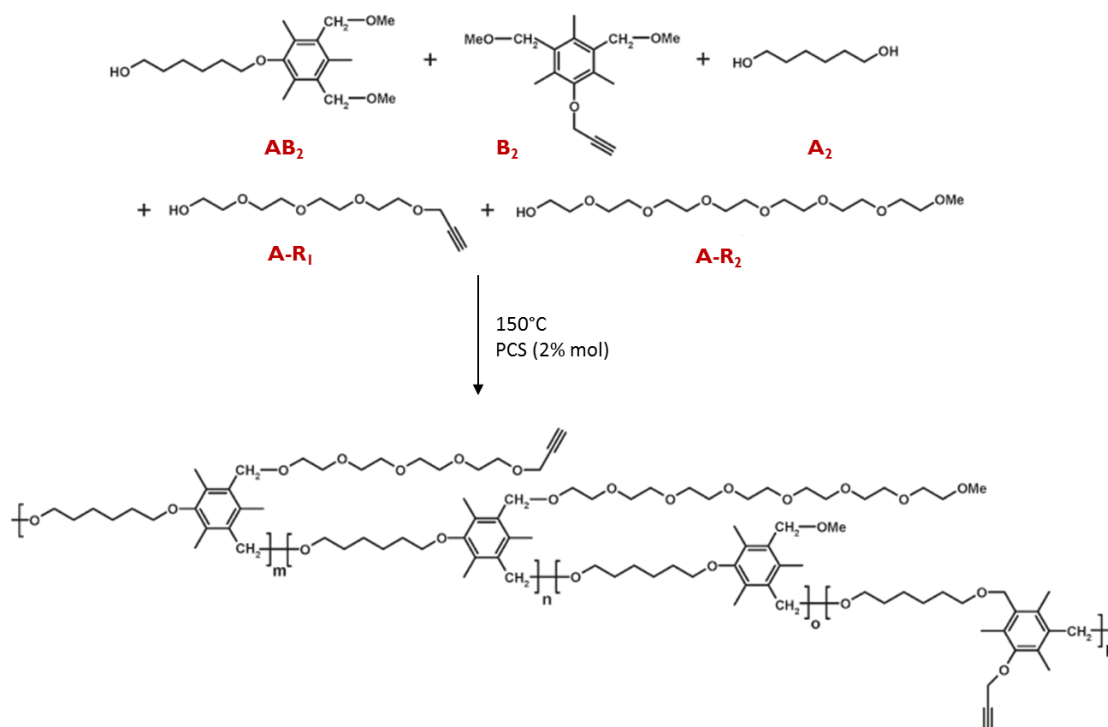

Scheme 1.15 Synthesis of hyperbranched polymers with clickable groups on the periphery by using an

$AB_2 + A_2 + B_2 + A-R_1 + A-R_2$ system.

The copolymerisation of building blocks with a mono-functional monomer bearing a specific (orthogonal) functionality offers a straightforward way to functionalise the polymer, when compared to the post-polymerisation method in which two step reaction are necessary. The simultaneous copolymerisation approach has been applied to a limited number of cases such as the $AB_2 + A$ (where A carries a PEG unit)⁸⁹ and $A_2 + B_3 + B$ (B carries a methacrylate groups)⁹⁰ systems and used respectively to produce thermosensitive and photocrosslinkable polymers.

The copolymerisation of $AB_2 + A$ monomers was also used by Han *et al.* to synthesis hyperbranched polymers with a narrow dispersity, a hydrophilic core and hydrophobic shell via the combination of self-condensing vinyl copolymerization (SCVCP) and reversible addition–fragmentation chain transfer (RAFT)⁹¹. The resulting polymer was modified by a click-like Menshutkin reaction to produce a water-soluble and clickable scaffold for further functionalisation. These polymers reportedly find potential applications as hyperbranched surfactants (amphiphilic character), hyperbranched ATRP macroinitiators and a novel dendritic polymer brush^{91,92}.

1.2.4 Properties and applications of hyperbranched polymers

The densely branched structure of hyperbranched polymers confers higher solubility and lower solution viscosity compared to linear polymers. The different solubility behaviour is due to the large numbers of end groups present within the structure of a hyperbranched polymer in comparison to a linear polymer with only two end-groups per chain. Moreover, hyperbranched polymers are fully amorphous, unable to crystallise as many linear polymers do; and are generally brittle materials because their structure does not allow for the formation of chain entanglements. Application of such polymers as bulk materials e.g. as engineering plastics, is therefore unrealistic. In academia, hyperbranched polymers have been widely discussed as drug carrier molecules or vectors for gene delivery to reproduce the behaviour of dendrimers, however the lack of a well-defined structure and broader dispersity make these polymers unsuitable for such applications. A more detailed discussion regarding potential biomedical applications can be found in the reviews of Gao and Yan³⁴ and Zheng⁹³. This section aims to provide an overview of the industrial applications of hyperbranched polymers. The combination of the properties mentioned above and the ability to synthesise hyperbranched polymers in a one-pot polymerisation on a large scale, has drawn significant attention in industry. For instance hyperbranched polymers with acrylate, vinyl ether, allyl ether, epoxy and hydroxyl-terminal groups can be cured and used as cross-linkers in coatings^{94,95}. Moreover, the high number of cross-linkable functional groups, together with the low viscosity and high solubility of hyperbranched polymers permits their use as powder coatings. Low solution and melt viscosity have led to applications as melt processing modifiers, additives and blend components for hyperbranched polymers. Kim and Webster, for instance, showed that bromo-terminated hyperbranched polyphenylene (5% w/w) blended with linear polystyrene reduced the melt viscosity and shear rates and improved the thermal stability with respect to pure polystyrene⁹⁶. Huber *et al.* observed a significant reduction in the melt viscosity of linear polyamide-6 without any loss of mechanical properties when only 0.1 % w/w of hyperbranched aromatic-aliphatic poly(ether amide)s was added; such properties suggest applications of hyperbranched polymers as processing aids⁹⁷.

Some of the most widely exploited commercial hyperbranched polymers are Hybrane[®] and Boltorn[®] polymers, depicted in Figure 1.7. Such polymers are produced on an industrial scale and are currently available from DSM Fine Chemicals (Geleen, Netherlands) and Perstorp Group (Perstorp, Sweden) respectively.

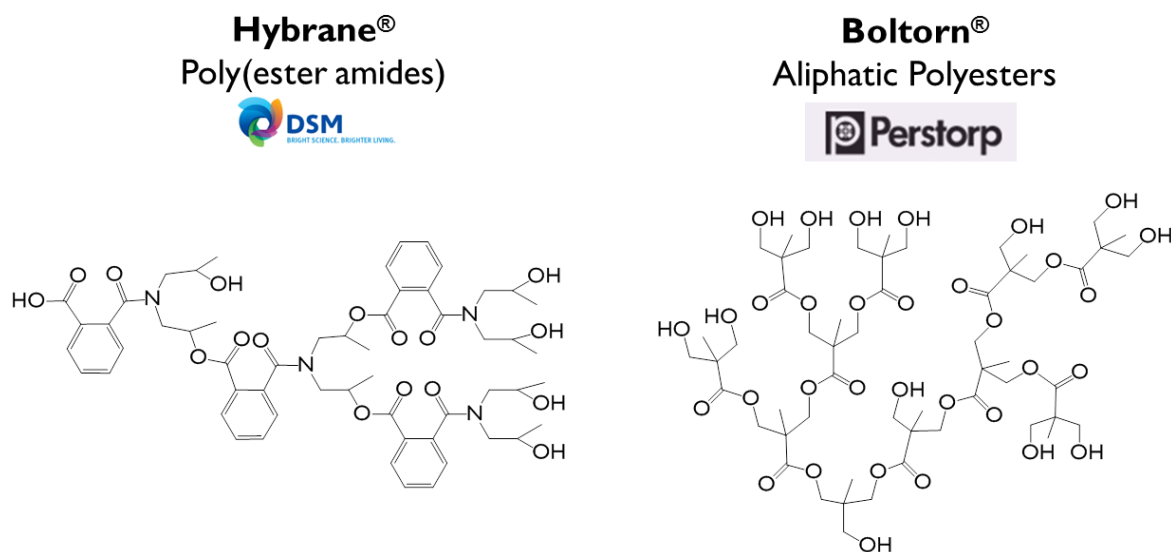

Figure 1.7 Commercially available hyperbranched polymers.

Hybrane® is an hydroxyl-functionalised hyperbranched poly(ester amide) obtained from the reaction of a cyclic anhydride (e.g. phthalic anhydride) with a diisopropanol amine and subsequent polycondensation reaction via an oxazolinium intermediate⁹⁸. The properties of Hybrane® can be modified by choosing a suitable anhydride compound in the process. Hybrane® has been successfully used in (i) textile applications as a dye-binder additive for polypropylene fibers⁹⁹, (ii) in oil field applications (Shell Global Solutions) to suppress the crystallisation of gas hydrate from the crude oil by delaying gas hydrate nucleation and crystal growth¹⁰⁰, (iii) in paper-coating applications to modify the rheology properties of the paper coating dispersion at the high operating speeds of the paper coating machine¹⁰¹ and (iv) for the separation of azeotropes mixtures containing water such as water/ethanol and water/dioxane due to selective interactions with water¹⁰².

Boltorn® polymers are hydroxyl-functionalised aliphatic polyesters synthesised by the polymerization of a multifunctional alcohol as a B₃ central core (2-(hydroxymethyl)-1,3-propanediol) and 2,2-bis(hydroxymethyl)propionic acid (Bis-MPA) as an AB₂ monomer¹⁰³. The average number of hydroxyl functionalities can be tailored from 8 to 64 per molecule and the M_w from 2000 to 11000 g/mol. The copolymerisation of bis-MPA in presence of a core keeps the $\bar{D} < 2$ and permits the development of a highly branched structure (DB c.a. 0.80). The main applications of Boltorn® vary from (i) a toughener for epoxy resins¹⁰⁴, (ii) a modifier for polystyrene and poly(styrene-co-maleic anhydride) for reducing their melt viscosity¹⁰⁵, (iii) a processing aid in the film-blowing process of linear low density polyethylene (LLDPE)¹⁰⁶, (iv)

a compatilizer to reduce the interfacial tension in blends of polypropylene/polyamide-6¹⁰⁷ and (v) a coating agent when modified with UV-curable groups such as methacryloyl groups¹⁰⁸.

In this chapter the state-of-art of hyperbranched polymers has been discussed remarking in particular on (i) the synthetic strategies used for the formation of a branched structure, the functionalization and the tailoring of the molecular weight and DB of the resulting product; (ii) the characterisation methods used to describe molecular structure, (iii) the problems related to the synthesis and the characterisation of such class of molecules; and finally (iv) a brief overview on their commercial application. In the light of the information gained, a novel approach for the synthesis of hyperbranched polymers via double-monomer methodology is described in the next chapters, discussing in detail the rationales of the studies carried out.

References

- ¹ Cowie, J. M. G., Arrighi, V. *Polymers: Chemistry and Physics of Modern Materials*. CRC Press **2008**.
- ² Odian, G. *Principles of Polymerisation*, J. Wiley & Sons, Inc., **2004**.
- ³ Rogers, M., Long, T. E. *Synthetic Methods in Step-Growth Polymers*, J. Wiley & Sons, Inc., **2003**.
- ⁴ Flory, P. J., *Principles of Polymer Chemistry*, Cornell Univ. Press, Ithaca, NY, **1953**.
- ⁵ Stille, J., K. *J Chem Ed*, **1981**, 8, 862-866.
- ⁶ Pinner, S. H. *J Polym Sci*, **1956**, 21, 153.
- ⁷ Yan, D., Gao, C., Frey, H. *Hyperbranched Polymers: Synthesis, Properties, and Applications*, John Wiley & Sons, Inc., Hoboken, New Jersey, **2011**.
- ⁸ Wooley, K. L., Fréchet, J. M. J., Hawker, C. *Polymer*, **1994**, 35, 4489-4495.
- ⁹ Voit, B. I., *C. R. Chimie*, **2003**, 6, 821–832.
- ¹⁰ Segawa, Y., Higashihara, T., Ueda, M. *Polym Chem*, **2013**, 4, 1746-1759.
- ¹¹ Voit, B. I., Lederer, A. *Chem Rev* **2009**, 109, 5924–5973.
- ¹² Voit, B. *J Polym Sci Part A*, **2000**, 38, 2505–2525.
- ¹³ Miravet, J. F., Fréchet, J. M. J. *Macromolecules*, **1998**, 31, 3461–3468.
- ¹⁴ Kim, Y. H., Webster, O. W. *J Am Chem Soc* **1990**, 112, 4592–4593.
- ¹⁵ Hobson L. J., Feast W. J. *Chem Commun*, **1997**, 21, 2067-2068.
- ¹⁶ Flory, P. J., *J Am Chem Soc*, **1952**, 74, 2718-2723.
- ¹⁷ Lu, P., Paulasaari, J. K., Weber, W. P. *Macromolecules*, **1996**, 29, 8583–8586.
- ¹⁸ Fréchet, J. M. J., Henmi, H., Gitsov, I., Aoshima, S., Leduc, M. R., Grubbs, R. B. *Science*, **1995**, 269, 1080-1083
- ¹⁹ Hawker, C. J.; Fréchet, J. M. J.; Grubbs, R. B.; Dao, J. *J Am Chem Soc*, **1995**, 117, 10763–10764.
- ²⁰ Liu, M. L.; Vladimirov, N.; Fréchet, J. M. J. *Macromolecules* **1999**, 32, 6881–6884..
- ²¹ Tokar, R.. Kubisa, P.. Penczek, S.. Dworak, A. *Macromolecules*, **1994**, 27, 320-322.
- ²² Dworak, A., Walach, W., Trzebicka, B. *Macromol Chem Phys*, **1995**, 196, 1963-1970.
- ²³ Sunder, A., Hanselmann, R., Frey, H., Mülhaupt, R. *Macromolecules*, **1999**, 32 , 4240-4246.

-
- ²⁴ Sunder, A., Frey, H., Mühlaupt, R. *Adv Mater*, **2000**, *12*, 235-239.
- ²⁵ Chang, H.-T., Fréchet J. M. J., *J Am Chem Soc*, **1999**, *121*, 2313–2314.
- ²⁶ Emrick, T., Chang, H. T., Fréchet, J. M. J. *Macromolecules*, **1999**, *32*, 6380-6382.
- ²⁷ Yan, D., Gao, C., *Macromolecules*, **2000**, *33*, 7693-7699
- ²⁸ Fang, J. F.; Kita, H.; Okamoto, K. I. *Macromolecules* **2000**, *33*, 4639-4646.
- ²⁹ Kricheldorf, H. R., Vakh tangishvili, L., Fritsch, D. J. *J. Polym Sci Part A* **2002**, *40*, 2967-2978.
- ³⁰ Gao, C., Yan, D. *Chem Commun*, **2001**, *1*, 107–108.
- ³¹ Zhu, S.-W., Shi, W.-F. *Polym Int*, **2002**, *51*, 223–227.
- ³² Gao, C., Yan, D., Tang, W. *Macromol Chem Phys*, **2001**, *202*, 2623–2629.
- ³³ Lin, Q., Long, T. E. *Macromolecules*, **2003**, *36*, 9809–9816.
- ³⁴ Gao, C., Yan, D. *Prog Polym Sci*, **2004**, *29*, 183–275.
- ³⁵ Jikei M.i, Chon, S.-H., Kakimoto, M.-A., Kawauchi, S., Imase, Watanebe T. J. *Macromolecules*, **1999**, *32*, 2061–2064
- ³⁶ Liu, Y.-L., Tsai, S.-H., Wu, C.-S., Jeng, R.-J. *J Polym Sci Part A*, **2004**, *42*, 5921–5928.
- ³⁷ Tang, L., Fang, Y., Tang, X. J. *Polym Sci Part A*, **2005**, *43*, 2921–2930.
- ³⁸ Wu, D., Liu, Y., Chen, L., He, C., Chung, T. S., Goh, S. H. *Macromolecules*, **2005**, *38*, 5519–5525.
- ³⁹ Gao, C., Tang, W., Yan, D. Y. *J Polym Sci Polym Chem*, **2002**, *40*, 2340–2349.
- ⁴⁰ Stumpe, K., Komber, H., Voit, B. I. *Macromol Chem Phys*, **2006**, *207*, 1825–1833
- ⁴¹ Li, H., Wu, H., Zhao, E., Li, J., Sun, J. Z., Qin, A., Tang, B. Z. *Macromolecules*, **2013**, *46*, 3907–3914.
- ⁴² Connor R., McClellan, W. R. *J Org Chem*, **1938**, *3*, 570-577.
- ⁴³ Vernon B., Tirelli N., Bachi T., Haldimann D., Hubbell J. *J Biomed Mater Res*, **2003**, *64*, 447–56.
- ⁴⁴ Vaccaro E., Scola D. A., *Chemtech*, **1999**, *29*, 15–23.
- ⁴⁵ Wang, D., Yu, Z.-Q., Hong, C.-Y., You Y.-Z. *Eur Polym J*, **2013**, *49*, 4189–4194.
- ⁴⁶ Mather, B. D., Viswanathan, K., Miller, K. M., Long, T. E., *Prog Polym Sci*, **2006**, *31*, 487–531.
- ⁴⁷ Danusso F., Ferruti P. *Polymer*, **1970**, *11*, 88–113.
- ⁴⁸ Ranu, B.C., Banerjee S. *Tetrahedron Lett*, **2007**, *48*, 141-143.
- ⁴⁹ Wu, D., Liu, Y., He, C., Chung, T., Goh, S. *Macromolecules*, **2004**, *37*, 6763-6770.
- ⁵⁰ Hong, C.-Y., You, Y.-Z., Wu, D.-C., Liu, Y., Pan, C.-Y. *J Am Chem Soc*, **2007**, *129*, 5354-5355.
- ⁵¹ Gong, C., Miravet, J., Fréchet, J. M. J. *J Polym Sci Part A*, **1999**, *37*, 3193-3201.
- ⁵² Hölter, D., Burgath, A., Frey, H. *Acta Polymer*, **1997**, *48*, 30–35.
- ⁵³ Hölter, D., Frey, H. *Acta Polymer*, **1997**, *48*, 298-309.
- ⁵⁴ Cheng, K. C., Chuang, T. H., Chang, J. S., Guo, W., Su, W. F. *Macromolecules*, **2005**, *38*, 8252–8257.
- ⁵⁵ Hanselmann, R., Holter, D., Frey, H. *Macromolecul*, **1998**, *31*, 3790-3801
- ⁵⁶ Bharathi P., Moore, J. S., *Macromolecules*, **2000**, *33*, 3212–3218.
- ⁵⁷ Schmaljohann, D., Voit, B. I. *Macromol Theory Simul*, **2003**, *12*, 679–689.
- ⁵⁸ Unal, S., Lin, Q., Mourey, T. H., Long, T. E. *Macromolecules*, **2005**, *38*, 3246-3254.
- ⁵⁹ Manaresi P., Munari A., Pilati F., Alfonso G. C., Russo S., Sartirana L. *Polymer*, **1986**, *27*, 955–960
- ⁶⁰ Flory, P. J. *J Am Chem Soc*, **1941**, *63*, 3083-3096.
- ⁶¹ Stockmayer, W. A. *J Chem Phys*, **1944**, *12*, 125-131.

- ⁶² Hudson, N., MacDonald, W. A., Neilson, A., Richards, R. W., Sherrington D. C. *Macromolecules*, **2000**, *33*, 9255-9261.
- ⁶³ Rosu R. F., Shanks R. A., Bhattacharya S. N. *Polym Int*, **1997**, *42*, 267-275.
- ⁶⁴ Maruyama, K., Kudo, H., Ikehara, T., Ito, N., Tadatom, N., *J Polym Sci Part A*, **2005**, *43*, 4642-4653.
- ⁶⁵ Hawker, C. J., Lee R., Fréchet, J. M. J. *J Am Chem Soc*, **1991**, *113*, 4583-4595.
- ⁶⁶ Chen, L., Zhu, X. Y., Yan, D. Y., Chen, Y., Chen Q., Yao, Y. F. *Angew Chem Int Ed*, **2006**, *45*, 87-90.
- ⁶⁷ Jia, Z. F., Chen, H., Zhu X. Y., Yan, D. Y. *J Am Chem Soc*, **2006**, *128*, 8144-8145.
- ⁶⁸ Kambouris P., Hawker, C. J. *J Chem Soc, Perkin Trans 1*, **1993**, 2717-2721
- ⁶⁹ Bolton D. H., Wooley, K. L. *J Polym Sci Part A*, **2002**, *40*, 823-835.
- ⁷⁰ Hutchings, L. R., Dodds J. M., Roberts-Bleming, S. J. *Macromolecules*, **2005**, *38*, 5970-5980.
- ⁷¹ Wooley, K. L., Hawker, C. J., Lee, R. Fréchet, J. M. J. *Polym J*, **1994**, *26*, 187-197.
- ⁷² Gao, C., Xu, Y., Yan, D., Chen, W. *Biomacromolecules*, **2003**, *4*, 704-712.
- ⁷³ Parker, D., Feast, W. J. *Macromolecules*, **2001**, *34*, 2048-2059.
- ⁷⁴ Unal, S., Oguz, C., Yilgor, E., Gallivan, M., Long, T. E., Yilgor, I. *Polymer*, **2005**, *46*, 4533-4543.
- ⁷⁵ Morikawa, A., Akagi M. *Polym J*, **2013**, *45*, 614-621.
- ⁷⁶ Komber, H., Voit, B., Monticelli, O., Russo, S. *Macromolecules*, **2001**, *34*, 5487-5493
- ⁷⁷ Radke, W., Litvineko G., Müller, A. H. E. *Macromolecules*, **1998**, *31*, 239-248.
- ⁷⁸ Ishida, Y., Sun, A. C. F., Jikei M., Kakimoto, M. *Macromolecules*, **2000**, *33*, 2832-2838.
- ⁷⁹ Wang J. Y., Johnson, D. M. *Polym Int*, **2009**, *58*, 1234-1245.
- ⁸⁰ Lederer, A., Voit, D., Clausnitzer, C., Voit, B. *J Chromatogr A*, **2002**, *976*, 171-179.
- ⁸¹ Turner, S. R., Voit, B. I., Mourey, T. H. *Macromolecules*, **1993**, *26*, 4617-4623.
- ⁸² Pu, K., Shi, J., Cai, L., Li K., Liu, B. *Biomacromolecules*, **2011**, *12*, 2966-2974.
- ⁸³ Roy R., Ramakrishnan, S. *J Polym Sci Part A*, **2011**, *49*, 1735-1744.
- ⁸⁴ Shen, Y., Kuang, M., Shen, Z., Nieberle, J., Duan H., Frey, H. *Angew Chem Int Ed*, **2008**, *47*, 2227-2230.
- ⁸⁵ Wang, D., Zheng, Z., Hong, C., Liu, Y., Pan, C. *J Polym Sci Part A*, **2006**, *44*, 6226-6242.
- ⁸⁶ Liang, Y., Wan, D., Cai, X., Jin M., Pu, H. *J Polym Sci Part A*, **2010**, *48*, 681-691.
- ⁸⁷ Saha A., Ramakrishnan, S. *Macromolecules*, **2009**, *42*, 4956-4959.
- ⁸⁸ Saha A., Ramakrishnan, S. *Macromolecules*, **2009**, *42*, 4028-4037.
- ⁸⁹ Saha A., Ramakrishnan S. *Macromolecules*, **2008**, *41*, 5658-5664.
- ⁹⁰ Maruyama, K., Hirabayashi, T., Kudo, H., Nishikubo T. *Polym J*, **2010**, *42*, 790-794.
- ⁹¹ Han, J., Li, S., Tang A., Gao, C. *Macromolecules*, **2012**, *45*, 4966-4977.
- ⁹² Li, S., Han J., Gao, C. *Polym Chem*, **2013**, *4*, 1774-1787.
- ⁹³ Zheng, Y., Li, S., Weng, Z., Gao, C. *Chem. Soc. Rev.*, **2015**, *44*, 4091-4130.
- ⁹⁴ Johansson, M., Malmström, E., Hult, A. *J Polym Sci Part A: Polym Chem*, **1993**, *31*, 619-624.
- ⁹⁵ Schmaljohann, D., Voit, B. I., Jansen, J. F. G. A., Hedriks, P., Loontjens, J. A. *Macromol Mater Eng*, **2000**, *275*, 31-41.
- ⁹⁶ Kim, Y. H., Webster, O. W. *Macromolecules*, **1992**, *25*, 5561-5572.
- ⁹⁷ Huber, T., Böhme, F., Komber, H., Kronek, J., Luston, J., Voigt, D., Voit, B. *J Macromol Chem Phys*, **1999**, *200*, 126-133.
- ⁹⁸ Froehling, P. *J Polym Sci Part A*, **2004**, *42*, 3110-3115.

- ⁹⁹ Burkinshaw, S. M., Froehling, P. E, Mignanelli, M, *Dyes Pigm*, **2002**, *53*, 229-235.
- ¹⁰⁰ Shell International Research. *PCT Patent WO 01/77270*, **2000**.
- ¹⁰¹ Topchim NV. *PCT Patent WO 02/48459*, **2000**.
- ¹⁰² Seiler, M., Köhler, D., Arlt, W. *Sep Purif Technol*, **2002**, *29*, 245-263.
- ¹⁰³ Malmström, E., Johansson, M., Hult, A. *Macromolecules*, **1995**, *28*, 1698-1703.
- ¹⁰⁴ Mezzenga, R., Boogh, L., Manson J-AE. *Compos Sci Technol*, **2001**, *61*, 787–795.
- ¹⁰⁵ Mulkern, T.J., Tan, N.C.B. *Polymer*, **2000**, *41* 3193–3203.
- ¹⁰⁶ Hong, Y., Coombs, S.J., Cooper-White, J.J., Mackay, M.E., Hawker, C.J., Malmström, E., Rehnberg, N. *Polymer*, **2000**, *41*, 7705–7713.
- ¹⁰⁷ Jannerfeldt, G., Boogh, L., Manson, J-AE. *J Polym Sci Part A*, **1999**, *37*, 2069–2077.
- ¹⁰⁸ Wan, Q., Schrick, S.R., Culbertson, B.M., *J Macromol Sci Pure*, **2000**, *11*, 1317–1331.

Chapter 2

Aim of the project

2.1 Aim of the project

On the base of the work reported in literature for hyperbranched polymers, hyperbranched poly(ester amine)s (PEAs) and poly(amido amine)s (HPAMAMs) are synthesised by the double monomer methodology (DMM) of multifunctional monomers^{1,2} via Michael addition reaction. We selected this method because: (i) provides a simple route for the synthesis of a family of hyperbranched polymers; (ii) offers the possibility to tailor the properties of the polymer thanks to the variety of monomers commercially available and (iii) allows the scale up of the reaction. Although the direct polymerisation of multifunctional monomers was born as a cross-linking methodology (Flory's theory)^{3,4}, strategies have been developed for the synthesis of gel-free hyperbranched polymers such as the use of monomers pairs in which at least one of the two monomers has asymmetrical functionality (e.g. $A_2+B'B_2$).

In the present study hyperbranched poly(ester amine)s and poly(amido amine)s are synthesised using monomer pairs (A_x+B_y) with symmetric functional groups. In both cases two linear building blocks are used, each bearing two functionalities as end-groups; in particular a diamine is used as B_4 monomer and diacrylate and diacrylamide is used as A_2 monomer for PEAs and HPAMAMs respectively. The system A_2+B_4 with symmetric functionalities is less common than the system $A_2+B'B_2$ with asymmetric functionalities for the synthesis of hyperbranched polymers because of the higher risk of gelation. Gelation (crosslinking) during the polymer synthesis is normally something to be avoided because in an industrial perspective it could lead to serious consequences if it occurs in large scale reactor. Gelation is more likely for the A_2+B_4 system because: (i) the reaction of A_2 with B_4 leads ideally to a two-step polymerisation in which the intermediate formed is still a species with symmetrical functional groups (secondary amine); (ii) the resulting secondary amine groups are more reactive than primary amine (second stage of the reaction faster than first one) and (iii) the monomer feed ratio has to permit the reaction of resulting secondary amine for the formation of a branched structure. Thus, control over the polyaddition can be easily lost and for this reason the choice of the reaction conditions are crucial. Although the use of the A_2+B_4 is uncommon for the synthesis of hyperbranched poly(ester amine)s and poly(amido amine)s, we found this system particularly attractive because it can potentially form a product with higher number of functional terminal groups and branch points with respect to the other systems generally used such as $A_2+B'B_2$ ⁵.

The general aims of the project are:

1. Exploring the reaction conditions of the polyaddition A_2+B_4 for the synthesis of PEAs and HPAMAMs as first approach to control gelation. In both cases the effect of the molar ratio is studied; the molar ratio is particularly important because determinates the final structure and molar mass of the polymer. Moreover, parameters such as temperature, concentration for PEAs and type of solvent and the time of the reaction for HPAMAMs are further investigated.
2. Developing an effective strategy that permits to overcome the problem of gelation typical of the A_2+B_4 system. The effectiveness of the proposed method aim to the industrial scale up of the polymerisations without risk of gelation in the reactor.
3. Modification of the chemical structure of the synthesis polymers by using: (a) different type of B_4 monomer in the polyadditions A_2+B_4 (point 1) and (b) the strategy in point (2) that will be developed on a dual-goal of avoiding gelation during the polymerisation and functionalising the polymer in one-pot reaction. The results found in the points 1 and 2 provide the optimal reaction conditions to carry out reactions at this stage.
4. Studying and comparing the stability of PEAs and HPAMAMs in protic solvents such as methanol or water to understand their long-term stability.
5. Exploring potential industrial applications for the synthesised polymer by studying the properties of these polymer.

The results of this work aspire to provide evidences of the progress of the state of art of hyperbranched polymers synthesised by A_2+B_4 with a view to a potential future commercialisation of these polymers.

The project was funded by Croda International and the scale up of the reactions and the application tests were carried in their laboratories: Croda (Hull) for the scale up and Croda (Cowick) for the application tests.

References

- ¹ Mather, B. D., Viswanathan, K., Miller, K. M., Long, T. E. *Prog Polym Sci*, **2006**, *31*, 487–531.
- ² Gao, C., Yan, D. *Prog Polym Sci*, **2004**, *29*, 183–275.
- ³ Flory, P. J. *J Am Chem Soc*, **1941**, *63*, 3096–3100.
- ⁴ Carothers, W. H., *Trans Faraday Soc*, **1936**, *32*, 39-49.
- ⁵ Kricheldorf, H. R., Vakhtangishvili, L., Fritsch, D. *J Polym Sci Pol Chem*, **2002**, *40*, 2967-2978.

Chapter 3

Hyperbranched poly(ester amine)s Synthesis, Characterisation and Stability in Protic Solvents.

3.1 Hyperbranched poly(ester amine)s by double monomer methodology (DMM) via aza-Michael addition reaction: state of art.

Hyperbranched poly(ester amine)s (PEAs) can be synthesised via the aza-Michael addition polymerisation of symmetrical (e.g. A_2+B_4 , A_2+B_3)¹ and asymmetric (e.g. $A_2+B'B_2$, $AA'+B_3$)^{2,3,4} monomer pairs. In a typical reaction, the monomers bearing two or more acrylate groups act as an aza-Michael acceptor while those with two or more amine groups, with or without different reactivity (primary and/or secondary) act as aza-Michael donors. Scheme 3.1 shows an example of a typical aza-Michael addition polymerisation carried out using asymmetric monomer pairs². The asymmetric route is generally preferred to the symmetric route because the polymerisation proceeds via a multistage process with a greater control over gelation – a typical side reaction when multifunctional monomers are used⁵.

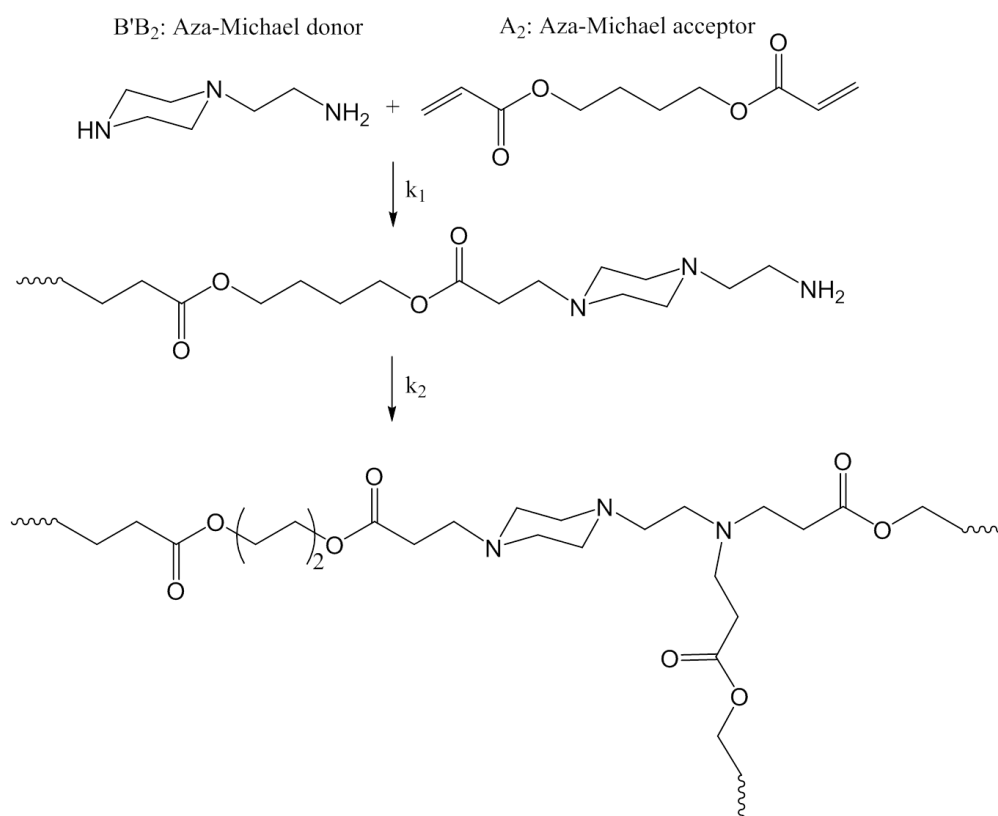

Scheme 3.1 Synthesis of hyperbranched poly(ester amine) via Michael addition of A_2 and $B'B_2$ monomers.

Figure 3.1 shows examples of monomers typically used in the aza-Michael addition polymerisation. It is worth noting that the reactivity of the aza-Michael donor (amine) depends not only on the type of functional groups but also on the chemical environment of the active group within the monomer structure. In fact, steric hindrance of the B groups can modify their reactivity and consequently lead to a change of the architecture of the polymer⁶.

Aza-Michael donor used:**Aza-Michael acceptor used:**

Figure 3.1 Examples of typical Michael donors and Michael acceptors used for the synthesis of hyperbranched poly(ester amine)s. TMPTA-AEPZ¹¹, EGDA-TEPA⁹, EGDA/BDDA/HDDA-AEPZ/AMPD/MEDA³⁰, TMPETA-AEPZ/API/DED/HYD¹², BDDA-AEPZ^{5,6}, PEGDA-EOBEA¹, GTA-PEI⁷.

Although the use of symmetrical monomer pairs can reduce the control of the polymerisation reaction because of the higher risk of gelation, both approaches are able to produce soluble hyperbranched polymers under certain reaction conditions. In particular, the choice of reaction

temperature, solvent, monomer concentration, manner of monomer addition and monomer feed ratio for a given system, all play an important role in determining the fate of the polymerisation reaction and hence promoting the synthesis of fully-soluble branched polymers^{3,4,8,9,10}.

For the polymerisation of $A_2+B_1B_2$ monomers pairs such as ethylene glycol diacrylate (EGDA) and 1-(2-aminoethyl) piperazine (AEPZ), it has been reported that gelation does not occur when the molar ratio $A_2: B_1B_2$ was 1:1 and 3:2³. However, when a molar ratio of 3:2 was used, the monomer concentration and the reaction temperature was shown to play an important role and gelation could only be avoided in dilute conditions and at temperatures lower than 40°C. The reaction EGDA:AEPZ with molar ratio 1:1 was attempted in various solvents such as $CHCl_3$, DMSO, DMF, DMA, NMP at 40 °C for 5 days and in all cases hyperbranched polymers were obtained, with a degree of branching higher than 50% and M_w ranging from 15,000 to 20,000 $g\ mol^{-1}$ with a $\mathcal{D} < 1.4$ (values obtained by aqueous SEC relative to standards of PEO)³. The surprisingly narrow distribution is due to the reprecipitation of the polymer, which removes the low molecular weight fraction.

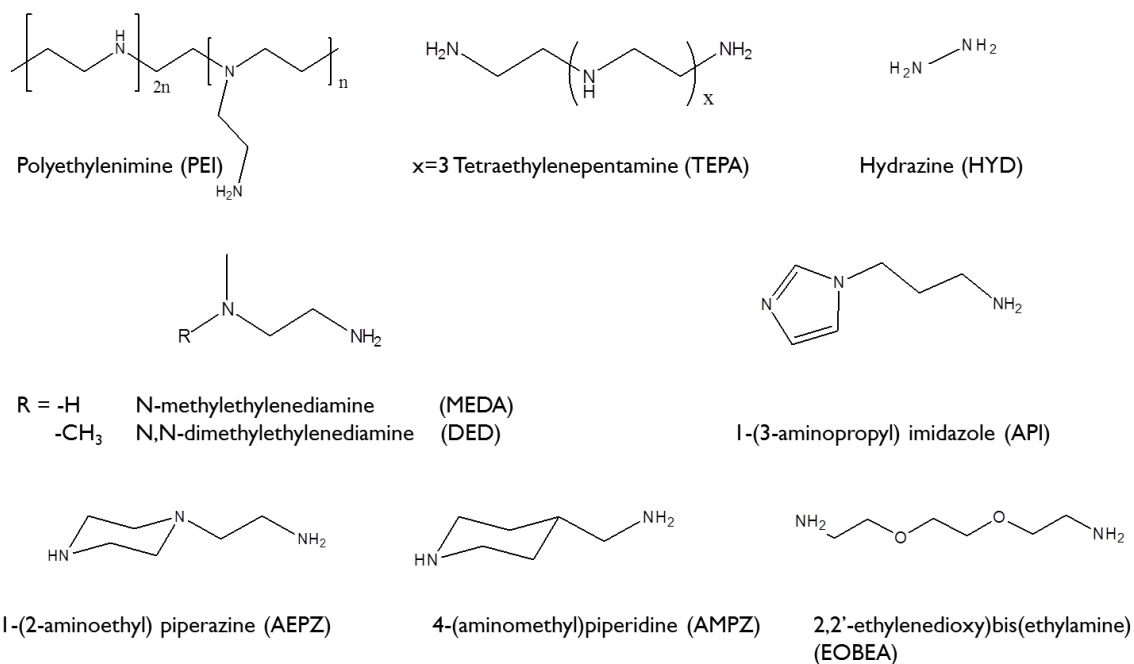
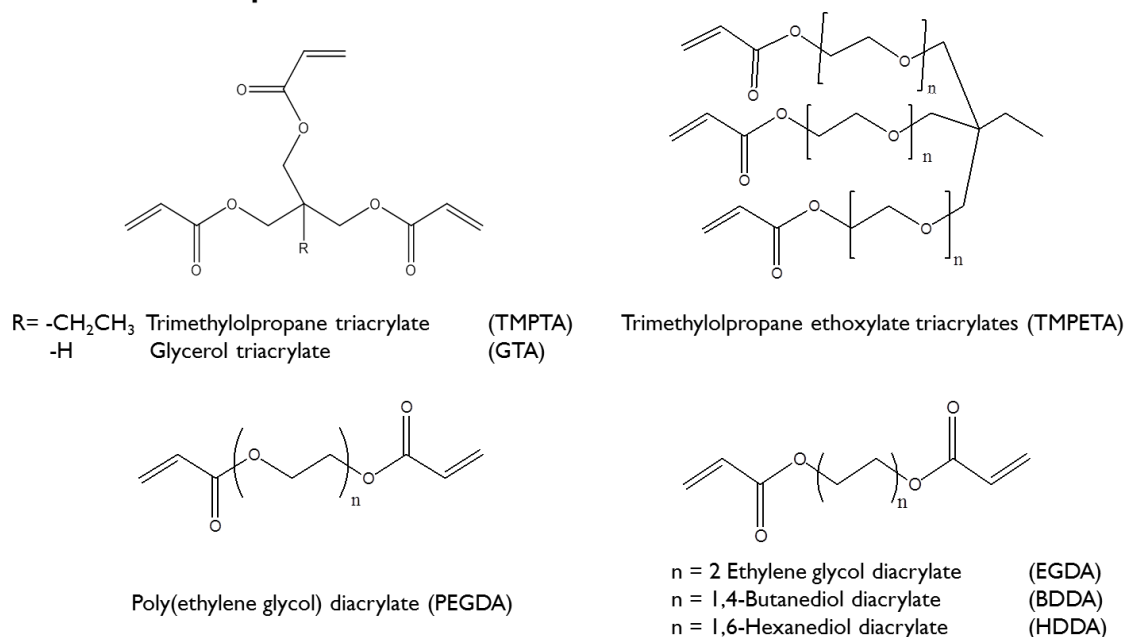
Aprotic solvents are normally used for the synthesis of hyperbranched poly(ester amine)s, to ensure the stability of the ester units, which are otherwise hydrolysable in protic solvents like water, and for promoting the formation of high molecular weight polymer^{3,5,9}. The long-term stability of such groups in protic solvents was investigated in the current work and is discussed in section 3.4.3.

Previous reports describe how polymerisation reactions that yield soluble hyperbranched poly(ester amine)s have been quenched by (1) end-capping the vinyl terminal groups of the polymer with monomers bearing an amine as functional group and precipitation of the reaction mixture in a suitable non-solvent^{1,5} or alternatively (2) by precipitating the reaction mixture directly in a suitable non-solvent containing concentrated aqueous HCl^{11,12}. HCl, in this case, can be used to “deactivate” the amine groups within the polymer from further reaction with the residual acrylate groups and at the same time form hyperbranched polycations by the quaternisation reaction.

Hyperbranched PEAs synthesised using the pairs of the monomer shown in Figure 3.1 are generally soluble in organic solvents such as DMF, DMSO, DMA, NMP, $CHCl_3$ but poorly soluble in THF¹³. Polymers synthesised from hydrophobic monomers e.g. HDDA in Figure 3.1 are more soluble in THF¹⁴. The solubility in water of these polymers depends on the nature of the starting monomers and the presence or absence of charge on the structure; in fact polymers

in the protonated form, obtained for instance from the precipitation of the mixture in acidic conditions, are fully soluble in water and often insoluble in organic solvents^{12,31}.

In the synthesis of hyperbranched poly(ester amines), the molar ratio of the acrylate and the amine groups, beyond simply controlling gelation, can dictate which functional group will be found at the terminal units in the resulting polymer¹⁵. For example, when a feed ratio of diacrylate to diamine (BB'-type) of 2:1 is used, hyperbranched PEAs with terminal acrylate groups can be obtained⁵. The synthesis of hyperbranched polymers with reactive terminal groups permits further modification of the polymer by post-polymerisation reactions. Primary, secondary or tertiary amines⁵, as well as monohydroxyl and diol groups¹⁶ are examples of terminal groups introduced by post-polymerisation of the residual vinyl groups of the polymer (Scheme 3.2).

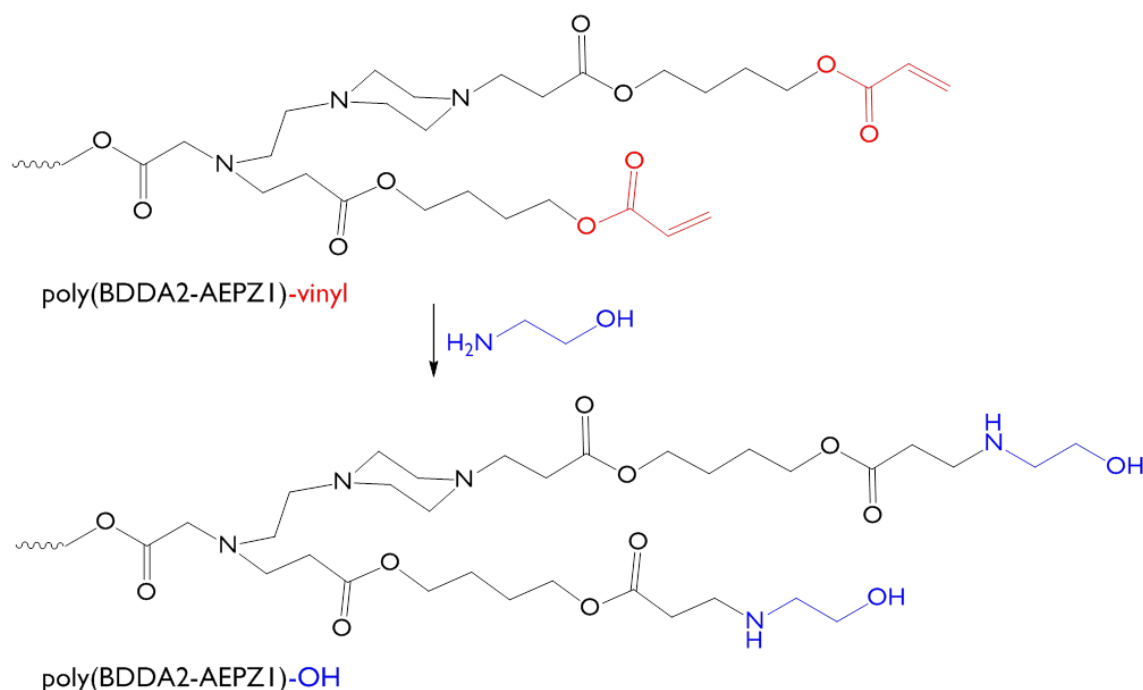

Scheme 3.2 Modification of the acrylate end groups of a hyperbranched poly(ester amine) with hydroxyl groups by post-polymerisation¹⁶.

Hyperbranched poly(ester amine)s have drawn attention for potential biomedical applications such as a matrix for drug delivery^{11,17,18,19}. Generally speaking, such polymers are good candidates as non-viral vectors in gene delivery if they have (1) high transfection efficiency (the ability to transport biomolecules into the cells) and (2) low cytotoxicity. Hyperbranched poly(ester amine)s are in fact good candidates because the first requirement is satisfied by the amino groups within the polymer structure while the second requirement is met by the hydrolysis of the ester linkages. In particular, amine groups promote, in their protonated form,

the transfection by electrostatic interactions with negatively charged biomolecules such as drugs and nucleic acids²⁰. In addition, the amine groups exhibit a buffering effect, also called the 'proton sponge' effect because of their ability to capture a large amount of protons in an acidic environment, over a wide pH-range^{17,21}. On the other hand ester groups, as hydrolysable groups, decrease the toxicity of these carriers by allowing degradation of the polymer into low molecular weight fragments²². Thus, polycations with low molecular weights have lower charge density than those with high molecular weight and consequently they interact less with the negatively charged cellular membrane reducing in this way toxicity²³. Beyond hyperbranched poly(ester amine)s, other structures such as linear^{20,24,25,26} and crosslinked^{27,28,29} PEAs have been investigated for the application of this type of polymer as non-viral gene carriers. Hydrolysis of ester functionalities in pure water is generally slow; for this reason it is usually catalysed by either acid or basic conditions. Hyperbranched poly(ester amines)s can be hydrolysed in pure water because the unprotonated amino groups in the polymer act as an intramolecular nucleophilic catalyst^{9,12,30}. For this reason degradation is mainly affected by (i) the pH of the aqueous solution in which the polymer is dissolved (ii) the topology of the polymer and (iii) the internal spatial structure. In particular, faster degradation occurs at pH 7.4 rather than pH 5.1 because of the higher fraction of unprotonated amino groups; cleavage of 40% of ester groups takes place in 1 day at pH 7.4 and 7 days at pH 5.1^{11,12,30}. Moreover, the stability of the polymer in water increases with decreased accessibility of the ester groups and limited flexibility of the polymer structure, which reduces the interaction between amine and ester groups. It follows that a cross-linked structure is more stable in aqueous medium than the hyperbranched structure which is in turn more stable than a linear structure^{12,28}. Terminal amine groups (1°, 2°, 3° amine) generally have a negligible effect on the hydrolysis profiles; the hydrolysis rate is instead influenced by the internal spatial structure as dictated by (i) the nature of the spacer: hydrophilic spacers attract water molecules to the ester sites encouraging the decomposition and (ii) the length of the hydrophilic spacers: longer spacers degraded faster than those with shorter spacers because of the formation of looser structures with more flexible chains, hence, ester sites are more easily accessible³¹.

The degradation of hyperbranched poly(ester amine)s has been mainly studied by ¹H-NMR, by comparing of the integrals of the signals attributed to the methylene protons of the ester (-COOCH₂-) and hydroxyl groups (HOCH₂-) which are the product of the hydrolysis of the ester bonds^{30,31}. Another method reported to analyse the decomposition of hyperbranched polymers is liquid chromatography–mass spectroscopy (LC-MS) of the degradation products³⁰.

3.2 Rationale and aim of the study

In the present study hyperbranched poly(ester amine)s are synthesised via aza-Michael addition using monomer pairs with readily available, symmetric functional groups ($A_x + B_y$); in particular a diacrylate such as PEGDA (poly(ethylene glycol) diacrylate) is used as the A_2 monomer and the diamines EDA (ethylenediamine) or HDA (hexamethylenediamine) as B_4 monomer. The major drawback of the selected strategy (A_2+B_4) is the possibility to form insoluble crosslinked gel product rather soluble hyperbranched polymers. However Tu *et al.* proved the potential validity of the strategy with monomer pairs such as PEGDA (A_2) and 2,2'-(ethylenedioxy)bis(ethylamine) EOBEA (B_4)¹. They found that hyperbranched polymers with different degrees of branching could be synthesised in DMF at 60°C, by regulating the feed molar ratio of A_2 and B_4 . The strategy adopted to avoid gelation involved the end-capping of the residual acrylic terminal groups of the polymer with dimethylamine (DEA) - post-polymerisation.

In the present work we explore the $A_2 + B_4$ system and in particular consider the key parameters of the reaction such as molar ratio, temperature and concentration as a first approach to control/limit gel formation and produce soluble hyperbranched polymers from PEGDA (A_2) and HDA/EDA (B_4) as monomers. The molar ratio is particularly important for this system, because it largely dictates the structure of the final product; the starting monomers are in fact linear units which are able to develop a branched structure from the reaction of their functional groups. Once the role played by the various reaction parameters on the polymerisation is understood, a new approach will be presented for the synthesis of hyperbranched poly(ester amine) that can potentially reduce or eliminate, the risk of gelation of the “ $A_2 + B_4$ ” system in a one-pot reaction. The new synthetic strategy is based on an “ $A_2 + A + B_4$ ” system in which the A-monomer is added during polymerisation rather than post-polymerisation. The introduction of a mono-functional monomer within an $A_2 + B_4$ system reduces the risk of formation of cross-linked species by end-capping a portion of functional groups. The addition of a small amount of mono-functional (A) co-monomer also represents a strategy to control the molecular weight of a polymer in step-growth polymerisation because it acts as chain-stopper in a growing polymer³². Therefore the proposed “ $A_2 + A + B_4$ ” strategy should not only inhibit gelation but also regulate the molecular weight of the resulting polymer. The use of similar strategies is rare but have been successfully used to limit cross-linking in the synthesis of hyperbranched poly(ethylene terephthalate) (PET) by using $A_2 + B_2 + A_3$ ³³, $A_2 + B_2 + B_3$ (or B_4) + B ³⁴ and $A_2 + B_4 + B$ ³⁵ systems. For the synthesis of hyperbranched poly(ester amine)s, the use

of mono-functional monomers with amine groups to end-cap the acrylate terminal groups only at the end of the polymerisation to prevent further reactions that could lead to gelation has been reported^{1,5}.

We propose; (a) the use a mono-functional monomer as a starting material rather than added at the end of polymerisation as is generally the case and (b) the end-capping of the N-H groups of the B₄ monomer instead of the acrylate groups, since B₄ generates the branched units in the polymer and at high conversions, a cross-linked structure. Thus, in a one-pot reaction it should be possible to simultaneously (i) allow the polyaddition between A₂ and B₄ monomer; (ii) control/inhibit gelation by tuning the number of functional groups available for the polymerisation and (iii) orthogonally functionalise the hyperbranched polymer by selecting specific functionalised mono-acrylate monomers to confer precise properties to the polymer. In the light of these considerations, the method aims to provide a scalable route to hyperbranched PEAs using cheap and readily available starting materials. Moreover, this method also offers great advantages over strategies which seek to quench reactions before the gel point (Chapter 1, section 1.2.1.2) as it should be no longer necessary to monitor and stop the reaction at a certain conversion of functional groups above which gelation occurs. The choice of an “A₂ + B₄” system is further justified in this case, because alternative systems for the synthesis of branched poly(ester amine) such as “A₂ + B'B₂” would not lead to an end-capped and functionalised polymer with a branched structure as final product.

Hyperbranched poly(ester amine)s are (bio)degradable polymers in which the amino groups catalyse the hydrolysis of ester groups. Therefore the stability of these polymers is also investigated and reported. Generally, the stability of PEAs is studied in water for their application in gene delivery however in the present work a similar but alternative route of decomposition of the hyperbranched poly(ester amine) in methanol has been observed, where transesterification takes place. This side reaction was studied by SEC analysis and NMR. The degradation of these polymers, whilst attractive for some applications, is an issue that limits their potential for long-term applications. Thus a novel strategy to delay degradation is also proposed. The strategy is based on the “A₂ + B₄·2HCl” system in which the amine groups of the B₄ monomer are replaced with quaternary amine groups. Feast *et al.*³⁶ reported the synthesis of cationic hyperbranched poly(amino amide), analogues of the Tomalia PAMAM dendrimer, by a single monomer methodology using an ammonium salt monomer. In Figure 3.2 the type of monomer used and the mechanism proposed for the polymerisation is depicted.

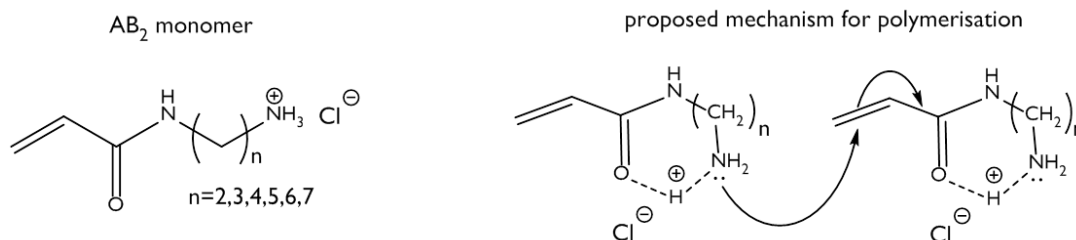

Figure 3.2 Melt polymerisation for the synthesis of hyperbranched poly(amido amine) via aza-Michael addition of aminoacrylate hydrochloride monomers (AB₂-type) shown on left side³⁶. On the right side a possible mechanism of the reaction proposed by the author is depicted.

The polyaddition of a series of AB₂ aminoacrylate hydrochloride monomers was carried out in the melt by a Michael addition reaction where A is the Michael acceptor and B₂ is the HCl salt of a primary aliphatic amine. Inspired by this work, we investigated the Michael addition polymerisation of an acrylate group (A) with an ammonium hydrochloride group (B) but via the double monomer methodology “A₂ + B₄·2HCl”. This approach also represents a novel method for the synthesis of charged and more stable hyperbranched poly(ester amine)s in a one-pot reaction.

3.3 Experimental part

3.3.1 Materials and reagents

Poly(ethylene glycol) diacrylate (PEGDA: M_n=575 g/mol), hexamethylenediamine (HDA: 98%), ethylenediamine (EDA: ReagentPlus®, ≥99%) methyl methacrylate (MMA: 99%, contains ≤30 ppm MEHQ as inhibitor), methyl acrylate (MA: 99%, contains ≤100 ppm monomethyl ether hydroquinone as inhibitor), diethylamine (DEA; ≥99.5%), hexamethylenediamine dihydrochloride (HDDC: 99%), triethylamine (TEA: ≥99%), N,N-dimethylformamide (DMF: anhydrous, 99.8%,), chloroform-d (CDCl₃ 99.96 atom % D), dimethyl sulfoxide-d₆ (DMSO-d₆ 99.96 atom % D), deuterium oxide (D₂O: 99.9% atom % D), diethyl ether (ACS reagent, anhydrous, ≥99.0% contains BHT as inhibitor,), tetrahydrofuran (THF, contains 250 ppm BHT as inhibitor, ACS reagent, ≥99%), dimethyl sulfoxide (DMSO), were purchased from Sigma-Aldrich. Except for THF, all the other compounds were used without any purification. THF was dried over 3Å molecular sieves (20% w/v) for 48 hours³⁷. PEO standards were purchased from Polymer Laboratories.

3.3.2 Characterisation techniques

Size exclusion Chromatography (SEC)

The number-average molecular weight (M_n), weight-average molecular weight (M_w) and dispersity (\mathcal{D}) of the synthesised polymers and PEGDA monomer were determined by size exclusion chromatography (SEC) using a Viscotek TDA 301 with triple detectors: refractive index, right-angle light scattering, and viscosity. Two PLgel 5 μ m mixed C columns were used (linear range of molecular weight from 200-2,000,000 g/mol) were used. DMF with 0.1% of LiBr was used as the mobile phase at a flow rate of 1.0 ml/min at 70 °C. The molecular weight was determined by means a conventional calibration curve (log MW vs. retention volume, which was generated using a series of PEG/PEO polymer standards (Polymer Labs).

The number-average molecular weight (M_n), weight-average molecular weight (M_w) and dispersity (\mathcal{D}) of PEGDA monomer was further analysed by SEC on a triple detection Viscotek TDA 302 with refractive index, light scattering, and viscosity detectors and 2 x 300 mm 5 μ m PLgel mixed C columns that have a linear range of molecular weight from 200-2,000,000 g/mol. The solvent was THF, the flow rate was 1.0 ml/min at a temperature of 35°C. The molecular weight was determined by means a conventional calibration curve (log MW vs. retention volume, which was generated using a series of PS polymer standards (Polymer Labs).

The samples of the reactions performed in bulk were prepared for SEC analysis by weighing 1 mg of the reaction mixture and diluting it in order to obtain a concentration of approximately 1.0 mg/ml in DMF. The samples of the reactions performed in DMF were prepared by collecting an amount of solution corresponding to approximately 1 mg of mixture. This amount of solution was estimated by taking into account the initial concentration of the reagents. A dilution was subsequently carried out using DMF to obtain a solution concentration of approximately 1.0 mg/ml.

Nuclear Magnetic Resonance (NMR)

^1H -NMR and ^{13}C -NMR spectra of the synthesised hyperbranched polymers were obtained using a Varian 700 MHz and 176 MHz spectrometer respectively (at 298 K). ^{13}C -NMR was performed by recording the signals for 5 hours with a relaxation delay of 10.0 seconds and a pulse of 45.0 degree to quantify the structural units of the polymer. 2D-NMR, ^1H , ^{13}C -HMBC and ^1H , ^{13}C -HSQC spectra, were recorded with a standard pulse sequence to assign the polymer structure. CDCl_3 and d-DMSO were used as solvents. The solvent signals are expected at 7.26 (^1H -NMR) and 77.16 ppm (^{13}C -NMR) for CDCl_3 and 2.50 and 39.52 ppm for d-DMSO. All the NMR

spectra were run on crude recovered products; for the reaction carried out in DMF solution, proton peaks at 8.02, 2.96 and 2.88 ppm and carbon peaks at 162.62, 36.50, 31.45 ppm are expected for the DMF solvent in CDCl₃. For the reactions in DMSO, the presence of TEA was detected at 0.93 and 2.43 ppm (¹H-NMR) and 11.74 and 45.74 (¹³C-NMR).

Elemental Analysis

The elemental analysis was carried using an Exeter CE-440 analyser.

3.3.3 Synthesis of the hyperbranched poly(ester amine)s.

Synthesis of PEA1- hyperbranched poly(PEGDA-HDA)

Synthesis of PEA1-1.5

In a typical reaction, HDA (0.58 g, 5 mmol) was added in a round bottom flask (100 ml) to a solution of PEGDA (4.30 g, 7.5 mmol) in 22.5 ml DMF (18% w/v). The mixture was stirred vigorously using an overhead mechanical stirrer under nitrogen atmosphere at 60 °C for 72 hours. Samples were extracted periodically for NMR spectroscopy and SEC analysis. The final product was recovered as an insoluble gel swollen in the solvent. SEC (DMF/LiBr, PEO as standards): $M_n=2150$ g/mol; $M_w=29700$ g/mol; $\bar{D}=14.0$ (the quoted values refer to the last sample collected and analysed before gelation occurred). ¹H-NMR (700MHz, CDCl₃): acrylate conversion = 80% before gelation. ¹³C-NMR (176MHz, CDCl₃): DB = 0.38 before gelation.

The synthesis of PEA1-1.5 was also carried out at room temperature. From the reaction a gel product swollen in the solvent was recovered after 300h. The intermediate product analysed after 288h without further purification showed: SEC (DMF/LiBr, PEO standards) $M_n = 2500$ g/mol; $M_w = 37500$ g/mol; $\bar{D} = 17.0$; ¹H-NMR (700MHz, CDCl₃): acrylate conversion = 75%; ¹³C-NMR (176MHz, CDCl₃): DB 0.45.

The synthesis of PEA1-1.5 was repeated with a monomer concentration of 25 % w/v in DMF (15 ml) at 60°C. From the reaction a gel product swollen in the solvent was recovered after 35h. The intermediate product analysed after 24h without further purification showed: SEC (DMF/LiBr, PEO standards) $M_n = 1600$ g/mol; $M_w = 12800$ g/mol; $\bar{D} = 8.0$, ¹H-NMR (700MHz, CDCl₃): acrylate conversion = 75%; ¹³C-NMR (176MHz, CDCl₃): DB 0.32.

The synthesis of PEA1-1.5 was repeated in bulk (no solvent): in a typical reaction HDA (0.58 g, 5 mmol) was added to PEGDA (4.3 g, 7.5 mmol) in a round bottom flask (100 ml). The mixture was stirred vigorously using an overhead mechanical stirrer under nitrogen atmosphere

at 60 °C for 24 hours. From the reaction a gel product was obtained after 7h with 90% of yield. The intermediate product analysed after 5h showed: SEC (DMF/LiBr, PEO standards) $M_n = 1250$ g/mol; $M_w = 11500$ g/mol; $\bar{D} = 10.0$; $^1\text{H-NMR}$ (700MHz, CDCl_3): acrylate conversion = 70%; $^{13}\text{C-NMR}$ (176MHz, CDCl_3): DB = 0.35.

The reaction described above for the synthesis of PEA1-1.5 ($T=60^\circ\text{C}$) was repeated under the same reaction conditions with a variety of different molar ratios.

Synthesis of PEA1-3

HDA (0.58 g, 5 mmol) and PEGDA (8.60 g, 15 mmol) were dissolved in 42.5 ml of DMF (18% w/v) and stirred for 288h. A gel product swollen in the solvent was recovered. The intermediate product analysed after 264h without further purification showed: SEC (DMF/LiBr, PEO standards) $M_n = 1300$ g/mol; $M_w = 30000$ g/mol; $\bar{D} = 23.5$, $^1\text{H-NMR}$ (700MHz, CDCl_3): acrylate conversion = 60%, $^{13}\text{C-NMR}$ (176MHz, CDCl_3): DB 0.83.

Synthesis of PEA1-2:

HDA (0.58 g, 5 mmol) and PEGDA (5.75 g, 10 mmol) dissolved in 29.5 ml of DMF and stirred for 150h. A gel product swollen in the solvent was recovered. The intermediate product analysed after 96h without further purification showed: SEC (DMF/LiBr, PEO standards) $M_n = 1800$ g/mol; $M_w = 22000$ g/mol; $\bar{D} = 10.0$; $^1\text{H-NMR}$ (700MHz, CDCl_3): acrylate conversion = 65%, $^{13}\text{C-NMR}$ (176MHz, CDCl_3): DB 0.65.

Synthesis of PEA1-0.8:

HDA (0.58 g, 5 mmol) and PEGDA (2.30 g, 4 mmol) dissolved in 13.2 ml of DMF and stirred for 96h. The mixture was precipitated after 96 in diethyl ether and a soluble polymer with 60% of yield recovered. SEC (DMF/LiBr, PEO standards): $M_n = 1080$ g/mol; $M_w = 3200$ g/mol; $\bar{D} = 3.0$; $^1\text{H-NMR}$ (700MHz, CDCl_3): acrylate conversion = 100%; $^{13}\text{C-NMR}$ (176MHz, CDCl_3): DB 0.18.

$^1\text{H-NMR}$ (700MHz, CDCl_3 , 298K) δ ppm: 6.40, 6.15 and 5.85 (m, 6H, $-\underline{\text{C}}\text{H}=\underline{\text{C}}\text{H}_2$, PEGDA), 4.32 and 4.24 (m, 4H, $-\text{C}(\text{O})\text{O}\underline{\text{C}}\text{H}_2\text{CH}_2-$ PEGDA), 3.74 and 3.68 (m, 4H, $-\text{C}(\text{O})\text{O}\text{CH}_2\underline{\text{C}}\text{H}_2-$ PEGDA), 3.64 (m, 24H, $-\text{O}\underline{\text{C}}\text{H}_2\underline{\text{C}}\text{H}_2\text{O}-$ PEGDA), 2.87 (m), 2.75 (m), 2.58 (m), 2.54 (m), 2.46 (m), 2.38 (m) ($-\text{OC}(\text{O})\text{CH}_2\underline{\text{C}}\text{H}_2\text{NH}\underline{\text{C}}\text{H}_2-$ and $(-\text{OC}(\text{O})\text{CH}_2\underline{\text{C}}\text{H}_2)_2\text{N}\underline{\text{C}}\text{H}_2-$), 1.46 (m, 4H, $-\text{NCH}_2\underline{\text{C}}\text{H}_2\text{CH}_2-$ HDA), 1.32 (m, 4H, $-\text{NCH}_2\text{CH}_2\underline{\text{C}}\text{H}_2-$ HDA).

^{13}C -NMR (176MHz, CDCl_3 , 298K) δ ppm: 171.35 ($-\underline{\text{C}}(\text{O})\text{CH}_2\text{CH}_2\text{N}-$), 164.82 ($-\underline{\text{C}}(\text{O})\text{CH}=\text{CH}_2$), 130.00 and 127.67 ($-\underline{\text{C}}\text{H}=\underline{\text{C}}\text{H}_2$), 69.68 ($-\text{O}\underline{\text{C}}\text{H}_2\underline{\text{C}}\text{H}_2\text{O}-$ PEGDA), 68.12 and 68.06 ($-\text{C}(\text{O})\text{O}\underline{\text{C}}\text{H}_2\underline{\text{C}}\text{H}_2-$ PEGDA), 62.83 and 62.55 ($-\text{C}(\text{O})\text{O}\underline{\text{C}}\text{H}_2\text{CH}_2-$ PEGDA), 52.82, 48.83, 48.44 and 44.42 ($(-\text{OC}(\text{O})\text{CH}_2\underline{\text{C}}\text{H}_2\text{NH}\underline{\text{C}}\text{H}_2-$ and $-\text{OC}(\text{O})\text{CH}_2\underline{\text{C}}\text{H}_2\text{N}(\underline{\text{C}}\text{H}_2\text{R})_2$), 33.90 and 31.74 ($-\text{OC}(\text{O})\underline{\text{C}}\text{H}_2\text{CH}_2\text{NHCH}_2-$ and $(-\text{OC}(\text{O})\text{CH}_2\underline{\text{C}}\text{H}_2)_2\text{N}\underline{\text{C}}\text{H}_2-$, 29.21 ($-\text{NCH}_2\underline{\text{C}}\text{H}_2\text{CH}_2-$ HDA), 26.44 ($-\text{NCH}_2\text{CH}_2\underline{\text{C}}\text{H}_2-$ HDA).

Synthesis of PEA2 - hyperbranched poly(PEGDA-EDA)

Synthesis of PEA2-1.5

In a typical reaction EDA (0.30 g, 5 mmol) was added in a round bottom flask (100 ml) to a solution of PEGDA (4.30 g, 7.5 mmol) in 21.4 ml DMF (18% w/v). The mixture was stirred vigorously using an overhead mechanical stirrer under nitrogen atmosphere at 60 °C for 120 hours. Samples were extracted periodically for NMR spectroscopy and SEC analysis. The mixture was precipitated in diethyl ether and dried overnight in vacuum oven. A gel product formed during storage in vacuum oven (yield = 75%) was obtained. Before precipitation (120h) the product showed: SEC (DMF/LiBr, PEO standards) $M_n = 1500$ g/mol; $M_w = 40000$ g/mol; $\text{Đ} = 27.5$; ^1H -NMR (700MHz, CDCl_3): acrylate conversion = 90%; ^{13}C -NMR (176MHz, CDCl_3): DB 0.70.

The reaction described above was repeated at a monomer concentration of 25% w/v EDA (0.30 g, 5 mmol) and PEGDA (4.30 g, 7.5 mmol) in 14.2 ml DMF and stirred for 20h. The final product was recovered as gel swollen in the solvent. Characterisation data of the crude product after 5h: SEC (DMF/LiBr, PEO standards) $M_n = 1000$ g/mol; $M_w = 12500$ g/mol; $\text{Đ} = 12.0$; ^{13}C -NMR (176MHz, CDCl_3): DB = 0.40.

The reaction described above was repeated in bulk. EDA (0.30 g, 5 mmol) was added in a round bottom flask (100 ml) to PEGDA (4.30 g, 7.5 mmol) and stirred vigorously for 1h. A gel product was recovered with yield of 92%. Characterisation data of the crude product after 20 minute: SEC (DMF/LiBr, PEO standards) $M_n = 750$ g/mol; $M_w = 5750$ g/mol; $\text{Đ} = 8.0$, ^1H -NMR (700MHz, CDCl_3): acrylate conversion = 75%, ^{13}C -NMR (176MHz, CDCl_3): DB 0.35.

Synthesis of PEA2-1.5MA

The synthesis of PEA2-1.5 was repeated in solution (18% in DMF) as described above. The reaction was carried out for 24h followed by end-capping the polymer with an excess of methyl acrylate (MA). The mixture was allowed to react for other 24h. The mixture was precipitated in

diethyl ether and dried in vacuum oven. A gel product was formed during storage in vacuum oven with 85% of yield. The polymer after 24h (before the addition of MA) was analysed without purification and showed: SEC (DMF/LiBr, PEO standards) $M_n = 1150$ g/mol; $M_w = 12500$ g/mol; $\bar{D} = 11.5$; $^1\text{H-NMR}$ (700MHz, CDCl_3): of acrylate conversion = 85%. After end-capping (48h): SEC (DMF/LiBr, PEO standards) $M_n = 1200$ g/mol; $M_w = 11000$ g/mol; $\bar{D} = 10.0$.

Synthesis of PEA2-0.8

The synthesis was carried out in bulk with a molar ratio $A_2:B_4$ of 0.8:1 EDA (0.30 g, 5 mmol) and PEGDA (2.30 g, 4 mmol) for 24h at 60°C. The resulting polymer (yield c.a. 90%) was not purified. SEC (DMF/LiBr, PEO standards) $M_n = 700$ g/mol; $M_w = 2500$ g/mol; $\bar{D} = 3.0$; $^1\text{H-NMR}$ (700MHz, CDCl_3): of acrylate conversion = 100%, $^{13}\text{C-NMR}$ (176MHz, CDCl_3): DB 0.10.

$^1\text{H-NMR}$ (700MHz, CDCl_3 , 298K) δ ppm: 6.41, 6.12 and 5.80 (m, 6H, $-\text{CH}=\text{CH}_2$, PEGDA), 4.28 and 4.20 (m, 4H, $-\text{C}(\text{O})\text{OCH}_2\text{CH}_2-$ PEGDA), 3.71 and 3.66 (m, 4H, $-\text{C}(\text{O})\text{OCH}_2\text{CH}_2-$ PEGDA), 3.62 (m, 24H, $-\text{OCH}_2\text{CH}_2\text{O}-$ PEGDA), 2.85 (m), 2.74 (m), 2.68, (m), 2.65 (m), 2.61 (m), 2.50 (m), 2.44 (m) ($-\text{OC}(\text{O})\text{CH}_2\text{CH}_2\text{NHCH}_2-$ and $-\text{OC}(\text{O})\text{CH}_2\text{CH}_2)_2\text{NCH}_2-$).

$^{13}\text{C-NMR}$ (176MHz, CDCl_3 , 298K) δ ppm: 171.15 ($-\text{C}(\text{O})\text{CH}_2\text{CH}_2\text{N}-$), 164.51 ($-\text{C}(\text{O})\text{CH}=\text{CH}_2$), 129.61 and 127.19 ($-\text{CH}=\text{CH}_2$), 69.29 ($-\text{OCH}_2\text{CH}_2\text{O}-$ PEGDA), 67.63 and 67.67 ($-\text{C}(\text{O})\text{OCH}_2\text{CH}_2-$ PEGDA), 62.41 and 62.15 ($-\text{C}(\text{O})\text{OCH}_2\text{CH}_2-$ PEGDA), 55.76, 53.51, 52.58, 52.35, 51.01, 49.32, 48.25, 48.09, 47.80, 45.91, 43.96, 43.81, 40.44 ($-\text{OC}(\text{O})\text{CH}_2\text{CH}_2\text{NHCH}_2-$ and $-(\text{OC}(\text{O})\text{CH}_2\text{CH}_2)_2\text{NCH}_2-$), 33.57 and 31.27 ($-\text{OC}(\text{O})\text{CH}_2\text{CH}_2\text{NHCH}_2-$ and $-\text{OC}(\text{O})\text{CH}_2\text{CH}_2)_2\text{NCH}_2-$).

Synthesis of PEA3 - hyperbranched poly(PEGDA-MMA-HDA).

PEGDA (4.30 g, 7.5 mmol) and MMA (0.50 g, 5 mmol) were dissolved in 16.5 ml of DMF under nitrogen in a round flask (100 ml) and subsequently HDA (0.58 g, 5 mmol) was added to the solution (25% w/v). The mixture was vigorously stirred using a mechanical stirrer at 60 °C for 24 hours. A gel product was obtained after 28h with a yield of 80%. The intermediate product was analysed after 24 hours without purification: SEC (DMF/LiBr, PEO standards) $M_n = 1700$ g/mol; $M_w = 10900$ g/mol; $\bar{D} = 7.5$, $^1\text{H-NMR}$ (700MHz, CDCl_3): acrylate conversion = 76%, $^{13}\text{C-NMR}$ (176MHz, CDCl_3): DB 0.20.

$^1\text{H-NMR}$ (700MHz and 700MHz, CDCl_3 , 298K) δ ppm: 6.09, 5.82 and 5.53 (m, 6H, $-\underline{\text{C}}\underline{\text{H}}=\underline{\text{C}}\underline{\text{H}}_2$, PEGDA), 5.76 and 5.24 (2H, $\underline{\text{C}}\underline{\text{H}}_2=\underline{\text{C}}(\underline{\text{C}}\underline{\text{H}}_3)-$, MMA), 3.97 and 3.89 (m, 4H, $-\text{C}(\text{O})\text{O}\underline{\text{C}}\underline{\text{H}}_2\underline{\text{C}}\underline{\text{H}}_2-$ PEGDA), 3.41 and 3.37 (m, 4H, $-\text{C}(\text{O})\text{O}\underline{\text{C}}\underline{\text{H}}_2\underline{\text{C}}\underline{\text{H}}_2-$ PEGDA), 3.41 ppm (3H, $\underline{\text{H}}_3\underline{\text{C}}\text{OC}(\text{O})-$ MMA), 3.31 (m, 24H, $-\text{O}\underline{\text{C}}\underline{\text{H}}_2\underline{\text{C}}\underline{\text{H}}_2\text{O}-$ PEGDA), 2.43 (m), 2.28 (m), 2.21 (m), 2.12 (m), 2.06 (m) ($-\text{OC}(\text{O})\underline{\text{C}}\underline{\text{H}}_2\underline{\text{C}}\underline{\text{H}}_2\underline{\text{N}}\underline{\text{H}}\underline{\text{C}}\underline{\text{H}}_2-$ and $-\text{OC}(\text{O})\underline{\text{C}}\underline{\text{H}}_2\underline{\text{C}}\underline{\text{H}}_2)_2\underline{\text{N}}\underline{\text{C}}\underline{\text{H}}_2-$), 1.60 (3H, $\underline{\text{C}}\underline{\text{H}}_2=\underline{\text{C}}(\underline{\text{C}}\underline{\text{H}}_3)-$, MMA), 1.16 (m, 4H, $-\text{N}\underline{\text{C}}\underline{\text{H}}_2\underline{\text{C}}\underline{\text{H}}_2\underline{\text{C}}\underline{\text{H}}_2-$ HDA), 1.01 (m, 4H, $-\text{N}\underline{\text{C}}\underline{\text{H}}_2\underline{\text{C}}\underline{\text{H}}_2\underline{\text{C}}\underline{\text{H}}_2-$ HDA).

$^{13}\text{C-NMR}$ (176MHz, CDCl_3 , 298K) δ ppm: 171.75 ($-\underline{\text{C}}(\text{O})\underline{\text{C}}\underline{\text{H}}_2\underline{\text{C}}\underline{\text{H}}_2\underline{\text{N}}-$), 167.05 ($-\underline{\text{C}}(\text{O})\underline{\text{C}}(\underline{\text{C}}\underline{\text{H}}_3)=\underline{\text{C}}\underline{\text{H}}_2$, MMA), 165.32 ($-\underline{\text{C}}(\text{O})\underline{\text{C}}\underline{\text{H}}=\underline{\text{C}}\underline{\text{H}}_2$, PEGDA), 124.70 and 135.65 ($\underline{\text{C}}\underline{\text{H}}_2=\underline{\text{C}}(\underline{\text{C}}\underline{\text{H}}_3)-$, MMA) 130.33 and 127.70 ($-\underline{\text{C}}\underline{\text{H}}=\underline{\text{C}}\underline{\text{H}}_2$, PEGDA), 70.00 ($-\text{O}\underline{\text{C}}\underline{\text{H}}_2\underline{\text{C}}\underline{\text{H}}_2\text{O}-$ PEGDA), 68.43 and 68.39 ($-\text{C}(\text{O})\text{O}\underline{\text{C}}\underline{\text{H}}_2\underline{\text{C}}\underline{\text{H}}_2-$ PEGDA), 63.07 and 62.86 ($-\text{C}(\text{O})\text{O}\underline{\text{C}}\underline{\text{H}}_2\underline{\text{C}}\underline{\text{H}}_2-$ PEGDA), 52.92, 49.04, 48.54 and 44.45 ($-\text{OC}(\text{O})\underline{\text{C}}\underline{\text{H}}_2\underline{\text{C}}\underline{\text{H}}_2\underline{\text{N}}\underline{\text{H}}\underline{\text{C}}\underline{\text{H}}_2-$ and $-\text{OC}(\text{O})\underline{\text{C}}\underline{\text{H}}_2\underline{\text{C}}\underline{\text{H}}_2\underline{\text{N}}(\underline{\text{C}}\underline{\text{H}}_2\underline{\text{R}})_2$), 51.12 ($\underline{\text{H}}_3\underline{\text{C}}\underline{\text{O}}\underline{\text{C}}(\text{O})-$, MMA), 33.84 and 31.87 ($-\text{OC}(\text{O})\underline{\text{C}}\underline{\text{H}}_2\underline{\text{C}}\underline{\text{H}}_2\underline{\text{N}}\underline{\text{H}}\underline{\text{C}}\underline{\text{H}}_2-$ and $-\text{OC}(\text{O})\underline{\text{C}}\underline{\text{H}}_2\underline{\text{C}}\underline{\text{H}}_2)_2\underline{\text{N}}\underline{\text{C}}\underline{\text{H}}_2-$), 29.37 ($-\text{N}\underline{\text{C}}\underline{\text{H}}_2\underline{\text{C}}\underline{\text{H}}_2\underline{\text{C}}\underline{\text{H}}_2-$ HDA), 26.60 ($-\text{N}\underline{\text{C}}\underline{\text{H}}_2\underline{\text{C}}\underline{\text{H}}_2\underline{\text{C}}\underline{\text{H}}_2-$ HDA), 17.53 ($\underline{\text{C}}\underline{\text{H}}_2=\underline{\text{C}}(\underline{\text{C}}\underline{\text{H}}_3)-$, MMA).

Synthesis of PEA4 - hyperbranched poly(PEGDA-MA-HDA).

PEGDA (4.30 g, 7.5 mmol) and MA (0.43 g, 5 mmol) were dissolved in 16.3 ml (15.5 g) of DMF under nitrogen in a round flask (100 ml) and subsequently HDA (0.58 g, 5 mmol) was added to the solution (25% w/v). The mixture was vigorously stirred using a mechanical stirrer at 60 °C for 144 hours. The product, analysed without further purification, showed after 144 hours: SEC (DMF/LiBr, PEO standards) $M_n = 1350$ g/mol; $M_w = 40150$ g/mol; $\text{Đ} = 30.0$, $^1\text{H-NMR}$ (700MHz, CDCl_3): acrylate conversion = 85% for the PEGDA and 82% for the MA monomer, $^{13}\text{C-NMR}$ (176MHz, CDCl_3): $\text{DB}' = 0.70$.

The reaction was repeated in bulk. After 10 hours the product was recovered as gel (yield c.a. 90%). The characterisation data of the crude product after 8 hours are: $M_n = 950$ g/mol; $M_w = 17500$ g/mol and $\text{Đ} = 18.5$.

$^1\text{H-NMR}$ (700MHz, CDCl_3 , 298K) δ ppm: 6.00, 5.79 and 5.49 (m, 6H, $-\underline{\text{C}}\underline{\text{H}}=\underline{\text{C}}\underline{\text{H}}_2$, PEGDA and MA), 3.95 and 3.83 (m, 4H, $-\text{C}(\text{O})\text{O}\underline{\text{C}}\underline{\text{H}}_2\underline{\text{C}}\underline{\text{H}}_2-$ PEGDA), 3.36 and 3.31 (m, 4H, $-\text{C}(\text{O})\text{O}\underline{\text{C}}\underline{\text{H}}_2\underline{\text{C}}\underline{\text{H}}_2-$ PEGDA), 3.36 (3H, $\underline{\text{H}}_3\underline{\text{C}}\underline{\text{O}}\underline{\text{C}}(\text{O})-$, MA), 3.25 (m, 24H, $-\text{O}\underline{\text{C}}\underline{\text{H}}_2\underline{\text{C}}\underline{\text{H}}_2\text{O}-$ PEGDA), 2.37 (m), 2.21 (m), 2.14 (m), 2.07 (m), 2.02 (m) ($-\text{OC}(\text{O})\underline{\text{C}}\underline{\text{H}}_2\underline{\text{C}}\underline{\text{H}}_2\underline{\text{N}}\underline{\text{H}}\underline{\text{C}}\underline{\text{H}}_2-$ and $-\text{OC}(\text{O})\underline{\text{C}}\underline{\text{H}}_2\underline{\text{C}}\underline{\text{H}}_2)_2\underline{\text{N}}\underline{\text{C}}\underline{\text{H}}_2-$), 1.08 (m, 4H, $-\text{N}\underline{\text{C}}\underline{\text{H}}_2\underline{\text{C}}\underline{\text{H}}_2\underline{\text{C}}\underline{\text{H}}_2-$ HDA), 0.95 (m, 4H, $-\text{N}\underline{\text{C}}\underline{\text{H}}_2\underline{\text{C}}\underline{\text{H}}_2\underline{\text{C}}\underline{\text{H}}_2-$ HDA).

^{13}C -NMR (176MHz, CDCl_3 , 298K) δ ppm: 172.34 ($-\underline{\text{C}}(\text{O})\text{CH}_2\text{CH}_2\text{N}-$, MA), 171.86 ($-\underline{\text{C}}(\text{O})\text{CH}_2\text{CH}_2\text{N}-$, PEGDA), 165.68 ($-\underline{\text{C}}(\text{O})\text{CH}=\text{CH}_2$, MA), 165.17 ($-\underline{\text{C}}(\text{O})\text{CH}=\text{CH}_2$, PEGDA), 129.95 and 127.52 ($\underline{\text{C}}\text{H}_2=\underline{\text{C}}(\text{CH}_3)-$, MA) 130.14 and 127.63 ($-\underline{\text{C}}\text{H}=\underline{\text{C}}\text{H}_2$, PEGDA), 70.00 ($-\text{O}\underline{\text{C}}\text{H}_2\underline{\text{C}}\text{H}_2\text{O}-$ PEGDA), 68.29 and 68.26 ($-\text{C}(\text{O})\text{O}\underline{\text{C}}\text{H}_2\underline{\text{C}}\text{H}_2-$ PEGDA), 62.93 and 62.72 ($-\text{C}(\text{O})\text{O}\underline{\text{C}}\text{H}_2\text{CH}_2-$ PEGDA), 52.94, 48.94, 48.47 and 44.39 ($(-\text{OC}(\text{O})\text{CH}_2\underline{\text{C}}\text{H}_2\text{NH}\underline{\text{C}}\text{H}_2-$ and $-\text{OC}(\text{O})\text{CH}_2\underline{\text{C}}\text{H}_2\text{N}(\underline{\text{C}}\text{H}_2\text{R})_2$), 50.78, 50.68 and 50.64 ($\text{H}_3\underline{\text{C}}\text{OC}(\text{O})-$, MA), 33.94 and 31.82 ($-\text{OC}(\text{O})\underline{\text{C}}\text{H}_2\text{CH}_2\text{NH}\underline{\text{C}}\text{H}_2-$ and $(-\text{OC}(\text{O})\text{CH}_2\underline{\text{C}}\text{H}_2)_2\text{N}\underline{\text{C}}\text{H}_2-$, 29.33 ($-\text{N}\underline{\text{C}}\text{H}_2\underline{\text{C}}\text{H}_2\text{CH}_2-$ HDA), 26.54 ($-\text{N}\underline{\text{C}}\text{H}_2\text{CH}_2\underline{\text{C}}\text{H}_2-$ HDA).

Synthesis of PEA5 - hyperbranched hydrochloride poly(PEGDA-HDDC) .

Synthesis of PEA5-0.8

HDDC (0.94 g, 5 mmol) was added to a solution of PEGDA (2.30 g, 4 mmol) and TEA (0.25g, 2.5 mmol) in DMSO (15 ml, 18% w/v) at 60°C for 24h. The polymer was recovered by precipitation in THF with a yield of 80% w/w. ^1H -NMR (700MHz, d-DMSO): % acrylate conversion = 95%.

The reaction above described was repeated under the same reaction conditions without the use of TEA in bulk. ^1H -NMR (700MHz, d-DMSO): no acrylate conversion.

The reaction described above was repeated under the same reaction conditions without the use of TEA in DMSO. ^1H -NMR (700MHz, d-DMSO): acrylate conversion = 15% after 24h. The same reaction was repeated at the same conditions at 100°C . ^1H -NMR (700MHz, d-DMSO): acrylate conversion = 50% after 24h. The reaction was repeated under the same reaction conditions by varying the amount of TEA during the polyaddition. The reaction was studied by ^1H -NMR, see Table 3.1.

Synthesis of PEA5-1.5

The reaction described above was repeated at the same reaction conditions using a molar ratio PEGDA:HDDC of 1.5:1. After 144 hour, ^1H -NMR showed c.a. 65% of acrylate conversion. The mixture was precipitated after 144 hours in THF and a soluble product obtained with a yield of 40%. ^{13}C -NMR: DB 0.30.

^1H -NMR (700MHz, d-DMSO, 298K) δ ppm: 9.21 and 8.01 (s, broad, quaternary amine groups); 6.26, 6.15 and 5.90 ppm ((m, 6H, $-\underline{\text{C}}\text{H}=\underline{\text{C}}\text{H}_2$, PEGDA), 4.18 and 4.07 (m, 4H, $-\text{C}(\text{O})\text{O}\underline{\text{C}}\text{H}_2\text{CH}_2-$ PEGDA), 3.60 (m, 4H, $-\text{C}(\text{O})\text{O}\underline{\text{C}}\text{H}_2\underline{\text{C}}\text{H}_2-$ PEGDA), 3.46 (m, 24H, $-\text{O}\underline{\text{C}}\text{H}_2\underline{\text{C}}\text{H}_2\text{O}-$ PEGDA),

3.07, 3.00, 2.95, 2.80 (m, (-OC(O)CH₂CH₂NHCH₂- and -OC(O)CH₂CH₂N(CH₂R)₂, new methylene from polymerisation), 1.60 and 1.30 (-NCH₂CH₂CH₂- and -NCH₂CH₂CH₂-, HDDC).

¹³C-NMR (176MHz, d-DMSO, 298K) δ ppm: 172.06 (-C(O)CH₂CH₂N-, PEGDA), 168.30 ppm (-C(O)CH=CH₂, PEGDA), 132.65 and 127.45 (-CH=CH₂, PEGDA), 69.63 (-OCH₂CH₂O-PEGDA), 68.44 and 68.34 (-C(O)OCH₂CH₂- PEGDA, splitting of the signal with the polymerisation reaction), 64.56 and 64.43 (-C(O)OCH₂CH₂- PEGDA, splitting of the signal with the polymerisation reaction), 53.66, 48.79, 47.68, 42.65 ((-OC(O)CH₂CH₂NHCH₂- and -OC(O)CH₂CH₂N(CH₂R)₂, new methylene from polymerisation), 30.26 and 28.45 (-OC(O)CH₂CH₂NHCH₂- and (-OC(O)CH₂CH₂)₂NCH₂-, 29.33 (-NCH₂CH₂CH₂- HDA), 26.54 (-NCH₂CH₂CH₂- HDA).

Table 3.1 Change of the acrylate conversion as function of the time and the amount of TEA for the polyaddition of PEA5-0.8.

%w/w TEA	time (h)	% acrylate conversion
0.01	0.5	5
	5	8
	24	10
	48	10
0.03	65	13
	100	16
0.1	115	20
0.5	124	30
	145	45
	165	50
1	175	50

3.3.4 Stability Tests

The stability of poly(ester amine) samples was tested by dissolving the polymer in methanol (polymer concentration 5% w/v) and stirring the solution for at least 24 hours at room temperature. After this time, the solvent was removed using a rotary evaporator and the polymer analysed by DMF SEC analysis and ¹³C-NMR (alcoholic functionality: -OCH₂CH₂OH at 72.71 ppm; -OCH₂CH₂OH at 60.59 ppm; methoxide functionality H₃COC(O)- at 51.47).

3.4 Results and Discussion

In this section the synthesis of hyperbranched poly(ester amine)s (PEAs) by using the “A₂ + B₄” and “A₂ + A + B₄” strategies is discussed. Four series of polymers with different chemical structure were synthesised using pairs of different starting monomers (Figure 3.3); PEA1

(poly(PEGDA and HDA)), PEA2 (poly(PEGDA and EDA)), PEA3 (poly(PEGDA, MMA and HDA)) and PEA4 (poly(PEGDA, MA and HDA)).

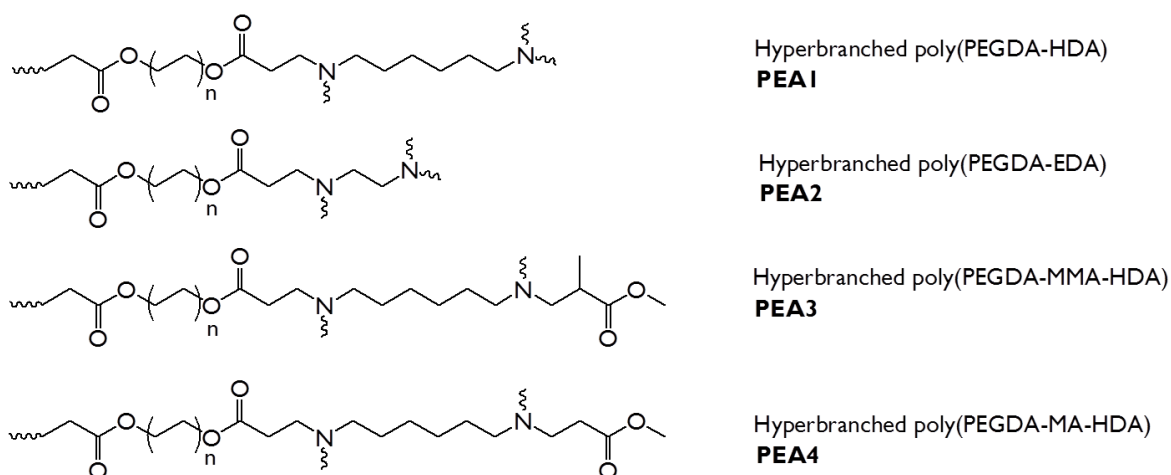
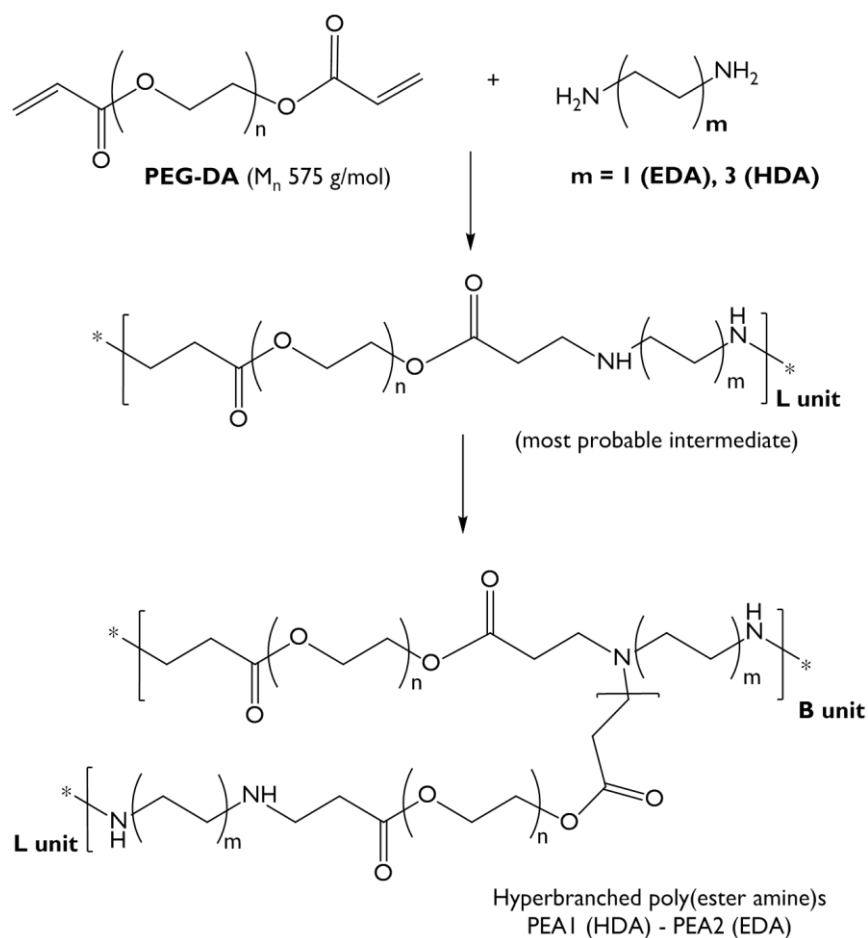

Figure 3.3 Series of polymers synthesised by Michael addition polymerisation with different starting monomers.

3.4.1 Synthesis of hyperbranched poly(ester amine) by “A₂+B₄” strategy.

Hyperbranched polymers PEA1 and PEA2 were obtained in a one-pot reaction using different mole ratios of poly(ethylene glycol) diacrylate (PEGDA) and a diamine; either hexamethylenediamine (HDA) or ethylenediamine (EDA) (Scheme 3.3). The aza-Michael addition reaction occurs by the polyaddition of PEGDA and HDA or EDA. PEGDA is an A₂-monomer having two terminal acrylate groups while HDA and EDA are each B₄-monomers with two primary amine groups. The molar feed ratio of the monomers as well as appropriate reaction conditions are important parameters for the synthesis of gel-free hyperbranched polymers^{38,39,40} For this reason the key parameters such as molar ratio, temperature and monomer solution concentration were systematically varied in the polymerisation reaction, and the effect of these changes on the resulting structure is discussed. The polymerisation reaction was carried out both in solution and in bulk; when in solution the solvent selected for the reaction was DMF¹.



Scheme 3.3 Synthesis of hyperbranched poly(ester amine) via Michael addition of PEGDA (A₂) monomer and HDA or alternatively EDA (B₄) monomer

3.4.1.1 Hyperbranched poly(ester amine) from PEGDA and HDA/EDA monomers: structural characterisation.

A typical ¹H-NMR spectrum of a hyperbranched polymer obtained from the bulk polymerisation of PEGDA and HDA is shown at the bottom of the Figure 3.4 (ii); the spectrum can be compared with the ¹H-NMR spectra of the two starting monomers overlapped in Figure 3.4 (i). All the spectra analysed in this work were obtained directly from the reaction mixture without any purification to follow the progress of the reaction in real time. For this reason, the presence of signals corresponding to the unreacted monomers has to be considered. The decision to analyse the impure polymers was made due to the high sensitivity of this type of polymerisation to parameters such as reaction time, temperature, solvents and the concentration of the monomers^{10,41}. Moreover, we found that purification of the intermediates of the reaction as well as the final products by precipitation and subsequent drying could result in further polymerisation leading to the formation of a cross-linked structure which was insoluble and therefore impossible to analyse.

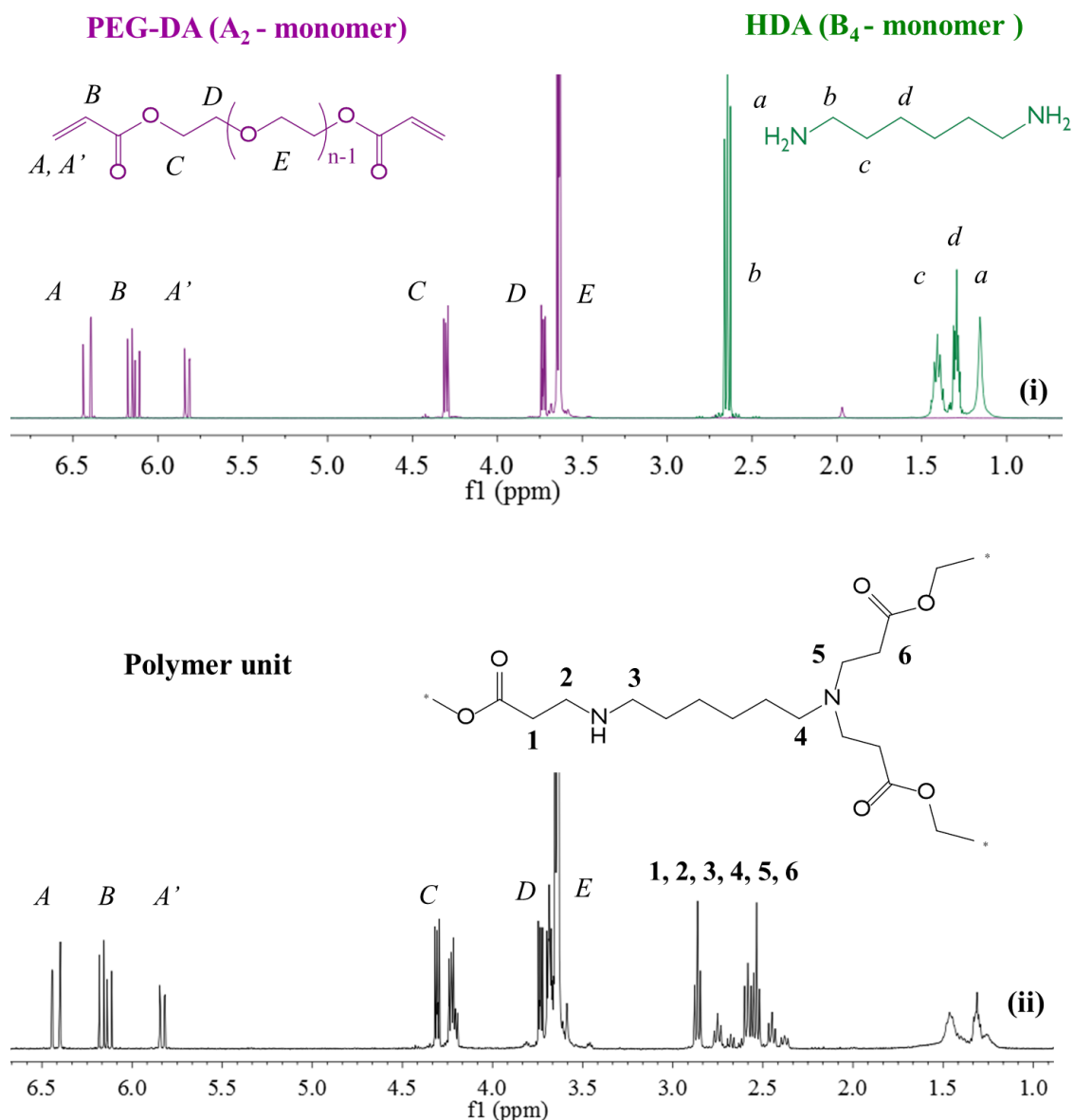

Figure 3.4 $^1\text{H-NMR}$ (700MHz, CDCl_3) of (i) the starting monomers of the polyaddition PEGDA and HDA and (ii) the crude product resulting from the reaction in bulk at 60°C with a molar ratio $A_2:B_4$ of 1.5:1.

Comparing the NMR spectrum of the product (Figure 3.4 (ii)) with that of the two monomers (Figure 3.4 (i)) allows assignment of the peaks for the polymer structure. Thus, the signals in the range 6.40-5.80 ppm (Figure 3.4 (ii)) are typical of the vinyl protons in PEGDA (A, A' and B signals in Figure 3.4 (i)); the presence of these signals suggests incomplete reaction of the functional groups of the A_2 -monomer. The two peaks in Figure 3.4 (ii) between 4.0 and 4.5 ppm belong to the methylene protons α to the acrylate group (C peak in Figure 3.4 (i) at 4.32 ppm). The chemical shift of these protons undergoes a change to 4.24 ppm following the polymerisation reaction and for this reason a splitting is observed. A further splitting is observed after polymerisation for the proton peak D that moves from 3.74 to 3.68 ppm. The intense signal

at 3.64 ppm corresponds to the methylene protons, alpha to the ether functionality (*E* signals in Figure 3.4 (i)). The signals 1, 2, 3, 4, 5, 6 between 2.25 and 3.25 ppm in Figure 3.4 (ii) correspond to the methylene protons connected with the carbonyl and the methylene protons linked to secondary and tertiary amines and the presence of these peaks is evidence of the reaction between the A₂ monomer and B₄ monomer. Finally the peaks between 1.3 and 1.6 ppm correspond to the methylene in β and γ positions with respect to the amine in HDA.

The polymerisation reactions were studied during the reaction time by following (i) the molecular weight by SEC analysis; (ii) the PEGDA conversion by ¹H or ¹³C-NMR and (iii) the degree of branching by ¹³C-NMR. An explanation of the calculations is reported below and the data obtained are included in the subsequent discussion of the results.

Acrylate group conversion

From the integrals associated with the vinyl proton peaks (6.40-5.80 ppm) it is possible to calculate the conversion of PEGDA; that value refers to the percentage of A (acrylate) groups which have reacted and is calculated as follows:

$$\% \text{ A conversion} = \left[1 - \frac{I_{5.80-6.40} \cdot 2}{I_{4.24-4.32} \cdot 3} \right] \cdot 100 \quad \text{Equation 3.1}$$

I_{5.80-6.40} corresponds to the integrals of the protons belonging to the vinyl groups while I_{4.24-4.32} is the area of the methylene protons (*C* signal in Figure 3.4 (i)) adjacent to the carboxylic group in the PEGDA chain.

Alternatively, the conversion of acrylate groups in PEGDA can be calculated using Equation 3.2 that takes into account the signals in the ¹³C-NMR spectra.

$$\% \text{ A conversion} = X_{171.35} = \frac{I_{171.35}}{I_{171.35} + I_{164.82}} \cdot 100 \quad \text{Equation 3.2}$$

Figure 3.6 shows a typical ¹³C-NMR spectrum with full structural assignment of the hyperbranched polymer obtained from the bulk polymerisation of PEGDA and HDA. PEGDA conversion (Equation 3.2) can be calculated in this case by using the integral values of the peak assigned to the carbonyl carbon of the acrylate group. The peak numbered 13, at 164.82 ppm in Figure 3.6 of the carbonyl group belonging to the unreacted acrylate group moves to 171.34 ppm (peak 9 Figure 3.6) following the reaction between PEGDA and HDA.

An error between the Equation 3.1 and 3.2 for the calculation of the acrylate conversion is expected and arises mainly due to different accuracy in the integration of the peaks in ¹H and ¹³C-NMR. In the ¹H-NMR spectrum, the integration of the signals is a measure of the proton count. In a ¹³C-NMR spectrum the low natural abundance of ¹³C and long T₁ relaxation times

results in the acquisition of the spectra with a much lower signal-to-noise ratio. For this reason, ^{13}C -NMR spectra were acquired over 5 hours to increase signal intensity and to allow an estimate of the percentage of acrylate groups reacted and the degree of branching of the polymer as discussed below. Acrylate conversion data will be included in the subsequent discussion.

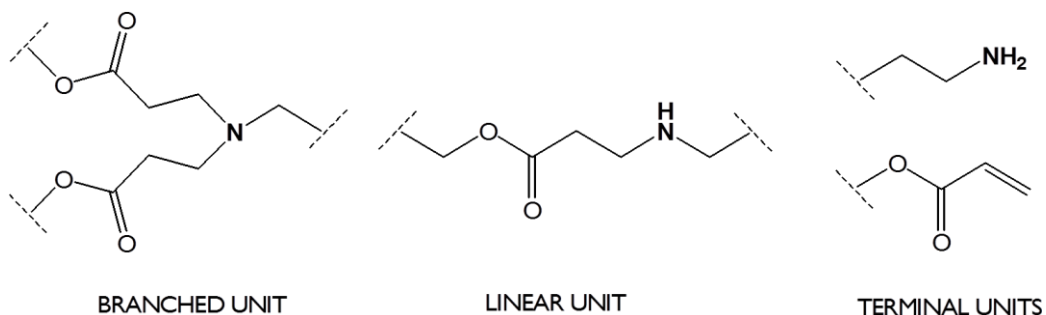

Figure 3.5 Structural units formed from the polyaddition of PEGDA and HDA/EDA

Degree of branching

The degree of branching (DB) is an important structural feature of hyperbranched polymers and may be calculated by the identification of the terminal, linear and branched units of the synthesised polymer. These units, shown in Figure 3.5, can be defined in terms of amine structure; for instance the branched unit is characterised by a tertiary amine, the linear unit by a secondary amine and the terminal unit by a primary amine and/or an acrylate group.

The DB has been calculated for all polymers by using the equations developed by Frey (Equation 3.3). It is worth remarking that Equation 3.3 is based upon an AB_n ($n \geq 2$) system^{42,43} in which the relationship $B = T + 1$ is valid and therefore this equations might not be totally accurate for the system investigated in the current work ($\text{A}_2 + \text{B}_4$); however this equation has been commonly used for the calculation of the DB of hyperbranched polymers synthesised by using an $\text{A}_2 + \text{B}_4$ system and similar systems⁴¹. As a consequence of this potential inaccuracy the discussion will be limited to the relative trends in DB rather than claims of absolute DB values.

$$\text{DB}_{\text{Frey}} = \frac{2B}{2B+L} \quad \text{Equation 3.3}$$

For the current study, the structural units shown in Figure 3.5 were identified and quantified in the ^{13}C -NMR spectra; ^1H -NMR cannot be used for this purpose because the chemical shifts of the different structural units (e.g. methylene protons in α -position to the amine group) are overlapped in the range between 2.38 and 2.87 ppm (Figure 3.4). The calculation of the DB was hence carried out by using quantitative ^{13}C -NMR using the α -methylene carbon with respect to

the amine group (method 1, discussed below) or alternatively the α -methylene carbon with respect to the ester group (method 2, discussed below).

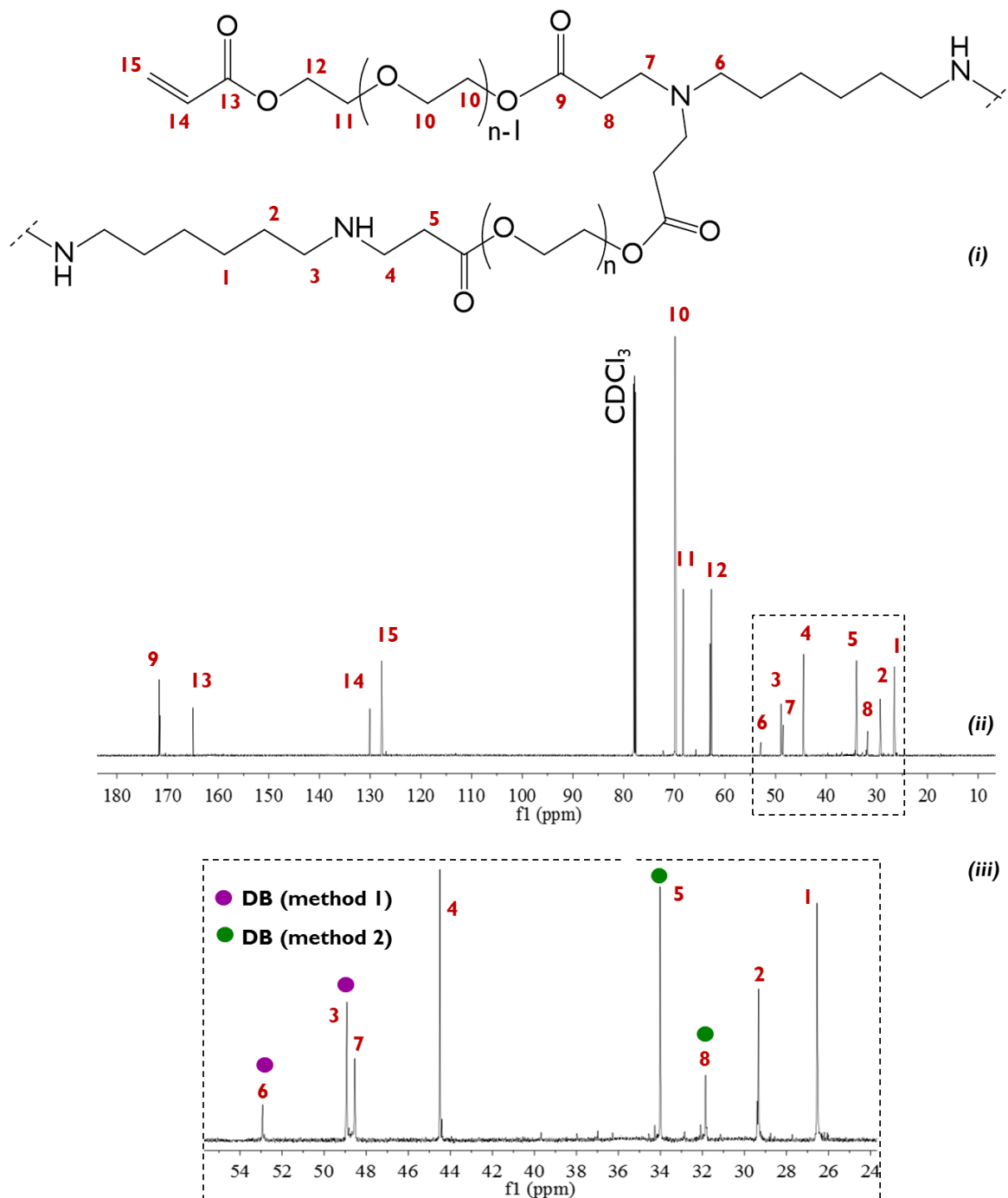

Figure 3.6 (i) Structure of the product obtained from the reaction in bulk at 60°C with a molar ratio $\text{A}_2:\text{B}_4$ of 1.5:1. (ii) ^{13}C -NMR (176 MHz, CDCl_3) spectrum of the crude product of the reaction with the relative assignments. (iii) Expanded picture of the region of the C signals used for the calculation of the DB according to method 1 (indicated in purple) and method 2 (in green).

Method 1

The structural units of the polymer (Figure 3.5) were identified by using the methylene carbon in the α position to the nitrogen atom. The addition reaction between PEGDA (A_2 -

monomer) and HDA (B₄-monomer) gives rise to two types of methylene carbon for each linear and branched unit, close to the amine group. One methylene carbon is found in the PEGDA repeat unit (signal 4 and 7 in Figure 3.6) and the other one from HDA repeat unit (signal 3 and 6). The degree of branching was calculated by using the signals belonging to the HDA repeat unit since it is able to form branching points. Therefore, the area of the signals 3 and 6 (in Figure 3.6) at 48.83 ppm and at 52.82 ppm of the linear and branched units respectively, were used in the Equation 3.3 for the calculation of the DB. The assignment of these carbon peaks to the HDA monomer was confirmed by ¹H, ¹³C-HMBC (Heteronuclear Multiple Bond Correlation). In Figure 3.7, the coupling between the methylene carbon, alpha to the amine group (signals 3 and 6) and the methylene protons in β and γ positions belonging to the HDA can be observed. The identification of the linear and branched units was further established by synthesising a model linear polymer (PEA1-0.8, section 3.4.1.2) and comparing the resulting ¹³C-NMR spectra with the branched analogue (e.g. PEA1-1.5 in section 3.4.1.2). The absence of the carbon peaks 6, 7 and 8 shown in Figure 3.6, for the linear polymer was noted.

Method 2

The identification of the structural units through method 1 is only possible when the number of bonds between the two amine groups within the B₄-monomer is such that the α-methylene carbons are able to produce two distinguishable chemical shifts from different structural units (e.g. HDA monomer). However, in this work the polymerisation reaction was also carried out using EDA, a monomer with a shorter ethylene chain between the two amine groups and in this case the structural units can be identified instead by using the methylene carbon alpha to the ester group in the PEGDA monomer. These peaks can be observed when the reaction between PEGDA and either EDA or HDA occurs. Thus, the branched units (signal 8 in Figure 3.6) produce a signal at 31.74 ppm while the linear unit (signal 5 in Figure 3.6) has a peak at 33.90 ppm. The assignment of these peaks was proved by reference to the work of Tu *et al.*¹ and other similar systems reported in the literature^{5,14}.

For HDA, the results obtained for the DB calculated by methods 1 and 2 are compared in Table 3.2, for the reaction with a molar ratio A₂:B₄ of 3:1. The values obtained show a potential error of ≤5% between the two methods. If not specified, method 2 is used throughout this work in the calculation of the DB. Degree of branching data will be included in the subsequent discussion.

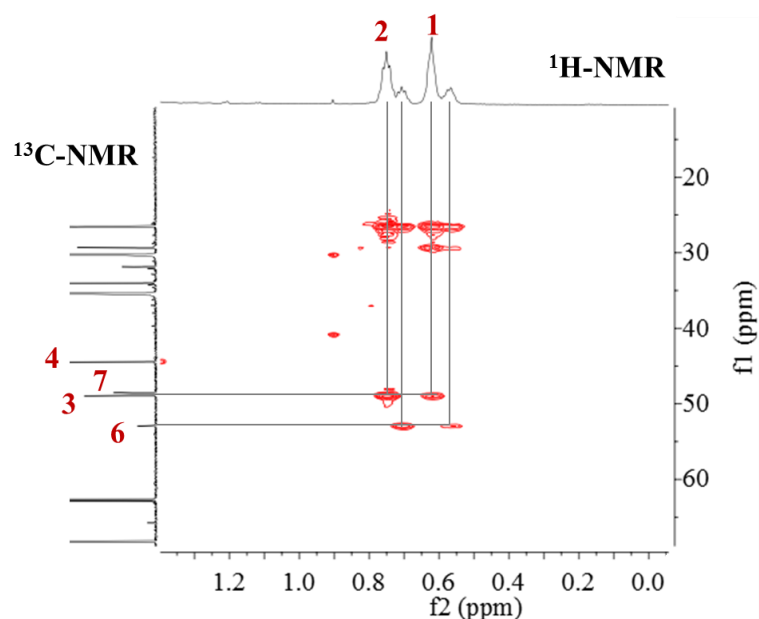

Figure 3.7 $^1\text{H},^{13}\text{C}$ -HMBC of the crude product of the polymerisation the reaction in bulk at 60°C with a molar ratio $\text{A}_2:\text{B}_4$ of 1.5:1 (see Figure 3.6 for the assignment).

3.4.1.2 Hyperbranched poly(PEGDA-HDA) - PEA1: effect of $\text{A}_2:\text{B}_4$ molar ratio.

The polymerisation reaction between A_2 (PEGDA) and B_4 (HDA) monomers was studied in DMF at 60°C (total monomer solution concentration, 18% w/v) at various monomer molar ratios, in order to investigate the relationship between the structure of the resulting polymer and the ratio of A and B functional groups. The series of polymers synthesised from this monomer pair is identified as PEA1. The monomer molar ratios ($\text{A}_2:\text{B}_4$) investigated were: 3:1, 2:1, 1.5:1 and 0.8:1 or in terms of the ratio of functional groups acrylate:N-H (A:B) the ratios were respectively 6:4 (excess of A groups), 4:4 (equal moles of A and B groups), 3:4 and 1.6:4 (excess of B groups). The polymerisation reactions were monitored by ^1H and ^{13}C -NMR and by SEC analysis and all the samples were analysed without any purification.

^1H -NMR was used to estimate the conversion of A groups during the polymerisation reaction; the results obtained are listed in Table 3.2. The values obtained for the last samples analysed before gelation can be compared with the values obtained from the theoretical models of Carothers (p_A^C) and Flory-Stockmayer p_A^{FC} ⁴⁴. The comparison between the three sets of data shows that the experimental results are in between the theoretical values predict by the models, in agreement with the previously reported observations that Carothers's theory overestimates the conversion at the gel point while Flory-Stockmayer theory underestimates it^{44,45}.

The data reported in Figure 3.8 and Table 3.2 show that PEA1-1.5 ($A_2:B_4$ 1.5:1) reaches a higher weight-average molecular weight (M_w) after 48 hours than PEA1-3 ($A_2:B_4$ 3:1), PEA1-2 ($A_2:B_4$ 2:1) and PEA1-0.8 ($A_2:B_4$ 0.8:1). Similar or higher M_w are observed for PEA1-3 and PEA1-2 after 120 and 96 hours respectively. In contrast, the SEC chromatograms of the sample PEA1-0.8 does not show any change in terms of molecular weight and \bar{D} after five hours, suggesting that at such a molar ratio, the reaction is completed in the first 5 hours. This assumption is supported by $^1\text{H-NMR}$ which indicates full conversion of the acrylate groups for PEA1-0.8 as PEGDA is in this case the limiting monomer. The viscosity and light scattering data are shown for all these samples in the Appendix A, Figure A.1 and A.2.

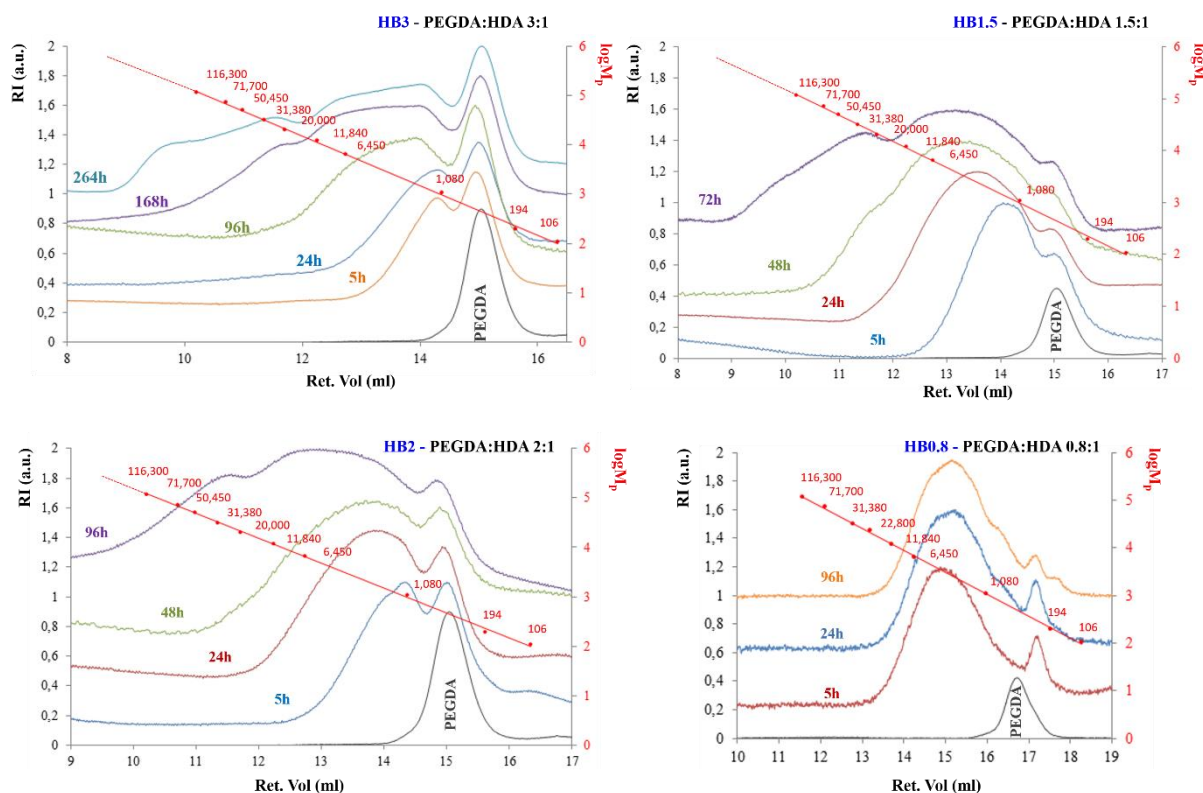

Figure 3.8 Effect of the molar ratio on the molecular weight and dispersity for the crude products of the samples PEA1-3, PEA1-2, PEA1-1.5, PEA1-0.8 taken from the mixture at different times. The chromatograms (RI detector, DMF+0.1%LiBr eluent) of each sample are overlapped with that of the PEGDA starting monomer to indicate the residual PEGDA of the reaction and the calibration curve of PEO standards used to calculate the relative molecular weight of the resulting polymer.

$^{13}\text{C-NMR}$ spectroscopy was used to characterise the architecture of the resulting polymers PEA1-3, PEA1-2, PEA1-1.5, and PEA1-0.8 at varying reaction times by the calculation of the DB. The DB values in Table 3.2 show that for PEA1-0.8, the molar ratio (0.8:1) does not promote the formation of a sufficient a number of branched units to describe the polymer as hyperbranched. Typical DB values for hyperbranched polymer are in the range of 0.40-0.60.

Therefore, for PEA1-0.8 a DB of 0.18 suggests a slightly branched structure with a predominance of linear units. In contrast, samples PEA1-3, PEA1-2 and PEA1-1.5 all developed a branched architecture; in particular, a DB of c.a. 0.50 was obtained after 24 hours for PEA1-3 and PEA1-2 while a DB of 0.35 was obtained for a sample of PEA1-1.5 taken from the reaction mixture after 48 hours. The development of a branched architecture for the PEA1-3, PEA1-2 and PEA1-1.5 samples is also supported by the Mark-Houwink plot shown in Figure A.3 of the Appendix A. These plots represent the relationship between molecular weight and intrinsic viscosity, for the samples collected from the reaction mixture before gelation (viscometer detection of the samples in Figure A.2). In these plots, the development of a branched architecture is supported by the reduction in intrinsic viscosity at a given molar mass. In particular PEA3, PEA1-2 and PEA1-1.5 samples showed a significant reduction in intrinsic viscosity compared to the lightly branched polymer PEA1-0.8. A low intrinsic viscosity represents a compact, dense branched architecture, while a high intrinsic viscosity represents a larger more open (unbranched) molecular structure.

Table 3.2 Experimental conditions, characterisation data and theoretical prediction of the gel point for the hyperbranched polymers PEA1-3, PEA1-2, PEA1-1.5, PEA1-0.8 extracted and analysed at different times from the reactions carried out at 60°C in DMF (18% w/v).

Sample	time (h)	A ₂ :B ₄	M _n ^a	M _w ^a	Đ ^a	experimental	theoretical		DB ^c
						% A reacted ^b	p _A ^c	p _A ^{FS}	
PEA1-0.8	5	0.8:1	1050	3150	3.0	100			-
	24	0.8:1	1050	3200	3.0	100	100.0 ^d	90.8	-
	96	0.8:1	1080	3200	3.0	100			0.18
PEA1-1.5	5	1.5:1	650	1500	2.0	-			-
	24	1.5:1	1100	3650	3.5	72			0.25
	48	1.5:1	1200	8550	9.5	78	83.3	66.6	0.35
	72	1.5:1	2150	29700	14.0	80			0.38
PEA1-2	5	2:1	610	1200	2.0	-			-
	24	2:1	950	2500	2.5	55			0.50
	48	2:1	1040	3850	3.7	-	75.2	57.4	-
	96	2:1	1800	22000	10.0	65			0.65
PEA1-3	5	3:1	620	1010	1.5	-			-
	24	3:1	620	1150	1.8	45 (48)			0.45 (0.47)
	48	3:1	635	1350	2.0	48 (48)			0.49 (0.51)
	72	3:1	940	3150	3.5	-			-
	96	3:1	940	3500	3.8	48 (51)	66.7	47.3	0.61 (0.61)
	120	3:1	1000	8500	9.3	-	(100 %B)	(70.7 %B)	-
	168	3:1	1150	15000	15.5	55 (58)			0.75 (0.75)
	192	3:1	1200	18500	16.0	-			-
	216	3:1	1200	19500	16.5	-			-
264	3:1	1300	30000	23.5	60 (65)			0.83 (0.85)	

^a with M_w and M_n in g/mol and calculated by DMF SEC analysis with PEO as standards; ^b calculated by ¹H-NMR according to the equation 3.1 and the equation 3.2 (section 3.4.1.1); ^c calculated by ¹³C-NMR according to the method 1 and method 2 (section 3.4.1.1); ^d the system never gels.

Despite the branched structure achieved for samples PEA1-3 and PEA1-2 after 24 h, the data in Table 3.2 and the chromatograms in Figure 3.8 show that at such time, only the formation of low molecular weight polymers with $M_w = 1150$ g/mol for PEA3 and $M_w = 2500$ g/mol for PEA1-2. Only at longer reaction times are higher molecular weights achieved; $M_w = 22000$ g/mol at 96 h for PEA1-2 and $M_w = 15000$ g/mol at 168 h for PEA1-3. From Table 3.2 it can be observed that the M_n values for samples PEA1-1.5, PEA1-2 and PEA1-3 are always low due to the presence of unreacted PEGDA in the polymerisation mixture analysed. However, the rising values of dispersity with time are an indication of the progress of the polyaddition that proceeds with the formation of fractions with high molar mass (Figure 3.8). In particular, for the polyaddition of PEA1-3 a very broad dispersity ($\mathcal{D} = 23.5$) is observed at 264 hours, due to the formation of a very high molecular weight fraction, as evidenced by the shoulder at low retention volume (9.5 ml, SEC chromatogram in Figure 3.8). Therefore, a comparison of the M_w values for the samples PEA1-1.5, PEA1-2 and PEA1-3 is more significant than the M_n values and enables a study of the behaviour of the reactions.

Moreover, the chromatograms in Figure 3.8 show the presence of unreacted PEGDA eluted at retention volume 15 ml for all the products except for PEA1-0.8 in which full conversion of PEGDA is achieved. Varying amounts (based on area under the concentration curve) of unreacted PEGDA with respect to the whole distribution was observed for the other samples; 35% PEGDA after 72 hours for PEA1-3, 20% after 96h for PEA1-2 and 9% after 72h for PEA1-1.5. The different amounts of residual PEGDA can be explained when considering the different molar ratios used. In fact, the excess of acrylate groups used for the synthesis of PEA1-3 accounts for the higher residual PEGDA peak in this case.

The DB and M_w values obtained in this study show that the molar ratio PEGDA:HDA can have a significant impact on the molar mass and structure of the resulting polymer. As well as impacting upon the different size and structures obtained for polymers PEA1-3, PEA1-2, PEA1-1.5 and PEA1-0.8, the monomer molar ratios used also affected the macroscopic nature of the final product. Thus, an insoluble (cross-linked) gel was recovered after 288 hours for PEA1-3, after 150 hours for PEA1-2 and after 80 hours for PEA1-1.5. Only PEA1-0.8 was recovered as a fully-soluble product, albeit with a lightly branched architecture. It is worth noting that the chromatograms of PEA1-0.8 in Figure 3.8 show also the elution of fractions at retention volume higher than 17.0 ml corresponding at species with molecular weight lower than the PEGDA monomer (eluted around 16.9 ml). The cause of this peak was not investigated since only the linear PEA1-0.8 shows the formation of such species and it is not a purpose of this work to

study the polyaddition of linear polymers. However, it is possible that an amidation reaction can occur as side reaction after the polyaddition and lead potentially to the formation of PEG (poly(ethylene glycol)) eluted at lower retention volume than PEGDA monomer (Scheme 3.4). Amidation in an aprotic solvent such as DMF can take place preferably in the reaction PEA1-0.8 rather in PEA1-1.5, PEA1-2 and PEA1-3 because of the presence of secondary amine groups of the linear units that permits the nucleophilic attack of amine groups on the ester group, which is not possible with the bulky tertiary amine. Such side reactions have already been observed during the polyaddition of tetraethylenepentamine (TEPA) and ethylene glycol diacrylate (EGDA)⁹. In this case a polymer with 29% of tertiary amine, 50% of secondary amine and 21% of primary amine was obtained and amidation has been found to occur only after the addition polymerisation because its low rate of reaction. However, the authors of this work did not observe any change in the degree of polymerisation of the polymer after amidation showing that such side reaction only produced semi-ester groups (see step 1 in Scheme 3.4) and not ethylene glycol.

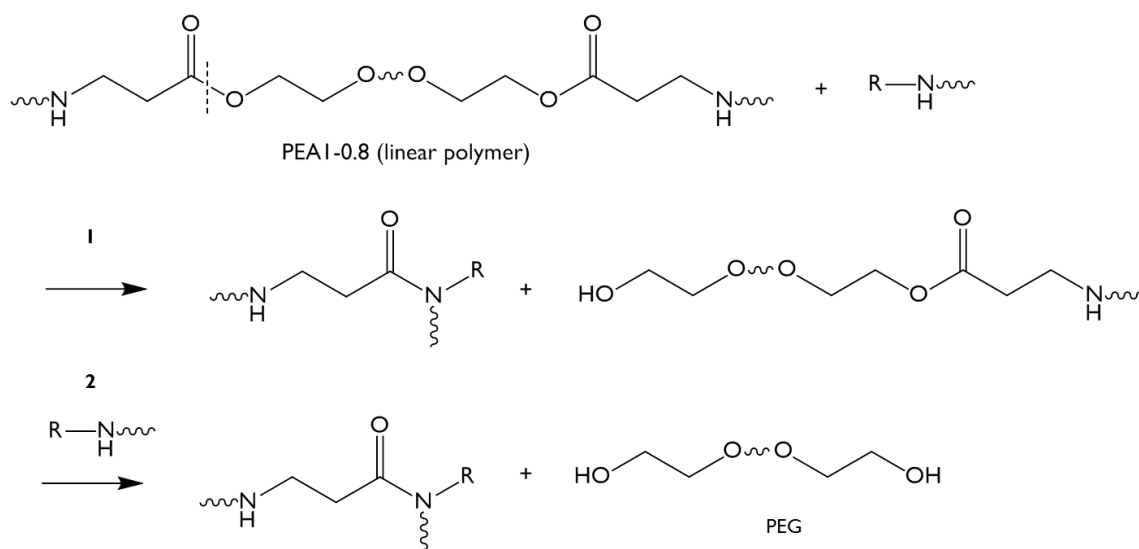

Scheme 3.4 Amidation side reaction supposed during the synthesis of PEA1-0.8

In this section it has been shown that at long reaction times, a fully soluble product can be obtained only when the number of amine groups is in large excess with respect to the acrylate groups (PEA1-0.8) but such conditions do not promote the development of a highly branched architecture. Thus, a relationship exists between the gel formation and the ratio of A and B functional groups. Moreover, the reaction time is also a variable which should be considered in future work in order to make branched and soluble product. In fact, the molar ratios used to synthesis samples PEA1-3, PEA1-2 and PEA1-1.5 did produce soluble, hyperbranched polymer

at intermediate reaction times but ultimately resulted in gelation and a cross-linked products after prolonged times. Although these molar ratios can develop a branched structure, a strategy has to be found in order to inhibit gelation independently of the effect of time on the polyaddition. The molar ratio $A_2:B_4$ of 1.5:1 was selected to carry out further investigations for the synthesis of gel-free hyperbranched polymers. We believe that the results obtained for this monomer feed ratio could, if necessary, be reproduced on reactions with molar ratios $A_2:B_4$ of 3:1 and 2:1.

3.4.1.3 Synthesis of PEA1-1.5 - the effect of temperature.

The reaction with molar ratio PEGDA:HDA of 1.5:1 that forms the polymer PEA1-1.5 was investigated in DMF at 18% w/w at RT to study the effect of the temperature on the reaction and its role in inhibiting gelation. The data in Figure 3.9 indicates the relative rate of reaction (increase of molecular weight with time) at RT and 60°C. The errors in SEC measurements using a conventional calibration are subject to errors in reproducibility and are estimated to be c.a. 1%.

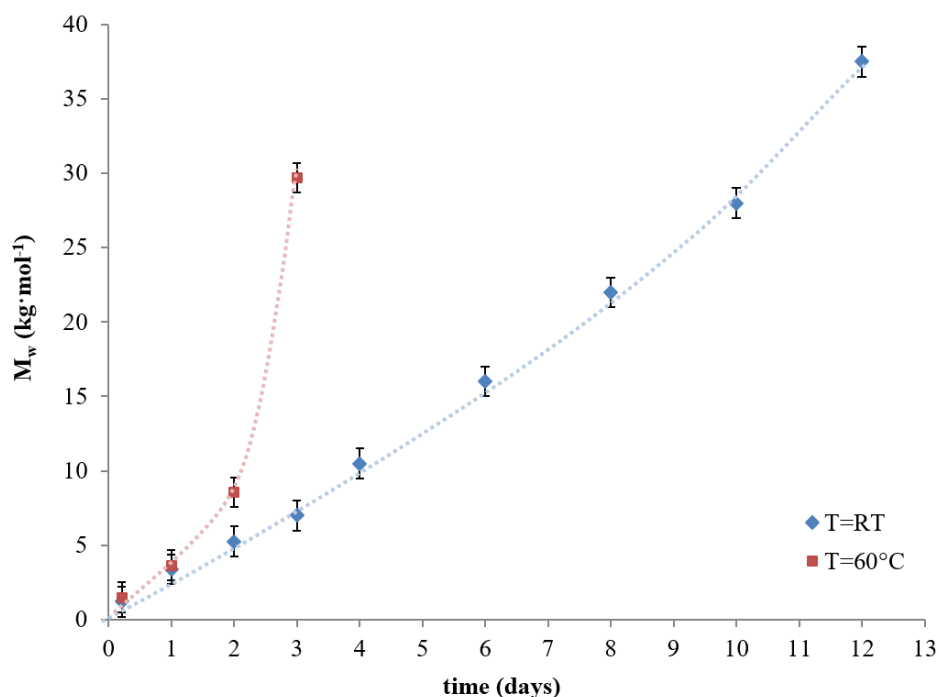

Figure 3.9 Graph to illustrate the different rate of increment of M_w with the temperature during the reaction times. The polymerisation reactions were carried out at RT and 60°C by using a molar ratio PEGDA:HDA of 1.5:1 in DMF (18% w/v). The dotted lines are not experimental curves.

From the figure and the values in Table 3.2 and Table 3.3 it can be seen that no significant difference in molecular weight and DB can be observed after 1 day between the two reactions

($M_w \cong 3500$ g/mol and $DB \cong 0.25$). However, after longer times ($t > 2$ days), the reaction at 60 °C has unsurprisingly proceeded to a much higher molecular weight with an M_w of 29,700 g·mol⁻¹ and $DB = 0.38$ while the reaction at RT only reached similar molecular weight and DB after 8 days (the dashed lines used in Figure 3.9 to connect the experimental points are only a guide to help the visualisation of the rate of the two reactions). The results obtained suggest that the temperature affects significantly the rate of the growth of the polymer; moreover, in both cases gelation was unavoidable during the polymerisation when more than 80% of acrylate groups have been converted, albeit that gelation occurred at different times; 80 hours for the reaction at 60°C and after 300 hours (c.a. 13 days) at RT. For these reactions it has also been observed that it is not possible to completely prevent gelation by precipitating the mixture before the gel point. In fact, the precipitation of a small amount of the reaction mixture following by drying of the residual product led to a gel product. The polymer is hence able to further polymerise during the purification process; consequently, under the conditions used, precipitation does not represent a good strategy to overcome the problem of gelation for these polymers.

Table 3.3 Characterisation data of the crude products resulting from the reaction at room temperature (RT) at different time in DMF (18% w/v) with molar ratio A₂:B₄: 1.5:1.

t (h)	M_n (g/mol) ^a	M_w (g/mol) ^a	\bar{D} ^a	% A conversion ^b	DB ^c
5	650	120	2.0	-	-
24 (1 day)	1100	3400	3.0	60	0.23
48 (2 days)	1500	5250	3.5	-	-
72 (3 days)	1600	7000	4.0	65	0.33
96 (4 days)	1800	10500	5.5	-	-
144 (6 days)	1950	16000	7.5	-	-
192 (8 days)	2000	22000	10.0	70	0.38
240 (10 days)	2300	28000	13.0	-	-
288 (12 days)	2500	37500	17.0	75	0.45

^a calculated by by DMF SEC analysis (RI detector) with PEO as standards; ^b calculated by ¹H-NMR according to the equation 3.1 (see section 3.4.1.1); ^c calculated by by ¹³C-NMR according to the method 2 (see section 3.4.1.1).

3.4.1.4 Synthesis of PEA1-1.5 - the effect of solution concentration.

Monomer solution concentration plays an important role in the polymerisation between monomers pair such as A₂ and B₄ in which there is a risk of gelation. The reaction that yields PEA1-1.5, (1.5PEGA-1HDA), was carried out with a monomer solution concentration of 18% w/v and resulted in gelation after 80 hours. The same reaction was also carried out in DMF at 25% w/v and in bulk. Although these conditions might accelerate the gel formation, it was decided to include these results in this work to explore the role of the concentration and of the

solvent on the polymerisation reaction and at the same time understand how these parameters affect the rate of the reaction. The molecular weight data obtained by SEC analysis for these reactions are shown in Table 3.4. The SEC data refers to intermediate products collected during the reaction at various times and analysed without purification.

For the reactions in solution, Table 3.4 shows that increasing the concentration from 18% to 25% resulted in a significant increase in the rate of reaction. In fact, a concentration of 25% w/v led, in 24 hours, to a polymer with a similar molecular weight and dispersity to that of polymer prepared in a solution concentration of 18% w/v after 48 hours. The similarity in the two products extends to a similar PEGDA conversion of 75-80%, a degree of branching of c.a. 0.35 and in both cases the reactions eventually resulted in gelation albeit at a different rate (80h at 18% and 35h at 25%). The RI and DP chromatograms of the polymerisation carried out at 25% w/v after 24h are shown overlapped in Figure A.4 of the Appendix A. One would expect that monomer concentration would affect the rate of the reaction, however it is remarkable how significant this affect is, even though the difference between the two concentrations used was not particularly high.

Table 3.4 Comparison of the characterisation data of the crude products obtained in solution (DMF) at different concentrations (18% and 25%w/v) at 60 °C and in bulk at RT with molar ratio A₂:B₄: 1.5:1.

t (h)	%w/v	M _n (g/mol) ^a	M _w (g/mol) ^a	D	% A conversion	DB
24	25	1600	12850	8.0	75	0.32
5	18	670	1500	2.2	-	-
24	18	1100	3650	3.5	72	0.25
48	18	1200	8550	9.5	78	0.35
72	18	2150	29700	14.0	80	0.38
1	bulk	950	3000	3.0	55	-
5	bulk	1250	11500	10.0	70	0.35

^a calculated by DMF SEC (RI detector) analysis with PEO as standards; ^b calculated by ¹H-NMR according to the equation 3.1 (see section 3.4.1.1); ^c calculated by ¹³C-NMR according to the method 2 (see section 3.4.1.1).

Moreover, it is worth pointing out that the monomer concentration affects the rate of inter- and intra-molecular reactions between polymer chains and in particular at high monomer concentration intermolecular reactions are encouraged over the intramolecular reactions, leading to an increase in molecular weight of the polymer and gelation in shorter times. Although both the concentrations used (18% and 25% w/v) allow the polymerisation in concentrated conditions, the intermolecular reactions should more readily occur at 25% w/v rather than at 18% w/v. However, in dilute conditions (< 18% w/v) it is expected that the increasing contribution of intramolecular reactions will promote a less pronounced increase in molecular weight and internal cyclisation that might help to inhibit gelation. The formation of

cyclic species in dilute conditions is a strategy already adopted for the synthesis of gel-free hyperbranched polymers from the $A_2 + B_3$ systems^{46,47}. A similar strategy could be adopted as future work for the polyaddition $A_2 + B_4$ discussed in this work, in order to synthesise soluble hyperbranched poly(ester amine)s. In the light of these considerations, the DB values in Table 3.4 calculated from ^{13}C -NMR may also include the percentage of branching points of the possible cyclic species formed in situ together with the branched polymer. However it can be speculated that at concentrations of 18% and 25% w/v the formation of cyclic species should be less likely to occur.

Bulk conditions often represent a good option for reactions since they obviously do not require the use of solvents. This feature is cost efficient in terms of money, time of reaction and handling time and in some cases reduces the toxicity of the reactions. In the current study and based on previously described results, we would have expected a faster rate of reaction and an increased risk of gelation. Unsurprisingly all of the reactions attempted in the bulk did lead to gelation during the polymerisation reaction or after precipitation.

The solution polymerisations using HDA as the B_4 monomer resulted in gelation when the molar ratio $A_2:B_4$ was 1.5:1 at 25 and 18% w/v at 60°C in DMF. Bulk conditions for the reaction with a molar ratio $A_2:B_4$ 1.5:1 would be expected to accelerate the onset of gelation, thus the study of reactions in bulk was carried out at RT (instead of 60 °C). Table 3.4 summarises the results obtained by SEC analysis and ^1H -NMR for this reaction. Comparing these results with those obtained for the reactions in solution at 25 and 18 % w/v shows that the reaction in bulk proceeds much faster than that in solution even though the temperature was lower. In fact after 5 hours (in bulk and at RT) the molecular weight of the polymer and the acrylate group conversion were similar to the values obtained after 24 hours when the concentration of the monomer was 25 %w/v or after 2 days when the concentration was 18 %w/v. As expected the reaction in bulk also reached gelation as those in solution had, despite carrying out the reaction at lower temperature - gelation was observed after 7 hours.

3.4.1.5 Hyperbranched poly(PEGDA-EDA) – PEA2: effect of a shorter aliphatic spacer.

The reaction between PEGDA and HDA with a molar ratio 1.5:1 was selected for further investigation of the synthesis of gel-free hyperbranched poly(ester amine)s. It has been discussed previously that modifying parameters such as monomer concentration and temperature results in a significant change in the rate of the reaction. In these circumstances all

the reactions eventually resulted in gelation during the polymerisation reaction. In this section the reaction PEGDA-HDA (PEA1) with molar ratio 1.5:1 is repeated but modified by replacing the HDA (B₄) with EDA; the polymerisation was carried out at 60 °C both in DMF at 25% w/v and 18% w/v and in bulk (Scheme 3.3). The products of these reactions were labelled as PEA2.

Polymerisation reaction of PEA2 in solution

The reaction between PEGDA and EDA in DMF at 25% w/v showed a different rate of the reaction compared to the reaction carried out with HDA as B₄ monomer. For the two diamines the molecular weight values and DB obtained are summarised in Table 3.5. It should be noted that the resulting polymers, although similar in molecular weight, were obtained after different reaction times. Moreover, in both cases the polymerisations lead to gelation at different times: 35h for the reaction with HDA and 20h for that with EDA. These data suggest that by replacing HDA with EDA an increase of the rate of the reaction occurs.

Table 3.5 Characterisation data of the resulting crude products obtained at different times from the reaction PEGDA-EDA at 60°C in DMF (18% w/v) with molar ratio A₂:B₄: 1.5:1.

sample	% w/v ^a	t (h)	M _n ^b	M _w ^b	Đ ^b	%A conversion ^c	DB ^d
PEA1	25	24	1600	12850	8.0	-	0.32
PEA2	25	5	1000	12500	12.0	-	0.40
	18	1	320	850	2.5	-	-
	18	2	500	1450	3.0	-	-
	18	5	720	2850	4.0	-	-
PEA2	18	24	1150	18000	15.5	85	0.50
	18	48	1350	33250	24.5	-	-
	18	72	1500	40500	25.5	-	-
	18	120	1500	40000	27.5	90	0.70

^a monomer concentration; ^b in g/mole, calculated by DMF SEC analysis with PEO as standards; ^c calculated by ¹H-NMR according to the equation 3.1 (see section 3.4.1.1); ^d calculated by ¹³C-NMR according to the method 2 (see section 3.4.1.1).

Very different behaviour was observed when the monomer concentration was decreased from 25% w/v to 18% w/v. In this case, the reaction with EDA did not lead to gelation even after 5 days. The progress of the reaction was followed by SEC analysis (Figure 3.10); and the corresponding molecular weight values of the samples collected at various reaction times are reported in Table 3.5. The DP chromatograms are shown in Appendix A, Figure A.4. The table shows that the values of M_w in the reaction with EDA increases faster in the first 48 hours and then gradually at higher conversions (> 85%) where the reaction between polymers predominates, as opposed to reaction between polymer and monomer. The reaction between PEGDA and EDA at 18% w/v proceeds for 120 hours with the formation of a broad molecular weight distribution and with very high molecular weight fractions eluted between 10 and 13 ml. After 120 hours, a highly branched structure with a DB of 0.70 is obtained without gelation.

Despite these encouraging results obtained for the reaction with EDA, the risk of gel formation is still to be considered during the recovery and purification steps. In this case the polymer was precipitated into diethyl ether and a viscous product was recovered. This product, not yet fully dried, was soluble in water, DMF, DMSO, MeOH and CH₃Cl but once dried completely in vacuum oven, a gel product was obtained. Thus, the polymer in the bulk form would appear to continue reacting and form a cross-linked structure during the storage in vacuum oven.

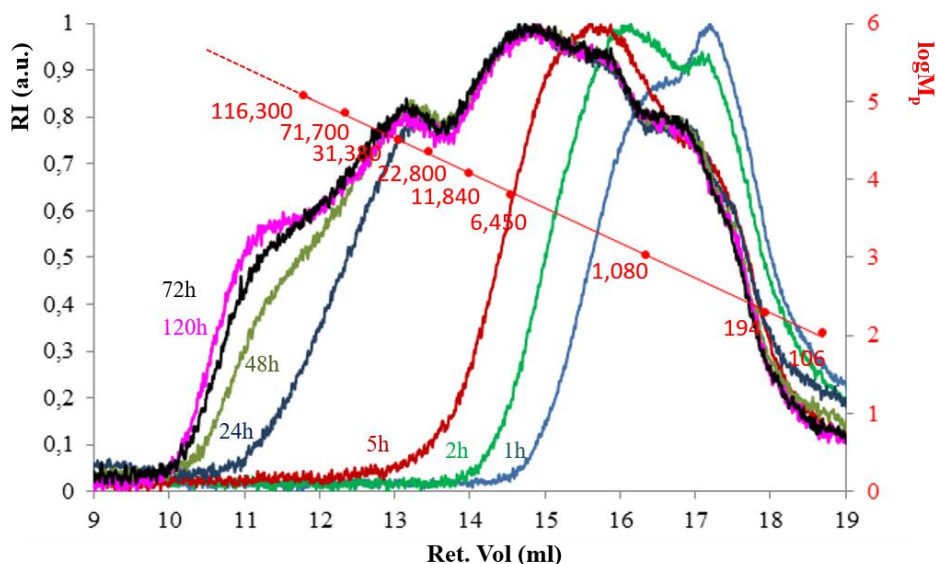

Figure 3.10 DMF SEC chromatograms for the polymerisation of PEGDA-EDA (in DMF, 18% w/v, A₂:B₄ = 1.5:1, 60° C) as a function of reaction time

A comparison between the rate of the reaction with EDA (PEA2) and the one carried under the same conditions with HDA (PEA1) as B₄ monomer is depicted in Figure 3.11; the errors in SEC measurements using a conventional calibration are subject to errors in reproducibility and are estimated to be less than 2%. The graph shows that during 72 hours the reaction forming PEA2 proceeds with a higher rate of reaction compared to PEA1 and therefore at 24 hours the product of the polyaddition PEGDA-EDA (PEA2) has higher M_w compared to that of PEGDA-HDA (PEA1). The molar mass of the polymer formed using HDA increased steadily for 72h and only at such time was a polymer with similar M_w value to that achieved for PEGDA-EDA obtained. However, this increase in molecular weight leads the reaction with HDA to gelation after 80 hours.

The different rate of the reactions observed for PEA2 and PEA1 may be due to the different solubility of the HDA and EDA monomers in DMF and their different physical state. EDA is in fact a liquid which is fully soluble in DMF and therefore readily available for the polyaddition once added to the solution of PEGDA in DMF. HDA monomer is instead only partially soluble

in DMF but it was found that its solubility increased in DMF in the presence of PEGDA because of the occurrence of the polyaddition reaction and fully solubility can be achieved for HDA monomer when added to a solution of PEGDA in DMF. In addition, HDA is a solid compound and in this case also a solubilisation time of the monomer in PEGDA/DMF has to be considered. Therefore, it can be speculated that the onset of the homogeneous polymerisation is delayed when HDA is used. However, at 72 hours a different behaviour can be observed. PEA1 (polyaddition PEGDA-HDA) increases the molecular weight until the formation of a gel product while PEA2 (polyaddition PEGDA-EDA) does not change significantly its molecular weight and remains soluble as a branched polymer in DMF solution.

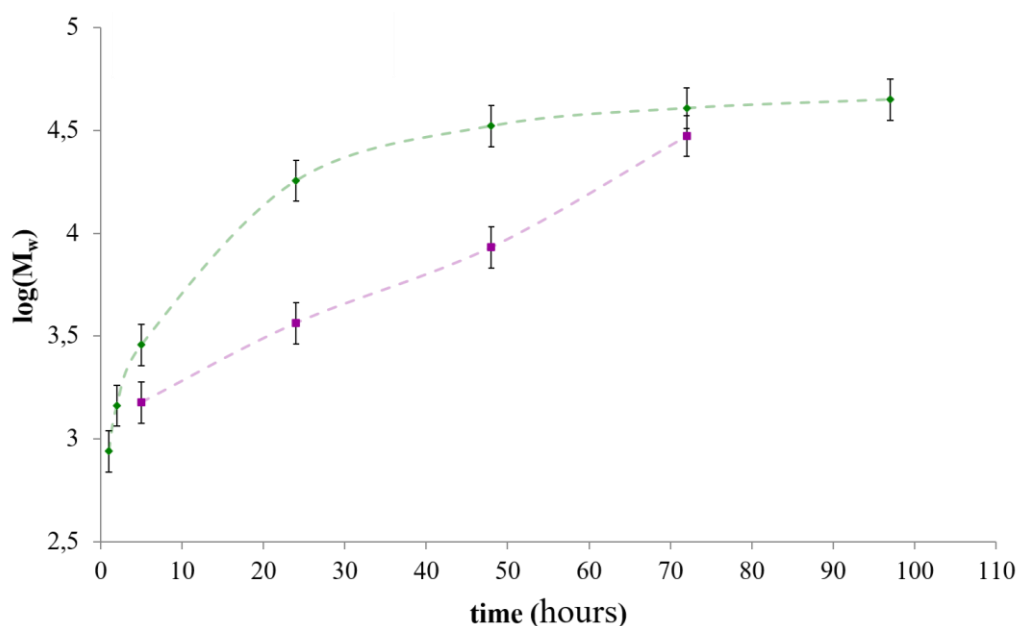

Figure 3.11. Comparison of the rate of increment of weight-average molecular weight (M_w) with reaction time of the product resulting from the polyaddition of PEA2 (green curve) and PEA1 (purple curve). Both reactions were carried out in solution (DMF, 18%w/v) at 60°C with molar ratio $A_2:B_4$: 1.5:1.

These results can be explained on the basis of the different aliphatic chains length of EDA and HDA that lead to a different flexibility of the polymer structure and availability of the functional groups for the polyaddition. In particular, the longer chain of the HDA monomer increases the flexibility of the monomer in solution and consequently the N-H groups are more available for the reaction while the steric hindrance of the NH groups and the rigidity of a short chain in the EDA monomer inhibits further polymerisation that would result in gelation. A similar effect has been already observed by Horie *et al.* for the curing reaction of epoxide with EDA, TDA (trimethylene diamine), HDA⁴⁸. In this work the authors reported that only when HDA is used does the curing reaction reach 100% conversion, due to the flexibility of the hexamethylene

chain. The conversion achieved with EDA and TDA was in the range of 80-90% because the restricted mobility of the chain, limits the possibility of reaction for the functional groups by crosslinking.

Polymerisation reaction of PEA2 in bulk.

The reaction of PEGDA and EDA with a molar ratio of 1.5:1 did not lead to gelation during the polymerisation in solution at 18 % w/v and $T=60^{\circ}\text{C}$. An analogous reaction was carried out in bulk. In contrast to the reaction carried out in solution, the bulk reaction rapidly proceeded to gelation in less than 1 hour. A sample collected from the reaction mixture after only 20 min, that is before the onset of gelation, proved to be a polymer with a modest molecular weight and molecular weight distribution: M_n 750 g/mol; M_w 5750 g/mol; Đ 8.0. In addition, ^{13}C -NMR data confirmed the formation of branched polymer with a DB of 0.35 and a conversion of acrylate groups of c.a. 75 % after only 20 minutes of reaction.

All the reactions in bulk are so rapid that an insoluble, crosslinked product is obtained in relatively short time which is the main disadvantage of working in bulk; namely the limited control over the reactivity of the monomers and therefore gelation. Since the primary goal of this research is to develop a synthetic route to produce soluble, hyperbranched polymers rather than cross-linked insoluble gels, an alternative approach must be considered.

All the reactions described above showed that it is possible to synthesise a hyperbranched polymer in solution (DMF) and in bulk with monomers such as PEGDA and HDA/EDA. However, in all cases the hyperbranched polymer continues to react – sometimes after recovery and upon storage to eventually result in gelation. Only in two cases was gelation not observed in solution during the reaction: (a) for the synthesis of PAE1-0.8 but in this case the molar ratio leads to a predominantly linear polymer and (b) for the polyaddition of PEGDA-EDA but gelation occurs after precipitation of the mixture when the polymer is dry. In all cases, gelation takes place when full conversion of the limiting monomer (PEGDA) occurs for the reactions with $A_2:B_4$ of 1.5:1. Gel formation is difficult to inhibit by the reaction conditions thus the end-capping of a portion of B functional groups is a strategy that was chosen to stop gelation.

3.4.2 Synthesis in solution (DMF) of hyperbranched poly(ester amine) by “ $A_2 + A + B_4$ ” strategy.

Hyperbranched polymers can be synthesised by an $A_2 + B_4$ methodology; however the results above show that it is very difficult to prevent the polymerisation from proceeding to gelation –

even if in some cases, gelation only occurs after recovery of the polymer. It was decided therefore to explore alternative strategies to not only prevent gelation during the polymerisation but also to stabilise the product to further reaction upon storage. One approach considered useful involved the addition of a mono-functional co-monomer to the $A_2 + B_4$ system as shown in Scheme 3.5.

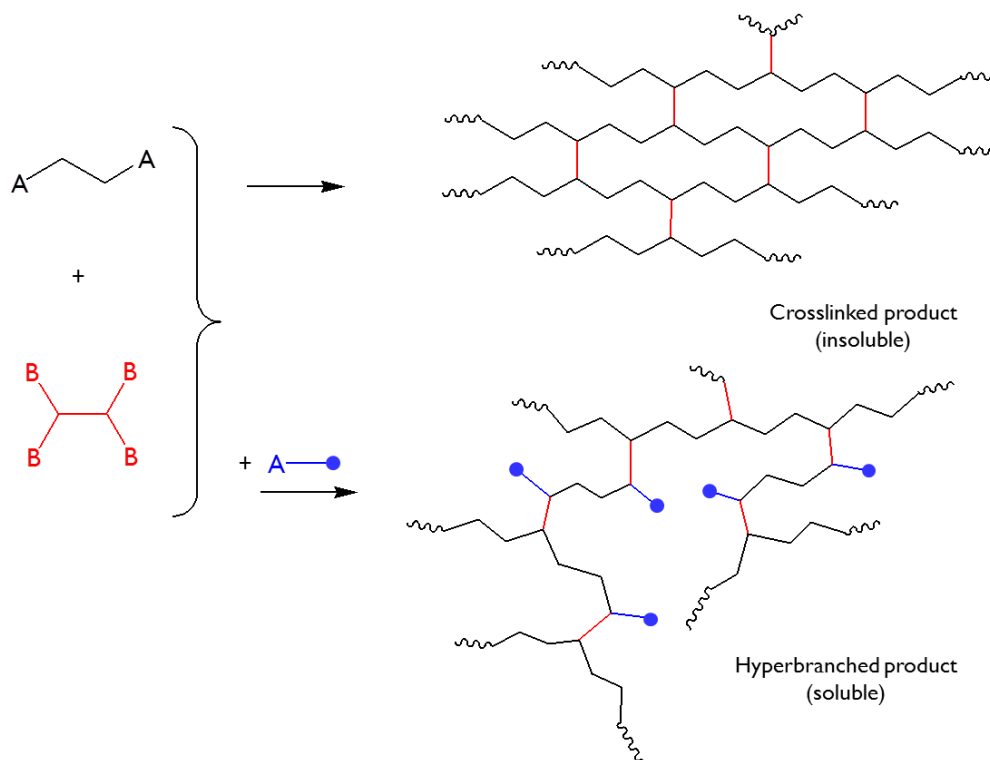

Scheme 3.5 Schematic representation of the polymerisation between A_2 and B_4 monomers without and with a monofunctional A-monomer leading to a crosslinked and hyperbranched polymer respectively.

It was anticipated that the addition of such a monomer would effectively ‘cap’ a proportion of the growing chains, thereby inhibiting further growth (and crosslinking leading to gelation) and under ideal conditions would render the final polymer “inert” to further reaction by ensuring the absence of any unreacted A or B groups. Although one would expect this strategy also to have an impact on the final molecular weight – maybe even offer an opportunity to control the molecular weight – it also has the advantage of enabling the introduction of further, orthogonal functionality to the resulting hyperbranched polymers.

For hyperbranched poly(ester amine)s, the introduction of a mono-functional co-monomer has previously been carried out **at the end** of the polymerisation, to ‘cap’ one of the residual functional groups.^{1,5,29} However post-polymerisation end-capping offers little benefit in terms of influencing the molecular weight of the polymer or indeed of inhibiting gelation. In one such case a post-polymerisation capping strategy was attempted but in the main, the results presented

in the next sections see the introduction of the mono-functional monomer at the start of the reaction as a co-monomer for the synthesis of poly(ester amine)s. For this reason the choice of the molar ratio $A_2:A:B_4$ is crucial to permit the formation of a soluble polymer with reasonable molar mass and a branched structure.

3.4.2.1 A-monomer introduced post-polymerisation.

The synthesis of hyperbranched poly(ester amine) polymers using PEGDA (A_2) and EDA (B_4) as starting monomers in DMF (18% w/v) has been described above in section 3.4.1.5.

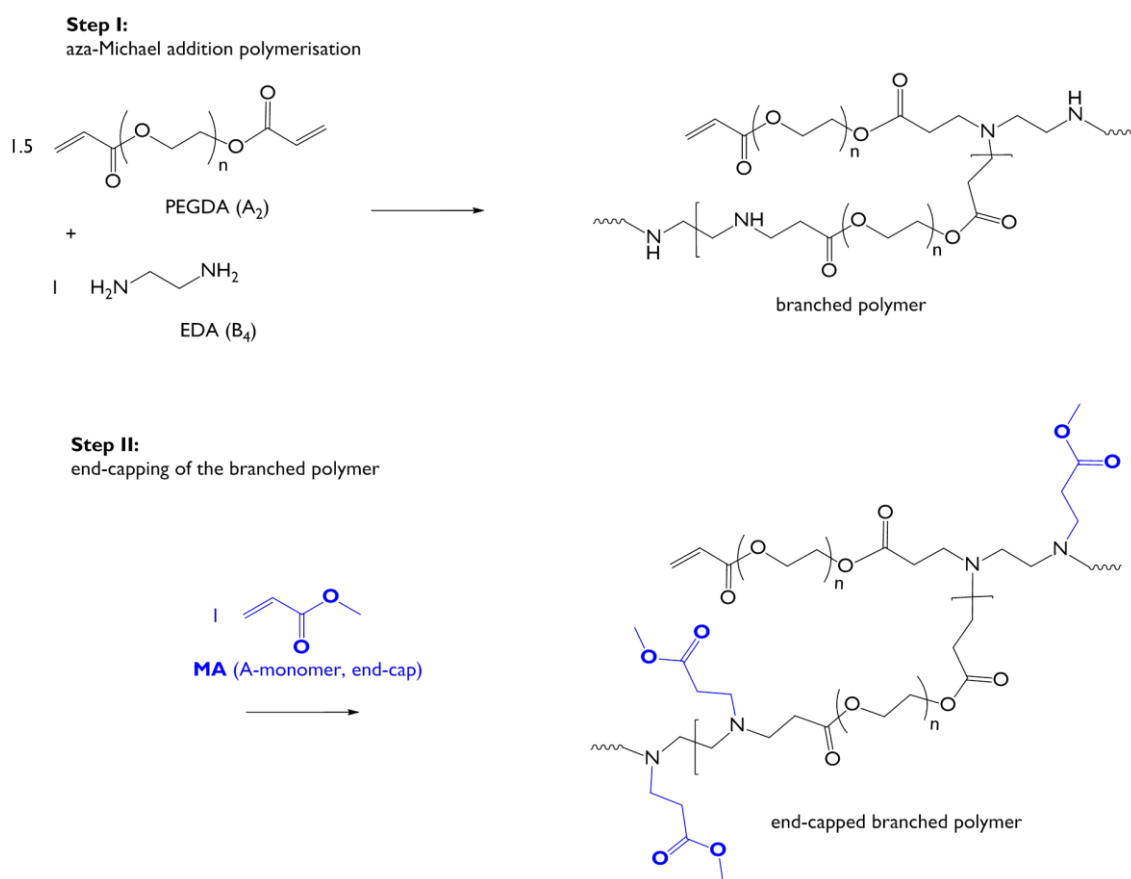

Scheme 3.6 Schematic representation of the hyperbranched poly(ester amine) by using PEGDA and EDA as starting monomers (Step I) and the end-capping (Step II) of the resulting polymer by using a single monomer functionality (MA-monomer).

The molar ratio 1.5:1 of $A_2:B_4$ resulted in c.a. 85% conversion of acrylate groups and the development of a branched soluble structure (DB 0.50) after 24 hours. No gelation was observed even after 120 hours. It is worth recalling that the same reaction with HDA as B_4 monomer formed a gel product after 80 hours. Nevertheless, the polymer synthesised with EDA turned into a gel when the recovered polymer was stored in bulk. Thus, in this case the mono-functional monomer was introduced post-polymerisation to understand if the capping of a portion of unreacted A (acrylate group) or B (N-H groups) functional groups can inhibit the gel formation

of the recovered polymer. A first attempt was carried out by end-capping the N-H groups 24 hours after the start of the polymerisation reaction; for this purpose methyl acrylate (MA) was used as the mono-functional A monomer (Scheme 3.6).

The polymerisation was carried out in DMF at a monomer concentration of 18% w/v with a molar ratio $A_2:B_4$ of 1.5:1 (Step I, Scheme 3.6). The molecular weight of the polymer before the addition of MA was: M_n 1150 g/mol; M_w 12500 g/mol; \bar{D} 11.5. Moreover 1H -NMR showed that 85% of acrylate groups had reacted. These data are in very good agreement with the results of a previous reaction carried out under the same conditions (Table 3.5) and demonstrates a high degree of reproducibility. The presence of unreacted N-H groups at the end of the polymerisation cannot be easily proved by 1H -NMR because of the numerous chemical environments obtained after the reaction; however the stoichiometry of A_2 and B_4 used imposes an excess of N-H groups and the identification of linear units in the ^{13}C -NMR supports the existence of unreacted N-H groups. The end-capping monomer (MA) was added in excess with respect to the N-H groups present within the polymer's structure after polymerisation (1 mole) and the mixture stirred for a further 24 hours (Step II, Scheme 3.6). The polymer after the addition of MA had a molecular weight: M_n 1200 g/mol; M_w 11000 g/mol; \bar{D} 10.0. The values are as expected unchanged with the respect to those obtained before the addition of MA. This result suggests the reaction of MA with the polymer occurred otherwise an increase of M_w should have been obtained after 48h as shown in Table 3.5 for the same reaction without the end-capping.

However, gelation was not avoided by introducing MA at the end of the polyaddition; in fact the precipitation of the mixture led to a gel product during the storage of the polymer in a vacuum oven. This behaviour might be due to the incomplete reaction of the N-H groups of the polymer with MA in solution and in this way the residual amine groups are still available to form a cross-linked structure after precipitation of the mixture on the bulk polymer. It can be speculated that the steric hindrance of the N-H groups in a short chain as in the EDA units may have reduced the accessibility of the MA monomer and hence limited the end-capping reaction in solution.

3.4.2.2 A-monomer introduced as starting monomer.

The effect of adding a mono-functional monomer was studied on a reaction that had previously been shown to be susceptible to gelation during polymerisation – namely the polyaddition of PEGDA and HDA at 60 °C in DMF (25% w/v) and in bulk with a molar ratio $A_2:B_4$ of 1.5:1 –

i.e. with a slight excess of N-H groups. Methyl methacrylate (MMA, A'-monomer) and methyl acrylate (MA, A-monomer) were selected as potential mono-functional monomers to “cap” the excess of N-H groups. MMA is an A'-monomer as its functional group is a methacrylate and the methyl group in alpha position to the ester group confers lower reactivity than the acrylate group of the PEGDA while MA is an A-monomer because it has the same functional group and hence the same reactivity as the A₂-monomer. In order to develop a branched architecture and “cap” only the excess of N-H groups of the reaction with A₂:B₄ of 1.5:1, the amount of the three starting materials (A₂, B₄, A or A') was chosen such that the total ratio of A or (A + A') groups and B groups was 1:1 (molar ratio A₂:A/A':B₄ monomers was 1.5:1:1 - see Scheme 3.7).

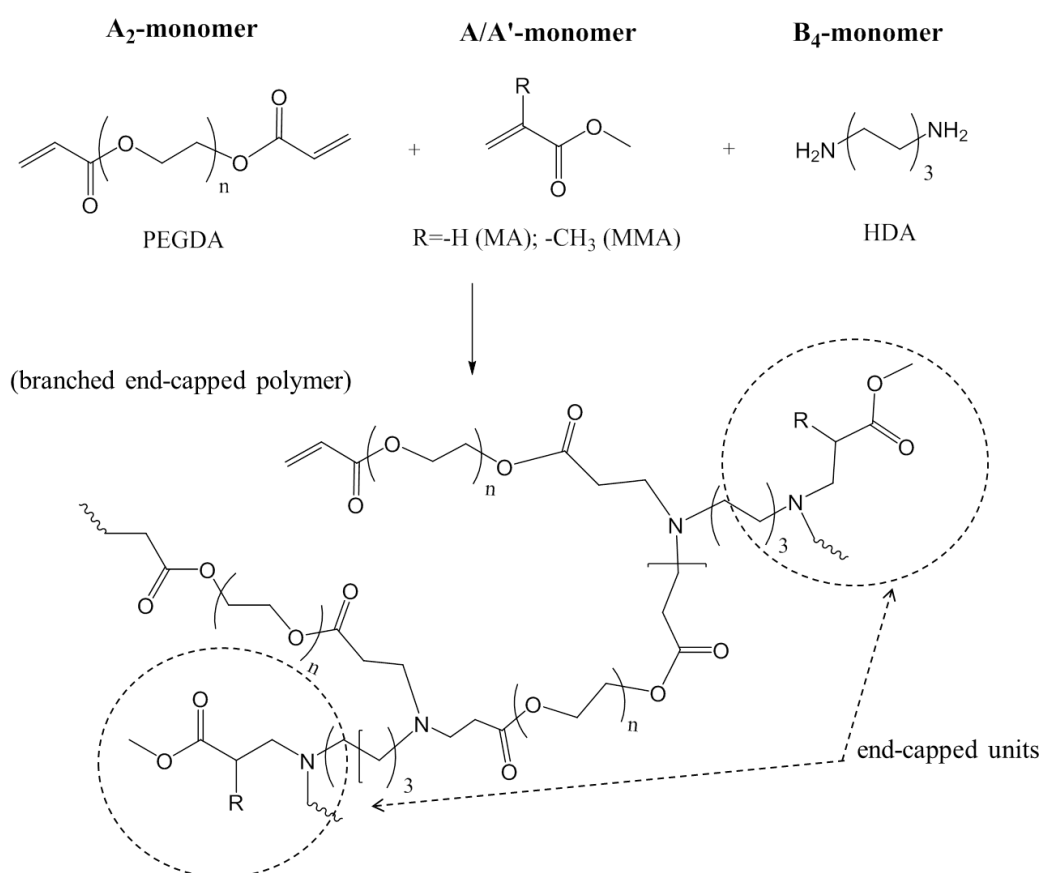

Scheme 3.7 Schematic representation of the end-capped hyperbranched poly(ester amine)s via (A₂+A/A'+B₄) approach in one-pot reaction. The end-capped units of the polymer are encircled in the figure.

3.4.2.2.1 Synthesis of hyperbranched poly(ester amine) with methyl methacrylate (MMA) monomer as A-monomer.

The reaction of PEGDA-HDA with MMA as end-capping monomer was carried out with a molar ratio A₂:A:B₄ of 1.5:1:1, a ratio of functional groups A:B of 1:1, in DMF (25% w/v) at 60 °C. One would expect a lower reactivity for MMA compared to PEGDA as the methyl

substituent on the carbon-carbon double bond increases the electronic density on the vinyl group, decreasing its ability to act as Michael acceptor. Nevertheless, we investigated this compound because the vinyl group can easily be distinguished from the vinyl groups of the PEGDA (Figure 3.12). Therefore the PEGDA conversion was calculated using Equation 3.1.

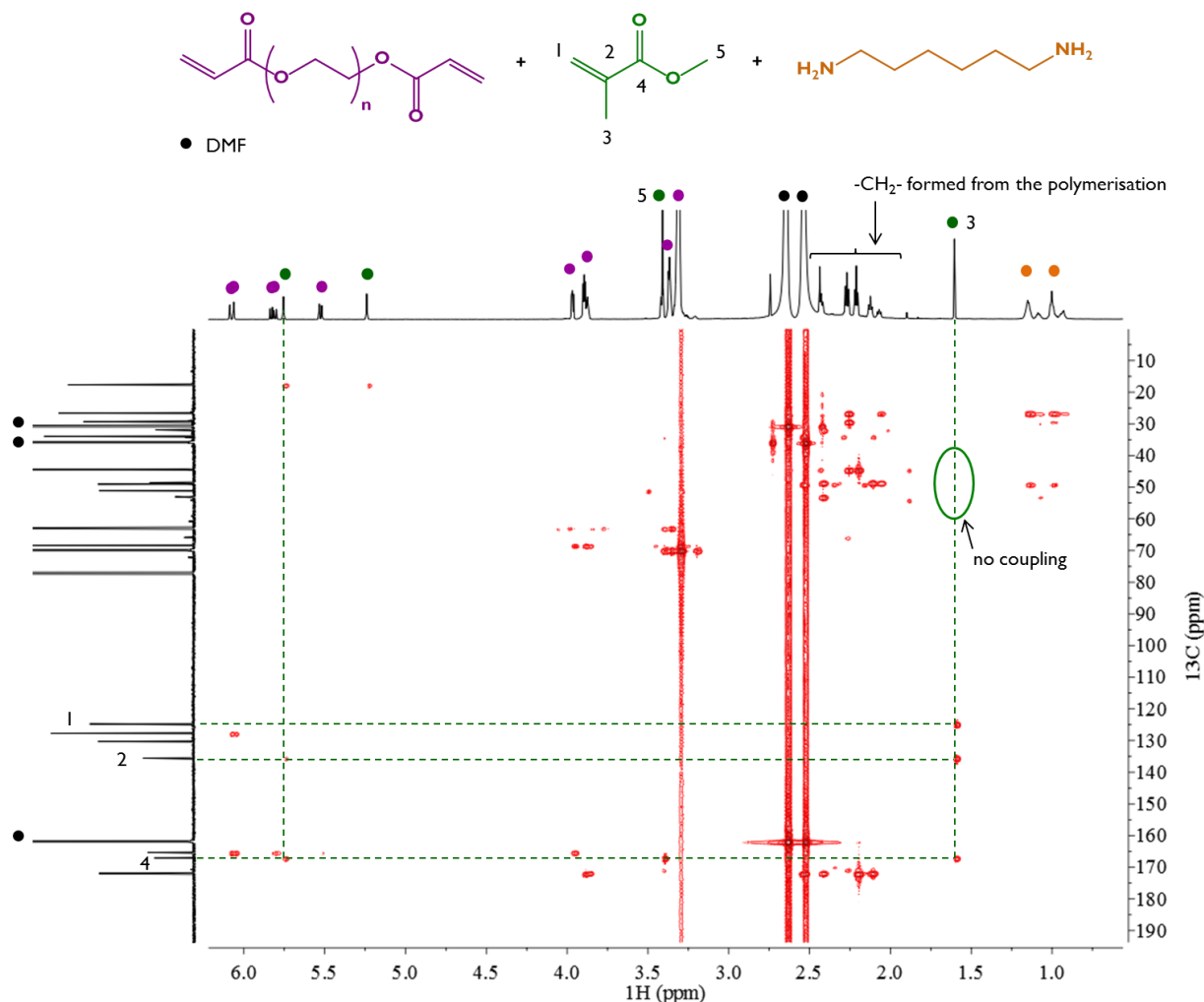

Figure 3.12 ^1H , ^{13}C -HMBC spectra (CDCl_3) of the crude product obtained from the polymerisation reaction between PEGDA (purple dots) and HDA (orange dots) and no evidence of the reaction between MMA (green dots) and HDA.

As in previous cases, all the analyses were carried out directly on samples extracted from the reaction mixture without any further purification. Despite of the advantages that MMA offers in terms of the characterisation of the polymer, the absence in Figure 3.12 of coupling between the methyl proton (peak 3) at 1.60 ppm and the carbon signals in the range 40-60 ppm where the methylene groups formed from the addition of the vinyl groups of the MMA with HDA should appear, proves the inability of the MMA monomer to take part to the reaction. The methyl proton 3 (Figure 3.12) is only coupled with the vinyl carbon peak and the carbonyl

carbon of the unreacted MMA. All the other couplings in the ^1H , ^{13}C -HMBC spectra are evidence of the polyaddition reaction between PEGDA and HDA. The inability of the MMA to take part to the reaction resulted in gelation after 28 hours as was seen for the analogous reaction without any end-capping monomer (3.4.1.3).

Table 3.6 Characterisation data of the crude product taken and analysed from the reaction PEGDA-HDA-MMA (in DMF (25% w/v), T=60°C molar ratio A₂:A:B₄: 1.5:1:1) at different reaction times.

<i>t</i> (h)	M _n (g/mol) ^a	M _w (g/mol) ^a	Đ ^a	%A (A ₂) conversion ^b	%A (A) conversion ^b	DB ^c
3	1000	3000	2.5	73	0	0.11
24	1700	10900	7.5	76	0	0.20

^a calculated by DMF SEC analysis with PEO as standards; ^b calculated by ^1H -NMR; ^c calculated by ^{13}C -NMR according to the method 2 (see section 3.4.1.1).

Table 3.6 shows the molecular weight data for the product obtained before the gel point. The RI and DP chromatograms are shown in Appendix A, Figure A.6. A comparison of the results of this reaction and the analogous reaction carried out in the absence of MMA (Table 3.4) shows that the results are very similar. In fact, almost the same molecular weight distribution is achieved after 24 hours of reaction and in both cases gelation occurred during the polymerisation after around 30 hours.

These results strongly suggest that the methyl methacrylate played no part in the reaction, thus a mono-functional monomer with the same reactivity as the A₂ monomer was used and methyl acrylate (MA) was selected. In this way HDA should react equally with the two Michael acceptors A₂ and A, ignoring the mobility effect of the two monomers that might arise due to their different size.

3.4.2.2.2 Synthesis of hyperbranched poly(ester amine) with methyl acrylate (MA) monomer as A-monomer.

The reaction of PEGDA-HDA with MA as end-capping monomer was carried out with a molar ratio A₂:A:B₄ of 1.5:1:1 in DMF (25% w/v) at 60 °C. The reaction was followed by SEC analysis and ^{13}C -NMR with samples were analysed during the reaction without any purification. In Figure 3.13 and Figure A.7 of the Appendix A the RI and DP chromatograms are respectively shown. From the Figure 3.13 two observations arise; (1) in the presence of MA, the polymerisation reaction proceeds with the growth of polymer with time; (2) gelation does not occur during the polymerisation reaction – even after 144 hours – whereas for the analogous reaction without a mono-functional co-monomer, gelation occurred after 35 hours. The molecular weight and the dispersity of the polymer continue to increase throughout the reaction which is evident by the shift of the main peak to lower retention volumes and the significant

broadening of the molecular weight distribution, The formation of the two shoulders at retention volumes of around 13.0 (after 72 hours) and 11.0 ml (after 144) indicates the generation of chains of very high molecular weight. The molecular weight values are reported in Table 3.7.

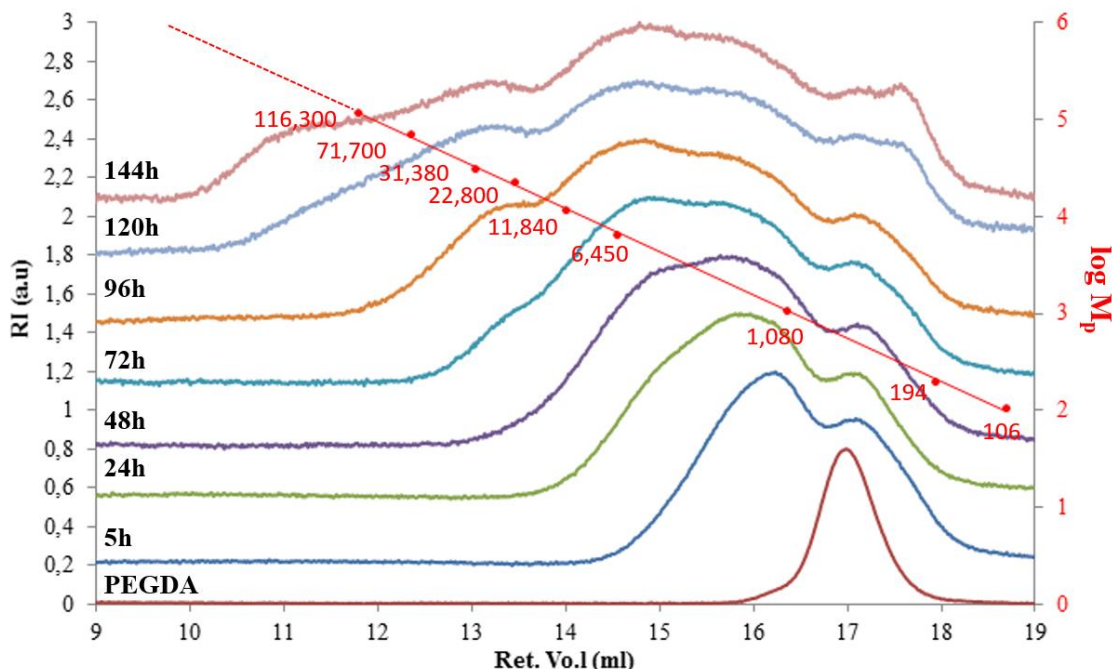

Figure 3.13 Increase of the molecular weight and dispersity during the time of the polyaddition 1.5PEGDA+1MA+1HDA carried out in solution (DMF, 25% w/v) at 60°C.

Quantitative ^{13}C -NMR was used in this case to calculate the acrylate conversion for the PEGDA and MA monomers (Equation 3.2). In this case ^1H -NMR does not provide useful information, as the proton peaks of the MA overlap with those of the PEGDA. The conversion of PEGDA was calculated according to Equation 3.2 using the signal for the carbonyl carbon of the unreacted PEGDA at 165.0 ppm and the carbonyl carbon of the reacted PEGDA at 172.0 ppm in (peaks 13 and 9 in Figure 3.14). The conversion of MA was however, calculated according to the following equation:

$$\% \text{ A conversion (MA)} = X_{172.30} = \frac{I_{172.30}}{I_{172.30} + I_{165.70}} \cdot 100 \quad \text{Equation 3.4}$$

where $I_{165.70}$ is the integral of the carbonyl carbon (peak 22, Figure 3.14) of the unreacted MA and $I_{172.30}$ is the integral of the carbonyl carbon of the reacted MA monomer (peak 18, Figure 3.14). ^1H , ^{13}C -HSQC and ^1H , ^{13}C -HMBC NMR analysis (Figure 3.15) confirms the assignments. It has been noted from Figure 3.15 that the methyl carbon (signal 19) of the methoxy group, moves from 50.78 ppm (free MA) to 50.68 and 50.64 (signal 19') ppm when it end-caps the

polymer. The a, b and c couplings in the figure confirm the assignments of the carbonyl carbon peaks of the unreacted and reacted MA.

Table 3.7 Characterisation data of the crude product taken and analysed at different reaction times from the reactions PEGDA- MA-HDA and PEGDA-HDA at 60°C in DMF (25% w/v) with molar ratio A₂:A:B₄ of 1.5:1:1.

time (h)	M _n ^a	M _w ^a	Đ ^a	%A conversion ^{exp,b}		p _A ^{theo}		DB ^b
				PEGDA (A ₂)	MA (A)	Carothers	F-S	
3	650	1350	2.0	55%	50%			0.18
5	750	1550	2.0	-	-			-
24	900	2300	2.5	60%	60%			0.35
48	1000	3550	3.5	65%	65%	87.5	66.6	0.45
72	1150	5600	5.0	80%	75%			0.55
96	1400	10300	7.5	-	-			-
120	1400	27500	20.0	-	-			-
144	1350	40150	30.0	85%	82%			0.70
120*	1100	28800	26.0	-	-	83.3	66.6	0.60
24	1600	12850	8.0	75%	not used			0.32

^a with M_n and M_w in g/mol and calculated by DMF SEC analysis with PEO as standards; ^b calculated by ¹³C-NMR; * polyaddition PEGDA-MA-HDA at 60°C in DMF (25% w/v) with molar ratio A₂:A:B₄ of 1.5:1:1 repeated for 120h.

For both PEGDA and MA, the values of acrylate conversion, in Table 3.7, increase with reaction time and the relative conversion of each of them occurs at approximately the same rate. This last observation is expected and consistent with the fact that the monomers have the same functional group. Moreover, the effect of the MA on the molecular weight of the resulting polymer can be observed. In fact, a comparison in Table 3.7 of the molecular weight values obtained after 24 hours for the reactions carried with and without mono-functional monomer shows the expected reduction of the molecular weight of the product obtained by using the “A₂ + A + B₄” strategy. The conversion of acrylate (A) groups obtained experimentally in Table 3.7 can be compared with the theoretical values calculated by using Carothers and Flory-Stockmayer’s theories. The experimental value obtained (for conversion of A groups) in absence of MA mono-functional monomer is in between the two theoretical values, and in good agreement with the previous results shown in Table 3.2. However, the addition of MA monomer to the polymerisation mixture changes the situation and although the conversion of A groups after 72h is also in between the two theoretical values, at higher reaction times, when the reaction between polymer chains becomes predominant, and gelation might be expected, the results suggest deviation from the findings in the literature and the previous experimental results. Thus the data for the sample collected after 144h tends towards the theoretical value predicted by Carothers. This high value for conversion for A groups prior to gelation can be reasonably ascribed to the inhibition of crosslinking by the monofunctional monomer, at high extents of the reaction.

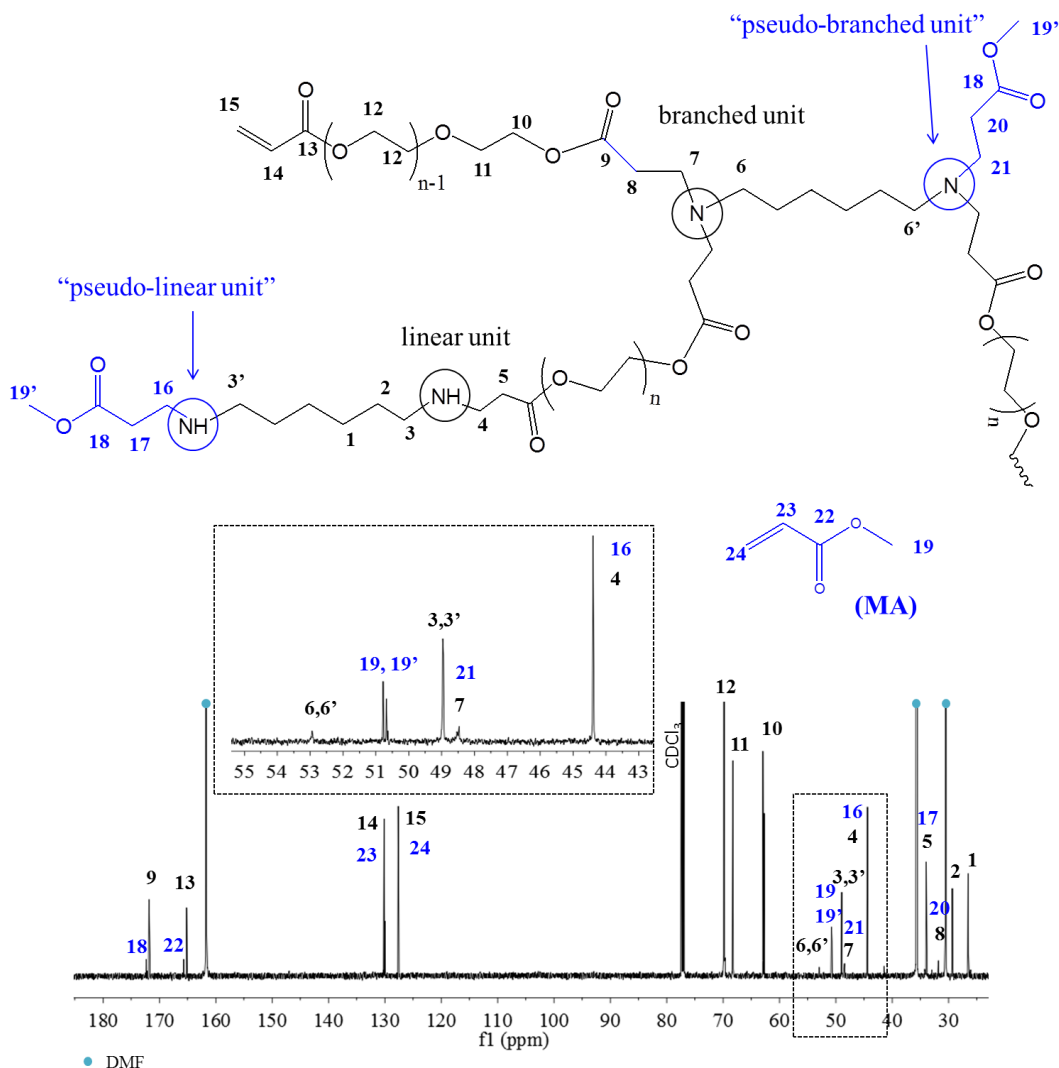

Figure 3.14 ^{13}C -NMR (176MHz, CDCl_3) and structure of the product of the reaction 1.5PEGDA+1MA+1HDA (in DMF 25% w/v, T=60°C). The spectrum was recorder after 3 hours and it is relative to the product analysed without purification.

In Table 3.7 the DB values are also presented. It is worth noting that the use of methyl acrylate (MA) as an end-capping monomer prevents the recognition by NMR of any of the structural units shown in Figure 3.5. In fact, the reaction of methyl acrylate with the amine groups generates exactly the same signals in the ^{13}C -NMR spectrum as the reaction between PEGDA and HDA (Figure 3.10). In section 3.4.1.1, it has been shown that when a tertiary amine (in a branched unit) is formed, signals 6, 7, 8 (Figure 3.6) can be identified whilst when a secondary amine (in a linear unit) is generated, signals 3, 4, 5 (Figure 3.6) are observed. Upon the introduction of MA monomer, the relevant ^{13}C -NMR signals corresponding to the branched unit are indistinguishable from the "pseudo-branched unit" formed by reaction between methyl acrylate and a secondary amine group (signals 6', 20, 21 in Figure 3.10). In the same manner, the linear unit is indistinguishable from the "pseudo-linear unit" (signals 3', 16, 17 in Figure

3.14), which is a terminal end-capped unit from the reaction between methyl acrylate and a primary amine.

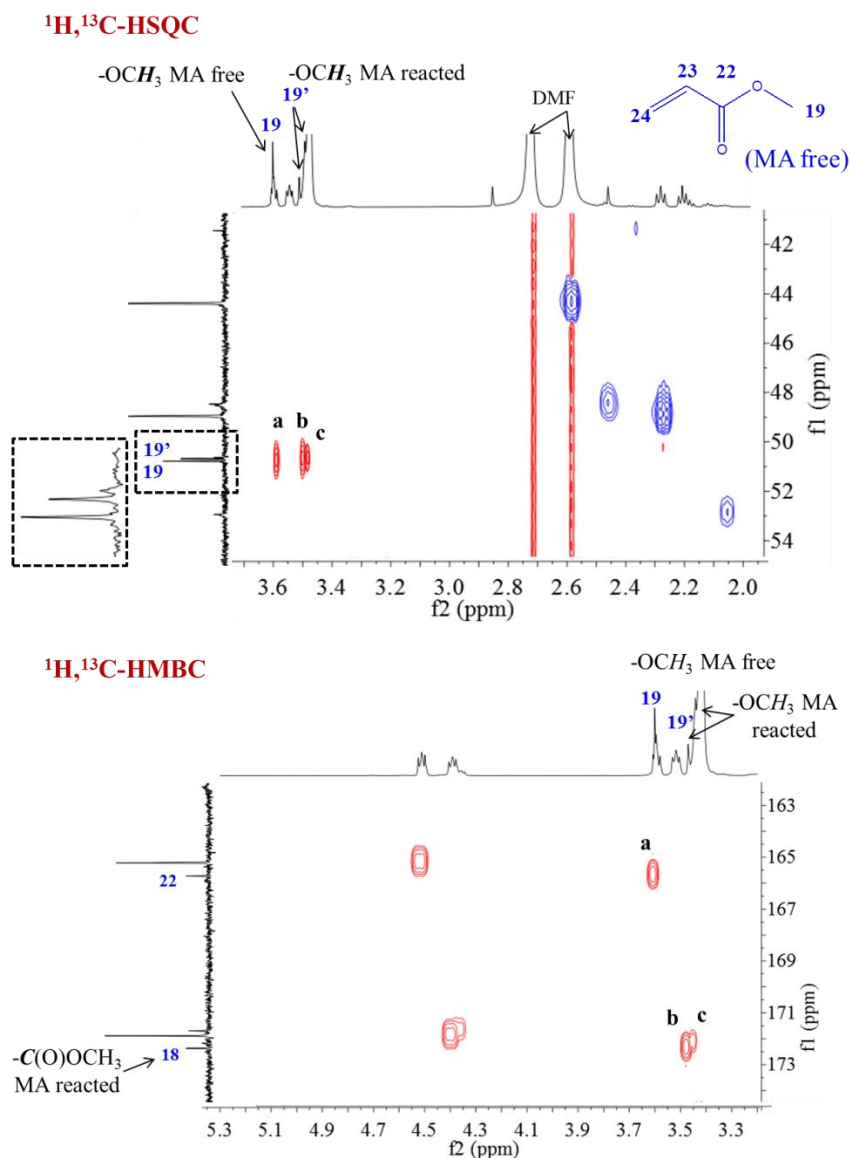

Figure 3.15 Expansion of the $^1\text{H},^{13}\text{C}$ -HSQC and $^1\text{H},^{13}\text{C}$ -HMBC spectra of the crude product after 3 hours of reaction 1.5PEGDA+1MA+1HDA (in DMF 25% w/v, $T=60^\circ\text{C}$) that prove the occurred reaction of the MA monomer.

The DB reported in this context is hence a “pseudo degree of branching” because it is not consistent with the definition of degree of branching⁴². For this reason it will be designated DB’ and calculated as follow:

$$\text{DB}' = \frac{2B'}{2B' + L} \quad \text{Equation 3.5}$$

where B’ and L’ are respectively, the sum of the branched and “pseudo-branched” units and linear and “pseudo-linear” units. Although the DB’ values in Table 3.7 do not give precise information about the actual polymer structure, they do show that the addition of MA at the

early stage of the reaction permits the development of a pseudo-branched architecture (Figure 3.14). Further information regarding the molecular architecture can be obtained from the Mark-Houwink plots in Appendix A, Figure A.8. By comparing the plot obtained for the sample PEA4 (1.5PEGDA+1MA+1HDA) with those of the samples PEA1-1.5 (1.5PEGDA+1HDA, without mono-functional monomer at 25% w/v) and PEA3 (1.5PEGDA+1MMA+1HDA), the effect of the addition of an effective mono-functional monomer can be observed. In fact, the higher intrinsic viscosity observed at intermediate and high molecular weight only for the sample PEA4 is due to the formation of a less dense structure compared to the polymers PEA1-1.5 and PEA3 prone instead to gelation. This result suggest that the addition of methyl acrylate (PEA4) is successful in suppressing gelation and allowing the polymerisation to proceed to higher conversion (MW) but the resulting structure is less highly branched.

The results in this section have shown that the addition of the mono-functional monomer can lead to a significant improvement of the polymerisation reaction – namely, where gelation had occurred after 35 hours for an analogous reaction (PEGDA and HDA in DMF at 25% w/v) without mono-functional monomer, gelation did not occur even after 144h in the presence of MA, and a pseudo-branched polymer was formed. The reaction was repeated to test the reproducibility in terms of the molecular weight of the final product. Table 3.7 shows that after 120 hours a polymer was formed with a satisfactory reproducibility. However, at such time a significant increase of the viscosity of the mixture was observed and at longer reaction times, gelation did occur in agreement with the theoretical predictions. Hence from these results it can be concluded that whilst the presence of a mono-functional monomer as a starting material is able to significantly inhibit the onset of gelation, with the molar ratios used here, gelation cannot be avoided indefinitely.

The formation of high molecular weight species and hence cross-linking, probably occurs because the molar ratio $A_2:A:B_4$ chosen (1.5:1:1) still permits the formation of a network during the polyaddition between the A_2 and B_4 monomers. A different ratio $A_2:A:B_4$ should be selected to allow the synthesis of a fully soluble branched and end-capped polymer. We believe that the strategy discussed in this section could be an effective way to overcome gelation and at the same time functionalise the polymer. Further studies exploring the same strategy were carried out for the synthesis of hyperbranched poly(amido amine)s (Chapter 5) where the impact of the molar ratio of the A monomer on the molecular weight of the polymer is discussed and in particular, the study demonstrates that gelation can be successfully avoided when at least 1.2 mole equivalents of A-monomer is used in agreement with the Carother's theory.

The reaction described above was also carried out in bulk. In Figure 3.16, the evolution of molecular weight with time is compared for the reaction in bulk and in solution. The results show that the reaction in bulk proceeded far more rapidly and gelation was reached after 10 hours. In fact, after only 8 hours, the product had a molecular weight distribution of M_n 950 g/mol; M_w 17500 g/mol and \bar{D} 18.5 whereby similar values might be achieved for the reaction in solution after c.a. 110 hours.

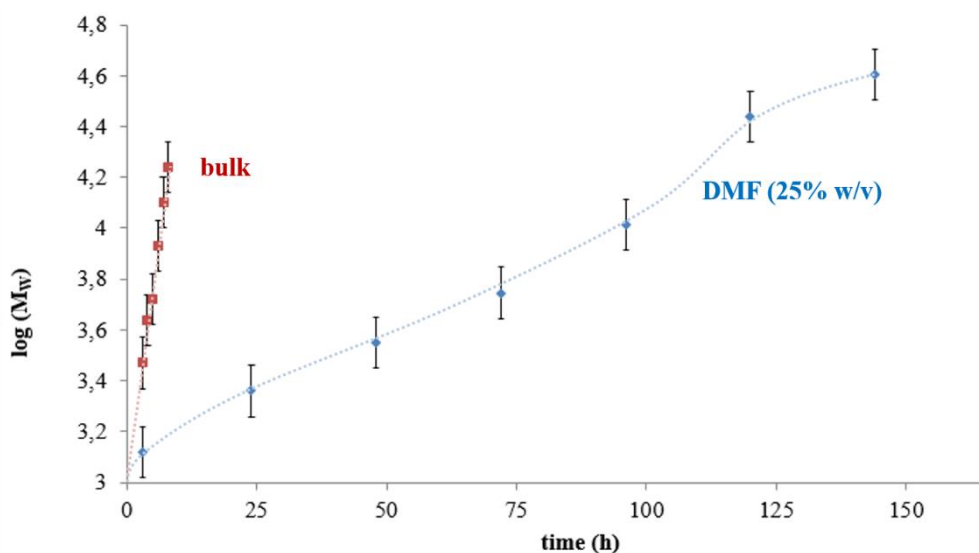

Figure 3.16 Comparison of the increase of the weight-average molecular weight (M_w) for the reaction 1.5PEGDA+1HDA+1MA when carried out in bulk (red line) and in solution (DMF, 25% w/v) (blue line).

3.4.3 Hyperbranched PEAs: stability.

Hyperbranched poly(ester amine)s are generally used in applications in which degradability is required, for example gene delivery^{6,11,12,31}. Ester groups are inherently susceptible to hydrolysis reactions and where polymers contain ester functionalities in the polymer backbone, ester hydrolysis can result in degradation. Although one of the aims of this work was the development of a strategy to synthesis a gel-free, soluble hyperbranched polymer, the long-term stability of this type of polymer is also an issue that must be considered. The stability of the synthesised PEA polymers was therefore studied.

3.4.3.1 Stability in methanol – hyperbranched and linear PEAs.

The polymerisation reaction carried out in bulk using PEGDA, MA and HDA with a molar ratio $A_2:A:B_4$ of 1.5:1:1 led to the formation of a cross-linked product after 10 hours (section 3.4.2.2.2). The SEC chromatogram of the polymer obtained before gelation (after 5 hours) is shown in Figure 3.17 (left side, black line). It was observed that the cross-linked (insoluble) polymer recovered at the end of the polymerisation appeared to change from an insoluble gel to

a soluble polymer, when stored in methanol and water for less than 24 hours at room temperature (c.a. 5% w/v). Thus, in order to investigate this phenomenon, the methanol (or water) was removed under reduced pressure and the residue dried in a vacuum oven. A distinct change in the physical state of the polymer was observed - from an insoluble cross-linked gel into an apparently soluble viscous liquid. SEC analysis was carried out on the (now soluble) product (Figure 3.17) and a significant reduction in molecular weight was observed in comparison to the final sample of the reaction analysed before gelation. The molecular weight decreased from M_n 950 g/mol; M_w 17500 g/mol; \bar{D} 18.5 for the sample collected after 5 hours (reaction in bulk 1.5PEGDA-1HDA-1MA) to M_n 400g/mol; M_w 650 g/mol; \bar{D} 1.5 for the polymer stored for 24 hours in methanol and M_n 380 g/mol; M_w 450 g/mol; \bar{D} 1.2 for polymer stored 24 hours in water.

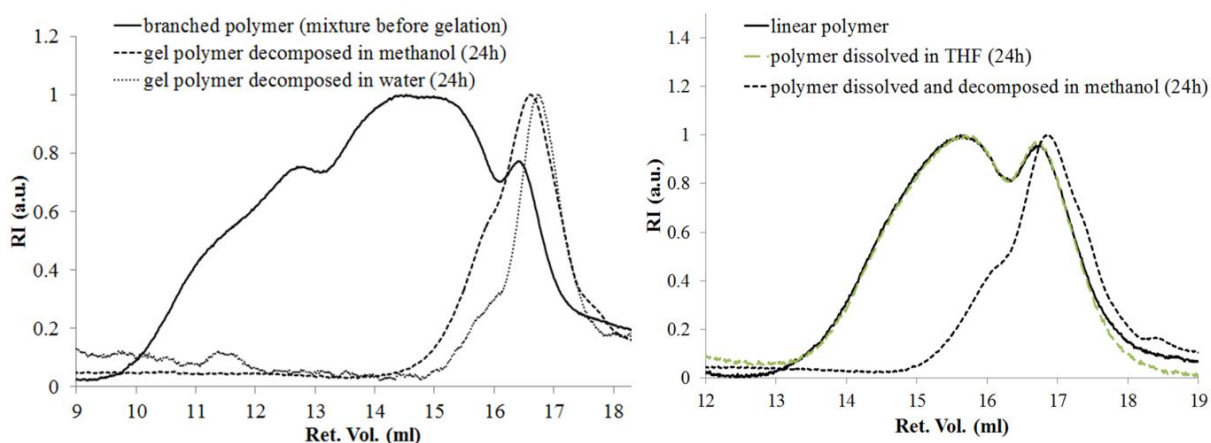

Figure 3.17 SEC chromatograms (RI detector) of a branched (left side) and linear poly(ester amine) (right side) before and after storage.

The dramatic reduction in molar mass strongly suggests that the polymers underwent decomposition upon storage in methanol and water and the precise mechanism of decomposition was subsequently investigated. In order to test this hypothesis, a linear polymer which was not susceptible to gelation was used. In this way, a study of the degradation mechanism can be carried out by analysing the sample before and after the storage in methanol. For this purpose a fully soluble PEA2-0.8 polymer (not cross-linked) was synthesised in bulk at 60 °C from PEGDA and EDA monomers by using a molar ratio $A_2:B_4$ of 0.8:1. This study can be equally carried out by using the slightly branched PEA1-type polymer (e.g. PEA1-0.8 from the polyaddition PEGDA-HDA) as the occurrence of decomposition should be

independent from the length of the aliphatic spacer of the diamine monomer.

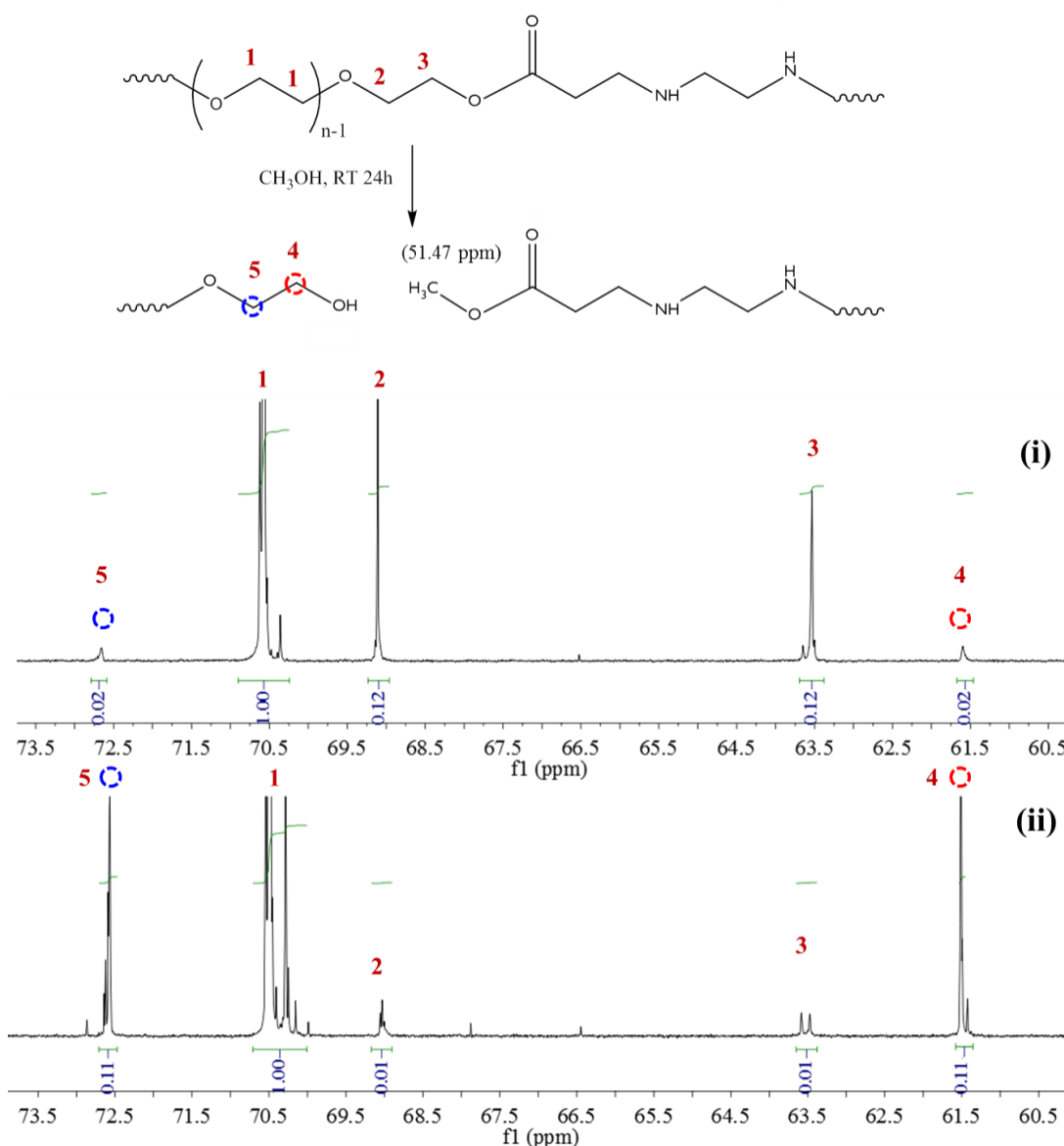

Figure 3.18 ^{13}C -NMR (176MHz, CDCl_3) of the lightly linear polymer obtained from the polymerisation PEGDA-EDA before (i) and after (ii) decomposition.

The polyaddition of PEGDA-EDA after 24 hours at 60°C resulted in the full conversion of the acrylate groups (PEGDA), the formation of a slightly branched structure ($\text{DB} = 0.10$) and resulted in a polymer with a modest molecular weight: M_n 700 g/mol; M_w 2500 g/mol; \bar{D} 3.0 (Figure 3.17, right side, black line). As expected polymer PEA2-0.8 was soluble in polar solvents (protic and aprotic) and was dissolved in methanol (5% w/v) and stirred for 24 hours at room temperature. For comparison, the stability of the polymer in anhydrous THF (5% w/v) was also investigated. The SEC traces in Figure 3.17 (right side) of the samples recovered from the solution in dry THF and methanol are represented with a green and black dotted line

respectively. The chromatograms show (i) a dramatic reduction in molecular weight (M_n : 330 g/mol; M_w : 580 g/mol; \bar{D} : 1.5) for the sample dissolved in methanol and (ii) unchanged molecular weight for the sample dissolved in dry THF, confirming the stability of the polymer in aprotic solvents. The result obtained for this polymer in methanol reproduces that obtained for the branched polymer.

The polymer PEA2-0.8 which had been dissolved in methanol was also analysed by ^{13}C -NMR (Figure 3.18 (ii)) in an attempt to verify the mechanism of degradation. The spectrum obtained is compared in Figure 3.18 with that of the (undegraded) sample analysed after polymerisation (Figure 3.18 (i)). The ^{13}C -NMR spectra show that methylene carbon 3 and 2 at 63.53 and 69.12 ppm respectively, in the α - and β -position with respect to the ester group are reduced in their relative intensity by c.a. 90%. In addition, ^{13}C -NMR shows a proportional increase of the relative intensity of the peaks 4 and 5 at 61.50 and 72.56 ppm respectively which can be reasonably assigned to the methylene carbon in α - and β -position to an alcoholic functionality. The same peaks are present as an impurity in the undecomposed sample (Figure 3.18 (i)) since it has been found that PEGDA (as purchased) contains such functionalities belonging to PEG (2.2% w/w) and PEGMA (11.8% w/w)⁴⁹. This observation supports the assignment of the peaks of the alcoholic species observed upon the decomposition of the polymer in methanol.

As mentioned in the introduction of this chapter, poly(ester amine)s undergo hydrolysis in water; such side reactions are usually slow and often catalysed under acidic and basic conditions. Similar considerations are valid for the transesterification reaction⁵⁰. The amine groups present with the structure of the poly(ester amine), being basic, are capable of catalysing the degradation⁹ of the polymer. To test this hypothesis, the stability of PEGDA in methanol was also investigated. PEGDA was dissolved and stirred for 1 month in methanol at room temperature, the solution was then dried under reduced pressure and the residual product analysed by ^{13}C -NMR spectroscopy and SEC analysis (Figure 3.19). PEGDA did not show any evidence of decomposition. In particular, the ^{13}C -NMR spectra show that the PEGDA does not undergo any decomposition when stirred for 1 month in methanol. In fact, the relative intensity of the NMR peaks of PEGDA remains completely unchanged. SEC analysis (in both THF and DMF) further reinforces the suggestion that PEGDA is stable in the absence of base. The superimposition of chromatograms of the monomer PEGDA and that of the PEGDA after 1 month in methanol are shown in Figure 3.19. The SEC analysis carried out using DMF as the eluent reveals a slight broadening at higher retention volume (low MW) for the sample dissolved in methanol for one month. This result may suggest the onset of the decomposition

of the PEGDA. However, it is worth noting that the DMF SEC operates at 70 °C and DMF can itself degrade in time to produce amines (amongst other things) that could catalyse the decomposition of the PEGDA during the SEC elution time if any trace of residual methanol is present⁵¹. For this reason SEC analysis was also carried out in THF as eluent. The THF SEC chromatograms of PEGDA and PEGDA after 1 month in methanol are also shown for a direct comparison (Figure 3.19) and are identical in this case, no evidence of decomposition was observed.

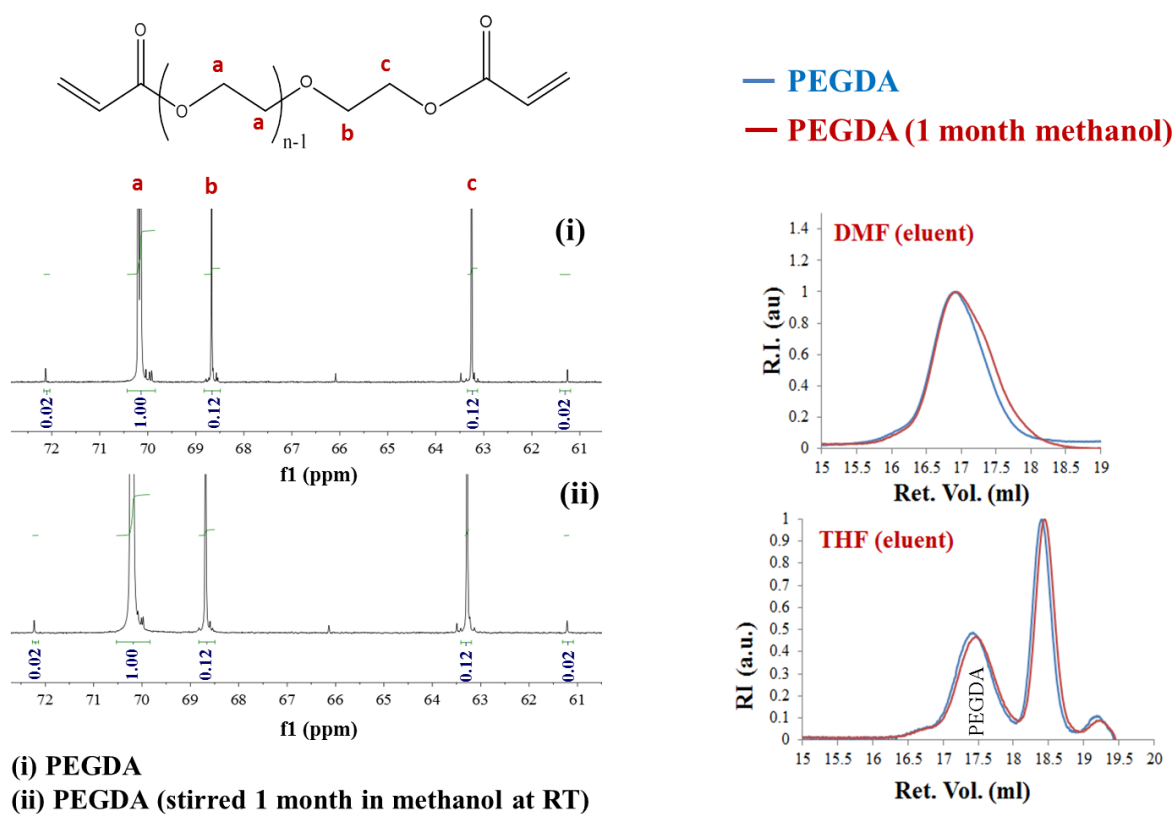
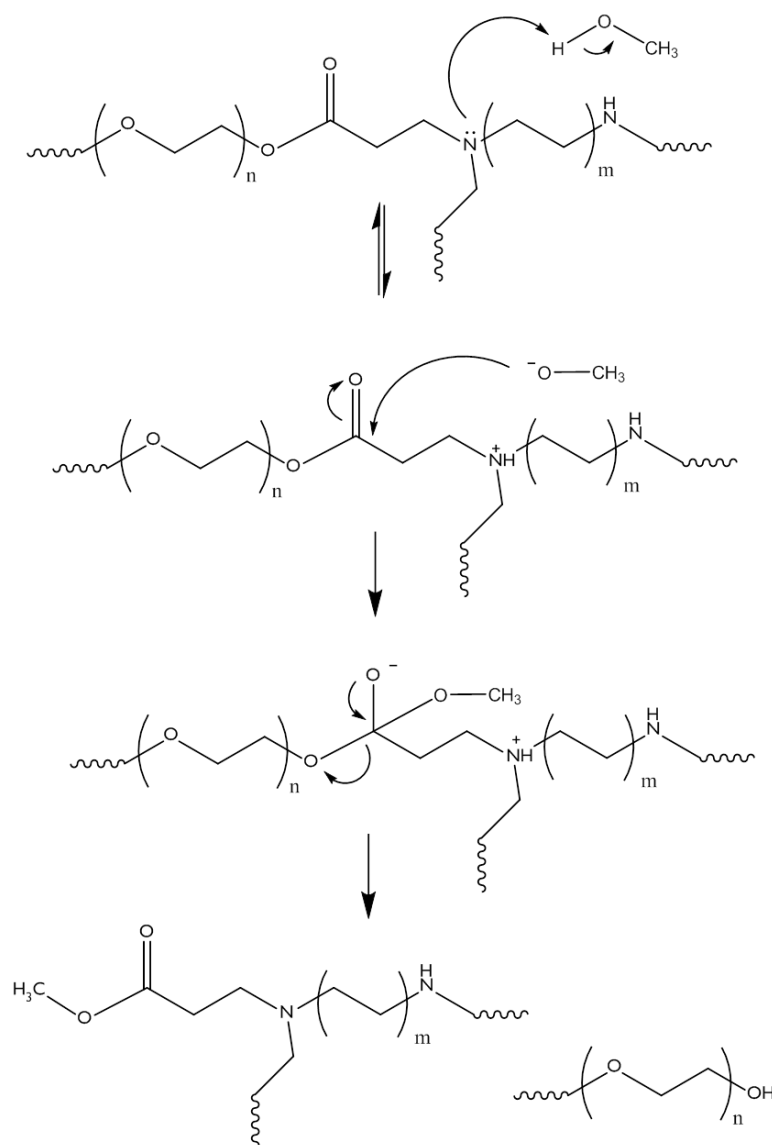

Figure 3.19 Left side: ^{13}C -NMR (176MHz, CDCl_3) of (i) PEGDA and (ii) PEGDA after 1 month in methanol. Right side: DMF SEC (on the top) and THF SEC (on the bottom) (RI detector) of PEGDA (blue traces) and PEGDA after 1 month in methanol (red traces). Both ^{13}C -NMR and SEC analysis prove the stability of PEGDA in methanol.

The results described above suggest that methanol is able to act as nucleophile and attack the carbonyl carbon of the ester group with the reaction being catalysed by the amine groups which can deprotonate the alcohol (Scheme 3.8). Transesterification in/with methanol is proposed as the mechanism of polymer decomposition. In order to enhance the stability of PEAs, a strategy is proposed and discussed in the next section to avoid/delay decomposition in methanol or water.



Scheme 3.8 Possible mechanism of base (amine) catalysed transesterification of hyperbranched poly(ester amine) in methanol at room temperature.

3.4.3.2 Synthesis and stability of hydrochloride poly(ester amine)s – PEA5.

In previous sections it has been shown that the hyperbranched poly(ester amine) (PEA) undergoes transesterification and hence degradation in methanol, catalysed by the amine groups present with the structure. In this section a strategy is proposed to enhance the stability of PEA. The strategy is based on the synthesis of PEAs bearing the amine groups present as the hydrochloride salt. In this form, the amine groups are no longer able to act as a base and deprotonate methanol, which in turn acts as nucleophile in the transesterification reaction. Therefore, decomposition should be avoided and the stability of PEAs increased. Feast *et al.* previously reported the synthesis of hyperbranched poly(amido amine) polymers by addition polymerisation in the melt using a series of AB₂-type monomers³⁶. The AB₂ monomers used were aminoacrylate hydrochloride where A is an acrylate and B₂ the hydrochloride salt of a

primary aliphatic amine (Figure 3.2). This work showed that by heating the pure hydrochloride salt, N-acryloyl-1,6-diaminohexane hydrochloride (m.p. 165°C) above its melting point (190-230 °C), polymerisation via Michael addition occurred. Below the melting point there was no evidence of polymerization. The mechanism proposed for this reaction is shown in Figure 3.2. A low concentration of free amine groups has to be instantaneously present for the nucleophilic attack on the acrylate group because the ammonium ion cannot act as a nucleophile. The interaction between the positively charged nitrogen ($-\text{CH}_2\text{NH}_3^+ \text{Cl}^-$) and the amide oxygen is allowed by the conformation of the AB_2 monomer; thus, when the proton is nearer the carbonyl oxygen the amine is a powerful nucleophile and can participate in Michael addition with an acryloyl unit.

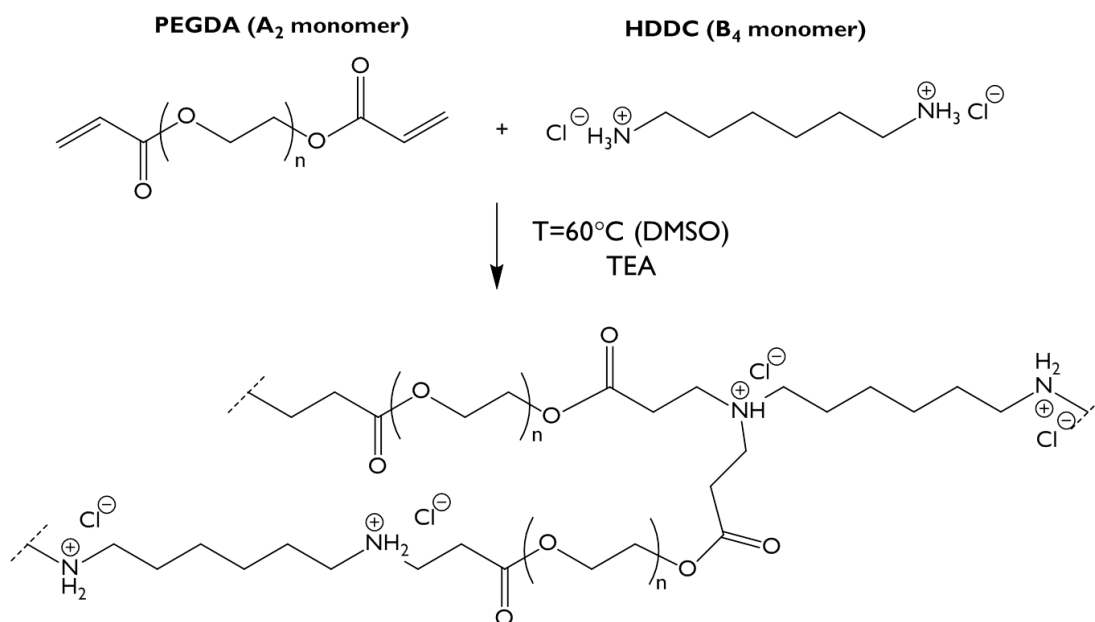

Scheme 3.9 Schematic representation and reaction conditions of the synthesis of hydrochloride hyperbranched poly(ester amine)s, PEA5, by double monomer methodology from PEGDA and HDDC as A_2 and B_4 monomers.

Inspired by the results of this work, the Michael addition of PEGDA (A_2 monomer) and hexamethylenediamine dihydrochloride, HDDC (B_4 monomer) was attempted (Scheme 3.9). This polymerisation sees the use of the same functional groups used by Feast³⁶ but exploits the double monomer methodology instead of single monomer methodology (SMM) and for this reason the reaction conditions have to be investigated. This new class of polymer is identified as PEA5.

3.4.3.2.1 Synthesis of PEA5

The molar ratio A₂:B₄ of 0.8:1 (PEA5-0.8) was initially used because the large excess of N-H groups permits the total consumption of the acrylate groups (limiting group) without the risk of gelation. In this way, the success of the reaction can be easily established through the disappearance of the vinyl proton signals in the ¹H-NMR spectra. Although the molar ratio selected does not promote the development of a branched architecture, this study was focussed on finding conditions which allow successful reaction with the hydrochloride salt of the amine monomer.

The reaction between PEGDA and HDDC was first carried out in bulk at various different temperatures. No reaction was observed when the temperature was below 100 °C and a solid and insoluble product was formed at temperatures higher than 100 °C. This result suggests that the polymerisation in melt described in the work of Feast⁵² is not a suitable strategy for our system (m.p. HDDC 256-257 °C). The same reaction was subsequently attempted in DMSO solution at a monomer concentration of 18% w/v in presence of trimethylamine (TEA). DMSO was chosen as solvent because in the current work, it was observed that the reaction with a molar ratio PEGDA:HDDC of 0.8:1 led in DMSO to 15% conversion of the acrylate groups after 24h at 60 °C and 50% after 24h at 100°C. Although the reaction does not reach the expected full conversion of acrylate groups, the results found suggest that DMSO is able to promote itself the reaction between HDDC and PEGDA. In order to improve the acrylate conversion, triethylamine (TEA) was added to the system PEGDA-HDCC in DMSO to act as activator for the B₄ monomer. TEA is a proton sponge that “activates” the HDDC monomer by promoting the reversible formation of the free amine (Scheme 3.10). The use of TEA as an activator towards an ammonium group has already been reported for the synthesis of uncharged linear poly(amido amine)s from amino acids with diacrylamides⁵³. In Scheme 3.10 a plausible hypothesis is shown for the synthetic route and the likely equilibria which exist in solution. TEA triggers first the Michael addition reaction (Equilibrium 1) and then its basicity permits the equilibrium between the protonated and unprotonated form of the polymer (Equilibrium 2). The reaction in Scheme 3.9 was initially carried out using catalytic amounts of TEA (0.01% w/w) but further aliquots of TEA were added to the reaction mixture and the amount of TEA used was gradually increased to 1% w/w with respect to the total weight of the A₂ and B₄ monomers; the temperature used for the reaction was 60°C. Figure 3.20 shows the progress of the reaction in terms of acrylate conversion as a function of time and the amount of TEA used.

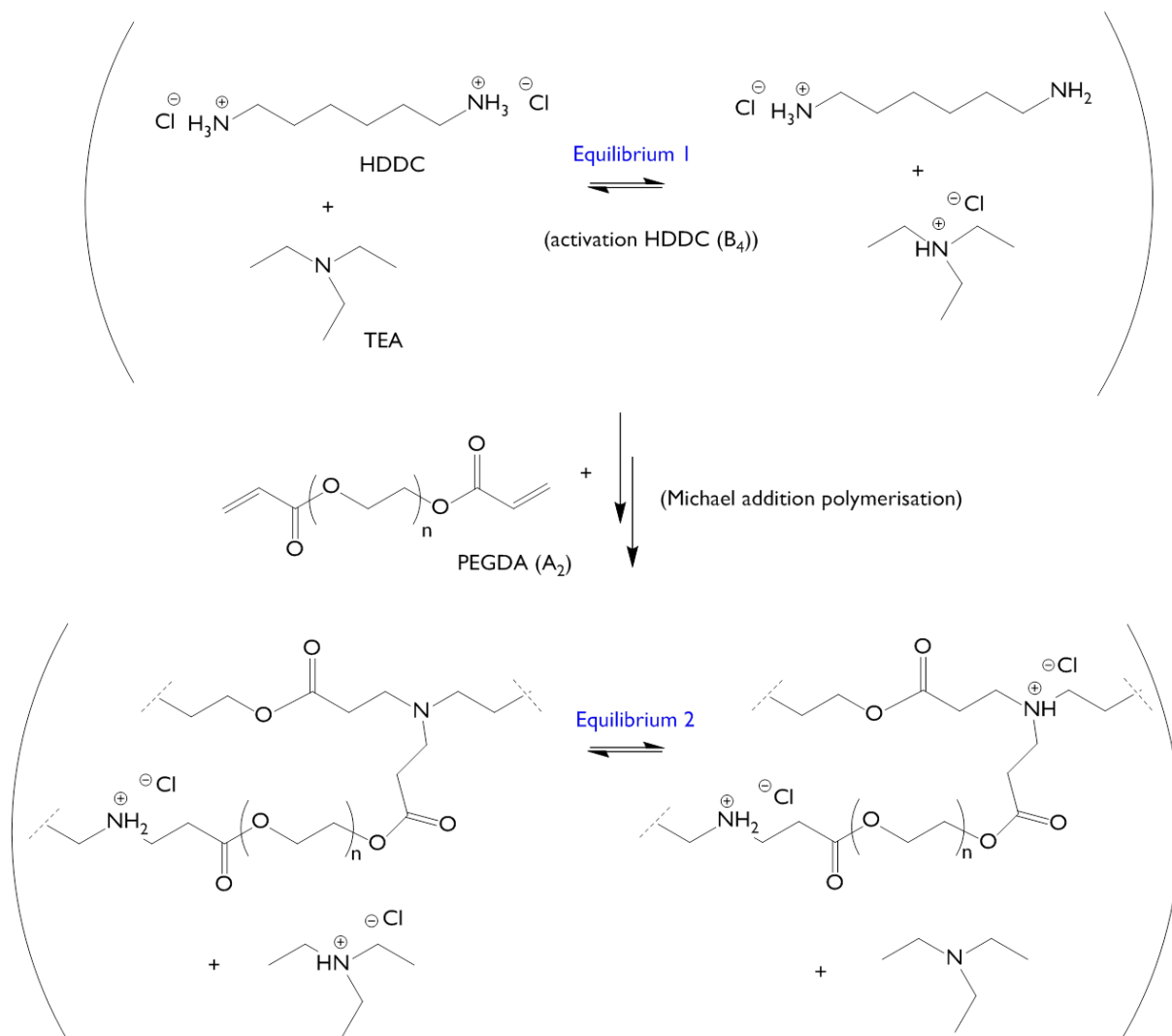

Scheme 3.10 Equilibrium reactions likely involved in the polymerisation $\text{A}_2 + \text{B}_4 \cdot 2\text{HCl}$.

In the Figure 3.20 it is possible to observe that the impact of TEA on the polymerization was negligible when the amount of TEA used with respect to the total amount of monomers was less than 0.1% w/w (orange dot in Figure 3.20). In fact the conversion of acrylate groups, when 0.01 and 0.03% of TEA was used, was lower than 20% as for the reaction between PEGDA and HDDC in DMSO at 60°C without TEA (yellow dot). However, TEA starts to have a noticeable (but modest) impact on the reaction when present at levels higher than 0.1% w/w. In particular, 50% conversion of acrylate groups was achieved with 1% w/w of TEA. However, a similar result was found in DMSO without TEA when a temperature of 100 °C was used. It is worth emphasizing that the amount of TEA was increased by adding additional TEA to a single polymerisation reaction during the progression of the reaction and of course the value of the conversion of acrylate groups obtained will also be affected by the time of the reaction. However, from Figure 3.20 it can be observed that during the periods of time in which the

amount of TEA is kept constant (i.e. purple dots 0,01% TEA, green dots 0.03 % TEA and black dots 1%TEA) there is not a significant increase in acrylate conversion, thus the effect of time on conversion can be considered to be negligible with respect to the effect of the amount of TEA used.

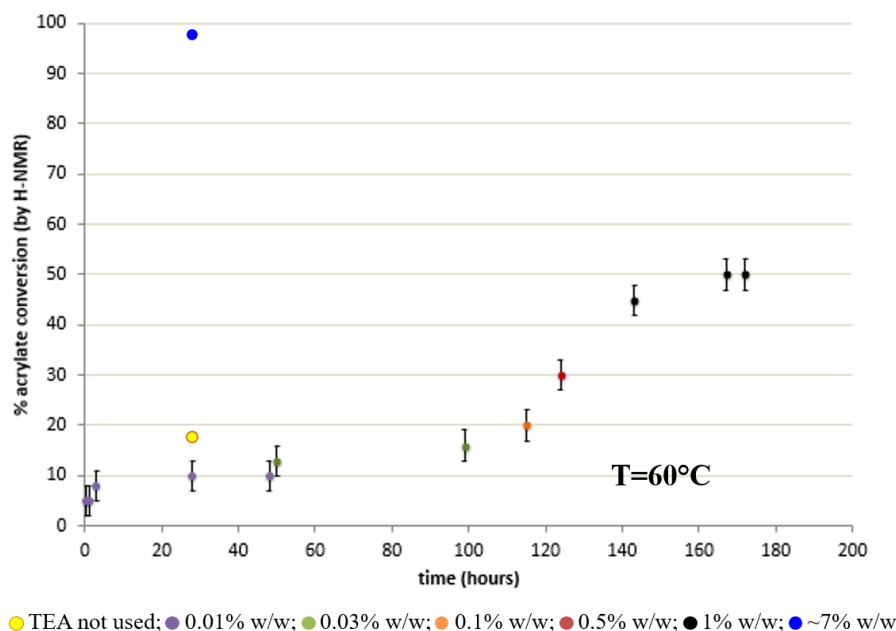

Figure 3.20 Acrylate conversion (%) resulting from the polyaddition of A₂-B₄·2HCl with varying amount of TEA.

Despite the improvement of the reaction using 1% TEA, PEGDA does not take part in the reaction to the extent which one would expect for the reaction with a molar ratio PEGDA: HDDC 0.8:1 (PEA5-0.8) in which 100% conversion of acrylate groups is achieved (PEGDA fully reacted). This objective can be obtained however, by increasing the amount of TEA to c.a. 7% w/w that corresponds to a molar ratio of HDDC:TEA of 1:0.5 (Scheme 3.10). Under these conditions almost total conversion of acrylate groups (95 %) was achieved after 24 hours, blue dot in Figure 3.20. The resulting polymer PEA5-0.8 was recovered by precipitation in THF (yield 80% w/w) and was soluble in water, DMSO, DMF and methanol. The stability of this polymer and the retention of the HCl within the structure are discussed in section 3.4.3.2.2.

Once suitable conditions to synthesise PEA5 had been found, the molar ratio PEGDA-HDDC was increased from 0.8:1 to 1.5:1 since it has been observed that such a ratio (A₂:B₄ 1.5:1) can form more highly branched polymers. Thus, the Michael addition was carried out in DMSO at 60°C with a molar ratio PEGDA:HDDC:TEA of 1.5:1:0.5.

Table 3.8 Acrylate (A) conversion and DB of the crude product of the reaction PEGDA + HDDC + TEA (mole ratio 1.5:1.0:0.5) in DMSO at 60°C.

time (h)	% A conversion	DB
24	45	0.15
48	55	-
144	65	0.30

The progress of the reaction was monitored by the % conversion of acrylate groups (A groups) and the results in Table 3.8 show that, although the reaction proceeded slowly, the reaction is able to occur without risk of gelation to produce a 65% conversion of A groups and a branched architecture (DB 0.30) after 144 hours. The DB was in this case calculated by using the methylene carbon in the alpha position to the nitrogen atom (Method 1 in the section 3.4.1.1); the structural units were identified using $^1\text{H},^{13}\text{C}$ -HSQC and $^1\text{H},^{13}\text{C}$ -HMBC. The PEGDA conversion was calculated according to Equation 3.1. The resulting polymer was precipitated in THF in c.a. 40% yield. The low yield suggests that the polyaddition of PEGDA-HDDC was less efficient than analogous reactions carried out with HDA or EDA as B_4 monomer and for this reason it can be assumed that only a polymer with low molecular weight was formed when using HDDC and it is possible that recovery by precipitation was not terribly efficient. However, from the reaction PEA5-1.5 an important observation arises; the analogous reaction with free diamine (PEA1) leads to the formation of a cross-linked product after 96 hours of polymerisation. However, the use of a dihydrochloride diamine B_4 monomer results instead in the synthesis of soluble branched polymer without the formation of a gel. The product recovered by precipitation was fully soluble in water, DMSO, DMF and methanol. The pH of a 5% w/v solution in water of the synthesised polymer was measured and a neutral pH was observed. This result suggests the protonation of the amine groups and therefore the retention of the hydrogen chloride within the structure of this polymer can be assumed. In contrast polymer PEA2, containing no cationic groups – only free amine groups – has a pH of around c.a. 9 under the same conditions.

In summary, the results reported in this section support the validity of the proposed strategy for the synthesis of hydrochloride PEA5. The stability of such a class of polymers is discussed in the next section. Moreover, from the synthesis of PEA5, it was observed that the use of the hydrochloride salt of the diamine represents an effective way to overcome the problem of gelation, which is typical of polymerisations carried out with an “ $\text{A}_2 + \text{B}_4$ ” system and offers at the same time, an alternative synthetic route for cationic hyperbranched polymers by the double monomer methodology (DMM). This strategy will be further explored in Chapter 5 for the synthesis hyperbranched poly(amido amine)s.

3.4.3.2 Stability in methanol of the PEA5.

The stability of the hyperbranched poly(ester amine) in its hydrochloride form was studied. The hydrochloride amine groups should limit the amine-catalysed decomposition of the polymer observed in the section 3.4.3.1 and consequently increase their stability. This enhanced stability may open up the possibility of new applications in situations where degradation has to be delayed or is not a requirement.

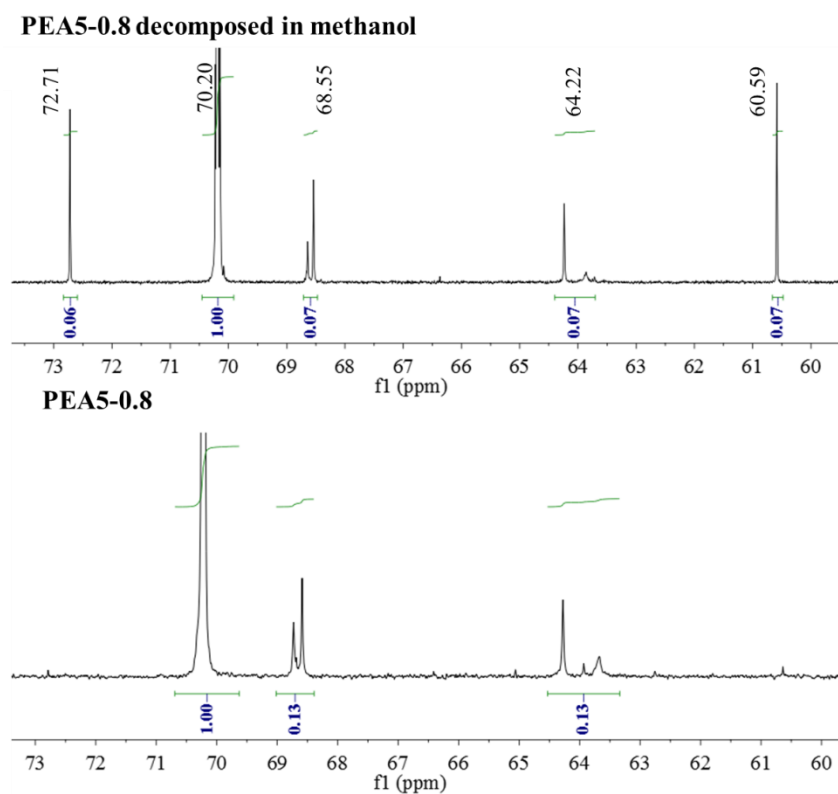

Figure 3.21 ^{13}C -NMR of the cationic linear poly(ester amine) obtained from the reaction 0.8PEGDA+1HDDC (on the bottom) and the same polymer after 24 hours in methanol.

For this study PEA5-0.8, obtained from the synthesis in DMSO at 60 °C with the addition of TEA was used. The recovered polymer showed a good solubility in H₂O, DMSO, DMF and CH₃OH. Thus, for a direct comparison with the stability of the unprotonated linear analogue, the stability of the poly(ester amine) hydrochloride was studied in methanol. PEA5-0.8 was dissolved in methanol (5% w/v) and stirred at room temperature for 24 hours. In Figure 3.21 the ^{13}C -NMR spectra of the linear cationic polymer before and after dissolving in methanol are shown. ^{13}C -NMR of the polymer sample which had been stirred in methanol showed evidence of polymer degradation. In fact, from Figure 3.21 (spectrum on the top) it is possible to observe the signals of the carbon methylene at 60.59 and 72.71 that, according to the previous discussion, has been assignment to the alpha and beta position with respect to a hydroxyl group

respectively. This result suggests that transesterification can still occur in methanol when the polymer is present as the hydrochloride salt of the amine. However, the extent of degradation expressed as a percentage of cleaved ester groups was estimated to be less than 50% after 24 hours whereas the NMR analysis of the analogous linear PEGDA-EDA copolymer (Figure 3.18) indicated that almost all the ester groups of the PEGDA-EDA polymer had been cleaved after 24 h in methanol. Therefore, although the decomposition is not completely inhibited by forming the amine salt, a significant reduction of the rate of decomposition was observed. Moreover, elemental analysis was carried out on the polymer as made and as recovered after precipitation to calculate the N:Cl ratio. This ratio should indicate whether the hydrogen chloride is retained within the structure after precipitation. The theoretical atom percentage calculated for the linear structure ($C_{30}H_{58}N_2O_{13} \cdot 2HCl$) and the experimental results are given in Table 3.9. The results showed that the ratio N:Cl is lower than the theoretical ratio with 23% less chlorine than anticipated.

Table 3.9 Elemental analysis of the polymer PEA5-0.8 obtained from the reaction 0.8PEGDA+1HDDC.

Atom%	C%	H%	N%	Cl%
Theoretical	49.52	8.31	3.83	9.74
Experimental	49.05	7.98	3.91	7.68

This result goes some way towards explaining the partial decomposition of the cationic polymer in methanol because the hydrogen chloride is only partially retained within the structure. The lower N:Cl ratio is most likely due to the existence of unprotonated polymer fractions (Equilibrium 2 in Scheme 3.10).

Precipitation in acidic (HCl) and dry conditions can be considered in future studies to recover the fully protonated product and hence a more stable polymer in protic solvents.

The enhanced stability of linear hydrochloride poly(ester amino) in methanol has been demonstrated and the potential of the method proved. The results presented here should encourage further investigations for the synthesis of cationic and more stable hyperbranched poly(ester amino) by an “ $A_2 + B_4$ ” strategy without risk of gelation.

3.5 Conclusions

The synthesis of hyperbranched poly(ester amine) by the double monomer methodology (DMM) using multifunctional monomers PEGDA (A_2) and HDA or EDA (B_4) was described. Three different strategies have been investigated: (i) “ $A_2 + B_4$ ”; (ii) “ $A_2 + A + B_4$ ”; (iii) “ $A_2 + B_4 \cdot 2HCl$ ” strategies.

It has previously been reported that soluble hyperbranched polymers with a DB between 0.47 and 0.36 have been synthesised by increasing the molar ratio $A_2:B_4$ from 0.8:1 to 1.2:1 respectively and end-capping the polymer post polymerisation but before the precipitation¹.

$A_2 + B_4$ strategy

The synthesis of hyperbranched poly(ester amine) was explored. The monomer molar ratio was varied to understand the impact upon the resulting polymer molecular weight and structure. Moreover, the effect of the temperature, solution concentration and structure of B_4 monomer was further studied.

In contrast to the trends reported in the literature¹, at a molar ratio $A_2:B_4$ of 0.8:1 it was only possible to synthesis lightly branched polymers (PEA1-0.8) while hyperbranched polymers could be synthesised in solution when the molar ratio $A_2:B_4$ was higher than 1:1 ($A:B (>2):4$) such as 1.5:1, 2:1 and 3:1 (PEA1-1.5, PEA1-2 and PEA1-3). An increase of the DB with the increase in the mole fraction of A functional groups was observed. However, the polymerisation reactions for PEA1-1.5, PEA1-2 and PEA1-3 all resulted in gelation at different reaction times and it was not possible to recover a fully soluble branched product from the polymerisation reaction. The $A_2 + B_4$ system was further investigated by changing the reaction temperature, the concentration of the monomers in solution and by carrying out the reaction in bulk conditions. All of these parameters were shown to play a major role on the rate of the reaction and consequently on the resulting polymer structure. Bulk conditions, although attractive for industrial-scale production, led to very rapid reactions and the early formation of a sol-gel system. The problem of gelation during the polymerisation in solution (DMF, 18% w/v at 60°C, $A_2:B_4$ of 1.5:1) was however delayed by replacing HDA (B_4 monomer) with EDA, a diamine with a shorter aliphatic spacer. The cause of this behaviour was not investigated but it can be supposed that the decreased flexibility of a shorter aliphatic spacer was able to reduce the rate of the polymerisation and inhibit gelation during the reaction. Although gelation did not occur in solution, it did occur upon storage of the recovered polymer.

The results discussed in this work show that $A_2 + B_4$ is an effective and efficient system for the production of hyperbranched polymers but strategies need to be developed to prevent the formation of a cross-linked product.

$A_2 + A + B_4$ strategy

Hyperbranched polymers were successfully synthesised by using a molar ratio $A_2:B_4$ of 1.5:1 but the full conversion of the limiting functional groups of the A_2 monomer eventually leads to the formation of a network structure. In light of this result, the introduction of a mono-functional

monomer as starting material was explored as a strategy to inhibit the formation of cross-linked species. The end-capping of a portion of the N-H groups of the B₄ monomer reduces the number of sites available for the formation of branch points and cross-linked species. The strategy was studied by using a molar ratio A₂:A:B₄ of 1.5:1:1 with the aim to synthesise a gel-free branched polymer in a one-pot reaction. Two mono-functional monomers were selected, namely methyl acrylate (MA) (A-monomer) and methyl methacrylate (MMA) (A'-monomer), but only when MA was used, was the reaction successful because the reactivity of its functional group is comparable to that of the acrylate groups of the PEGDA monomer. MMA was shown not to take part in the reaction because of the reduced reactivity of the vinyl groups by means of the inductive effect of the methyl groups alpha to the ester groups of the acrylate. The polymerisation reaction using 1.5PEGDA + 1MA + 1HDA carried out in DMF (25% w/v) at 60°C showed significant improvements compared to the analogous reaction without MA monomer. In fact, the introduction of a mono-functional monomer significantly inhibited the onset of gelation compared to the reaction of 1.5PEGDA + 1HDA (without A-monomer) that reached the gel point after 35 hours. However, the molar ratio PEGDA:MA:HDA of 1.5:1:1 used ultimately resulted in the formation of insoluble species during the polymerisation; an increase of the molecular weight of the polymer with the reaction time was observed but gelation can still occur at prolonged reaction times. The introduction of the A-monomer did however permit (i) the progress of the reaction for long times ($t \geq 5$ days) and (ii) the reduction of the molecular weight of the resulting polymer with respect to the molecular weight of polymer PEGDA-HDA obtained without the use of MA.

The results obtained in this work suggest that the synthesis of soluble, branched, uncross-linked polymer by such a strategy has a good chance of success by using a different molar ratio A₂:A:B₄ that uses higher fraction of the A-monomer and a molar ratio A₂:B₄ able to develop a branched structure. Although this was not achieved with this particular system, enough evidence has been obtained to encourage further investigations into this strategy for the synthesis of hyperbranched poly(amido amine)s which will be discussed in Chapter 5.

The addition of MA-monomer was also attempted post-polymerisation to the reaction 1.5PEGDA-1EDA. In the absence of a mono-functional monomer, this reaction did not undergo crosslinking during polymerisation in solution but did occur in the bulk polymer recovered from precipitation. It was found that the end-capping of the N-H groups of the polymer post-polymerisation did not eliminate gelation on the bulk polymer, possibly due to the reduced accessibility of such groups since they are not terminal groups. It is anticipated that the end-

capping of the acrylate groups, post-polymerisation may yet lead to a soluble branched polymer without the risk of gelation for recovered bulk polymer and it would be worthy to explore the end-capping of these groups as possible future work.

“A₂ + B₄·2HCl” strategy

Finally, inspired by the melt polymerisation of the ammonium salt of an AB₂-type monomer, the polymerisation of the monomer pair “A₂ + B₄·2HCl”, was investigated with the aim to enhance the long-term stability of PEAs. The synthesis occurred successfully in DMSO and in presence of an activator, TEA. Moreover, from the synthesis of this polymer it was observed that the retention of the HCl on the amine groups resulted in inhibition of gelation both during the polymerisation time and on the bulk polymer recovered from the reaction mixture. This observation should encourage further investigations into this strategy as a method to synthesise branched and charged polymers by double monomer methodology. The results of this work are discussed in the Chapter 5.

Stability results

The stability of the poly(ester amine) polymers to degradation was also studied by SEC analysis and NMR spectroscopy. The lightly branched polymer was chosen to investigate the mechanism of degradation as this sample was not susceptible to gelation and was hence fully soluble. The decomposition of the polymer in methanol was evident due to (i) a significant reduction of the molecular weight (SEC analysis) (ii) the presence in the ¹³C-NMR spectrum of new peaks which were assigned to alcohol groups not present in the polymer as made. It was hypothesised that degradation occurred via cleavage of the ester group of the polymer, catalysed by the amine groups within the same structure. This hypothesis was supported by comparing the stability of the polymer in methanol with the stability of the PEGDA under the same conditions – PEGDA did not show any evidence of decomposition in methanol. Amine-catalysed transesterification was reasonably proposed as cause and mechanism of polymer degradation in methanol. Moreover, it was found that the synthesis of the hydrochloride salt of hyperbranched poly(ester amine) PEA5 by the “A₂ + B₄·HCl” strategy lead to a cationically charged hyperbranched polymer with enhanced stability to degradation in methanol.

Poly(ester amine) polymers were explored in this work initially to study the synthetic strategies described, however the instability of this class of polymer represents a potential problem from an applications point of view. As the reactions in bulk have a high rate of reaction, polymerisation in solution has to be considered and the instability of poly(ester amine)s impedes the use of protic solvents such as water for the polyaddition and therefore, the use of these

polymers in aqueous formulations. Further attempts focussing on the development of strategies for the synthesis of gel-free hyperbranched polymers based on the $A_2 + B_4$ methodology and on a system which is more hydrolytically more stable such as poly(amido amine)s should enhance the stability of such polymers in a protic environment and will be the subject of Chapter 5.

References

- ¹ Tu, C., Li, N., Zhu, L., Zhou, L., Su, Y., Li, P., Zhu, X. *Polym Chem*, **2013**, *4*, 393-401.
- ² Wu, D., Liu, Y., He, C., Chung, T., Goh, S. *Macromolecules*, **2004**, *37*, 6763-6770.
- ³ Gao, C., Tang, W., Yan, D. *J Polym Sci Part A*, **2002**, *40*, 2340-2349.
- ⁴ Yan, D., Gao, C. *Macromolecules*, **2000**, *33*, 7693-7699.
- ⁵ Wu, D., Liu, Y., Chen, L., He, C., Chung, T. S., Goh, S. H. *Macromolecules* **2005**, *38*, 5519-5525.
- ⁶ Liu, Y., Wu, D. C., Ma, Y. X., Tang, G. P., Wang, S., He, C. B., Chung, T. S., Goh, S. *Chem Commun* **2003**, *20*, 2630-2631
- ⁷ Arote, R. B., Lee, E.-S. Jiang, H.-L., Kim, Y.-K., Choi, Y.-J., Cho, M.-H., Cho, C.-S. *Bioconjugate Chem*, **2009**, *20*, 2231-2241.
- ⁸ Hong, C. Y., You, Y. Z., Wu, D. C., Liu, Y., Pan, C. Y. *J Am Chem Soc*, **2007**, *129*, 5354-5355.
- ⁹ Wu, C. B., Hao, J. Y., Deng, X. M. *Polymer* **2007**, *48*, 6272-6285.
- ¹⁰ Mather, B. D., Viswanathan, K., Miller, K. M., Long, T. E. *Prog Polym Sci*, **2006**, *31*, 487-531.
- ¹¹ Wu, D. C., Liu, Y., Jiang, X., Chen, L., He, C. B., Goh, S. H., Leong, K. W. *Biomacromolecules* **2005**, *6*, 3166-3173.
- ¹² Chew, S. A., Hacker, M. C., Saraf, A., Raphael, R. M., Kasper, F. K., Mikos, A. G. *Biomacromolecules* **2010**, *11*, 600-609
- ¹³ Gao, C., Yan, D. *Prog Polym Sci*, **2004**, *29*, 183-275.
- ¹⁴ Wu, D., Liu, Y., He, C., Chung, T., Goh, S. *Macromolecules*, **2004**, *37*, 6763-6770.
- ¹⁵ Wu, D. C., Liu, Y., Jiang, X., He, C. B., Goh, S. H., Leong, K. W. *Biomacromolecules*, **2006**, *7*, 1879-1883.
- ¹⁶ Wu, D. C., Liu, Y., He, C. B., Goh, S. H. *Macromolecules*, **2005**, *38*, 9906-9909.
- ¹⁷ Dincer, S., Turk, M., Piskin, E. *Gene Ther*, **2005**, *12*, S139-S145.
- ¹⁸ Arote, R., Kim, T. H., Kim, Y. K., Hwang, S. K., Jiang, H. L., Song, H. H., Nah, J. W., Cho, M. H., Cho, C. S. *Biomaterials*, **2007**, *28*, 735-744.
- ¹⁹ Park, M. R., Kim, H. W., Hwang, C. S., Han, K. O., Choi, Y. J., Song, S. C., Cho, M. H., Cho, C. S. *J Gene Med*, **2008**, *10*, 198-207.
- ²⁰ Lynn, D. M., Langer, R. *J Am Chem Soc*, **2000**, *122*, 0761-10768.
- ²¹ Godbey, W. T., Wu, K. K., Mikos, A. G. *J Control Release*, **1999**, *60*, 149-160.
- ²² Luten, J., van Nostrum, C. F., De Smedt, S. C., Hennink, W. E. *J Control Release*, **2008**, *126*, 97-110.
- ²³ Fischer, D., Bieber, T., Li, Y. X., Elsassner, H. P., Kissel, T. *Phar. Res*, **1999**, *16*, 1273-1279.
- ²⁴ Anderson, D. G., Peng, W., Akinc, A., Hossain, N., Kohn, A., Padera, R., Langer, R., Sawicki, J. A. *PNAS*, **2004**, *101*, 16028-16033.
- ²⁵ Lynn, D. M., Anderson, D. G., Putnam, D., Langer, R. *J Am Chem Soc*, **2001**, *123*, 8155-8156.
- ²⁶ Anderson, D. G., Lynn, D. M., Langer, R. *Angew Chem Int Edit*, **2003**, *42*, 3153-3158.

-
- ²⁷ Burakowska, E., Quinn, J.R., Zimmerman, S. C., Haag, R. *J Am Chem Soc*, **2009**, *131*, 10574-10580.
- ²⁸ Kim, H. J., Kwon, M. S., Choi, J. S., Yang, S. M., Yoon, J. K., Kim, K., Park, J. S. *Biomaterials*, **2006**, *27*, 2292-2301.
- ²⁹ Kim, T. I., Seo, H. J., Choi, J. S., Yoon, J. K., Baek, J. U., Kim, K., Park, J. S. *Bioconjugate Chem*, **2005**, *16*, 1140-1148.
- ³⁰ Zhong, Z. Y., Song, Y., Engbersen, J. F. J., Lok, M. C., Hennink, W. E., Feijen, J. *J Control Release*, **2005**, *109*, 317-329.
- ³¹ Chew, S. A., Hacker, M. C., Saraf, A., Raphael, R. M., Kasper, F. K., Mikos, A. G. *Biomacromolecules*, **2009**, *10*, 2436-2445.
- ³² Odian, G. *Principles of Polymerization*, 3rd ed., John Wiley & Sons, New York, **1991**.
- ³³ Manaresi P., Munari A., Pilati F., Alfonso G. C., Russo S., Sartirana L. *Polymer*, **1986**, *27*, 955-960.
- ³⁴ Rosu R. F., Shanks R. A., Bhattacharya S. N. *Polym Int*, **1997**, *42*, 267-275.
- ³⁵ Hudson, N., MacDonald, W. A., Neilson, A., Richards, R. W., Sherrington D. C. *Macromolecules*, **2000**, *33*, 9255-9261.
- ³⁶ Hobson, J. L., Kenwright, A. M., Feast, W. J. *Chem Commun*, **1997**, 1877-1878.
- ³⁷ Bradley, D., Williams, G., Lawton, M. *J Org Chem*, **2010**, *75*, 8351-8354.
- ³⁸ Jikei, M., Chon, S. H., Kakimoto, M., Kawauchi, S., Imase, T., Watanebe, J. *Macromolecules* **1999**, *32*, 2061-2064.
- ³⁹ Russo, S., Boulares, A., da Rin, A., Mariani, A., Cosulich, M. E. *Macromol Symp*, **1999**, *143*, 309-321.
- ⁴⁰ Emrick, T., Chang, H.-T., Frechet, J. M. J. *Macromolecules*, **1999**, *32*, 6380-6382.
- ⁴¹ Gao, C., Xu, Y., Yan, D., Chen, W. *Biomacromolecules*, **2003**, *4*, 704-712.
- ⁴² Hölter, D., Burgath, A., Frey, H. *Acta Polym*, **1997**, *48*, 30-35.
- ⁴³ Holter, D., Frey, H. *Acta Polym*, **1997**, *48*, 298-309.
- ⁴⁴ Pizzi, A., Mittal, K. L. *Handbook of adhesive technology*, Chapter 8, **2003**, New York, NY 10016, USA.
- ⁴⁵ Stolov, A. A., Xie, T., Penelle, J., Hsu, S. L. *Macromolecules*, **2000**, *33*, 6970-6976.
- ⁴⁶ Lin, Q., Long, T. E. *Macromolecules*, **2003**, *36*, 9809-9816.
- ⁴⁷ Reisch, A.; Komber, H.; Voit, B. *Macromolecules* **2007**, *40*, 6846-6858.
- ⁴⁸ Horie, K., Hiura, H., Sawada, M., Mita, I., Kambe, H. *J Polym Sci Part A*, **1970**, *8*, 1357-1372.
- ⁴⁹ Peters, R., PhD thesis, University of Amsterdam, **2009**.
- ⁵⁰ Schuchardta, U., Serchelia, R., Vargas, R. M. *J Braz Chem Soc*, **1998**, *9*, 199-210.
- ⁵¹ Robertson, G. P., Mikhailenko, S. D., Wang, K. P., Xing, P. X., Guiver, M. D., Kaliaguine, S. *J Membrane Sci*, **2003**, *219*, 113-121.
- ⁵² Hobson, L.J., Feast, W. J. *Polymer*, **1999**, *40*, 1279-1297.
- ⁵³ Danusso, F., Ferruti, P. *Polymer*, **1970**, *11*, 88-113.

Chapter 4

Hyperbranched poly(amido amine)s Synthesis, Characterisation and Stability upon storage.

4.1 Hyperbranched poly(amido amine) via Michael addition reaction: state of art.

Poly(amido amine) polymers (PAMAMs) are a class of macromolecules that can be obtained by polyaddition of diacrylamide (A_2) and diamine monomers (e.g. B^1B_2 , B_4)^{1,2}. The polyaddition occurs via aza-Michael addition of primary or secondary amines (Michael donors) to the double bond of the acrylate group (Michael acceptor) activated by the adjacent, electron withdrawing carbonyl group. The number of active N-H bonds on the Michael donor determines the number of potential branch points (Scheme 4.1); for instance a B_4 monomer bearing two primary amine groups (4 N-H groups) can form a branched polymer while a B_2 monomer with two secondary amine groups can only lead to a linear structure (Scheme 4.1)^{3,4,5}.

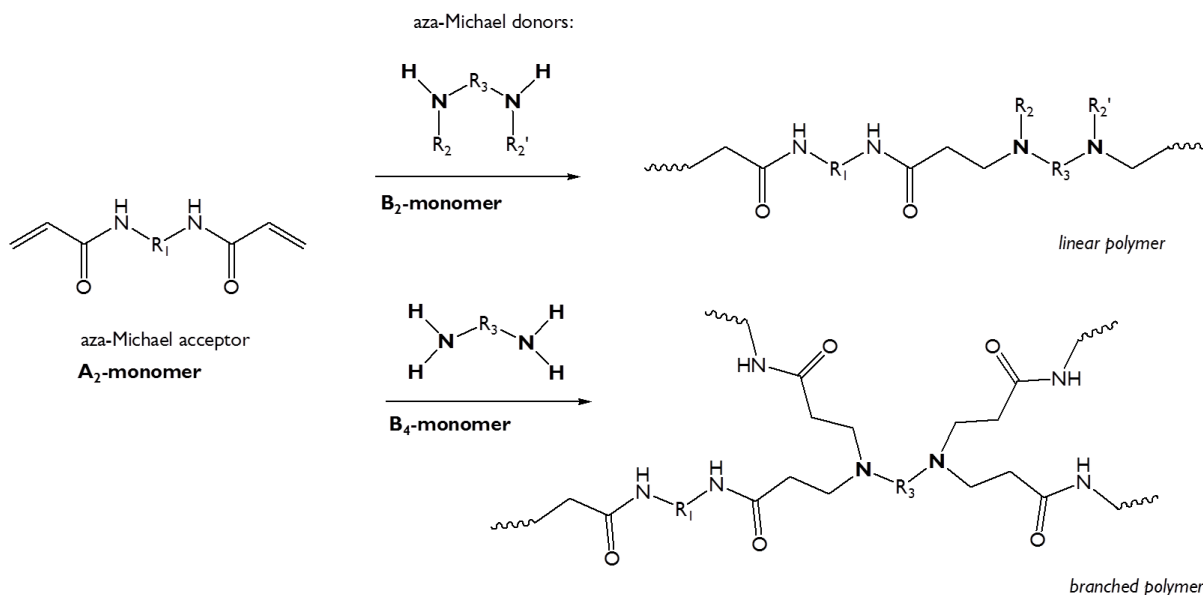

Scheme 4.1 Schematic representation of the synthesis of poly(amido amine) with different structure depending on the number of active hydrogen on the Michael donors.

In this case, as for the synthesis of hyperbranched poly(ester amine)s, the choice of a B_4 -monomer can lead to the formation of cross-linked structures. Thus, hyperbranched poly(amido amine)s have previously been preferentially synthesised by using monomers such as B^1B_2 with, for example, a secondary amine (B^1) and a primary amine (B_2) in order to control the formation of cross-linked, insoluble species^{1,3,6,7}. In this case the polymerisation occurs by a one-pot two-step reaction whereby in the first step, the secondary amine reacts with the acrylamide group and in the second step the primary amine group reacts with the acrylamide groups³. Examples of monomer pairs typically used for the synthesis of hyperbranched poly(amido amine) are shown in Figure 4.1.

The use of a low concentration of reactants, low temperatures and a stringently controlled molar ratio is also preferred to gain control over the reaction and promote the synthesis of gel-free, soluble branched poly(amido amine)^{8,9,10,11}.

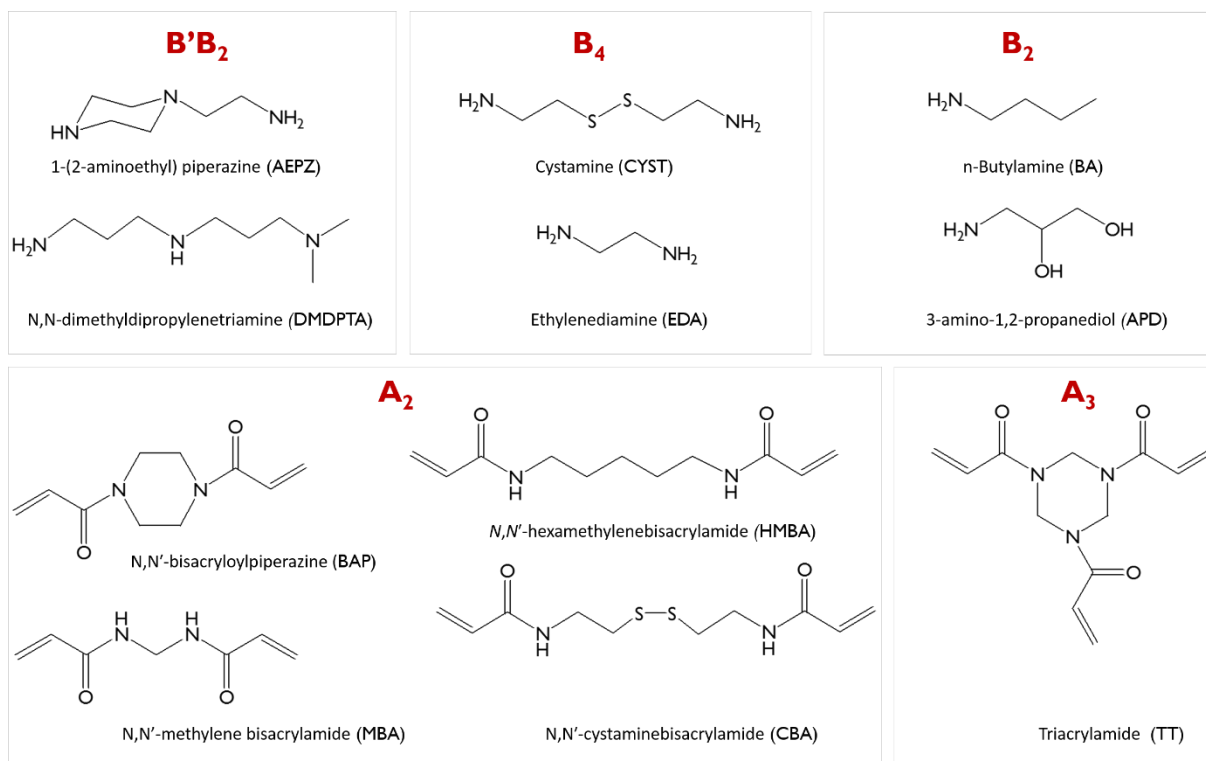
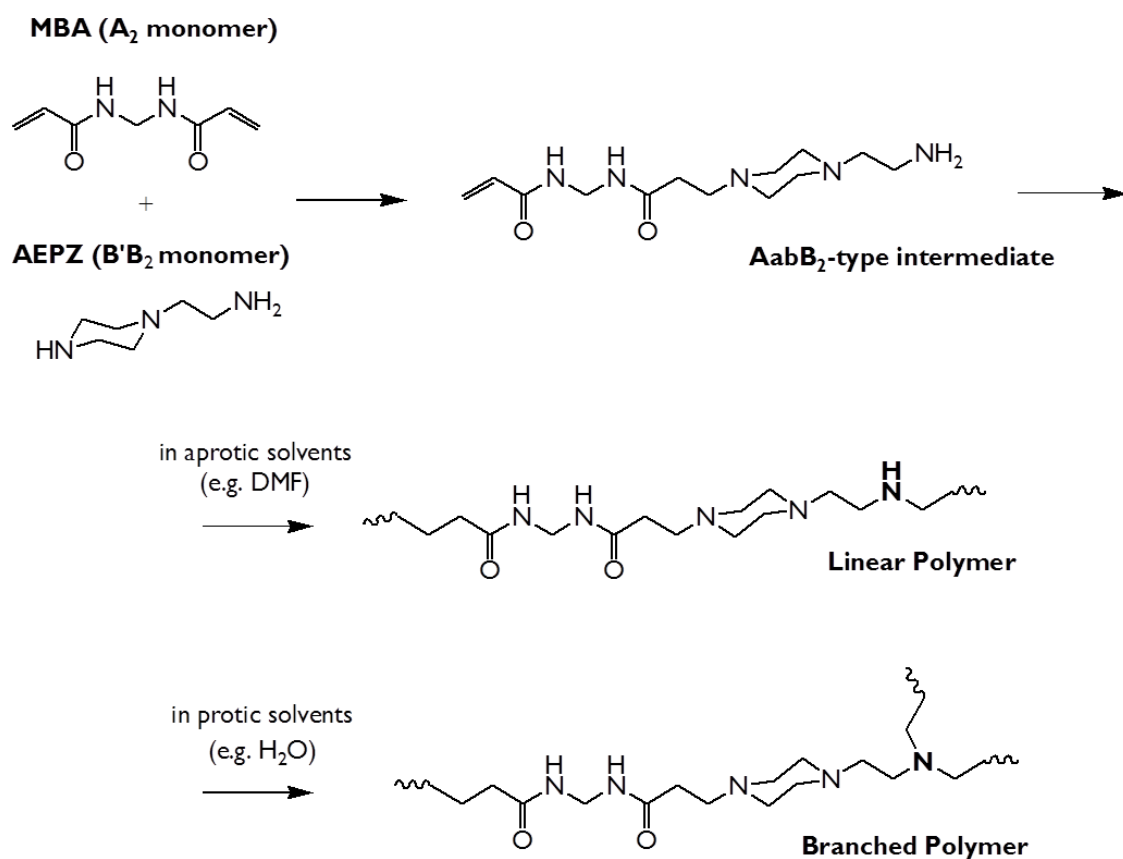

Figure 4.1 Typical Michael donors ($B'B_2$, B_4 , B_2) and Michael acceptors (A_2 and A_3) used for the synthesis of hyperbranched poly(amido amine) via aza-Michael addition polymerisation. MBA-AEPZ²¹, CBA-AEPZ¹⁶, TT-BA¹, TT-APD¹⁸, CBA/BAP-EDA/CYST², HMBA/CBA-DMDPTA⁶.

The typical polymerisation reactions shown in Scheme 4.1 occur preferably in protic solvents which are able to carry mobile protons; water as well as alcohols including ethylene glycol, methanol, ethanol, N-methyl-N,N-di-2-hydroxyethylamine and benzyl alcohol are all good media for the reaction^{12,14}. Such solvents accelerate the rate of the reaction leading to a polymer with high molecular weight without the use of catalysts or the need for high temperatures. In contrast, aprotic solvents decrease the rate of the reaction and low molecular weights are obtained^{12,13}. The polyaddition reaction follows pseudo-second order kinetics in a protic solvent and third-order kinetics in aprotic solvents. The kinetic constant includes in the former case, the catalytic protic species while in latter case takes into account the autocatalytic activity of the amine groups^{14,15}.

For the polyaddition between MBA and AEPZ (Scheme 4.2), it has also been found that the varying ability of solvents to act as a proton transfer agent affects the topology of the resulting polymer, by controlling the reactivity of the primary and secondary amine toward the acrylamide. Thus, in the polymerisation MBA-AEPZ, the different reactivity between a

secondary and primary amine leads to the rapid formation of an AabB₂-type intermediate (Scheme 4.2) where A and a are the unreacted and reacted vinyl group respectively of the acrylamide group of the A₂-monomer while B₂ represents the two unreacted N-H groups of the primary amine and b represents the reacted secondary amine groups. This intermediate is formed both in aprotic and protic solvents but the branched units are preferably formed from the reaction of the two N-H groups of the primary amine in protic solvents¹⁷. Thus, a linear polymer (DB = 0.00) was obtained in DMF, a lightly branched polymer (DB < 0.30) obtained in a mixture of DMF/water and a hyperbranched polymer (DB = 0.44) in pure water^{5,16,17}.



Scheme 4.2 Schematic illustration of the synthesis route and the molecular structure of PAMAMs obtained in different solvents¹⁶.

Hyperbranched poly(amido amine) polymers can be further functionalised. For this purpose, starting materials bearing specific functionalities can be used for the polymerisation in order to introduce functional groups into the polymer structure. These additional functionalities on the starting monomer should not interfere with the polymerisation reaction and, once present as terminal groups of the polymer, they can be used to alter the properties of the polymer by further functional group transformation reactions carried out post-polymerisation. Previous examples of functional groups which have been introduced during the polymerisation by means of the

starting monomers include hydroxyl (e.g. APD in Figure 4.1), tertiary amine (e.g. DMDPTA in Figure 4.1), allyl, amide and ether groups^{6,18,19}. On the other hand, chemical groups such as -NH₂ or -NHR, which are able to react with the double bond of the A_x monomer, must be introduced using different strategies. Primary and secondary amines as terminal groups of the polymer can be introduced via the starting monomers as protected functionalities^{5,20}. Alternatively, these functionalities can be introduced post-polymerisation^{1,21,22}. For instance, a branched poly(amido amine) with only vinyl groups as terminal groups can be modified post-polymerisation with specific molecules bearing amine functional groups²³.

Hyperbranched poly(amido amino)s are in general, more hydrolytically stable than analogous poly(ester amine)s. Linear poly(amido amino)s have been found to be stable in concentrated aqueous solution at pH 8-10 and T=18-25°C therefore these conditions permit the occurrence of polymerisation without evidences of degradation³⁴. However, degradation via hydrolysis of the amidic groups was observed in protic solvents under reflux for poly(amido amino) dendrimers²⁴. Moreover, a decomposition study has been previously reported for linear poly(amido amine)s in dilute aqueous solution (0.2% w/v) at pH 7.4 (phosphate buffer) and 37°C; a reduction of the molecular weight of the polymer to oligomers was observed after periods ranging from days to several weeks²⁵. A relationship between the degradation rate and the polymer structure has been observed and in particular, it has been found that amphoteric poly(amido amine)s (bearing acidic functional group, e.g. BAC-2MeP in Figure 4.2) underwent degradation with a slower rate compared to non-amphoteric counterpart (e.g. MBA-2MeP in Figure 4.2)^{4,26}. This effect is due to the different functional groups present within the two polymer structures that affect the pH of the aqueous solution. The amino groups of the poly(amido amine)s act as a base in aqueous solution, catalysing the hydrolysis reaction. Therefore the introduction of an acidic functionality within the polymer structure decreases the pH of the solution and increases the stability of such polymers.

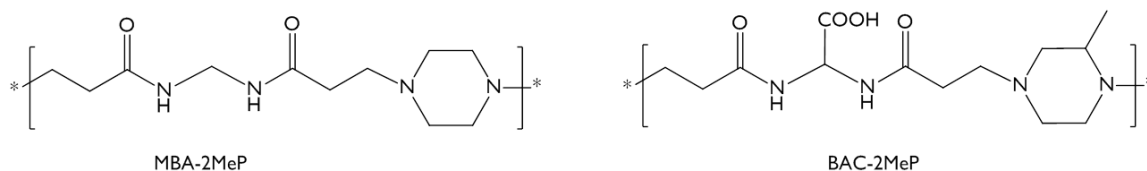

Figure 4.2 Structure of the linear portion of PAMAMs used for the study of the stability in aqueous media.

Degradation is in fact strongly influenced by the pH. A study carried out by dissolving the BP-BHE polymer (bisacryloyl piperazine-N,N'-bis(2-hydroxyethyl)ethylene-diamine) in water at

pH 5.5, 7.5 and 8.0 at 37°C shows that hydrolytic cleavage occurs more rapidly under alkaline and neutral conditions while at acidic pH degradation takes place with a very slow rate²⁷.

A similar study on the stability of poly(amido amine)s has been carried out on quaternised linear poly(amido amine)s in aqueous media and it was observed that such polymers are (i) reasonably stable in neutral conditions for some days but ultimately degrade to oligomeric products, (ii) stable in acidic conditions and (iii) unstable at pH > 7, conditions at which fast degradation occurs²⁵.

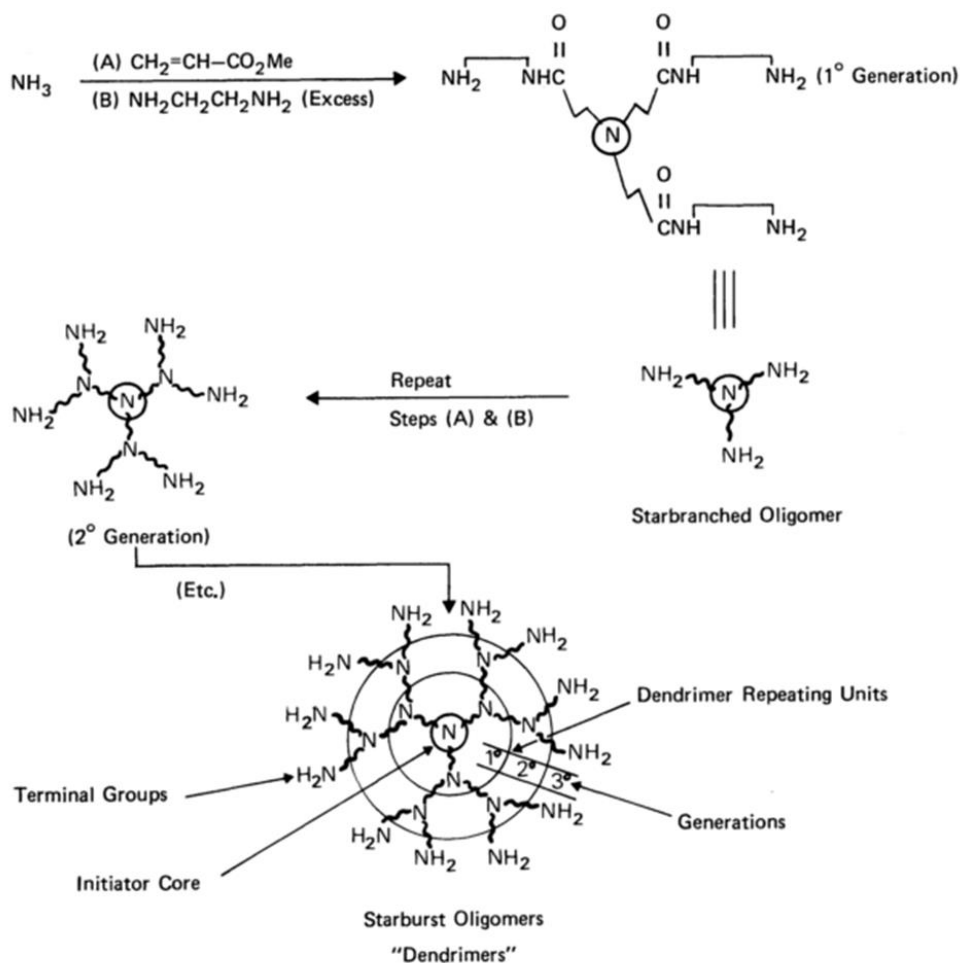
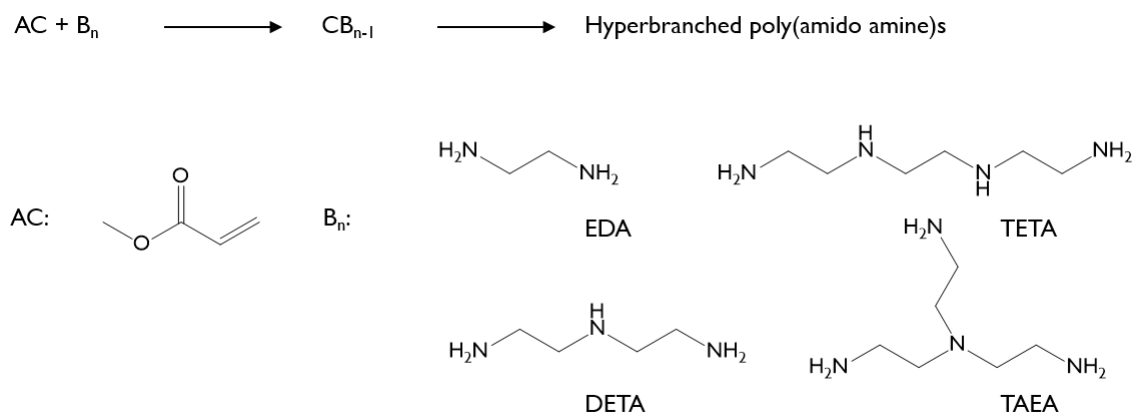

Figure 4.3 PAMAM dendrimers synthesis²⁸.

When considering branched poly(amido amine)s it is worth mentioning PAMAM dendrimers as the original branched poly(amido amine) (also called Starburst polymers) described for the first time in 1985 by Tomalia *et al*²⁸. It is the most widely investigated family of dendrimers and the first to be produced on a commercial scale. However, the use of PAMAM dendrimers is still limited to research areas due to its high cost. The synthesis of PAMAM dendrimers starts as depicted in Figure 4.3 with ammonia or ethylene diamine (EDA) as a core followed by exhaustive Michael addition of amino groups with methyl acrylate and subsequently amidation

of the resulting ester with EDA. The scientific interest in PAMAM dendrimers has been due to the well-defined globular structure and high density of positive charge on the surface that permits the condensation of DNA and the interaction with cells in drug and gene delivery applications^{29,30}. However, a large scale synthesis of this product is difficult and expensive and the functionalisation of the polymer would increase complexity of the synthesis. For this reason, hyperbranched PAMAM analogues were developed³¹. Aliphatic hyperbranched PAMAM can be prepared by polymerisation of an AC-monomer such as methyl acrylate (MA) - where A is the acrylate group and C the methyl ester group - with polyamine (B_n monomers) such as ethylenediamine (EDA), diethylenetriamine (DETA), triethylenetetramine (TETA), tris(2-aminoethyl)amine (TAEA) (Scheme 4.3). The reaction leads to the formation of a CB_{n-1} intermediate at room temperature with a feed ratio AC: B_n of 1:1; the intermediate is able to self-condense via amidation reaction at high temperatures under vacuum. Molecular weights (M_n) ranging from 7,000 to 12,000 $\text{g}\cdot\text{mol}^{-1}$ with \bar{D} of 1.8-2.6 were obtained using DMF SEC analysis and a calibration curve of linear PS standards^{32,33}. The resulting hyperbranched polymer can be prepared with different terminal groups by varying the ratio AC: B_n from 1:1 to n :1 (with $n > 1$).



Scheme 4.3 Synthesis of hyperbranched PAMAM via AC+ B_n approach

4.2 Aims of the current work

Hyperbranched poly(amido amine)s (HPAMAMs) can be synthesised by the Michael addition reaction between bisacrylamides (A_2) and primary diamino monomers (B_4). The tendency of such ($A_2 + B_4$) systems to undergo gelation and strategies to inhibit gelation has been discussed in the previous chapter. The synthesis of soluble hyperbranched polymers from a (modified) $A_2 + B_4$ system without the risk of gelation, offers the possibility of commercial scale up and the development of new industrially relevant applications.

In Chapter 3 it was also found that hyperbranched poly(ester amine)s are unstable in protic solvents since the amine functionalities within the polymer structure catalyse the cleavage of the ester groups and hence the degradation of the product. Although, the main aim of the current work is to synthesise gel-free, soluble hyperbranched polymers, the long-term stability of these polymers is an important issue that must be considered. The hydrolytic instability of poly(ester amine)s precludes their use in aqueous formulations. However, the stability of this type of polymer can be enhanced by decreasing the reactivity of the amine groups by their quarternisation. Alternatively, the ester group in the A₂ monomer can be replaced with a functional group which is more hydrolytically stable such as the amide group. The increased stability of the amide group permits the use of protic reaction solvents. In this work, we aim to:

- (i) explore the effect of reaction conditions upon the synthesis of hyperbranched poly(amido amine)s and test the reproducibility of the optimised reaction;
- (ii) study the stability of the resulting polymers in protic solvents (e.g. water) in comparison to that of poly(ester amine)s;
- (iii) study the stability of the bulk poly(amido amine)s during long term storage;
- (iv) modify the properties of the hyperbranched polymers by varying the chemical structure of the diamine monomer.

Once a good understanding of the new A₂ + B₄ system has been achieved, the strategies developed to inhibit gelation presented in Chapter 3 will be implemented, not only to prevent the formation of cross-linked species but also to produce functionalised hyperbranched PAMAM polymers in a one-pot reaction.

4.3 Experimental part

4.3.1 Materials and reagents

N,N'-methylenebis(acrylamide) (MBA, 99%), ethylenediamine (EDA: ReagentPlus®, ≥99%), 2,2'-(ethylenedioxy)bis(ethylamine) (EOBEA, 98%), triethylamine (TEA: ≥99%), dimethyl sulfoxide-d₆ (DMSO-d₆ 99.96 atom % D), chloroform-d (CDCl₃ 99.96 atom % D), phosphorus pentoxide (P₂O₅, ≥98%), lithium chloride hydrate (LiCl·H₂O, ≥99.99%) and magnesium nitrate hexahydrate (Mg(NO₃)₂·6H₂O) were all purchased from Sigma-Aldrich and used as received. PriamineTM1075 and ArlasolveTM (DMI 99.02%) were provided by Croda. Distilled water, methanol (analytical reagent grade), tetrahydrofuran (laboratory reagent grade), acetone (laboratory reagent grade) were purchased from Fisher scientific and used without any

purification. Poly(ethylene oxide) (PEO) and poly(styrene) (PS) standards were purchased from Polymer Laboratories.

4.3.2 Characterisation techniques

Size exclusion Chromatography (SEC)

The number-average molecular weight (M_n), weight-average molecular weight (M_w) and dispersity (\mathcal{D}) were determined by size exclusion chromatography (SEC).

The series of polymers HPAMAM 1 and HPAMAM 2 were analysed on a Viscotek TDA 301 with refractive index, light scattering, and viscosity detectors. Two PLgel 5 μ m mixed C columns were used (linear range of molecular weight from 200-2,000,000 g/mol). DMF with 0.1% of LiBr was used as mobile phase at a flow rate of 1.0 ml/min and at 70 °C. The molecular weight was determined by means a conventional calibration curve (log MW vs. Retention Volume) which was set up using a series of narrow molecular weight poly(ethylene oxide) (PEO) standards (Polymer Labs). For the polymer HPAMAM 1-type the molecular weight was also calculated by using triple detection SEC. For this purpose the dn/dc of the hyperbranched polymer was determined by preparing a solution of the product in DMF at a known concentration (approximately 1.00 mg/ml) and by analysing the sample with respect to a polymer standard with a known dn/dc . A triple detection calibration was created as a single polystyrene standard with a dn/dc in DMF of 0.165 ml/g⁴⁰; M_n 65000 g/mol; \mathcal{D} 1.025; intrinsic viscosity (IV) 0.256.

The polymers HPAMAM3 were analysed on a Viscotek TDA 302 with refractive index, light scattering, and viscosity detectors and 2 x 300 mm 5 μ m PLgel mixed C columns that have a linear range of molecular weight from 200-2.000.000 g/mol. The solvent was THF, the flow rate was 1.0 ml/min at a temperature of 35°C. The molecular weight was calculated (i) by means a conventional calibration curve which was set up using a series of narrow molecular weight polystyrene (PS) standards (Polymer Labs) and (ii) by triple detection using the value of dn/dc of polystyrene in THF ($dn/dc = 0.185$ ml/g)⁴⁰.

Sample preparation: SEC analysis was carried out on the intermediate products of the polymerisation, analysed without purification and on the final polymer purified by precipitation. For the intermediate products: aliquots (5.5 μ l for the solution with monomer concentration of 18% w/v) of the polymerisation solution corresponding to approximately 1 mg of polymer were diluted with 1 ml of DMF to obtain a solution concentration of approximately 1 mg/ml. The final product of the polymerisation, recovered by precipitation and dried, were prepared for

SEC analysis by weighing approximately 1.0 mg of the polymer and dissolving it in 1 ml of DMF order to obtain a concentration of 1 mg/ml.

SEC analysis: calculation of the dn/dC of the HPAMAM 1.7 polymer

HPAMAM 1.7 was synthesised in two different reactions, using the same reaction conditions. The products recovered by precipitation from the two reactions were used to prepare solutions in DMF at 0.880 and 1.088 mg/ml respectively; by setting the SEC experiment with such parameters values of dn/dC of 0.0987 and 0.1050 ml/g were obtained respectively for samples labelled in the section 4.4.1.3.2 as HPAMAM 1.7.1 and HPAMAM 1.7.2.

SEC analysis: calculation of the gel fraction for sol-gel samples

Method (a)

1. In a typical experiment, a solution of the HPAMAM 1.7 polymer (fully soluble) in DMF was prepared at a known concentration C_1 of 0.8800 mg/ml in a volumetric flask. The solution was agitated overnight to allow solubilisation, analysed by DMF SEC and the area of the chromatograms obtained ($A_1 = 54.40$).
2. Subsequently, a suspension in DMF of the partially crosslinked (sol-gel) polymer, obtained by exposing the soluble HPAMAM 1.7 polymer for a certain time (e.g. 3 days) at relative humidity (RH) = 53.4%, was prepared at a known concentration of 0.7810 mg/ml by using a volumetric flask. The suspension was agitated overnight to allow complete solubilisation of the sol fraction, filtered through a 0.4 μm syringe filter to remove the gel fraction and the filtrate (solution of the sol fraction of the polymer in DMF) analysed by DMF SEC. The chromatogram of the sample with an area of $A_2 = 44.60$ was acquired.

As the area of the resulting chromatograms obtained by RI detector is proportional to the concentration of the polymer in DMF (eluent SEC analysis), the acquired areas A_1 and A_2 for the fully soluble and sol-gel samples respectively have to be divided by the respective initial concentrations C_1 and C_2 and the percentage of gel fraction calculated as follow:

$$\frac{A_1}{C_1} : 100 = \frac{A_2}{C_2} : (100-x) \quad ; \quad x = \% \text{ gel fraction} = 7.62\% \text{ (3 days, RH=53.4\%)} \quad \text{Equation 4.1}$$

Method (b)

The triple (RI, RALS, IV) detectors were used to calculate the concentration of sol fraction present in the sol-gel samples and estimate the percentage of gel fraction. In this case the specific dn/dC of the samples in DMF is required. For this purpose the average dn/dC value of

0.1019 \pm 0.0032 ml/g obtained for the sample HPAMAM 1.7 (fully soluble), was used for all the sol-gel samples analysed. For the SEC analysis, suspensions at known concentrations of the sol-gel samples in DMF were prepared. The suspensions were agitated overnight to allow the full solubilisation of the sol fraction, filtrated through a 0.4 μ m syringe filter to remove the gel fraction and the filtrate (solution of the sol fraction of the polymer in DMF) analysed by SEC. The concentration of the soluble fractions was automatically calculated by setting the SEC experiment with the specific refractive index (dn/dC) of the soluble fraction (assumed to be 0.1019 ml/g). The ratio of the calculated concentration obtained from the SEC experiment and the total concentration measured gives the actual percentage of soluble fraction of the analysed samples and hence the percentage of gel fraction formed during the time.

Nuclear Magnetic Resonance Spectroscopy

One-dimensional solution ^1H -NMR and ^{13}C -NMR spectra of the synthesised hyperbranched polymers were obtained using a Varian spectrometer 700 MHz and 176 MHz respectively (298 K). The spectra were referenced to the trace of hydrogenous solvent present in the deuterated NMR solvent. $(\text{CD}_3)_2\text{SO}$ was used as a solvent for 1D and 2D-NMR measurement of the HPAMAM 1 and HPAMAM 2- type of polymers [$\delta(^1\text{H}) = 2.50$ ppm; $\delta(^{13}\text{C}) = 39.52$ ppm] while CDCl_3 was used for the HPAMAM 3-type polymer [$\delta(^1\text{H}) = 7.26$ ppm; $\delta(^{13}\text{C}) = 77.16$ ppm]. Quantitative ^{13}C -NMR spectra were obtained by using inverse gated decoupling, recording the signals for 5 hours with a relaxation delay of 10.0 seconds and a pulse of 45.0 degree to quantify the structural units of the polymer. 2D-NMR, ^1H , ^{13}C -HMBC and ^1H , ^{13}C -HSQC spectra, were recorded with a standard pulse sequence to assign the polymer structure.

4.3.3 Synthesis of hyperbranched poly(amido amine)s.

Hyperbranched poly(amido amine)s (HPAMAM) synthesised in this work are labelled as HPAMAM 1, HPAMAM 2 and HPAMAM 3 according to the monomer pair used for the polyaddition and hence to the chemical structure of the polymer (Figure 4.4). Moreover, the synthesis of HPAMAM 1 was carried out by using different monomer mole ratios, temperature and time or solvents mixture, and as these parameters have an impact on the molecular weight and structure of the final polymer, the samples were identified as HPAMAM 1.X where X distinguishes the polymers on the basis of the different reaction conditions used. Similar labelling system was used for HPAMAM 3 in which different times or solvent mixture were used for the polymerisation. The codes for all the polymer synthesised in the present work are listed in Table 4.1

Table 4.1 Samples codes of the polymers synthesised by using different monomer pairs and reactions conditions.

Sample Code	Monomers pair	Molar ratio A ₂ :B ₄	Temperature (°C)	time (h)	Solvent	
HPAMAM 1.1	MBA-EDA	1:1	RT	72	MeOH/H ₂ O	
HPAMAM 1.2		1.2:1		5		
HPAMAM 1.3		1.5:1		6		
HPAMAM 1.4		2.5:1		24		
HPAMAM 1.5		3:1		72		
HPAMAM 1.6				40		10
HPAMAM 1.7				24		
HPAMAM 1.8				168		
HPAMAM 1.9				96		Arlasolve™/H ₂ O
HPAMAM 1.10		50	72	MeOH/H ₂ O		
HPAMAM 2	MBA-EOBEA	3:1	40	72	MeOH/H ₂ O	
HPAMAM 3.1	MBA-Priamine™	3:1	60	72	MeOH/THF	
HPAMAM 3.2				96	MeOH/THF	
HPAMAM 3.3				72	MeOH/Arlasolve™	

Polyaddition MBA-EDA: synthesis of hyperbranched HPAMAM 1 at 40°C

HPAMAM 1.7: in a typical reaction MBA (1.00 g, 6.50 mmol) was dissolved in 5.3 ml (18% w/v) of a methanol/water mixture (70/30 v/v) in a 100 ml round bottom flask. EDA (0.13 g, 2.16 mmol) was subsequently added to the solution. The mixture was stirred under nitrogen atmosphere at 40 °C for 24 hours. The final product was recovered by precipitation in acetone with a yield of 75%. SEC analysis (DMF+0.1%LiBr): M_n 3250 g/mol, M_w 19500 g/mol, \bar{D} 6.0 (PEO standards). ¹H-NMR (700 MHz, d-DMSO): %A conversion = 65% (calculated from the polymerisation mixture analysed without purification); ¹³C-NMR (176 MHz, d-DMSO) DB = 0.98.

HPAMAM 1.8: the reaction described above was repeated under the same conditions for 168h. Yield of 80%; SEC analysis (DMF+0.1%LiBr): M_n 3500 g/mol, M_w 52500 g/mol, \bar{D} 15.0 (PEO standards); ¹³C-NMR (176 MHz, d-DMSO): DB = 0.98.

HPAMAM 1.6: the reaction described above was repeated under the same reaction conditions except that the reaction was quenched by precipitation after 10 hours. The polymer was recovered with a yield of 60%. SEC analysis (DMF+0.1%LiBr): M_n 1500 g/mol, M_w 4950 g/mol, \bar{D} 3.5 (PEO standards). ¹³C-NMR (176 MHz, d-DMSO): DB = 0.92.

HPAMAM 1.9: The polyaddition MBA (6.50 mmol) and EDA (2.16 mmol) was also carried out in 10.4 ml (10% w/v) of Arlasolve™/H₂O (50/50% v/v) at 40°C (see Figure 4.18 for the structure of Arlasolve™). The polymer was recovered by precipitation in acetone after 96 hours. Yield = 70% containing c.a. 6.5% of gel fraction; SEC analysis (DMF+0.1%LiBr) of the sol

fraction: M_n 3000 g/mol, M_w 35000 g/mol, \bar{D} 11.5 (PEO standards). ^{13}C -NMR (176 MHz, d-DMSO): DB = 0.82.

Polyaddition MBA-EDA: synthesis of HPAMAM 1 at 50°C

HPAMAM 1.10: the reaction described above for HPAMAM 1.7 was repeated with the same molar ratio for 72h at 50°C. Yield= 85% (contains c.a. 5% gel fraction); soluble fraction: SEC analysis (DMF+0.1%LiBr): M_n 3910 g/mol, M_w 60170 g/mol, \bar{D} 15.3 (PEO standards). ^{13}C -NMR (176 MHz, d-DMSO): DB = 0.97.

Polyaddition MBA-EDA: synthesis of HPAMAM 1 at RT

HPAMAM 1.5: the reaction described above was repeated with the same molar ratio for 72h at RT. Yield= 82%; SEC analysis (DMF+0.1%LiBr): M_n 2500 g/mol, M_w 15000 g/mol, \bar{D} 6.0 (PEO standards); ^{13}C -NMR (176 MHz, d-DMSO): DB = 0.92.

The polyaddition MBA-EDA carried out at RT was repeated using different monomer molar ratios:

HPAMAM 1.1: 1 g MBA (6.50 mmol) and 0.26 g EDA (6.50 mmol) were dissolved in 6.5 ml methanol/water (70/30 v/v) and the reaction stirred for 72h. SEC analysis (DMF+0.1%LiBr): M_n 350 g/mol, M_w 3850 g/mol, \bar{D} 10.0 (PEO standards); ^1H -NMR (700MHz, d-DMSO): A group conversion c.a. 100%; ^{13}C -NMR (176 MHz, d-DMSO): DB=0.15 (data relative to the impure product).

HPAMAM 1.2: 1 g MBA (6.50 mmol) and 0.32 g EDA (5.42 mmol) were dissolved in 6.2 ml (5.3 g) methanol/water (70/30 v/v) and stirred for 5 hours until the formation of a gel product was observed. Yield (gel product recovered) = 95%. The analysis of the reaction mixture after 3 hours shows the formation of the following product: SEC analysis (DMF+0.1%LiBr): M_n 150 g/mol, M_w 190 g/mol, \bar{D} 1.2 (PEO standards).

HPAMAM 1.3: 1 g MBA (6.50 mmol) and 0.26 g EDA (4.32 mmol) dissolved in 6.0 ml (5.3 g) methanol/water (70/30 v/v) and stirred for 6 hours until the formation of a gel product was observed. Yield (gel product recovered) = 90%. The analysis of the reaction mixture after 5 hours shows the formation of the following product: SEC analysis (DMF+0.1%LiBr): M_n 450 g/mol, M_w 2000 g/mol, \bar{D} 4.5 (PEO standards); ^1H -NMR (700MHz, d-DMSO): A group conversion 90%; ^{13}C -NMR (176 MHz, d-DMSO): DB = 0.35.

HPAMAM 1.4: 1 g MBA (6.50 mmol) and 0.16 g EDA (2.60 mmol) dissolved in 5.5 ml methanol/water (70/30 v/v) and stirred for 24 hours until the formation of a gel product was observed. A gel product swollen in the solvent was recovered.

$^1\text{H-NMR}$ (700 MHz, d-DMSO, 298K) δ ppm: 8.69 and 8.56 (m, 1H, $-\text{NH}\underline{\text{C}}(\text{O})-$, MBA), 6.28, 6.11 and 5.65 (m, 3H, $-\underline{\text{C}}\text{H}=\underline{\text{C}}\text{H}_2$, MBA), 4.47 and 4.37 (m, 2H, $-\text{NH}\underline{\text{C}}\text{H}_2\underline{\text{N}}\text{HC}-$, MBA), 2.61, 2.38 and 2.21 (m, $-\text{N}\underline{\text{C}}\text{H}_2\underline{\text{C}}\text{H}_2\underline{\text{N}}(\underline{\text{C}}\text{H}_2\underline{\text{C}}\text{H}_2\underline{\text{C}}(\text{O})-)_2$ and $-\text{N}\underline{\text{C}}\text{H}_2\underline{\text{C}}\text{H}_2\underline{\text{N}}\text{H}\underline{\text{C}}\text{H}_2\underline{\text{C}}\text{H}_2\underline{\text{C}}(\text{O})-$).

$^{13}\text{C-NMR}$ (176 MHz, d-DMSO, 298K) δ ppm: 173.5 ($-\text{NH}\underline{\text{C}}\text{H}_2\underline{\text{N}}\underline{\text{C}}(\text{O})-$, MBA), 166.3 ($-\text{NH}\underline{\text{C}}\text{H}_2\underline{\text{N}}\underline{\text{C}}(\text{O})\text{CH}=\text{CH}_2$, MBA), 131.5 and 127.5 ($-\underline{\text{C}}\text{H}=\underline{\text{C}}\text{H}_2$, MBA), 52.2, 51.1, 50.0 ($-\text{N}\underline{\text{C}}\text{H}_2\underline{\text{C}}\text{H}_2\underline{\text{N}}(\underline{\text{C}}\text{H}_2\underline{\text{C}}\text{H}_2\underline{\text{C}}(\text{O})-)_2$ and $-\text{N}\underline{\text{C}}\text{H}_2\underline{\text{C}}\text{H}_2\underline{\text{N}}\underline{\text{C}}\text{H}_2\underline{\text{C}}\text{H}_2\underline{\text{C}}(\text{O})-$), 44.3 ($-\text{NH}\underline{\text{C}}\text{H}_2\underline{\text{N}}-$, MBA), 35.1 and 33.4 ($-\text{N}\underline{\text{C}}\text{H}_2\underline{\text{C}}\text{H}_2\underline{\text{N}}(\underline{\text{C}}\text{H}_2\underline{\text{C}}\text{H}_2\underline{\text{C}}(\text{O})-)_2$ and $-\text{N}\underline{\text{C}}\text{H}_2\underline{\text{C}}\text{H}_2\underline{\text{N}}\underline{\text{C}}\text{H}_2\underline{\text{C}}\text{H}_2\underline{\text{C}}(\text{O})-$).

Polyaddition MBA-EOBEA: synthesis of HPAMAM 2.

HPAMAM 2: in a typical reaction MBA (1.00 g, 6.50 mmol) was dissolved in 6.2 ml (18% w/v) of a methanol/water mixture (70/30 v/v) in a 100 ml round bottom flask. EOBEA (0.32 g, 2.16 mmol) was subsequently added to the solution. The mixture was stirred under nitrogen atmosphere at 40 °C for 72 hours. Part of the mixture was received by precipitation in acetone (SEC analysis (DMF+0.1%LiBr): M_n 4150 g/mol, M_w 14800 g/mol, \bar{D} 3.5 (PEO standards) and the other part dried by removing the solvent under reduced pressure and the polymer stored as impure in vacuum oven: SEC analysis (DMF+0.1%LiBr): M_n 800 g/mol, M_w 11700 g/mol, \bar{D} 14.5 (PEO standards). $^1\text{H-NMR}$ (700 MHz, d-DMSO): MBA incorporated = 85% (calculated on the reaction mixture); $^{13}\text{C-NMR}$ (176 MHz, d-DMSO) DB 0.98.

$^1\text{H-NMR}$ (700 MHz, d-DMSO, 298K) δ ppm: 8.71, 8.64, 8.51 and 8.40 (m, 1H, $-\text{NH}\underline{\text{C}}(\text{O})-$, MBA), 6.21, 6.10 and 5.58 (m, 3H, $-\underline{\text{C}}\text{H}=\underline{\text{C}}\text{H}_2$, MBA), 4.52, 4.40 and 4.33 (m, 2H, $-\text{NH}\underline{\text{C}}\text{H}_2\underline{\text{N}}\text{HC}-$, MBA), 3.44 (m, 4H, $-\text{O}\underline{\text{C}}\text{H}_2\underline{\text{C}}\text{H}_2\underline{\text{O}}-$, EOBEA), 3.35 (m, 2H, $-\text{O}\underline{\text{C}}\text{H}_2\underline{\text{C}}\text{H}_2\underline{\text{N}}-$, EOBEA), 2.62 (m, 4H, $-\text{O}\underline{\text{C}}\text{H}_2\underline{\text{C}}\text{H}_2\underline{\text{N}}(\underline{\text{C}}\text{H}_2\underline{\text{C}}\text{H}_2\underline{\text{C}}(\text{O})-)_2$) 2.49 (m, 2H, $-\text{O}\underline{\text{C}}\text{H}_2\underline{\text{C}}\text{H}_2\underline{\text{N}}-$ EOBEA), 2.16 ppm (m, 4H, $-\text{O}\underline{\text{C}}\text{H}_2\underline{\text{C}}\text{H}_2\underline{\text{N}}(\underline{\text{C}}\text{H}_2\underline{\text{C}}\text{H}_2\underline{\text{C}}(\text{O})-)_2$).

$^{13}\text{C-NMR}$ (176 MHz, d-DMSO, 298K) δ ppm: 172.0 ($-\text{NH}\underline{\text{C}}\text{H}_2\underline{\text{N}}\underline{\text{C}}(\text{O})-$, MBA), 165.0 ($-\text{NH}\underline{\text{C}}\text{H}_2\underline{\text{N}}\underline{\text{C}}(\text{O})\text{CH}=\text{CH}_2$, MBA), 131.5 and 126.0 ($-\underline{\text{C}}\text{H}=\underline{\text{C}}\text{H}_2$, MBA), 69.9, 69.7, 69.2, 68.8 ($-\underline{\text{C}}\text{H}_2-$ EOBEA), 52.3 ($-\text{O}\underline{\text{C}}\text{H}_2\underline{\text{C}}\text{H}_2\underline{\text{N}}(\underline{\text{C}}\text{H}_2\underline{\text{C}}\text{H}_2\underline{\text{C}}(\text{O})-)_2$), 49.7 ($-\text{O}\underline{\text{C}}\text{H}_2\underline{\text{C}}\text{H}_2\underline{\text{N}}(\underline{\text{C}}\text{H}_2\underline{\text{C}}\text{H}_2\underline{\text{C}}(\text{O})-)_2$), 43.2 ($-\text{NH}\underline{\text{C}}\text{H}_2\underline{\text{N}}-$, MBA), 33.0 ($-\text{O}\underline{\text{C}}\text{H}_2\underline{\text{C}}\text{H}_2\underline{\text{N}}(\underline{\text{C}}\text{H}_2\underline{\text{C}}\text{H}_2\underline{\text{C}}(\text{O})-)_2$).

Polyaddition MBA-PriamineTM: synthesis of HPAMAM 3.

HPAMAM 3.1: in a typical reaction MBA (1.00 g, 6.50 mmol) was dissolved in 19.8 ml (10% w/v) of a methanol/THF mixture (50/50 v/v) in a 100 ml round bottom flask. PriamineTM (1.20 g, 2.16 mmol) was subsequently added to the solution. The mixture was stirred under nitrogen atmosphere at 60 °C for 72 hours. The polymer was recovered by precipitation of the mixture in cold acetone (dry ice). Yield 75%. SEC analysis (THF+1% v/v TEA): M_n 4500 g/mol, M_w 14600 g/mol, \bar{D} 3.0 (PS standards) ¹H-NMR (700 MHz, CDCl₃): %A conversion=63%; ¹³C-NMR (176 MHz, CDCl₃) DB 0.92.

HPAMAM 3.2: the reaction described above was repeated under the same conditions except the reaction was allowed to proceed for 4 days. Yield 82%. SEC analysis (THF+1% v/v TEA): M_n 5900 g/mol, M_w 24000 g/mol, \bar{D} 4.0 (conventional calibration, PS standards); ¹H-NMR (700 MHz, CDCl₃): %A conversion=60% ¹³C-NMR (176 MHz, CDCl₃) DB 0.95.

HPAMAM 3.3: the synthesis of PAMAM 3 was also carried out at 60°C in methanol/ArlasolveTM (50/50% v/v). The mixture was precipitated after 30 hours in cold acetone. Yield=75%. SEC analysis (THF+1% v/v TEA): M_n 3100 g/mol, M_w 19500 g/mol, \bar{D} 5.5 (PS standards). ¹H-NMR (700 MHz, CDCl₃): %A conversion = 60%; ¹³C-NMR (176 MHz, CDCl₃) DB 0.90.

¹H-NMR (700 MHz, CDCl₃, 298K) δ ppm: 8.50 and 8.19 (m, 1H, -NH \underline{C} (O)-, MBA), 6.21, 6.10 and 5.50 (m, 3H, -CH=CH₂, MBA), 4.59, 4.51 and 4.43 (m, 2H, -NHCH₂NHC-, MBA), 2.58 (m, 4H, -N(CH₂CH₂C(O)-)₂), 2.30 (m, 2H, -CH₂N(CH₂CH₂C(O)-)₂), 2.27 (m, 4H, -N(CH₂CH₂C(O)-)₂), 1.15 (m, -CH₂- PriamineTM), 0.75 (m, 6H, CH₃- PriamineTM).

¹³C-NMR (176 MHz, CDCl₃, 298K) δ ppm: 173.5 (-NHCH₂NHC(O)-, MBA), 165.5 (-NH \underline{C} (O)CH=CH₂, MBA), 130.5 and 127.0 (-CH=CH₂, MBA), 53.2 (-CH₂N(CH₂CH₂C(O)-)₂), 49.5 (-N(CH₂CH₂C(O)-)₂), 44.3 (-NHCH₂NH-, MBA), 33.3 (-N(CH₂CH₂C(O)-)₂), 31.8, 30.0, 27.5, 26.0, 22.5 (-CH₂- PriamineTM), 14.0 (CH₃- PriamineTM).

4.3.4 Stability test*Stability of the HPAMAM 1.7 polymer in water*

1% w/v and 18% w/v solutions of HPAMAM 1.7 were prepared in water. Aliquots of each solution were periodically withdrawn for SEC and ¹H and ¹³C-NMR analysis to determine the molecular weight and the presence of decomposition products.

Stability of the HPAMAM 1.7 polymer upon storage in a desiccator at different relative humidity

0.5 g of the bulk polymer HPAMAM 1.7 was stored in a desiccator at varying relative humidity, where humidity was controlled by using aqueous solutions saturated with specific salts⁴⁰:

Table 4.2 Relative humidity (RH) values at 25°C corresponding at different saturated solution.

Saturated salt solutions	P ₂ O ₅	LiCl·H ₂ O	Mg(NO ₃) ₂ ·6H ₂ O	Pure water
% RH (T=25°C)	0	12.0	53.4	100

The relative humidity values indicated in Table 4.2 were not determined under the experimental conditions used for the analysis, therefore the RH values shown above should be considered as qualitative and indicative rather than quantitative.

SEC analysis and ¹H and ¹³C-NMR were periodically used to monitor the molecular weight of the polymer and the gel fraction was estimated by SEC analysis for the sample exposed at RH 53.4% for 1, 3 and 7 days by preparing 25 ml solutions at known concentrations of the polymer in DMF. The solution was stirred overnight to dissolve the soluble fraction and the insoluble gel fraction removed by filtration. The concentration of the soluble fraction was estimated to be 100% after 1 day, between 92-85% (depending on the method used for the calculation of the gel fraction - see below) after 3 days and between 80-60% after 7 days.

4.4 Results and Discussion

Herein the synthesis of hyperbranched poly(amido amine) polymer (HPAMAM) using the “A₂ + B₄” strategy is discussed. Three series of polymers with different backbones were synthesised by using different starting monomers, wherein the same A₂ monomer (MBA) was used in all cases while the B₄ monomer was systematically changed. The B₄ monomers used were: EDA, EOBEA and PriamineTM. The three series of polymers are labelled according to the relative structure as: HPAMAM 1 (poly(MBA-EDA)), HPAMAM 2 (poly(MBA-EOBEA)) and HPAMAM 3 (poly(MBA-PriamineTM)) (Figure 4.4).

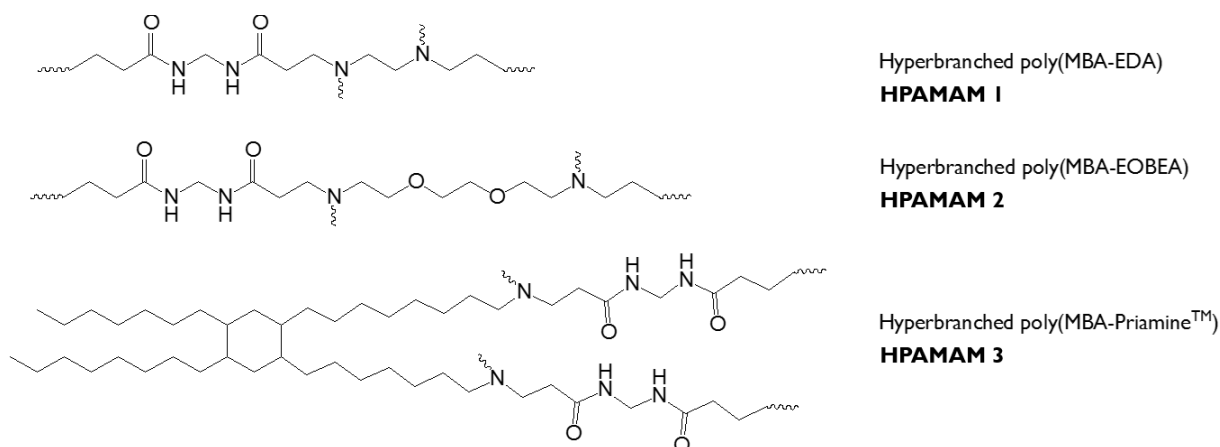
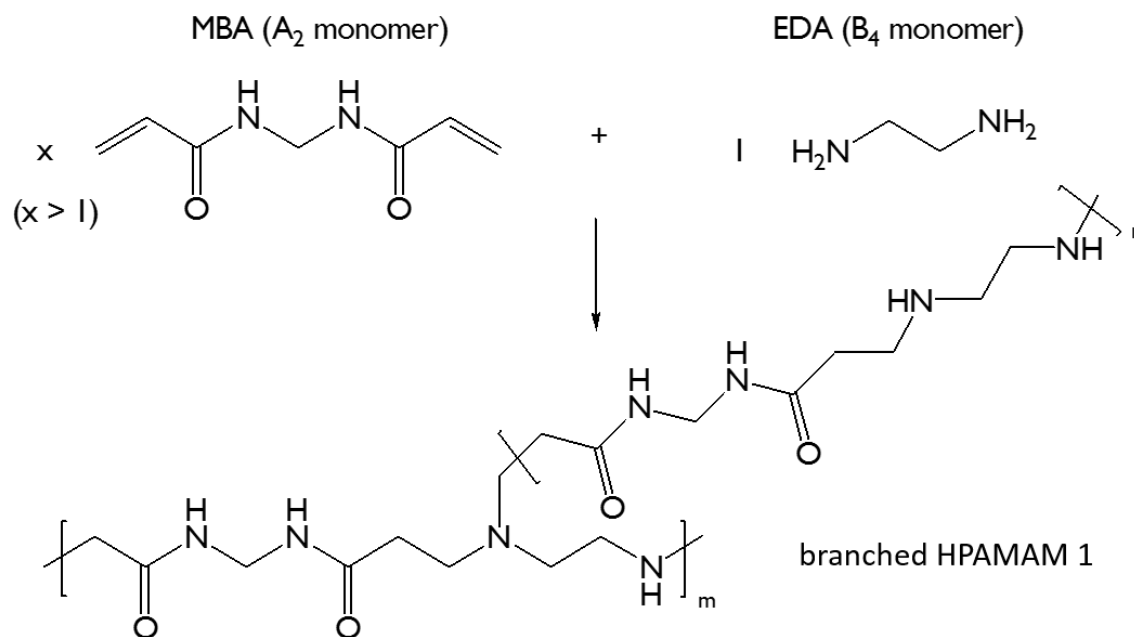

Figure 4.4 Series of polymers synthesised by Michael addition polymerisation with different stating monomers.

4.4.1 Synthesis of hyperbranched poly(MBA-EDA)s HPAMAM 1 via aza-Michael addition.

Hyperbranched poly(amido amine) HPAMAM 1 samples were obtained by a one-pot reaction of methylene bisacrylamide (MBA) and ethylenediamine (EDA) (Scheme 4.4). MBA is an A_2 -monomer having two acrylamide groups while EDA is a B_4 -monomer with two primary amine groups. Soluble (uncrosslinked) hyperbranched polymers can be synthesised by using a suitable molar ratio of A_2 : B_4 monomers and appropriate reaction conditions to inhibit the formation of gel product.



Scheme 4.4 Synthesis of HPAMAM 1 via Michael addition polymerisation of MBA and EDA monomers.

4.4.1.1 Structure and characterisation of the polymer

The polymerisation reaction shown in Scheme 4.4 was carried out in methanol/water (70/30 v/v) - since the Michael addition is promoted by protic solvents (section 4.1)^{2,34}. The monomer concentration used was 18% w/v because at higher concentrations the solid MBA-monomer does not dissolve completely in the reaction solvent and the polymerisation does not proceed well in a heterogeneous phase. Moreover, in the present study it was observed that the reaction does not proceed in the bulk, since the EDA_(liquid)-MBA_(solid) are immiscible. The reaction therefore requires (i) the use of solvents and (ii) that both monomers are fully soluble in the reaction media.

The solution polymerisation of MBA and EDA was carried out under various conditions with a view to optimisation (Scheme 4.4) of, in particular, the effect of (i) monomer molar ratio, (ii) temperature (iii) reaction time and (iv) nature of solvents used. The progress of the reactions was followed by extracting a small sample of the reaction mixture at various times and carrying out analysis on the intermediate product without purification. SEC analysis was carried out to establish the molecular weight and dispersity, ¹H-NMR to calculate the conversion of acrylamide (A) groups and ¹³C-NMR to estimate the degree of branching. A typical ¹H-NMR and ¹³C-NMR spectra of the product analysed after 24h (without purification) at 40°C, with a molar feed ratio MBA:EDA of 3:1 is shown in Figure 4.5. The molecular weights were calculated using a conventional calibration curve generated using linear PEO standards and for this reason the data obtained may significantly underestimate the actual molecular weight, since branched polymers have smaller hydrodynamic volumes than linear polymers of similar molecular weight. The results are included in the next sections.

The percentage of MBA units incorporated into the polymer was calculated by ¹H-NMR analysis of the impure product, which also contains unreacted starting materials (Figure 4.5 (i)), by using the area of the methylene proton peak *d* of MBA (see structure on the top of the Figure 4.5 and relative ¹H-NMR spectrum in Figure 4.5 (ii)). This signal moves to a lower chemical shift following reaction of the vinyl group. In particular, from Figure 4.5(i), it can be observed that the polymerisation reaction mixture results in the presence of three different methylene signals peaks: *d* at 4.55 ppm for the methylene protons of the MBA monomer; *d'* at 4.45 ppm of the methylene protons of the terminal units of the polymer in which only one vinyl group of the MBA monomer has reacted (see structural units on the top of the Figure 4.5); *d''* at 4.37 ppm corresponding to the methylene protons of the backbone units, that is when both of the acrylamide functionalities of MBA have reacted. It is worth noting from Figure 4.5 that a similar

observation can be made about the amide proton *c* of MBA which appears at 8.76 ppm in the starting material (Figure 4.5 (ii)) but appears as three separate signals (*c*, *c'*, *c''*) in the reaction mixture (Figure 4.5 (i)).

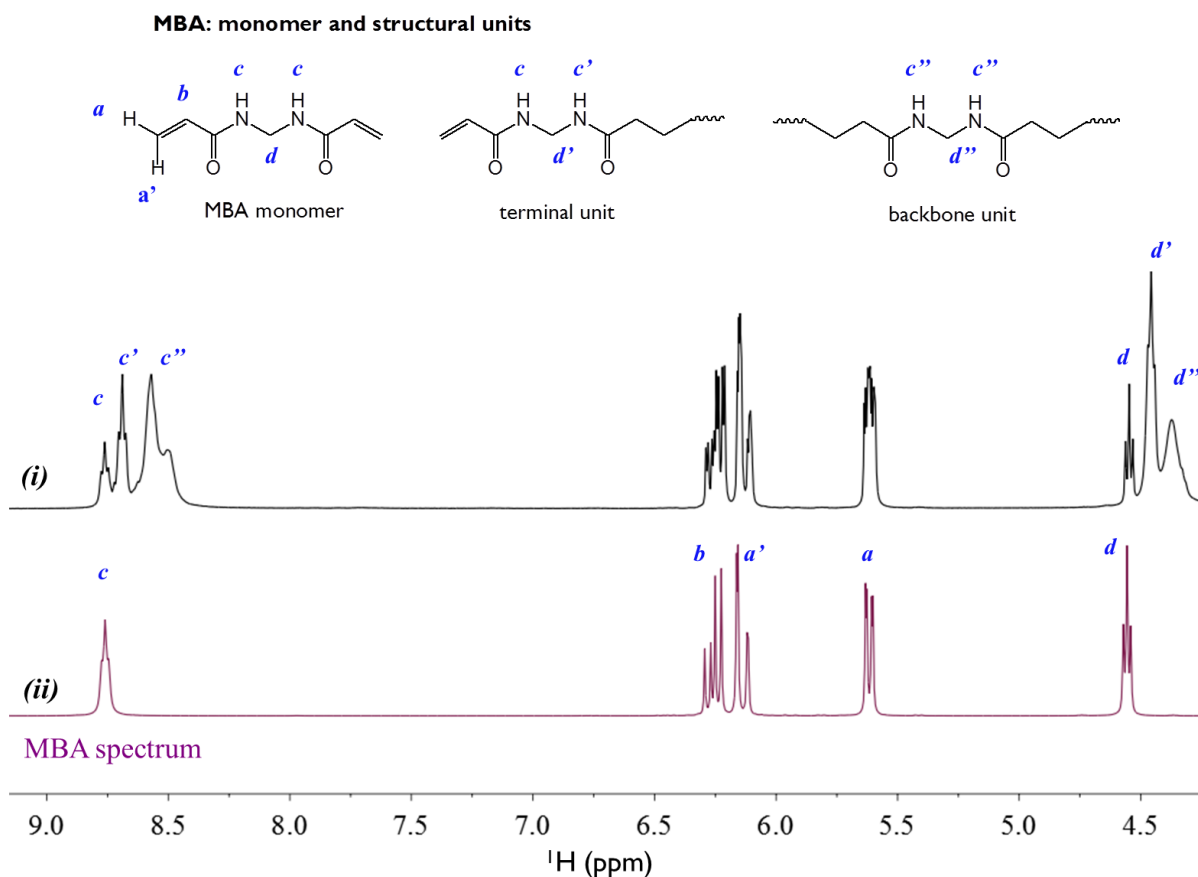

Figure 4.5 $^1\text{H-NMR}$ spectra (700MHz, d-DMSO) of (i) the reaction mixture (analysed without purification) of the polyaddition 3MBA-1EDA (HPAMAMA 1.7) at 40°C in methanol/water after 24h; (ii) MBA (A_2) monomer.

Thus the percentage of MBA units incorporated in the polymer can be calculated as follow:

$$\% \text{ MBA} = \frac{I_{d'} + I_{d''}}{I_d + I_{d'} + I_{d''}} \cdot 100 \quad \text{Equation 4.2}$$

The presence of the three methylene peaks suggests incomplete acrylamide reaction when the diacrylamide (A_2) monomer is in stoichiometric excess with respect to the B_4 monomer. The change in position of the proton peak *d* as well as the broadening of the peaks *d'* and *d''* at 4.45 and 4.37 ppm supports the polyaddition of the MBA with EDA.

Alternatively, the polymerisation reaction can be followed by calculating the percentage of unreacted vinyl A groups. In this case, the calculation has to be carried out according to the area of the vinyl protons (*a*, *a'*, *b* between 5.53 and 6.32 ppm) with respect to the total area of the methylene proton peaks *d*, *d'*, *d''* between 4.37 and 4.55 ppm (Equation 4.3).

$$\% \text{ A conversion} = \left[1 - \frac{I_{5.53-6.32}}{I_{4.37-4.55} \cdot 3} \right] \cdot 100 \quad \text{Equation 4.3}$$

In order to define the structure of the synthesised polymers, the degree of branching has to be determined. The possible structural units making up the polymer are shown in Figure 4.6. The identification of the branched and linear units was possible thanks to the synthesis of lightly branched (where the linear units predominates and hence can be easily identified) and highly branched polymers (HPAMAM 1.1 and HPAMAM 1.5 respectively) from the same starting monomers (discussed in the section 4.4.1.2).

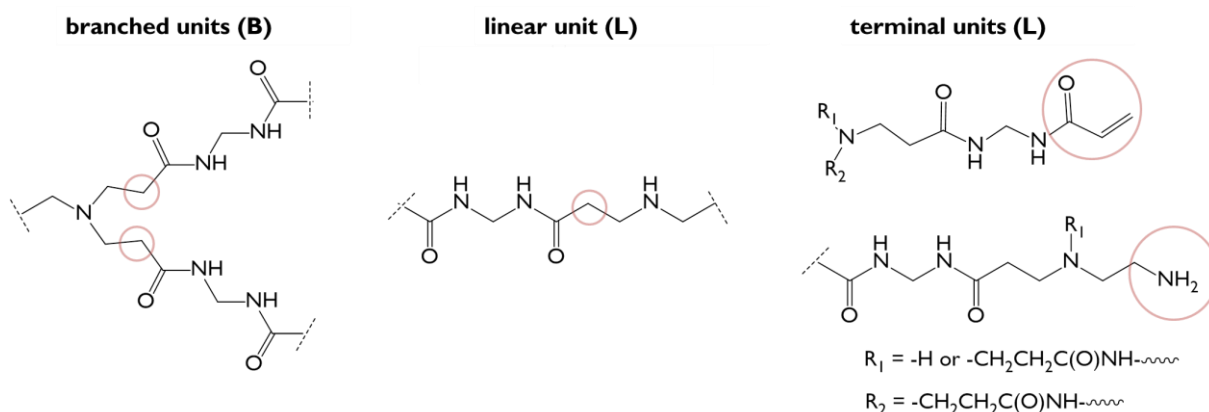

Figure 4.6 Structural units of the hyperbranched poly(amido amine) HPAMAM 1 obtained from the reaction MBA-EDA

The degree of branching of the resulting polymers was calculated using the equation proposed by Frey (Equation 4.4) according to Method 2 described in Chapter 3 (section 3.4.1.1) which uses the chemical shift of the carbon methylene group in the beta position with respect to the amine groups of the polymer (encircled in Figure 4.6). These results are reported in the coming sections.

$$\text{DB}_{\text{Frey}} = \frac{2B}{2B + L} \quad \text{Equation 4.4}$$

4.4.1.2 Effect of the molar feed ratio on the polymerisation reaction

The effect of the monomer molar ratio on the solution polymerisation (methanol/water 70/30 v/v) of MBA with EDA (Scheme 4.4) was studied at room temperature with a total monomer solution concentration of 18% w/v. The molar ratios of A₂:B₄ studied were 1:1, 1.2:1, 1.5:1, 2.5:1 and 3:1 such that the ratios of functional groups A:B were respectively: 2:4, 2.4:4, 3:4 (excess of N-H groups), 5:4 and 6:4 (excess of acrylamide groups). The progress of these reactions was followed by collecting samples at various times (without purification) from the

reaction mixture and analysis by SEC analysis and NMR spectroscopy – the results are summarised in Table 4.3. It is worth noting that the molecular weight values obtained by SEC analysis are relative to a calibration curve constructed using linear PEO standards. The use of linear polymer standards such as PEO is likely to lead to a significant underestimation of the actual molecular weight of the synthesised hyperbranched polymers for reasons mentioned above. Although this represents a limitation, the method is adequate because it enables a qualitative study of the effect of the reaction conditions on polymerisation reaction.

Molar ratio A₂:B₄ of 1.2:1 and 1.5:1

The polymerisation between MBA and EDA with molar ratios A₂:B₄ of 1.2:1 and 1.5:1 led in both cases to the formation of low molecular weight oligomers in the first 3 hours of reaction (SEC analysis in Table 4.3) which was followed by an rapid increase in viscosity and finally to gelation in less than 10 hours (5h for HPAMAM 1.2 and 6h for HPAMAM 1.3).

Table 4.3 Characterisation data of the intermediate products (analysed without purification) of the polyadditions MBA-EDA carried out with different molar ratios in methanol/water (70/30 v/v) at 18%w/v and at RT.

sample	A ₂ :B ₄	time (h)	M _n ^a	M _w ^a	Đ ^a	experimental	DB ^c	theoretical	
						% A reacted ^b		p _A ^C	p _A ^{FS}
HPAMAM 1.1	1:1	24	350	3800	10.0	-	-	100	81
		72	350	3850	10.0	100	0.15		
HPAMAM 1.2	1.2:1	3	150	190	1.2	-	-	92	71
		4.5	-	-	-	95	0.25		
		5	gel product						
HPAMAM 1.3	1.5:1	3	150	250	1.5	40	0.15	83	66
		5	450	2000	4.5	90	0.35		
		6	gel product						
HPAMAM 1.4	2.5:1	< 24	gel product					70	51
		24	280	850	3.0	-	-		
HPAMAM 1.5	3:1	48	650	7850	12.0	-	-	67	47
		72	750	11500	15.0	65	0.95		

^a calculated by DMF SEC analysis with PEO as standards; ^b calculated by ¹H-NMR according to the Equation 4.3;

^c calculated by ¹³C-NMR according to Equation 4.4.

The products of the reactions with molar ratio A₂:B₄ of 1.2:1 and 1.5:1 are identified as HPAMAM 1.2 and HPAMAM 1.3 respectively. For HPAMAM 1.3, a significant increase of the molecular weight was observed after 5 hours before the formation of the gel product (Table 4.3) and although HPAMAM 1.2 was not further analysed before gelation, the evolution of molecular weight prior to the gel point of this sample is expected to be similar to that observed for HPAMAM 1.3. Prior to gelation, NMR spectroscopy data indicated a high conversion of acrylamide groups (95% for HPAMAM 1.2 after 4.5 hours and 90% for HPAMAM 1.3 after 5 hours) and a moderately branched polymer with a DB of 0.25 for HPAMAM 1.2 and 0.35 for

HPAMAM 1.3. It is worth recalling that values of DB for hyperbranched polymers are commonly in the range of 0.40-0.60 while linear and dendrimer are characterised by DB = 0.00 and 1.00 respectively. The obtained values of DB are expected from the molar ratios used, which correspond to an excess of N-H groups (A:B is 2.4:4 for HPAMAM 1.2 and 3:4 for HPAMAM 1.3).

Molar ratio A₂:B₄ of 1:1

A soluble polymer HPAMAM 1.1 was obtained when the molar ratio A₂:B₄ was 1:1; the polyaddition proceeds in this case, without risk of gelation. The molecular weight values for sample HPAMAM 1.1 (Table 4.3) show that the reaction reached completion after 24 hours and for this reason the molecular weight remains unchanged after 72 hours. Moreover, completion of the reaction is confirmed by the absence of residual vinyl signals of the acrylamide monomer in the ¹H-NMR spectrum. The resulting polymer had a DB of 0.15 suggesting a prevalence of linear units rather than branched units (Figure 4.7, left side) due to the use of an excess of N-H groups (ratio acrylamide:N-H groups is 2:4).

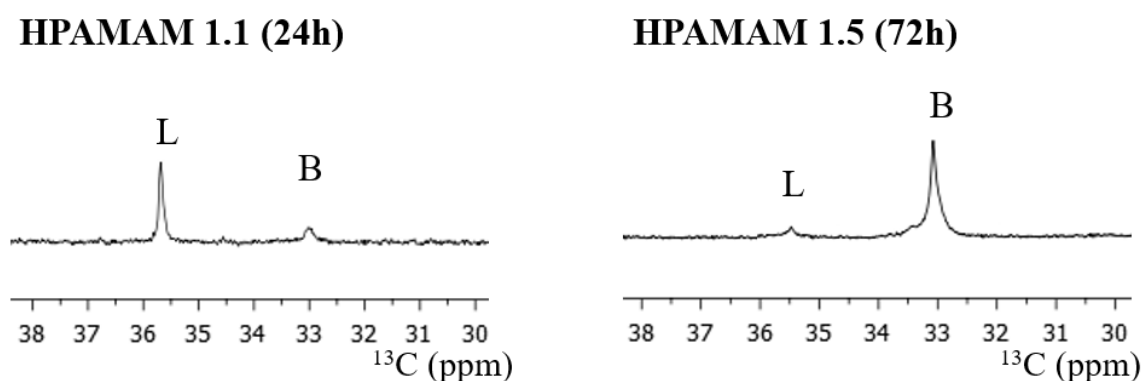

Figure 4.7 Enlargement of the carbon region typical for the branched (B) and linear (L) units.

Molar ratio A₂:B₄ of 2.5:1 and 3:1

When a molar ratio of MBA:EDA of 2.5:1 and 3:1 were used, different results were obtained albeit if the polymerisations proceed in both cases with an excess of acrylamide groups. In fact the reaction with A₂:B₄ of 2.5:1 led to the formation of a gel product (HPAMAM 1.4) in less than 24 hours while the polyaddition MBA-EDA with A₂:B₄ of 3:1 proceeds without risk of gelation and with the formation of a soluble, branched polymer (HPAMAM 1.5) as shown in Table 4.3. This result provides experimental evidence that the system MBA-EDA is close to the

gel point when the ratio $A_2:B_4$ is lower than 3:1. This observation is supported by Martello *et al.* who calculated theoretically the stoichiometric ratio B/A at which gelation can be avoided; such a calculation was carried out for the system N,N' -bisacryloylcystamine (CBA – A_2) and ethylenediamine (EDA – B_4) and the authors of this work found that by working with a ratio B/A of 0.3312 or $B = 0.3312 \cdot A$, a hyperbranched polymer can be obtained without the formation of a gel product². For our system (MBA-EDA) such a condition is satisfied in the polyaddition with $A_2:B_4$ being 3:1 (HPAMAM 1.5) but not in the case of $A_2:B_4$ being 2.5:1 where the ratio B/A is c.a. 0.40 and for this reason HPAMAM 1.4 forms a gel.

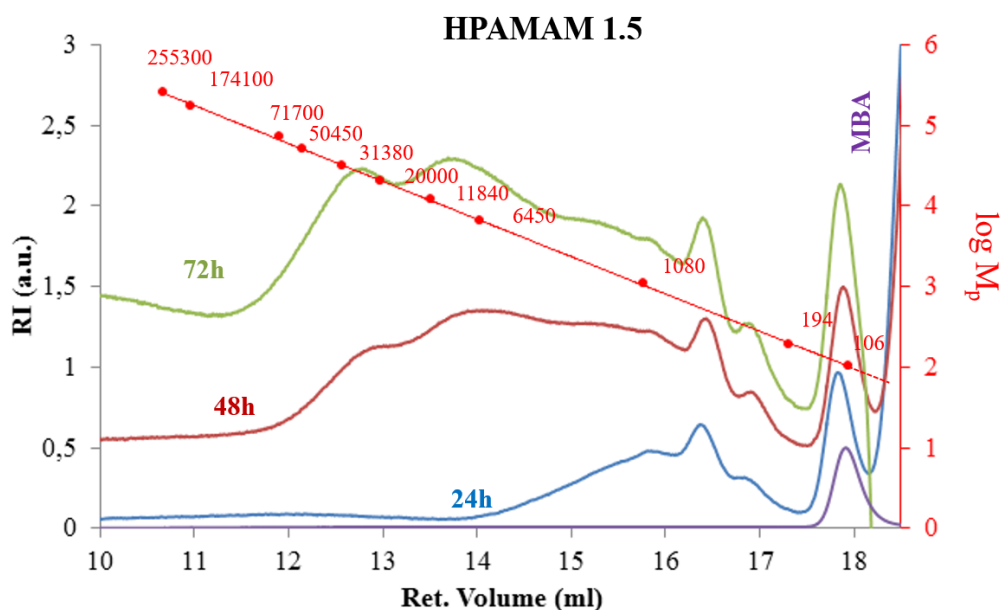

Figure 4.8 SEC chromatograms showing the increase of the molecular weight and dispersity with time for the reaction of HPAMAM 1.5 ($A_2:B_4$ 3:1) at room temperature.

The polymer HPAMAM 1.5 after 72 hours shows the formation of mainly branched units (Figure 4.7, right side) and a DB of 0.95 was calculated by ^{13}C NMR. Figure 4.7 compares the ^{13}C NMR data for samples HPAMAM 1.1 and HPAMAM 1.5 prepared with an MBA:EDA molar ratio of 1:1 and 3:1 respectively and illustrates the significant difference in the relative amounts of linear and branched units formed. The diversity in polymer structures formed can be further observed from the Mark-Houwink plots in the Appendix B, Figure B.2, obtained from the viscometer signal of the samples extracted from the polymerisation mixture after 72h (Figure B.1, Appendix B). As expected, a lower intrinsic viscosity representing a more compact and densely-branched molecule is observed for HPAMAM 1.5 with respect to HPAMAM 1.1. The higher intrinsic viscosity observed for the HPAMAM 1.1 indicates a larger and more open, less-branched molecular structure.

The SEC chromatograms of the intermediate products collected at various times for reaction HPAMAM 1.5 are shown in Figure 4.8; the chromatograms are superimposed with that of the MBA monomer to identify the excess unreacted MBA monomer.

The molecular weight values obtained for the intermediate products HPAMAM 1.5 at RT analysed without purification are presented in Table 4.3. The SEC traces, together with the values of molecular weight show that the polymerisation needs at least 48 hours to develop a polymer with high molecular weight and dispersity ($\bar{D} > 10.0$).

The reaction mixture (HPAMAM 1.5) was recovered after 3 days at room temperature in 82% yield, by precipitation in acetone and the polymer fully characterised by $^1\text{H-NMR}$, $^{13}\text{C-NMR}$ and SEC analysis. A product with M_n 3050 g/mol, M_w 15000 g/mol, \bar{D} 5.5 and DB 0.95 was recovered. It is worth remarking that a DB approaching 1 does not indicate the formation of a perfect dendrimer-like topology but rather fully-branched hyperbranched polymer with irregular growth, as shown in Figure 4.9. Hyperbranched poly(amido amine)s, prepared by a different strategy, with degree of branching approaching 1 have been previously observed by Hobson and Feast³⁵.

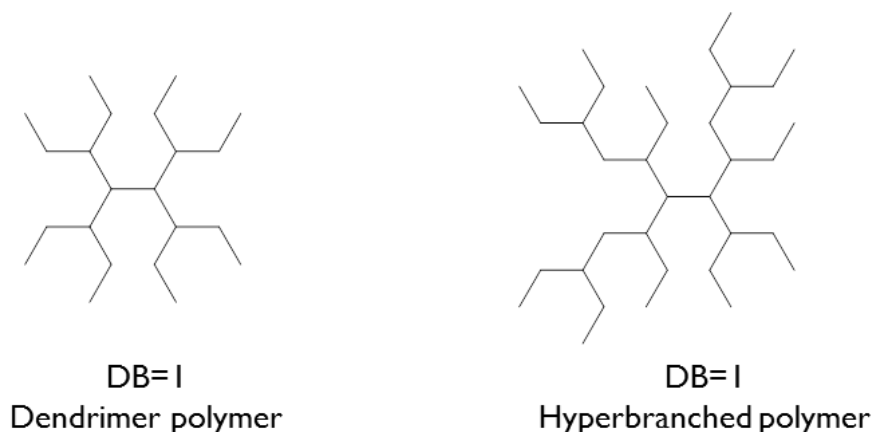

Figure 4.9 Example of different topology of polymers with DB=1.

Figure 4.10 shows the $^1\text{H-NMR}$ and $^{13}\text{C-NMR}$ of the resulting polymer and the full assignment of its structure. 2D-NMR was used for further identification of the peaks (Figure 4.11). The percentage of branched (B) and linear units (L) were calculated by quantitative $^{13}\text{C-NMR}$ according to the area of the carbon peaks 11 and 6 in Figure 4.10. The coupling in $^1\text{H},^{13}\text{C}$ -HMBC spectra in Figure 4.11 of the protons 11 and 6 with the carbonyl 3 ($^{13}\text{C-NMR}$) confirms the assignment of carbons 11 and 6 to the β -methylene of the amine groups of the polymer. All the other signals corresponding to methylene protons which are α - to the amine groups are expected between 40-55 ppm^{1,6,17}.

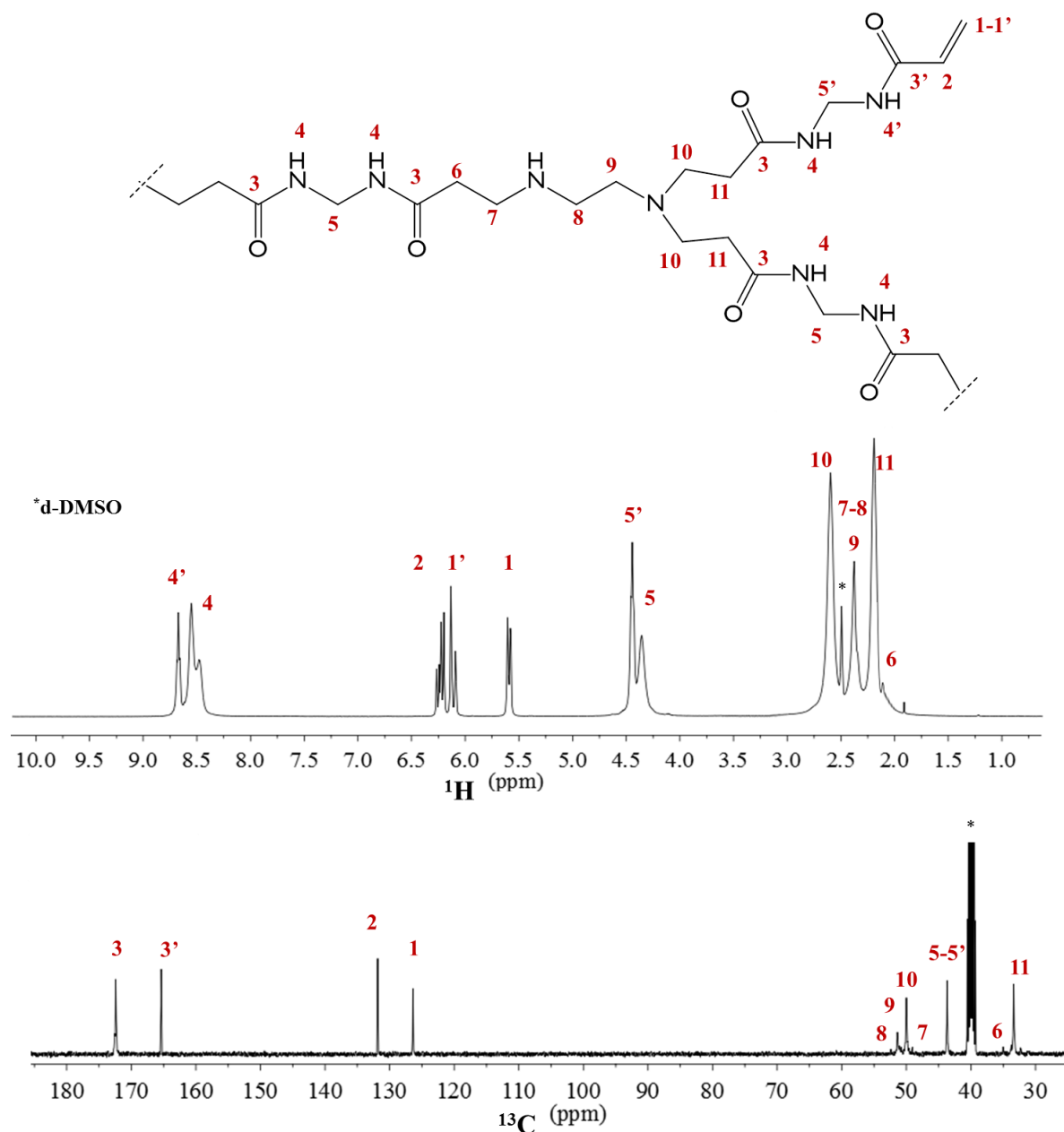

Figure 4.10 Typical ^1H -NMR and ^{13}C -NMR spectra (d-DMSO, 700MHz and 176MHz) of a branched product recovered by precipitation from the reaction HPAMAM 1.5 at RT in methanol/water after 72h.

The analysis of the polymers produced using the molar ratios discussed in section 4.4.1.2 suggests that only the reactions with molar ratio $\text{A}_2:\text{B}_4$ of 1:1 and 3:1 produce soluble polymers but with different values of DB. HPAMAM 1.5 after 72h has a significantly higher DB than the HPAMAM 1.1. It is clear therefore, and fully expected, that changing the molar ratio of the starting materials can modify the structure of the resulting polymer. Gel-free, soluble hyperbranched polymers can be synthesised using a molar ratio $\text{A}_2:\text{B}_4$ 3:1 and this ratio was hence chosen to carry out further studies.

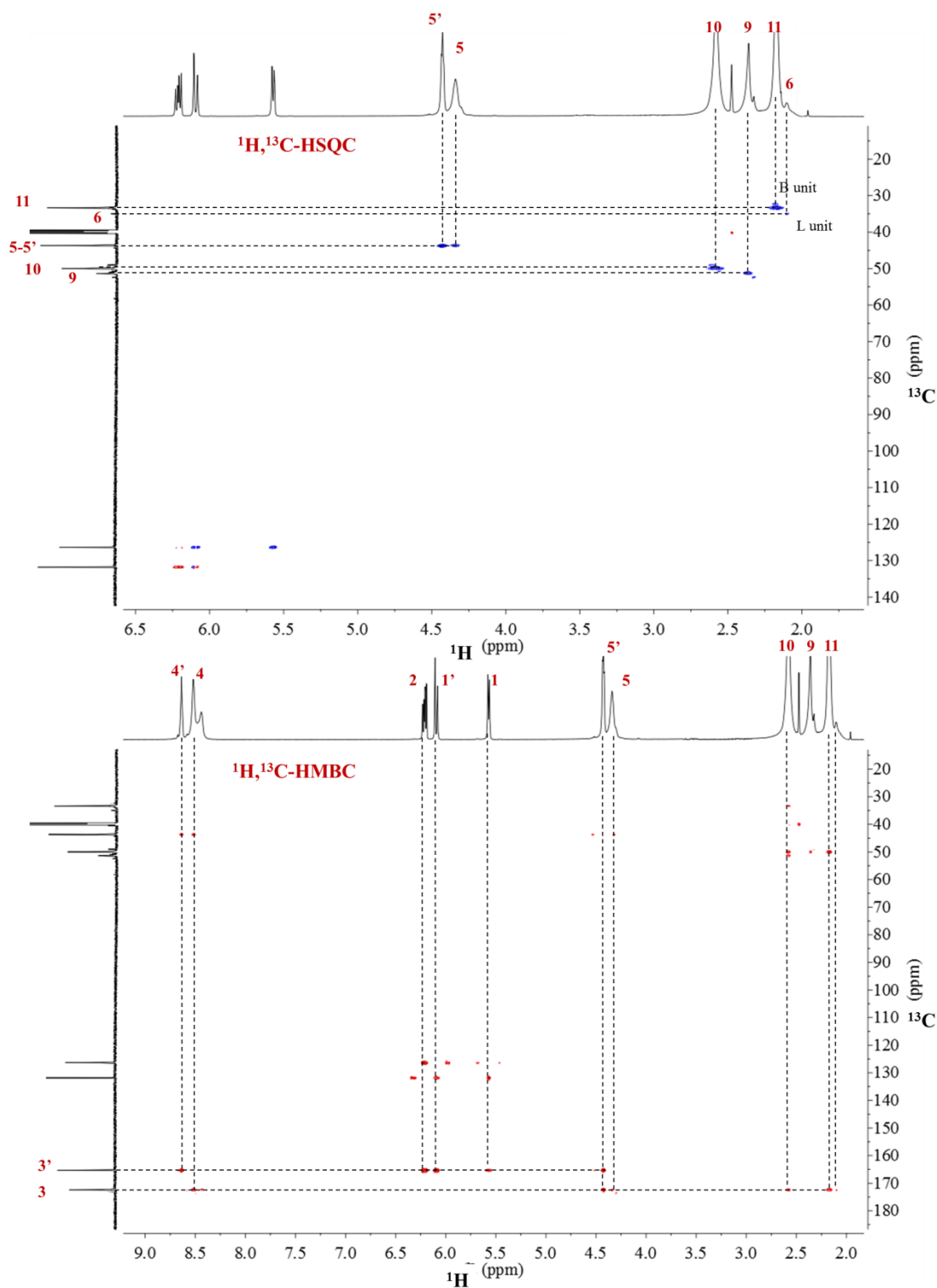

Figure 4.11 ^1H , ^{13}C -HSQC and ^1H , ^{13}C -HMBC spectra of a branched product recovered by precipitation from the reaction 3MBA+1EDA at RT in methanol/water after 72h. In the spectra the most significant coupling are showed to prove the polymer structure.

From the results in Table 4.3, a comparison between the experimental values obtained for the conversion of A groups before gelation (last sample analysed in the polymerisation reactions) and the theoretical values calculated by using Carothers and Flory-Stockmayer theory (Chapter

1, section 1.1.1) can be done. The results in the table show that the experimental values obtained by $^1\text{H-NMR}$ are unexpectedly in good agreement to the set of data predicted using the Carother's equation. Previous results showed (table 3.2) in fact that the experimental results were generally in between the two theoretical values. However, it is worth considering that the experimental results are affected by the time at which the samples are extracted from the polymerisation mixture and analysed. In fact the samples HPAMAM 1.2 and HPAMAM 1.3 were extracted from the polymerisation mixture and analysed just before gelation (Table 4.3) and their results match very well the Carothers's prediction. From the results obtained in the current work, it emerges that the Carothers's approach i.e. calculating the extent of reaction at which the number-average degree of polymerization approaches infinity ($\overline{X}_n \rightarrow \infty$), provides a better prediction of the occurrence of gelation and the gel point for the system studied in this work. Therefore it can be supposed that the system studied herein, deviates significantly from the ideal model proposed by Flory-Stockmayer and this in turn may suggest that the reactivity of all identical functional groups is not the same and independent of molecular size during the polymerisation reaction and intramolecular (cyclisation) reactions between functional groups on the same molecule do indeed occur in solution.

4.4.1.3 Polymerisation MBA-EDA (HPAMAM 1) with molar ratio 3:1

4.4.1.3.1 Synthesis of HPAMAM 1.5, HPAMAM 1.8 and HPAMAM 1.10 – the effect of the temperature

The polymerisation of MBA and EDA (3:1) in solution (methanol/water 70/30 v/v, monomers concentration 18% w/v) previously carried out at room temperature (HPAMAM 1.5) was further studied at 40° and 50°C to establish the impact of temperature on the rate and outcome of the reaction. The product of the reaction at 40 °C and 50 °C were identified as HPAMAM 1.8 and HPAMAM 1.10 respectively. The reactions were studied by analysing the intermediate products of the reactions by SEC analysis and ^1H and $^{13}\text{C-NMR}$ without any purification. The SEC samples were prepared by taking from the reaction mixture an aliquot corresponding to 1 mg and diluting with 1 ml of DMF (SEC eluent). From SEC analysis the MW values were calculated in two ways by setting the integration limits on the chromatograms as shown in Figure 4.12, that is; 1) by taking into account the whole distribution and 2) by excluding the unreacted MBA monomer from the analysis. Both sets of data are relevant because the former provides the molecular weight of the intermediate products taken from the reaction mixture without purification while the latter method enables an estimate of the molecular weight of the

products in case the reaction is stopped at a given conversion. In the following discussion we refer to the molecular weight of the products as M_n^1 , M_w^1 , \bar{D}^1 obtained by setting the limits as in 1 (Figure 4.12) and M_n^2 , M_w^2 , \bar{D}^2 by setting the limits as in 2.

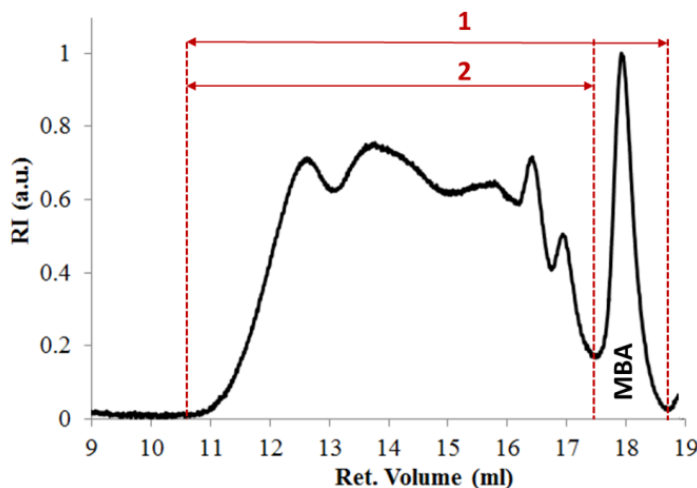

Figure 4.12 Integration limits used to calculate the MW by SEC analysis of the samples HPAMAM 1.5, HPAMAM 1.8, HPAMAM 1.10; the limits are set by taking into account 1) the whole distribution of the chromatogram is; 2) the distribution without the unreacted MBA monomer.

The molecular weight values obtained from SEC analysis (DMF + 0.1%LiBr, PEO standards) are summarised in Table 4.4. From the table it is possible to observe that, by excluding the MBA monomer (setting 2, Figure 4.12) from the distribution, the calculated molecular weight of the intermediates products is increased; the increase is more significant for M_n since M_n is more sensitive to the low molecular weight fractions.

Table 4.4 Characterisation data of the intermediate products analysed without purification for the reaction 3MBA-1EDA in methanol/water – 70/30 – studied at different reaction temperatures (RT, 40°C and 50°C).

Samples code	time (h)	T (°C)	$M_n^{1,a}$	$M_n^{2,a}$	$M_w^{1,a}$	$M_w^{2,a}$	$\bar{D}^{1,a}$	$\bar{D}^{2,a}$	%A reacted ^b	DB ^c
HPAMAM 1.5	24	RT	280	690	850	1150	3.0	1.7	-	-
	48	RT	650	1550	7840	8700	12.0	5.6	-	-
	72	RT	780	1740	11000	12000	14.0	6.8	63	0.92
HPAMAM 1.8	1	40	140	260	170	300	1.3	1.1	-	-
	5	40	240	530	930	1310	4.0	2.5	-	-
	10	40	470	1000	4130	4850	8.8	4.8	-	-
	15	40	490	1140	7360	8590	15.0	7.5	-	-
	24	40	570	1270	11950	13500	20.7	10.5	-	-
	48	40	570	1400	14700	16800	26.0	12.0	-	-
	72	40	630	1600	16600	18800	26.5	12.0	70	0.98
168	40	850	2070	48500	53050	56.8	25.6	-	-	
HPAMAM 1.10	24	50	870	1850	38400	41260	44.0	22.0	-	-
	72 (sol part)	50	1250	2050	81600	84700	65.2	41.3	65	0.97

^a with M_n and M_w in g/mol, values calculated by DMF SEC analysis with PEO as standards (1) on the whole distribution of the chromatogram and (2) on the distribution with the unreacted monomer subtracted (see Figure 4.12); ^b calculated by ¹H-NMR according to the Equation 4.3; ^c calculated by ¹³C-NMR according to Equation 4.4.

In Figure 4.13, the effect of temperature can be observed by comparing the trend of the weight-average molecular weight M_w^1 for the samples collected from the reactions at different times and analysed without purification. The errors in SEC measurements using a conventional calibration are subject to errors in reproducibility and are estimated to be c.a. 1%. The data in Figure 4.13 shows that after 24 hours the reaction at 50°C forms a polymer with highest M_w^1 (38400 g·mol⁻¹) while the reaction at room temperature showed at 24 h the lowest M_w^1 value (850 g·mol⁻¹). Therefore, the reduction of the temperature reduces the rate of the reaction with a concomitant decrease in the molecular weight of the polymer. After 72 hours the reactions at RT, 40° and 50°C produce polymers with the following molecular weights values: M_n^1 780 g/mol, M_w^1 11000 g/mol and \bar{D}^1 14.0 at RT; M_n^1 630 g/mol, M_w^1 16600 g/mol and \bar{D}^1 26.5 at 40°C; M_n^1 1250 g/mol, M_w^1 81600 g/mol and \bar{D}^1 65.2 at 50 °C. By comparing the data, it is possible to observe that an increase in the reaction temperature of only 10°C (from 40 to 50 °C) resulted in a significant increase in the molar mass and dispersity of the resulting polymer; moreover, the reaction at 50 °C occurs with such high rate of reaction that the presence of a gel fraction was observed in situ. It is worth noting that, with the exception of the gel fraction observed at high conversions at T = 50 °C, the reactions did not reach gelation during the polymerisation. The reaction 3MBA-1EDA at 40°C was carried out for 168 hours to study also the effect of reaction time which is discussed in the next section.

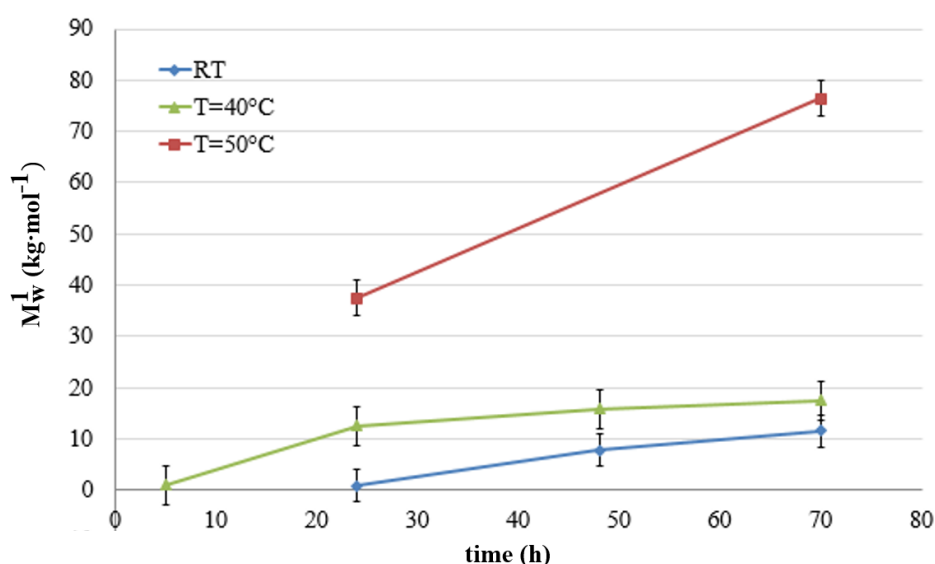

Figure 4.13 Increase of the weight-average molecular weight (calculated on the whole distribution, M_w^1) with time for the synthesis of HPAMAM 1.5, HPAMAM 1.8 and HPAMAM 1.10 at RT, 40°C and 50°C respectively.

Polymers HPAMAM 1.5, HPAMAM 1.8 and HPAMAM 1.10 were prepared using a mole ratio MBA:EDA of 3:1 at different temperatures and were also characterised by NMR to calculate the conversion of acrylamide groups and the DB value after 72 hours (Table 4.4). In all cases, highly branched structures were formed; in fact ^{13}C -NMR showed in all cases that the $\text{DB} > 0.90$ – indicating the absence or very low proportion of linear units.

The products of the reaction carried out at RT, 40°C and 50°C were recovered by precipitation in acetone, yielding a white solid product which was subsequently shown to be fully soluble in water, DMSO and DMF. The yields were 82%, 80% and 85% for the reaction carried out at RT, 40° and 50°C respectively. However, the product recovered from the reaction at 50°C contained a small gel fraction (c.a. 5% w/w calculated by dissolving the recovered product in water, separating the soluble and gel fractions by filtration and drying and weighing the insoluble part). The molecular weights of the resulting purified products were: M_n 3910 g/mol; M_w 60170 g/mol ; \bar{D} 15.3 for the soluble fraction recovered after 72 hours at 50°C; M_n 3500 g/mol; M_w 52500 g/mol; \bar{D} 15.0 after 168h at 40°C; M_n 2500 g/mol, M_w 15000 g/mol, \bar{D} 6.0 after 72 hours at RT. The temperature of 40°C was selected to carry out further analysis because it proceeded to result in a reasonably high molecular weight polymer, with a high DB and no gelation. The polymerisation at 50 °C with shorter reaction time (< 24h) might also be considered for future work.

4.4.1.3.2 Synthesis of HPAMAM 1 with molar ratio $A_2:B_4$ of 3:1: effect of the time and reproducibility of the reactions.

The reaction MBA-EDA with a molar ratio $A_2:B_4$ of 3:1 in methanol/water (70/30 v/v) was carried out at 40°C for 168 hours. The progress of the polymerisation was studied by sampling the reaction at various times and carrying out SEC analysis on the intermediate samples without purification. Samples were collected every 5 hours for the first 15h, after 24 hours and once a day up to 72 hours and a final sample was taken at 168 hours; in Table 4.4 and Figure 4.14 the molecular weight values and the RI chromatograms obtained by SEC analysis are shown. In Appendix B (Figure B.3) the RALS and DP chromatograms at different stage of the polymerisation reaction are further shown. The sampling of the reaction permitted a study of the rate of polymerisation and enables an approximate correlation between the molar mass of the resulting polymer and the reaction time.

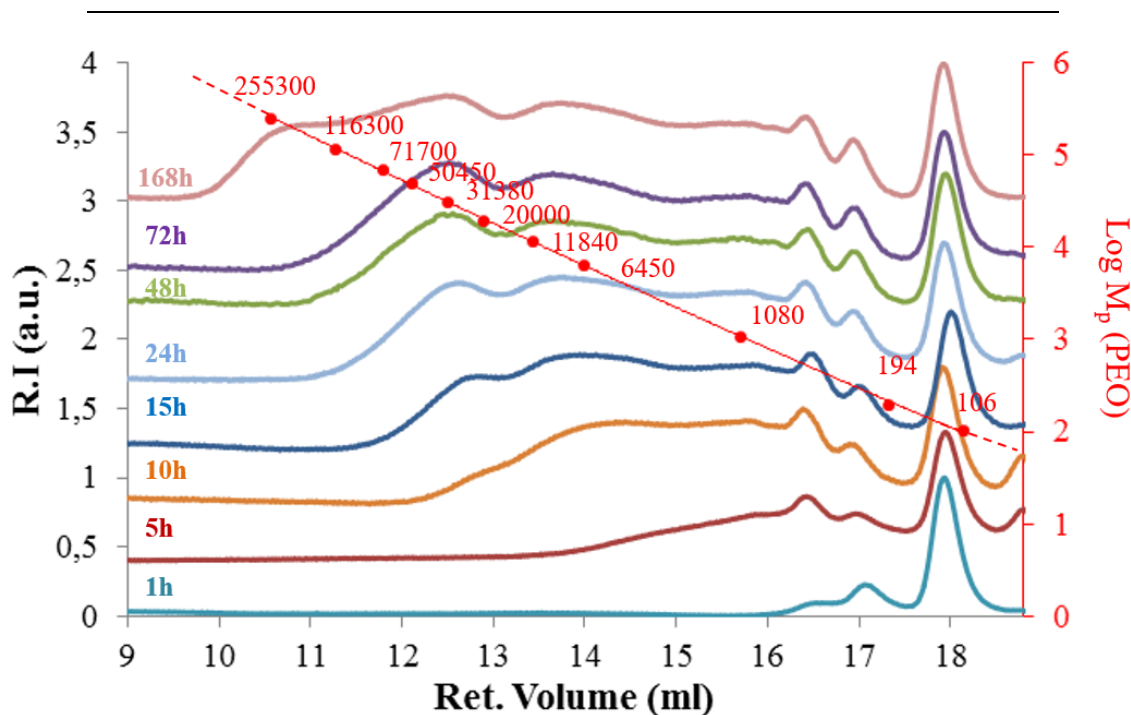

Figure 4.14 SEC chromatograms (RI detector, DMF, 0.1% LiBr) of the intermediate samples of HPAMAM 1.8 analysed without purification of the reaction 3MBA-1EDA at 40°C in methanol/water (18% w/v) at different time.

All the chromatograms in Figure 4.14 show the presence of excess unreacted MBA monomer eluted at 18ml (the chromatogram of MBA monomer). The M_w^2 and \mathcal{D}^2 values obtained during the 168 hours are plotted versus the reaction time in Figure 4.15; also in this case the errors in SEC measurements using a conventional calibration are subject to errors in reproducibility and are estimated to be 1%. The molecular weight values were analysed by excluding the unreacted monomer from the distribution and were calculated using a calibration curve of PEO standards. The M_w^2 and \mathcal{D}^2 of the resulting polymer increase rapidly in the first 24 hours then the rate of the reaction significantly decreases and a product with M_w^2 16600 g/mol and \mathcal{D}^2 12.0 is formed after 72 hours. The corresponding increase in the molecular weight distribution with the time can also be observed in Figure 4.14. In the first hours only oligomers are formed, however after 10 hours there is a noticeable increase in molecular weight and dispersity, which continues with time. At longer reaction time (168h) the polymerisation had resulted in a very HMW fraction, eluting between 10 and 11 ml (Figure 4.14). At this point, the reaction mixture had increased significantly in viscosity but no gelation was observed. However, the significant increase of the molecular weight of the polymer at 168h suggests that the polymerisation reaction still proceeds and the formation of a gel fraction can be expected at longer times (> 168h).

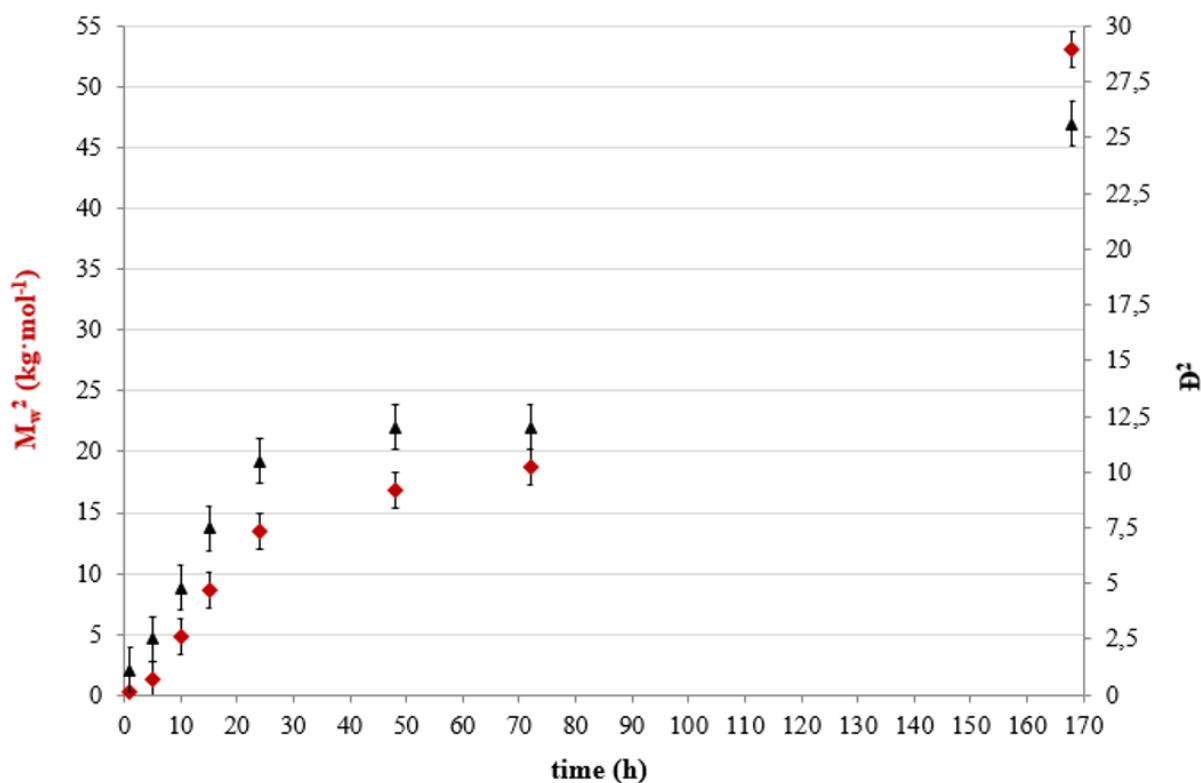

Figure 4.15 Increase of the M_w^2 and \bar{D}^2 (obtained by DMF-SEC analysis - PEO as stds - excluding the unreacted monomer from the distribution of the chromatograms) with the time of the reaction 3MBA-1EDA at 40°C in methanol/water (18% w/v).

The data shown in Figure 4.15 suggests that it should be possible to control and tailor the molar mass of the polymer, by stopping the reaction at a particular time **IF** the reaction is reproducible. Thus, the previously described reaction was subsequently repeated twice – once quenched after 10 hours and the second time after 24 hours. The quenching times were arbitrarily chosen. The products of these reactions are labelled as HPAMAM 1.6 and HPAMAM 1.7. Both products were recovered by precipitation in acetone to yield a white solid which was shown to be fully soluble in water, DMSO and DMF without any associated gel fractions. The yield of each polymer was affected by the early quenching of the reaction and was 60% for HPAMAM 1.6 and 75% for HPAMAM 1.7. In both cases, highly branched polymers were obtained and the ¹³C-NMR spectra of each indicated a predominance of branched units (DB=0.98 for HPAMAM 1.7 and 0.92 for HPAMAM 1.6). The different molecular weight values (SEC analysis, PEO as standards) of the two products HPAMAM 1.6 and HPAMAM 1.7 recovered after precipitation (purified samples in Table 4.5) confirm reasonable reproducibility of the polymerisation and the ability to control the molecular weight of the final product by the time of the reaction.

Table 4.5 Characterisation data of the polymers HPAMAM 1.6 and HPAMAM 1.7 recovered by precipitation from the reaction 3MBA-1EDA after 10 and 24 hours respectively; as comparison the significant MW values of the HPAMAM 1.7 are further reported.

sample		time (h)	$M_n^{1,a}$	$M_n^{2,a}$	$M_w^{1,a}$	$M_w^{2,a}$	$\bar{D}^{1,a}$	$\bar{D}^{2,a}$
HPAMAM 1.6	impure	10	450	1000	3250	3500	7.2	3.5
	purified		1500		4950		3.5	
HPAMAM 1.7	impure	24	620	1400	10550	12400	17.7	8.8
	purified		3250		19500		6.0	
HPAMAM 1.8	impure	10	470	1000	4130	4850	8.8	4.8
		24	570	1270	11950	13500	20.7	10.5

^a with M_n and M_w in g/mol, values calculated by DMF SEC analysis with PEO as standards ¹ on the whole distribution of the chromatograms and ² on the distribution with the unreacted monomer subtracted.

Moreover, as the polyaddition MBA-EDA is a step-growth polymerisation, the reproducibility is a feature that has to be further investigated. For this reason the values obtained for the impure samples HPAMAM 1.6 and HPAMAM 1.7 are compared in Table 4.5 with those obtained and discussed in previous section for the HPAMAM 1.8 after 10 and 24 hours (Table 4.4) (the polymer HPAMAM 1.8 was synthesised using the same reaction conditions used for HPAMAM 1.6 and HPAMAM 1.7 but the polymerisation was carried out for 168 hours). The impure products HPAMAM 1.6 and HPAMAM 1.7 (Table 4.5) do not show significant differences to those obtained for HPAMAM 1.8 and polymers with similar values of M_n^1 are obtained. The polymerisation reaction can hence be considered reproducible. Moreover, a comparison of the values in Table 4.5 shows that the precipitation of the reaction mixtures HPAMAM 1.6 and HPAMAM 1.7 results in polymers with a higher molar mass (as expected) and consequently a lower value of \bar{D} with respect to those obtained for the sample HPAMAM 1.8, by excluding the unreacted MBA monomer from the calculation of the molecular weight (M_n^2 , M_w^2 and \bar{D}^2). This likely arises due to the loss of some part of the lower molecular weight fraction upon precipitation, due to the higher solubility of low molecular weight/oligomeric species. The reproducibility and scalability of the polymerisation reaction of 3MBA-1EDA carried out in methanol/water for 24h at 40°C was further investigated in a series of reactions of increasing scale. The optimisation of the reaction had been initially carried out on a 1 g scale but was subsequently scaled to 10 g, 50 g and finally 420 g with the last two reactions being carried out in the industrial laboratories at Croda (Hull). It is worth noting that whilst scaling up the reaction, all other reaction conditions including monomer concentration, temperature, rate of stirring, volume ratio of solvents were unchanged.

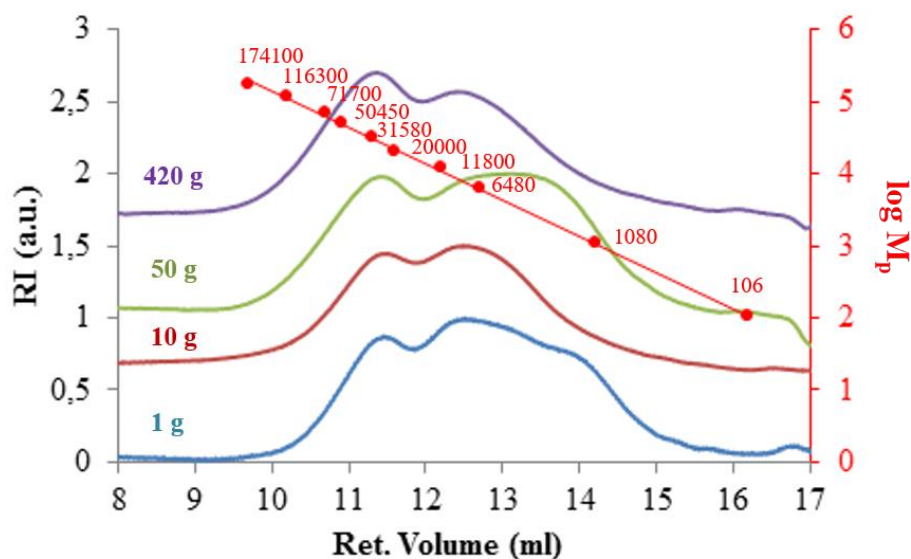

Figure 4.16 SEC chromatograms (RI detector, DMF+0.1% LiBr) of the polymer HPAMAM 1.7 synthesised by using 1 g (pale blue trace), 10 g (red trace), 50 g (green trace), and 420 g (purple trace) of the initial starting monomers.

The reproducibility of molecular weight was studied by SEC analysis (RI detector) and the results shown in Figure 4.16 and Table 4.6. In Appendix B, Figure B.4, the overlapping of the DP chromatograms of the samples is also shown. Most importantly, all of these reactions proceeded in the absence of gelation. Considering the rather random nature of the polymerisation, the results of the four reactions do not show significant variation; the polymerisation reaction can hence be considered to be both scalable and reasonably reproducible. The large volume of material produced enabled the exploration of potential applications (see Chapter 6).

Table 4.6 Molecular weigh data obtained using a conventional calibration with PEO as standards and yields of the polymers HPAMAM 1.7 synthesised at 40°C for 24h by using 1 g, 10 g, 50 g and 420 g of starting monomers (MBA and EDA)

Reaction scale (g)	M_n (g/mol)	M_w (g/mol)	\bar{D}	Yield (%)
1	3250	19500	6.0	75-80
10	5000	25000	5.0	65
50	3500	21500	6.0	78
420	4300	28000	6.5	50

The results described above clearly show that it is possible to synthesise with a good reproducibility hyperbranched polymers with high degree of branching by the “A₂ + B₄” methodology and moreover that a molar ratio A₂:B₄ of 3:1 and a mixture of methanol/water (18% w/v) as solvent proved optimal. It was found that the polyaddition proceeds efficiently at 40°C such that in 24 hours the formation of high molecular weight polymer results and most significantly, in the absence of gelation. Moreover, a study of the reaction progress with time

revealed a clear trend which provides a method for “defining” with reasonable accuracy an appropriate reaction time for a desired final molecular weight.

The molecular weight of the synthesised hyperbranched polymers has always been calculated according to the conventional calibration by using PEO as standards. The conventional calibration requires only the use of the RI detector and the concentration of the polymer solution does not have to be known accurately. As mentioned in the section 4.4.1.2, this method might be inaccurate due to the different hydrodynamic volume-molar mass relationship for the standards used compared to the branched polymer samples produced. Thus, for the polymer HPAMAM 1.7, the molecular weight was further calculated by using a triple detection (TD) (RI-IV-LS) calibration. For the synthesised polymer, this method is not as straightforward as the conventional calibration since it requires first the calculation of the dn/dc of the polymer; a value which is specific to the polymer/solvent system used (eluent DMF + LiBr). For this purpose, the concentrations of the polymer solutions used for the analysis have to be known accurately. Two samples of HPAMAM 1.7 (labelled as HPAMAM 1.7.1 and HPAMAM 1.7.2) of the same polymer, synthesised in two different reactions, were analysed. The SEC chromatograms obtained with RI and RALS detectors are shown superimposed in Figure 4.17.

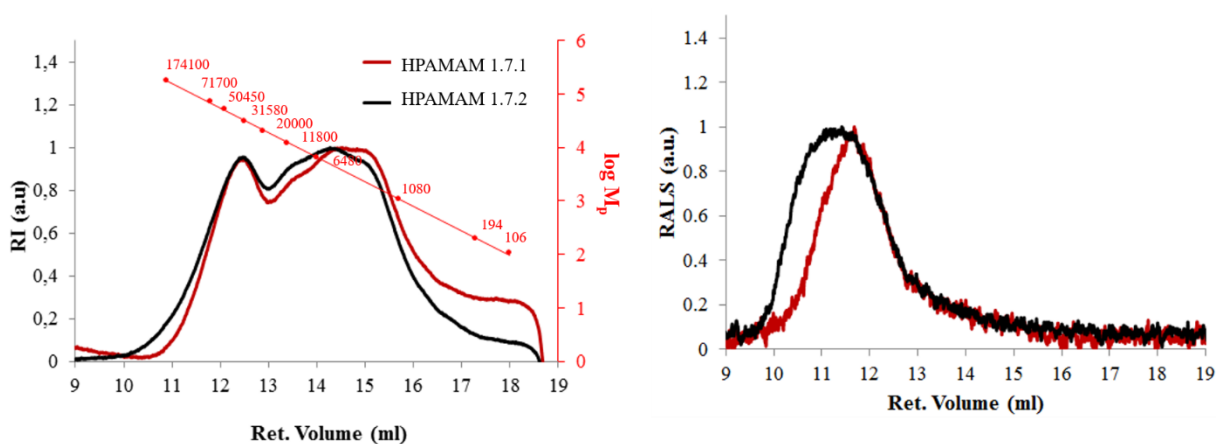

Figure 4.17 SEC chromatograms (RI detector, left side – RALS detector right side) of the HPAMAM 1.7.1 (red trace) and HPAMAM 1.7.2 (black trace).

From the comparison of the chromatograms, only small changes at low retention volume can be observed and a similar chemical composition can be assumed for the two samples. The dn/dc values obtained for the two samples are shown in Table 4.7 and represent an average of three SEC runs. In Table 4.7 the values of molecular weight calculated according to the conventional calibration (CC) and triple detectors (TD) are reported. The discrepancy in molecular weights obtained for the samples HPAMAM 1.7.1 and HPAMAM 1.7.2 with the same method is due to the small difference of the polymer distribution observed from the chromatograms Figure 4.17.

Table 4.7 Comparison of the molecular weight data calculated for the samples HPAMAM 1.7.1 and HPAMAM 1.7.2 by triple detectors (TD: RI, RALS, IV) with their specific dn/dC and by conventional calibration (CC).

Sample	Method	M_n (g/mol)	M_w (g/mol)	\bar{D}	$\langle dn/dC \rangle$ ml/g
HPAMAM 1.7.1	CC	3050	20500	7.0	0.0987 ^a
	TD	10910	100340	9.0	
HPAMAM 1.7.2	CC	3150	22550	7.5	0.105 ^b
	TD	14800	124900	8.5	

^a calculated by using a concentration C of 0.880 mg/ml; ^b calculated by using a concentration C of 1.088 mg/ml

By comparing in Table 4.7 the results obtained by using the two different methods (CC and TD), it is possible to observe that the use of the TD reveals significantly higher molecular weight values compared to those obtained by the CC and provides values that tend to be closer to the absolute molecular weight of the analysed polymer. The MW obtained by the TD is in fact calculated on the basis of the intrinsic properties of the polymer, namely the intrinsic viscosity, light scattering of the solution and the concentration of polymer solution and the values are not relative to a calibration curve of polymer standards. However, the LS detector is not very sensitive at low molecular weights and this feature may also lead to significant inaccuracies for the polymers studied in this work. In fact, from Figure 4.17, a weak RALS signal is produced for the fraction eluted between 13 and 19 ml, which is clearly visible with the RI detector. Thus, the CC method might lead to an underestimation of the real MW while the TD may lead to an overestimation. For this reason both sets of data are relevant and have to be taken into account to define the size of this type of polymer.

4.4.1.3.3 Synthesis of HPAMAM 1.9 with Arlasolve™ as solvent.

It has been shown above (Section 4.4.2.1) that hyperbranched poly(amido amine) can be successfully synthesised using a molar ratio of $A_2:B_4 = 3:1$ in a mixed protic solvent system (MeOH/water 70/30 v/v). The above described polymerisation was also attempted using a solvent widely used by Croda, namely dimethyl isosorbide (DMI) (see Figure 4.18), also known as Arlasolve™. This solvent is considered a sustainable solvent as it is obtained from starch³⁶, was produced and provided by Croda. Arlasolve™ is produced with a high purity since it is widely used for personal care and pharmaceutical applications. This solvent is miscible in all proportions with water and with a variety of other solvents including esters, alcohols and polyols. Moreover it has been found that Arlasolve™ is stable to hydrolysis, has excellent solvent properties and is able to enhance the solubility of many different active ingredients and increase their penetration into the skin^{37,38}.

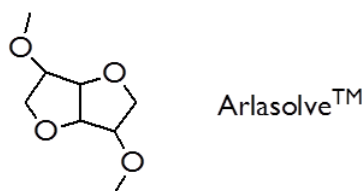

Figure 4.18 Structure of Arlasolve™.

The effect of the Arlasolve™ as a solvent for the polyaddition of MBA-EDA was studied whilst keeping all the other parameters unchanged i.e. A₂:B₄ of 3:1 at 40 °C in Arlasolve™ (18% w/v). Despite the good solvent properties mentioned above, Arlasolve™ did not turn out to be a good solvent for the MBA monomer, even at low concentrations and the polymerisation proceeded heterogeneously and resulted after 24 hours in only 25% conversion of the MBA and in the formation of a product with low molecular weight. As already mentioned in the section 4.4.1.1, the polymerisation reaction proceeds efficiently when the monomers are fully soluble and is favoured by the use of protic solvents. Therefore Arlasolve™ was subsequently used in a mixture with a co-solvent which is able to fully dissolve MBA monomer. As MBA is soluble in water, DMSO and DMF at any concentration and in methanol or in a mixture of methanol/water (70/30 v/v), at concentration $\leq 18\%$ w/v, it was decided to use water as the co-solvent. A variety of volume ratios of Arlasolve™:H₂O were used to test the solubility of MBA and its polyaddition with EDA. It was found that in order to have a homogeneous reaction and consequently allow an efficient polymerisation; (i) a volume ratio of H₂O with respect to Arlasolve™ higher than 50% v/v has to be used with a monomer concentration of 18% w/v; (ii) a volume ratio Arlasolve™:H₂O of 50:50% v/v satisfactorily solubilises the reactants at a monomer concentration of 10% w/v. The latter condition was used to study the reaction and the product of this such reaction was identified as HPAMAM 1.9.

Table 4.8 Molecular weight data (DMF SEC, RI detector, PEO standard) of the intermediate samples (impure samples) and the product HPAMAM 1.9 recovered after precipitation (purified sample after 96h) of the reaction 3MBA-1EDA at 40°C in Arlasolve™:H₂O 50:50% v/v.

time (h)	sample HPAMAM 1.9	M _n (g/mol)	M _w (g/mol)	Đ
24	impure	550	1100	2.0
48	impure	950	11200	11.5
72	impure	1500	21000	14.0
96	impure (sol fraction)	1500	36850	24.5
96	purified	3000	35000	11.5

The polyaddition 3MBA–1EDA carried out in this solvent mixture proceeded for 96 hours during which time the molecular weight of the resulting polymer increased with reaction time (Table 4.8). After 96 hours, 60% of the acrylamide groups had reacted and at such time a significant increase in the viscosity of the reaction was observed as well as the formation of a

gel fraction. The molecular weight (Table 4.8) for the sample analysed after 96 hours corresponds to the soluble fraction of this sample. The reaction was hence quenched at 96 hours by precipitation in acetone and a polymer was recovered in 75% yield. This product was redissolved, filtered and dried and a gel-free polymer was recovered in c.a. 70% yield (~ 6.5% gel fraction formed). The resulting polymer was highly branched with a DB of 0.82 and the molecular weight and the dispersity values of the resulting polymer (purified sample) are shown in Table 4.8.

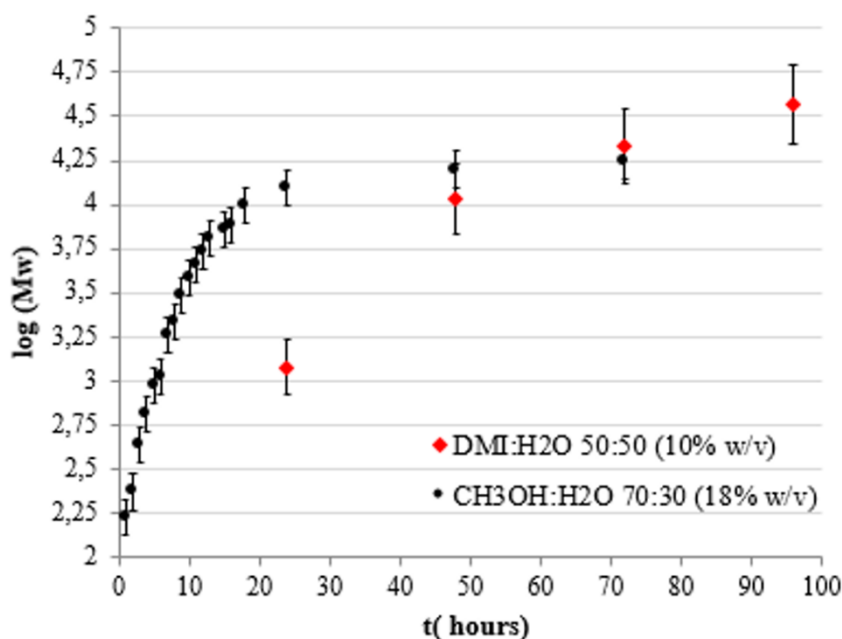

Figure 4.19 Increase of the weight-average molecular weight (logarithmic form) during the time of the polyaddition between MBA and EDA at 40°C in methanol/water (18%w/v) (black dots) and ArlasolveTM/water (10%w/v) (red dots).

In order to understand the role of ArlasolveTM on the polymerisation reaction, the M_w values of the intermediate samples collected at various times during the reaction in ArlasolveTM:H₂O were compared with those collected for the same reaction carried out in MeOH/ H₂O. The graph in Figure 4.19 shows that after 24 hours the M_w of the product formed in ArlasolveTM/H₂O is significant lower than that formed in MeOH/H₂O but similar values are reached at time ≥ 48 hours. However, the data at 96 hour represents only the soluble part of the reaction product, thus the rate of the reaction is lower in the first 24 hours but increases after such time until the eventual formation of an insoluble fraction. For these reactions the effect of the reaction conditions has to also be considered; the reaction in ArlasolveTM:H₂O was in fact carried out at a lower monomer concentration (10% w/v instead of 18% w/v) and at higher volume ratio of water (50% v/v instead of 30% v/v) with respect to the reaction in MeOH/H₂O. The lower monomer concentration would be expected to decrease the rate of the reaction while the use of

higher volume of water enhances the rate. The effect of the water is discussed in the section 4.4.1.4.1 where the stability of the polymer dissolved in water is discussed. It is clear that that the Arlasolve™ can be used as a co-solvent in place of methanol in the polymerisation reaction and allow the production of high molecular weight polymer. This result encourages future investigations with an alternative A₂ monomer which is possibly more soluble in Arlasolve™.

4.4.1.4 Stability of HPAMAM 1.7, upon long-term storage.

The results described in previous sections have shown that hyperbranched polymers can be synthesised, reproducibly and on a large scale using MBA-EDA in a molar ratio 3:1 at 40°C in methanol/water (70/30). Under these conditions, soluble polymer is produced in the absence of gelation. Having overcome the problem of gelation, the hydrolytic stability of the resulting branched poly(amido amine) (HPAMAM) polymers was studied in aqueous solution at room temperature. For this purpose polymer HPAMAM 1.7 was used. It was not possible to study the stability of the HPAMAM 1.7 in methanol, as was done for the poly(ester amine)s (Chapter 3), since all the HPAMAM 1-type polymers were not fully soluble in methanol. However, since cross-linked poly(ester amine), obtained in attempts to synthesise soluble hyperbranched polymer, underwent degradation in a similar fashion both in water and in methanol (Figure 3.17), a comparison of the stability in protic solvents of the poly(ester amine) and that of the poly(amido amine) is appropriate.

The first significant point to make when considering the hydrolytic stability of the hyperbranched poly(amido amine)s prepared in this study, is that the polymers were synthesised in a protic solvent (MeOH/Water) at 40°C. The fact that high molecular weight polymer was formed would suggest that hydrolytic stability is not a significant issue during the polymerisation. However, long term stability is still a matter of interest. Thus, the stability of the resulting polymers was studied in aqueous solution, as well as during long-term storage in different environments. The molecular weight of the polymer was monitored by SEC analysis at various times when the HPAMAM 1.7 polymer was stored in a vacuum oven, and when stored at different relative humidity.

4.4.1.4.1 Stability of the polymer in aqueous solutions.

The long term hydrolytic stability of polymer HPAMAM 1.7 in aqueous solution was studied. Aliquots of the solution were periodically removed for analysis by SEC to monitor any changes

in the molecular weight of the polymer. Two different solutions (1% w/v and 18% w/v) were prepared to study the stability of the polymer in both dilute and concentrated conditions.

Dilute aqueous solution

A 1% w/v solution of HPAMAM 1.7 in water was prepared. The pH of this solution at the beginning of the test was 8.5. Samples were removed periodically over six months for SEC analysis. Figure 4.20 shows the SEC chromatograms of the starting material ($t=0$) and the polymer after storage in water for 1 day and 60 days.

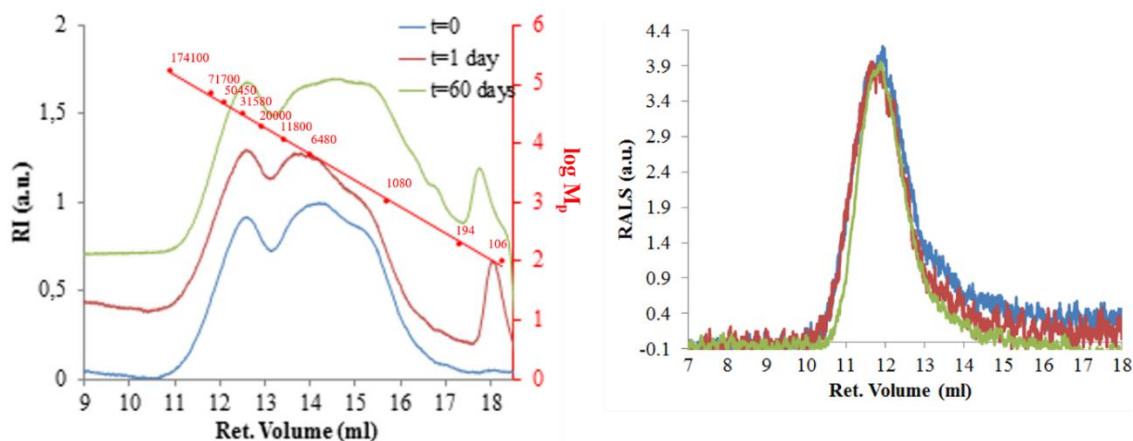

Figure 4.20 SEC chromatograms (RI detector on the left side, RALS detector on the right side) of the sample HPAMAM 1.7 ($t=0$, blue trace) and the same sample dissolved and stirred in water at 1% w/v for 1 day (red trace) and 60 days (green trace).

From the RI signals (Figure 4.20, left side) it can be observed that the dispersity increases with the time due to the formation of a low molecular weight species which eluted at 18 ml. It has been shown earlier that MBA is eluted at this retention volume. The formation of this fraction can be observed after only 24 hours and the area of this peak represent c.a. the 5% of the whole distribution. This result suggests the onset of the polymer decomposition which occurs preferably at the terminal units; in fact, if decomposition was a random process, it would also occur on the backbone of the polymer and the MW distribution should have shifted to higher RV (lower MW). After 60 days the area of the fraction eluted between 14 and 17 ml increases and this observation is an indication that at this stage, degradation starts taking place on the backbone of the polymer. A possible mechanism of decomposition is depicted and discussed below. The molecular weight data were obtained using a conventional calibration and the results reported in Table 4.9. The data show an increase of the dispersity upon prolonged storage of the polymer in aqueous solution, as a result of a significant reduction in the value of M_n .

Table 4.9 Molecular weight values (PEO standards) of the polymer HPAMAM 1.7 ($t=0$) dissolved and stirred in water at 1% w/v for 1 and 60 days.

time (days)	M_n (g/mol)	M_w (g/mol)	\bar{D}
0	3250	19500	6.0
1	1300	18000	14.5
60	1150	16500	14.0

Moreover, the sample HPAMAM 1.7 does not show any evidence of an increase in MW of the polymer over 60 days and this feature can be better observed by the RALS signals in Figure 4.20 (right side); this sensitivity of the RALS detector is proportional to molecular weight and is thus more sensitive to high molecular weight species. For this reason if an increase in MW had occurred, it would be most evident in the RALS data. However, after 6 months, a further sample was removed for analysis but the sample appeared to have undergone gelation and could not be analysed by SEC.

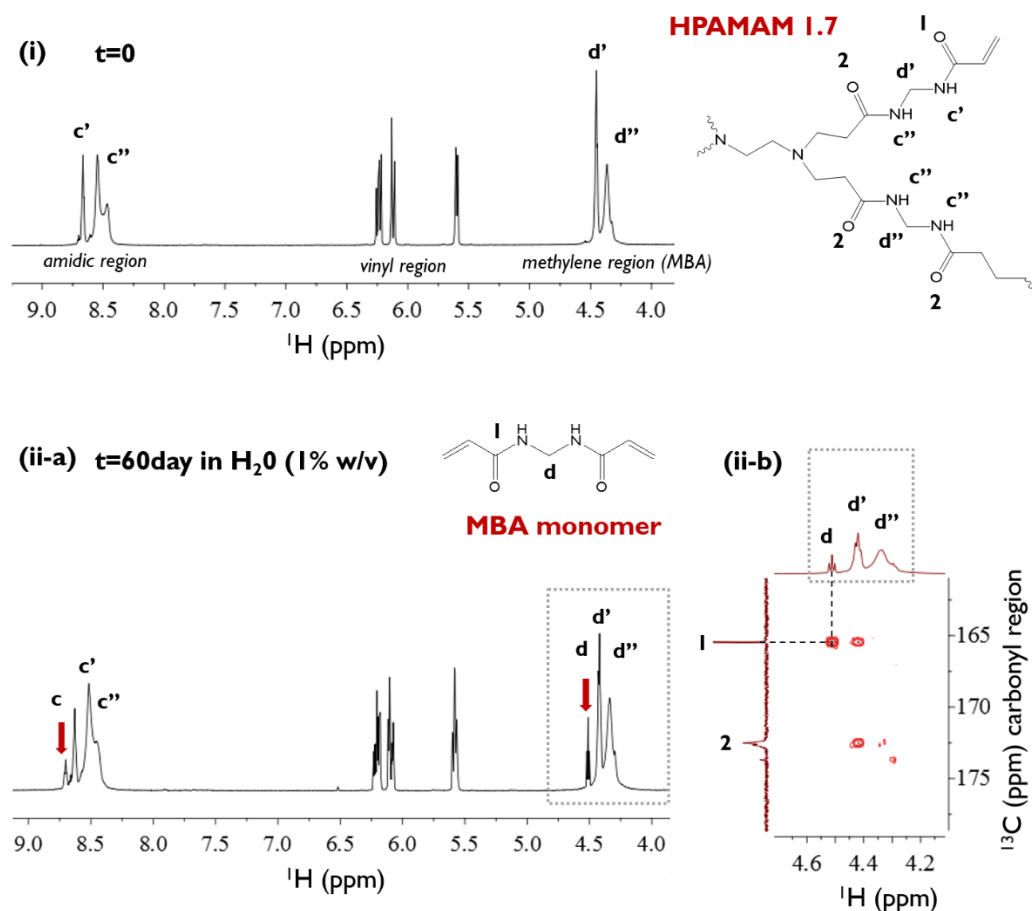
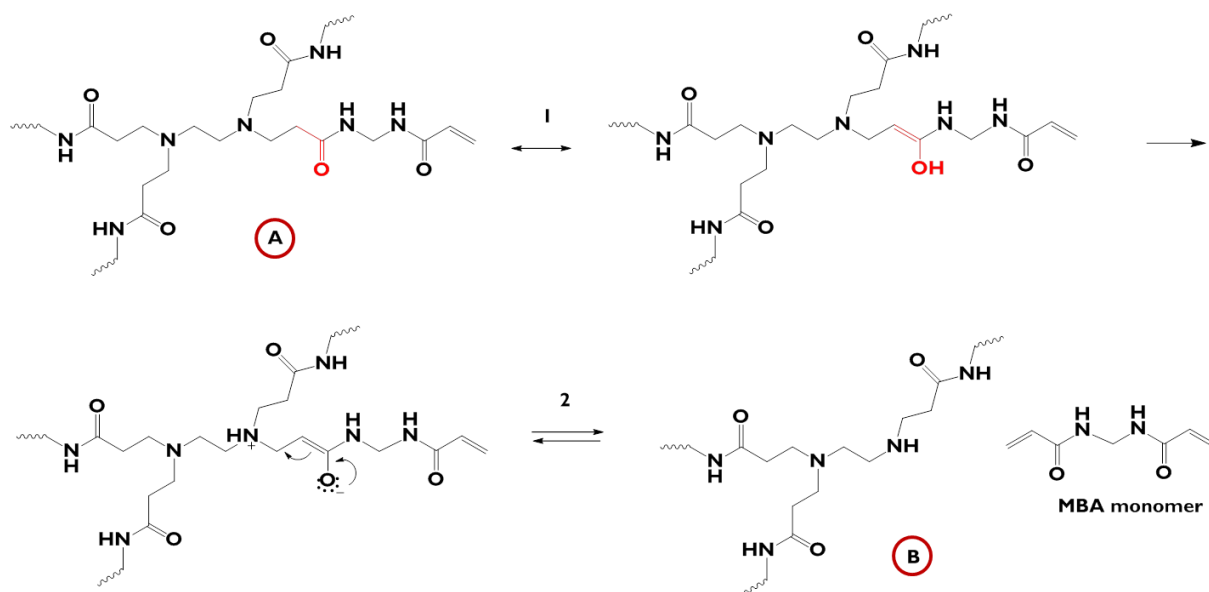

Figure 4.21 ^1H -NMR (700MHz, d-DMSO) of : (i) the polymer HPAMAM 1.7; (ii-a) the same sample after 2 months (60 days) in water at 1% w/v in which the presence of MBA is also detected. (ii-b) ^1H , ^{13}C -HMBC enlargement.

This observation suggests that in water, not only is decomposition an issue, but that chain coupling also takes place, albeit at a much lower rate compared to that at which the polymer degrades (at $t > 60$ days). The occurrence of the chain-coupling is explained by the fact that

water promotes the aza-Michael polyaddition that in this case occurs intramolecularly between the unreacted functionality of the synthesised polymer. In order to understand the mechanism of degradation, the structure of the polymer after 60 days in water at 1% w/v was investigated by $^1\text{H-NMR}$. Figure 4.21 compares the $^1\text{H-NMR}$ spectra of the sample after 60 days in water (ii-a) with that of the initial polymer ((i) $t=0$). Two new peaks at 8.72 and 4.55 ppm can be observed, indicated with red arrows in Figure 4.21 (ii-a), in the spectrum of the polymer stirred in water for 60 days. The same result but less pronounced was also observed for the sample stirred in water for 24h. These new peaks at 8.72 and 4.55 ppm correspond to the amidic proton *c* and methylene proton *d* respectively of the MBA monomer bearing both the acrylamide groups. The coupling in $^1\text{H},^{13}\text{C-HMBC}$ (Figure 4.21 (ii-b)) of the proton peak at 4.55 ppm (*d*) only with the carbon peak *l* at 165.34 ppm of the carbonyl of the unreacted acrylamide groups confirms that both the acrylamide functionalities of the monomeric unit are present and unreacted. The NMR results suggest that the decomposition of the polymer might occur via elimination reaction of the A₂ monomer. In particular, retro-Michael addition occurs most probably in water because of (1) the possibility of enolisation and (2) the existence of an equilibrium between the A form (product of the Michael addition) and B form (product of the decomposition via retro-Michael addition) shown in Scheme 4.5 of the polymer.



Scheme 4.5 Plausible degradation mechanism of the HPAMAM 1.7 polymer in water (via retro-Michael addition).

Similar results have been observed for PAMAM dendrimers when stored in methanol (5% solution) at -15°C , 4°C , RT and 50°C ³⁹. In this case decomposition was studied by gas chromatography and it has been confirmed that decomposition of PAMAM is caused by retro-Michael addition and elevated temperatures promote a shifting of the equilibrium towards the

retro-Michael reaction. At RT, in particular, the author of this previous report showed that c.a. 5 % of PAMAM is decomposed after 1 day and 15% after 20 days in methanol. These results are consistent with those obtained for HPAMAM 1.7 in water in the current study. Moreover, for hyperbranched polymer HPAMAM 1.7, decomposition is expected to start on the terminal units since these units are more accessible than the sterically hindered backbone units. Decomposition can alternatively occur via hydrolysis of the amide groups, however no evidence of this reaction was found by NMR.

The results discussed in this section suggest that long-term storage of HPAMAM polymers in dilute aqueous solution results in some decomposition however, the extent of degradation is far less than for the poly(ester amine) analogues. Moreover, the degradation appears to be concentrated in the terminal units and after initial cleavage of the terminal units to release MBA, little further degradation was observed. For this reason we can consider the polymer to be reasonably stable to degradation in water at 1% w/v. Nevertheless, it has also been mentioned that after 6 month gelation was observed on this sample.

Concentrated aqueous solution.

An 18% w/v solution of the polymer HPAMAM 1.7 in water was also prepared. The pH of this solution at the beginning of the test was 9.0. The samples were analysed periodically over 7 days by SEC analysis and the chromatograms of the polymer dissolved and stirred in water for 1 day and 7 days are shown and compared with the chromatogram of the starting polymer in Figure 4.22. The RI data (Figure 4.22, left side) reveals the emergence a significant broadening of the molecular weight distribution, to lower retention volumes/higher molecular weight with time.

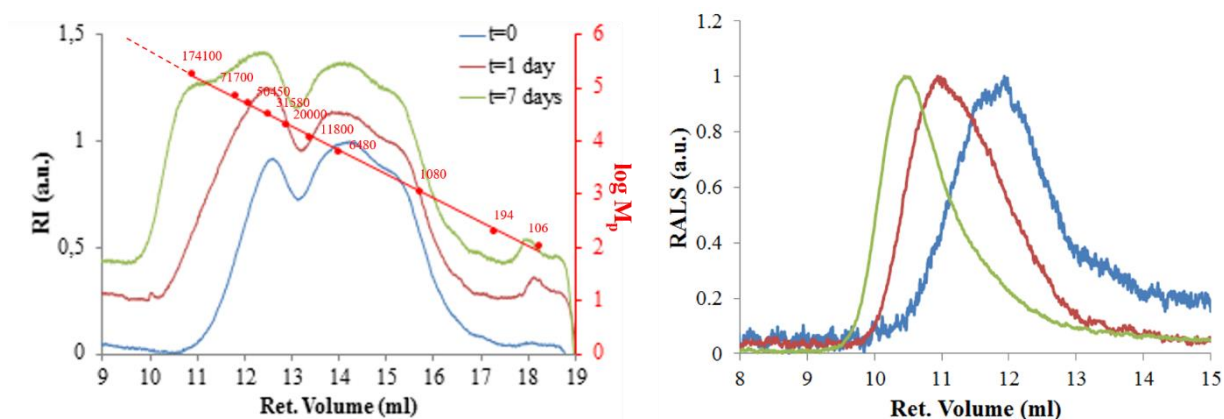

Figure 4.22 SEC chromatograms (RI detector on the left side, RALS detector on the right side) of the sample HPAMAM 1.7 ($t=0$, blue trace) when dissolved and stirred in water at 18% w/v for 1 day (red trace) and 7 days (green trace).

The molecular weight and dispersity data are presented in Table 4.10. Storage in concentrated aqueous solution results in very different behaviour to that observed in dilute conditions. Namely, the increase in the dispersity is predominantly associated with an increase of the weight-average molecular weight of the polymer due to the formation of high molecular weight species eluted between 10-11 ml. The formation of these species is even more evident when using the RALS detector to represent the SEC chromatograms (Figure 4.22, right side) and suggests that storage in concentrated aqueous solution results in further polymerisation/chain coupling and an increase in molecular weight. Unsurprisingly, the polymer underwent gelation after 8 days in water.

Table 4.10 Molecular weight values (PEO standards) of the polymer HPAMAM 1.7 ($t=0$) dissolved in water at 18% w/v and stirred $t=1$ day and 7 days.

time (days)	M_n (g/mol)	M_w(g/mol)	\bar{D}
0	3250	19500	6.0
1	4500	34650	7.5
7	4750	58300	12.0

Although chain coupling and gelation dominate the behaviour of the polymer upon storage in concentrated solution, it can also be seen from the RI chromatograms in Figure 4.22 that the formation of a low molecular weight species occurs as evidenced by a small peak eluting at 18 ml. This suggests that some degradation also occurs, however, the area of this peak in both chromatograms represents less than 1% of the total area. The sample dissolved in water for 7 days was also analysed by $^1\text{H-NMR}$. The spectrum did not indicate any significant differences to that of the starting polymer confirming the near absence of decomposition species. It is therefore clear that storage of the HPAMAM 1.7 polymer in concentrated aqueous solution conditions (i) does not lead to significant degradation but (ii) does result in further chain coupling and gelation in a short period of time.

When considering the observations made for HPAMAM 1.7 stored under both dilute and concentrated solution it is clear that the rate of degradation and chain coupling reactions depends on the solution concentration. In dilute conditions the impact of degradation is greater than the contribution of chain of coupling and vice versa in concentrated conditions. However, storage in dilute conditions results predominantly in cleavage of the terminal units in the first 24 hours with little further degradation and chain coupling only occurs to a very low extent. In contrast, storage in concentrated aqueous conditions promotes the formation of a cross-linked product in only a few days. We can consider the polymer to be relatively stable for at least 2 months in

dilute aqueous solutions and given the nature of the decomposition it might be possible to inhibit terminal group cleavage.

4.4.1.4.2 Stability of the bulk polymer in vacuo.

The stability of HPAMAM 1.7 during storage in vacuo was also studied. SEC analysis was run on samples of the dry bulk polymer after various storage times in vacuo over a period of 6 month.

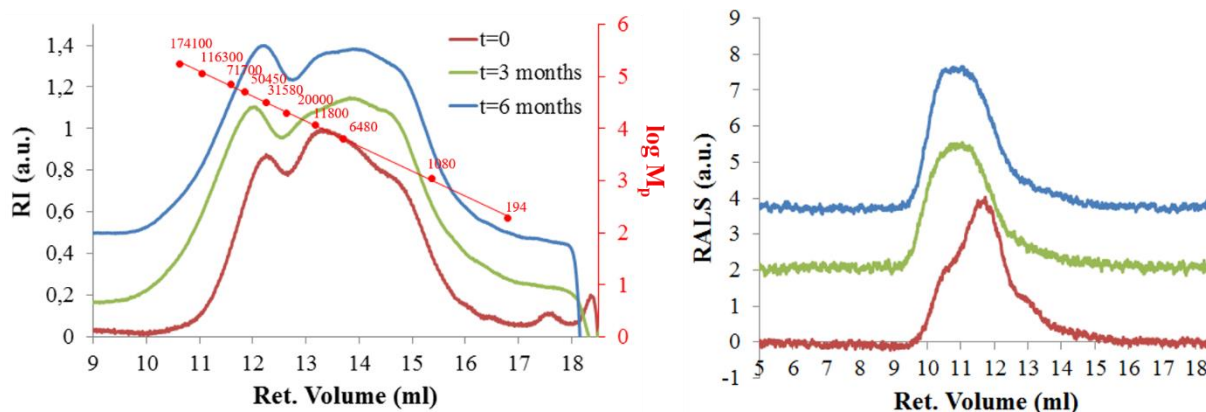

Figure 4.23 SEC chromatograms (DMF with 0.1% LiBr) of the polymer (HPAMAM 1.7 $t=0$) analysed at different times during its storage in vacuum oven. The time $t=0$ refers to the time in which the polymer can be considered dry (3 days after precipitation of the reaction mixture) and the study on the bulk polymer can start.

The impact of storage in vacuo on this sample was assessed using SEC analysis and data is shown in Figure 4.23. The RI detector provides the whole distribution of the polymer while the RALS is more sensitive to the high molecular weight fraction. The SEC data shows a slight broadening of the molecular weight distribution to high molecular weight after the storage of the polymer in vacuum for 3 months. However, no further changes were observed after 6 months. The molecular weight values, presented in Table 4.11, do not show significant variations. Moreover, no evidence of degradation or gelation are observed and therefore the results of this study show that the HPAMAM polymer is stable when stored for prolonged periods in vacuo.

Table 4.11 Molecular weight values of the polymer HPAMAM 1.7 ($t=0$) stored in vacuum oven. DMF SEC analysis (PEO standards was run over 6 months to monitor the stability of the bulk polymer).

time (months)	M_n (g/mol)	M_w (g/mol)	\bar{D}
0	3250	19500	6.0
3	3150	22550	7.5
6	3000	21450	7.2

4.4.1.4.3 Stability of the bulk polymer in desiccator at different relative humidity

The storage stability of the polymer was further studied by exposing the polymer to different relative humidity (RH). Thus, the polymer was sealed in a desiccator with specific saturated solutions to obtain varying relative humidity, as shown in Figure 4.24. Pure distilled water and P_2O_5 (phosphorus pentoxide) were used to obtain within the desiccator a RH of 100% and 0% respectively while saturated solution of $Mg(NO_3)_2 \cdot 6H_2O$ (magnesium nitrate hexahydrate) and $LiCl \cdot H_2O$ (lithium chloride hydrate) were prepared to achieve RH of 53.4% and 12%. These last values were not determined experimentally and therefore are only indicative in this context; the values provided were measured by Wexler *et al* at 25 °C⁴⁰.

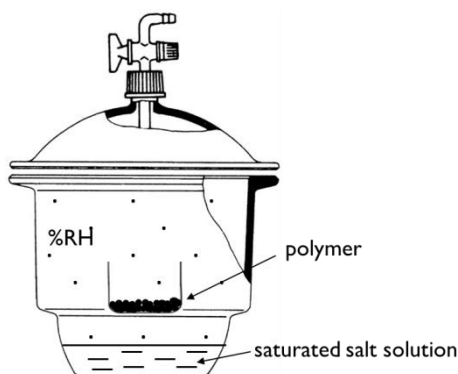

Figure 4.24 HPAMAM 1.7 polymer sealed in desiccator and exposed at different relative humidity (RH) varied with the use of specific saturated salt solution.

In Figure 4.25 the trend of the weight-average molecular weight (M_w) in the logarithmic form at different RH is depicted; the errors in SEC measurements using a conventional calibration are subject to errors in reproducibility and are estimated to be c.a. 1%. From the graph it is possible to observe that: (i) at RH of 100% a reduction of the M_w of c.a. 60% occurs within 24 hours; (ii) at RH of 53.4% the M_w increases during the first 3 days and then a significant decrease is observed after 7 day; (iii) at a RH of 12%, a trend similar to that described for RH of 53.4% is obtained but the rate of the variation in molecular weight is slower and (iv) in absence of humidity (RH=0%) the M_w can be considered more or less stable and only an increase of c.a. 20% respect to initial M_w of the polymer can be observed in 60 days.

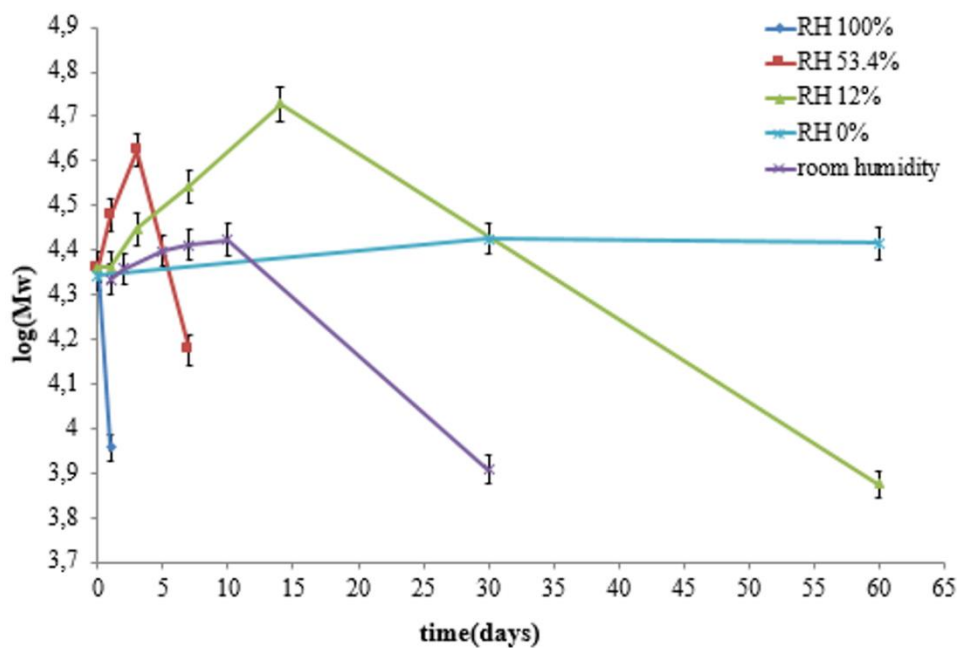

Figure 4.25 Trend of the weight-average molecular weight (M_w) with storage time of the polymer HPAMAM 1.7 when stored in dry conditions (pale blue line) and at relative humidities (RH) of 100% (dark blue line), 53.4% (red line), 12% (green line) and the humidity of the room in our research lab (purple line).

The increase in molecular weight observed at 53.4% and 12% suggests that the polymer undergoes further chain coupling and this process leads over time to gelation. The apparent reduction in the molecular weight is probably an indication that the residual soluble fraction of the polymer is low molecular weight. The rate of chain-coupling increases at higher RH and for this reason at RH=100% only a reduction in M_w can be observed due to fast formation of the gel fraction. The chain-coupling is negligible in absence of humidity (RH 0%) and therefore M_w does not undergo significant variation; this behaviour is similar to that described for the polymer stored in vacuo. Once the behaviour of the polymer under specific storage conditions was established, the molecular weight of the polymer when stored in a vial at the relative humidity of our research laboratory (atmospheric humidity) was also analysed. The trend of this sample, in Figure 4.25 (purple line), shows that the molecular weight of the polymer still increases but with a rate lower compared to that observed at RH 12%. The occurrence of chain coupling can also be described in terms of gel formation and for this reason the percentage of gel fraction was in parallel calculated for the sample at RH 53.4%, arbitrarily selected. The amount of gel fraction was obtained by SEC using polymer solutions at known concentrations from: (a) the ratio of the normalised areas (Equation 4.1) of the RI chromatogram of the samples taken at RH = 53.4% after $t=1, 3, 7$ days and the sample at $t=0$ (red square markers in Figure 4.26) and (b) the calibration of the SEC experiment with the specific dn/dC of the polymer (black dots in Figure 4.26). The methods used are described in detailed in the experimental

section of this chapter (Method a and Method b). Data obtained from the two methods are relevant and hence discussed since each is affected by a different inaccuracy.

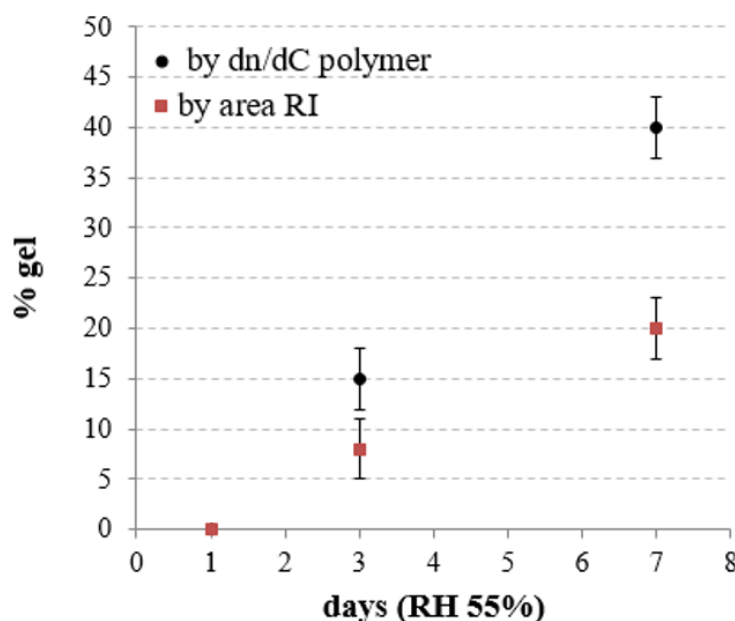

Figure 4.26 Percentage of gel fraction calculated for the sample HPAMAM 1.7 stored at c.a. RH=53.4% by DMF SEC by using RI detector (red dots) and RALS detector (black dots).

In particular Method “a” has an error in the measured concentration of the solution while the Method “b” has an error in the dn/dC used since the starting polymer (at $t=0$) has a different molecular weight compared to that after exposing the sample to RH=53.4% for $t=1, 3, 7$ days (see Figure 4.25). The error bars in the graph in Figure 4.26 were calculated for each sample on the base of two or three experiments. In Figure 4.26 it is possible to observe that both Methods generate a similar linear trend in so much that the gel fraction increases linearly with time at RH 53.4%. In particular the gel fraction is absent after 1 day and increases from c.a. $11.3 \pm 3.7\%$ to $30.0 \pm 10.0\%$ of the whole sample after 3 and 7 days respectively. The reported amount of gel fraction represents an average value of the two calculations carried out for each sample (3 and 7 days) using Methods “a” and “b” (see section 4.3.2) and the corresponding error represents the difference between the two values. The discrepancy between the two sets of data (red square and black dots in Figure 4.26) obtained by using the two methods mentioned above, increases with time at RH 53.4% because the gel fraction becomes more prevalent and the molecular weight of the soluble fraction diverges more significantly with respect to that of the fully soluble polymer (HPAMAM 1.7) used to calculate the dn/dC (see Figure 4.25 for the M_w values of the soluble fraction). Therefore in this case, the error in dn/dC used became more significant for the calculation of the concentration of the soluble fraction that permits to obtain the percentage of gel fraction.

The results in this section show that the conditions under which the polymer is stored can have a significant impact on the long-term stability of the polymer. It has been shown that moisture present in the air affects the molecular weight of the polymer and this effect is more evident at high relative humidity. Storage in aqueous solution revealed two possible sources of instability, degradation and chain coupling, and the relative contribution of each process was related to solution concentration. The results of the storage stability experiments under various relative humidity indicate the predominance of chain coupling; the humid environments reproduce the conditions, and consequently the results, of storage in concentrated aqueous solution. In summary, the results of section 4.4.1.4 suggest that the polymer has to be stored in anhydrous conditions in order to preserve its stability.

4.4.2 Modifying the structure of the B₄ monomer to tailor the chemical properties of the hyperbranched poly(amido amine) polymers.

Given the very wide range of potential A₂ and B₄ monomers, the described strategy is potentially very versatile. Thus, the chemical properties of the hyperbranched polymer synthesised by aza-Michael addition can be easily modified by changing the structure of one of the two monomer building blocks. Two different types of B₄ (bis-amino) monomer were used in this work; 2,2'-(ethylenedioxy)bis(ethylamine) (EOBEA) to increase the hydrophilicity of the polymer and Priamine™ to confer a more hydrophobic character to the polymer – see Figure 4.27.

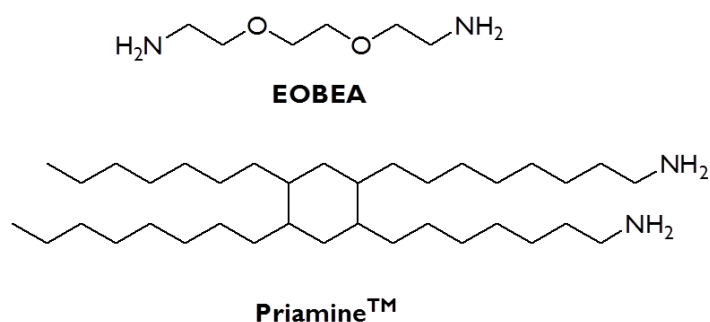

Figure 4.27 Structure of the B₄ monomers EOBEA and Priamine™

4.4.2.1 EOBEA as B₄ monomer

The Michael addition between MBA (A₂) and EOBEA (B₄) monomer was carried out in methanol/water (70/30) at 18% w/v and at 40°C with a molar ratio A₂:B₄ of 3:1. These conditions were previously found to be suitable for this system and a homogeneous

polymerisation occurred. The product of this reaction is identified as HPAMAM 2. The reaction scheme for the polymerisation of MBA and EOBEA is shown on the top of the Figure 4.28. The reaction was allowed to proceed for 3 days and the molecular weight values of the samples collected (without purification) after 1 day and 3 days are presented in Table 4.12. SEC samples were prepared by taking an aliquot corresponding to approximately 1 mg of polymer from the reaction mixture and diluting with 1 ml of DMF (SEC eluent). The molecular weight values were calculated by taking into account the entire distribution (M_n^1 , M_w^1 , \bar{D}^1) including the unreacted monomer in one case and the distribution excluding the monomer in the other case (M_n^2 , M_w^2 , \bar{D}^2).

Table 4.12 Molecular weight data of the polymerisation mixture (impure) and purified product of the reaction HPAMAM 2 prepared at 40°C and molecular weight variation of the impure product when stored in bulk form at RT in vacuo.

reaction time (days)	T (°C)	Sample	$M_n^{1,a}$	$M_n^{2,a}$	$M_w^{1,a}$	$M_w^{2,a}$	$\bar{D}^{1,a}$	$\bar{D}^{2,a}$
1	40	impure ^b	520	1100	7000	8000	13.0	7.0
3	40	impure ^b	750	1650	10500	11900	14.0	7.0
		purified	4150		14800		3.5	
storage time (days)								
0	RT	impure ^c	800		11700		14.5	
15	RT	impure ^c	700		10800		15.5	
30	RT	impure ^c (sol)	650		6900		10.5	
90	RT	impure ^c (sol)	950		15500		16.5	

^a with M_n and M_w in g/mol, values calculated by DMF SEC analysis with PEO as standards ⁽¹⁾ on the whole distribution and ⁽²⁾ on the distribution with the unreacted monomer subtracted (see Figure 4.12); ^b sample in solution - analysed without removing the solvent from the reaction mixture; ^c sample in bulk - analysed by removing the solvent from the reaction mixture.

From the results in Table 4.12, an increase of the M_n^2 of the polymer from 1100 to 1650 g/mol with increased reaction time can be observed. Under the previously optimised conditions, the reaction proceeded without gelation. The polymer HPAMAM 2 synthesised from the polyaddition MBA-EOBEA, was recovered after 3 days both purified by precipitating about half of the reaction mixture in acetone at RT and, as an impure sample recovered by evaporating the solvent from the remaining mixture under reduced pressure. From the precipitation, a polymer with M_n 4150 g/mol, M_w 14800 g/mol and \bar{D} 3.5 was obtained (Table 4.12). The polymer recovered by solvent evaporation (t=0 day storage, Table 4.12) showed no significant change in molecular weight from the polymer sample (no purification) analysed after 3 days of reaction. This results suggests that no significant further polymerisation occurs during the solvent removal step and this observation is in itself significant, since the analogous poly(ester amine) forms a gel when recovered by solvent removal under vacuum.

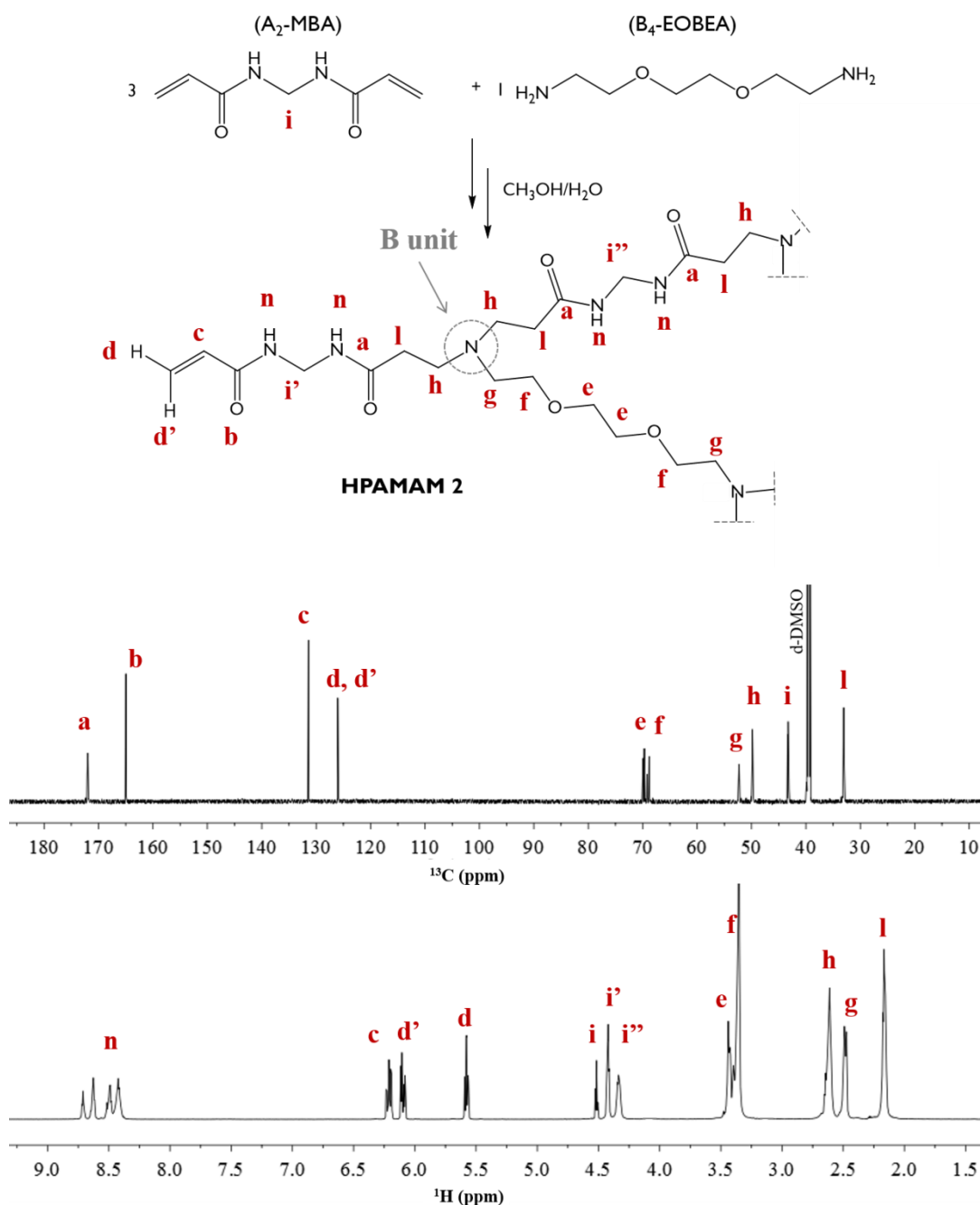

Figure 4.28 Schematic representation of the Michael addition reaction between MBA (A₂) and EOBEA (B₄) on the top; the assignment of the resulting polymer structure by ¹H-NMR and ¹³C-NMR is depicted (impure product).

The ¹H-NMR and ¹³C-NMR spectra of the polymer recovered by solvent evaporation are shown in Figure 4.28. From the change in chemical shift of the methylene proton peak i of the MBA monomer, from 4.51 ppm (monomer) to 4.43 (i') and 4.33 (i'') it is possible to estimate that 85% of the MBA has been converted into polymer, of which 65% of the MBA units has both acrylamide functionalities reacted and the remaining 20% has only one of the two acrylamides consumed. 15% of the MBA remained unreacted. From the ¹³C-NMR in Figure 4.28, a DB = 0.98 was calculated, indicating the high prevalence of branched units. The unpurified sample

recovered by solvent removal was stored in vacuo and analysed periodically over 90 days in order to investigate any impact of residual MBA on the polymer and to establish whether it is possible or not to avoid the precipitation step of the mixture. It is worth recalling that the purified polymer HPAMAM 1.7 remains stable when stored in vacuo (results section 4.4.1.4.2). The stability was assessed by DMF SEC analysis. Table 4.12 shows the molecular weight data obtained by periodically analysing the products of HPAMAM 2 under storage. No significant change in molecular weight was observed after 15 days in vacuo. However, the sample analysed after 30 days showed the formation of a gel fraction and therefore the molecular weight quoted in Table 4.12 is that of the sol fraction. It was estimated that the gel fraction made up around 36.5% of the sample (calculated from the ratio between the normalised areas of the SEC chromatograms (RI detector) of HPAMAM 2 stored i) in vacuo at RT for 30 days and ii) at RT $t=0$ – fully soluble sample (Table 4.12)). After 90 days, an increase in molecular weight of the sol fraction of the polymer was observed (Table 4.12) arising due to the ongoing polymerisation that occurs upon storage in vacuo in the presence of the unreacted of MBA.

These results suggest that in order to preserve the stability of the polymer, the unreacted MBA should be removed before the storage of the polymer – even in vacuo. It is expected that the stability in vacuo of HPAMAM 2 (poly(MBA-EOBEA)) is similar to that observed in the section 4.4.1.4.2 for the sample HPAMAM 1 (poly(MBA-EDA)).

4.4.2.2 Priamine™ as B₄ monomer.

The synthesis of more a hydrophobic hyperbranched polymer - HPAMAM 3 - was carried out by using MBA as A₂-monomer and Priamine™ as a B₄-monomer – see Scheme 4.6. Priamine™ is a bio-based building block (oleic acid dimer-derived amine) and a C-36 diamine whose structure is shown in Scheme 4.6. It is a Croda product used mainly for coating applications due its low viscosity, high flexibility and chemical resistance, providing durability under a variety of conditions. For instance, it is used as protective marine coating as its flexibility increases impact and the crack resistance and its hydrophobicity makes it a good sealant, improving adhesion.

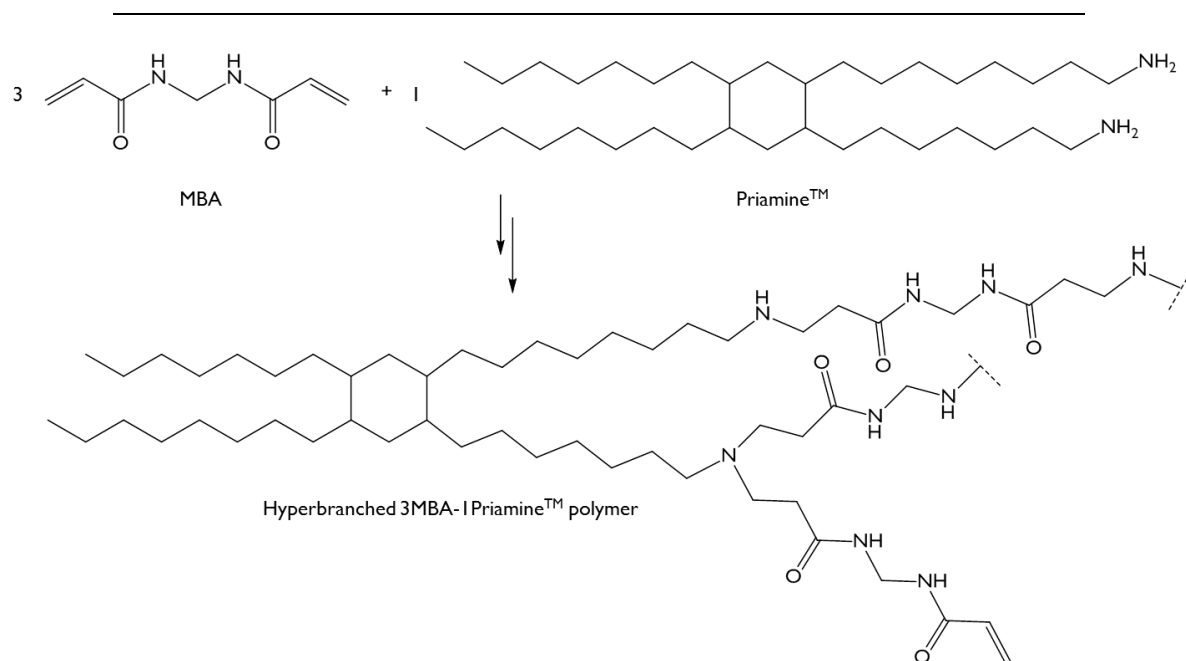

Scheme 4.6 Scheme of the reaction for the polyaddition MBA and Priamine™

The polymerisation of MBA-Priamine™ cannot be carried out in methanol/water because of the hydrophobicity of the Priamine™ and so alternative solvents were evaluated in order to find a homogeneous system. As Priamine™ is fully soluble in methanol, THF, CHCl₃, DCM and toluene, a first polymerisation was attempted using 100% methanol as a good solvent for the polymerisation and both monomers at 40°C. A total monomer concentration of 10% w/v was used and a homogeneous solution was obtained. The optimal monomer feed ratio A₂:B₄ of 3:1 was used. Although, the reaction under these conditions started as a homogeneous mixture, it turned into a cloudy suspension after 5 hours. The suspension was found to be soluble in solvents such as THF, CHCl₃ and DCM. Thus the ¹H-NMR in CDCl₃ was possible and revealed a product of which 45% of acrylamide groups had reacted to give a polymer with a DB = 0.45. However, after 24 hours, the polymerisation had proceeded to form c.a. 60% w/w of an insoluble gel fraction, estimated at the end of the experiment by dry weight of the gel fraction previously separated from the whole polymerisation mixture by filtration. The NMR results considered alongside the formation of a gel fraction, suggests the polymerisation of MBA and Priamine™ does proceed in methanol and it is supposed that gelation occurs in this case because of the heterogeneous nature of the reaction mixture. Moreover, the formation of such a suspension during polymerisation and its subsequent solubility in solvents which are less polar than methanol, confirms that the product of the polyaddition is not soluble in methanol. However methanol, is clearly able to dissolve the two starting monomers and promote the polymerisation, and hence should be used in a mixture with a good solvent for the resulting

polymer formed from MBA and Priamine™. The hydrophobic, non-polar nature of Priamine™ would suggest that a less polar solvent than methanol should be considered. Thus both THF and Arlasolve™ were used in turn in a 50/50 mixture with methanol and both were found to be good co-solvents with methanol for the polymerisation.

Polyaddition of MBA and Priamine™ in methanol/THF (50/50 v/v)

The reaction between MBA and Priamine™ was carried out with a molar ratio A₂:B₄ of 3:1 in methanol/THF (50/50% v/v). In this case, a temperature of 60°C was used since preliminary tests revealed a low rate of reaction for the synthesis of HPAMAM 1 and HPAMAM 2 at a temperature of 40°C. A total monomer concentration of 10% w/v was used to ensure that the polymerisation proceeds homogeneously. The progress of the polymerisation was studied by ¹H-NMR, ¹³C-NMR and SEC analysis using THF as eluent – a good solvent for the reaction product.

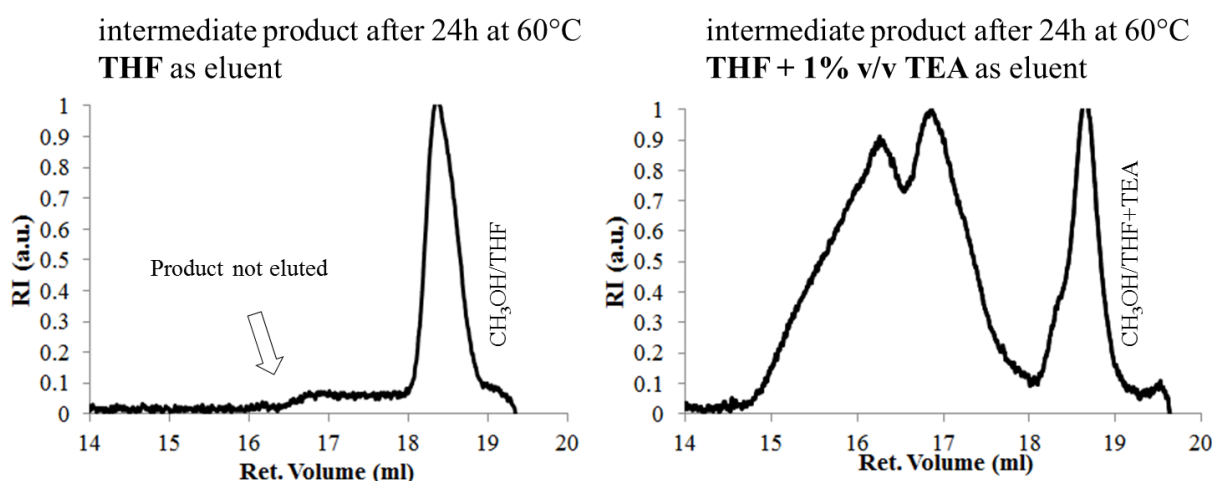

Figure 4.29 Effect of the addition of 1% v/v of TEA to the THF mobile phase on the elution of the intermediate product analysed without purification after 24 hours of the reaction 3MBA+1Priamine™ at 60°C in methanol/THF (50/50% v/v).

Initially SEC analysis did not show any peaks in either the RI or RALS trace (left side, Figure 4.29). The absence of these signals was subsequently found to be due to the interaction between amino groups within the polymer and the SEC column packing. The interaction of polar groups with the SEC column has previously been observed and reported by Bozanko *et al.* for sulfone-functionalised polystyrene⁴¹. Thus, we attempted to analyse the polymer by adding 1% v/v of triethylamine (TEA) to the eluent THF. TEA has been shown to inhibit any interaction between the polymer with the SEC column. Figure 4.29 shows the effect of the addition of TEA to the elution of the intermediate product taken from the reaction after 24 hours and analysed without

purification. The results confirm that the addition of TEA is an effective way to ensure the elution of the polymer from the column and hence the analysis by SEC.

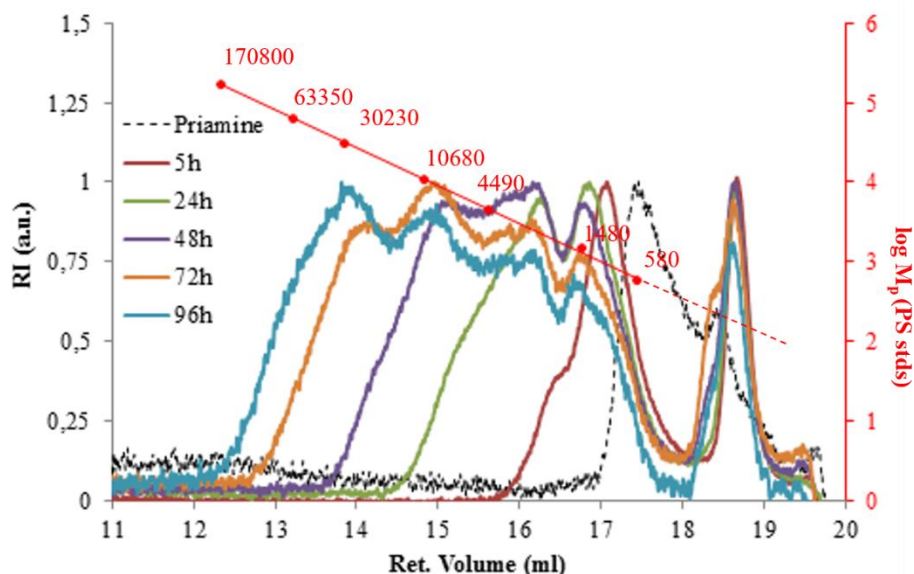

Figure 4.30 SEC analysis of the product HPAMAM 3.2 of the polyaddition 3MBA+1PriamineTM (T=60°C in methanol/THF at 10% w/v) showing molecular weight as a function of time.

The reaction between MBA and PriamineTM was allowed to proceed for 4 days at 60°C; the product of this reaction was designated HPAMAM 3.2. The SEC chromatograms (RI detector) of samples collected during the reaction are shown in Figure 4.30 (DP chromatogram in Appendix B, Figure B.5) which clearly shows that the molecular weight of the polymer increases with reaction time as evidenced by a shift to lower retention volumes. A broadening of the molecular weight distribution is also observed, as expected for such a polymerisation. After 5 hours it emerged that PriamineTM, which eluted at around 17.5 ml, is no longer present in the reaction mixture and the presence of oligomers eluted around 17 ml can be observed. The relative area of the peak at c.a. 17 ml tends to decrease with the time corresponding to the formation of species with a high molecular weight.

Table 4.13 Molecular weight (SEC) data for the intermediate products HPAMAM 3.2 analysed without purification of the reaction 3MBA+1PriamineTM at 60°C in methanol/THF (10% w/v).

Time (h)	T (°C)	M _n (g/mol) ^a	M _w (g/mol) ^a	Đ ^a	% A reacted ^b	DB ^c
5	60	850	1250	<1.5	-	-
24	60	1500	2900	2.0	50	0.75
48	60	2300	6000	2.5	55	0.82
72	60	3100	13350	4.0	60	0.90
96	60	3700	22700	6.0	60	0.95

^a calculated by THF SEC + 1% v/v TEA (PS standards) excluding from the distribution the unreacted MBA; ^b calculated by ¹H-NMR; ^c calculated by ¹³C-NMR.

In Table 4.13 the increase of the molecular weight of the polymer with reaction time can be observed; M_n increases from 850 g/mol after 5h to 3700 g/mol after 96h. The molecular weight values were, in this case, all calculated by excluding from the distribution unreacted MBA since

the additive TEA is also eluted at same the retention volume as MBA. From the data in Table 4.13 it is clear that the M_w value approximately doubles every 24h and that this increase is associated with the formation of a new fraction (Figure 4.30). The progress of the polymerisation was followed by calculating the conversion of acrylamide (A) groups ($^1\text{H-NMR}$) and the DB ($^{13}\text{C-NMR}$) of the polymer. After 96 hours, 60% of the acrylamide groups had reacted and a highly branched architecture (DB 0.95) was formed. Moreover, after 96h, the formation of a shoulder at retention volume of c.a. 13 ml was observed in the SEC chromatogram and, in the reaction mixture the presence of dust-like particles was detected. The reaction was therefore stopped after 4 days by precipitation into cold acetone. A white precipitate was recovered in 82% yield. The polymer was found to be soluble in CHCl_3 at RT and at 50°C in THF and DCM and from the solubility test it was also observed that the gel fraction formed was only present in a small amounts in the recovered product and therefore the polymer was not separated and treated as fully soluble. The molecular weight of the final product can be calculated (i) by using a conventional calibration method with PS standards; M_n 5900 g/mol, M_w 24000 g/mol, Đ 4.0 and (ii) by triple detection calibration using a dn/dC for PS in THF of 0.185⁴⁰ giving M_n 6400 g/mol, M_w 44000 g/mol, Đ 6.5. Both calculations are inaccurate to a greater or lesser extent for the polymer in question since the molecular weight values obtained in both cases are relative to linear PS standards which are chemically and architecturally different to the synthesised polymer. In order to estimate an absolute molecular weight, the calculation of the specific dn/dC of the polymer in THF + 1% v/v TEA is necessary. The onset of gelation after 96 hours suggests that the optimal reaction time for the polymerisation of 3MBA:1PriamineTM in methanol/THF at 60°C is 3 days. Thus, the reaction was repeated for this period of time and the resulting product, identified as HPAMAM 3.1, characterised by $^1\text{H-NMR}$, $^{13}\text{C-NMR}$ and SEC analysis. From SEC analysis, the formation of a polymer (analysed without purification) with an M_n 3040 g/mol, M_w 12800 g/mol and Đ 4.2 was detected after 3 days. A comparison of these values with those in Table 4.13 (at 72 hours) suggests that the reaction is reproducible. The $^1\text{H-NMR}$ and $^{13}\text{C-NMR}$ spectra of the mixture after 3 days are shown in Figure 4.31 with the assignment of the polymer's structure; the identification of the structure was possible by means of ^1H , ^{13}C -HSQC and ^1H , ^{13}C -HMBC analysis. The DB of the polymer, calculated using the signals g (branched unit) and h (linear unit) in the $^{13}\text{C-NMR}$ spectrum, was estimated to be 0.92. This value confirms that the polymerisation led predominantly to the formation of branched units rather than linear units. From the $^1\text{H-NMR}$, the change of the signal corresponding to the methylene group in the MBA

monomer/residue (d) indicates that proportion of MBA monomer units which had reacted via both acrylamide groups (d'') and only one acrylamide group (d'). This data allows a calculation of the proportion of MBA monomer incorporated in the polymer to be 85%. Moreover, the percentage of acrylamide groups reacted can also be calculated by integrating the peaks corresponding to the vinyl protons with respect to the total area of the methylene protons d, d' and d'' (63%).

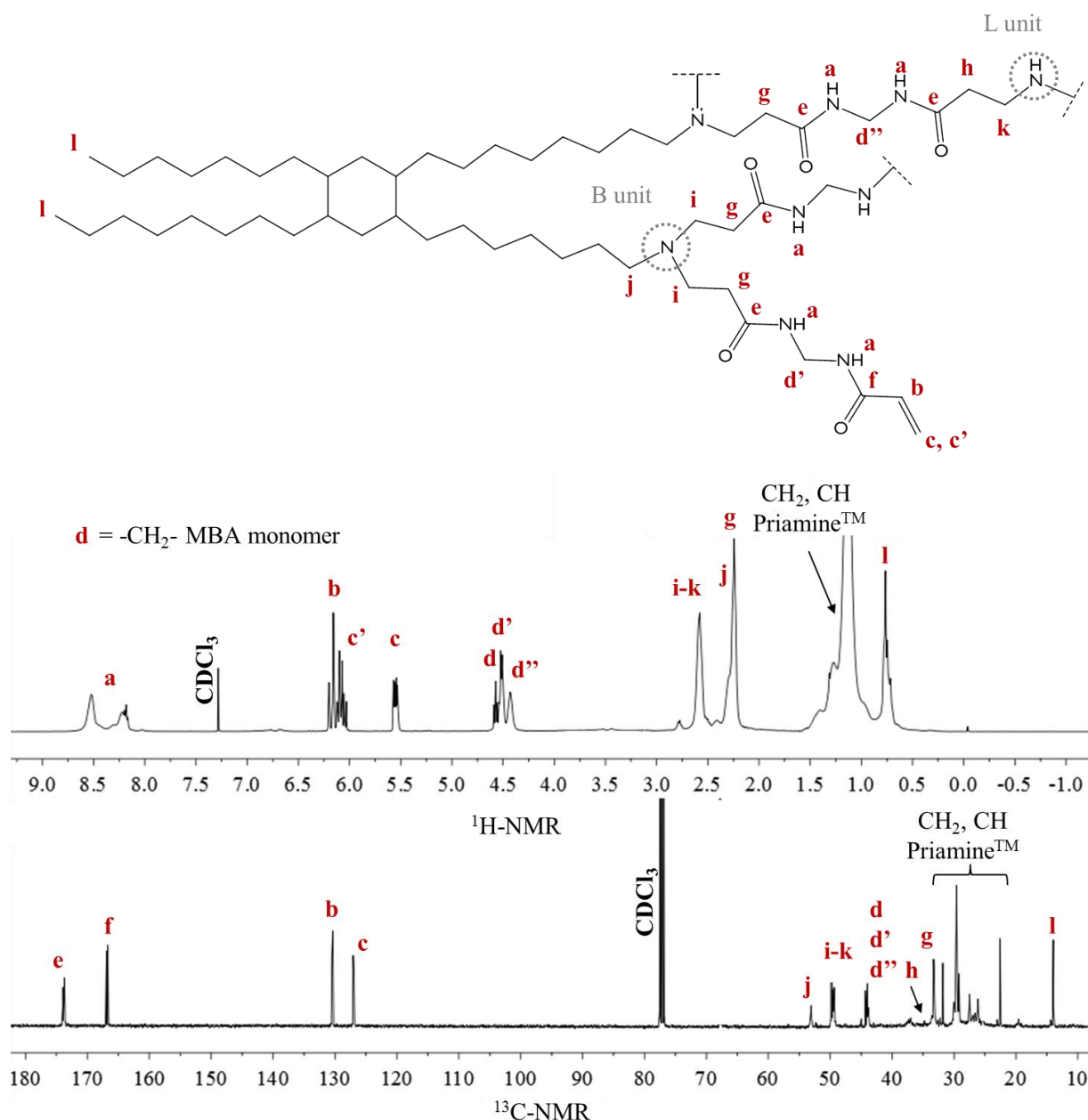

Figure 4.31 $^1\text{H-NMR}$ and $^{13}\text{C-NMR}$ of the impure product obtained after 3 days of the reaction $3\text{MBA}+1\text{Priamine}^{\text{TM}}$ ($T=60^\circ\text{C}$ in methanol/THF at 10% w/v) with the relative assignment of the structure.

The product was recovered by precipitation in cold acetone after 3 days reaction time in 75% of yield. The SEC chromatograms (RI and RALS signals) of this product are shown in Figure

4.32. The molecular weight of the final product (HPAMAM 3.1) was: (i) M_n 4500 g/mol, M_w 14600 g/mol, \bar{D} 3.0 (conventional calibration with PS standards) and (ii) M_n 4500 g/mol, M_w 23200 g/mol, \bar{D} 5.0 (triple detector using a dn/dc of PS in THF of 0.185 ml/g).

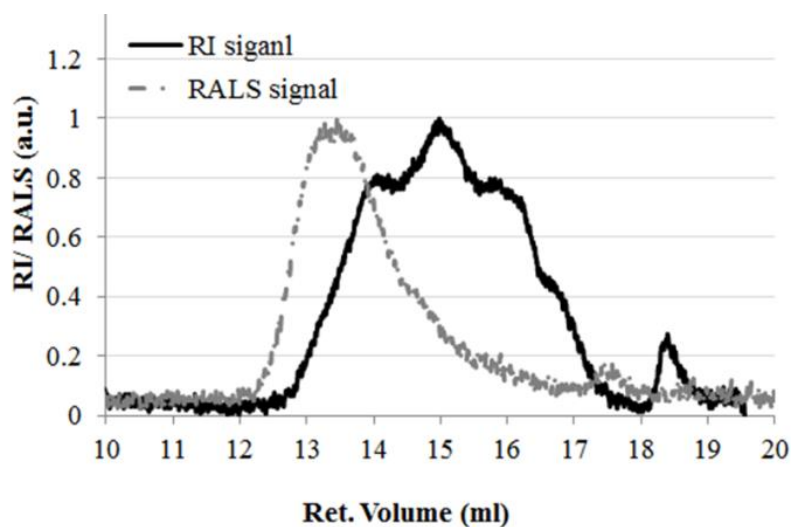

Figure 4.32 SEC chromatograms (RI and RALS detectors) of the product HPAMAM 3.1 the reaction 3MBA+1PriamineTM in methanol/THF at 60°C recovered by precipitation after 3 days reaction.

The success of the polymerisation 3MBA:1PriamineTM carried out in methanol/THF encouraged the scale up of the reaction. The reaction was initially carried out in Durham using 1 g or 3 g of the starting materials and with excellent reproducibility (Table 4.14).

Table 4.14 Molecular weight data and yield of the product 3MBA-1PriamineTM obtained from the polyaddition in methanol/THF at 60°C with increasing quantities of starting monomers to test the reproducibility of the reaction.

Reaction scale (g)	M_n (g/mol)	M_w (g/mol)	\bar{D}	Yield (%)
1	4500	14600	3.2	75
3	4300	15500	3.5	78
20	4500	17500	4.0	72
350	4800	16500	3.5	45

The scale up of the reaction to 20 and 350 g was carried out within the labs of the industrial sponsor of this project, Croda. In this case, as for the reaction MBA:EDA, the optimised reaction conditions had to be strictly reproduced to avoid gelation. Reactions were hence carried out for 3 days and the polymer recovered by precipitation into cold acetone. Figure 4.33 shows the chromatograms (RI detectors) of the products of the reactions 3MBA-1PriamineTM carried out at increasing scale (DP chromatograms in Appendix B, Figure B.6). The molecular weight values of the resulting polymers obtained by THF (+ 1% v/v TEA) SEC using PS as standards, are reported in Table 4.14. Figure 4.33 and the data in Table 4.14 confirm that the reaction can be scaled up, with good reproducibility. However, a comparison of the RI chromatograms in

Figure 4.33 reveals a slight decrease in the area of the low molecular weight species for the product recovered from the 350g reaction but no significant change to the high molecular weight fraction eluted between 13 and 14 ml. The handling of large volumes of solvent during the recovery of the product produced on the largest scale, probably lead to an unsatisfactory precipitation and a lower yield was obtained (Table 4.14).

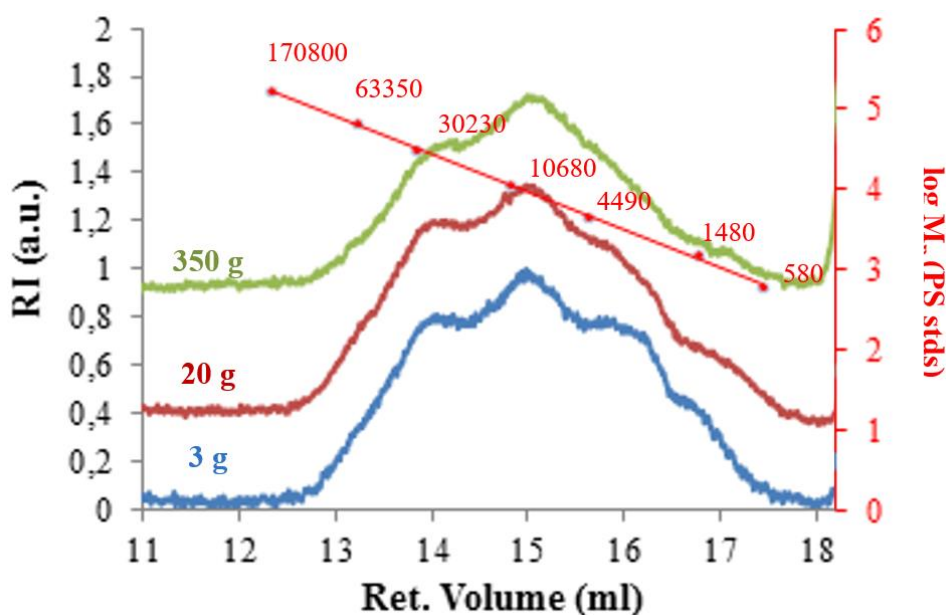

Figure 4.33 THF SEC chromatograms (RI detector) of the product 3MBA-1Priamine™ obtained from the polyaddition in methanol/THF at 60°C by using 3 g (blue trace), 20g (red trace) and 350 g (green trace) of starting monomers.

The results in this work showed good reproducibility for the polyaddition of MBA-Priamine™ under the conditions selected and consequently of the molecular weight of the final product.

Polyaddition of MBA and Priamine™ in methanol/Arlasolve™ (50/50 v/v)

The polymerisation of 3MBA:1Priamine™ was also carried out in methanol/Arlasolve™ (50/50% v/v) at 60°C, at a monomer concentration of 10% w/v. The product of this reaction is labelled HPAMAM 3.3. The reaction was evaluated by SEC analysis and ¹H and ¹³C-NMR. The characterisation data for the samples taken from the mixture after 24 and 30 hours are shown in Table 4.15. From the data, a significant increase of the M_w can be observed between 24 and 30 hours. A comparison of the data in Table 4.15 with that in Table 4.13, indicates that the reaction in methanol/Arlasolve™ proceeds at a higher rate than the reaction in methanol/THF. Thus, a polymer with M_w of 21500 g/mol and Đ of 5.0 was obtained after 30 hours in methanol/Arlasolve™ (Table 4.15) whereas a similar molecular weight was obtained for the reaction in methanol/THF only after 96 hours. However, the increased rate of reaction

leads to the formation of a gel fraction after 30h as opposed to 96h. The reaction was therefore stopped at this time by precipitation.

Table 4.15 Characterisation data of the polymer samples HPAMAM 3.3 (3MBA+1Priamine™ at 60°C in methanol/Arlasolve™ (10% w/v)).

Time (h)	T (°C)	M _n (g/mol) ^a	M _w (g/mol) ^a	Đ ^a	% A reacted ^b	DB ^c
24	60	2500	9500	3.5	55	0.83
30	60	3000	21500	5.0	60	0.90

^a calculated by THF SEC + 1% v/v TEA (PS standards) excluding from the distribution the unreacted MBA; ^b calculated by ¹H-NMR; ^c calculated by ¹³C-NMR.

The product HPAMAM 3.3, a polymer containing sol and gel fractions, obtained after 30 hours was recovered by precipitation in cold acetone (yield 75%). The soluble fraction, obtained by filtration was dissolved in THF for SEC analysis and had a molecular weight; M_n 3100 g/mol, M_w 19500 g/mol, Đ 5.5 (conventional calibration, PS standards); M_n 31700 g/mol; M_w 113100 g/mol, Đ 3.5 by triple detection SEC using a dn/dc of 0.185 ml/g⁴⁰ (PS in THF). The RI and RALS chromatograms of the final product are depicted in Figure 4.34.

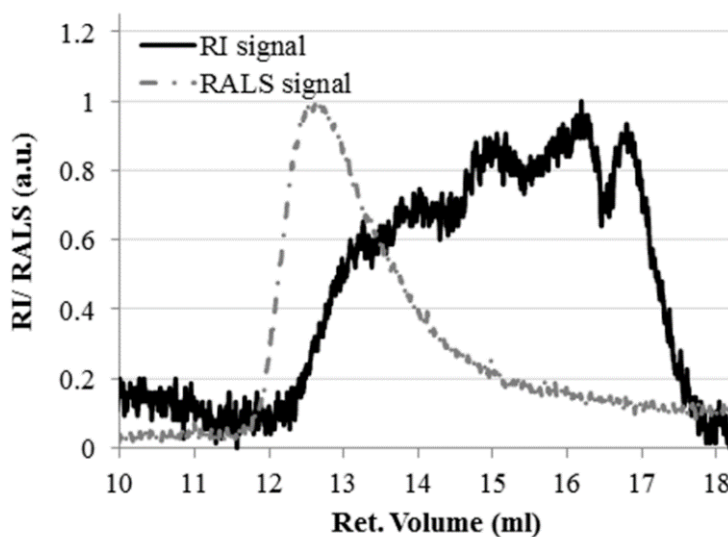

Figure 4.34 SEC chromatograms (RI and RALS detectors) for the final product HPAMAM 3.3 of the reaction 3MBA+1Priamine™ in methanol/Arlasolve™ at 60°C recovered by precipitation after 30 hours reaction.

The results reported above for the polymerisation of MBA and Priamine™ show that although methanol is a good solvent for both monomers, a co-solvent is required to promote the polymerisation and maintain a homogeneous polymerisation solution. Both Arlasolve™ and THF can be used as a co-solvent, although the choice of solvent affects the rate of the reaction. Moreover, although Arlasolve™ and THF are both cyclic ethers, they have different impacts upon the polymerisation (see comparison of Figure 4.32 and Figure 4.34); Arlasolve™/methanol promotes the polyaddition, accelerating the rate of the reaction while the rate in THF/MeOH is slower. As discussed in the introduction of this chapter, the synthesis of

HPAMAM occurs preferentially in protic solvents because of their ability to carry solvated protons however, neither Arlasolve™ nor THF are protic solvents but both can act as H-bond acceptors. In fact, the parameter corresponding to the hydrogen bond δ_H interactions evaluated according to Hansen's approach, widely used by industry⁴², for the two solvents are $\delta_H = 12.0$ ^{43,44} and $\delta_H = 8.0$ ⁴⁵ for Arlasolve™ and THF respectively. The higher δ_H value for Arlasolve™ supports the idea of better solvation for the Arlasolve™/methanol system and an enhanced capacity to transport/stabilise the mobile proton for the aza-Michael addition reaction leading to the formation of a product with higher molecular weight. The results obtained for the polyaddition MBA-Priamine™ in Arlasolve™/methanol and THF/methanol show that both solvent mixtures are good candidates for the reaction and a branched, soluble polymer with high MW can be obtained by quenching the reaction at different times, namely less than 24 hours for Arlasolve™/methanol and 3 days for THF/methanol).

4.5 Conclusions

Hyperbranched poly(amido amine) polymers were successfully synthesised by the aza-Michael polyaddition reaction between an A_2 (MBA) and B_4 (EDA) monomer. The reaction occurs in solution and a mixture of protic solvents such as methanol/water (70/30% v/v) was used. The architecture of the final polymer can be regulated by changing the molar ratio of the starting monomers and in particular, a branched and soluble product was obtained by working with a molar ratio of $A_2:B_4$ of 3:1, such that there is an excess of acrylamide groups with respect to the N-H groups. This result confirms the possibility to obtain soluble branched PEA by quenching the polyaddition PEA1-3 (Chapter 3) at a certain conversion prior to the onset of gelation. Moreover, the results reported in the present chapter show that the rate of reaction for HPAMAMs can be controlled with temperature and it was observed that at 40°C the formation of a gel fraction only occurs at longer reaction times (>1 week). Thus, this temperature was selected as the optimal temperature for further investigations into this reaction. The results suggest that the $A_2 + B_4$ strategy can be successfully exploited despite the risk of gelation discussed in Chapter 3. Moreover, for hyperbranched poly(amido amine)s it was shown that is possible to produce a polymer of predictable molecular weight by quenching the reaction at a particular time. This was made possible by previously analysing the evolution of molecular weight of the resulting polymer as a function of reaction time.

The reproducibility and scalability of the polyaddition of MBA-EDA was tested and established by repeating the reaction several times using increasing amounts of starting monomers.

Poly(amido amine)s are preferred in this work to poly(ester amine)s due to their increased hydrolytic stability. In fact, now that the conditions for the synthesis of gel-free hyperbranched polymer are established, this project aims also to evaluate the properties of the polymers to find potential novel industrial applications. Therefore, long term stability upon storage is required for HPAMAMs and in order to demonstrate this feature, the stability of the HPAMAM 1.7 was evaluated when dissolved in water at room temperature and in bulk at different RH. The polymer showed relatively good hydrolytic stability both in dilute and concentrated solutions. However, the hyperbranched poly(amido amine), did show a tendency to undergo further chain-coupling in water which could and did lead in some cases to gelation. This instability is more evident in highly concentrated aqueous solutions (e.g. 18% w/v). The stability of the PAMAM polymer when stored in the bulk form in the presence and in absence (in vacuo) of air showed that the polymer should preferably be stored under anhydrous conditions (in a vacuum oven or in a desiccator with a drying agent) as the moisture in the air is able to promote further slow chain coupling in the bulk and the eventual formation of a gel fraction as was observed in aqueous solutions.

Despite the need for careful storage, the polyaddition of MBA and EDA was considered for industrial scale up. With this in mind the use of alternative “industrial” solvents was considered. A mixture of ArlasolveTM/H₂O (50/50% v/v) instead of CH₃OH/H₂O (70/30% v/v) showed satisfactory results and the polymerisation proceeds in this solvent leading to a polymer with a molecular weight M_w of more than 10,000 g/mol after 48 hours. Both the use of ArlasolveTM and the increased volume of water (50% v/v) with respect to the methanol/water mixture contributed to an increase in the rate of polyaddition and as a result the polymerisation is susceptible to gelation. In order to reduce the risk of gelation, shorter reaction times will need to be considered for future experiments.

Finally, the properties of the resulting polymer can be modified by using different diamine building blocks (B₄). In particular, EOBEA was used as an example of a monomer which might increase the hydrophilicity of the final product and PriamineTM used as a monomer to increase hydrophobicity. In both cases the polyaddition reaction proved successful in methanol/water (70/30% v/v, 18% w/v), at 40°C for the former case and in methanol/THF (50/50% v/v, 10% w/v) or methanol/ArlasolveTM at 60°C for the latter case. The effect of the use of different B₄ building

blocks on the final properties of the polymer was studied and will be discussed in the Chapter 6.

References

- ¹ Wang, D., Zheng, Z., Hong, C., Liu, Y., Pan, C. *Polym Sci Pol Chem*, **2006**, *44*, 6226–6242.
- ² Martello, F., Piest, M., Engbersen, J. F. J., Ferruti P. *J Control Release*, **2012**, *164*, 372–379.
- ³ Wang, D., Liu, Y., Hu, Z., Hong, C., Pan C. *Polymer*, **2005**, *46*, 3507–3514.
- ⁴ Emilriti, E., Ranucci, E., Ferruti, P. *J Polym Sci Pol Chem*, **2005**, *43*, 1404–1416
- ⁵ Lin, C., Zhong, Z., Lok, M. C., Jiang, X., Hennink, W. E., Feijen, J., Engbersen, J. F. J. *Bioconjugate Chem*, **2007**, *18*, 138-145
- ⁶ Chen, J., Wu, C., Oupicky D. *Biomacromolecules*, **2009**, *10*, 2921–2927
- ⁷ Wang, D., Liu, Y., Hong, C.-Y., Pan, C.-Y. *Polym Sci Pol Chem*, **2005**, *43*, 5127–5137
- ⁸ Komber, H., Voit, B., Monticelli, O., Russo, S. *Macromolecules*, **2001**, *34*, 5487-5493
- ⁹ Lin, Q.; Long, T. E. *Macromolecules*, **2003**, *36*, 9809-9816
- ¹⁰ Unal, S., Yilgor, I., Yilgor, E., Sheth, J. P., Wilkes, G. L., Long, T. E. *Macromolecules*, **2004**, *37*, 7081-7084
- ¹¹ Stumbe, J. F., Bruchmann, B. *Macromol Rapid Commun* **2004**, *25*, 921-924
- ¹² F. Danusso, P. Ferruti, *Polymer*, **1970**, *11*, 88-113
- ¹³ P. Ferruti, M.A. Marchisio, R. Barbucci, *Polymer*, **1985**, *26*, 1336-13
- ¹⁴ Manfredi, A., Ranucci, E., Suardi, M., Ferruti, P., *J Bioact Compat Polym*, **2007**, *22*, 219-231.
- ¹⁵ Mather, B. D., Viswanathan, K., Miller, K. M., Long, T. E. *Prog. Polym. Sci.* **2006**, *31*, 487–531
- ¹⁶ Zhang, B., Ma, X., Murdoch, W., Radosz, M., Shen Y. *Biotechnol Bioeng*, **2013**, *110*, 990-998
- ¹⁷ Wang, R., Zhou, L., Zhou, Y., Li, G., Zhu, X., Gu, H., Jiang, X., Li, H., Wu, J., He, L., Guo, X., Zhu, B., Yan D. *Biomacromolecule*, **2010**, *11*, 489–49
- ¹⁸ Wang, H.-B., Chen, X.-S., Pan C.-Y. *Eur Polym J* **2008**, *44*, 2184–2193
- ¹⁹ Lin, C., Engbersen J. F. J., *J Control Release*, **2008**, *132*, 267–272
- ²⁰ Malgesini, B., Verpilio, I., Duncan, R., Ferruti P. *Macromol. Biosci.* **2003**, *3*, 59–66
- ²¹ Wang, D., Yu, Z.-Q., Hong, C.-Y., You Y.-Z. *Eur Polym J*, **2013**, *49*, 4189–4194
- ²² Lin, C., Blaauboer, C.-J., Timoneda, M. M., Lok M. C., van Steenberg, M., Hennink W. E., Zhong Z., Feijen J., Engbersen J. F. J. *J Control Release*, **2008**, *126*, 166–174.
- ²³ Ping, Y., Wu, D., Kumar, J. N., Cheng, W., Lay, C. L., Liu Y. *Biomacromolecules*, **2013**, *14*, 2083–2094.
- ²⁴ Tang, M. X., Redemann, C. T., Szoka, F. C. *Bioconjugate Chem* **1996**, *7*, 703-714.
- ²⁵ Ferruti, P., Ranucci, E., Bignotti, F., Sartore, L., Bianciardi, P., Marchisio, M. A., *J Biomat Sci Polym Ed* **1994**, *6*, 833–844
- ²⁶ Ferruti, P., Ranucci, E., Sartore, L., Bignotti, F., Marchisio, M. A., Bianciardi, P., Veronese, F. M. *Biomaterials* **1994**, *15*, 1235–1241.
- ²⁷ Ranucci, E., Spagnoli, G., Ferruti, P., Sgouras D., Duncan, R., *J Biomater Sci Polymer Edn*, **1991**, *2*, 303-315.
- ²⁸ Tomalia, D.A., Baker, H., Dewald, J., Hall, M., Kallos, G., Martin, S., Roeck, J., Ryder, J., Smith P. *Polym J* **1985**, *17*, 117-132.

-
- ²⁹ Wang, X., He, Y., Wu, J., Gao, C., Xu, Y. *Biomacromolecules* **2010**, *11*, 245–251.
- ³⁰ Bielinska, A.U., Chen, C., Johnson, J., Baker, J. R., Jr. *Bioconjugate Chem.* **1999**, *10*, 843-850.
- ³¹ Hobson, L. J., Kenwright A. M., Feast W. J. *Chem Comm* **1997**, *21*, 1877-1878.
- ³² Gao, C., Yan, D. *Prog Polym Sci*, **2004**, *29*, 183–275.
- ³³ Yan, D., Gao, C., Frey H., *Hyperbranched Polymer Synthesis, Properties and Applications* John Wiley & Sons, Inc., Hoboken, New Jersey, **2011**, 115-116
- ³⁴ Ferruti, P. *J Polym Sci Pol Chem*, **2013**, *51*, 2319–2353.
- ³⁵ Hobson, L. J., Feast, W. J. *Polymer*, **1999**, *40*, 1279-1297.
- ³⁶ Durand, M., Zhu, Y., Molinier, V., Féron, T., Aubry, J.-M. *J Surfact Deterg*, **2009**, *12*, 371–378.
- ³⁷ Lipp, R., Gunther, C., Riedl, J., Tauber U. *Patent US5904931 A*, **1999**, Schering Aktiengesellschaft, Berlin, Germany.
- ³⁸ Simonsen, L., Petersen, M.B., Groth, L. *Eur J Pharm Sci*, **2002**, *17*, 95-104.
- ³⁹ Peterson, J., Allikmaa, V., Pehk, T., Lopp, M. *Proc Estonian Acad Sci Chem*, **2001**, *50*, 167–172.
- ⁴⁰ Wexler A., Hasegawa, S. *J Res Nat Bur Stand*, **1954**, *53*, 19-26
- ⁴¹ Bozanko, A., Carswell, W.D., Hutchings, L.R., Richards, R.W. *Polymer*, **2000**, *41*, 8175–8182.
- ⁴² Hansen, C.M. *Hansen Solubility Parameters: A User's Handbook*, CRC Press, Boca Raton, Florida, **2007**.
- ⁴³ Mottu, F., Gaillood, P., Massuelle, D., Rüfenacht, D.A., Doelker, E. *Biomaterials*, **2000**, *21*, 803-811.
- ⁴⁴ Cahill, JR. et al. *Patent US 2015/0045420 A1*, **2015**.
- ⁴⁵ Moity, L., Benazzouz, A., Molinier, V., Nardello-Rataj, V., Elmkaddem, M. K., de Caro, P., Thiébaud-Roux, S., Gerbaud, V., Marion, P., Aubry, J.-M. *Green Chem*, **2015**, *17*, 1779–1792.

Chapter 5

**Synthetic strategies for the
modification of hyperbranched
poly(amido amine)s**

5.1 Modification of hyperbranched poly(amido amine)s - the current state of the art.

Hyperbranched poly(amido amine)s (HPAMAMs) synthesised by an aza-Michael addition reaction between an acrylamide group (A) and an N-H (B) group (1° , 2° amine) may be further modified by post-polymerisation reactions. The molar ratio of monomers used for the polyaddition establishes the nature of the terminal groups of the resulting polymer and specific functionalisation reactions can therefore be implemented. For example, Wang *et al.* synthesised hyperbranched poly(amido amine) using an A_3 and B_2 monomer combination and obtained a product with predominantly acrylic terminal groups when using a molar ratio $A_3:B_2$ of 1:1, and a product predominantly terminated with secondary amine groups when using a monomer molar ratio $A_3:B_2$ of 1:2¹. The former was subsequently modified with 1-methyl piperazine (MPZ) while the latter was modified with methyl acrylate (MA) and poly(ethylene oxide) (PEO) to introduce hydrophilic groups at the periphery of the structure².

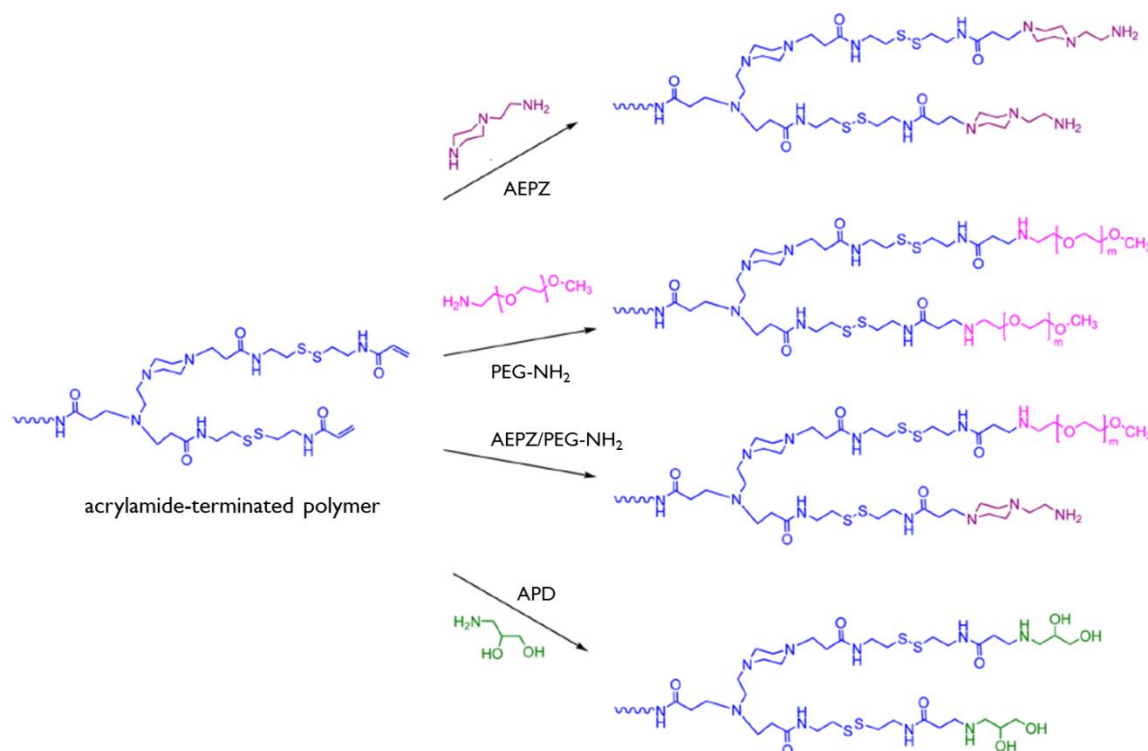

Figure 5.1 Functionalisation of hyperbranched acrylamide terminated poly(amido amine) with AEPZ, PEG-NH₂, a mixture AEPZ/PEG-NH₂ and APD³.

Ping *et al.* similarly synthesised acrylamide-terminated hyperbranched poly(amido amine)s by using an A_2 and B_2 monomer pair with a molar ratio $A_2:B_2$ of 3:1.5³. In this work they functionalised the resulting polymer (Figure 5.1) with: (i) primary amines by using 1-(2-aminoethyl)piperazine (AEPZ); (ii) PEG chains via α -amino- ω -methoxy-poly(ethylene glycol)

(PEG-NH₂); (iii) primary amines and PEG chains by using a mixture of AEPZ and PEG-NH₂ and (iv) hydroxyl groups by end-capping the polymer with 3-amino-1,2-propanediol (APD). The resulting functionalised polymers showed redox-responsive properties for gene delivery. Many other examples of hyperbranched poly(amido amine)s which have been modified by a post-polymerisation strategy have been reported including by reaction with phenylalanine⁴, aminopropyl cellulose⁵ and folic acid⁶. Modification via post-polymerisation reaction is particularly necessary when the desired functional groups may interfere with the polymerisation reaction e.g. primary amines. In all cases where the chosen functionalisation agent does not interfere with the polymerisation reaction, the polymer can be functionalised during the polymerisation reaction by selecting suitable monomers or co-monomers bearing the desired functional groups. However, in some cases, it is desirable that the functionalisation agent interferes with the polymerisation in order to avoid specific side reaction such as gelation. An example has been described in Chapter 3 of this work where the use of an A-monomer that competes with A₂ monomer for the reaction with B₄ has been discussed. For hyperbranched poly(amido amine)s only a very few examples of functionalising the polymer during the polymerisation are reported in the literature. Hydroxyl terminated hyperbranched poly(amido amine) was synthesised using triacrylamide (A₃) and 3-amino-1,2-propanediol (B₂) with an equimolar feed ratio⁷. In this case the B₂-monomer carries both the amino and hydroxyl functional groups, thereby allowing the polymerisation with A₂ to proceed largely unaffected with simultaneous functionalisation of the polymer with alcohol groups. Moreover, degradable poly(amido amine) nanoparticles functionalised with galactose were synthesised in a one-pot polymerisation of N,N'-cystaminebisacrylamide (CBA) as the A₂-monomer, 1-(2-aminoethyl)piperazine (AEPZ) as B'B₂-monomer and galactosamine (N-Gal) as B₂ co-monomer (with B' = -NH-; B₂ = -NH₂)⁸. A molar ratio A₂:B'B₂:B₂ of 2:1:2 was used to synthesise the functionalised crosslinked polymer that was reported to act as a drug deliver agent; N-Gal was selected as co-monomer because the presence of Gal on the shell of the polymer nanoparticle confers specific affinity towards target cells such as the liver tumour cells in this case⁹.

Beyond the introduction of specific functional groups, the properties of poly(amido amine)s can also be modified by quaternisation of the amino groups within the polymer structure, thereby conferring a cationic character to the polymer. In fact, one attractive feature of hyperbranched poly(amido amine)s is the rapid protonation the amino groups at low pH. In this way protonated polymers have been synthesised by (i) isolating the polymer by freeze-drying after dialysis

against distilled water acidified with HCl to pH 3¹⁰ or (ii) precipitation of the reaction mixture directly into acetone containing 5% v/v of 37% HCl³. Alternatively, the amine groups within the hyperbranched poly(amido amine)s can be quaternised via post-polymerisation alkylation, for example hyperbranched PAMAM was modified by methylation with dimethyl sulphate in methanol¹¹. Moreover, a straightforward method for the synthesis of cationic hyperbranched poly(amido amine)s was proposed by Hobson *et al.* who carried out the melt polymerisation of an AB₂ monomer containing ammonium (B) and acrylamide (A) groups¹². This last strategy has already been discussed in the section 3.4.3 and applied to the current A₂ + B₄ system with the aim of synthesising gel-free hyperbranched poly(ester amine).

5.2 Aims of the current work

Hyperbranched poly(amido amine)s (HPAMAMs) have been successfully synthesised by aza-Michael addition of the monomers MBA (A₂) and EDA (B₄) as described in Chapter 4. Gelation was avoided by using an excess of acrylamide groups (the molar ratio MBA:EDA used was 3:1) and stopping the reaction after 24h. Choosing a suitable reaction time not only inhibits gelation but can also define the final molecular weight of the polymer. Moreover, it has been shown that the stability of the synthesised hyperbranched poly(amido amine)s is a further issue that has to be considered, as their instability in water leads to both chain-coupling and degradation of the polymer (section 4.4.1.4.1). The occurrence of chain-coupling has been also observed when the bulk polymer is not stored in dry conditions. In light of these results, the present work aims to develop routes for the modification/functionalisation of HPAMAMs during polymerisation by using strategies that provide a further path to inhibit gelation and limit degradation of the polymer upon storage. Such strategies are below presented.

Functionalization by A₂ + B₄ + X strategy.

As mentioned above, functionalisation during polymerisation has already been reported for (i) hyperbranched poly(amido amine) by using the A₃ + B₂ strategy in which the B₂ monomer, contains additional, non-reactive functionalities (e.g. hydroxyl groups)⁷ and (ii) for the synthesis of crosslinked poly(amido amine) nanoparticles using a three component system A₃ + B'B₂ + B₂ with B₂ acting as a co-monomer for the introduction of the desired functionalities on the periphery of the polymer⁸. Moreover, it has been reported in the literature that the introduction of a third reactive compound, during a double monomer polymerisation which has a tendency to undergo gelation, is an effective way to inhibit crosslinking and to offer some control over the ultimate structure and molecular weight of the resulting polymer. This strategy has been

explored for the synthesis of hyperbranched poly(ethylene terephthalate) (PET) by using the following systems; $A_2 + B_2 + A_3$ ¹³, $A_2 + B_2 + B_3$ (or B_4) + B ¹⁴ and $A_2 + B_4 + B$ ¹⁵. Inspired by results found in the literature, a novel strategy was developed with the aim of adding a third comonomer (X) to the $A_2 + B_4$ system described earlier in this thesis. It was hoped that such a strategy would allow functionalisation, control the MW of the polymer and inhibit gelation. The objectives of the proposed $A_2 + B_4 + X$ strategy are thus:

- (i) To provide an alternative route for the synthesis of gel-free polymers. In order to establish the efficiency of the mono-functional monomer to inhibit gelation, the functionalisation/copolymerisation reaction will be carried out under conditions that would otherwise lead to gelation. This situation can be achieved by decreasing the molar ratio of A_2 (MBA): B_4 (EDA) from 3:1 (formation of soluble product) to 2.5:1 which has been previously shown to result in gelation.
- (ii) To regulate the molecular weight of the polymers without the need to stop the reaction at a particular conversions. To this end an A-monomer (N-(3-methoxypropyl)acrylamide - MPAM) was used together with A_2 (MBA) and B_4 (EDA) and the mole fraction of MPAM was systematically varied in the polymerisation 2.5MBA:1EDA to assess the impact of the amount used on the molecular weight of the resulting polymer.
- (iii) To functionalise the resulting polymer to confer specific properties. In this case two different 'A monomers' were investigated (Scheme 5.1):
 - a. $A_2 + B_4 + A$ in which A is a monomer (MPAM) bearing an acrylamide group with similar reactivity to the A groups of the MBA (A_2 monomer). In this case the polymerisation reaction (MBA-EDA) and the end-capping reaction should occur in parallel via competing aza-Michael addition reactions. MPAM hence decorates the polymer with methoxy groups by end-capping a portion of the N-H groups of the branching monomer B_4 .
 - b. $A_2 + B_4 + C$ in which C is a monomer bearing a succinic anhydride as the reactive group and a hydrophobic aliphatic side chain. In this system two different reactions proceed in competition, i.e. nucleophilic substitution and conjugate addition. Although, the use of a 'C' monomer introduces further complexity to the system, preliminary studies to understand the behaviour of this system will be reported.

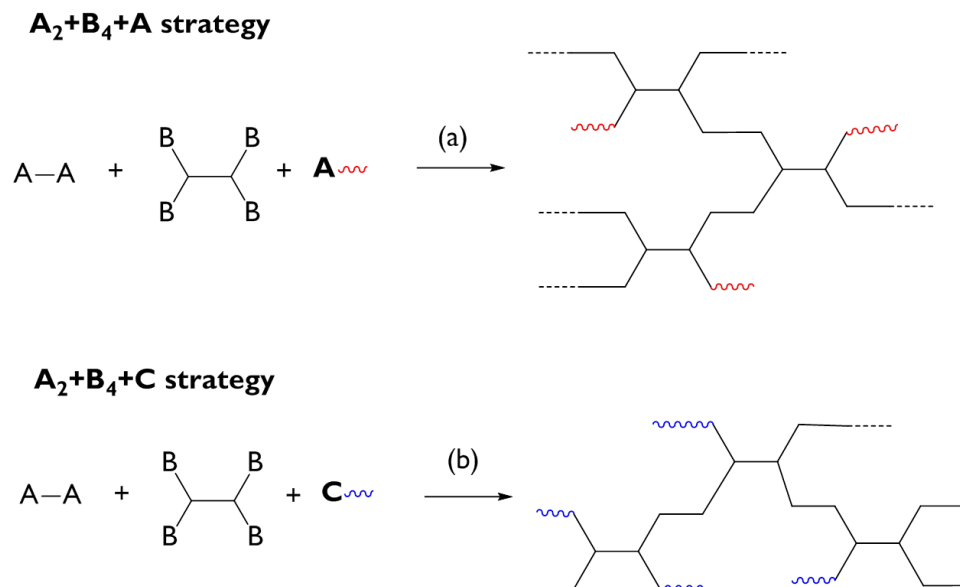

Scheme 5.1 Synthetic strategies used for the functionalisation of hyperbranched poly(amido amine)s via three components system.

- (iv) To enhance the long-term stability of the polymers in water and in the bulk. The monofunctional-monomer can act as an end-capper to reduce the possibility of subsequent chain-coupling by reducing the number of unreacted functional groups remaining after the polymerisation. Thus, the stability in water of the end-capped hyperbranched poly(amido amine) synthesised has been investigated. Moreover, in Chapter 4 it has been shown that the onset of decomposition occurs preferentially on the terminal units.

Synthesis of cationic hyperbranched poly(amido amine)s

The second strategic approach to modify the hyperbranched poly(amido amine)s involves the synthesis of cationic hyperbranched poly(amido amine)s by quaternisation of the amine groups. Two variations on this approach are discussed: direct polymerisation and post-polymerisation. The synthesis of cationic HPAMAMs by direct polymerisation was first proposed by Feast *et al.*¹⁶ who used a single monomer methodology to polymerise an ammonium salt monomer. Inspired by that work, a modified strategy is applied here, to synthesise cationic hyperbranched poly(amido amine)s by the direct polymerisation of A₂ and B₄ monomers (double monomer methodology) MBA and hexamethylenediamine dihydrochloride (HDDC). HDDC is the hydrochloride salt of a B₄ amine monomer and for this reason, activation to generate a portion of the free amine is necessary to promote the aza-Michael addition of MBA and HDDC. This strategy has been already introduced in Chapter 3, whereby the aim was to increase the stability of PEAs. The results obtained in that case also showed that the use of HDDC monomer inhibits

gelation during polymerisation. This strategy constitutes a novel approach for the development of a cationically-charged hyperbranched poly(amido amine)s. Previous reports on the synthesis of cationic hyperbranched PAMAMs generally involved post-polymerisation quaternisation, by precipitation of the polymerisation mixture in acidic conditions or by alkylation of the polymer. As mentioned here, cationic hyperbranched PAMAMs can also be obtained by alkylation of the resulting polymer (by post-polymerisation) and we also report the quarterisation of the polymeric secondary and tertiary amines using methyl iodine in DMF.

5.3 Experimental

5.3.1 Materials

N,N'-methylenebis(acrylamide) (MBA, 99%), ethylenediamine (EDA, ReagentPlus®, ≥99%), N-(3-methoxypropyl)acrylamide (MPAM, 95 % contains MEHQ as inhibitor), hexamethylenediamine dihydrochloride (HDDC, 99%), 4-(dimethylamino)pyridine (DMAP, ReagentPlus®, ≥99%), methyl iodide (ReagentPlus® 99.5% contains copper as stabiliser), triethylamine (TEA, ≥99%), hydrochloric acid (HCl, ACS reagent, 37 %), dimethyl sulfoxide-d₆ (DMSO-d₆ 99.96 atom % D), chloroform-d (CDCl₃ 99.96 atom % D), were purchased from Sigma-Aldrich as used as received. Polyisobutylene succinic anhydride (PIBSA, 80% BASF) was provided by Croda. Distilled water, methanol (analytical reagent grade), tetrahydrofuran (laboratory reagent grade), acetone (laboratory reagent grade), N',N'-dimethylformamide (DMF, anhydrous, 99.8%), were purchased from Fisher scientific and used without any purification. Poly(ethylene oxide) (PEO) and poly(styrene) (PS) standards were purchased from Polymer Laboratories.

5.3.2 Characterisation techniques

Size exclusion Chromatography (SEC)

The number-average molecular weight (M_n), weight-average molecular weight (M_w) and dispersity (\mathcal{D}) were determined by size exclusion chromatography (SEC).

The HPAMAM 1.A polymers (see structure in Figure 5.2) were analysed on a Viscotek TDA 301, using 2 x 300 mm PLgel 5 μ m mixed C columns with a linear range of molecular weight from 200 - 2,000,000 g/mol. DMF with 0.1% of LiBr was used as the mobile phase at a flow rate of 1.0 ml/min at 70 °C. The molecular weight was determined by means a conventional calibration curve (log MW vs. RV) which was set up using a series of narrow molecular weight poly(ethylene oxide) (PEO) standards (Polymer Labs). The HPAMAM 1.C polymers (Figure

5.2) were analysed on a Viscotek TDA 302, using 2 x 300 mm PLgel 5 μm mixed C columns with a linear range of molecular weight from 200-2,000,000 g/mol. The solvent was THF, the flow rate was 1.0 ml/min at a temperature of 35°C. The molecular weight was calculated by RI detector according to the conventional calibration of narrow molecular weight polystyrene (PS) standards.

Solution Nuclear Magnetic Resonance

^1H -NMR and ^{13}C -NMR spectroscopy were carried out on a Varian spectrometer at 700 MHz and 176 MHz respectively (298 K). 2D-NMR, ^1H , ^{13}C -HMBC and ^1H , ^{13}C -HSQC spectra, were obtained using a standard pulse sequence to assign the polymer structure. The spectra were referenced to the trace of hydrogenous solvent in the deuterated NMR solvent. $(\text{CD}_3)_2\text{SO}$ was used as the solvent for 1D and 2D-NMR measurements of the HPAMAM 1.A polymers and for the cationic hyperbranched polymer HPAMAM 4 and HPAMAM 5 (Figure 5.2) [$\delta(^1\text{H})=2.50$ ppm; $\delta(^{13}\text{C})=39.52$ ppm] while CDCl_3 was used for the HPAMAM 1.C polymer [$\delta(^1\text{H})=7.26$ ppm; $\delta(^{13}\text{C})=77.16$ ppm]. Quantitative ^{13}C -NMR spectra were obtained by using inverse gated decoupling, recording the signals for 5 hours with a relaxation delay of 10.0 seconds and a pulse of 45.0 degrees to quantify the structural units of the polymer.

Solid-state ^{15}N -Nuclear Magnetic Resonance

Cation hyperbranched polymers HPAMAM 4 and HPAMAM 5 were also analysed by solid state ^{15}N -NMR using a Varian VNMRS spectrometer with a 9.4 T magnet operating at 40.527 MHz for ^{15}N nuclei. The spectra were referenced to the chemical shift of the nitromethane (CH_3NO_2) used as reference compound. Spectra were obtained using cross polarisation (CP) and magic-angle spinning (SPA) with a 3.00 ms contact time, a 10.0 s recycle delay and at spin-rate of approximately 6 kHz. Spectra were recorded without and with interrupted decoupling (ID) with a 200 μs dephasing delay.

Stability in water

Aqueous solutions (18% w/v) of the HPAMAM 1 and HPAMAM 1.A polymers were prepared. Aliquots of the solutions were periodically analysed by SEC analysis and ^1H and ^{13}C -NMR to determine the molecular weight and to identify the possible presence of decomposition products.

5.3.3 Polymer synthesis

Polyaddition 2.5MBA-1EDA-xMPAM ($2.5 \leq x \leq 0.8$): synthesis of end-capped/functionalised HPAMAM 1.A.

A series of HPAMAM 1.A polymers (with A=MPAM, see Figure 5.2) were prepared by maintaining the mole ratio A₂:B₄ unchanged (2.5:1) but varying the mole ratio of MPAM from 2.5 to 0.8. The different polymers are identified as follow:

Table 5.1 Samples codes for the HPAMAM 1.A-type polymers.

Samples code	Mole Ratio A ₂ :B ₄ :A
HPAMAM 1.A1	2.5:1:0.8
HPAMAM 1.A2	2.5:1:1
HPAMAM 1.A3	2.5:1:1.1
HPAMAM 1.A4	2.5:1:1.2
HPAMAM 1.A5	2.5:1:1.3
HPAMAM 1.A6	2.5:1:1.8
HPAMAM 1.A7	2.5:1:2.5

HPAMAM 1.A7: in a typical reaction MBA (1.00 g, 6.50 mmol), and MPAM (0.93 g, 6.50 mmol) were dissolved in 9.8 ml (18% w/v) of methanol/water (70/30 v/v) in a round bottom flask (100 ml). EDA (0.165 g, 2.60 mmol) was subsequently added to the solution. The mixture was stirred under a nitrogen atmosphere at 40 °C for 3 days. The final product was recovered by precipitation in acetone with a yield of 45%. SEC analysis (DMF+0.1%LiBr - PEO stds): $M_n = 2200$ g/mol; $M_w = 4100$ g/mol; $\bar{D} = 1.8$, ¹H-NMR (700MHz, d-DMSO): % MPMA reacted = 17% and % MBA reacted = 85% (calculated on the crude reaction mixture); ¹³C-NMR (176MHz, d-DMSO), $DB' = 0.95$.

HPAMAM 1.A6: according to the method described above, MBA (1.00 g, 6.50 mmol), MPAM (0.67 g, 4.68mmol) and EDA (0.165 g, 2.60 mmol) were reacted in 8.5 ml of methanol/water. Product: yield 50%; SEC analysis (DMF+0.1%LiBr - PEO stds): $M_n = 2250$ g/mol; $M_w = 15600$ g/mol; $\bar{D} = 6.5$; ¹H-NMR (70MHz, d-DMSO): 15% MPAM (calculated on the reaction mixture after 3 days), ¹³C-NMR (176MHz, d-DMSO): $DB' = 0.93$.

HPAMAM 1.A5: according to the method described above, MBA (1.00 g, 6.50 mmol), MPAM (0.48 g, 3.38 mmol) and EDA (0.165 g, 2.60 mmol) were reacted in 7.6 ml of methanol/water. Product: yield 63%; SEC analysis (DMF+0.1%LiBr - PEO stds): $M_n = 3500$ g/mol, $M_w = 27000$ g/mol, $\bar{D} = 7.5$; ¹H-NMR (700 MHz, d-DMSO): % MPMA reacted= 12% (calculated on the reaction mixture not purified); ¹³C-NMR (176 MHz, d-DMSO), $DB' = 0.95$.

HPAMAM 1.A4: according to the method described above, MBA (1.00 g, 6.50 mmol), MPAM (0.44 g, 3.12 mmol) and EDA (0.165 g, 2.60 mmol) were reacted in 7.4 ml of methanol/water. Product: yield 55 %; SEC analysis (DMF+0.1%LiBr - PEO stds): $M_n=4100$ g/mol; $M_w=30500$ g/mol; $D=7.5$, $^{13}\text{C-NMR}$ (176MHz, d-DMSO): $DB'=0.94$.

HPAMAM 1.A3: according to the method described above, MBA (1.00 g, 6.50 mmol), MPAM (0.41 g, 2.86 mmol) and EDA (0.165 g, 2.60 mmol) were reacted in 7.1 ml of methanol/water. Product: Yield 65%; SEC analysis (DMF+0.1%LiBr - PEO stds): $M_n=4700$ g/mol; $M_w=74200$ g/mol; $D=15.5$, $^{13}\text{C-NMR}$ (176MHz, d-DMSO): $DB'=0.95$.

HPAMAM 1.A2: according to the method described above, MBA (1.00 g, 6.50 mmol), MPAM (0.37 g, 2.60 mmol) and EDA (0.165 g, 2.60 mmol) were reacted in 7.1 ml of methanol/water. A sol-gel product was recovered with 65% yield. Soluble fraction: SEC analysis (DMF+0.1%LiBr - PEO stds) $M_n=4350$ g/mol; $M_w=74400$ g/mol; $D=17.0$, $^1\text{H-NMR}$ (d-DMSO): 8% MPAM and 90% MBA conversion (calculated on the reaction mixture after 3 days), $^{13}\text{C-NMR}$ (176MHz, d-DMSO): $DB'=0.96$. The reaction is high sensitive to gelation and a gel was recovered by repeating the reaction with 90% yield.

HPAMAM 1.A1: according to the method described above, MBA (1.00 g, 6.50 mmol), MPAM (0.30 g, 2.08 mmol) and EDA (0.165 g, 2.60 mmol) were reacted in 6.8 ml of methanol/water. A gel product was recovered from the reaction (yield 85 %).

$^1\text{H-NMR}$ (700MHz, d-DMSO): 8.62 and 8.50 ppm (m, 2H, $-\text{NHCH}_2\text{NHC}(\text{O})\text{CH}=\text{CH}_2$, MBA), 7.86 (1H, $-\text{NHCH}_2-$, MPAM), 6.28, 6.11 and 5.65 ppm (m, 3H, $-\text{CH}=\text{CH}_2$, MBA), 4.42 and 4.35 ppm (m, 2H, $-\text{NHCH}_2\text{NHC}-$, MBA), 3.29 (m, 2H, $-\text{NHCH}_2\text{CH}_2\text{CH}_2\text{OCH}_3$, MPAM), 3.17 (s, 3H, $-\text{NHCH}_2\text{CH}_2\text{CH}_2\text{OCH}_3$, MPAM), 3.03 (m, 2H, $-\text{NHCH}_2\text{CH}_2\text{CH}_2\text{OCH}_3$, MPAM), 2.58 (m, 2H, $-\text{NCH}_2\text{CH}_2\text{N}(\text{CH}_2\text{CH}_2\text{C}(\text{O})-)_2$ end-capped and branched unit), 2.37 (m, 4H, $-\text{NCH}_2\text{CH}_2\text{NH}-$ end-capped and branched unit), 2.18 (m, 2H, $-\text{NCH}_2\text{CH}_2\text{N}(\text{CH}_2\text{CH}_2\text{C}(\text{O})-)_2$ branched unit), 2.12 ((m, 2H, $-\text{NCH}_2\text{CH}_2\text{NR}(\text{CH}_2\text{CH}_2\text{C}(\text{O})-)$ end-capped unit), 1.56 (m, 2H, $-\text{NHCH}_2\text{CH}_2\text{CH}_2\text{OCH}_3$, MPAM) .

$^{13}\text{C-NMR}$ (176MHz, d-DMSO): 172.52 ($-\text{C}(\text{O})\text{CH}_2\text{CH}_2\text{N}-$, MBA), 165.32 ($-\text{C}(\text{O})\text{CH}=\text{CH}_2$, MBA), 131.85 and 126.36 ($-\text{CH}=\text{CH}_2$, MBA), 70.00 ($-\text{NHCH}_2\text{CH}_2\text{CH}_2\text{OCH}_3$, MPAM), 58.30 ($-\text{NHCH}_2\text{CH}_2\text{CH}_2\text{OCH}_3$, MPAM), 52.30 and 51.38 ($-\text{NCH}_2\text{CH}_2\text{NH}-$ end-capped and branched unit), 50.00 ($-\text{NCH}_2\text{CH}_2\text{N}(\text{CH}_2\text{CH}_2\text{C}(\text{O})-)_2$ end-capped and branched unit), 43.65 ($-\text{NHCH}_2\text{NHC}-$, MBA), 36.10 ($-\text{NHCH}_2\text{CH}_2\text{CH}_2\text{OCH}_3$, MPAM), 34.95 ($-\text{NHCH}_2\text{CH}_2\text{CH}_2\text{OCH}_3$, MPAM).

NCH₂CH₂NR(CH₂CH₂C(O)-) end-capped unit), 33.35 (-NCH₂CH₂N(CH₂CH₂C(O)-)₂ branched unit), 29.65 (-NHCH₂CH₂CH₂OCH₃, MPAM).

Polyaddition 2.5MBA-1.5EDA-xPIBSA (x = 1 and 0.5): synthesis of end-capped/functionalised hyperbranched HPAMAM 1.C.

A series of HPAMAM 1.C polymers (with C=PIBSA monomer, see structure in Figure 5.2) were prepared at different mole ratios A₂:B₄:C and the polymers identified as follow:

Samples code	Mole Ratio A ₂ :B ₄ :C
HPAMAM 1.C1	2.5:1:1
HPAMAM 1.C2	2.5:1.5:1
HPAMAM 1.C3	2.5:1.5:0.5

HPAMAM 1.C3: a solution of MBA (1.50 g, 9.73 mmol) in methanol (12 ml) was added to a solution of PIBSA (2.43 g, 1.95 mmol) and DMAP (0.24 g, 1.95 mmol) in THF (28 ml). EDA (0.35 g, 5.84 mmol) was hence added the solution. The mixture was stirred under a nitrogen atmosphere at 50 °C for 3 days. The polymer was recovered by precipitation in acetone, washed in water and dried in vacuo with a yield of 45 %. SEC analysis (THF+1% v/v TEA): M_n 1400 g/mol, M_w 2140 g/mol, Đ 1.5 (PS standards); ¹H-NMR (700MHz, CDCl₃): 65% acrylamide conversion (calculated on the reaction mixture).

HPAMAM 1.C2: according to the method described above MBA (1.50 g, 9.73 mmol), PIBSA (4.86 g, 3.90 mmol), DMAP (0.48 g, 3.90 mmol) and EDA (0.35 g, 5.84 mmol) were reacted in ~60 ml of MeOH/THF (70/30 v/v) at 50°C for 3 days. Yield: 50 %, SEC (THF+1%v/v TEA): M_n 2000 g/mol, M_w 2950 g/mol, Đ 1.5 (PS standards); ¹H-NMR (700MHz, CDCl₃): 65% acrylamide conversion (calculated on the reaction mixture).

HPAMAM 1.C1: a solution of MBA (1.50 g, 9.73 mmol) in methanol (12 ml) was added to a solution of PIBSA (4.86 g, 3.90 mmol) in THF (28 ml). EDA (0.23 g, 3.90 mmol) was hence added to the solution. The mixture was stirred under a nitrogen atmosphere at 50 °C and after 2 hours a heterogeneous polymerisation mixture was obtained. The reaction was stopped, the reaction mixture dried under reduced pressure and analysed. ¹³C-NMR (176MHz, CDCl₃): % acrylamide conversion < 5%.

¹H-NMR (700MHz, CDCl₃): 8.70 (broad, s, -OH), 8.30 (s, -C(O)NH-), 6.85-6.25 (m, 3H, -CH=CH₂, MBA), 4.90 (m, -C=CH₂, PIBSA), 4.60 (m, 2H, -NHCH₂NHC-, MBA), 3.20 (m, 1H, -CH-, PIBSA), 3.00-1.40 (m, -CH₂-), 1.08 (s, -CH₃, PIBSA).

^{13}C -NMR (176MHz, CDCl_3): 180.0 ($-\underline{\text{C}}(\text{O})\text{OH}$), 177.0 ($-\underline{\text{C}}(\text{O})\text{NH}-$), 175.0 ($\underline{\text{C}}(\text{O})\text{CH}_2\text{CH}_2\text{N}-$, MBA), 165.0 ($-\underline{\text{C}}(\text{O})\text{CH}=\text{CH}_2$, MBA), 135.0 and 125.0 ($-\underline{\text{C}}\text{H}=\underline{\text{C}}\text{H}_2$, MBA), 156.0 (quaternary C, $-\underline{\text{C}}=\text{CH}_2$, PIBSA), 108.0 ($-\text{C}=\underline{\text{C}}\text{H}_2$, PIBSA), 59.0-35.0 ($-\text{CH}_2-$), 40.5 ($-\underline{\text{C}}\text{H}-$, PIBSA), 31.0 ($-\text{CH}_3$, PIBSA), 32.0 (quaternary C, chain PIBSA).

Polyaddition 3MBA-1HDDC: synthesis of hyperbranched hydrochloride HPAMAM 4.

MBA (1.75 g, 11.35 mmol) was dissolved in methanol/water 70/30 v/v (14 ml) at 40°C, HDCC (0.71 g, 3.78 mmol) was added to a solution and the mixture stirred for 3 days. The polymer was recovered by precipitation of the mixture in acetone containing 1 % w/w HCl 37% and then by washing the product in acetone. Yield 75 % w/w. ^1H -NMR (700MHz, d-DMSO): MBA reacted = 60% (calculated on the reaction mixture); ^{13}C -NMR (176MHz, d-DMSO): DB = 0.87.

^1H -NMR (700MHz, d-DMSO): 8.50, 8.10, 9.20 ($-\underline{\text{N}}\text{H}-$), 6.28-5.60 (m, 3H, $-\underline{\text{C}}\text{H}=\underline{\text{C}}\text{H}_2$, MBA), 4.47 and 4.40 (m, 2H, $-\text{NH}\underline{\text{C}}\text{H}_2\text{NHC}-$, MBA), 3.25-2.68 (m, $-\underline{\text{C}}\text{H}_2\text{N}-$ and $-\underline{\text{C}}\text{H}_2\text{NH}-$), 1.67 and 1.30 (m, 2H, $-\text{NCH}_2\underline{\text{C}}\text{H}_2\underline{\text{C}}\text{H}_2-$, HDDC).

^{13}C -NMR (176MHz, d-DMSO): 170.0 ($\underline{\text{C}}(\text{O})\text{CH}_2\text{CH}_2\text{N}-$, MBA), 164.9 ($-\underline{\text{C}}(\text{O})\text{CH}=\text{CH}_2$, MBA), 131.0 and 126.0 ($-\underline{\text{C}}\text{H}=\underline{\text{C}}\text{H}_2$, MBA), 51.95, 48.20, 46.50, 42.75 ($-\underline{\text{C}}\text{H}_2\text{N}-$ and $-\underline{\text{C}}\text{H}_2\text{NH}-$), 43.50 ($-\text{NH}\underline{\text{C}}\text{H}_2\text{NHC}-$, MBA), 30.90 ($-\text{C}(\text{O})\underline{\text{C}}\text{H}_2\text{CH}_2\text{NH}-$, L unit, MBA), 29.20 ($-\text{C}(\text{O})\underline{\text{C}}\text{H}_2\text{CH}_2\text{N}-$, B unit, MBA), 26.15, 23.18 ($-\text{NCH}_2\underline{\text{C}}\text{H}_2\underline{\text{C}}\text{H}_2-$, HDDC).

^{15}N -NMR (solid state, $\text{CH}_3^{15}\text{NO}_2$): -253.3 ($-\underline{\text{N}}\text{HC}(\text{O})-$), -324.1 ($-\text{R}_3\underline{\text{N}}\text{H}^+$), -337.5 ($-\text{R}_2\underline{\text{N}}\text{H}_2^+$).

Polyaddition 3MBA-1EDA followed by post-polymerisation alkylation: alkylated hyperbranched HPAMAM 5.

MBA (1.00 g, 6.50 mmol) was dissolved in 5.3 ml (18% w/v) of methanol/water (70/30 v/v) in a round bottom flask (100 ml). EDA (0.13 g, 2.16 mmol) was subsequently added to the solution. The mixture was stirred under a nitrogen atmosphere at 40 °C for 24 hours and the polymer recovered by removal of the solvent under reduced pressure. The branched product (impure) with a molecular weight (SEC (DMF+0.1LiBr - PEO std): M_n 630 g/mol, M_w 19700 g/mol, Đ 20.0; ^{13}C -NMR (176MHz, d-DMSO): DB=0.95), was dissolved in 5 ml of DMF and an excess of CH_3I (0.71 g, 5.00 mmol) was added. The solution was stirred for 24h at 50 °C and the reaction was stopped by precipitation in acetone. Yield 88 % w/w.

^1H -NMR (700MHz, d-DMSO): 3.10 (m, 3H, $\underline{\text{C}}\text{H}_3\text{N}^+\text{R}_3$), 3.85 (m, 4H, $-\text{NCH}_2\underline{\text{C}}\text{H}_2\text{N}-$, B unit, EDA), 3.56 (m, 2H, $-\underline{\text{C}}\text{H}_2\text{N}-$, MBA).

^{13}C -NMR (176MHz, d-DMSO): 48.70 ($\underline{\text{C}}\text{H}_3\text{N}^+\text{R}_3$), 53.50 ($-\text{N}\underline{\text{C}}\text{H}_2\underline{\text{C}}\text{H}_2\text{N}-$, B unit, EDA), 58.60 ($-\underline{\text{C}}\text{H}_2\text{N}-$, MBA).

^{15}N -NMR (solid state, $\text{CH}_3^{15}\text{NO}_2$): -251.5 ($-\underline{\text{N}}\text{HC}(\text{O})-$), -318.2 ($-\text{R}_3\underline{\text{N}}^+\text{CH}_3$).

5.4 Results and Discussion

In this section the modification of hyperbranched poly(amido amine)s is discussed. Four sets of polymers bearing different functional side groups and in some cases cationically charged, were synthesised by different strategies. The resulting hyperbranched polymers are labelled according to the relative structure (Figure 5.2): HPAMAM 1.A (poly(MBA-EDA-MPAM)), HPAMAM 1.C (poly(MBA-EOBEA-PIBSA)), HPAMAM 4 (poly(MBA-HDDC)) and HPAMAM 5 (methylated poly(MBA-EDA)).

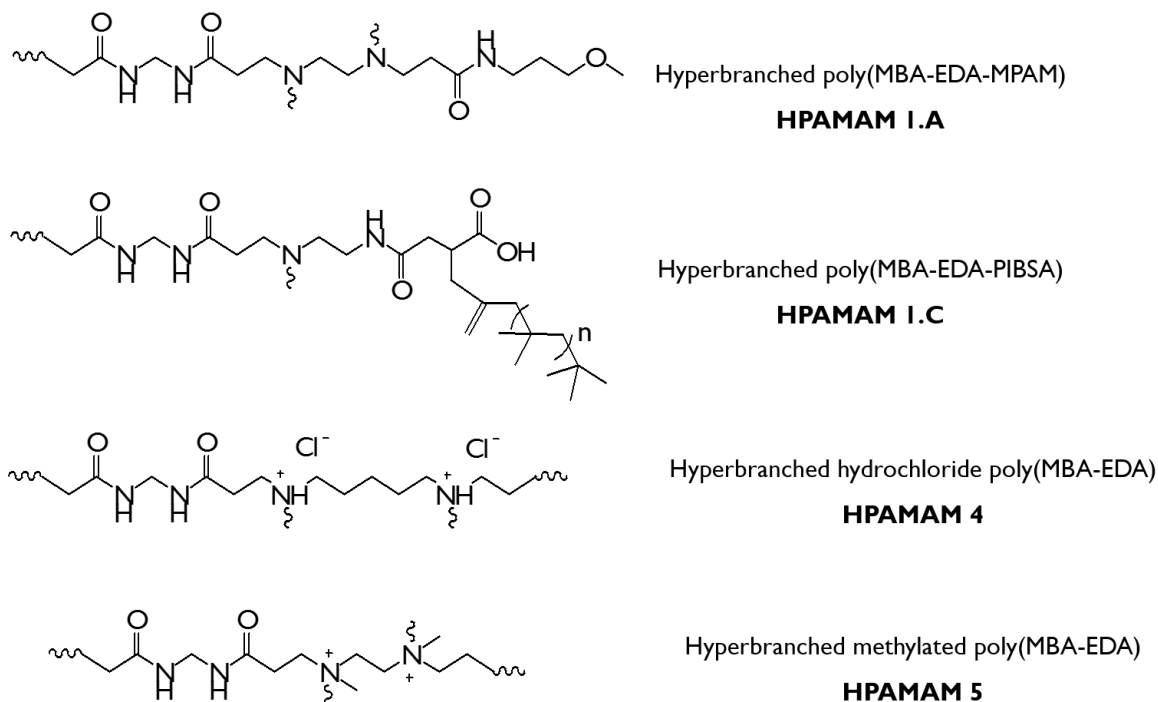
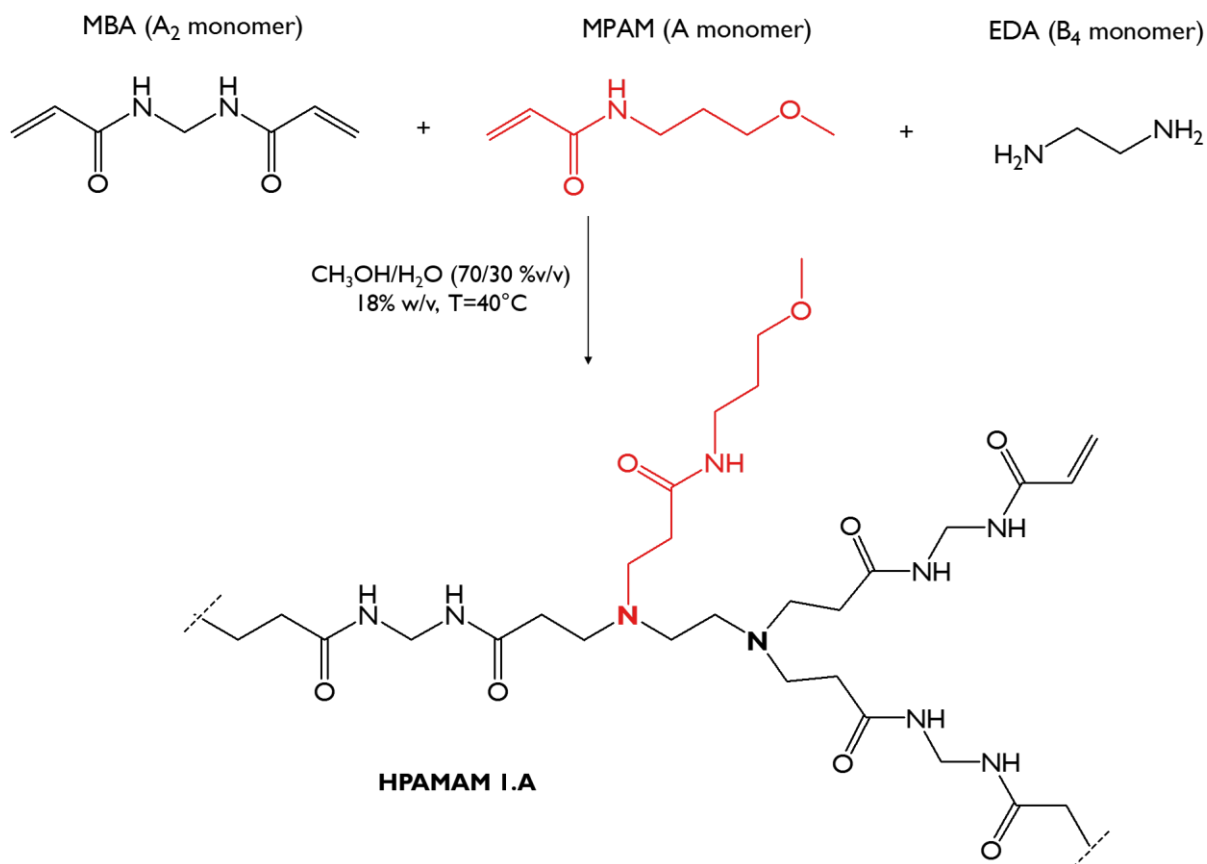

Figure 5.2 Modification of the hyperbranched polymers synthesised by Michael addition polymerisation.

5.4.1 Synthesis of end-capped hyperbranched poly(amido amine)s by $\text{A}_2 + \text{A} + \text{B}_4$ strategy

Functionalised hyperbranched poly(amido amine)s were synthesised by the aza-Michael addition of MBA (A_2 , linear building block) and EDA (B_4 , branched building block) monomers

in the presence of a mono-functional, end-capping co-monomer N-(3-methoxypropyl)acrylamide, MPAM (A) – see Scheme 5.2.



Scheme 5.2 Synthesis of functionalised hyperbranched poly(amido amine) HPAMAM 1.A via Michael addition polymerisation of MBA-EDA-MPAM monomers.

MPAM was chosen as the mono-functional co-monomer to end-cap the branched monomer (B_4) and simultaneously study the impact of a third (monofunctional) monomer bearing the same reactive ‘A’ functionality as MBA, the A_2 monomer, on the Michael addition polymerisation. Since all ‘A’ functionalities are the same, they should all have a similar reactivity. Thus, MBA and MPAM act as competing aza-Michael acceptors towards the diamine monomer EDA (aza-Michael donor). The reactions were carried out in methanol/water (70/30 %v/v) with a total monomer concentration of 18% w/v, at $40^\circ C$. Different molar ratios of $A_2:A:B_4$ were investigated and the polymerisations were stopped after 3 days by precipitation of the reaction mixture in acetone. It is worth noting that the molar ratios of $A_2:B_4$ used would ordinarily lead to gelation within 24 hours in the absence of the monofunctional A monomer.

5.4.1.1 Structure and characterisation

The polyaddition MBA-MPAM-EDA was carried out for 3 days and during the polymerisation, samples were withdrawn from the reaction mixture for analysis by SEC (DMF-RI detector, PEO standards), 1D, ^1H and ^{13}C -NMR, and 2D-NMR.

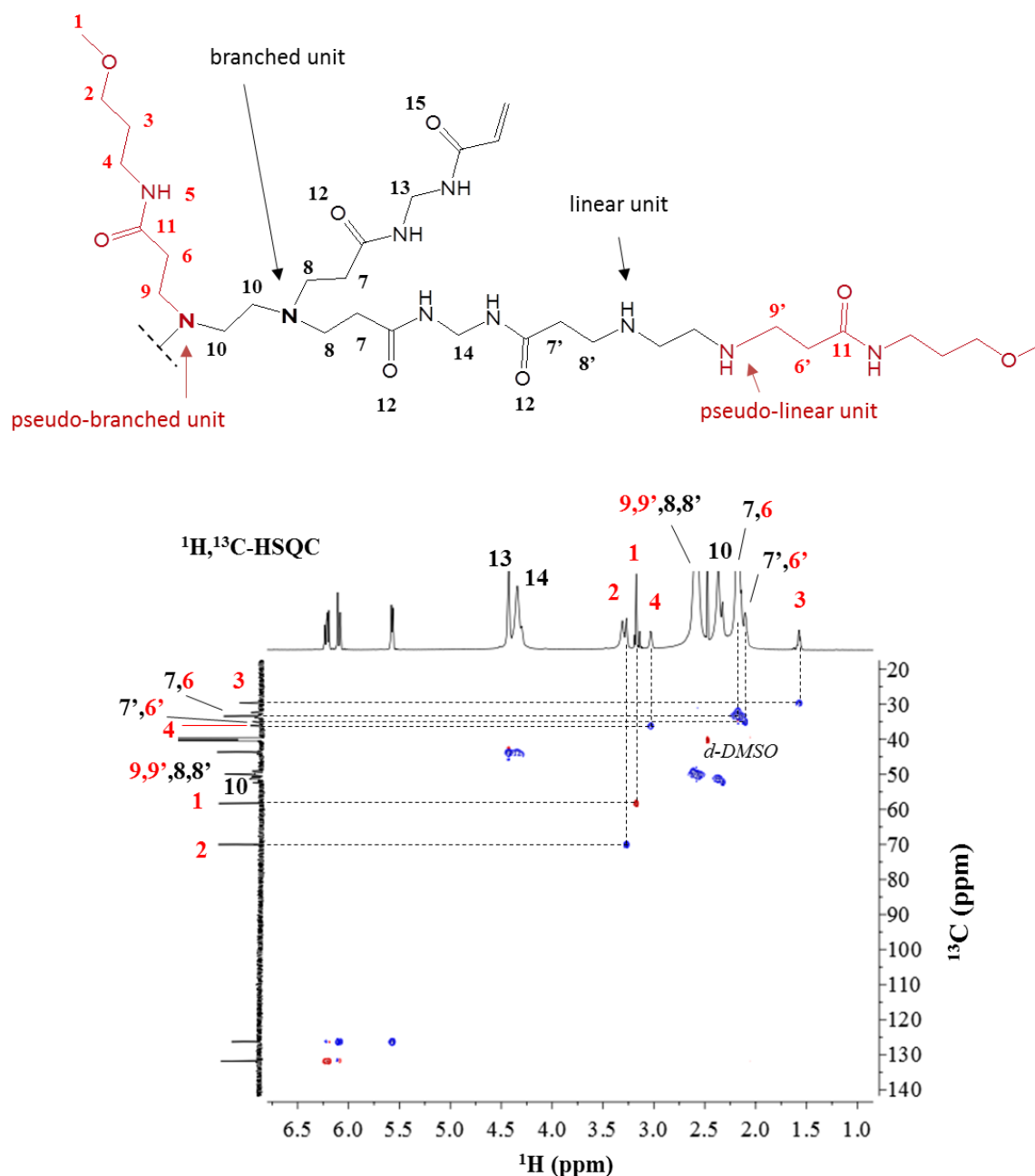

Figure 5.3 Typical ^1H , ^{13}C -HSQC of the product HPAMAM 1.A recovered by precipitation from the polyaddition between MBA (A₂), EDA (B₄) and MPAM (A) and assignment of the structure (depicted on top).

1D-NMR was used to follow the progress of the reaction in terms of MBA and MPAM conversion, and 2D-NMR was used for the assignment of the structure of the polymer. After 3 days the product was precipitated in acetone, recovered by filtration and dried in vacuo. The full structural assignment of the polymer obtained from MBA and EDA (HPAMAM 1) without

MPAM has been previously presented in Chapter 4 therefore here, the focus will be on the identification of the end-capped units and on the ability of MPAM to take part in and influence the reaction (Scheme 5.2). Figure 5.3 and Figure 5.4 show typical $^1\text{H},^{13}\text{C}$ -HSQC and $^1\text{H},^{13}\text{C}$ -HMBC spectra of the hyperbranched polymer which, in this case was synthesised using a molar ratio $A_2:A:B_4$ of 2.5:1.3:1. The signals in the 1D-NMR corresponding to the end-capped units are numbered in red according to the structure shown at the top of Figure 5.3. The presence of such signals is evidence that the MPAM monomer took part in the reaction and their coupling in the $^1\text{H},^{13}\text{C}$ -HSQC and $^1\text{H},^{13}\text{C}$ -HMBC spectra confirm the assignments to the MPAM monomer. The identification of peaks corresponding to the reacted MPAM in the NMR spectra of the polymer, was based on the ^{13}C and ^1H -NMR spectra of the MPAM starting material. The methoxy group in particular, is easily identifiable in the $^1\text{H},^{13}\text{C}$ -HSQC (Figure 5.3) since coupling between carbon 1 and proton 1 produces a peak with a different colour compared to others. The colour indicates the phase and the multiplicity of a certain group, thus the difference in colour of such a peak supports the assignment to the $-\text{CH}_3$ of the methoxy group. The coupling in the $^1\text{H},^{13}\text{C}$ -HMBC spectra (Figure 5.4, (a)) of carbon signal 2 with proton signals 1 and 3 also confirms the presence of an end-capped unit on the polymer (see Figure 5.3 for the polymer structure). The successful reaction of MPAM is further evidenced by the presence of the carbonyl carbon 11 at c.a. 172.0 ppm (Figure 5.4, (b)). The chemical shift of this peak confirms the reaction of the acrylamide group as the same carbonyl carbon peak is observed at c.a.165.0 ppm in the pure monomer. The coupling in Figure 5.4 (b) of carbon peak 11 with proton peaks 4, 5, 6 and 6' proves the correct assignment of this carbon to the reacted MPAM unit. On the other hand, the polymerisation reaction between MBA and EDA is confirmed by the presence of peaks 7, 8 and 10 (Figure 5.3 and Figure 5.4) corresponding to the methylene group formed during the polymerisation, by the presence of peaks 13 and 14 in the proton spectra belonging to methylene of the reacted MBA and peak 12 in the carbon spectra corresponding to the carbonyl of the reacted acrylamide groups. The signals of the polymer backbone are numbered in black according to the structure shown in Figure 5.3. The couplings of these peaks have been already discussed in Chapter 4.

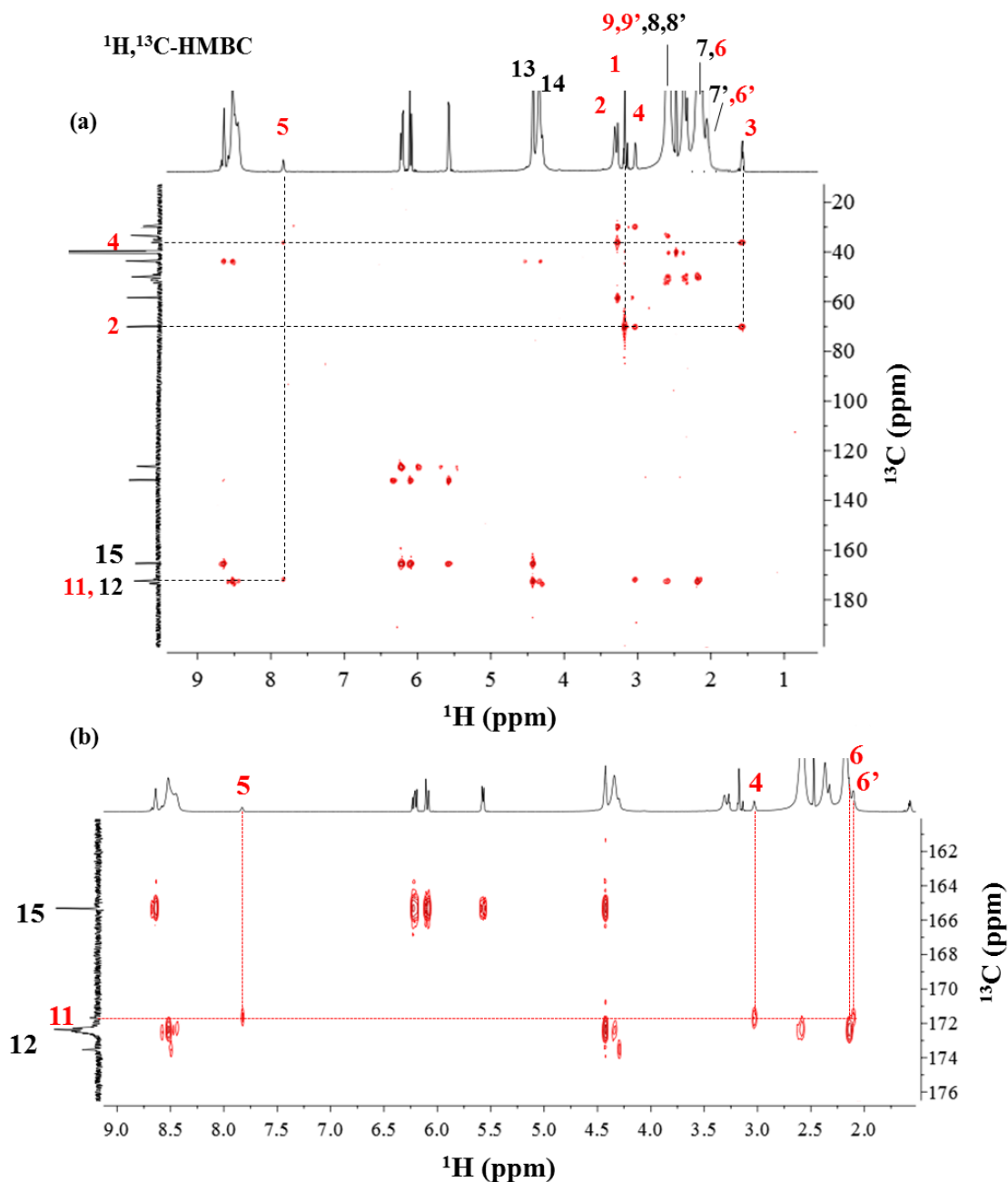

Figure 5.4 (a) Typical $^1\text{H},^{13}\text{C}$ -HMBC spectra of the product recovered by precipitation from the polyaddition between MBA (A_2), EDA (B_4) and MPAM (A). (b) Enlargement of the $^1\text{H},^{13}\text{C}$ -HMBC spectra that confirms the reaction of the MPAM monomer with EDA (see structure in Figure 5.3 for the assignment).

The 1D-NMR spectra of the intermediate products (analysed without purification) also permits a calculation of the percentage of MPAM (A) and MBA (A_2) monomers which are incorporated into the polymer during the reaction. The % of MPAM was calculated using the 1D ^1H -NMR data and in particular the methylene proton peak 3' which appears at 1.61 ppm in the monomer but changes to 1.56 ppm (peak 3) in the polymer (Figure 5.5). The relative integration of peak 3 and 3' can be used to calculate monomer conversion as follows:

$$\% \text{ MPAM reacted} = \frac{I_{1.56}}{(I_{1.56} + I_{1.61})} \cdot 100 \quad \text{Equation 5.1}$$

The conversion of MBA was calculated by $^1\text{H-NMR}$ according to Equation 4.1, as discussed in Chapter 4.

The identification of the structural units and therefore calculating the degree of branching (DB) of the MBA-EDA-MPAM polymer is more complex, since the MPAM and MBA monomers bear the same functional group which, in turn, means that it is not possible to distinguish between the branched and pseudo-branched units or between the linear and pseudo-linear units (see structure on the top of Figure 5.3). From the 2D-NMR spectra shown in Figure 5.3 and Figure 5.4, peaks corresponding to the branched (signals 7 and 8) and pseudo-branched (signals 6 and 9) units and linear (7' and 8') and pseudo-linear (6' and 9') of the polymer can be observed. Thus, for all the HPAMAM 1.A samples synthesised in this work, a DB' is defined, instead of DB, as the 'pseudo' units are included in the calculation. Although it was expected that the use of different amounts of end-capper would lead to a significant variation of the DB' of the polymer, the use of MPAM does not permit such an observation or confirmation by NMR. A DB' between 0.93 and 0.95 was obtained in all cases. It is an objective of future work to modify the present strategy by using an alternative co-monomer or characterisation method that enables the end-capped units to be distinguished from the branched and linear units, in turn to allow an accurate calculation of the degree of branching.

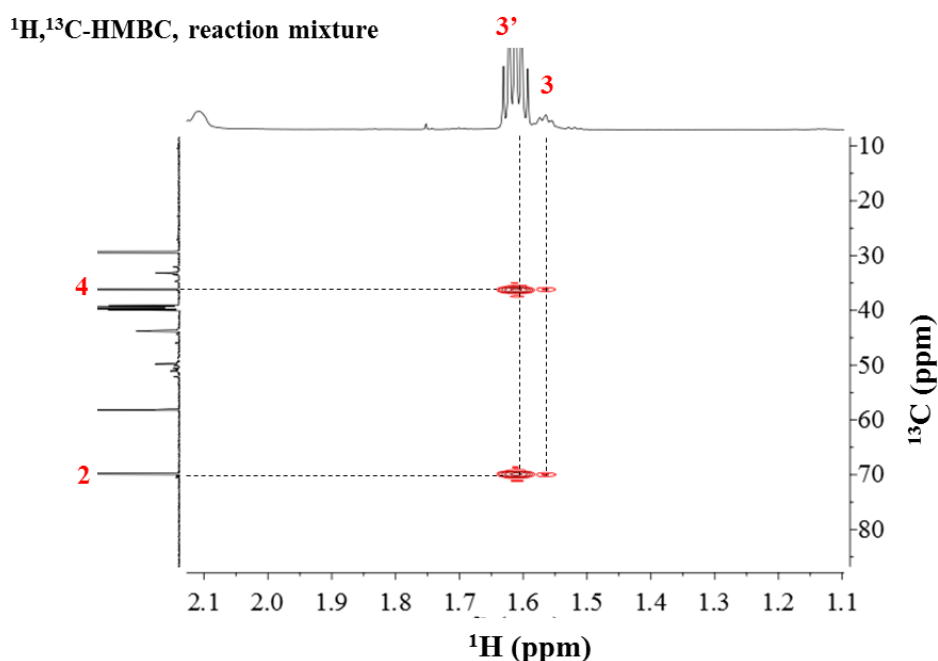

Figure 5.5 Enlargement of the $^1\text{H},^{13}\text{C}$ -HMBC spectrum of the product analysed without purification before the precipitation of the mixture of the polyaddition 2.5MBA+1.3MPAM+1EDA (HPAMAM 1.A5).

5.4.1.2 Synthesis of HPAMAMs 1.A – the effect of the mole fraction of the A-monomer on the molecular weight of the polymer

The polymerisation reaction using a molar ratio MBA:EDA of 2.5:1, was carried out in the presence of varying mole ratios (0.8 to 2.5) of MPAM as a mono-functional end-capping monomer (Scheme 5.2). The polymerisation was run for 3 days in solution (18% w/v in methanol/water, 70/30 % v/v) at 40°C. It is worth recalling that the polyaddition of MBA-EDA (in the absence of MPAM) results in gelation (sample HPAMAM 1.4, Chapter 4) when the mole ratio $A_2:B_4$ is 2.5:1. A series of reactions was carried out in the presence of MPAM at mole ratios of 0.8, 1.0, 1.1, 1.2, 1.3, 1.8 and 2.5 to investigate the impact of the introduction of MPAM at various levels. The resulting polymers were identified as HPAMAM 1.A1, HPAMAM 1.A2, HPAMAM 1.A3, HPAMAM 1.A4, HPAMAM 1.A5, HPAMAM 1.A6 and HPAMAM 1.A7. These reactions proceeded: (i) with formation of a gel product (HPAMAM 1.A1) when 0.8 mole of MPAM were used; (ii) with the formation of a small amount of solid, insoluble particles at the end of the polymerisation by working with 1.0 and 1.1 mole of MPAM and (iii) in the absence of gelation when the mole ratio of MPAM > 1.0 . Figure 5.6 (a) shows the SEC chromatograms (RI detector) of the products obtained with varying amounts of MPAM (DP chromatograms in Appendix C, Figure C.1). The errors in SEC measurements using a conventional calibration are subject to errors in reproducibility and are estimated to be c.a. 1%

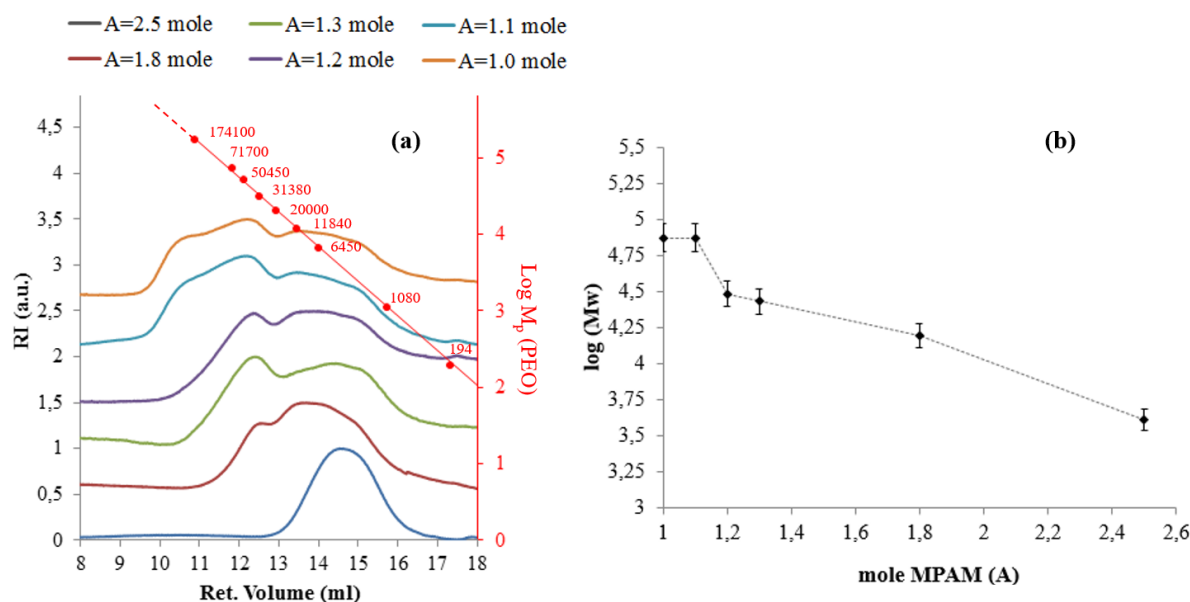

Figure 5.6 (a) SEC chromatograms (RI detector, left side) and (b) log (M_w) as function of the mole equivalents of MPAM for the unfractionated products of the reactions 2.5MBA-1EDA-xMPAM (with $2.5 \leq x \leq 1.0$) recovered after 3 days by precipitation.

The RI data, which is more informative, clearly shows that as the mole fraction of MPAM increases, the molecular weight and dispersity decrease (see also Table 5.2). An increase of the

mole fraction of MPAM leads to an increase of the number of end-capped units on the growing polymer, which in turn limits the growth of the polymer and results in a lower molar mass. This is expected and is evident from the M_w values in Table 5.2 that decrease from $74,400 \text{ gmol}^{-1}$ to $4,100 \text{ gmol}^{-1}$ as the amount of MPAM increases from 1.0 to 2.5 mole equivalents. This trend can be better visualised in Figure 5.6 (b) where $\log M_w$ is plotted against the mole equivalents of MPAM.

Table 5.2 Characterisation data of the products HPAMAMs 1.A obtained from the polyaddition 2.5MBA+1EDA+xMPAM (with $2.5 \leq x \leq 1.0$).

Sample	MPAM (mol)	$M_n^{(a)}$	$M_w^{(a)}$	$\bar{D}^{(a)}$	yield (%)	% MPAM ^(b)	% MBA ^(b)
HPMAM 1.A7	2.5	2200	4100	1.8	45	17	85%
HPMAM 1.A6	1.8	2250	15600	6.5	50	15	-
HPMAM 1.A5	1.3	3500	27000	7.5	63	12	-
HPMAM 1.A4	1.2	4100	30500	7.5	55	-	-
HPMAM 1.A3 (sol)	1.1	4700	74200	15.5	65	-	-
HPMAM 1.A2 (sol)	1.0	4350	74400	17.0	65	8	90%

^(a) in g/mol, the molecular weight values are calculated on the purified product according to SEC analysis (RI detector, PEO as standard and DMF+0.1% LiBr as eluent).

^(b) the %MPAM and % MBA indicate the percentage of each monomer incorporated into the polymer calculated by ¹H-NMR on the product analysed without purification.

The increase of the molecular weight also makes it easier to recover the polymer by precipitation, resulting in higher yields when less MPAM is used (Table 5.2). The percentage conversion of MBA and MPAM after 3 days of polymerisation is shown in Table 5.2. The data was calculated from ¹H-NMR data obtained on the un-purified product. Although MPAM was selected as a monomer with the same reactive functional group as MBA and therefore with expected similar reactivity, it is clear that MPAM does not participate in the polymerisation to the extent expected and in each case less than 20% of the available MPAM was incorporated. This suggests that (i) the acrylate (A) groups of the MBA are more reactive than the analogous acrylate groups of the MPAM monomer and (ii) even a low degree of MPAM incorporation significantly affects the molar mass of the polymer and is sufficient to inhibit gelation.

Moreover, the polymerisation which was carried out with a molar ratio MBA:EDA of 2.5:1 in the presence of 1.0 mole equivalents of MPAM results in 90% of MBA conversion (Table 5.2) and the conversion of MBA undergoes a slight decrease to 85% when increasing the amount of MPAM from 1.0 to 2.5 mole equivalent. The clear identification of the MBA units within the polymer structure (Figure 4.5, Chapter 4) also illustrates a decrease in the percentage of MBA monomer fully incorporated in the polymer (MBA with both acrylamide functional groups reacted) from 60% for the sample HPAMAM 1.A2 to 45% for HPAMAM 1.A7.

Although a high molecular weight polymer with high dispersity can be synthesised by the reaction carried out in presence of 1.0 or 1.1 mole equivalents of MPAM, both reactions resulted

in the formation of a small amount of gel fraction at the end of the polymerisation. This suggests that the amount of MPAM used in these cases is not sufficient to completely inhibit gelation. The polymerisation reactions with 1.0 or 1.1 mole equivalents of MPAM were repeated to investigate how susceptible these reactions were towards gelation. The reaction with 1.1 mole equivalent of MPAM gave similar results; namely the formation of a soluble polymer with a similar MW to that shown in Table 5.2 and a small quantity of insoluble cross-linked particles at the end of the polymerisation. The repetition of the reaction using 1.0 mole equivalent of MPAM led to complete gelation in less than 24 hours.

Some structural information regarding the end-capped HPAMAM 1.A-type of polymer, can be deduced from the Mark-Houwink plots in Figure C.2 (Appendix C). From the overlapping plots obtained for samples HPAMAM 1.A2, HPAMAM 1.A4 and HPAMAM 1.A7 it can be observed that the intrinsic viscosity increases when the mole fraction of A monomer increases. As already observed for the PEA4 polymer (Figure A.8), the addition of a mono-functional monomer leads to a structure which is more open (less branched) than an analogous polymer without a mono-functional co-monomer. In this case the effect of the variation of the amount of added A-monomer on the polymer structure, can be observed and in particular the compactness (branching) of the polymer increases in this order HPAMAM 1.A2 (A=1.0 mole) > HPAMAM 1.A4 (A=1.2 mole) > HPAMAM 1.A7 (A=2.5 mole).

From the results and observations related to this section of work, it can be concluded that: (i) the amount of MPAM can regulate the molecular weight of the polymer, (ii) the use of a monofunctional co-monomer such as MPAM can inhibit chain coupling and hence gelation, but only when more than 1.0 mole equivalent is used and (iii) the polymerisation 2.5MBA-1EDA needs at least 1.2 mole equivalents of MPAM in order to produce exclusively a soluble product. These final results are in good agreement with the theoretical values calculated using Carother's theory that predicts a conversion of B groups equal or higher than 100% when $MPAM \geq 1.0$ mole. It is worth recalling that a conversion of functional groups >100% corresponds to a case in which the system never gels. When all B groups are reacted (100%), a conversion of A groups equal to 80% can be extrapolated from the initial stoichiometric ratio.

5.4.1.3 Stability of the end-capped polymers HPAMAMs 1.A in water

It has been previously shown that the hyperbranched poly(amido amine) HPAMAM 1.7 prepared from MBA:EDA 3:1 has the tendency to undergo further reaction upon storage and to undergo chain coupling/degradation when dissolved in water. The incorporation of MPAM has

been shown to inhibit gelation during the polymerisation when more than 1.0 mole equivalent is used in the reaction 2.5MBA-1EDA, which would otherwise be susceptible to gelation. Moreover, the addition of MPAM offers some control over the molecular weight of the resulting polymer. The next step in this investigation is to establish the impact of incorporating MPAM into hyperbranched poly(amido amine)s upon their long-term storage stability in aqueous solution – this will be discussed below.

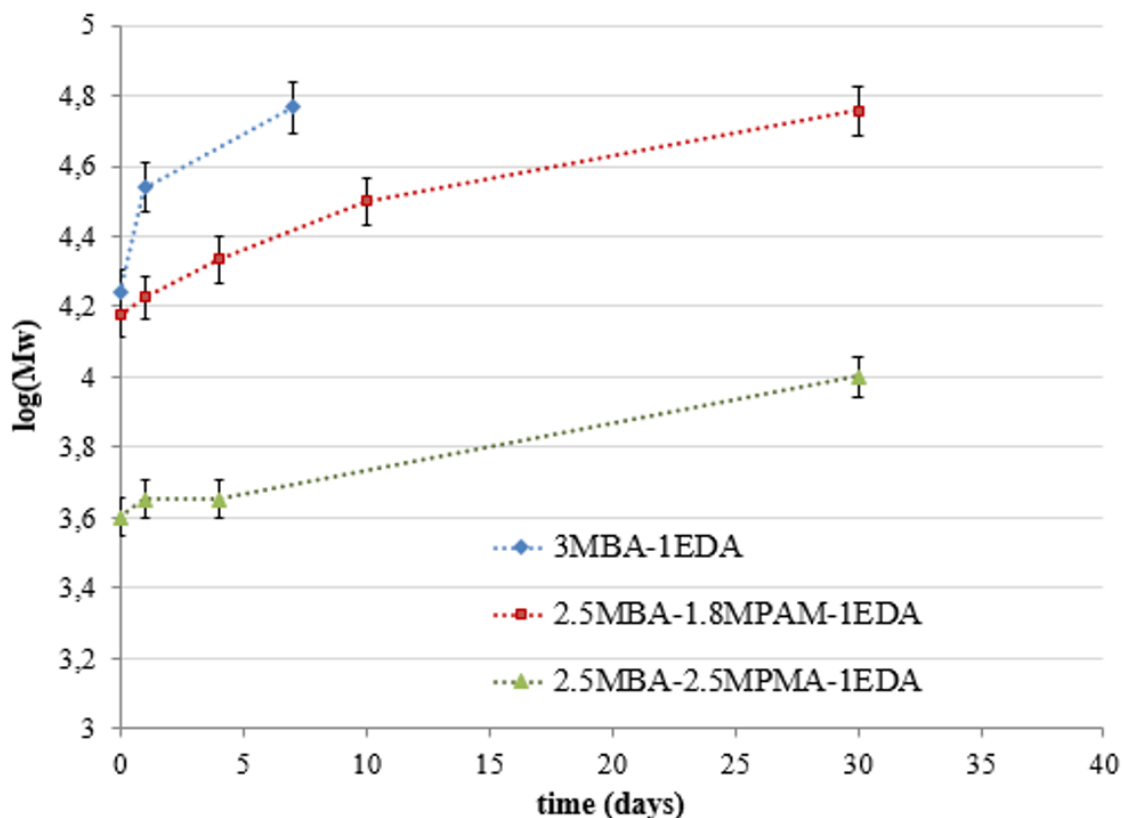

Figure 5.7 Variation of the molecular weight values (SEC-RI analysis, PEO stds) with respect to time for the end-capped polymers HPAMAM 1.A6 (in red) and HPAMAM 1.A7 (in green) and the not end-capped polymer HPAMAM 1.7 (in blue).

Polymers (HPAMAMs 1.A) which were prepared by the reaction of MBA-EDA-MPAM in molar ratio of 2.5:1:1.8 (HPAMAM 1.A6) and 2.5:1:2.5 (HPAMAM 1.A7) were recovered by precipitation, dried in a vacuum oven and then redissolved in water at a concentration of 18 % w/v. It is worth remembering, from the work discussed in Chapter 4, that at such a concentration the polymer underwent chain-coupling and this process dominated over the degradation of the polymer. Therefore, in order to investigate the ability of the mono-functional monomer to act as end-capping agent and prevent chain-coupling of the polymer, the stability of the polymers in solution was studied by periodically analysing aliquots of polymer by SEC. The data shown in Figure 5.7 and Table 5.3 show the impact of storage time in aqueous solution, on molecular

weight ($\log M_w$) for polymers produced both with and without incorporated MPAM. The errors in SEC measurements, in Figure 5.7, using a conventional calibration are subject to errors in reproducibility and are estimated to be c.a. 1%. The data clearly illustrates that the incorporation of MPAM end-capping results in a significant improvement of the stability for the end-capped polymers. In both examples of end-capped polymer, MPAM significantly retards the rate at which the molecular weight of the polymer increases in water. However, although the increase in molecular weight upon storage is much less than for the analogous polymer with no MPAM end-capping, the behaviour of HPAMAM 1.A6 shows that a similar M_w does result at longer times with respect to HPAMAM 1.7 - the polymer which is not end-capped ($M_w = 58300$ g/mol after 7 days for HPAMAM 1.7 and $M_w = 57000$ g/mol after 30 days for HPAMAM 1.A6).

Table 5.3 Molecular weight values (SEC-RI analysis, PEO stds) obtained at various times for the end-capped polymers HPAMAM 1.A6 and HPAMAM 1.A7 and the not end-capped polymer HPAMAM 1.7 dissolved in water (18 %w/w).

Sample	time (days)	M_n (g/mol)	M_w (g/mol)	\bar{D}
HPAMAM 1.7	0	3250	19500	6.0
	1	4500	35650	7.5
	7	4750	58300	12.0
HPAMAM 1.A6	0	3000	15000	5.0
	1	2500	16800	7.5
	4	3100	21550	7.0
	10	3300	31600	9.5
	30	4000	57000	10.0
HPAMAM 1.A7	0	2050	4150	2.0
	1	2100	4500	2.0
	4	2000	4500	2.5
	30	1980	10000	4.5

Moreover, improved stability is observed for a polymer with more end-capped units. Thus, polymer HPAMAM 1.A7 shows enhanced stability compared to HPAMAM 1.A6. However the incorporation of MPAM end-capping does not completely stabilise the polymer in solution and further chain-coupling does occur. Although no gelation was observed for the duration of the investigation, the formation of a gel product cannot be ruled out for extended storage times (>30 days). The results in this section show that the end-capped polymer is characterised by higher stability in water at 18% w/w and that gelation is significantly retarded in comparison to an analogous polymer with no end-capping where gelation occurred after 7 days.

5.4.2 Functionalisation of hyperbranched poly(amido amine)s via the $A_2 + B_4 + C$ strategy

In the previous section, the $A_2 + B_4$ polymerisation reaction carried out in the presence of a mono-functional, end-capping co-monomer bearing the same 'A' functional group (acrylamide) as the A_2 monomer has been discussed. Herein, this approach is further explored/developed by introducing an end-capping monomer with a different reactive function group a C-monomer. This C-functionalised monomer was used as starting material alongside MBA (A_2) and EDA (B_4). The C-monomer in this case is polyisobutylene succinic anhydride (PIBSA) also known under the tradename of Glissopal[®]SA, produced by BASF. PIBSA comprises of a short, polyisobutylene chain with an alkene group adjacent to the succinic anhydride (C group) reactive functional group (Scheme 5.3). This product is commonly used as additive for lubricants, biofuel, oil-drilling and explosives^{17,18,21}. As well as exploring the concept of using PIBSA as C-monomer, this monomer will also introduce hydrophobic terminal units on the hyperbranched polymer - see Scheme 5.3.

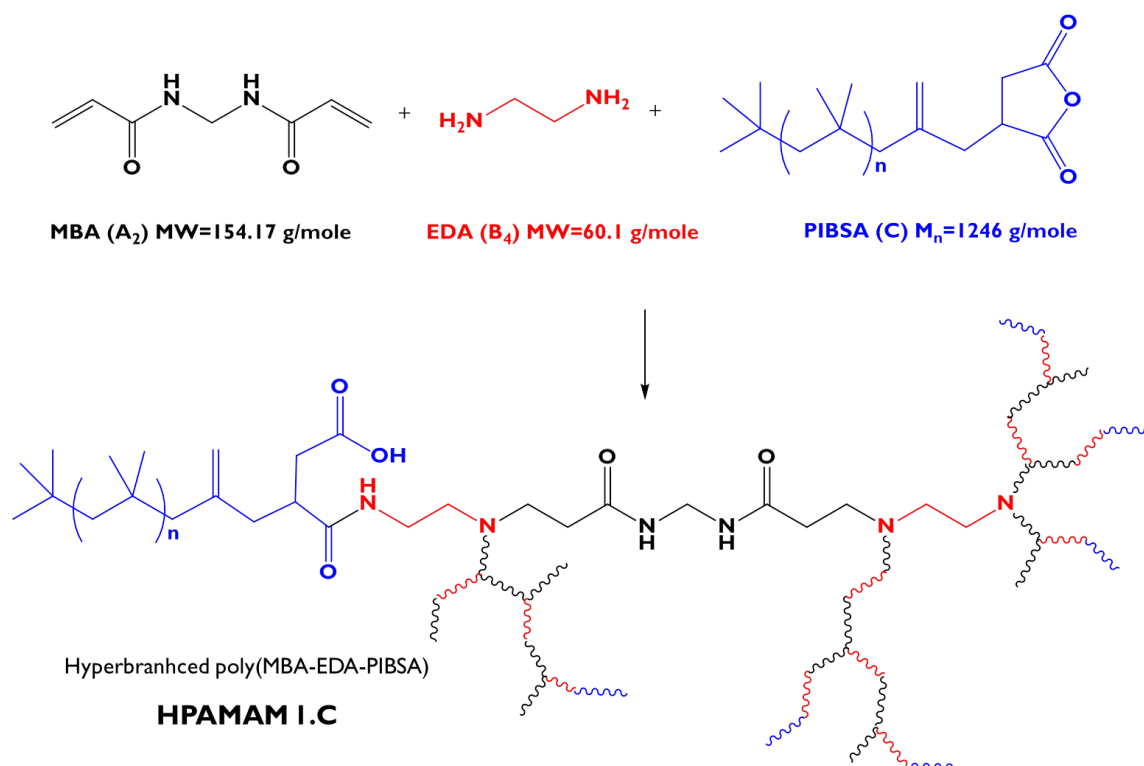

Scheme 5.3 Copolymerisation of $A_2 + B_4 + C$ in a one-pot synthesis of end-capped and functionalised hyperbranched HPAMAM 1.C polymer.

The polymerisation illustrated in Scheme 5.3 could not be carried out in methanol/water, the solvent used previously for the reaction between MBA and EDA, because the hydrophobic PIBSA is insoluble in such a polar mixture. However, the use of a polar component in the

solvent is necessary to ensure the solubilisation of MBA and hence allow the polymerisation reaction to proceed in homogeneous phase. MBA is soluble at any concentration in H₂O, DMF, DMSO and in MeOH at a solution concentration lower than 15 % w/v. Methanol was selected from these solvents for its polarity and relatively low boiling point. On the other hand, PIBSA showed good solubility in tetrahydrofuran (THF), dichloromethane, chloroform, toluene and hexane and the combined starting materials were shown to be soluble in a mixture of MeOH/THF with a volume ratio of 30/70 at a monomer concentration of 10% w/v. In order to optimise the reaction conditions, an initial test reaction was carried out at 50°C with a molar ratio A₂:B₄:C of 2.5:1:1 and the product of this reaction is labelled HPAMAM 1.C1. This molar ratio was initially chosen to reproduce the synthesis of HPAMAM 1.A2 (2.5MBA-1EDA-1MPAM) which ultimately lead to gelation, and therefore easily allows an investigation of the effect of replacing the A-monomer (MPAM) with a C-monomer (PIBSA). Although the use of PIBSA in the polyaddition 2.5MBA-1EDA did not lead to gelation, a heterogeneous polymerisation mixture comprising of a liquid and a solid product, was formed after few hours which was shown to correspond to a low acrylamide conversion (<5%, calculated by ¹³C-NMR, Equation 5.2). However, the recovered solid product was not cross-linked but fully soluble in THF and CHCl₃ and therefore it was possible to study the progress of the reaction by NMR (CDCl₃).

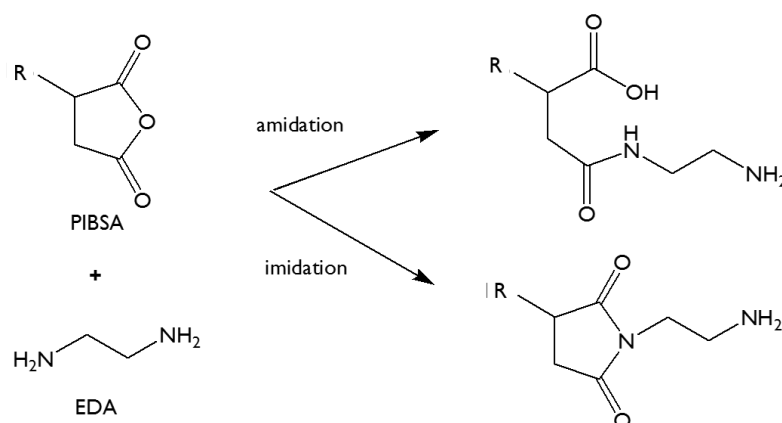

Scheme 5.4 Possible reaction routes for PIBSA-EDA system.

The ¹³C-NMR spectrum did show evidence of reaction between PIBSA and EDA, namely the chemical shifts of the two carbonyl carbons of the anhydride groups of the PIBSA moved from c.a. 169.0 and 173.0 (PIBSA) to c.a. 177.0 and 180.0 ppm. In order to assign these peaks, all possible reactions between PIBSA and EDA were considered. In fact, two reactions can potentially occur; amidation and imidation (see Scheme 5.4). The imidation reaction should

not be prevalent under the conditions used, since it has been reported that high temperatures ($>100^{\circ}\text{C}$) or the addition of acetyl chloride (to form a further anhydride as intermediate) are necessary to drive the reaction towards the imide^{17,19,20,21,22,23}. Therefore, in this first analysis, the carbon peaks at 177.0 and 180.0 ppm have been assigned to the amide and carboxylic acid groups respectively. The mechanism of the proposed reaction between PIBSA and EDA is shown in Scheme 5.5.

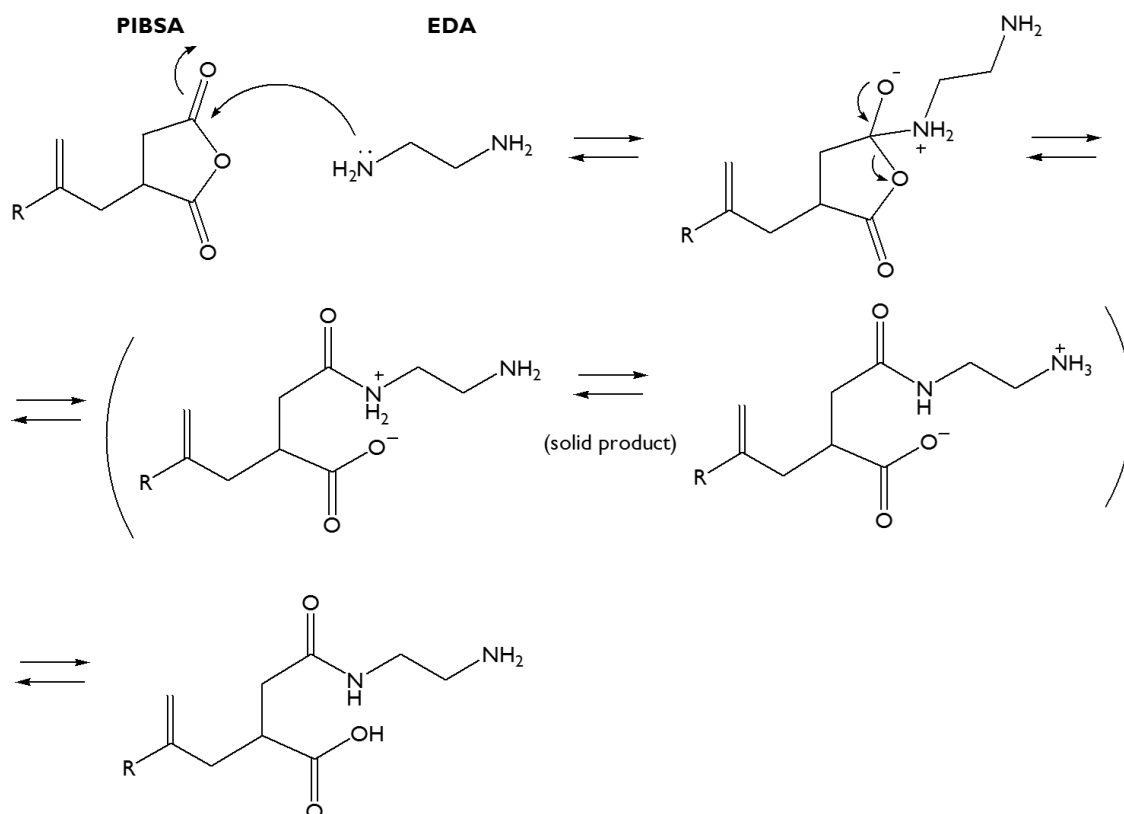

Scheme 5.5 Amidation reaction between PIBSA and EDA.

Although the mechanism has been drawn with the amidation reaction occurring on one of the carbonyl carbons, it is reasonable to assume that the amidation reaction could occur on either carbonyl carbon and a mixture of products I and II shown in Figure 5.8 is expected²¹. From the mechanism in Scheme 5.5 and the low acrylamide conversion observed ($<5\%$) in the polyaddition 2.5MBA-1EDA-1PIBSA, it can be supposed that the Michael polyaddition between EDA and MBA was not able to proceed in parallel with the amidation reaction between the amine and anhydride, possibly because of the protonation of the unreacted primary amine by the carboxylic acid formed from reaction PIBSA-EDA monomer. In this case the protonated primary amine represents a poor aza-Michael donor. Thus, two considerations arise; (i) amine groups react more quickly with the anhydride groups than the acrylate groups and the polymerisation is inhibited and (ii) the reaction A₂-B₄-C needs the addition of a base to permit

the formation of the free amine and therefore the polyaddition. To test the latter hypothesis, 4-dimethylaminopyridine (DMAP) was used as an additive to promote the reaction between MBA and EDA.

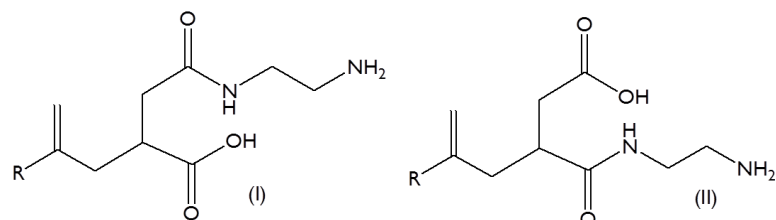
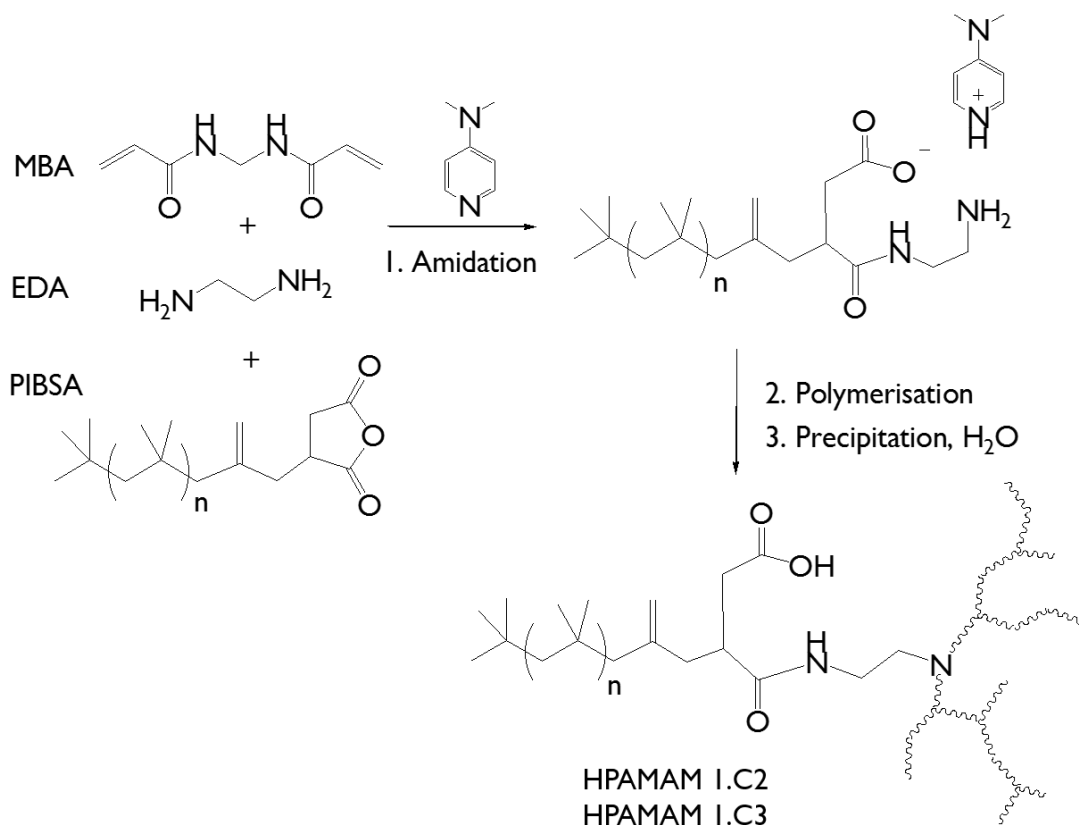

Figure 5.8 Possible products of the amidation reaction PIBSA-EDA.

In Scheme 5.6 a possible mechanism involving all three components in the reaction is depicted. As amidation appears to proceed faster than the Michael addition reaction, only half a mole equivalent of EDA is available for the polymerisation since the other half is consumed by the amide formation and thus is no longer available for the polymerisation.



Scheme 5.6 Possible reaction scheme of the polyaddition MBA-EDA in presence of PIBSA as end-capping monomer and DMAP as proton sponge.

Thus, the reaction MBA-EDA-PIBSA was repeated under the same conditions (50°C for 3 days) but with a different molar ratio of starting materials – namely $A_2:B_4:C$ was (a) 2.5:1.5:1 (A:B:C of 5:6:1 – HPAMAM 1.C2 product) and (b) 2.5:1.5:0.5 (A:B:C of 5:6:0.5 – HPAMAM 1.C3 product).

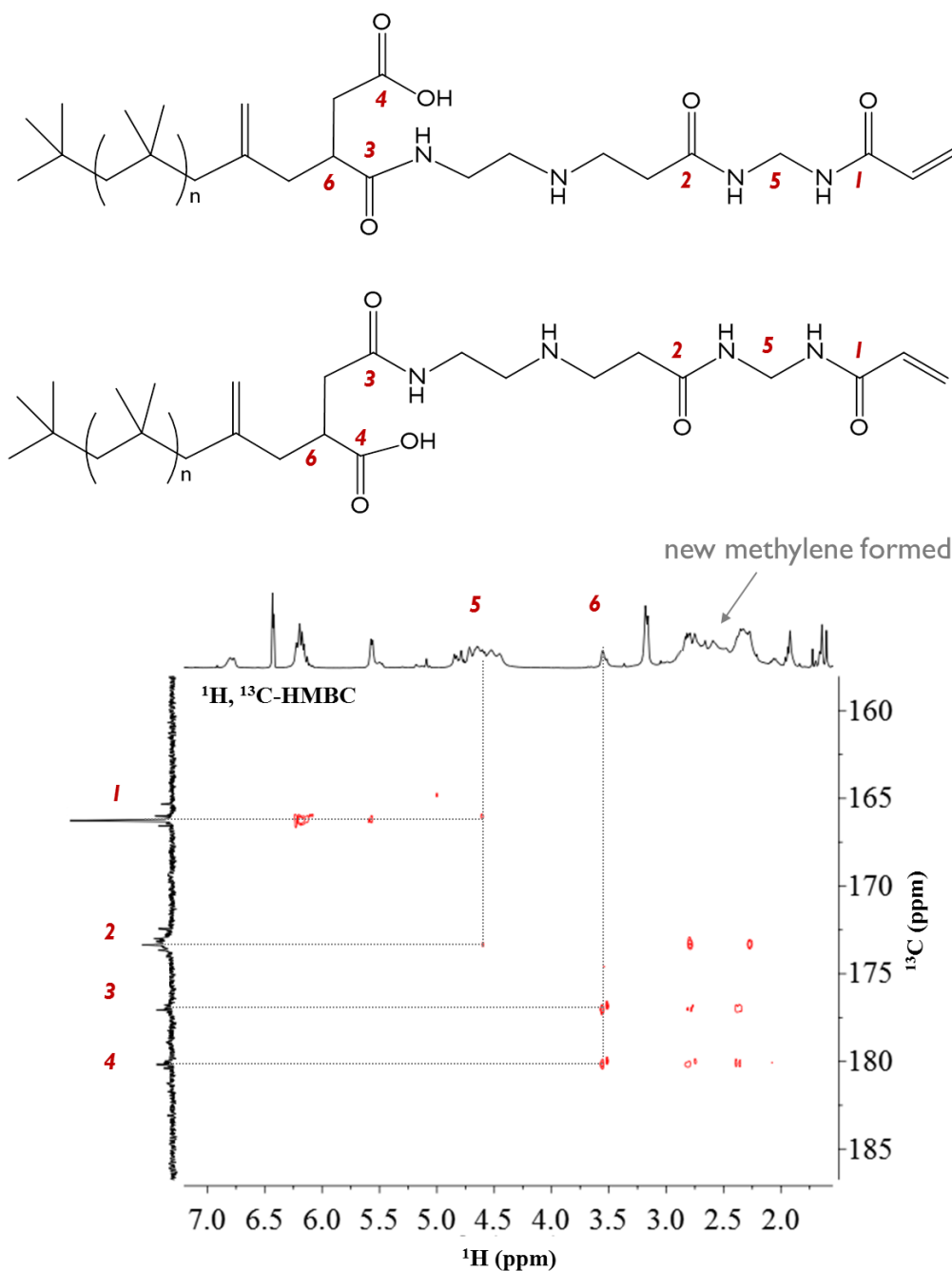

Figure 5.9 $^1\text{H}, ^{13}\text{C}$ -HMBC (CDCl_3) spectrum of the product HPAMAM 1.C2 analysed without purification of the reaction MBA:EDA:PIBSA with molar ratio 2.5:1.5:1.

Thus the mole of EDA was increased from 1 mole to 1.5 moles to permit the formation of a C-functionalised branched polymer. DMAP was used in a stoichiometric amount with respect to PIBSA in both cases. The reaction products HPAMAM 1.C2 and HPAMAM 1.C3 were analysed by SEC and 1D and 2D-NMR spectroscopy. The $^1\text{H}, ^{13}\text{C}$ -HMBC spectrum of the product HPAMAM 1.C2 analysed without purification after 3 days of reaction is depicted in Figure 5.9. A similar spectrum was obtained for HPAMAM 1.C3. The spectrum shows coupling of proton peak 6 with carbon peaks 3 (~177.0 ppm) and 4 (~180.0 ppm) which supports the

successful reaction between PIBSA and EDA. From the ^{13}C -NMR spectra, the conversion of the acrylamide groups of MBA can be estimated by using the Equation 5.2, which takes into account the movement of the carbonyl carbon of the acrylamide group of the MBA-monomer from 165.0 (signal 1, Figure 5.9) to 175.0 ppm (signal 2, Figure 5.9) following polyaddition.

$$\% \text{ A conversion} = \frac{I_{175.0}}{I_{175.0} + I_{165.0}} \quad \text{Equation 5.2}$$

The assignment of the peaks of the product was achieved by the combined interpretation of the spectra of polymer 3MBA-1EDA, the starting monomers and the product of a model reaction between PIBSA and EDA (in the absence of MBA) which was carried out to identify the signals of the product arising from the amidation. The ^{13}C -NMR spectrum of the product of the reaction HPAMAM 1.C2 indicates 65% conversion of acrylamide groups. Similar conversion was unexpectedly obtained also for HPAMAM 1.C3 in which a higher conversion was expected due the lower amount of C monomer used. In Figure 5.9 the ^1H , ^{13}C -HMBC spectrum of the product HPAMAM 1.C2 analysed without purification is shown. The coupling of the methylene proton 5 with both the carbonyl carbon 1 and 2 suggests that MBA monomer takes part in the reaction. Moreover, the broadness of the proton peak 5 suggests the existence of the different structural units of the MBA within the polymer formed from the reaction MBA-EDA (see structure in section 4.4.1.1, Chapter 4). After 3 days of reaction, each product (HPAMAM 1.C2 and HPAMAM 1.C3) was recovered by precipitation in acetone, washed in water and dried in vacuo. The resulting polymers were soluble in THF, CHCl_3 and toluene. The complexity of the 1D and 2D NMR spectra makes identification of the structural units of the polymers extremely difficult and consequently it is not possible in this case to establish the DB of the products. The purified polymers were analysed by SEC, using THF + 1% v/v TEA as the mobile phase. Although DMF was generally used as the eluent in this work, the current polymers were insoluble in DMF. It is worth recalling that the addition of TEA to the THF eluent is necessary in order to avoid the interaction of any polar groups with the column packing as was already observed for the HPAMAM 3-type polymers, that is the hyperbranched polymer synthesised from MBA and PriamineTM. The SEC chromatograms of the products HPAMAM 1.C2 and HPAMAM 1.C3 are shown in Figure 5.10 along with the chromatogram of the PIBSA comonomer. The molecular weight values obtained using a conventional calibration method (PS standards) are reported in Table 5.4.

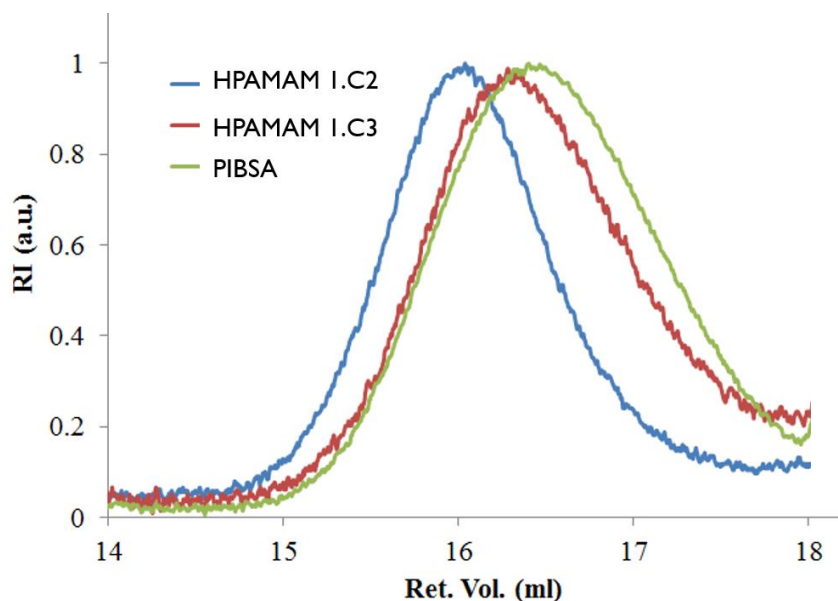

Figure 5.10 SEC chromatogram (RI detector, THF+1% v/v TEA as mobile phase) of the products HPAMAM 1.C2 and HPAMAM 1.C3 purified by precipitation overlapped with the chromatogram of the PIBSA co-monomer.

The values obtained for the two products do not show significant evidence of the success of the reaction. In fact, one would expect the MW to be considerably higher and therefore the polymer to be eluted at a lower RV. This result was not obtained even when the amount of the C-monomer was decreased from 1 to 0.5 mole equivalent. However, the value of acrylamide conversion was estimated by ^{13}C -NMR to be 65%, suggesting that the polyaddition had occurred to a reasonable extent. Similar values of acrylamide conversion were reported in Chapter 4 for the polymerisation between MBA and EDA with a molar ratio of 3:1. In this previous case, a polymer with acrylamide conversion of c.a. 65% had molecular weight values of M_n 3250 g/mol, M_w 19500 g/mol, \bar{D} 6.0 obtained using SEC analysis with DMF + 0.1% LiBr as eluent and PEO as standards.

Table 5.4 Molecular weight values obtained by SEC analysis (RI detector, THF+1 %v/v TEA) using PS as standards for the end-capped polymers HPAMAM 1.C2 and HPAMAM 1.C3 and the C-monomer (with C=PIBSA monomer).

Sample	ratio A:B:C	M_n (g/mol)	M_w (g/mol)	\bar{D}
HPAMAM 1.C2	5:6:1	2000	2950	1.5
HPAMAM 1.C2	5:6:0.5	1400	2140	1.5
C-monomer	0:0:1	1300	1950	1.5

This observation taken together with the NMR coupling in Figure 5.9 of the new methylene proton peaks (δ_H 2.90- 2.10 ppm) with the carbonyl carbons 2, 3 and 4, suggest that both the amidation and polyaddition reactions in solution have occurred and a polymer with a reasonable molecular weight has been formed. There appears to be some disagreement between the NMR data and the SEC. It is possible that the explanation for this disagreement is that the polymer HPAMAM 1.C2 is still able to interact with, and be retained by, the column during the

SEC analysis. If this were the case, the MW values obtained by THF SEC and reported in Table 5.4 would only represent a fraction of the polymer produced. Although future work is necessary to confirm the results obtained and establish the structure of the resulting polymers prepared with PIBSA as a C monomer, satisfactory results were obtained from the present study and the key objective of the work achieved. Thus, the reaction between MBA and EDA does not result in gelation in the presence of PIBSA and the polymer after precipitation is without doubt functionalised with the PIB functional groups, as evidenced by NMR data shown in Figure 5.11.

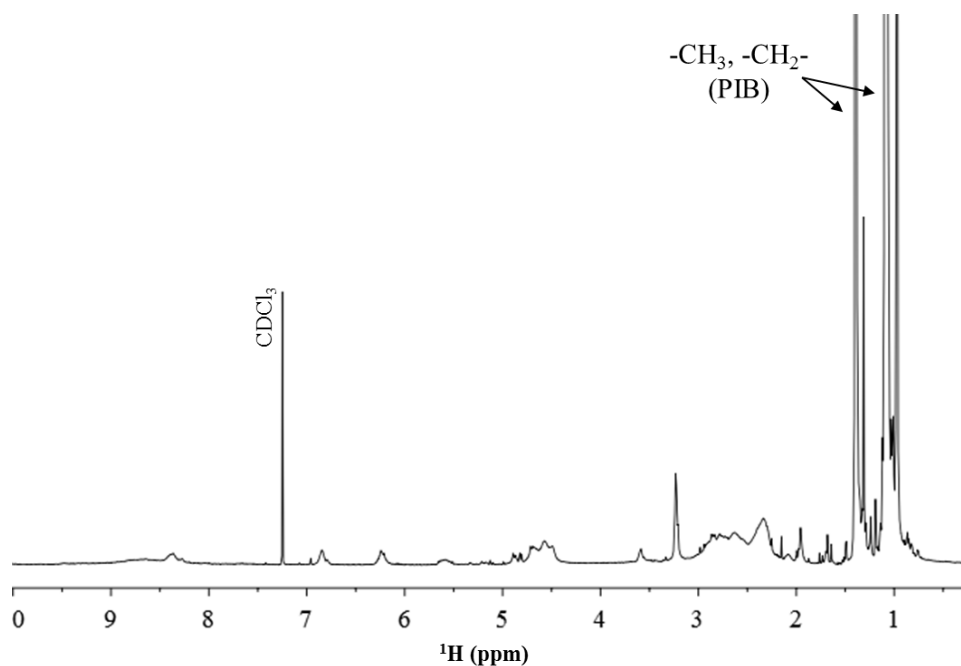

Figure 5.11 $^1\text{H-NMR}$ (CDCl_3) spectrum of the product HPAMAM 1.C2 purified by precipitation.

5.4.3 Synthesis of cationic hyperbranched poly(amido amine).

With a view to broadening the scope of potential applications, the synthesis of cationic hyperbranched poly(amido amine) is herein discussed. Generally speaking, cationic polymers are industrially relevant in applications including in the oil industry as flocculants^{24,25} and demulsifiers²⁶, in personal care for hair conditioning products^{27,28}, as ionic emulsifiers for metal-working fluids²⁹ and as non-viral vectors in biomedical applications^{30,31,32}. In the current study the synthesis of cationically charged hyperbranched polymers was carried out using two different strategies; direct polymerisation of cationic monomers (section 5.4.3.1) and post-polymerisation modification (section 5.4.3.2).

5.4.3.1 Direct polymerisation – an A₂ + B₄·2HCl strategy

Michael addition polymerisation was carried out using MBA as the A₂ monomer and hexamethylenediamine dihydrochloride (HDDC) as the B₄ (cationic) monomer with a molar ratio A₂:B₄ of 3:1 (see Figure 5.12).

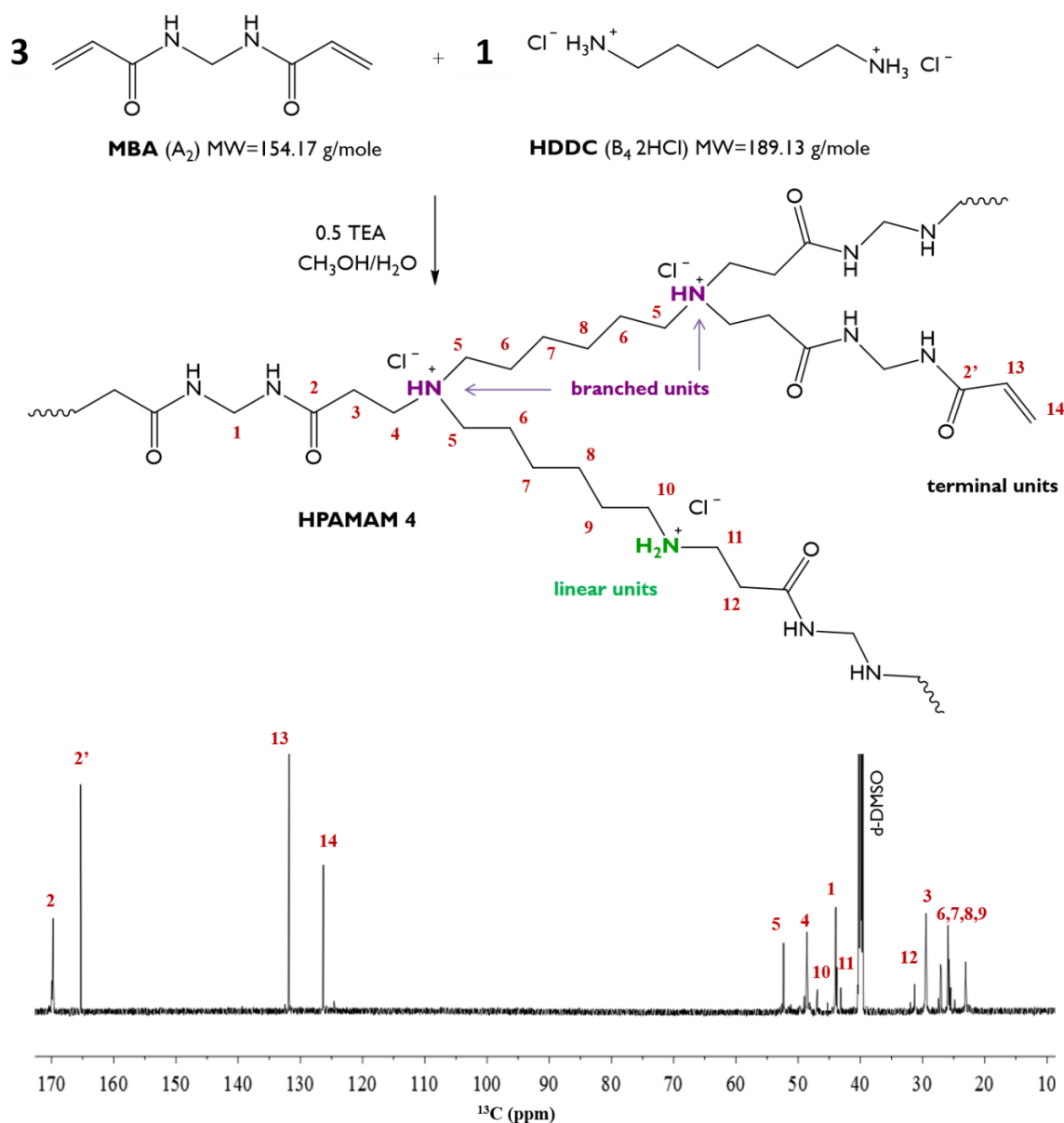

Figure 5.12 Reaction scheme for the synthesis of cationic hyperbranched polymer HPAMAM 4, with TEA as activator. ¹³C-NMR (700MHz, d-DMSO) of the final product recovered by precipitation in acetone with the assignment of the structure.

The reaction was carried out in methanol/water (70/30 % v/v) with a total monomer concentration of 18% w/v and a temperature of 40°C. The reaction was carried out in the presence of triethylamine (TEA) (0.5 mole) which acts as an activator towards the protonated primary diamine of HDDC as previously discussed in Chapter 3 (section 3.4.3). The

hydrochloride salt of an amine is not a good Michael donor and TEA deprotonates the primary amine of the HDDC in equilibrium between the different amine groups present. The product of this reaction is identified as HPAMAM 4. The reaction was carried out for 3 days and the reaction mixture analysed by ^1H and ^{13}C -NMR. After such time, a product with 60% of MBA incorporated into the polymer HPAMAM 4 (calculated by ^1H -NMR according to the Equation 4.1) and a degree of branching (DB) of 0.87 was obtained. The DB was calculated according to Frey's equation (Equation 4.3) by using the carbon signals 12 and 3 at 31.5 and 29.5 ppm of the linear and branched units respectively (Figure 5.12). The polymer was subsequently precipitated in acetone containing 1% v/v of concentrated HCl (37%), washed with acetone and recovered in 75% yield. HCl was added during the precipitation to (re)protonate any amine groups which had been deprotonated by TEA. In Chapter 3 (section 3.4.4) it was shown that the stability in methanol of a linear poly(ester amine) obtained from PEGDA and HDDC in the presence of TEA was compromised because a portion of the amine groups within the structure remained unprotonated after the precipitation of the polymer in THF without the addition of HCl.

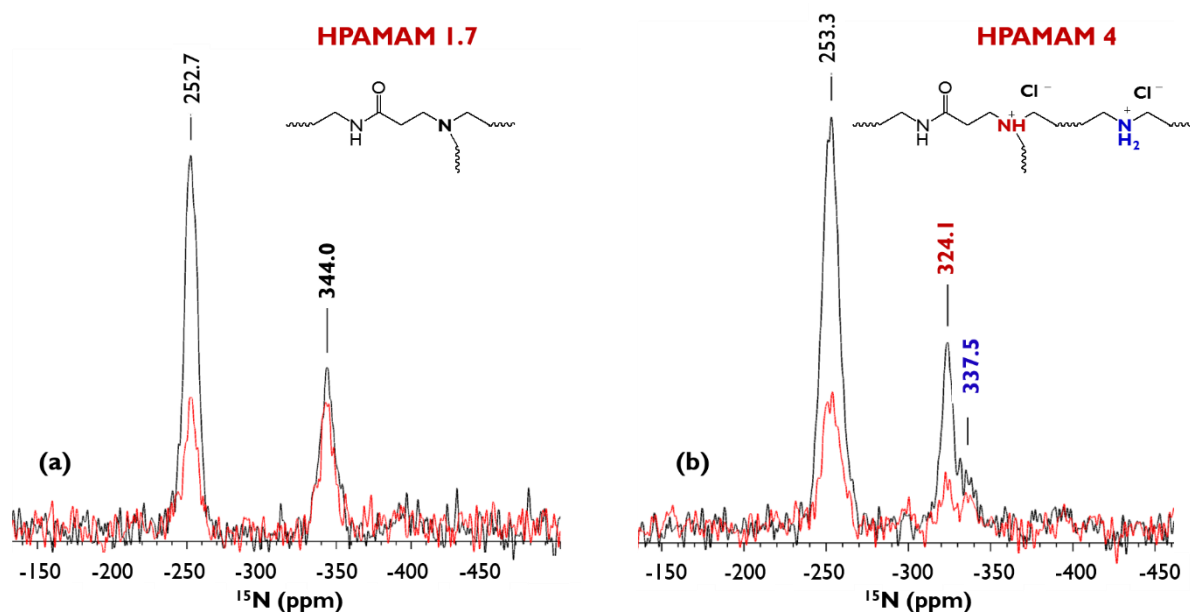

Figure 5.13 Solid-state ^{15}N -NMR spectra ($\text{CH}_3^{15}\text{NO}_2$) obtained by standard pulse sequence (black line) and interrupted-decoupling pulse (red line) of the (a) HPAMAM 1.7 (neutral hyperbranched poly(3MBA-1EDA)) and (b) the HPAMAM 4 (hyperbranched hydrochloride (3MBA-1HDDC)).

The cationic hyperbranched poly(amido amine) HPAMAM 4 synthesised from MBA and HDDC was dried in vacuo and analysed by NMR spectroscopy. The ^{13}C -NMR spectrum of the resulting polymer is shown in Figure 5.12 and the assignment of peaks was carried out according to the couplings observed in the ^1H , ^{13}C -HSQC and ^1H , ^{13}C -HMBC. The resulting polymer was soluble in water, DMF and DMSO and a pH of 7.5 was recorded for a 5% w/v solution in water.

The retention of the cationic quaternary ammonium chloride group within the polymer structure was confirmed by solid state ^{15}N -NMR spectroscopy. In Figure 5.13 the spectra of the cationic product HPAMAM 4 is shown and compared with the ^{15}N -NMR spectra obtained for the (neutral) hyperbranched polymer HPAMAM 1.7 produced from MBA and EDA (poly(3MBA-1EDA)). Two different ^{15}N -NMR experiments were carried out: (a) standard CP spectra are shown with black traces in Figure 5.13 and (b) spectra obtained with interrupted-decoupling (ID) are shown with red traces in the same figure. In this latter case, the decoupling is turned off during the experiment so that the signal from nitrogen atoms coupled to hydrogen will be reduced in intensity more than the signal originating from nitrogen atoms with weak coupling to hydrogen. By choosing a suitable time (200 μs in this case) for which the decoupling is off, it is possible to eliminate the signal originating from nitrogen atoms bonded directly to hydrogen, so that the resulting spectrum only contains signals from nitrogen atoms with no bonded hydrogens e.g. tertiary amines. Therefore, the combination of NMR experiments (a) and (b) as described, enables the assignment of N-H groups by observing a decrease of the intensity of the ^{15}N -signal in experiment (b). On the other hand the intensity of the ^{15}N -signal should not decrease when there is no hydrogen bonded directly to nitrogen³³.

The hyperbranched poly(amido amine)s synthesised from MBA and EDA (poly(3MBA-1EDA) has a high degree of branching ($\text{DB} > 0.90$) and therefore contains predominantly amide and tertiary amine groups with only a very few secondary amines belonging to linear units (see Figure 5.13). Hence, for this sample two ^{15}N -signals were observed at -252.7 and -344.0 ppm, which can be assigned respectively to the amide and tertiary amine nitrogens³⁴ (Figure 5.13 (a)). As expected, in this case a decrease in intensity is only observed for the amide peak at -252.7 ppm which contains an N-H bond, whereas the tertiary amine group at -344.0 ppm remains unchanged in the decoupled spectrum. However, in the case of the cationic hyperbranched polymer synthesised from MBA and HDDC (Figure 5.13 (b)), which has a slightly lower degree of branching (DB of c.a. 0.90), distinct signals can be observed for amide (-253.3 ppm) and tertiary amine (-324.1 ppm) groups and to a lesser extent the secondary amines of linear units as a shoulder at -337.5 ppm. The assignments were based on a comparison with the spectra in Figure 5.13 (a) and previous results in the literature^{34,35}. The key observations related to the data in Figure 5.13 (b) are; (i) the signal of the tertiary nitrogen shifts from -344.0 ppm to -324.1 ppm after quaternisation indicating two non-equivalent nitrogen atoms and (ii) the intensity of the signal at -324.1 ppm corresponding to the tertiary amine is significantly diminished in the interrupted decoupled spectrum, indicating in this case that this nitrogen atom is bonded to

hydrogen, therefore proving the quaternisation and the retention of the hydrogen chloride within the structure.

5.4.3.2 Post-polymerisation - amine alkylation reaction.

Cationic hyperbranched poly(amido amine)s were also synthesised in a two-step process. Step (I) involved the polyaddition of MBA-EDA according to the method previously described in section 4.4.1 and step (II) involved the N-alkylation of the amine groups of the resulting polymer (Scheme 5.7). The initial hyperbranched poly(3MBA-1EDA) was characterised directly without any purification by SEC (RI detector, DMF + 0.1% LiBr) and ^1H and ^{13}C -NMR to reveal a polymer with M_n 630 g/mol, M_w 19700 g/mol, Đ 20.0 and a highly branched architecture with a DB of 0.95. Therefore, the polymer showed a prevalence of tertiary amine groups (branched units) rather than secondary amine (linear units). The polymer was recovered by removing the solvent under reduced pressure and then dissolved in DMF at 50°C. An excess of methyl iodide was subsequently added to the mixture for the methylation reaction which was allowed to proceed for 24 hours before the reaction was quenched by precipitation in acetone. The product of such a reaction was identified as HPAMAM 5.

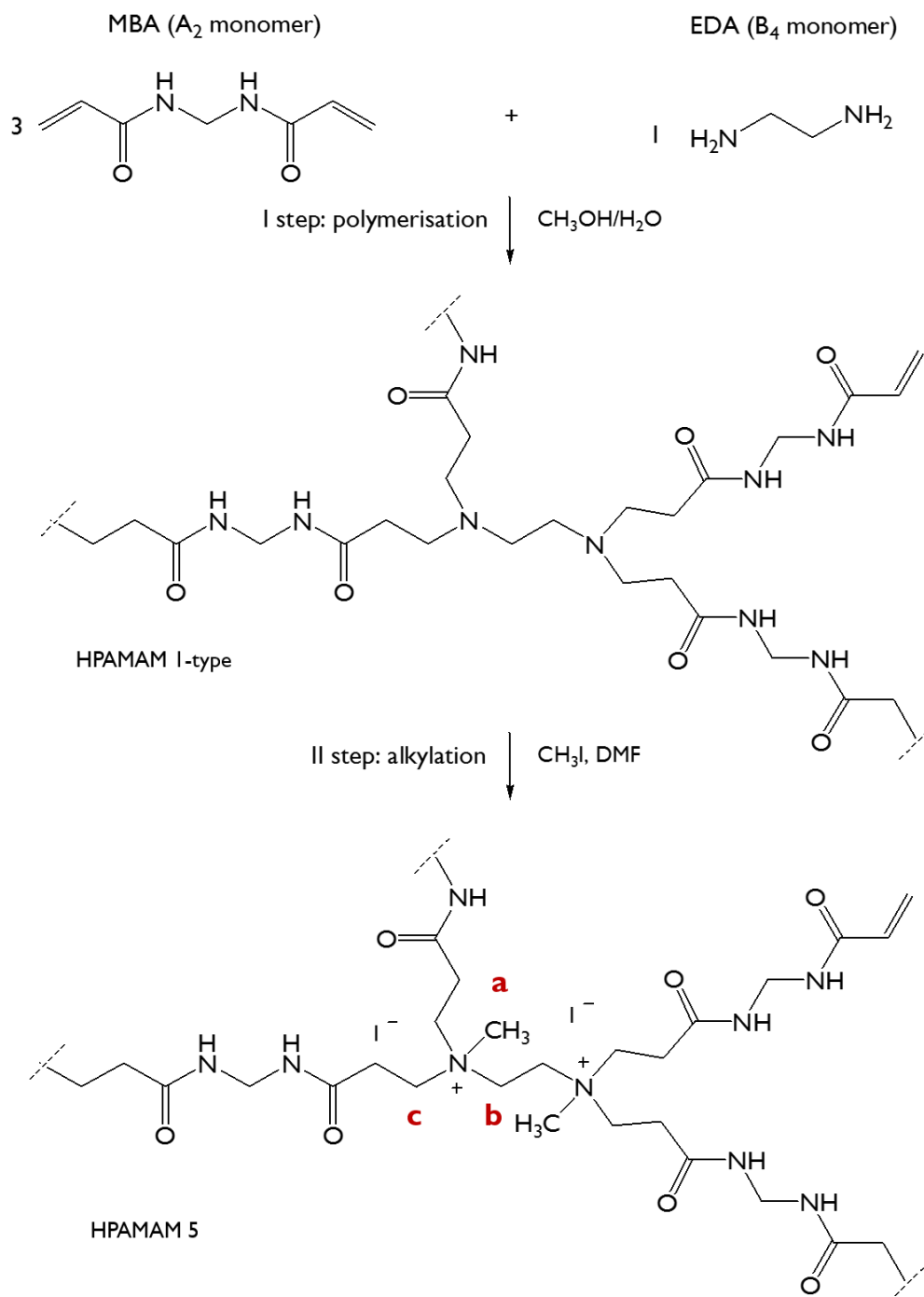

Scheme 5.7 Reaction scheme for the two-step synthesis of the HPAMAM 5: 1st step polymerisation reaction 3MBA-1EDA (HPAMAM 1-type polymer); 2nd step alkylation of the amine groups with CH_3I .

The branched and methylated units of the resulting polymer were identified by the presence of signals a, b and c (Scheme 5.7) in the $^1H, ^{13}C$ -HSQC NMR spectrum (Figure 5.14). Moreover, the presence of the methylated quaternary amine groups was confirmed by ^{15}N -solid state NMR. In contrast to the quaternized hyperbranched polymer discussed above in section 5.4.3.1, the intensity of the ^{15}N NMR signal of such a group obtained by interrupted decoupling (ID) NMR experiment should remain unchanged with respect to that carried out under the standard NMR

experimental set up ,since the alkylated amine group does not have a proton attached directly to the nitrogen atom.

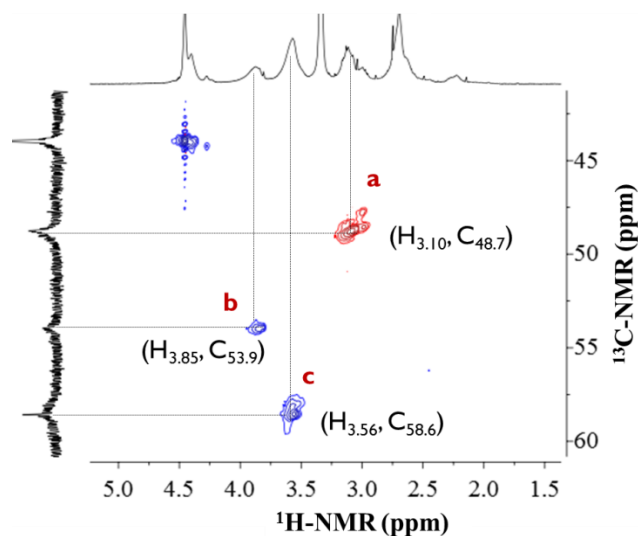

Figure 5.14 Enlargement of the $^1\text{H},^{13}\text{C}$ -HSQC NMR spectrum (d-DMSO) of the product of the reaction HPAMAM 5 recovered by precipitation.

In Figure 5.15 (b) the ^{15}N -NMR spectra of the HPAMAM 5 polymer and that of the precursor (Figure 5.15 (a)) are shown. HPAMAM 5 polymer shows two peaks at -251.5 and -318.2 ppm corresponding to the nitrogen of the amide and alkylated amine respectively. A comparison with the spectra of the HPAMAM 1.7 polymer helps the assignment. The ^{15}N -signal was acquired by using both standard and ID experimental conditions. In Figure 5.15 (b) a reduction of the intensity is observed for the peak at -251.5 ppm since an N-H group is present; the same behaviour is not observed for the peak at -318.2. In this case, in fact, the intensity of the signal does not change significantly and from the comparison with Figure 5.15 (a) the alkylation of the amine group moves the peak to higher chemical shift and sharpens the peak³⁶. These data prove the success of the quarterisation of the polymer by post-polymerisation.

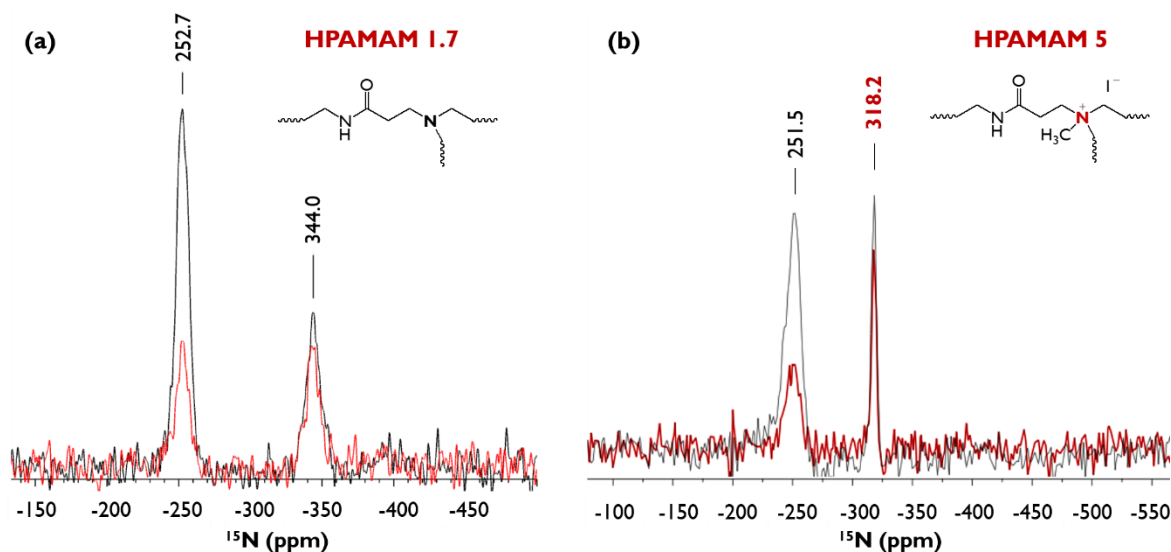

Figure 5.15 Solid-state ^{15}N -NMR spectra obtained by standard pulse sequence (black line) and interrupted-decoupling pulse (red line) of the (a) HPAMAM 1.7 (hyperbranched poly(3MBA-1EDA)) and (b) HPAMAM 5 (HPAMAM 1 with alkylated amine).

5.5 Conclusions

Strategies for the modification of hyperbranched polymers produced by an $A_2 + B_4$ strategy have been discussed in this work. The modifications have been carried out by (i) introducing specific functional groups and (ii) conferring a cationic character to the polymer.

The $A_2 + B_4 + X$ system has been used for the introduction of specific functionalities within the structure. A_2 (MBA) is the monomer that links the branching units generated from the B_4 (EDA) monomer and X is an end-capping, mono-functional monomer chosen with a specific functionality and is incorporated during the polymerisation reaction. The X -monomer can be selected either with the same reactive functional group (A or B) as the building blocks, thereby reacting via the same mechanism or with different reactive functional group (C), introducing an additional reaction pathway to the synthesis. Two different X -monomers have been used in this work, MPAM and PIBSA; the former is a monomer which possesses the same reactive (A) functionality and decorates the polymer with methoxypropyl groups while PIBSA is a C-monomer with an anhydride functionality that was used with the aim of introducing a short hydrophobic polyisobutylene moiety. The results of the reaction with MPAM (polyaddition MBA-EDA-MPMA, polymers HPAMAM 1.A) showed that the polymer can be successfully functionalised as evidenced by NMR spectroscopy. Moreover, it has been shown that the strategy is particularly useful in that, as well as introducing orthogonal functionality, it can (1) inhibit gelation in systems otherwise characterised by a high risk of gelation; (2) tune the molar

mass of the final polymer according to the level of end-capping monomer used in the polyaddition and (3) enhance the storage stability of the resulting hyperbranched poly(amido amine) in water. The attempted functionalisation of hyperbranched poly(amido amine)s with PIBSA (HPAMAM 1.C-type polymers) was more challenging as in this case the functionalisation occurs via nucleophilic substitution while the polymerisation proceeds via conjugated addition and the MBA and PIBSA have a significantly different reactivity towards EDA. However, NMR analysis provided evidence both of the reaction of the PIBSA-monomer with the primary amine of the EDA-monomer and of the polymerisation MBA-EDA with 65% of acrylamide conversion. Conclusive evidence of the molar mass of the resulting polymer was not achieved by SEC, possibly due to retention of the polymers HPAMAM 1.C2 and HPAMAM 1.C3 on the SEC column despite the use of THF + 1% TEA v/v as eluent. Nevertheless, satisfactory results were obtained for this preliminary work in so much that the following was achieved (i) a better understanding of the reactivity of the three compounds; (ii) optimisation of the reaction conditions (solvent, temperature, concentration) to allow in a one-pot reaction, the polymerisation and functionalisation of the polymer and (iii) evidence of a successful polymerisation of MBA-EDA and functionalisation of the resulting polymer with PIB groups. Strategies to improve the system are discussed in the future work section.

Finally, cationic hyperbranched polymers have been successfully synthesised by two methods of quarterisation: in one case the hydrochloride salt of polymer HPAMAM 4 was synthesised directly by the polymerisation of MBA and a diamine hydrochloride salt monomer, HDDC, while in the other case an alkylated polymer HPAMAM 5 was obtained by the methylation of the amine groups in a preformed polymer. In both cases, the successful production of a cationic hyperbranched polymer was proven by solution NMR spectroscopy and by solid-state ^{15}N -NMR spectroscopy. The latter analysis is a novel method of investigation for these polymers whereby the combined outputs of both cross-polarised and interrupted decoupled NMR experiments provides high selectivity for the ^{15}N nuclei and enables unambiguous assignment of the specific amine groups.

References

- ¹ Wang, D., Zheng, Z., Hong, C., Liu, Y., Pan, C. *J Polym Sci Part A*, **2006**, *44*, 6226–6242.
- ² Wang, D., Yu, Z.-Q., Hong, C.-Y., You Y.-Z., *Eur Polym J*, **2013**, *49*, 4189–4194.
- ³ Ping, Y., Wu, D., Kumar, J. N., Cheng, W., Lay, C. L., Liu Y. *Biomacromolecules*, **2013**, *14*, 2083–2094.
- ⁴ Wang, X., He, Y., Wu, J., Gao, C., Xu Y. *Biomacromolecules*, **2010**, *11*, 245–251.
- ⁵ Hassan, M. L. *J Appl Polym Sci*, **2006**, *101*, 2079–2087.

-
- ⁶ Li, M., Zhou, X., Zeng, X., Wang, C., Xu, J., Ma D., Xue W. *J Mater Chem B*, 2016, 4, 547-556.
- ⁷ Wang, H.-B., Chen, X.-S., Pan C.-Y. *Eur Polym J*, **2008**, 44, 2184–2193.
- ⁸ Yang, W., Pan, C.-Y., Liu, X.-Q., Wang J. *Biomacromolecules*, **2011**, 12, 1523–1531.
- ⁹ Brannon-Peppas, L., Blanchette, J. O. *Adv Drug Delivery Rev*, **2004**, 56, 1649–1659.
- ¹⁰ Chen, J., Wu, C., Oupicky, D. *Biomacromolecules*, **2009**, 10, 2921–2927.
- ¹¹ Yingnakhon, W., Srikulkit K. *Asian J Chem*, **2013**, 25, 4009-4012.
- ¹² Hobson, L. J., Feast, W. J. *Polymer*, **1999**, 40, 1279–1297.
- ¹³ Manaresi P., Munari A., Pilati F., Alfonso G. C., Russo S., Sartirana L. *Polymer*, **1986**, 27, 955–960.
- ¹⁴ Rosu R. F., Shanks R. A., Bhattacharya S. N. *Polym Int*, **1997**, 42, 267-275.
- ¹⁵ Hudson, N., MacDonald, W. A., Neilson, A., Richards, R. W., Sherrington D. C. *Macromolecules*, **2000**, 33, 9255-9261.
- ¹⁶ Hobson, J. L., Kenwright, A. M., Feast, W. J. *Chem Commun*, **1997**, 1877-1878.
- ¹⁷ Pirouz, S., Wang, Y., Chong, J. M., Duhamel J. *J Phys Chem B*, **2014**, 118, 3899–3911.
- ¹⁸ Nehal, S. A., Nassar, A. M., Abdel-Azim A. *Int J Polym Mater*, **2007**, 57, 114 - 124.
- ¹⁹ Evstafiev, V. P., Kotova, G. G. *J Appl Chem USSR* (Engl. Transl.), **1990** , 63, 416 - 421, 392 – 397.
- ²⁰ Yoda, H., Kitayama H., Katagiri, T., Takabe, K. *Tetrahedron*, **1992**, 48, 3313-3322.
- ²¹ Sanders, R., Snare, M., David, Y. *European Patent Application 0 330 375A1*, **1985**.
- ²² Jahnke, J.W. *EP 0 711 740A1*, **1996**.
- ²³ Cook, S. J., Pidsea, B. *US Patent 5 145 984*, **1992**.
- ²⁴ Kelland, M. A. *Production chemicals for the oil and gas industry*, CRC Press, Boca Raton (FL) **2009**.
- ²⁵ Zhao, X., Wu, D., Ma, C., Liu, L., Du, J., Liu, S. *Adv Mat Res*, **2011**, 311-313, 1124-1127.
- ²⁶ Killat, G. R., Conklin, J. R. *US Patent 4448708*, **1984**.
- ²⁷ Patil, A., Ferritto, M.S. *Polymers for Personal Care and Cosmetics*, ACS Symposium Series, American Chemical Society, Washington, DC, **2013**.
- ²⁸ Daenen, R. E. M. J., Derks, F. J. M., Weber, D., Wilz, R. *Patent US20150320670A1*, **2015**.
- ²⁹ Mang, T., Dresel, W. *Lubricants and Lubrication*, Wiley-VCH, Weinheim, **2007**.
- ³⁰ Lim, Y., Kim, S.M, Lee, Y., Lee, W., Yang, T., Lee, M., Suh, H., Park, J. *J Am Chem Soc*, **2001**, 123, 2460–2461.
- ³¹ Wolfert, M. A., Dash, P. R., Nazarova, O., Oupicky, D., Seymour, L. W., Smart, S., Strohal, J., Ulbrich, K. *Bioconjugate Chem*, **1999**, 10 , 993-1004.
- ³² Liu, Y., Wu, D., He, C., *Patent US008476386B2*, **2013**.
- ³³ Opella, S. J., Frey, M. H. *J Am Chem Soc*, **1979**, 101, 5854-5856.
- ³⁴ Philipsborn W., Müller, R. *Angew Chem Int Ed Engl*, **1986**, 25, 383-413.
- ³⁵ Kricheldorf, H. R. *Polym Bull*, **1980**, 3, 53-60.
- ³⁶ Vogl, O., Rehman, A., Zarras, P. *Monatsh Chem*, **2000**, 131, 437-449.

Chapter 6

**Properties and potential industrial
applications of hyperbranched
polymers HPAMAM 1 and
HPAMAM 3**

6.1 Introduction – properties and potential applications of hyperbranched poly(amido amine)s.

In previous chapters, the synthesis and functionalization of hyperbranched poly(ester amine)s and poly(amide amine)s have been discussed and it has been remarked how simple (one-step reaction and easy purification), versatile and cost-efficient the synthetic strategy is. All these aspects have encouraged the scale-up of the synthesis of hyperbranched poly(amide amine)s with a good reproducibility. The results obtained suggest that the synthesised polymers are potentially suitable for industrial applications and accordingly, a study of their properties has been carried out. Generally speaking, hyperbranched polymers have special properties which are the key to their industrial application and commercial success. In fact, the highly branched and dense-irregular structure leads to excellent solubility, low solution and melt viscosity and a high degree of terminal (functional) groups compared to linear polymers^{1,2}. In the light of these properties, hyperbranched polymers have been widely used as a reactive component in coating and resin formulations^{3,4} as polymer additives used for improving rheology and flow, for surface modification and enhancing the thermal and mechanical properties of a material^{5,6,7}. In this chapter, the properties and potential applications of the hyperbranched poly(amino amine)s synthesised in this study, from monomers MBA (A_2) and either EDA or PriamineTM (B_4) (Chapter 4) are discussed with an emphasis on both the importance of the resulting branched structure and the nature of the polymer (repeating unit and resulting end groups) which depends on the starting monomers selected. These last features dictate the final properties of a hyperbranched polymer⁸. For hyperbranched poly(amido amine)s (HPAMAMs), some potential properties and applications have been previously reported and are briefly discussed below. For instance;

1. The amino groups of HPAMAMs synthesised from MBA (A_2) and AEPZ ($B'B_2$) (molar ratio $A_2:B_4$ 1:1) were modified to allow the formation of a hydrogel by dynamic covalent bonds which can reversibly break and recombine. These hydrogels have found potential application in tissue engineering and controlled drug release⁹.
2. The high number of secondary and tertiary amine groups in HPAMAMs synthesised from CBA (A_2) and AEPZ ($B'B_2$) (molar ratio $A_2:B'B_2$ 2:1) act as a proton sponge, are able to confer a cationic character to the polymer in acidic conditions and therefore condense DNA for applications in gene therapy. For gene therapy applications, the numerous terminal groups of a hyperbranched polymer can be specifically modified to promote targeting of specific cancer cells (e.g. functionalisation with folate groups for

breast cancer cells)¹⁰. In this particular application, the biodegradability of the polymer is essential and can be easily achieved by synthesising such polymers by the double monomer methodology and choosing suitable monomers. This feature illustrates the versatility of the strategy chosen in this project which allows easy modification of the polymer structure and properties.

3. The amino-terminated HPAMAMs synthesised from 1MBA-1AEPZ (A_2 and $B'B_2$ monomers) are strongly electron-donating and can complex with metal ions (e.g. CdSe, Au, and Fe_3O_4). The HPAMAM acts in this way as a polymeric ligand that stabilises such ions in aqueous environments^{11,12}. Moreover, the branched structure with inner cavities and the absence of chain entanglements, promotes the formation of nanocomposite materials by hosting guest particles within the structure¹³.

6.2 Aims

The successful synthesis of hyperbranched poly(MBA-EDA) (HPAMAM 1) and poly(MBA-Priamine) (HPAMAM 3) has been previously described (see Chapter 4). The fact that these reactions could be easily scaled up with good reproducibility makes these polymers possible candidates for industrial scale-up and application. The properties of the polymers in the context of various applications were hence investigated under the supervision of Croda scientists. Croda has a great deal of expertise and wide interests in surfactants with emulsifying, dispersing, stabilising and wetting property profiles and the HPAMAMs produced in this program have been assessed by considering these properties.

In section 6.1, the properties and applications of HPAMAMs synthesised via the double monomer methodology, using monomer pairs with asymmetric functionalities (e.g. $A_2 + B'B_2$) have been discussed. Since the strategy ($A_2 + B_4$) adopted in this work has not been widely investigated for the synthesis of hyperbranched polymers, due to the risk of gelation, applications of polymers synthesised by such a strategy have not been found in the literature. The aim of the present work is to find, for the first time, potential commercial applications of polymers HPAMAM 1 (hyperbranched poly(MBA-EDA)) and HPAMAM 3 (hyperbranched poly(MBA-PriamineTM)) synthesised using the $A_2 + B_4$ system. In particular, the exploration of their properties as non-ionic surfactants or co-surfactants in the areas of crop care, personal care, geo-technologies and lubricants is discussed. Surfactants may play many different roles in formulations including foaming or anti-foaming agents, dispersants, wetting agents, detergents, emulsifiers and others. In some formulations, surfactants are used in combination with other surfactants, denoted as co-surfactants, to enhance their action. Thus, according to

the specific requirements of the application area selected, specific tests were carried out to evaluate the polymer's (HPAMAM 1 and HPAMAM 3) performance and the effectiveness of the polymers as non-ionic surfactants/co-surfactants.

- i. HPAMAM 1 is a water-soluble polymer with amine and amide groups. The polarity of this polymer enables its use in aqueous-based formulations and thus the properties in water were studied in order to establish potential applications in crop care and personal care.
- ii. HPAMAM 3 is a polymer characterised by medium polarity with both hydrophilic (amine and amide groups) and hydrophobic groups (aliphatic chains). The nature of this polymer permits, in this case, to test the properties as additive in the crude oil (geo technologies) and in base oils for lubricant formulations.

It is worth noting that the high degree of functional groups within the structure of the HPAMAM 1 and HPAMAM 3 is a significant advantage to enhance the performance of a product; hyperbranched polymers have also the potential to be more efficient and may be used in small amounts compared to their linear counterpart.

The results of this investigation will provide a general overview of the polymers' properties and provide a basis for future in-depth analysis in the selected application fields and possibly expanding applications into new fields.

6.3 Experimental part

6.3.1 Materials

Hyperbranched poly(3MBA-1EDA) – HPAMAM 1.7 and hyperbranched poly(3MBA-1PriamineTM) – HPAMAM 3.1 were synthesised as previously described. AtplusTM 245, SynperonicTM 10/6, suspension of titanium dioxide in water (SolavielTM CT-12W), CrodamolTM IPM (isopropyl myristate), glycerine, BrijTM S2, BrijTM S100, crude oil, KemelixTM D510, KemelixTM 3627X, n-hexane (laboratory reagent grade), toluene (laboratory reagent grade), distilled water, PAO6 (poly(alpha olefins), lubricant base fluid), PriolubeTM3959 (polyol ester, lubricant base fluid), glycerol mono-oleate (GMO, synthetic lubricant) were all used as provided by Croda.

6.3.2 Methods

Contact angle measurements

Polymer solutions were prepared in deionised water (0.2%, 1% and 10% w/w). Static contact angles were measured using a DataPhysics OCA20 contact angle instrument and SCA20 software. A 0.5 mm diameter needle was connected to syringe that allows the deposit of a small amount of the sample onto a surface covered by paraffin film (model hydrophobic surface). An optical microscope was used to obtain an image of the droplet and the contact angle calculated from this image using the SCA20 software.

Water wash-off resistance test

An aqueous suspension of titanium dioxide (Solaviel CT-12W) was prepared with 10% w/w of binder; either HPAMAM 1 or Atlox Semkote E135 – a Croda product. A 100 μm film of the suspension was deposited onto a Teflon square and dried at 40°C for several hours. The coated Teflon was then immersed into deionised water ~50 ml and subjected to vigorous agitation. At various times, a sample of the water was collected and measured in a UV spectrometer at 400 nm and the % transmission was recorded.

Static Surface Tension (Wilhelmy plate method)

Aqueous solutions at a concentration of 1% and 10% w/w of HPAMAM 1 were prepared and the surface tension measured at 22.5 \pm 0.5°C, by vertically suspending a platinum plate (2.0 x 1.0 cm) at the liquid/air interface (2 mm depth). The measurement was carried out using a Force Tensiometer – KRÜSS K100.

Dynamic Surface Tension (bubble pressure method)

Aqueous solutions at a concentration of 1% and 10% w/w of HPAMAM 1 (surfactant candidate) were prepared and the surface tension measured at 22.5 \pm 0.5°C by a SITA bubble pressure tensiometer. The working principles are described in section 6.4.1.

Co-surfactant test

HPAMAM 1 (0.10 g or 1 g) was added to 3 g of glycerine, 10 g of CrodamolTM IPM, 0.22 g of BrijTM S2 (emulsifying agent) and 0.68 g of BrijTM S100 (emulsifying agent) in water to produce a total of 100 g of formulation. The entire formulation was homogenised for 1 min at 2000 rpm with a mechanical stirrer. The stability of the resulting emulsions was evaluated at various times by a visual comparison with analogous formulations prepared without the polymer.

Interfacial tension (IFT) test

Interfacial tension for (a) a solution of HPAMAM 3 in toluene dispersed in distilled water and (b) a solution of HPAMAM 1 in water dispersed in toluene were measured with a Teclis Tracker tensiometer at $23.0 \pm 0.2^\circ\text{C}$.

Sample preparation (HPAMAM 3 solution) – a solution c.a. 100 ppm of HPAMAM 3 in toluene ($d = 0.867 \text{ kg/l}$) was prepared by heating the heterogeneous mixture of HPAMAM 3/toluene with stirring at 60°C for half an hour. Under these conditions HPAMAM 3 was found to be only partially soluble in toluene and filtration of the mixture to collect the soluble polymer fraction was necessary. For this reason the polymer concentration is reported as < 100 ppm in the later discussion.

Pour point measurement

The pour point of crude oil and crude oil/polymer samples was measured using a pour point tester, PPT 45150. The sample was prepared by adding 1 g of polymer to 30 ml of crude oil at 60°C (otherwise solid at RT). The sample crude oil/polymer was both analysed directly after mixing the two components together and by heating the whole sample at 60°C overnight before the test.

Turbidity measurement

The turbidity measurement was carried out to establish the suitability of the polymer as an asphaltene dispersant. 1 g of HPAMAM 3 was mixed with 15 g of crude oil and heated at 60°C for 2 hours. The whole mixture was dissolved in 90 g of toluene (0.94% w/w polymer solution) under stirring at 60°C and c.a. 4.4 mg of the cooled solution was added to 25 ml of n-heptane giving 2.4 ppm polymer in n-heptane, $d = 0.684 \text{ kg/l}$, to form the asphaltene dispersion sample. The dispersion was homogenised under stirring and c.a. 7.0 ml transferred in a test vial for the analysis. The turbidity measurements were obtained using a Turbiscan Lab that used a pulsed near infrared light source (850 nm) to measure the transmittance (% T) of the resulting dispersion. The % T was measured and recorded at 1 min intervals over a period of 900 s (15 min) along the height of the sample vial. The results of the measurement were presented by plotting the change in $\Delta T = \% T_{\text{top vial}} - \% T_{\text{bottom vial}}$ (where: top vial = 45 mm and bottom vial = 5 mm) with time (see Figure 6.15). A further description of the experiment is reported in the section 6.4.2.1.3.

High Frequency Reciprocating Rig (HFRR) test

The HFRR test assesses the performance of lubricant samples (base-oil/HPAMAM 3) and it is particularly suitable for wear testing and boundary friction measurements of lubricants. A schematic representation of the HFRR test is shown in Figure 6.1. The test involves a steel ball (diameter 6.0 mm) in contact with a stationary disk (diameter 10.0 mm and thickness 3.0 mm); the test ball and the disk are completely submerged in the lubricant sample and the entire apparatus is vibrated at 20 Hz for 60 min under a load of 400 g (4N). The test was carried out at 80 °C with the oil temperature controlled by a heater block with a variance of $\pm 1^\circ\text{C}$. From the test the coefficient of friction (COF) and diameter of the wear scar were measured. The COF could be measured through the frictional force and normal load according to Coulomb's law of friction. The diameter of the wear scar left on the ball is measured under a microscope. Sample (lubricant) preparation; in a typical experiment, 0.5 g of HPAMAM 3 was added to a base oil mixture, PriolubeTM3959 (8 g) and PAO6 (91.5 g), the whole sample was heated at 90°C, equilibrated at RT and tested.

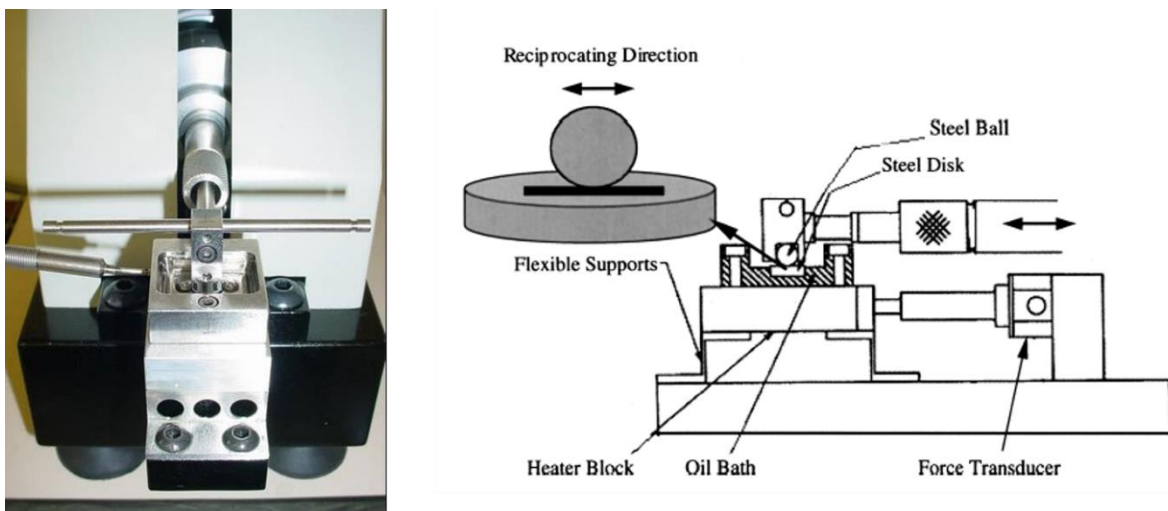

Figure 6.1 (left side) HFRR instrument used in Croda. (right side) schematic diagram of the test.

Mini Traction Machine (MTM) test

The mini traction machine (MTM) test evaluates the coefficient of friction (COF) of lubricant samples (base-oil/HPAMAM 3) in the mixed and hydrodynamic regimes of the Stribeck curve (Figure 6.16 and discussed further in section 6.4.2.2). In the MTM test, a rotating steel ball (steel AISI 52100, diameter 19.00 mm, hardness 800-920 HV, roughness $<0.021 \mu\text{m Ra}$) is in contact with a rotating steel disc (steel AISI 52100, diameter 46 mm, hardness 720-780 HV, roughness $<0.01 \mu\text{m Ra}$) as shown in Figure 6.2. The ball is loaded (with an applied load of

36N) against the face of the disc, and the ball and disc are driven independently to create a rolling and sliding contact. The disc is submerged in the lubricant (sample) bath which is temperature controlled; the temperatures used to test the lubricant were 40, 100 and 150°C ($\pm 1^\circ\text{C}$). Each temperature provides a Stribeck curve with the performance of the lubricant in analysis. The variance of the temperature was further reduced by covering the ball-on-disc set-up by a lid. Using a computer, testing parameters such as ball and disc speed, slide roll ratio (SRR of 0.5), temperature, and load can be regulated. The frictional force between the ball and disc is measured by varying the speed from 2.000 to 0.010 m/s by mean of a force transducer. Sample (lubricant) preparation; in a typical experiment, 0.5 g of HPAMAM 3 was added to a base oil mixture PriolubeTM3959 (8 g) and PAO6 (91.5 g), the whole sample was heated at 90°C, equilibrated at RT and tested.

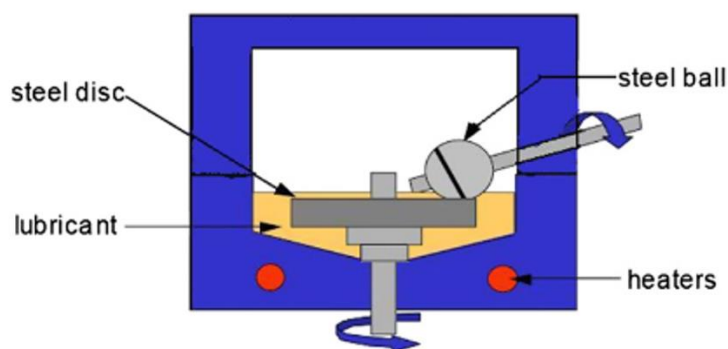

Figure 6.2 Schematic diagram of MTM test¹⁴.

6.4 Results and discussion

In this section the properties and potential applications of the samples HPAMAM 1.7 and HPAMAM 3.1, discussed in the Chapter 4, are investigated. For simplicity, such polymers are identified as HPAMAM 1 and HPAMAM 3 respectively throughout this work (Figure 6.3).

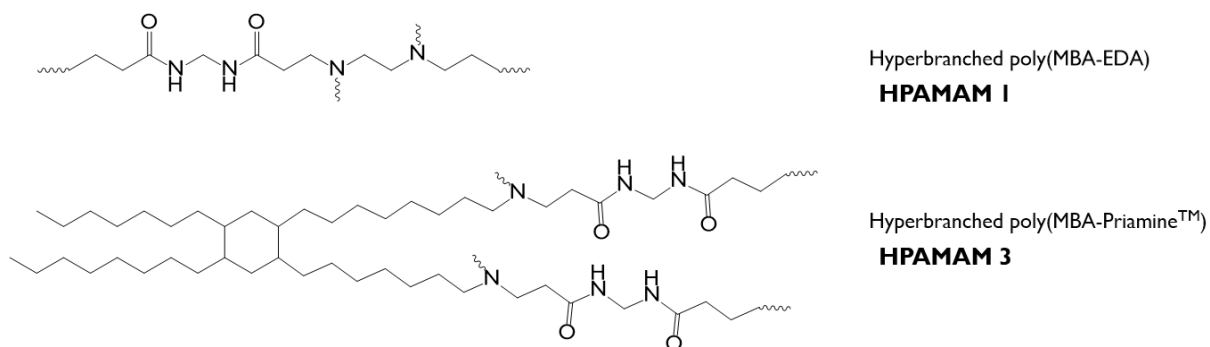

Figure 6.3 Structure of the hyperbranched polymers HPAMAM 1 and HPAMAM 3.

The different chemical structures of HPAMAM 1 and HPAMAM 3 confer different physical properties to the polymers and for this reason, different tests were carried out for the two polymers; largely on the basis of their solubility. HPAMAM 1 is a water-soluble polymer and for this reason was tested in aqueous-based formulations for applications such as crop care and personal care. In contrast HPAMAM3 is insoluble in water and for this reason was tested in other applications areas such as geo-technology (crude oil) and lubricancy. In both cases, the ability of the two polymers to act as non-ionic surfactants was investigated. Generally speaking, surfactants are molecules which are active at the interface/surface between unlike environments. In order to display this activity, such molecules must have a dual hydrophilic and hydrophobic nature. The stronger the tendency for the surfactant to accumulate and be active at the interface, the more effective the surfactant is. This tendency does not depend only on the structure of the surfactant but also on the nature of the two phases that meet at the interface. For this reason there is not a universally good surfactant which is suitable for all situations and the choice depends on the application¹⁵. Non-ionic surfactants show surface active properties without the presence of ions on their structure and generally rely on (poly)ether linkages, hydroxyl and amine groups for the hydrophilic nature and hydrocarbon chains for the hydrophobic character. The non-ionic character endows these molecules with properties including chemical compatibility with many chemicals and insensitivity to the presence of hard water¹⁶.

6.4.1 Hyperbranched poly(3MBA-1EDA) – HPAMAM 1: properties and applications

The surface tension and the contact angle (CA) of aqueous polymer solutions containing different concentrations of HPAMAM 1 were measured as a preliminary analysis according to the procedures described in section 6.3.2. The CA was used to quantify the tendency of the polymer solution to wet and spread on a waxy surface, specifically chosen to mimic the leaf surface for crop care applications, discussed in the next section. The CA is determined by measuring the angle formed between the polymer solution and the surface at the point of contact. The surface tension, defined as the cohesive force between the surface molecules of a liquid (e.g. water)¹⁷, quantifies the disruption of intermolecular bonds that occur when a surface is created; the surface tension of an aqueous polymer solution should deviate from the value corresponding to pure water. In particular, surfactants, being molecules with both

hydrophilic and hydrophobic nature and a tendency to accumulate at the boundary between phases, are able to reduce both the CA and the surface tension. Surface tension (σ) measurements were carried out under (1) static conditions using a Wilhelmy plate (described in the section 6.3.2) and (2) under dynamic conditions using a bubble pressure tensiometer. A brief description of the working principles of the bubble pressure tensiometer is reported below.

Bubble pressure tensiometer. The dynamic surface tension was measured by using a SITA bubble pressure tensiometer. The principle of the bubble pressure method is based on the flow of an air stream through a capillary, immersed into the solution to be analysed and the measure of the pressure which is needed to generate a bubble at the capillary tip, by mean of a pressure sensor. The pressure within the bubble varies continuously with its radius, from a minimum value, P_{\min} (A in Figure 6.4) to a maximum value P_{\max} (B in Figure 6.4). After the P_{\max} , the bubble grows quickly (C in Figure 6.4), separates from the capillary and a new bubble is formed (P_{\min} , A). The surface tension is calculated from the deviation between pressure maximum and minimum according to the Young-Laplace equation $\sigma = k \cdot (P_{\max} - P_{\min})$, where k takes into account the radius r of the probe tip. The P_{\max} is measured during the experiment as a function of time and this time-dependence is the result of diffusion of the surfactant molecules from the bulk phase to the air-solution interface.

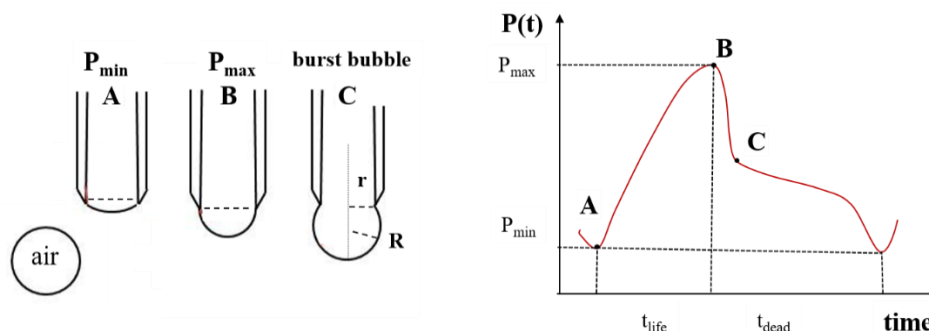

Figure 6.4 Dynamic surface tension of liquids (e.g. polymer aqueous solution) measured by bubble pressure method.

The time from the start of bubble growth to the maximum pressure defines the lifetime of the bubble (t_{life}), while the interval from P_{\max} until bubble departure from the probe tip is called deadtime (t_{dead}). During the experiment, air-bubbles are continuously produced and their lifetime varied from c.a. 31 s to c.a. 57000 s. The increase in the bubble lifetime can be achieved by decreasing the rate at which the bubbles forms (from 12.000 to 0.012 Hz), obtained by reducing the flow of the air stream. In the discussion of the results, σ of the test solution is plotted against the bubble lifetime. At short lifetimes (31 s, 12.000 Hz) the effect of

the surfactant can be considered negligible and $\sigma \approx \sigma_{\text{water}}$. The calibration was carried out automatically with water.

Contact Angle measurement

The contact angle (CA) was measured on a surface covered with a paraffin film for solutions containing 0.2 % w/w, 1 % w/w and 10 % w/w of the HPAMAM 1 polymer. The results in Table 6.1 clearly show that the presence of polymer in solution has an almost insignificant impact upon the CA of water, although a slight reduction in CA is evident for the solutions containing polymer at 1 % w/w and 10 % w/w. However, even in these cases the reduction in CA is considerably lower than would be expected for a surfactant. The reference sample listed in Table 6.1 represents an aqueous solution containing a surfactant with good wettability properties namely SynperonicTM 10/6 - polyoxyethylene (6) isodecanol, with a CA 60 degrees.

Table 6.1 Contact angle values of pure water and aqueous solutions prepared with 0.2, 1 and 10%w/w of HPAMAM 1 on a surface covered by paraffin film.

Sample	CA _{left} (degs)*	CA _{right} (degs)*
<i>pure water</i>	95.6	95.3
<i>0.2 % w/w HPAMAM 1</i>	94.7	94.1
<i>1 % w/w HPAMAM 1</i>	93.7	93.2
<i>10 % w/w HPAMAM 1</i>	93.5	93.0
<i>reference (0.2 % w/w surfactant)</i>	60-70	

* the values represent an average of three measurements.

The results obtained for the CA measurement show that polymer HPAMAM 1 does not have the properties to reduce the CA of the water. This behaviour is most likely due to the strong hydrophilic character of the polymer and the lack of a strongly hydrophobic moiety, which prevents the polymer accumulating at the interface and limits any surfactant properties.

Surface Tension measurement

Surface tension (σ) measurements were carried out with aqueous solutions containing 1 % w/w and 10 % w/w of the polymer under static and dynamic conditions. In Table 6.2 the results corresponding to the last point of the experiments are summarised. The value given for the reference sample listed in Table 6.2 is typical for a surfactant used in personal care products (< 45 mN/m).

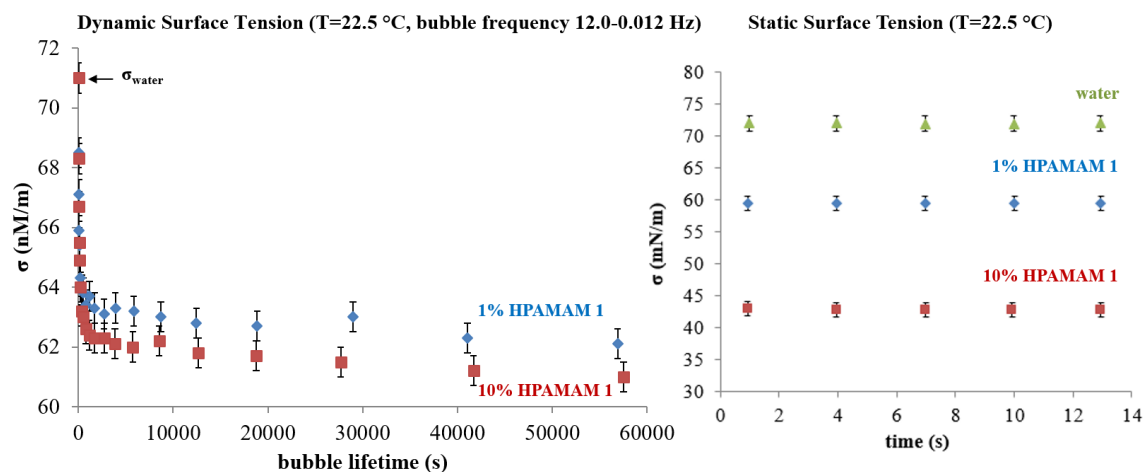

Figure 6.5 Dynamic (left side) and static (right side) surface tension measurement at 22.5 °C.

Static surface tension measurement. From the data presented in Figure 6.5 (right side), it is clear that under static conditions, the aqueous solution containing 10% of HPAMAM 1 does reduce the surface tension of the water and a comparison with the data in the Table 6.2 shows that such a reduction approaches the value expected for reference surfactants. However, although this result is comparable with the reference value, the amount of polymer used is significantly higher (10% polymer vs. 0.5% reference surfactant). When reducing the concentration of the polymer to 1% w/w, the effect of the polymer on the surface tension is less pronounced, although the σ of the water is still reduced. The increase of the σ with a decrease of the polymer concentration has already been observed in the literature for polymeric surfactants^{20,18}.

Dynamic surface tension measurement. Under dynamic conditions, the surface tension is measured as function of an air-bubble's lifetime, that is, the bubble's growth-time. Increasing the bubble lifetime (longer t_{life} , Figure 6.4) by decreasing the frequency at which the bubbles are produced, should enhance the effect of the polymer on the surface tension and the surface tension value tends towards that obtained under static conditions. The time required to reach such a value can be of the order of minutes to hours and depends on a number of parameters including the rate of diffusion of the polymer molecules to the air-liquid interface and the rate of their reorientation at the interface, polymer solution concentration, whether the surfactant is ionic or non-ionic, molecular weight and mobility¹⁹. The results obtained under dynamic conditions, in Table 6.2, reveal σ values which are considerably higher than those obtained under static conditions. The surface tension of the water can only be reduced when the polymer is present at the interface both at 1% and 10% polymer concentration. The reduced effect of the polymer on the σ values obtained under dynamic conditions with respect to those

obtained under static conditions may be due to the slow diffusion of the polymer to the interface. This behaviour is typical for polymers and in line with the results found in literature^{20,21,22}. Moreover, in this case an increase of the polymer concentration from 1% to 10%, does not lead to any significant variation of the surface tension. In fact, increasing the polymer concentration will lead to an increase in the viscosity of the aqueous HPAMAM 1 solution and therefore under dynamic conditions, the higher σ might be due to viscous resistance of the fluid against the growing air bubble interface²⁰. Such an increase of the σ measured in dynamic conditions has been observed in highly viscous aqueous solutions of polymers or glycerol^{21,23}.

Table 6.2 Surface tension (σ) values measured at T=22.5°C in static and dynamic conditions for the aqueous solutions containing 1 % w/w and 10 % w/w of the polymer HPAMAM 1; the values are compared with the σ of the water and a reference sample.

Sample	$\sigma_{\text{static}}^{\text{a}}$ (mN/m)	$\sigma_{\text{dynamic}}^{\text{b}}$ (mN/m)
1 % w/w HPAMAM 1	59.43	62.10
10 % w/w HPAMAM 1	42.80	61.00
pure water		72
reference (0.5 % w/w)		< 45

^a values obtained at t=13s.

^b value for a bubble lifetime of 57000 s (bubble frequency of 0.012 Hz).

The results in this section have shown that HPAMAM 1 (i) does not significantly reduce the CA of water on a waxy surface, most likely due to the hydrophilic nature of the product, (ii) reduces the σ value of the water measured under static conditions with the effect being more evident at high concentration (10% w/w), (iii) does not affect significantly the σ value of water measured under dynamic conditions, as in this case the rate of diffusion and the viscosity of the polymer solution may reduce the performance as surfactant. Although these preliminary results show that HPAMAM 1 is not a terribly effective surfactant, further application tests in the areas of crop care and personal care are discussed in the next section. In fact, aside the use of HPAMAM 1 as a surfactant, the polymer can also be tested as co-surfactant in various formulations. On the basis of the results obtained, optimisation of the product's chemical and architectural structure could be considered as future work to enhance the system. This optimisation can be easily achieved by the A₂ + B₄ approach reported in this thesis given the versatility of the synthetic strategy.

6.4.1.1 Crop Care Applications

Most agrochemical active ingredients (AAIs) are hydrophobic, dusty solids which are neither water-soluble nor water-dispersible. Specific formulations are hence required in order to

disperse the AAI in water, permit their use in spray formulations and reduce handling and safety problems for these products. Surfactants fulfil various roles in these formulations in terms of AAI performance namely (i) improved spray retention; (ii) ensuring good wetting, (iii) enhanced foliar penetration and (iv) inhibiting the evaporation of water droplets, thereby preventing precipitation of the AAI. Polymers are sometimes used as surfactants in this field as they enable cost-effective and rapid formulation^{24,25}. Generally speaking, low molecular weight, branched, non-ionic polymers e.g. alkoxyated alcohol, alkylpolysaccharide, polyoxyethylene (8) monobranched alcohol are considered good candidates as surfactants to enhance spray retention and therefore the availability of the AAI to the crop. In the present study, the effect of the polymer HPAMAM 1 as a co-surfactant was studied.

6.4.1.1.1 Effect of the HPAMAM 1 polymer on droplet formation

The results of contact angle and surface tension measurements obtained for HPAMAM 1, (section 6.4.1, Table 6.1 and Table 6.2) suggest that HPAMAM 1 is a poor candidate as a polymeric surfactant. However, polymers are often used in agrochemical formulations in combination with surfactants e.g. wetting agents, AAI uptake enhancers as anti-drift agents^{24,26}. Most agrochemicals e.g. pesticides, in particular for foliar application, are applied by spray as aqueous solutions and spray-drift is a significant risk that may occur when the dispersant formulation from the spray tank reaches the crop target, and can result in both inefficient use of the agrochemical and potential harm to the environment. From the spray-drift point of view, large droplets on the surface of the leaf are generally desirable to reduce the propensity of droplets to be affected by side winds²⁵. The incorporation of high MW polymer in agrochemical formulations reduces the risk of drifting by favouring the formation of larger drops (100-400 μ m). High MW polymers such as polyacrylamide, poly(ethylene oxide) and guar gum are generally added as drift control adjuvants²⁶ and this property can be achieved even at low polymer concentrations (0.01% w/w) for polymers with MW > 10⁶ g/mol. Therefore, both surfactants and polymers may be present in a spray formulation with the AAI, with the aim of improving the overall efficiency of the spray during application. In particular, the role of the polymer is to produce a viscoelastic film at the air/solution interface that modifies both the droplet size and the adhesion of the droplets to the leaf surface.

The size of the resulting droplets from aqueous solutions containing 0.2%, 1% and 10% w/w of the polymer HPAMAM 1 was evaluated by spraying the solutions onto a hydrophobic solid surface (paraffin film) to mimic the surface of leaves (see Figure 6.6). From the images presented in Figure 6.6, it can be seen that the addition of polymer does indeed modify the

size of the water droplets, even at concentrations as low as 0.2 % w/w and the effect becomes more appreciable at higher concentrations. In fact, by increasing the polymer concentration, larger droplets were obtained. This behaviour is likely to be due to the change of the viscoelastic properties of the aqueous solution when a polymer is added and these observations are in line with results previously reported in the literature^{24,26}. This initial analysis was only qualitative but the results obtained encourage additional future analysis such as quantitative analysis of the droplet size e.g. by using a laser diffraction droplet size analyser²⁷ and the evaluation of the performance of the polymer on an agrochemical formulation in presence of the active ingredients and typical surfactants.

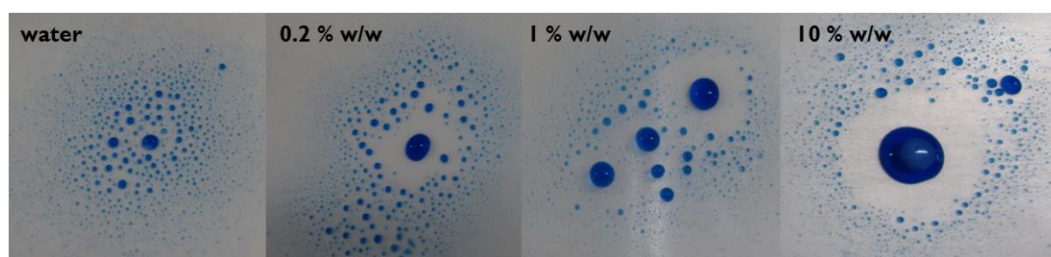

Figure 6.6 Impact of polymer concentration on the size of droplets formed by spraying onto a hydrophobic (paraffin) surface for samples with 0.2, 1 and 10 % w/w of polymer HPAMAM1 and pure water; the blue colouration of the droplets is due the addition of a dye. The picture has been cut maintaining the original (and uniform) scale.

From the droplet formation test, a further observation arose. Namely that after 24 hours, the evaporation of the water from the droplets of the polymer solutions produced a uniform solid film, independent of the initial polymer solution concentration. This observation suggests other possible applications of the polymer in crop care; in fact beyond the use of HPAMAM 1 as anti-drift agent, its use as binder for applications in seed-coatings was also considered. Seed-coatings help to form a true coating of active ingredients around a seed. The coating preserves the health of seeds during storage, transport and germination. This enables farmers to obtain higher yields through the efficient use of active ingredients²⁸.

6.4.1.1.2 Coating for seeds

Seed coatings are generally used to (i) protect the seeds from disease and pest attacks (ii) control germination, (iii) protect the seed from damage during handling and (iv) give a cosmetic appearance to the seed. The coating formulation is composed mainly of a binder, a filler, protection agents (e.g. fungicides and insecticides) and further components such as thickeners, colouring agents, anti-foaming agents, biocides and surfactants²⁹. The use of HPAMAM 1 as a binder is considered here. Binders generally comprise of water-soluble

polymers e.g. polyacrylamide, polyethylene oxide, polystyrene, polyurethane and methyl cellulose or waxes e.g. carnauba wax, paraffin wax and bees wax²⁹. The amount of binder used varies from 0.1 to 20% w/w based on the total weight of the coating powder³⁰. HPAMAM 1, being water-soluble, is a good candidate for this application. In order to test the ability of the polymer to act as a binder and form a resistant coating around the seed, a “wash-off resistance test” was carried out. Thus, a suspension of titanium dioxide (filler for the matrix of the coating) in water, containing 10% w/w of HPAMAM 1 was prepared. A film of the formulation was deposited onto a Teflon square, dried at 40°C for several hours and immersed into deionised water. The resistance/stability of the film was assessed by analysing samples of the water, after various times, by UV spectrometry. A lower value of transmission indicates more TiO₂ is liberated into the water, thereby indicating that the coating has low wash-off resistance. In Figure 6.7, the results obtained for the HPAMAM 1 polymer suspension are shown and compared to the behaviour of a suspension in water of titanium dioxide i) without binder (blank) and ii) with 10% of Atlox Semkote E135 – a commercial Croda product which is an ethylene vinyl acetate copolymer. It is clear that, although the solution containing HPAMAM 1 results in a less stable film than that prepared using the commercial benchmark binder, Atlox Semkote E135, HPAMAM 1 does enhance the resistance of the film compared to a formulation containing no binder.

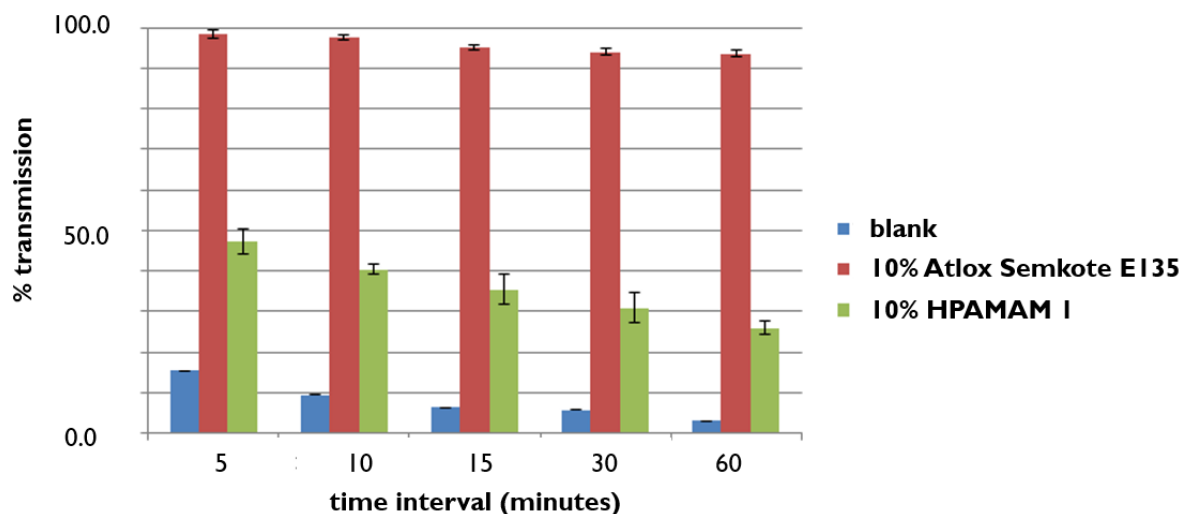

Figure 6.7 Water wash-off resistance test using UV transmission data. Comparison of the values of transmittance obtained with time for samples containing 10 %w/w of HPAMAM 1 (green), Atlox SemKote E135 (red) and the solution without any binder (blue).

In section 6.4.1.1 it has been shown that the hyperbranched poly(3MBA-1EBA), HPAMAM 1, has poor properties as a surfactant but it has been observed that such a polymer is able to increase the size of the water droplets by spraying. Therefore, HPAMAM 1 is a potential

candidate as an anti-drift agent which could be used in combination with surfactants in crop-care applications. As a TiO₂ binder it enhances the resistance of the coating for application in seed-coating treatments even if the performance is still modest compared to current commercially available products.

6.4.1.2 Personal care

The properties of the hyperbranched poly(3MBA-1EDA), HPAMAM 1, were also tested in the area of personal care products. Personal care includes applications in skin, sun and hair care formulations. The poly(3MBA-1Priamine) (HPAMAM 3) was not considered for this application area as it is not water-soluble and water is the main component in such formulations. Surfactants in personal care products help to stabilise oil-in-water emulsions but are also used as foaming agents, cleansing agents, wetting agents and conditioning agents to improve the appearance of hair and skin. The results of surface tension measurements obtained in section 6.4 have shown that HPAMAM 1 is not an effective surfactant therefore good emulsifier properties were not expected. However, it was thought that HPAMAM 1 might act as stabiliser – a co-surfactant able to further improve the stability of the emulsion; this property was hence tested.

6.4.1.2.1 Co-surfactant agent

Further experiments were carried out to test the properties of the polymer as a co-surfactant or more specifically as a stabiliser to help promote the stability of emulsions. VersaflexTM-V150 is a Croda product that acts as oil-in-water emulsifying and stabilization system composed by 22% w/w of BrijS100 (alcohol ethoxylate) and 68% w/w of BrijS2 (polyoxyethylene fatty ethers) as emulsifying agents and 10% w/w of Xanthan gum as a stabiliser. HPAMAM 1 in this context is tested as a replacement for the gum which acts as a stabilising agent in VersaflexTM-V150. To test this property, the polymer was added at concentrations of 0.1% and 1% w/w to formulations containing BrijS100 (0.68% w/w) and BrijS2 (0.22% w/w). The formulations containing HPAMAM 1 are shown in Figure 6.8 (emulsions C and D) and the emulsion stability was tested by observing the emulsions 1 and 4 days after the emulsion preparation. The stability of such emulsions was compared with emulsions containing the same type and amount of emulsifiers and (i) with gum as stabiliser (emulsion A in Figure 6.8) and (ii) without the gum (emulsion B in Figure 6.8). After 1 day, only formulations C and D (containing HPAMAM 1) underwent phase-separation while emulsion B was stable. It is

worth noting that HPAMAM 1 reduces the stability of the emulsion even at a low concentration (0.1% w/w). After 4 days, only formulation A, containing the emulsifier and the stabiliser remains homogeneous, as expected. The results shown in Figure 6.8 illustrate that HPAMAM 1 is not able to act as stabiliser in presence of emulsifier agents and rather, accelerates the phase-separation of the emulsion and this effect is already significant at low polymer concentrations (e.g. 0.1% w/w).

Emulsions water/Crodamol™ IPM

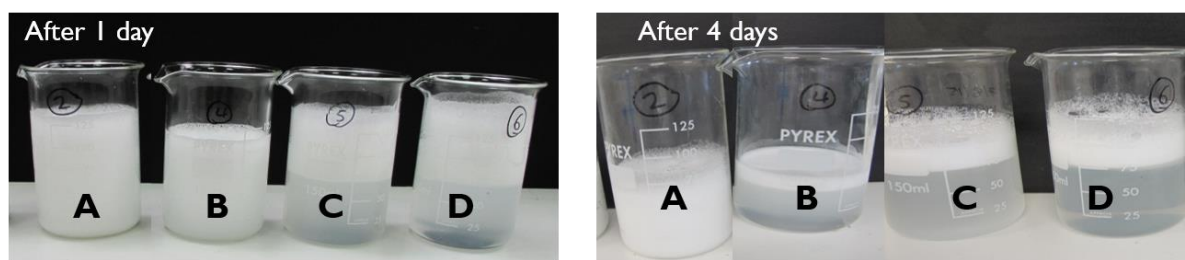

- A. 0.68% BrijS2 + 0.22% BrijS100 + 1% gum (1% Versaflex™-V150)
 B. 0.68% BrijS2 + 0.22% BrijS100
 C. 0.68% BrijS2 + 0.22% BrijS100 + 0.1% HPAMAM 1
 D. 0.68% BrijS2 + 0.22% BrijS100 + 1% HPAMAM 1

Figure 6.8 Emulsion of water/Crodamol™ IPM after 1 day and 4 days in presence of (A) 1% Versaflex™-V150 containing BrijS2 and BrijS100 as emulsifier and gum as stabiliser; (B) BrijS2 and BrijS100 without stabiliser; (C) BrijS2 and BrijS100 with 0.1% w/w HPAMAM1 as stabiliser and (D) BrijS2 and BrijS100 with 1% w/w HPAMAM 1 as stabiliser.

These results suggest that the polymer HPAMAM 1 is not a suitable candidate as an emulsifier/stabiliser for applications in personal care. This is perhaps not surprising given the hydrophilic nature of the polymer which inhibits accumulation of the molecules at the water/oil interface and consequently leads to no reduction of the interfacial tension. However, the observed ability of HPAMAM 1 to accelerate the phase-separation of oil/water may find use for other applications such as demulsification. This potential will be considered as future work to promote the separation of oil/water in the crude oil for instance.

6.4.2 Hyperbranched poly(3MBA-1Priamine™) – HPAMAM 3: properties and applications

The properties of the hyperbranched poly(3MBA-1Priamine™), identified as HPAMAM 3 (Figure 6.3), were studied in the field of geo technologies as a surfactant for crude oil and as an additive for lubricants used for machine components. HPAMAM 3, in contrast to HPAMAM 1, is a water-insoluble polymer bearing hydrophobic moieties and therefore

different application areas were explored. In particular, the action of HPAMAM 3 as a demulsifier, wax inhibitor or dispersant in crude oil was tested. Moreover, in the lubricants area, the coefficient of friction was measured under different conditions to establish its efficiency as additive.

6.4.2.1 Geo Technologies

Crude oil is composed of stable emulsions with varying levels of water dispersed in a continuous oil phase (water-in-oil emulsion) and stabilised by compounds naturally occurring in crude oil including asphaltenes, resins, and solids such as clays and waxes³¹. The water in the emulsion must be separated out before the crude oil is acceptable for further transportation or treatment at a refinery. In fact the dispersed water in the oil occupies space in the processing equipment and pipelines increasing operating and capital costs and causes corrosion problems during the refining process. Typically, the accepted water content is dictated by the sale specification and is in the range of 0.2–0.5 %³⁶. The role of a demulsifier is to destabilise the crude oil emulsion and therefore demulsifier molecules must be able to migrate rapidly through the crude oil phase to reach the droplet interface where it must counteract and displace the emulsifying agent. Such a class of molecules (demulsifiers) generally have a higher hydrophilic character than emulsifiers³². Typical demulsifiers are non-ionic polymers with MW in the range of 2,000-50,000 g/mol and most of them have a comb or branched architecture. Examples of polymers used as demulsifiers include alkylphenol-aldehyde resin alkoxyates, polyalkoxyates of polyols, polyamine polyalkoxyates, polyurethanes, hyperbranched polymers and polysiloxanes. Hyperbranched polymers including hyperbranched polycarbonates, polyesters, polyethers, polyurethane, polyamide, polyamine, poly(ester amine) and quaternised poly(amido amine), have all been claimed to act as water-in-oil demulsifiers^{33,36}. Small molecule amines are also good candidate demulsifiers but the efficiency of these small molecules is significantly lower than that of polymers³¹. Generally speaking, a demulsifier can act (i) as a ‘dropper’ if its primary function is to coalesce water droplets and release free water or (ii) as a ‘treater’ if it can flocculate a large number of sub-micron sized water droplets dispersed in the crude oil (Figure 6.9).

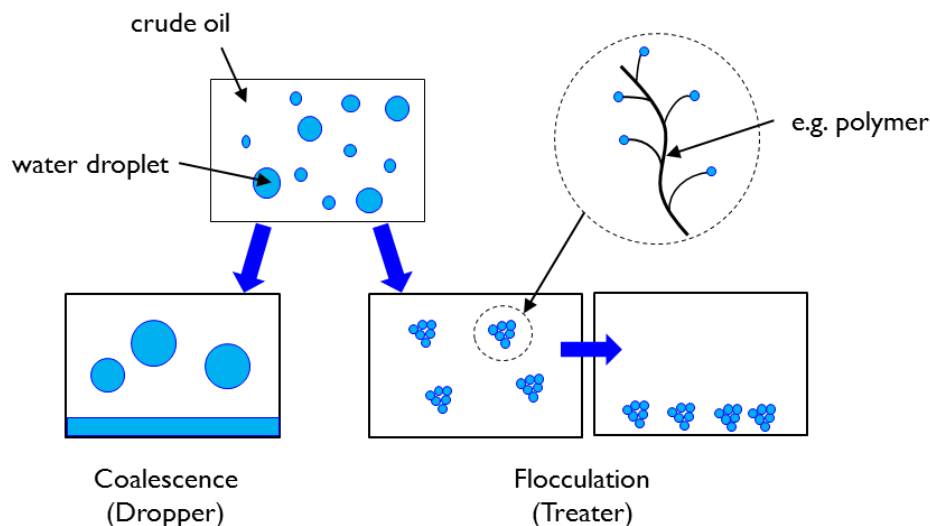

Figure 6.9 Scheme of the demulsification paths for crude oil: coalescence (left side, dropper molecule) and flocculation (right side, treater molecule).

In light of these considerations, the synthesised HPAMAM 3 is a promising class of candidate macromolecules for such application as the amine and amide groups permit the interaction of the polymer with the water molecules while the branches increase the efficiency of the polymer as a demulsifier enhancing the “capture” of water droplets in the oil.

6.4.2.1.1 Demulsifying agent

The ability of HPAMAM 3 to act as demulsifier was in this preliminary work tested by evaluating the adsorption kinetics of the polymer at the oil/water interface. For this purpose the dynamic interfacial tension was measured. The interfacial tension (IFT) describes the forces at the interface between oil and water. An effective demulsifier of a water-in-oil emulsion must mix with the emulsion and migrate to the interface of the water droplets lowering of the IFT³⁴. The dynamic interfacial tension was measured by the rising drop method in which the IFT is determined from the shape of a drop rising from a needle in a bulk liquid. Briefly: a light source (2, Figure 6.10), a cuvette (3) containing a rising drop of toluene/HPAMAM 3 in water and a CCD camera (6) are aligned on an optical bench (1). The drop of toluene/HPAMAM 3 or toluene is formed by using a syringe (4) and a motor (5) for pressing down the syringe. After the drop formation, the drop profile is digitised through the CCD camera and a computer (7). The monitor (8) is used to align and adjust the drop. The tensiometer allows the variation of the surface tension $\sigma(t)$ with time to be recorded, with $\sigma(t)$ deduced on the basis of mathematical analysis of the axial symmetric shape of the drop (Laplacian profile³⁵), by applying a controlled dilatational perturbation to the drop area.

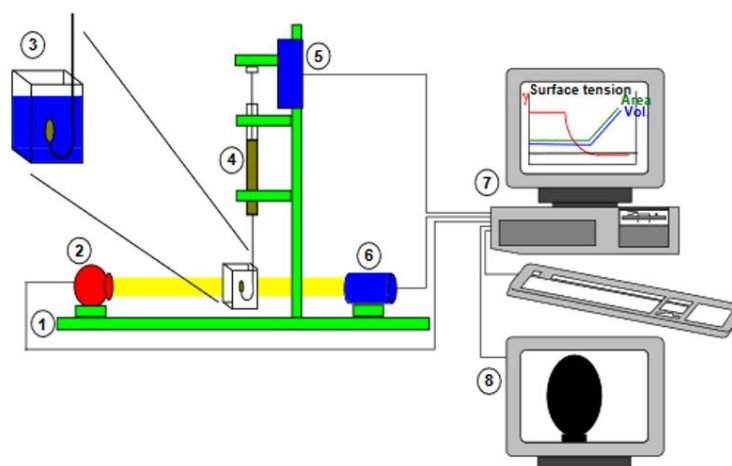

Figure 6.10 Schematic representation of a Teclis Tracker drop tensiometer.

HPAMAM 3 is soluble in CHCl_3 at RT and in THF and DCM at 40-50°C but it was found to be only partially soluble in toluene under heating at 60°C. Therefore, only the soluble part of the polymer in toluene, purified by filtration, was analysed. As a result, in the current study, the concentration of the polymer in toluene was not known accurately, and for this reason, in the present discussion the concentration is reported as <100 ppm (100 ppm would be the theoretical maximum concentration had HPAMAM 3 been 100% soluble in toluene). The IFT was measured by the rising drop method with a droplet of a HPAMAM 3/toluene solution (<100 ppm) in water (red trace, Figure 6.11). The error bars were calculated from three independent experiment and estimated to be around 1%.

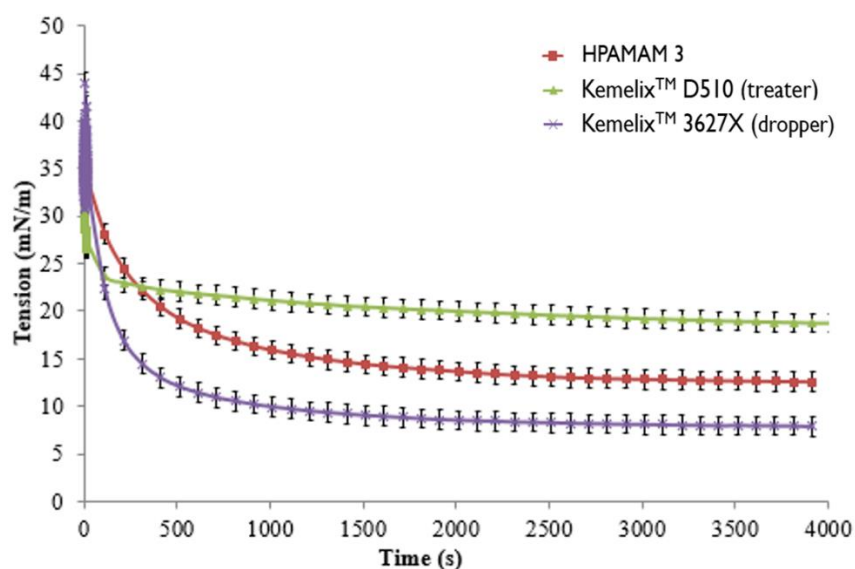

Figure 6.11 Comparison of the dynamic interfacial tension for a drop of toluene+HPAMAM 3 (<100ppm) in water and for a drop of toluene containing 10 ppm of commercial demulsifiers (Kemelix™ D510 and Kemelix™ 3627X) in water.

The results obtained for HPAMAM 3 are presented in Figure 6.11 along with those of two typical commercial demulsifiers produced by Croda that i) act as a treater (Kemelix D510 - polyimine alkoxyate, green trace) and ii) act as a dropper (Kemelix 3627X - resin alkoxyate, violet trace). Croda's products were analysed under the same conditions as HPAMAM 3 but at the lower concentration of 10 ppm. It is worth pointing out that the results obtained from the IFT measurement for the polymer show some important limitations, namely; (i) unknown nature and amount of soluble fraction of HPAMAM 3 in toluene and (ii) inability to directly compare the behaviour of HPAMAM 3 with that of the Croda products due to the different concentrations used. In fact, the rate of diffusion of the molecules to the interface increases with the concentration³⁴ and therefore the unknown concentration of the polymer in toluene leads to an inability to compare the measurements. Despite the limitations discussed, the results obtained for HPAMAM 3 do indicate some effect on the IFT. In fact a significant reduction of the interfacial tension from 45 to 13 mN/m is observed for HPAMAM 3 in c.a. 2500 s (c.a. 70% reduction from the starting point). Moreover, the trend of the curve observed is typical for demulsifiers - namely (i) an initial sharp decrease of the IFT associated with the migration of the demulsifier molecules from the surface adjacent to the interface and (ii) a subsequent, more gradual reduction in the IFT due to the diffusion of the molecules from the bulk (long process) and (iii) ultimately the interface becoming saturated and the equilibrium interfacial tension is reached³⁴. This behaviour encourages further investigations into such polymers as potential demulsifiers.

6.4.2.1.2 *Flow improver*

In the oilfield industry, wax (or paraffin) deposition is a significant issue since it can result in blockage of the oil pipes. At high pressure and temperature, any waxes within the oil will be in solution but when the temperature of the crude oil drops, the wax may start to precipitate. Another problem related to the presence of wax in crude oil, is the increased viscosity and potentially solidification of the oil due to the high amounts of wax precipitate in the oil, which in turn leads to an increase of the pumping pressure³⁶. In order to prevent wax deposition and wax solidification, wax inhibitors and flow improvers are generally used. A wax inhibitor is a compound which is able to lower the cloud point of the crude oil while a flow improver lowers the pour point. The cloud point is defined as the temperature at which precipitation of the first wax crystals in the crude oil occurs and the pour point (PP) represents the lowest temperature at which the crude oil remains fluid - below the PP the crude oil solidifies and loses its fluidity. Polymers such as ethylene-based copolymers e.g. ethylene/vinyl acetate,

ethylene/acrylonitrile copolymers, comb polymers e.g. acrylate or methacrylate ester polymers and branched polymers e.g. hyperbranched poly(ester amine)s, derivatised branched PEI, are often used as wax inhibitors and flow improvers. In all cases it is required that the polymer possesses (i) a long alkyl groups which are able to interact (e.g. via van der Waals interaction) with the wax, thereby modifying the crystallisation process which leads to wax deposition and (ii) a polar part (e.g. vinyl acetate, maleic anhydride or acrylonitrile) to inhibit the aggregation of the wax by covering sites where new wax molecules could attach^{36,37,38}. Moreover, it has been observed that comb and branched polymers, once adsorbed onto the growing wax crystals, have the additional ability to sterically hinder crystal growth, reducing the size of the crystal^{36,39}. Thus, the presence of branching side-chains in the polymer additive can be a further advantage. In this section, the effect of HPAMAM 3 as a flow improver is investigated. HPAMAM 3 is potentially suitable for this role since the polymer is branched with both non-polar (alkyl) groups and polar (amine and amide) groups. Generally, a crude oil with a high pour point indicates high wax content and the addition of a flow improver should decrease the temperature of the PP by up to 10-15°C. In order to determine the ability of the polymer to act as flow improver, the pour point was measured. The PP was determined according to the method described at the end of this section. The results are summarised in Table 6.3 and compared with the results obtained for the blank sample (crude oil). The data in Table 6.3 clearly shows that the addition of HPAMAM 3 does not modify the PP of the crude oil significantly during the cooling cycle from 105 (temperature at which all paraffin within the oil have been dissolved) to 25 °C. This result suggests that the polymer is not able to alter the flow properties of the crude oil. As HPAMAM 3 has been shown to require heating to dissolve it in THF and DCM and even with heating is only partially soluble in toluene, it was supposed that simply mixing of the polymer with the crude oil may not be sufficient to guarantee the solubilisation or a good blending of the polymer in oil. Therefore, the measurement was repeated by warming the polymer/oil mixture overnight at 60 °C prior to repeating the measurement. This additional step of heating the test sample before the measurement has already been reported in the literature (55°C for 2h) to promote mixing of the test sample and to make surfactant molecules more effective in crude oil⁴⁰. The heat-treated sample actually increases the PP of the crude oil significantly from 35.5 to 52.5 °C. Since an effective flow improver would be expected to lower the pour point, this result suggests that the polymer does not improve the system and it is not an effective flow improver. In fact the addition of the polymer produces a worse result than the blank sample.

Table 6.3 Pour point values obtained for the crude oil (blank) and crude oil in presence of HPAMAM 3 polymer. The sample crude oil/polymer was analysed directly after mixing the two component together and by heating the whole sample at 60 °C overnight before the test.

sample	treatment	PP (°C) T=105-25 °C
crude oil (blank)	-	35.5
HPAMAM 3	-	37.5
HPAMAM 3	60°C (overnight)	52.5

On the basis of the results obtained in Chapter 4 for HPAMAM 1 in which the occurrence of chain coupling and gelation in the presence of water has been reported, similar behaviour for HPAMAM 3 can be expected. In this case, it can be speculated that heating the polymer in the crude oil overnight, can result in an increase the MW of the polymer, possibly resulting in the formation of a cross-linked structure. This behaviour can itself lead to an increase of the viscosity of the crude oil.

Pour point measurement. The pour point measures the lowest temperature at which the oil continues to flow, as the oil is cooled without stirring. The measurement is carried out according to the rotational method, an automatic method in which a temperature sensor is used to detect the increase in viscosity of the sample on cooling. The sample cup (1, Figure 6.12) is filled with the sample and then set to a slow rotation of about 0.1 rpm by a motor (4). A temperature sensor (2) is dipped in the sample and the pour point measured in the temperature of 105-25°C. When the pour point is reached, the viscosity of the sample increases and the temperature sensor is moved out of its position, which triggers a light barrier sensor (3) that generates a signal and indicates the end of the test. The pour point can be determined with an accuracy of 1°C.

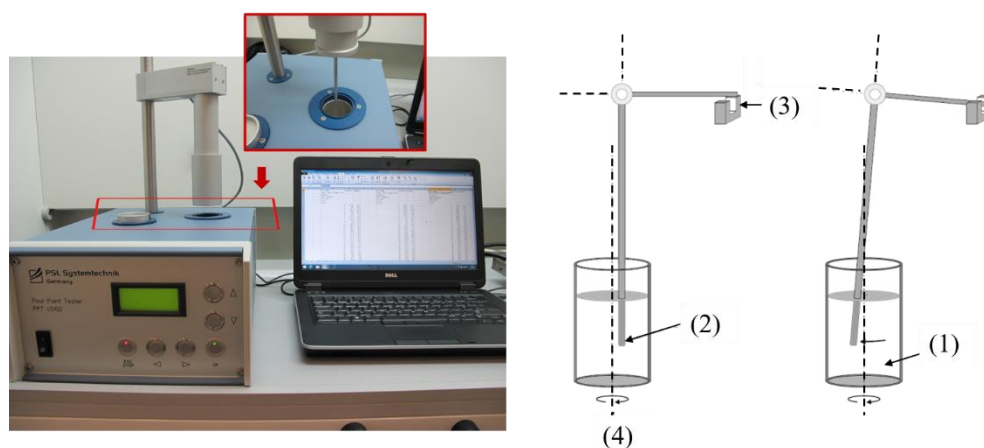

Figure 6.12 Pour point measurement by rotation method for crude oil and crude oil/polymer samples.

6.4.2.1.3 Asphaltene dispersant and inhibitors.

Asphaltenes are organic solids comprising of various polyaromatic structures with aliphatic side chains and functional groups such as sulphides, thiophenes, sulfoxide, carbonyl, hydroxyl/phenolic, pyrrolic, pyridine and occasionally tertiary amine groups⁴¹. Metals such as nickel, vanadium and iron are also present as a complex and the metals impart electrical charge. Asphaltenes are a complex mixture of species with a large range of structures which are difficult to characterise because of the tendency of such molecules to aggregate⁴² in solution and therefore only a representative structure can be drawn, see Figure 6.13.

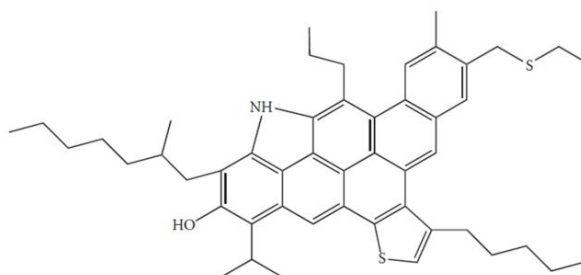

Figure 6.13 Representative structure of a proposed asphaltene molecule³⁶.

They are insoluble in light aliphatic hydrocarbons such as pentane and heptane but are soluble in aromatic solvents such as toluene and benzene. Asphaltene is considered to be the heaviest component in crude oil with a tendency to self-aggregate. The solubility of asphaltene in crude oil varies with the composition of the oil and external conditions such as temperature and pressure. The formation of asphaltene deposits is a big problem in the petroleum industry since the deposits can cause blockages in the pipelines and holdup production. Asphaltene dispersants (ADs) and inhibitors (AIs) are therefore used widely in industry to prevent the deposition of such molecules. In particular, AIs inhibit the aggregation of asphaltene molecules by adsorbing to the asphaltene surface and saturating the sites that promote the formation of larger aggregates. ADs reduce the particle size of the aggregates, helping to keep them in suspension in the crude oil³⁶. ADs therefore disperse preformed asphaltene flocculates. Polymeric surfactants bearing a polar (e.g. carboxylic acid, sulfonic acid, hydroxyl, amine, imide, amide) groups and non-polar groups (e.g. long alkyl long chains) are often used as AIs and ADs since the polar moiety can interact with asphaltene molecule (e.g. π - π , acid-base and dipole-dipole interactions, hydrogen bonding or metal-ion complexes) and prevent aggregation while the non-polar groups help to change the polarity of the outer surface of the aggregates and promotes dispersion in the crude oil. Moreover, compared to small molecules, polymers ensure a higher number of interactions because of the numerous

polar groups present within the polymeric structure. Polymers such as alkylphenol-aldehyde resin oligomers; polyolefin esters, amides or imides with alkyl or alkylene-pyridyl groups; hyperbranched poly(ester amide)⁴³; alkenyl/vinyl pyrrolidone are some examples of polymeric surfactants used³⁶. HPAMAM 3 is potentially a good candidate since the amide groups may interact with the asphaltene particles via hydrogen bonding and the alkyl chains of Priamine™ may maintain the aggregates in solution. Moreover, the hyperbranched polymers offer a much higher number of interaction sites (polar groups) than analogous linear polymers and small molecules. The ability of the polymer to act as an AI and/or AD was measured by dynamic turbidity using a TurbiScan. The method is described in section 6.3.2. The instrument measures the sedimentation of the asphaltene molecules in hexane (a poor solvent) by measuring the change in transmitted light (% T) through dispersions over time. Transmittance is measured along the height of the sample as shown in Figure 6.14. Initially (at time, $t=0$) the asphaltene molecules are dispersed homogeneously and the entire tube is opaque; in this case % T approaches zero, as shown in Figure 6.14 (a) for the blank sample (crude oil without dispersant). As the asphaltene settles ($t=x$), the upper part of the solution becomes clearer allowing more light to be transmitted ($\Delta T > 0$). When a good AI or AD is used, the asphaltene molecules should remain well-dispersed and the transmitted light remains constant and % T remains close to zero during the time of the measurement (Figure 6.14, b).

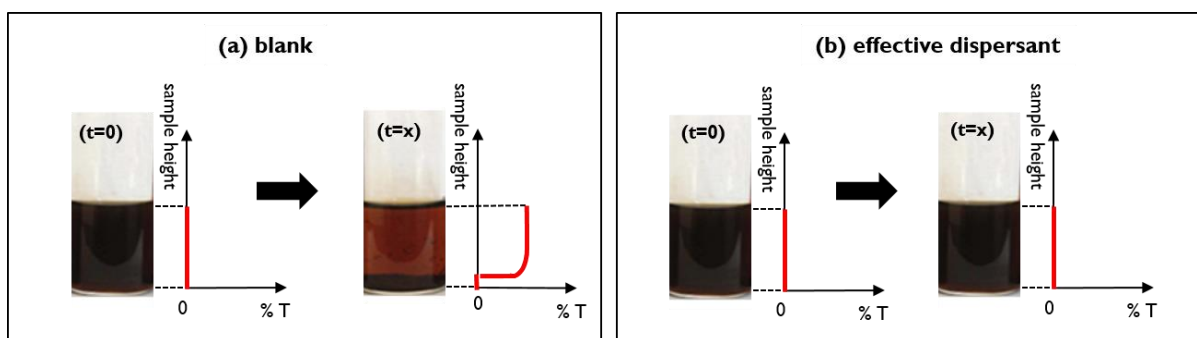

Figure 6.14 Dynamic turbidity measurement. Change in light transmittance along the height of the sample at $t=0$ and $t=x$ for (a) the blank sample and (b) the sample containing a good asphaltene dispersant.

The measurement was carried out by recording the variation of transmittance along the sample height as function of time at 1 min intervals over a 15 minute period (900 sec). In Figure 6.15 the ΔT values, defined as ($\% T_{\text{top vial}} - \% T_{\text{bottom vial}}$) obtained at a certain time t , for the blank and HPAMAM 3 samples are plotted against time of measurement and compared. The samples were prepared by dissolving in toluene (a good solvent for the asphaltene molecules present in the crude oil) at a concentration of c.a. 15 % w/w; (i) the crude oil only for the

blank sample and (ii) the crude oil containing ~6 % w/w HPAMAM 3. Subsequently aliquots of the toluene solutions were added to *n*-heptane (a poor solvent) to form an asphaltene dispersion (ratio toluene solution:*n*-heptane c.a. 1:5.5). It is worth noting that the sample of crude oil/HPAMAM 3 was heated at 60°C for 2h to improve the mixing/interaction of the two compounds before dissolving the whole sample in toluene (at 60°C). Under these conditions it was observed by visual examination, that only a negligible amount of polymer was not dissolved in toluene, a solvent in which the polymer had been previously found to be only partially soluble at 60°C. This observation of apparently improved polymer solubility might suggest evidence of a favourable interaction between the polymer and crude oil.

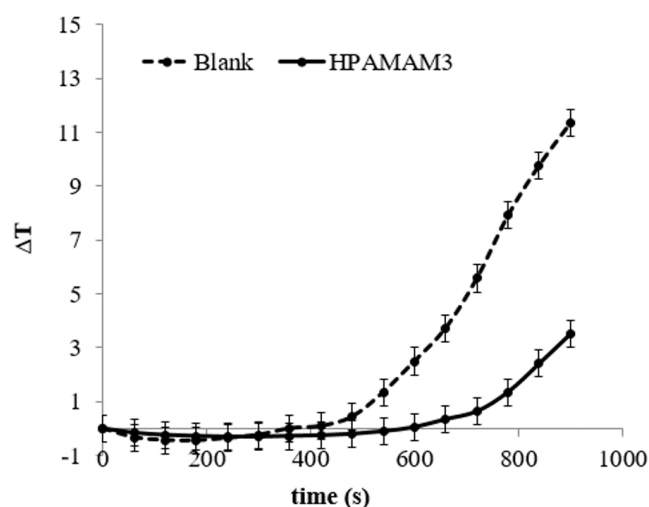

Figure 6.15 Asphaltene dispersant test: a plot of ΔT (where $T = \text{transmittance}$) and $\Delta T = T_{\text{top}} - T_{\text{bottom}}$) as a function of time (t) for samples containing crude oil (blank) and c.a. 2.4 ppm of HPAMAM 3 polymer in hexane.

From the graph in Figure 6.15 the effect of the polymer can be observed; the error bars were calculated from three independent experiment. From the graph emerges that HPAMAM 3 significantly (i) reduces the final ΔT value compared to the blank sample and (ii) delayed the onset of sedimentation to approximately 600 s (for the sample with the polymer) from approximately 400 s (for the blank sample). A lower ΔT value indicates a more homogeneous dispersion and indicates that the polymer is able to help stabilise the asphaltene dispersion. From the ultimate ΔT values of the measurement, the ability of the polymer to disperse asphaltene can be quantified by calculating the efficacy of the system measured with respect to the blank sample (Equation 6.1). A surfactant which is able to maintain a perfectly homogeneous dispersion of asphaltene for the duration of the measurement would have 100 % efficacy ($\Delta T_{\text{sample}}=0$).

$$\% \text{ Efficacy} = \frac{\Delta T_{\text{blank}} - \Delta T_{\text{sample}}}{\Delta T_{\text{blank}}} \cdot 100$$

Equation 6.1

For the system with HPAMAM 3 as dispersant, an efficacy of 69% was obtained (Table 6.4). This notable result suggests that the polymer, under the conditions described, is able to postpone the agglomeration and sedimentation of the asphaltene and act consequently as good dispersant for such molecules. As a comparison, in Table 6.4, the efficacy values obtained at a given concentration of typical asphaltene dispersants produced by Croda are listed; from the table can be noticed that an increase of the concentration leads to an increase of the efficacy. Although the comparison of the values in Table 6.4 suggest that the polymer, used in concentration of 2.4 ppm in heptane, is a less effective dispersant than the benchmark (e.g. FlowSolve™, a phenolic polymer), the results obtained for HPAMAM 3 would suggest that HPAMAM 3 a suitable candidate to consider for further investigations in the context of this application.

Table 6.4 Efficiency percentage (Equation 6.1) values calculated from the asphaltene dispersant test related to the concentration used for the sample and treatments used.

Dispersant	Concentration (ppm)	Efficacy %
<i>HPAMAM3</i>	2.4	69
<i>Croda's product</i>	1.6	97
<i>Croda's product</i>	0.8	45
<i>Croda's product</i>	0.4	21

6.4.2.2 Lubricants

The ability of HPAMAM3 to act as an additive in lubricant formulations for machine components, and in particular gear and transmissions was tested. The formulation of a lubricant is a balanced mix of a number of components and consists of base oils and a combination of additives that confer a specific performance and duration to the lubricant when in use. Typical base oils include mineral oils (mixtures of hydrocarbons obtained from crude oil by a conventional refinery process), synthetic hydrocarbons (e.g. polyalphaolefins and poly(alkylene glycols)), and naphthenic oils (e.g. rapeseed oil and castor oil). Lubricant additives are substances added to a lubricant formulation to achieve specific properties in use. Typical additives include detergents, anti-oxidants, anti-wear and anti-corrosion additives, pour point depressants, viscosity index enhancers, anti-foaming agents and friction modifiers⁴⁴.

In order to investigate the potential of HPAMAM 3 as a base-oil additive, the coefficient of friction was measured. Friction is the mechanical force that resists movement between rolling or sliding surfaces, caused by microscopic contact points. Therefore the coefficient of friction (COF) is defined as the ratio between the force of friction between the two surfaces and the

force pressing them together⁴⁴. A good lubricant should reduce friction by inhibiting this micro-contact. The lubricant is in fact a liquid which is able to flow and ideally, a lubricant flows in perfect layers (laminar flow). Therefore, the lubricant's layers and consequently the two (lubricated) surfaces slide freely past one another reducing friction⁴⁵. The performance of a lubricant can be assessed by measuring the COF under conditions known as lubricant conditions, described by the Stribeck diagram, shown in simplified form in Figure 6.16⁴⁴.

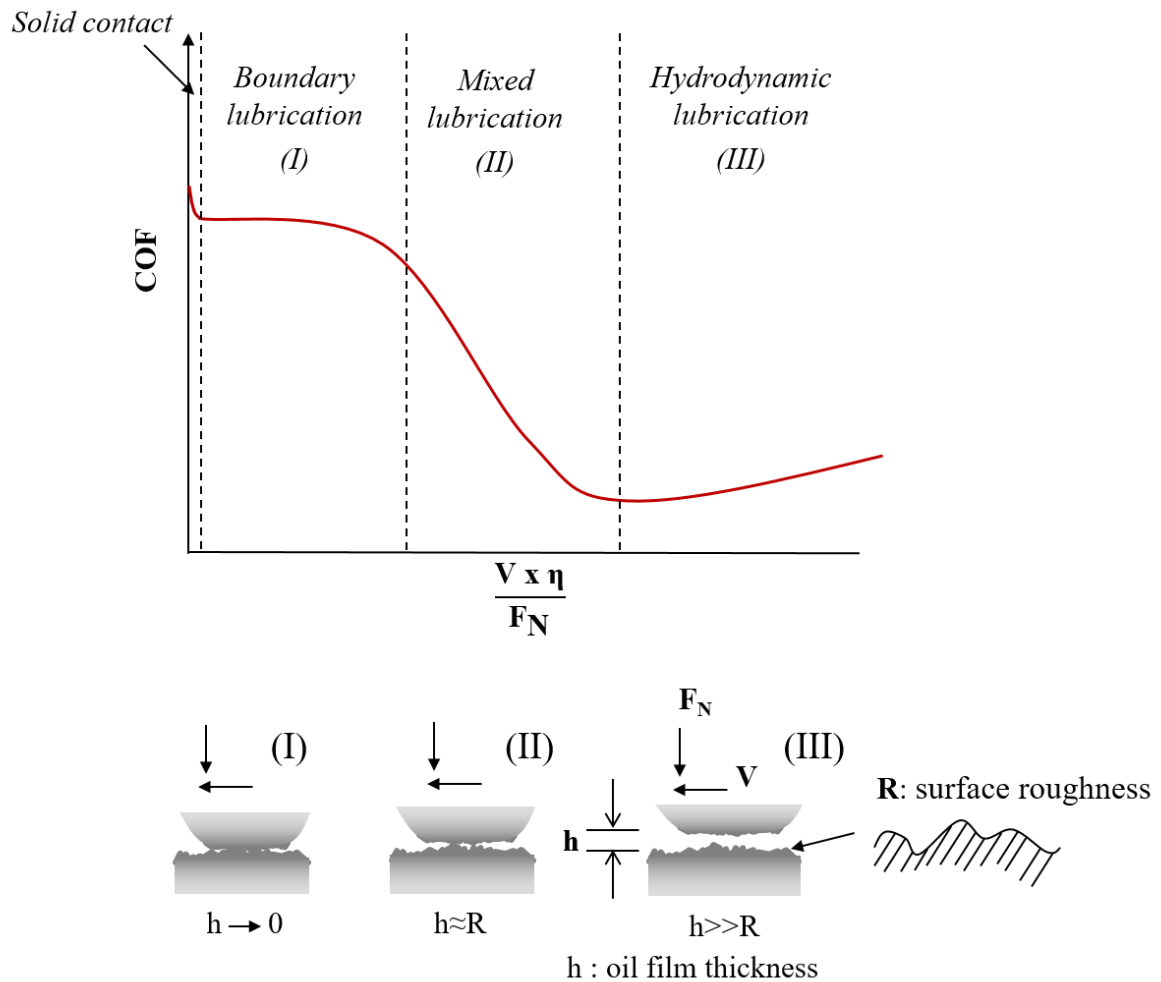

Figure 6.16 Stribeck curve and lubricants regimes⁴⁶.

The Stribeck diagram describes the relationship between the COF, viscosity of the lubricating oil (η), load (F_N) and sliding velocity of the two surfaces (V) and the curve in Figure 6.16 shows the characteristics of four lubrication regimes: solid contact, boundary (I), mixed (II) and hydrodynamic (III) lubrication⁴⁷.

- When $V = 0$, the COF is characterised by the highest value since the surfaces are in contact through the surface asperities and the monolayer of lubricant (static friction).

- As V grows, lubrication at the boundary conditions is achieved. This regime is characterised by a high COF as the two surfaces are still in contact albeit in different locations (metal-metal contact) and covered by a molecular layer of lubricant. The lubricating oil has a negligible effect on the COF in these conditions.
- A further increment of V causes an increase of the thickness of the lubricant layer and the lubricant provides some separation between the metal surfaces. The greater is V , the thicker is the oil film (h) due to hydrodynamic forces of the lubricant in the non-contacting points. As the metal-metal contact decreases, the COF decreases until at the optimal speed, minimum friction occurs.
- Hydrodynamic lubrication is characterised by a low COF as no metal-metal contact is involved. The two metal surfaces are completely separated by a film of lubricant (h). Therefore, the COF depends only on the viscosity of the lubricant used and consequently an increase of the sliding velocity results in an increase in the friction caused by the viscosity of the lubricant itself.

Generally speaking, an additive which is able to affect the COF in the boundary and mixed regime, is acting as friction modifier while a viscosity modifier is likely to improve the performance of the lubricant under hydrodynamic conditions.

The COF of the base oil containing HPAMAM 3 was measured under boundary conditions, by the high frequency reciprocating rig test (HFRR) and under mixed-hydrodynamic conditions by the mini-traction machine test (MTM). The tests are described in section 6.3.2. For a base oil additive to be considered effective it does not need to prove beneficial under all regimes. A good additive may show improved properties in only one of the three regimes and hence may be used for different applications.

HPAMAM 3 was found to be insoluble in the base oil at room temperature, most likely due to its polarity. Heterogeneous mixtures should be avoided for this type of test in order to keep the surfaces of the instrument's components intact and therefore preserve the accuracy of the measurement. In order to dissolve the polymer, the sample of polymer in base oil was heated to 90°C and then equilibrated at RT before testing. This resulted in a homogeneous solution of polymer/oil. It is worth remembering that HPAMAM 3 is fully soluble in THF and DCM and partially soluble in toluene when heated at 60°C. However in base oil, 60°C was not high enough to promote the solubilisation of the polymer and therefore a temperature of 90°C was used.

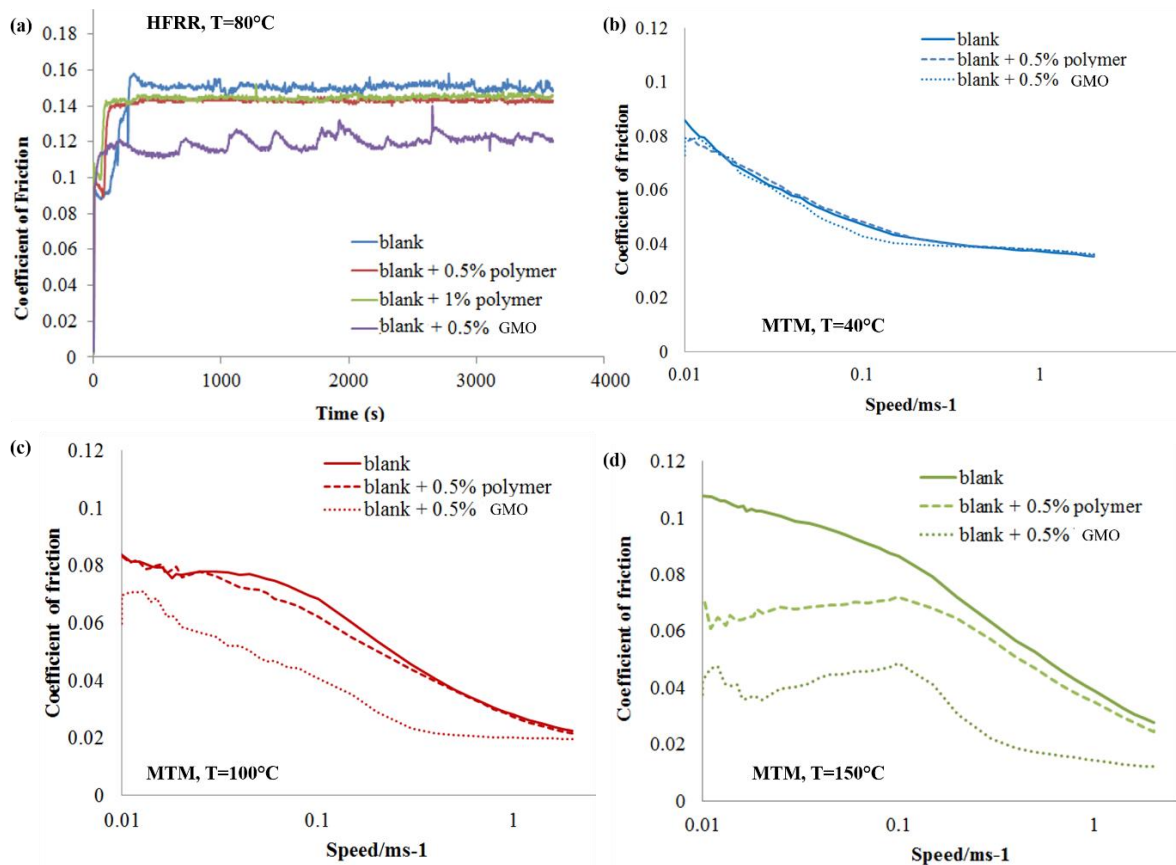

Figure 6.17 (a) Variation of the COF with time measured by HFRR test for samples of base oil with 0% (blank), 0.5% and 1% of HPAMAM3, and a sample containing 0.5% of a typical synthetic lubricant (GMO). (b) Variation of the COF with the test specimen rotational speed measured by MTM test at 40°C (c) at 100°C and (d) at 150°C.

In Figure 6.17 the results of the HFRR and MTM tests are shown. The HFRR test (Figure 6.17 (a)) was carried out at 80°C on 4 samples;

- i. synthetic oil (PAO6 + 8% PriolubeTM3959 where PAO6 is a polyalphaolefins and PriolubeTM3959 a saturated polyolester) with no additive – this constitutes the blank sample
- ii. synthetic oil containing 0.5 % w/w HPAMAM
- iii. synthetic oil containing 1 % w/w of HPAMAM 3 polymer and
- iv. a sample of oil containing 0.5% w/w of a glycerol monooleate (GMO) – a commercial lubricant.

A comparison of the results shows that for the HFRR test, a small reduction in the COF is observed for the two samples containing polymer compared to the blank sample. However an increase of the polymer concentration within the oil does not lead to any significant improvement. Although the addition of the polymer to base oil reduced the COF of the system, the reduction of the COF in the boundary regime is still small compared to the sample containing GMO. As shown in Figure 6.1 (section 6.3.2), in the HFRR test a steel ball slides

on a stationary disk and therefore the test also quantifies abrasion. The wear scar produced by the test ball on the underlying surface can be measured under a microscope to find the average diameter of the scar. This measurement is possible because the test is carried out under boundary conditions whereby the two metal surfaces are in contact (dry friction). The scar diameters are reported in Table 6.5 and show that the polymer is unable to protect the components and reduce the wear scars to the same extent as the sample containing 0.5% GMO. Moreover, an increase in the amount of polymer in the formulation results in an increase of the surface wear.

Table 6.5 Average diameter of the scars measured with a microscope from the HFRR test for the base-oil (blank) containing different concentrations of poly(3MBA-1Priamine) (HPAMAM3 polymer).

Blends	Average diameter scars (μm)
Blank	146.5
blank + 0.5% w/w polymer	147
blank + 1% w/w polymer	164
blank + 0.5% w/w GMO	123.5

The MTM test was carried out at 40°C, 100°C and 150°C. The graphs in Figure 6.17 show the reduction of the COF at a given temperature in the mixed and hydrodynamic regime. The sample containing the synthesised polymer (0.5% w/w) is compared with the blank (base-oil) and the sample with 0.5% GMO (synthetic lubricant). At 40 °C the COF has a similar trend for all the samples. At 100°C, a reduction of the COF (compared to the blank) is observed in the mixed and hydrodynamic regime for the sample with GMO but the sample containing polymer only showed a small improvement under mixed lubricant conditions. However, at 150 °C, both the sample with GMO and that with HPAMAM 3 show a significant reduction of the COF in the mixed regime – although the GMO is clearly more effective than the polymer. The polymer does therefore shows some promise at higher temperatures and might have some potential as a friction modifier, however further studies are required in order to improve the solubility of the polymer in base-oil, achieved in this case at 90°C, and improve the performance of the polymer in the boundary, mixed and hydrodynamic regime.

In summary, hyperbranched poly(3MBA-1Priamine) – HPAMAM 3 - has been investigated as a possible additive in lubricant formulations. The results have shown that the polymer is able to lead to a modest reduction in friction at the boundary condition and to a significant reduction in the mixed lubricant regime conditions at 150°C. However, below 100°C the polymer is not able to reduce the COF either in the mixed or hydrodynamic regime. It is worth restating that these results have been obtained by heating the sample polymer/base oil at 90°C before the tests, therefore future studies are necessary to (i) understand the stability of the

synthesised polymer at such a temperature in oil-environment and (ii) improve the solubility and the performance of the polymer by choosing different A₂ and B₄ monomers for the original synthesis.

6.5 Summary of the results

Herein the potential properties of hyperbranched poly(3MBA-1EDA) – HPAMAM 1 - and poly(3MBA-1Priamine) – HPAMAM 3 - as non-ionic surfactants were studied.

HPAMAM 1 polymer

HPAMAM 1 is a water-soluble polymer and its properties were evaluated in crop care and personal care applications where aqueous formulations are used. Preliminary analyses showed that the polymer does not perform terribly well as a surfactant. In fact, as an additive in water, the polymer is not able to reduce significantly the contact angle of water on a hydrophobic surface. The polymer lowers the static surface tension compared to pure water at high polymer concentration (10% w/w) however, such concentrations are significantly higher than those commonly used in commercial formulations (e.g. 0.5% w/w) and the polymer does not affect the surface tension value of the water measured under dynamic conditions. This poor performance is likely due both to the hydrophilic nature of the polymer and the slower diffusion properties of polymers compared to small molecules observed at the interface air/solution. Therefore, applications as a co-surfactant were considered for HPAMAM 1.

- For crop care applications, HPAMAM 1 showed the potential to act as anti-drifting agent; in fact, compared to the droplet of pure water, the addition of the polymer can result in the formation of larger droplets and possibly improve the adhesion of the droplet on the surface of leaves. This latter property has to be further investigated. Moreover, it has been observed that droplets of aqueous HPAMAM 1 solution can form a uniform coating after 24 hours when exposed in air at RT. This observation led to tests designed for applications in seed treatments and in particular the polymer was studied as binder for seed coatings. The result of this test showed the presence of the polymer enhances the resistance of the coating.
- For personal care applications, HPAMAM 1 showed poor properties as co-surfactant (stabiliser). The polymer has both a tendency to break the emulsion and accelerate the phase-separation between oil and water. This latter observation can be an advantage for potential applications of the polymer as a demulsifying agent.

HPAMAM 3 polymer

The properties of HPAMAM 3 were studied in the field of both geo technologies and lubricants. In geo technologies, the ability of the polymer to act as demulsifier, a flow improver and asphaltene dispersant was studied.

- Demulsifier: the dynamic interfacial tension (IFT) was measured. The IFT reduction and the trend of the IFT curve observed for the HPAMAM 3 provide some evidence of the activity of the polymer as a demulsifying agent. Even in this case, additional tests have to be carried out in order to confirm this effect.
- Flow improver: the impact of HPAMAM 3 as an additive in crude oil was assessed by measuring the pour point of crude oil/polymer. However, the polymer was not able to reduce the pour point of the oil, suggesting that the polymer is not an effective flow inhibitor.
- Asphaltene dispersant: the dispersant efficiency of the formulation containing 2.4 ppm of the polymer was significantly enhanced in comparison to crude oil (with no polymer added) and moreover a delay on the sedimentation time of the asphaltene was observed.

In the field of lubricants, the properties of HPAMAM 3 as an additive were studied.

- In the boundary regime, a reduction of the coefficient of friction (COF) or wear was not observed when 0.5% w/w and 1% w/w of polymer was used. There is little to suggest that the polymer may act as boundary lubricant or anti-wear additive.
- Moreover, the polymer does not act as hydrodynamic lubricant (viscosity modifier), in fact no reduction of the COF was observed at 40°C, 100°C and 150°C.
- Significant reduction of the COF was however observed in the mixed regime at 150°C.

Thus, the polymer shows potential utility as a friction modifier at high temperatures.

The sample of polymer/oil was heated at 90°C prior the tests described above to allow the solubilisation of the polymer in oil, therefore additional analysis has to be carried out to study the stability of the polymer in oil at such temperature and exclude potential modification of the polymer in oil.

References

¹ Voit, B. I. *J Polym Sci, Part A: Polym Chem*, **2000**, 38, 2505-2525.

² Hult, A., Johansson, M., Malmström, E. *Adv Polym Sci*, **1999**, 143, 1-34.

- ³ Schmaljohann, D., Voit, B. I., Jansen, J. F. G. A., Hedriks, P., Loontjens, J. A. *Macromol Mater Eng*, **2000**, 275, 31-41.
- ⁴ Johansson, M.; Malmström, E.; Hult, A. *J Polym Sci, Part A: Polym Chem*, **1993**, 31, 619-624.
- ⁵ Monticelli, O., Oliva, D., Russo, S., Clausnitzer, C., Pötschke, P., Voit, B., *Macromol Mater Eng*, **2003**, 288, 318-325.
- ⁶ Massa, D. J., Shriner, K. A., Turner, S. R., Voit, B. I. *Macromolecules*, **1995**, 28, 3214-3220.
- ⁷ Kim, Y. H., Webster, O. W. *Macromolecules*, **1992**, 25, 5561-5572.
- ⁸ Voit, B. I. *C. R. Chimie*, **2003**, 6, 821-832.
- ⁹ Yang, W., Wu, X., Liu, F., Dou, Y., Hub, Z., Hao, W., *RSC Adv*, **2016**, 6, 34254-34260
- ¹⁰ Li, M., Zhou, X., Zeng, X., Wang, C., Xu, J., Ma, D., Xue, W. *J Mater Chem B*, **2016**, 4, 547-556.
- ¹¹ Talapin, D. V., Rogach, A. L., Mekis, I., Haubold, S., Kornowski, A., Haase, M., Weller, H. *Colloids and Surfaces A: Physicochem. Eng. Aspects*, **2002**, 202, 145-154.
- ¹² Ji, M., Wuli Yang, W, Ren, Q., Lu, D. *Nanotechnology*, **2009**, 201-11.
- ¹³ Zhang, Y., Peng, H., Huang, W., Zhou, Y., Zhang, X., Yan, D. *J Phys Chem C*, **2008**, 112, 2330-2336.
- ¹⁴ Zhu, Y., Olofsson, U, Persson, K. *Wear*, **2012**, 292-293, 218-231.
- ¹⁵ Kronberg, B., Holmberg, K., Lindman, B. *Surface Chemistry of Surfactants and Polymers*, **2014**, Wiley, The Atrium Southern Gate Chichester West Sussex (England).
- ¹⁶ Behrens, R. W. *Weeds*, **1964**, 12, 255-258.
- ¹⁷ Petrucci, R. H. *General Chemistry: Principles and Modern Applications*, **2007**, Prentice Hall, Upper Saddle River, NJ.
- ¹⁸ Chang, C.H., Franses, E.I. *Colloid Surfaces A*, **1995**, 100, 1-45.
- ¹⁹ Persson, B., Nilsson, S., Sundelof, L.-O. *Charbohyd Polym*, **1996**, 29, 119-1276.
- ²⁰ Manglik, R. M., Wasekar, V. M., Zhang, J. *Exp Therm Fluid Sci*, **2001**, 25, 55-64.
- ²¹ Fainermana, V.B., Makievski, A.V., Millerb, R. *Colloid Surfaces A*, **1993**, 75, 229-235.
- ²² Rosen, M.J., gao, T. *J Colloid Interf Sci*, **1995**, 173, 42-48.
- ²³ Hirt, D. E., Prud'homme, K., Miller, B., Rebnfeld, L. *Colloid Surfaces*, **1990**, 44, 101-117.
- ²⁴ Wang, R., Dorr, G., Hewitt, A., Cooper-White, J. *Colloid Surfaces A*, **2016**, 500, 88-97.
- ²⁵ Knight, K., Blease, T. *Speciality Chemicals Magazine*, **2013**, 33, 18-19.
- ²⁶ Tadros. T. F., *Colloids in Agrochemicals, Volume 5: Colloids and Interface Science*, **2009**, Wiley-VCH.
- ²⁷ Dorr, G.J., Hewitt, A.J., Adkins, S.W., Hanan, J., Zhang, H., Noller, B. *Crop Prot*, **2013**, 53, 109-117.
- ²⁸ Hinkes, T. M., Wis. M., *Patent US3950891 A*, **1976**, Florida Celery Exchange, Orlando.
- ²⁹ Reus, H.A.M., Glas, Glas, J. *Patent EP2408290 A1*, **2012**.
- ³⁰ Kitamura, S., Masashi Watanabe, M., Nakayama, M. *Patent US4250660 A*, **1981**, Osaka, Japan.
- ³¹ Mosayebi, A., Abedini R. *Petroleum and Coal*, **2013**, 55, 26-30.
- ³² Rondón, M., Bouriat, P., Lachaise, J. *Energy & Fuels*, **2006**, 20, 1600-1604.
- ³³ Bruchmann, B., Büchner, K.-H., Guzman, M., Brodt, G., Frenzel, S. *International Patent Application WO2006084816*.
- ³⁴ Bhardwaj, A., Hartland, S. *Ind. Eng Chem Res*, **1994**, 33, 1271-1279.

-
- ³⁵ Saulnier, P., Boury, F., Malzert, A., Heurtault, B., Ivanova, T., Cagna, A., Panaïotov I., Proust, J. E. *Langmuir*, **2001**, *17*, 8104-8111.
- ³⁶ Kelland, M. A., *Production chemicals for the oil and gas industry*, **2009**, CRC Press, Boca Raton, FL.
- ³⁷ Yang, F., Zhao, Y., Sjöblom, J., Li, C., Paso, K. G. *J Disper Sci Technol*, **2014**, *36*, 213-225.
- ³⁸ Al-Shafy, H. I., Ismail, E.A. *J Eng*, **2014**, *4*, 54-61.
- ³⁹ Bucaram, S. M. *J Petrol Technol*, **1967**, *19* (2), 1544-1554.
- ⁴⁰ Kraiwattanawong, K., Fogler, H. S., Gharfeh, S. G., Singh, P., Thomason, W. H., Chavade, S. *Energy Fuels*, **2009**, *23*, 1575–1582.
- ⁴¹ F. Trejo, G. Centeno, J. Ancheyta *Fuel*, **2004**, *83*, 2169-2175.
- ⁴² McKenna, A. M., Donald, L. J., Fitzsimmons, J. E., Juyal, P., Spicer, V., Standing, K. G., Marshall, A. G., Rodgers, R. P. *Energy Fuels*, **2013**, *27*, 1246–1256.
- ⁴³ Cornelisse, P. M.W. *US Patent US007122113B2*, **2006**, Houston, TX (US).
- ⁴⁴ Mang, T., Dresel, M. *Lubricants and Lubrication*, 2nd Ed, **2007**, Wiley-VCH, Weinheim, DE.
- ⁴⁵ Ludema K. C. *Friction, Wear, Lubrication: A Textbook in Tribology*, **1996**, CRC Press, Boca Raton, FL.
- ⁴⁶ Hironaka, S. *Three Bond Technical News*, **1984**, *1*, 1-8.
- ⁴⁷ Klebanov, B. M., Groper M. *Power Mechanisms of Rotational and Cyclic Motions*, **2016**, CRC Press, Boca Raton, FL.

Chapter 7

Conclusions and Future work

7.1 Summary and conclusions

The double-monomer methodology based on the polymerisation of the A_2 and B_4 monomers via aza-Michael addition was selected as a strategy for the synthesis of hyperbranched polymers. With reference to the five points summarised in Chapter 2 which describe the objectives of this project, the following conclusions can be drawn from the results found in the Chapter 3, 4, 5 and 6:

1. The reaction conditions of the $A_2 + B_4$ polyaddition were explored for the synthesis of PEAs (where $A_2 = \text{PEGDA}$ and $B_4 = \text{EDA}/\text{HDA}$) and HPAMAMs (where $A_2 = \text{MBA}$ and $B_4 = \text{EDA}$) as a first approach to control/inhibit gelation. The selected $A_2 + B_4$ system represented an effective approach for the synthesis of hyperbranched polymers and for both PEAs and HPAMAMs it was found that branched polymers can be formed by working with a molar ratio $A_2:B_4$ which is higher than 1:1 ($A:B (>2):4$). In particular at a molar ratio $A_2:B_4$ of 3:1 highly branched polymers were produced namely (i) for HPAMAMs, a polymer (HPAMAM 1.7, Chapter 4) with M_n 620 g/mol, M_w 10550 g/mol, \bar{D} 17.7 and DB 0.98 was obtained after 24 hours reaction in methanol/water and (ii) for PEAs, a polymer (PEA1-3, Chapter 3) with M_n 620 g/mol, M_w 1150, \bar{D} 1.8 and DB 0.45 was formed after 24 hours of reaction at 60 °C in DMF. Although in both cases a gel-free and branched polymer was obtained after 24 hours, the different solvents used affected the rate of the reaction leading to polymers with significantly different molar masses. Therefore for the synthesis of HPAMAMs, a large stoichiometric excess of A_2 monomer with respect to B_4 monomer was used as first strategy to produce hyperbranched polymers and the polymerisation can be stopped at 24 hours by precipitation. The resulting purified polymer did not show the presence of a gel fraction and had M_n 3250 g/mol, M_w 19500 g/mol, \bar{D} 6.0 and DB 0.98. Moreover, from the study of the reaction conditions of the $A_2 + B_4$ polyaddition, it was found that other reaction parameters such as monomer solution concentration, temperature and time of the reaction predominantly affected the rate of the reaction.
2. A novel strategy based on the $A_2 + A + B_4$ system was successfully developed with the aim of stopping gelation where gelation had been shown to be a problem (e.g. $A_2 + B_4$) and promote the synthesis of gel-free hyperbranched polymers. For the synthesis of HPAMAMs ($A_2 = \text{MBA}$; $A = \text{MPAMA}$; $B_4 = \text{EDA}$) it was reported in Chapter 5, that the use of a mono-functional co-monomer is an effective way to inhibit gelation. In particular, the polymerisation of a molar ratio of $2.5A_2-1B_4$, which had a tendency to

gel, could be modified to prevent gelation by the addition of at least 1.2 mole equivalents of A. In this case exclusively soluble HPAMAM products were produced (HPAMAM 1.A4 - 1.A7). Moreover, it was found that by varying the amount of mono-functional A-monomer used, it is possible to tune the molecular weight of the final polymer since such co-monomers act as an end-capper in the reaction. For synthesis of PEAs (Chapter 3) the $A_2 + A + B_4$ system ($A_2 = \text{PEGDA}$; $A = \text{MA}$; $B_4 = \text{EDA}$) was instead studied at a molar ratio $A_2:A:B_4$ of 1.5:1:1 (product labelled as PEA2-1.5MA) and at such molar ratio gelation was significantly delayed (but not avoided) compared to the analogous reaction without A monomer. However, on the basis of the results found for HPAMAMs, a higher amount of A-monomer has to be used in order to inhibit gelation. The simplicity of the $A_2 + A + B_4$ strategy proposed is an important advantage in view of industrial scale up and implementation.

3. The chemical structure of HPAMAMs was successfully modified by using different approaches:
 - a. Taking the advantage of the use of monomer pairs ($A_2 + B_4$) for the synthesis of hyperbranched polymers, different B_4 monomers bearing the same number and type of reactive functional groups (primary amine) but different spacer units were used (Chapter 4). In particular, MBA was used as A_2 -monomer while EDA (HPAMAM 1), EOBEA (HPAMAM 2) and PriamineTM (HPAMAM 3) were all employed as B_4 monomers. The successful synthesis of a series of polymers with different chemical structures was confirmed by NMR spectroscopy and supports the effectiveness of this facile approach.
 - b. The $A_2 + A + B_4$ system mentioned above (point 2) was designed not only as a strategy to avoid gelation during polymerisation but also to functionalise polymers in a one-pot reaction (Chapter 5). For the synthesis and functionalization of HPAMAM, a mono-functional monomer was chosen (i) with the same reactive A functional group as the A_2 monomer ($A_2 = \text{MBA}$; $A = \text{MPAM}$; $B_4 = \text{EDA}$) and (ii) with a different functional group with respect to both A and B functional groups to give an $A_2 + C + B_4$ system ($A_2 = \text{MBA}$; $C = \text{PIBSA}$; $B_4 = \text{EDA}$). In both cases, NMR spectroscopy provided evidence of the success of the polymer functionalisation, with polymers decorated with methoxy groups from MPAM monomer in HPAMAM 1-A and the hydrophobic PIB functional group in HPAMAM 1-C. In addition, the reaction

- of MPAM with EDA (point (i)) was also investigated by SEC analysis which confirmed the ability to tune the molecular weight as a function of the amount of mono-functional co-monomer used. SEC analysis did not provide similar evidence for the reaction with PIBSA, most probably due to the interaction of the polymer with the column. Additional experiments are needed in this last case.
- c. The $A_2 + B_4 \cdot HCl$ system was demonstrated as a novel method for the synthesis of the hydrochloride salt of hyperbranched poly(ester amine) (PEA-5) in Chapter 3 and poly(amido amine) (HPAMAM 4) in Chapter 5, by double-monomer methodology. Cationically charged HPAMAMs were also produced by post-polymerisation quaternization/methylation of the amine groups in the preformed HPAMAM 5 polymer synthesised from A_2 (MBA) and B_4 (EDA) monomers.
4. The PEAs prepared in this work (Chapter 3) showed poor stability in protic solvents and evidence of transesterification in/with methanol was observed by SEC analysis and NMR spectroscopy. It was also proved that such decomposition reactions were catalysed by the amine groups present within the structure of the polymer. The stability of such polymers was subsequently enhanced by protonating and catalytically deactivating the amine groups within the polymer (PEA-5, Chapter 3). In this case the $A_2 + B_4 \cdot HCl$ ($A_2 = PEGDA$ and $B_4 \cdot HCl = HDDC$) system was studied to synthesis, in one-pot reaction, cationic hyperbranched polymers. The cationically-charged, hyperbranched polymer showed enhanced stability to degradation in methanol, however partial decomposition was still observed due to incomplete retention of the hydrogen chloride within the structure. In contrast, the synthesised HPAMAMs (Chapter 4 and 5) showed a relatively good stability to degradation in water, both in dilute and in concentrated solutions, due to the replacement of ester groups with amide groups. However, in concentrated solution (e.g. 18 % w/v) HPAMAMs underwent chain coupling and gelation occurred within a week. The stability of HPAMAMs towards chain-coupling was enhanced by synthesising the end-capped HPAMAM 1-A polymers via the $A_2 + A + B_4$ strategy.
 5. With a view to explore potential industrial applications, the properties of the hyperbranched poly(amido amine)s synthesised from monomers pairs MBA-EDA (HPAMAM 1) and MBA-PriamineTM (HPAMAM 3) were reported in Chapter 6. The

results suggested that HPAMAM 1 is not an effective surfactant due to its hydrophilic nature but the same polymer did show some promising properties as co-surfactant/anti-drifting agent for spray formulations and binder for seed-coating. HPAMAM 3 in contrast, bearing both a hydrophilic and hydrophobic moiety, has the potential to act as surfactant and the adsorption of the polymer to the water-toluene interface was explored by measuring the dynamic interfacial tension. HPAMAM 3 also showed potential as candidate demulsifier and asphaltene dispersant in crude oil. Moreover, this polymer was studied for lubricant applications. In this case, a reduction in the coefficient of friction was observed in the mixed regime at 150°C showing a potential utility as friction modifier at high temperature. Both for HPAMAM 1 and HPAMAM 3 additional analysis is needed to confirm these properties. The results obtained in this work open the prospect of a new class of hyperbranched polymers, synthesised via $A_2 + B_4$ strategy, with potential commercial applications and encourage further studies towards the modification of such polymers to further enhance their properties as surfactants.

7.2 Future work

In the current work, the synthesis of PEAs, using the $A_2 + A + B_4$ system, with a monomer molar ratio $A_2:A:B_4$ of 1.5:1:1 allowed gelation to be postponed but not avoided. The same approach was further investigated for the synthesis of HPAMAMs and it was shown that the $A_2 + A + B_4$ system can effectively inhibit gelation and generate a branched and fully soluble polymer when a molar ratio $A_2:A:B_4$ of $2.5:\geq 1.2:1$ was used. In the light of these results, such molar ratios can also be used for the synthesis PEAs in one-pot reaction. For PEAs the effect of the DMF solvent on the rate of the reaction has to be investigated.

For the $A_2 + A + B_4$ system, the use of an A-monomer in the polyaddition did not permit the identification of the structural units of the resulting polymer and therefore the degree of branching (DB) was calculated with some inaccuracy by including in the calculation the pseudo-branched units (end-capped linear units) and pseudo linear units (end-capped terminal units) together with the branched and linear units of the polymer. In order to accurately calculate the real DB of the polymer and quantify the end-capped units, the use of a ^{13}C -labelled A-monomer can be proposed. For instance, for the synthesis of PEAs, the methyl acrylate (MA) used as the A-monomer could be replaced with methyl acrylate-1- ^{13}C , that is the MA monomer with a carbonyl ^{13}C .

The $A_2 + C + B_4$ system where $A_2 = \text{MBA}$, $C = \text{Glissopal}^{\text{TM}}$ and $B_4 = \text{EDA}$ is a valid method for the synthesis of hyperbranched polymers with a hydrophilic and hydrophobic part. The results reported in Chapter 5 require further confirmation by repeating the experiments that led to the synthesis of the HPAMAM 1.C type of polymers. An in-depth study of the reaction could be carried out by replacing the $\text{Glissopal}^{\text{TM}}$ monomer with succinic anhydride (SA), the reactive functional group in $\text{Glissopal}^{\text{TM}}$. In the reaction of MBA and EDA with SA, the use of low molecular weight monomers may ease the assignment of the relevant peaks by NMR spectroscopy and the detection of the growth of the polymer by SEC analysis.

Future work could also involve the synthesis of a library of HPAMAMs polymers based on an $A_2 + A + B_4$ system ($A = \text{acrylamide groups}$ and $B = \text{N-H groups}$). By using an A_2 and/or a B_4 monomers with different spacers between the reactive functional groups, it should be possible to modify the backbone of hyperbranched polymers and tune their properties. Alternatively, by keeping unchanged the A_2 and B_4 monomers, a variety of commercially available A-monomers can be used to decorate the polymer with a variety of functional side groups.

In Chapter 6 it has been reported that HPAMAM 1 is not a very effective surfactant due to the highly hydrophilic nature of the product. In order to improve the surfactancy of such polymers, a hydrophobic part has to be introduced in the structure. Such a modification can be achieved using the $A_2 + B_4$ system in which one of the two monomers carries a hydrophobic side chain (e.g. aliphatic side chain) or by using the $A_2 + A + B_4$ system with a hydrophobic A monomer.

For the synthesis of HPAMAMs prepared by aza-Michael addition, the $A_2 + B' + B_4$ system could also be investigated and compared to the $A_2 + A + B_4$ system. An example of such system could exploit the mixture of MBA, diethylamine (DEA) and EDA as A_2 , B' and B_4 monomers respectively. The B' monomer should react with the A_2 monomer and form the A-ab intermediate presenting an end-capping agent towards the B_4 monomer. The molar ratio would need to be specifically investigated in this case, in order to produce a hyperbranched and end-capped/functionalised polymer.

The $A_2 + B' + B_4$ system can be further modified for instance to include (i) the $A_2 + B' + B_4 \cdot \text{HCl}$ system (e.g. where $A_2 = \text{MBA}$, $B' = \text{DEA}$, $B_4 \cdot \text{HCl} = \text{HDDC}$, Figure 7.1) conceived from the combination of the $A_2 + B' + B_4$ and the $A_2 + B_4 \cdot \text{HCl}$ systems or (ii) the $A_2 + (B_4 + B_4 \cdot \text{HCl})$ system (e.g. $3 A_2 + 1 (B_4 + B_4 \cdot \text{HCl})$). It is worth remembering that in the $A_2 + B_4 \cdot \text{HCl}$ system, the $B_4 \cdot \text{HCl}$ was activated by using an extra compound. In the proposed systems (i)

and (ii) mentioned above, the B' or B₄ monomer should activate the B₄·HCl and at the same time be incorporated within the polymer structure. In this way additional purification steps could be avoided and in addition a variety of cationic polymers decorated with specific functional groups could be synthesised.

Cationic hyperbranched poly(aminoethyl acrylate) (PAEA) has been recently synthesised by Chen *et al.* from an AB₂ macromonomer (alkynyl-(P(Boc-AEA)₁₀-N₃)₂). A subsequent click reaction of the macromonomer and deprotection of P(Boc-AEA) in trifluoroacetic acid resulted in a hyperbranched PAEA¹. This polymer showed excellent antibacterial activity and low hemolytic toxicity. On the base of these results, the properties of HPAMAMs synthesised in this work can be investigated for application as antimicrobial polymers.

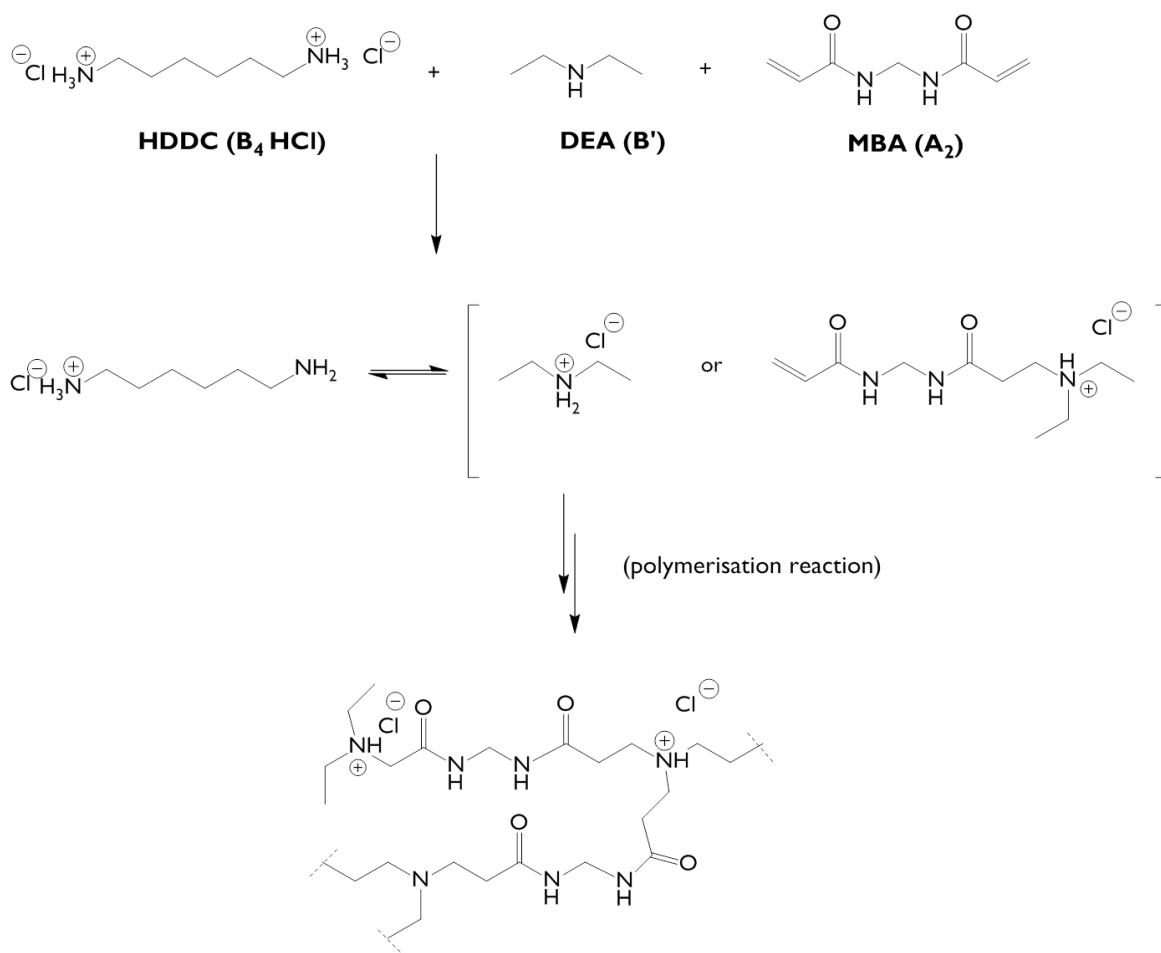

Scheme 7.1 Plausible scheme of the reaction between MBA, HDDC and DEA for the synthesis of cationic and end-capped/functionalised hyperbranched polymers by one pot-polymerisation.

Reference

- ¹ Chen, S. Q., Xu, L., He, C., Li, P. Y., Lu, X. X., Li, J. M., Li, H. J., He, W. D., Yang, L. *J Poly Sci Part A*, **2016**, *54*, 3462-3469.

Appendix A
PEA1-type polymers -
SEC Data from light scattering
and viscometer detectors

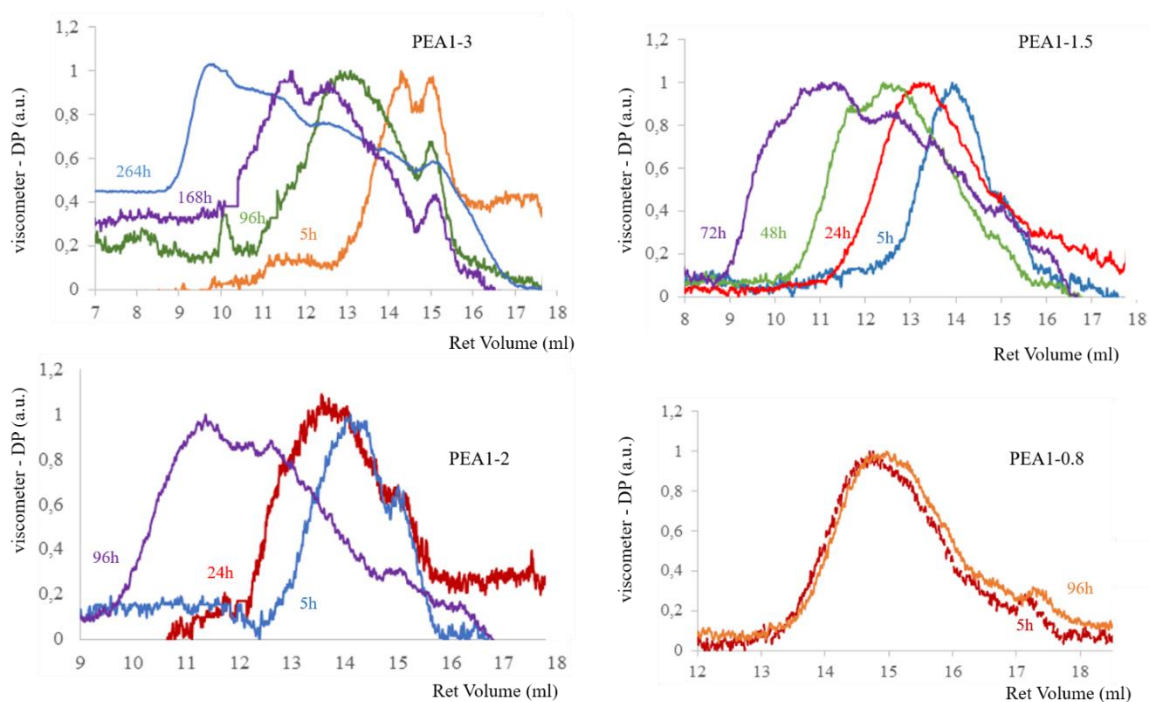

Figure A.1 Viscometer detection (DMF+0.1%LiBr) at different times for the samples PEA1-3, PEA1-2, PEA1-1.5, PEA-0.8 analysed from the reaction mixture without purification.

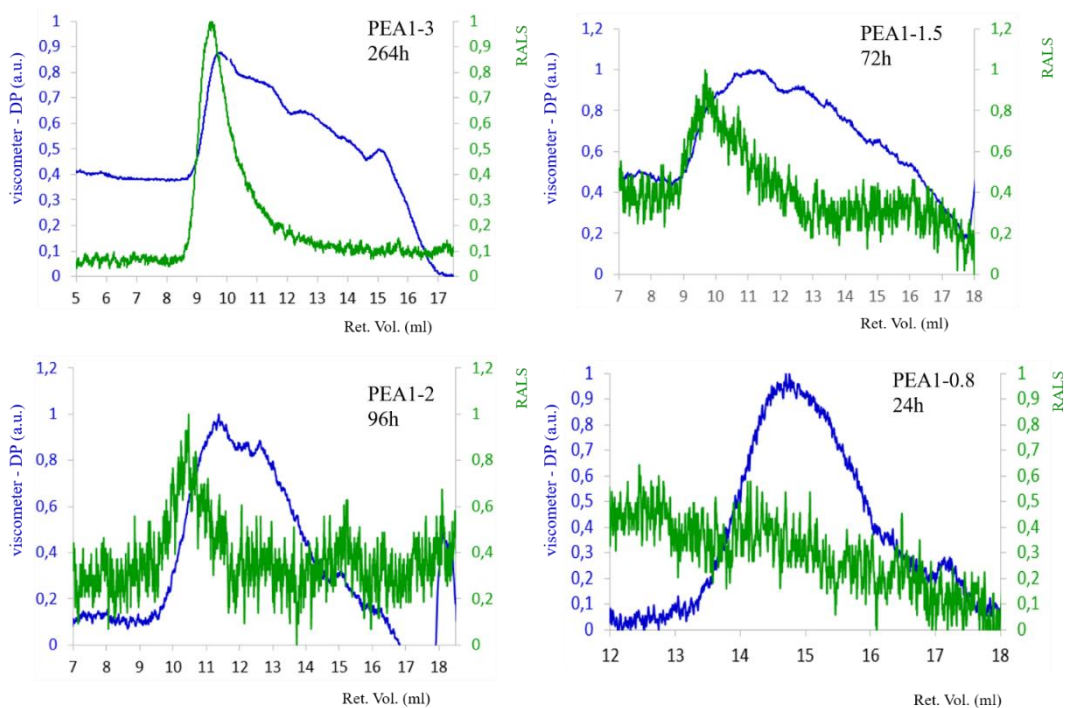

Figure A.2 Overlaid multi-detector chromatogram (DP and RALS detectors, DMF+0.1%LiBr) for the samples PEA1-3, PEA1-2, PEA1-1.5, PEA1-0.8 extracted before gelation from the polymerisation reaction carried out in DMF (18% w/v) at 60°C.

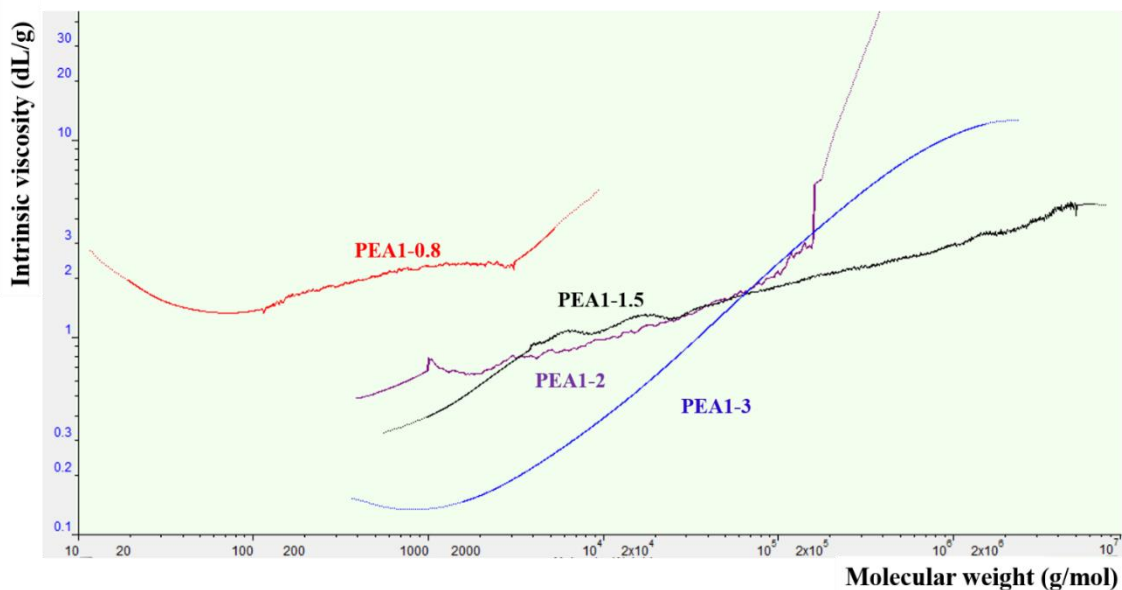

Figure A.3 Overlaid Mark-Houwink plots for different samples PEA1-3, PEA1-2, PEA-1.5, PEA-0.8 extracted before gelation from the polymerisation reaction carried out in DMF (18% w/v) at 60°C

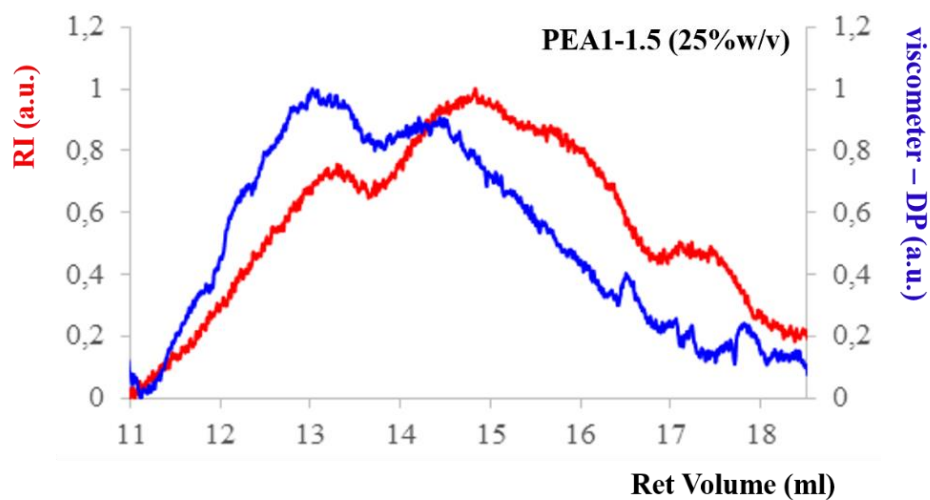

Figure A.4 Overlaid multi-detector chromatogram (RI and DP detectors, DMF+0.1%LiBr) for the sample PEA-1.5 after 24h extracted without purification from the polymerisation mixture in DMF (25% w/v) at 60°C-

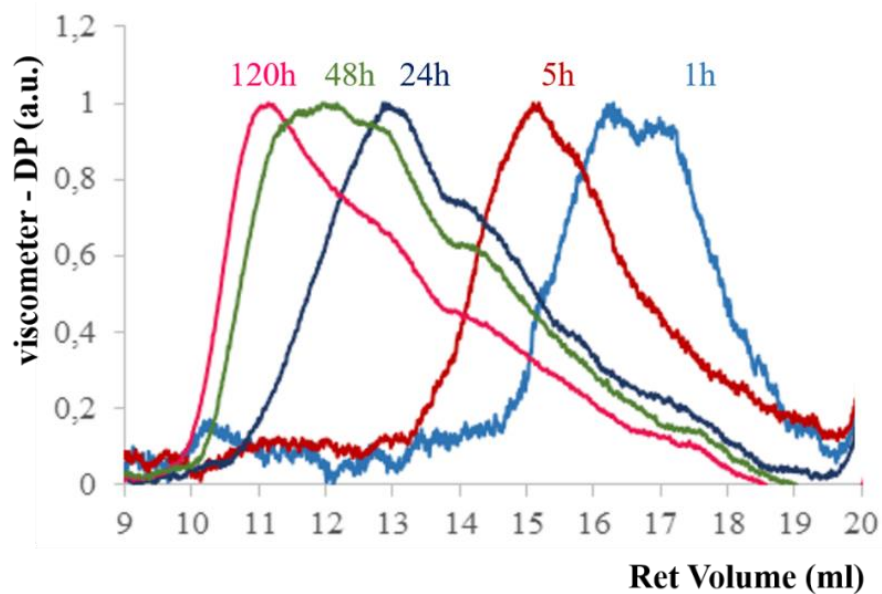

Figure A.5 DP chromatograms (DMF+0.1%LiBr) for the sample PEA2 (poly(PEGDA-EDA, polymerisation carried out in DMF (18% w/v) at 60°C with a molar ratio PEGDA:EDA of 1.5:1).

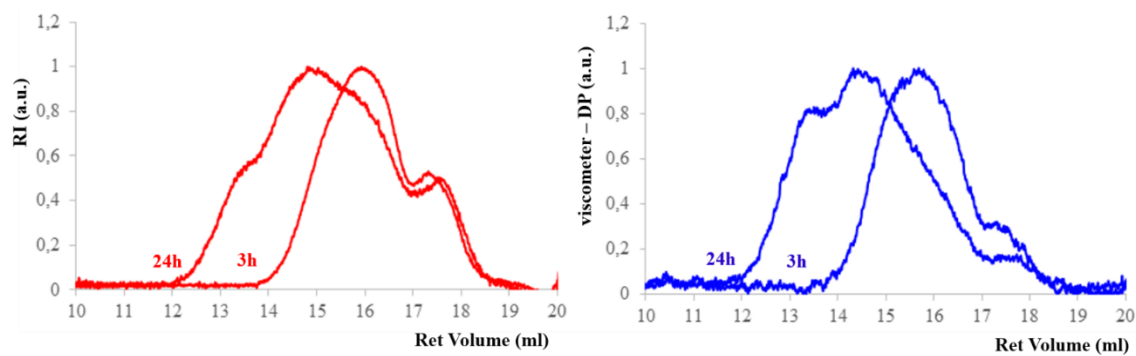

Figure A.6 DP (blue traces) and RI chromatograms (red traces) (DMF+0.1%LiBr) after 3h and 24h of polymerisation reaction for the sample PEA3 (1.5PEGDA-1MMA-1HDA) synthesised in DMF (25% w/v) at 60°C.

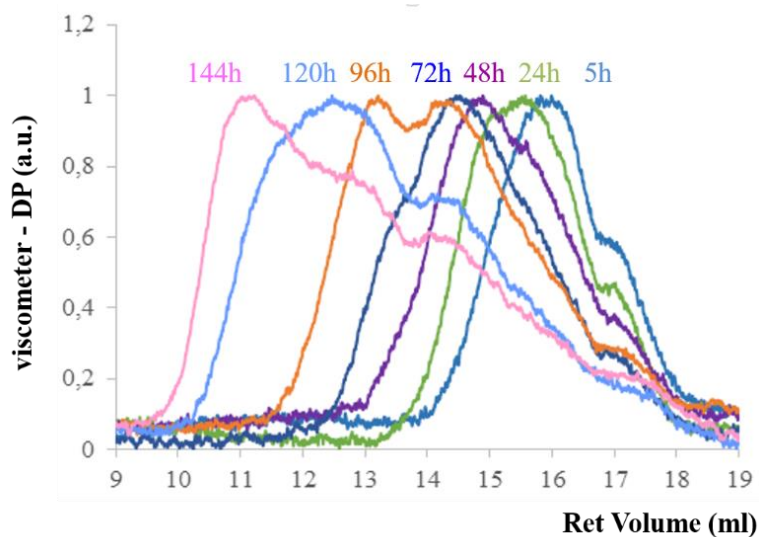

Figure A.7 DP chromatograms (DMF+0.1%LiBr) for the sample PEA4 (poly(PEGDA-MA-HDA)), polymerisation carried out in DMF at 25% w/v with a molar ratio PEGDA-MA-HDA of 1.5:1:1 at 60°C.

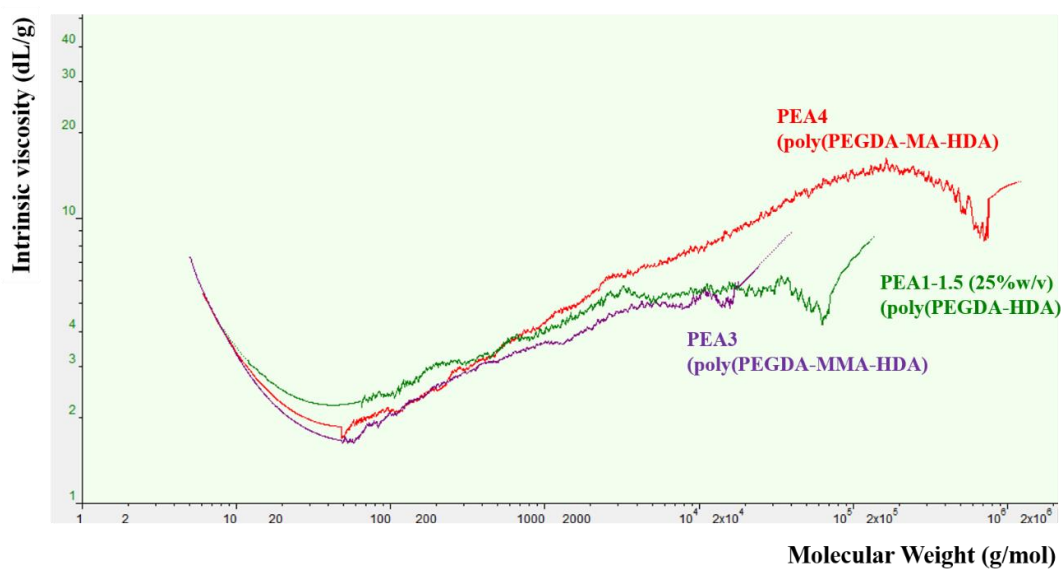

Figure A.8 Overlaid Mark-Houwink plots for different samples PEA1-3, PEA1-2, PEA-1.5, PEA-0.8 extracted before gelation from the polymerisation reaction carried out in DMF (18% w/v) at 60°C.

Appendix B
HPAMAM-type polymers –
SEC Data from light scattering
and viscometer detectors

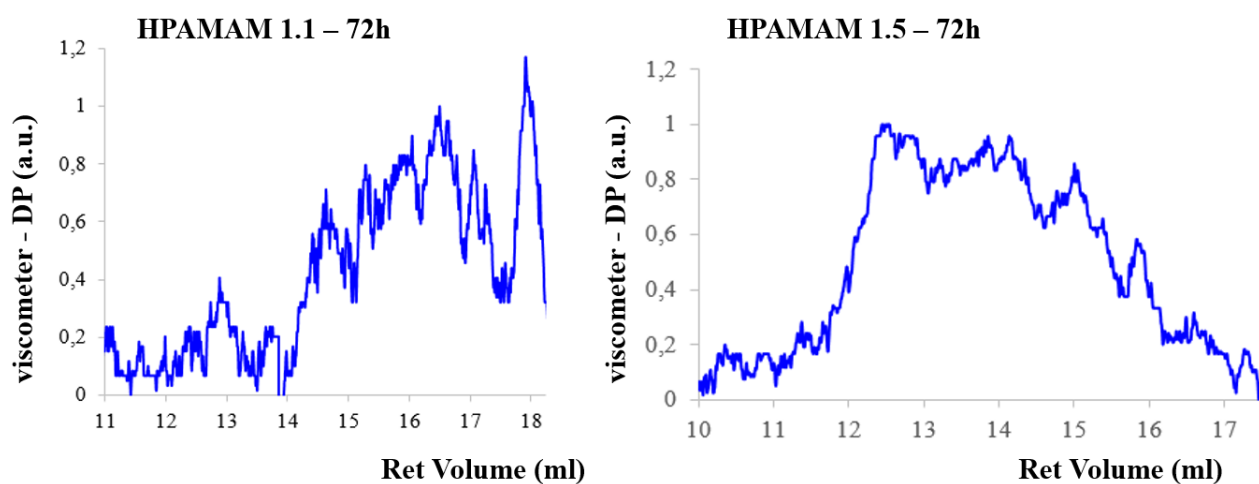

Figure B.1 Viscometer detection for the samples HPAMAM 1.1 and HPAMAM 1.5 after 72h of polymerisation in DMF (methanol/water 70/30 v/v, 18%w/v) at RT.

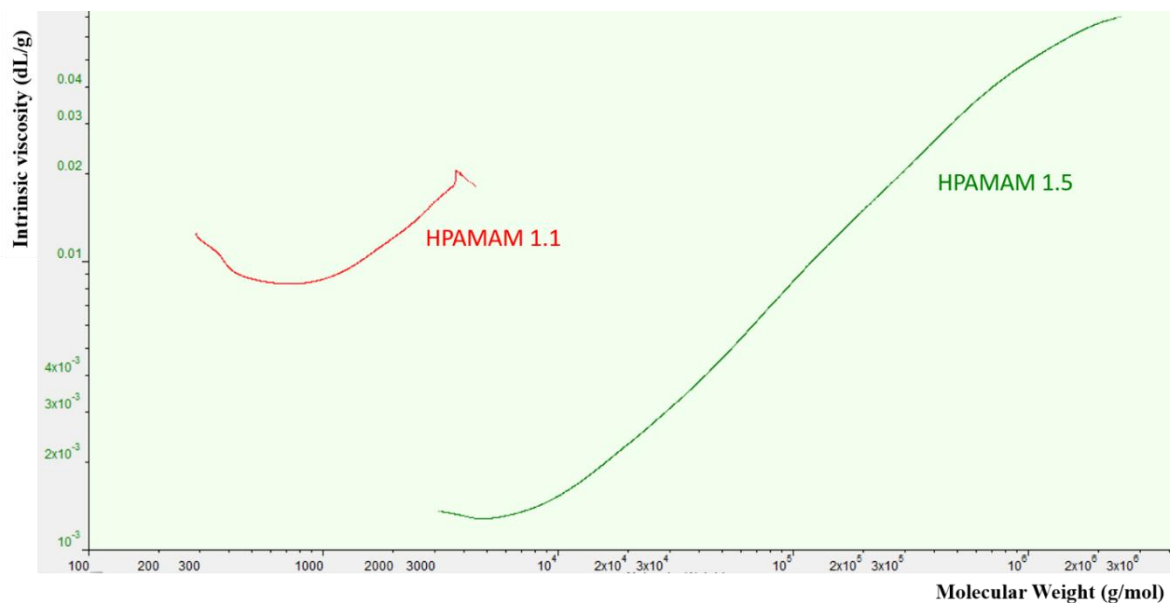

Figure B.2 Overlaid Mark-Houwink plots for different samples HPAMAM 1.1 and HPAMAM 1.5.

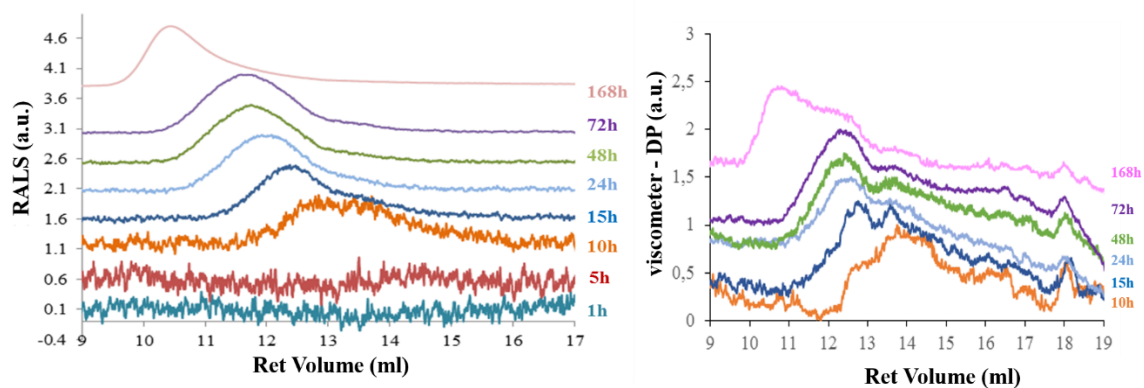

Figure B.3 RALS and DP chromatograms for the sample HPAMAM 1.8 (poly(3MBA-1EDA)) analysed at different times from the polymerisation reaction carried out in methanol/water (18% w/v) at 40°C.

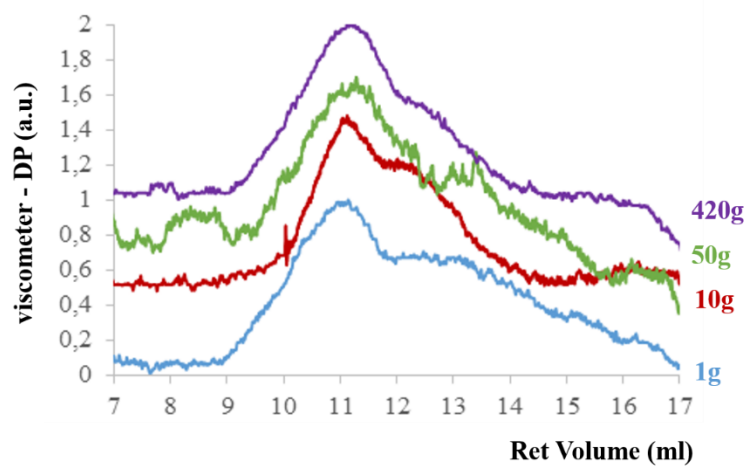

Figure B.4 Viscometer detection for the samples HPAMAM 1.7 synthesised by using 1g, 10g, 50g and 420g of starting monomers

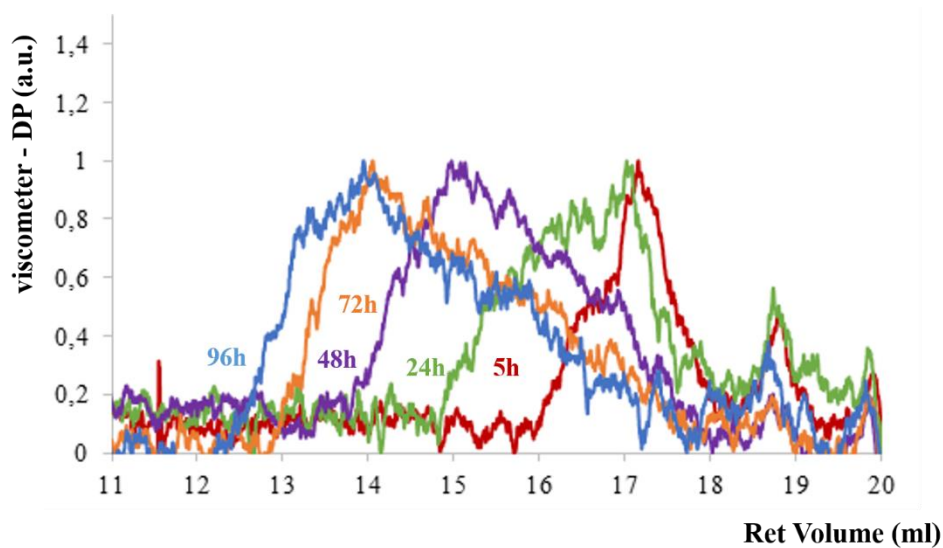

Figure B.5 Viscometer detection for the sample HPAMAM 3.2 product of the polyaddition 3MBA+1Priamine™ (T=60°C in methanol/THF at 10% w/v).

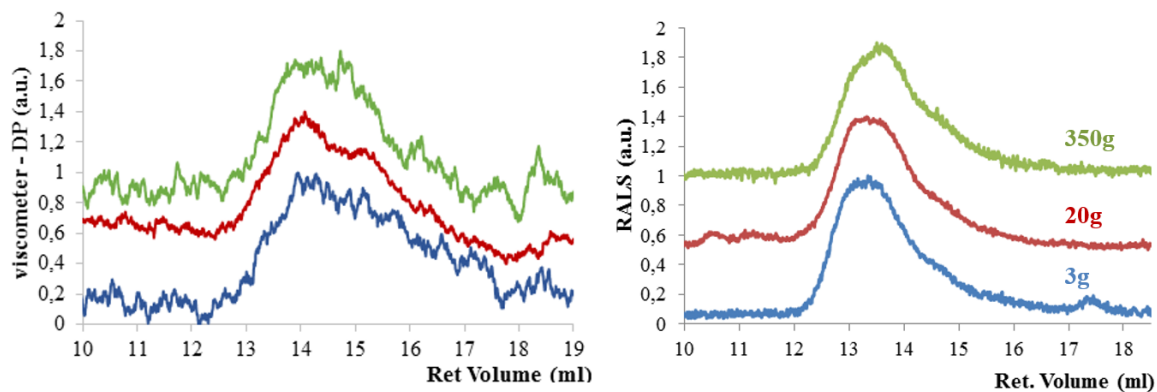

Figure B.6 RALS and DP chromatograms for the sample HPAMAM 1.8 of the product 3MBA-1Priamine™ obtained from the polyaddition in methanol/THF at 60°C by using 3 g (blue trace), 20g (red trace) and 350 g (green trace) of starting monomers.

Appendix C

**SEC Data from light scattering
and viscometer detectors of the
HPAMAM-1.A type polymers**

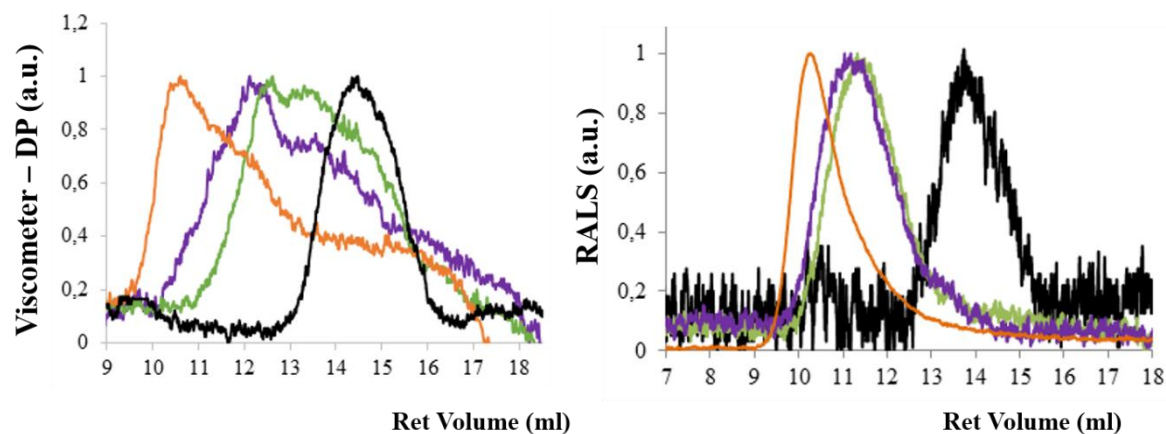

Figure C.1 RALS and DP chromatograms for the sample HPAMAM 1.A2, HPAMAM 1.A4, HPAMAM 1.A5, HPAMAM 1.A2 (2.5MBA-1EDA-xMPAM (with $x=1.0, 1.2, 1.3$ and 2.5 mole)) recovered after 3 days by precipitation.

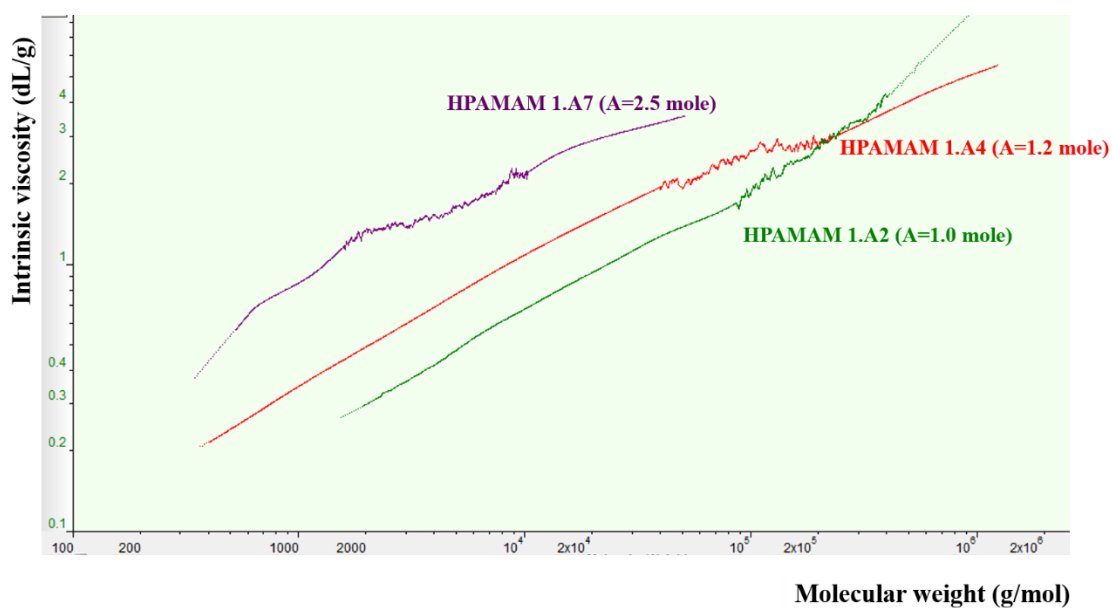

Figure C.2 Overlaid Mark-Houwink plots for different samples HPAMAM 1.A2, HPAMAM 1.A4 and HPAMAM 1.A7.