

## Durham E-Theses

---

### *On the combinatorics of quivers, mutations and cluster algebra exchange graphs*

JOHN WILLIAM LAWSON

#### How to cite:

---

LAWSON, JOHN WILLIAM (2017) On the combinatorics of quivers, mutations and cluster algebra exchange graphs. Doctoral thesis, Durham University.

#### Use policy

---

The full-text may be used and/or reproduced, and given to third parties in any format or medium, without prior permission or charge, for personal research or study, educational, or not-for-profit purposes provided that:

- a full bibliographic reference is made to the original source
- a <https://etheses.durham.ac.uk/id/eprint/12095/> is made to the metadata record in Durham E-Theses
- the full-text is not changed in any way

The full-text must not be sold in any format or medium without the formal permission of the copyright holders.

Please consult the [full Durham E-Theses policy](#) for further details.

**On the combinatorics of quivers,  
mutations and cluster algebra  
exchange graphs**

John William Lawson

A Thesis presented for the degree of  
Doctor of Philosophy



Department of Mathematical Sciences  
Durham University  
United Kingdom

April 2017



# On the combinatorics of quivers, mutations and cluster algebra exchange graphs

John William Lawson

Submitted for the degree of Doctor of Philosophy

April 2017

**Abstract:** Over the last 20 years, cluster algebras have been widely studied, with numerous links to different areas of mathematics and physics. These algebras have a cluster structure given by successively mutating seeds, which can be thought of as living on some graph or tree. In this way one can use various combinatorial tools to discover more about these cluster structures and the cluster algebras themselves. This thesis considers some of the combinatorics at play here.

Mutation-finite quivers have been classified, with links to triangulations of surfaces and semi-simple Lie algebras, while comparatively little is known about mutation-infinite quivers. We introduce a classification of the minimal types of these mutation-infinite quivers before studying their properties. We show that these minimal mutation-infinite quivers admit a maximal green sequence and that the cluster algebras which they generate are equal to their related upper cluster algebras.

Automorphisms of skew-symmetric cluster algebras are known to be linked to automorphisms of their exchange graphs. In the final chapter we discuss how this idea can be extended to skew-symmetrizable cluster algebras by using the symmetrizing weights to add markings to the exchange graphs. This opens possible opportunities to study orbifold mapping class groups using combinatoric graph theory.

# Declaration

The work in this thesis is based on research carried out in the Department of Mathematical Sciences at Durham University. No part of this thesis has been submitted elsewhere for any degree or qualification.

The work in Chapter 4 is based on joint research with Matthew Mills, University of Nebraska-Lincoln.

This thesis contains work published elsewhere by the author:

- Chapter 3 appears in *Experimental Mathematics*, [Law17].
- Chapter 5 appears in *The Electronic Journal of Combinatorics*, [Law16].

**Copyright © 2017 John William Lawson.**

“The copyright of this thesis rests with the author. No quotation from it should be published without the author’s prior written consent and information derived from it should be acknowledged.”

# Acknowledgements

I would like to thank my supervisors Pavel Tumarkin and John Parker for their continued support, encouragement and patience, as well as all those who provided assistance throughout my PhD, both in Durham and at conferences, and those with whom I collaborated. I would also like to thank my examiners Anna Felikson, Norbert Peyerimhoff and Pierre-Guy Plamondon for an enjoyable viva and their constructive feedback.

The Durham maths department has been a fantastic place to work, almost entirely due to the wonderful people who work there. A huge debt of gratitude is owed to Jane, Fiona, Gemma, Helene and all the other diligent office staff.

Similarly the department would not be the same without the many PhD students. Thanks to all those who I have shared time or an office with, including but not limited to Sam, Will, Dan, Jonny, Steven, Paul, David, Alex, Andy, Richard, Alastair, Stephan and Irene.

Finally I would like to thank those outside the maths department who made my time in Durham so enjoyable, especially Miriam, Tim, Danya, Andrew, Abi, Eleonore and the Hatfield MCR, and David, Mick, Greg, Davie, Curly, Peter and all the rest of the underwater hockey team.

This work was supported by an Engineering and Physical Sciences Research Council PhD scholarship [grant number EP/L504762/1].



*We observe a fragment of the process, the trembling of a single string in a symphonic orchestra of supergiants, and on top of that we know — we only know, without comprehending — that at the same time, above us and beneath us, in the plunging deep, beyond the limits of sight and imagination there are multiple, millionfold simultaneous transformations connected to one another like the notes of musical counterpoint.*

— from *Solaris* by Stanislaw Lem



# Contents

<b>Abstract</b>	<b>iii</b>
<b>List of Figures</b>	<b>xiii</b>
<b>List of Tables</b>	<b>xvii</b>
<b>1 Introduction</b>	<b>1</b>
<b>2 Cluster algebras</b>	<b>5</b>
2.1 Quivers and mutation . . . . .	6
2.1.1 Generalising quivers . . . . .	8
2.1.2 The global mutation group . . . . .	11
2.2 Variables, clusters and seeds . . . . .	13
2.3 Exchange graphs . . . . .	16
2.4 Reflections and Dynkin diagrams . . . . .	17
2.4.1 Finite type cluster algebra classification . . . . .	19
2.5 Surface cluster algebras . . . . .	21
2.5.1 Cluster structures from triangulations . . . . .	22
2.5.2 Adding taggings . . . . .	23
2.5.3 Extending to orbifolds . . . . .	25
2.5.4 Mutation-finite classification . . . . .	28
<b>3 Minimal mutation-infinite quivers</b>	<b>31</b>
3.1 Introduction . . . . .	31

3.2	Minimal mutation-infinite quivers . . . . .	33
3.2.1	Partial ordering on quivers . . . . .	33
3.2.2	Properties of minimal mutation-infinite quivers . . . . .	34
3.3	Coxeter simplices . . . . .	36
3.3.1	Simply-laced Coxeter simplex diagrams in different spaces . . . . .	37
3.3.2	A family of minimal mutation-infinite quivers . . . . .	38
3.4	Minimal mutation-infinite quiver moves . . . . .	41
3.4.1	A move example . . . . .	41
3.5	Classifying minimal mutation-infinite quivers . . . . .	47
3.5.1	A deterministic mutation-infinite check . . . . .	48
<b>4</b>	<b>Properties of minimal mutation-infinite quivers</b>	<b>49</b>
4.1	Introduction . . . . .	50
4.2	Cluster Algebras and Upper Cluster Algebras . . . . .	52
4.2.1	Locally acyclic cluster algebras and the Louise property . . . . .	54
4.3	Maximal green sequences . . . . .	55
4.3.1	Existence of maximal green sequences . . . . .	56
4.3.2	Direct sums of quivers . . . . .	58
4.3.3	Quivers ending with k-cycles . . . . .	59
4.4	On the mutation class of minimal mutation-infinite quivers . . . . .	61
4.4.1	Hyperbolic Coxeter simplex representatives . . . . .	61
4.4.2	Admissible quasi-Cartan companion matrices . . . . .	62
4.4.3	Double arrow minimal mutation-infinite quivers . . . . .	65
4.4.4	Exceptional minimal mutation-infinite quivers . . . . .	68
4.5	Maximal green sequences for minimal mutation-infinite quivers . . . . .	69
4.5.1	Rank 3 quivers . . . . .	72
4.5.2	Higher rank quivers . . . . .	72
4.6	$A=U$ for minimal mutation-infinite quivers . . . . .	74
4.7	Quivers in the mutation class with maximal green sequences . . . . .	76
4.8	Other questions and conjectures . . . . .	84

---

<b>5</b>	<b>Cluster automorphisms and marked exchange graphs</b>	<b>87</b>
5.1	Introduction . . . . .	87
5.2	Mutations . . . . .	90
5.3	Exchange graphs . . . . .	92
5.4	Cluster automorphisms . . . . .	100
5.5	Generalising automorphisms to the skew-symmetrizable case . . .	103
5.5.1	Marked exchange graph . . . . .	104
5.5.2	Geodesic loops . . . . .	107
5.5.3	Exchange graph automorphism effects on diagrams and matrices	110
5.6	Unfoldings . . . . .	115
5.7	Mapping class groups . . . . .	120
5.7.1	Unfoldings and covering maps . . . . .	122
<b>A</b>	<b>Minimal mutation-infinite quiver supplementary material</b>	<b>125</b>
A.1	Computing minimal mutation-infinite quivers . . . . .	125
A.1.1	Finding the size of a mutation-class . . . . .	125
A.1.2	Computing quivers . . . . .	129
A.1.3	Checking number of moves . . . . .	130
A.2	List of moves . . . . .	131
A.2.1	Moves for quivers of size 5 . . . . .	131
A.2.2	Additional moves for quivers of size 6 . . . . .	131
A.2.3	Additional moves for quivers of size 7 . . . . .	131
A.2.4	Additional moves for quivers of size 8 . . . . .	132
A.2.5	Additional moves for quivers of size 9 . . . . .	132
A.2.6	Additional moves for quivers of size 10 . . . . .	133
<b>B</b>	<b>Properties of MMI quivers supplementary material</b>	<b>137</b>
B.1	Tables of move-class invariants . . . . .	137
	<b>Bibliography</b>	<b>141</b>



# List of Figures

2.1	Example of a loop and 2-cycle. . . . .	6
2.2	Example of quiver mutation. . . . .	7
2.3	Constructing a skew-symmetric matrix from a quiver. . . . .	8
2.4	Constructing a diagram from a skew-symmetrizable matrix. . . . .	9
2.5	A diagram without any skew-symmetrizable matrix. . . . .	10
2.6	A diagram with multiple skew-symmetrizable matrices. . . . .	10
2.7	Local mutation of a diagram. . . . .	11
2.8	Valued quivers representing a skew-symmetrizable matrix. . . . .	12
2.9	Example of seed mutation . . . . .	14
2.10	A list of all Dynkin diagrams. . . . .	20
2.11	A self-folded triangle. . . . .	22
2.12	Flipping the interior arc of a triangulation. . . . .	22
2.13	Converting a self-folded triangle to tagged arcs. . . . .	24
2.14	Quivers from surface triangulations. . . . .	26
2.15	The exceptional types of mutation-finite quivers. . . . .	29
2.16	The exceptional types of mutation-finite diagrams. . . . .	30
3.1	The partial ordering on some examples of quivers. . . . .	33
3.2	Commutative diagram showing mutations and vertex removal. . . . .	34
3.3	Mutation does not preseve being minimal mutation-infinite. . . . .	35
3.4	Different orientations of the same graph. . . . .	36
3.5	Mutation-finite orientations of Coxeter diagrams. . . . .	39

3.6	Orientations of tree-like Coxeter diagrams. . . . .	39
3.7	Minimal mutation-infinite quivers not from Coxeter diagrams. . . . .	40
3.8	The 5 vertex minimal mutation-infinite quivers. . . . .	40
3.9	An example of a minimal mutation-infinite move. . . . .	42
3.10	Examples of where a move applies. . . . .	42
3.11	The effects of a minimal mutation-infinite move. . . . .	42
3.12	Example of a size 10 move with added constraints . . . . .	44
4.1	The decomposition of a quiver $Q$ ending in a $k$ -cycle. . . . .	59
4.2	Non-acyclic minimal mutation-infinite representatives. . . . .	64
4.3	Quiver without an admissible quasi-Cartan companion. . . . .	65
4.4	Mutation sequences for each double arrow representative. . . . .	67
4.5	Quiver without an admissible quasi-Cartan companion. . . . .	68
4.6	Mutation sequences for the first 5 exceptional representatives. . . . .	70
4.7	The remaining 5 exceptional representatives. . . . .	71
4.8	The quiver $\mathbb{X}_7$ and the other quiver in its mutation class. . . . .	73
4.9	Quivers direct sums or ending in a 3-cycle. . . . .	74
4.10	Acyclic rank 3 quivers with different exchange graphs. . . . .	77
4.11	Subgraphs of the quiver exchange graphs with green sequences. . . . .	78
4.12	Subgraphs of the quiver exchange graphs with green sequences. . . . .	80
4.13	The rank 4 quiver $R_{a,b,c}$ for $b, c \geq 2$ and $a \leq c - 2$ . . . . .	81
4.14	A subgraph of the exchange graph containing $\widehat{\Psi}(Q)$ . . . . .	85
5.1	Example of a permutation acting on a seed. . . . .	91
5.2	Labelled exchange graph for the mutation class of type $A_2$ . . . . .	93
5.3	Exchange graph for the mutation class of type $A_2$ . . . . .	93
5.4	Labelled exchange graph for the mutation class of type $B_2$ . . . . .	94
5.5	Exchange graph for the mutation class of type $B_2$ . . . . .	95
5.6	Commutative diagram of the various maps involved in Example 5.3.6. . . . .	96
5.7	The maximal green sequences of the quiver of type $A_2$ . . . . .	103

---

5.8	Marked exchange graph of type $B_3$ . . . . .	106
5.9	Marked exchange graph for cluster algebra of type $B_2$ . . . . .	107
5.10	Exchange graph of the mutation class of type $A_3$ . . . . .	118
5.11	Triangulation of an orbifold with associated diagram. . . . .	123



# List of Tables

3.1	Representatives: Orientations of hyperbolic Coxeter simplex diagrams	45
3.2	Representatives: Double arrow quivers . . . . .	46
3.3	Representatives: Exceptional quivers . . . . .	46
5.1	Disconnected 3-vertex diagrams. . . . .	112
5.2	Connected skew-symmetric 3-vertex diagrams. . . . .	112
5.3	Connected skew-symmetrizable 3-vertex diagrams. . . . .	113
B.1	Rank 4 and 5 hyperbolic Coxeter simplex move-classes. . . . .	138
B.2	Higher rank hyperbolic Coxeter simplex move-classes. . . . .	138
B.3	Double arrow move-classes. . . . .	139
B.4	Exceptional move-classes. . . . .	139



# Chapter 1

## Introduction

Around 20 years ago, Fomin and Zelevinsky introduced a new framework by which to study dual canonical bases and total positivity in certain semi-simple groups. This framework gives the backbone of what we now call cluster algebras, and their ideas have resonated throughout all manner of mathematics and physics.

The main component in the construction of a cluster algebra is the process of mutation, which gives a way of locally changing a mathematical object to give a new similar object. Different objects in various different mathematical frameworks have been shown to be related by processes similar to mutation, and so the broad topic of cluster algebras has become of interest to many mathematicians.

The simplest object which can be mutated is typically a matrix or a quiver. While these objects themselves may be simple, quivers have been used to encode information about much more complicated objects in different fields. The study of mutations of quivers can then be translated back into this original field, where the cluster algebra structure gives new ways of computing and analysing the original objects.

One such use of quivers in this thesis is to encode the triangulations of surfaces and here mutation between two quivers is the same as flipping an edge in their corresponding triangulations. Surface triangulations and the transformations between them encode information about the surface itself, and this information is in turn en-

coded into the cluster structure. As such, we can use the algebra and combinatorial properties of the arising cluster structure to study the geometry of the underlying surface. Recent work in this direction has given new perspectives on the mapping class groups of surfaces and possibly certain orbifolds, whereby some presentations of these groups can be computed in a combinatorial way.

The cluster structure of a given cluster algebra can be visualised in an exchange graph, which is typically some quotient of an  $n$ -regular tree. These graphs contain information about their algebra, and so provide a purely combinatorial approach to computing certain properties of the algebra. When the algebra arises from other areas of mathematics, then these links provide new and exciting approaches to studying these areas combinatorially which have perhaps not been known before.

A cluster algebra is generated by a number of cluster variables, but the number of these generators is typically infinite, and each has to be constructed individually using mutations. An effort has been made to provide a simpler description of these cluster algebras by providing an upper bound for each algebra. These upper cluster algebras are easier to study and contain the original cluster algebra, but in general it is not known whether the algebras are equal. In some cases, for example acyclic cluster algebras, they have been shown to be equal while for others, like cluster algebras arising from once-punctured closed surfaces, they are not.

One possible link between the two is given by maximal green sequences of the quiver which generates the cluster algebra. For mutation-finite quivers it has been shown that a quiver admits a maximal green sequence if and only if its cluster algebra is equal to its upper cluster algebra. These maximal green sequences are also related to paths within scattering diagrams which cross walls in particular ways, to certain paths in exchange graphs, and to particular reflections of  $c$ -vectors.

Quivers have been used for a long time in the representation theory of algebras, so it is perhaps not surprising that the theory of cluster algebras was quickly translated into the language of representation theory. Cluster categories have been constructed whereby the quivers, clusters and seeds are encoded as sums of objects in the category

and mutation is a well defined operation replacing a single summand of an object with the only other possible object which preserves certain properties. Many of the well known results about cluster algebras have been proved first in the cluster category and translated back into the language of cluster algebras. This thesis will not discuss this categorification, but there is a wealth of literature on the subject and many of the references cited in this thesis use these techniques.

This thesis starts with an introduction to cluster algebras and a detailed background view of their construction in Chapter 2. This includes an overview of the required definitions of quivers, seeds, mutations, cluster algebras and exchange graphs, before providing a glimpse of some particular examples of cluster algebras which have links to reflection groups and to surfaces.

The quivers which generate these surface and reflection group cluster algebras are mutation-finite, that is only a finite number of quivers can be obtained through successive mutations. Such quivers are rare and in general most quivers are mutation-infinite, admitting an infinite number of quivers through continued mutations. A full classification of all mutation-finite quivers includes these surface quivers and only a small number of other exceptional types.

The first main set of results in this thesis relate to minimal mutation-infinite quivers, from which an infinite number of quivers can be constructed through mutations, but where any subquiver only admits finitely many. Chapter 3 introduces the classification of these quivers through a number of moves constructed from sequences of mutations, while Appendix A includes a discussion on the computations used to find them, and a list of all the moves which determine the classification.

Once we know of certain classes of quivers, and in particular have lists of all the quivers appearing in the classes, it is natural to ask which properties they may have. In Chapter 4 we consider whether minimal mutation-infinite quivers admit maximal green sequences and prove that they all do, and also discuss what the quiver exchange graphs of these quivers look like. These quivers generate certain cluster algebras and we show that these cluster algebras are equal to their upper cluster

algebras, strengthening the possible link between maximal green sequences and the equality of the cluster algebra and its upper cluster algebra.

An area which has only fairly recently been studied is that of the possible maps between cluster algebras which preserve their cluster structure. Some progress has been made on these cluster algebra quasi-homomorphisms in recent years and was initiated by the study of automorphisms of cluster algebras. Such an automorphism maps a cluster algebra to itself, while preserving how mutations link the various clusters in the cluster structure.

The cluster automorphisms of certain cluster algebras have been shown to coincide with the graph automorphisms of the algebra's exchange graph. In Chapter 5 we discuss these links as well as other ways of considering cluster automorphisms. The main results in that chapter extend these ideas to skew-symmetrizable cluster algebras, which are typically less well studied. As exchange graph automorphisms can be computed combinatorially from the structure of the graph, these links provide a possible means to find automorphism groups of anything which contains a cluster algebra structure.

# Chapter 2

## Cluster algebras

Fix an **ambient field**  $\mathcal{F} = \mathbb{K}(x_1, \dots, x_n)$  to be the field of rational functions over a field  $\mathbb{K}$  in  $n$  variables. Any element  $f \in \mathcal{F}$  in this field is then of the form

$$f = \frac{P(x_1, \dots, x_n)}{Q(x_1, \dots, x_n)}$$

for some polynomials  $P$  and  $Q$  with coefficients in  $\mathbb{K}$ . Cluster algebras of rank  $n$  are certain subalgebras of this ambient field with an additional cluster structure. The generators of the algebra are computed using the combinatorial procedure of mutation which provides this cluster structure and leads to many applications in different areas of mathematics and physics.

This chapter aims to cover all the basic definitions and ideas behind the study of cluster algebras, as well as some possible generalisations and different view points on the topic. In all of the following  $n$  refers to the rank of the cluster algebra, unless noted otherwise.

We start by defining mutation on quivers in Section 2.1 before adding variables and defining cluster algebras in Section 2.2. In Section 2.3 we define an algebra's exchange graph, before moving on to look at some of the applications of cluster algebras in Section 2.4 and Section 2.5. The links between reflection groups in Section 2.4 leads to the classification of all finite type cluster algebras, while the surface algebras given in Section 2.5 are linked to the mutation-finite classification.

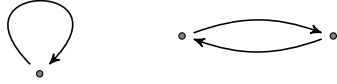

Figure 2.1: Example of a loop (left) and 2-cycle (right), which we assume do not appear in any quiver considered in this thesis.

## 2.1 Quivers and mutation

The study of cluster algebras revolves around the combinatorial cluster structure which has been shown to appear throughout mathematics and physics. The main component of this structure is the idea of mutations, which we first introduce on quivers before generalising to include variables, functions and seeds. Fomin and Zelevinsky first studied mutations of skew-symmetrizable matrices in their first cluster algebra paper [FZ02], and it is well-known that these mutations can be stated equivalently for quivers, as we do here.

**Definition 2.1.1.** A **quiver**  $Q$  is an oriented (multi-)graph with a set of vertices denoted  $Q_0$  and a set of arrows  $Q_1$ . In all the following we assume that a quiver has no loops (arrows starting and ending at the same vertex) and no 2-cycles (a pair of differently oriented arrows between two vertices, as shown in Figure 2.1).

**Definition 2.1.2.** Given a quiver  $Q$  with vertices labelled  $\{1, \dots, n\}$  then **quiver mutation** in the  $k$ -th vertex,  $\mu_k$ , gives a new quiver  $\mu_k(Q) = Q'$  from  $Q$  by the following three step process, as shown in Figure 2.2:

1. For any path  $i \rightarrow k \rightarrow j$  of length 2 with midpoint  $k$ , add an arrow  $i \rightarrow j$ .
2. Reverse all arrows adjacent to  $k$ .
3. Remove a maximal collection of 2-cycles should any be created.

While not immediately obvious from the definition, mutation is an involution so  $\mu_k(\mu_k(Q)) = Q$  for any quiver. We can use mutations to define an equivalence relation, which then gives equivalence classes and a number of mutation properties of quivers.

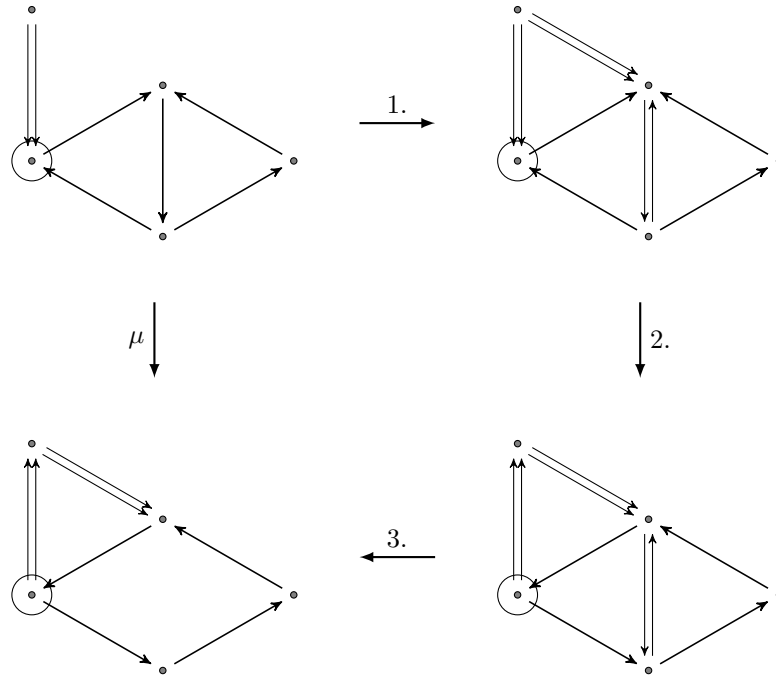

Figure 2.2: Example of quiver mutation at the circled vertex. Each step given in Definition 2.1.2 is shown separately.

**Definition 2.1.3.** Two quivers  $P$  and  $Q$  are **mutation equivalent** if there is a sequence of mutations taking  $P$  to  $Q$ .

**Definition 2.1.4.** The **mutation class**  $\mathcal{S}(Q)$  of a quiver  $Q$  is the equivalence class under this relation.

The mutation class is therefore a collection of quivers which can all be obtained from an initial quiver by successive mutations.

**Definition 2.1.5.** A quiver is **mutation-finite** if its mutation class contains only finitely many quivers, otherwise it is **mutation-infinite**.

A **source** (respectively **sink**) is a vertex of a quiver which is the destination (resp. source) of no arrows. Mutation at a sink or source will only change the orientations of arrows adjacent to the vertex, and will not change the underlying graph.

**Definition 2.1.6.** An **induced subquiver** of a quiver  $Q$  is a subgraph constructed by removing a collection of vertices from  $Q$ .

The restrictions on the definition of a quiver ensure that quivers are in one-to-one correspondence with skew-symmetric matrices (a matrix  $A$  such that  $A^T = -A$ ).

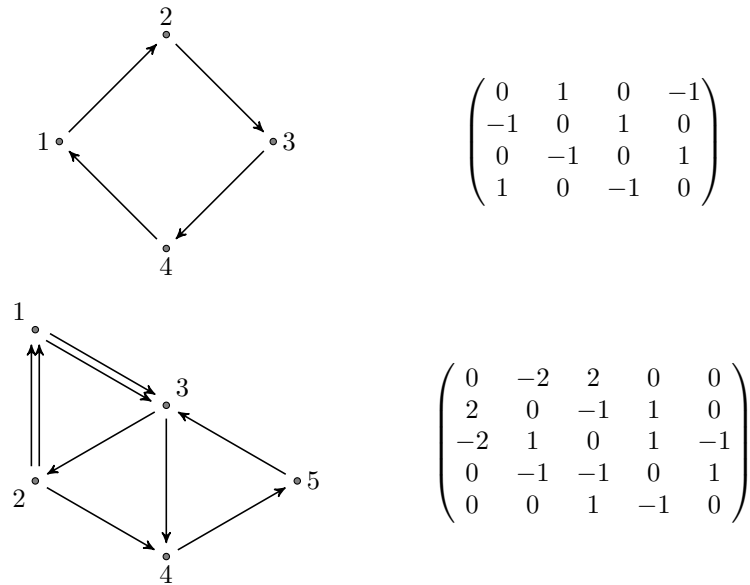

Figure 2.3: Two examples of constructing a skew-symmetric matrix from a given quiver.

Given a quiver  $Q$  with  $n$  vertices labelled  $\{1, \dots, n\}$ , its matrix  $B = (b_{i,j})$  has  $n$  rows and columns, and  $b_{i,j}$  is the number of arrows from the vertex  $i$  to the vertex  $j$  minus the number of arrows from  $j$  to  $i$ , as illustrated in Figure 2.3.

In the case of these matrices, subquivers correspond to principal submatrices, constructed by simultaneously removing rows and columns.

### 2.1.1 Generalising quivers

Although it is easier to visualise cluster algebras in terms of quivers, the correspondence with matrices gives an easier way to compute mutations. It also gives the first way of generalising these ideas by studying skew-symmetrizable matrices as well as skew-symmetric matrices.

**Definition 2.1.7.** A matrix  $B$  is **skew-symmetrizable** if there exists an integer valued, positive diagonal matrix  $D$  such that  $BD$  is skew-symmetric. The diagonal matrix with smallest positive diagonal entries is called the **symmetrizing** matrix of  $B$ .

**Definition 2.1.8.** Given a skew-symmetrizable matrix  $B = (b_{i,j})$  then **matrix**

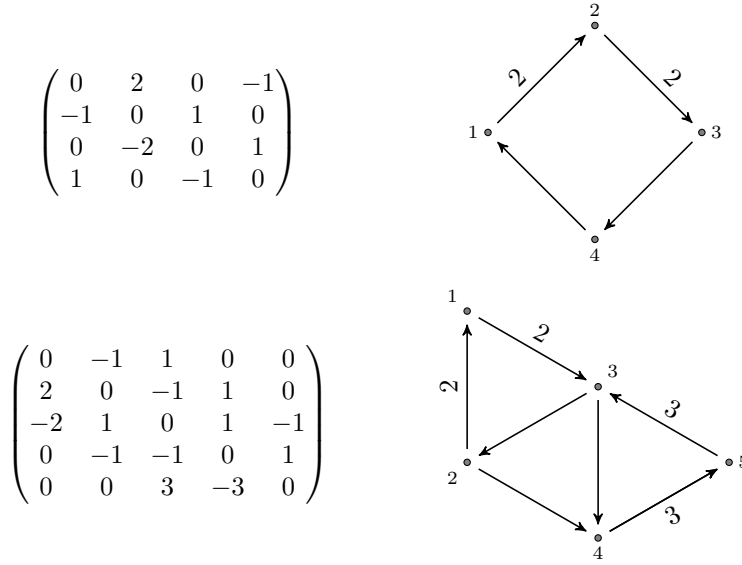

Figure 2.4: Two examples of constructing a diagram from a given skew-symmetrizable matrix.

**mutation** in the  $k$ -th direction gives a new matrix  $B' = (b'_{i,j})$  where

$$b'_{i,j} = \begin{cases} -b_{i,j} & \text{if } i = k \text{ or } j = k, \\ b_{i,j} + \frac{|b_{i,k}| |b_{k,j} + b_{i,k}| |b_{k,j}|}{2} & \text{otherwise.} \end{cases}$$

When the skew-symmetrizable matrix is actually skew-symmetric, then this definition of mutation coincides with the definition of quiver mutation as defined above.

A skew-symmetric matrix uniquely defines a quiver, so we would like to construct a similar graph for a given skew-symmetrizable matrix.

**Definition 2.1.9.** Given a skew-symmetrizable  $n \times n$  matrix  $B = (b_{i,j})$ , its associated **diagram** is a weighted directed graph with vertices labelled  $1, \dots, n$  and an arrow between  $i \rightarrow j$  with weight  $-b_{i,j}b_{j,i}$  when  $b_{i,j} > 0$ , as shown in Figure 2.4.

In this way we can construct a weighted graph for any skew-symmetrizable matrix, however it is not true that any weighted graph can give such a skew-symmetrizable matrix. In order for such a matrix to exist, the product of weights in every chordless cycle in the diagram must be a perfect square. For example the weighted graph in Figure 2.5 does not have any skew-symmetrizable matrix representative.

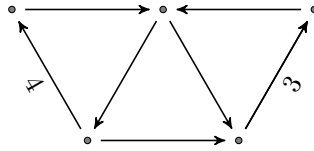

Figure 2.5: An example of a weighted graph which cannot be represented as a skew-symmetrizable matrix. Note that any cycle containing the weight 3 will not give a perfect square product of weights.

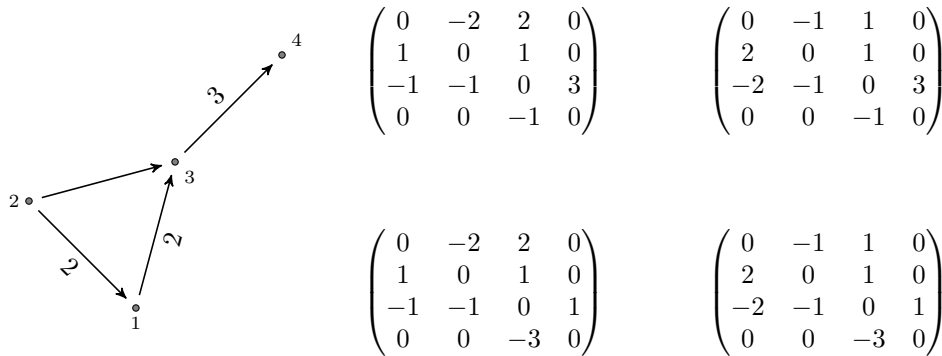

Figure 2.6: A diagram corresponding to multiple different skew-symmetrizable matrix representatives.

As the weights in the diagram are products of the two values in the matrix, a given diagram could admit multiple different skew-symmetrizable matrix representatives, as illustrated in Figure 2.6.

This requirement to have squares in each cycle provides a way to mutate the diagram without knowing the actual matrix representation of the diagram. This mutation then coincides with the matrix mutation given above.

**Definition 2.1.10.** Given a diagram  $R$ , then **diagram mutation** in the  $k$ -th vertex gives a new diagram  $\mu_k(R) = R'$  constructed from  $R$  as shown in Figure 2.7. For any path  $i \rightarrow k \rightarrow j$  of length 2 through  $k$ , the edge  $i - j$  will change, as will the direction of all arrows adjacent to  $k$ .

A diagram does not contain all the information present in its skew-symmetrizable matrix, as the edge labels do not describe how the values in the matrix appear. A different way to construct a quiver-like object from a skew-symmetrizable matrix which preserves all this information is to use valued quivers; these introduce edge weights or vertex weights depending on the type used.

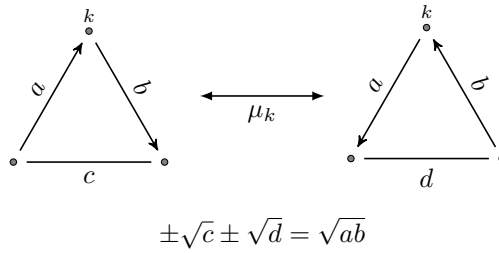

Figure 2.7: Local mutation of a diagram in vertex  $k$ . The value of  $d$  is uniquely determined by the formula, and either of  $c$  or  $d$  could be zero. The sign of  $\sqrt{c}$  (and of  $\sqrt{d}$ ) is positive if the cycle is oriented, otherwise it is negative.

**Definition 2.1.11.** A (pair weighted) **valued quiver** representing a given skew-symmetrizable matrix  $B = (b_{i,j})$  is a quiver with an arrow  $i \rightarrow j$  when  $b_{i,j} > 0$  with weight  $(-b_{j,i}, b_{i,j})$ , on the left in Figure 2.8.

**Definition 2.1.12** ([FG09, Sec. 1.2], [LFZ16, Sec. 1]). A (vertex weighted) **valued quiver** representing a given skew-symmetrizable matrix  $B = (b_{i,j})$  with symmetrizing matrix  $D = (d_i)$  is a quiver with

$$\frac{b_{i,j} \gcd(d_i, d_j)}{d_j} = \frac{-b_{j,i} \gcd(d_i, d_j)}{d_i}$$

arrows  $j \rightarrow i$  when  $b_{i,j} > 0$  and each vertex  $i$  has the weight  $d_i$  attached to it, as shown in Figure 2.8.

The initial skew-symmetrizable matrix of either type of valued quiver can easily be constructed from the quiver. Each quiver can also be mutated in such a way that this mutation coincides with its corresponding matrix mutation, see for example [LFZ16, Sec. 1] for vertex weighted quiver mutation.

### 2.1.2 The global mutation group

In all the above, we have used labels on the vertices of the quivers and diagrams to construct their matrices. A typical mutation class will contain many isomorphic quivers, distinguished only by this labelling. In some cases it is useful to consider all isomorphic quivers separately, though this is often more computationally expensive and usually does not lead to any additional information than when considering

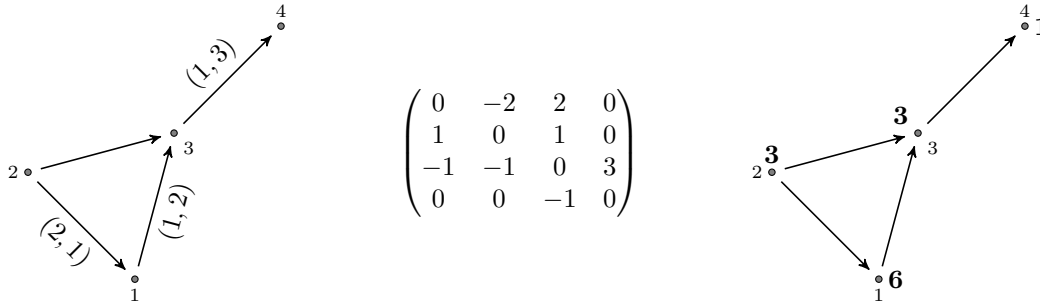

Figure 2.8: The two types of valued quiver representing a skew-symmetrizable matrix. On the left is the pair weighted valued quiver, where the edge weights are given as pairs  $(-b_{j,i}, b_{i,j})$  and on the right is the vertex weighted quiver, where the vertex weights are given in bold.

classes of isomorphic quivers.

We introduce the idea of labelled and unlabelled mutation classes, following King and Pressland [KP16], to enable us to specify whether we are considering individual quivers or classes of isomorphic quivers.

**Definition 2.1.13.** A **labelled quiver** is a quiver with a specific choice of labels on its vertices.

A quiver isomorphism is a permutation of the labels on the vertices, so a permutation  $\sigma$  acts on a labelled quiver  $Q$  by taking the  $i$ -th vertex to the  $\sigma(i)$ -th vertex in  $Q \cdot \sigma = Q^\sigma$ .

Above we defined mutations using the labelling of vertices, however the process is exactly the same if the labels are removed. Without labels the idea of having a mutation  $\mu_k$  is problematic as there is no label  $k$ , so we need to distinguish between global mutations  $\mu_i$  on labelled quivers and local mutations  $\mu$  on unlabelled quivers. Once we add variables in Section 2.2 then these local mutations will be indexed by the variables corresponding to the mutated vertex.

When considering labelled quivers, the mutations  $\mu_i$  can be thought of as belonging to a group, along with permutations, which act on quivers with  $Q \cdot \mu_k = \mu_k(Q)$  and  $Q \cdot \sigma = Q^\sigma$ .

**Definition 2.1.14** ([KP16, Sec. 1]). The **global mutation group** of rank  $n$  is the

group

$$M_n = \langle \mu_1, \dots, \mu_n \mid \mu_i^2 = 1 \rangle \rtimes \text{Sym}(n)$$

where the  $\mu_i$  are mutations and  $\mu_i \sigma = \sigma \mu_{\sigma(i)}$  for  $\sigma \in \text{Sym}(n)$ .

The labelled mutation class  $\mathcal{S}^0(Q)$  of a labelled quiver  $Q$  is the orbit of  $Q$  under the action of  $M_n$ , and the unlabelled mutation class  $\mathcal{S}(Q)$  is given by the quotient by the symmetric group action. This definition of mutation class coincides with the definition given above, as any two quivers in the same orbit of  $M_n$  are mutation-equivalent.

## 2.2 Variables, clusters and seeds

The mutations of quivers and matrices yields a number of interesting results, including the classification of mutation-finite matrices by Felikson, Shapiro and Tumarkin in [FST12c] discussed in Section 2.5 as well as the classification of minimal mutation-infinite quivers given in Chapter 3. However most work on cluster algebras includes the study of rational functions which also change under mutations and generate the cluster algebra itself.

To be precise, we start by considering labelled clusters and labelled seeds, though typically cluster algebra papers only study their unlabelled counterparts.

**Definition 2.2.1.** An  $n$ -tuple  $\mathbf{x} = (\beta_1, \dots, \beta_n)$  of rational functions in  $\mathcal{F}$  is a **labelled cluster** if the elements are all algebraically independent in  $\mathcal{F}$ .

**Definition 2.2.2.** A **labelled seed** is a pair  $(\mathbf{x}, B)$  where  $\mathbf{x} = (\beta_1, \dots, \beta_n)$  is a labelled cluster and  $B = (b_{i,j})$  is a  $n \times n$  skew-symmetrizable matrix.

The matrix  $B$  is usually referred to as the **exchange matrix** and the rational functions  $\beta_i$  appearing in a cluster are referred to as **cluster variables**.

**Definition 2.2.3.** Let  $(\mathbf{x}, B)$  be a labelled seed in  $\mathcal{F}$  and  $k \in \{1, \dots, n\}$  then **seed mutation** in the  $k$ -th direction constructs a new seed  $(\mathbf{x}', B')$  from  $(\mathbf{x}, B)$  where

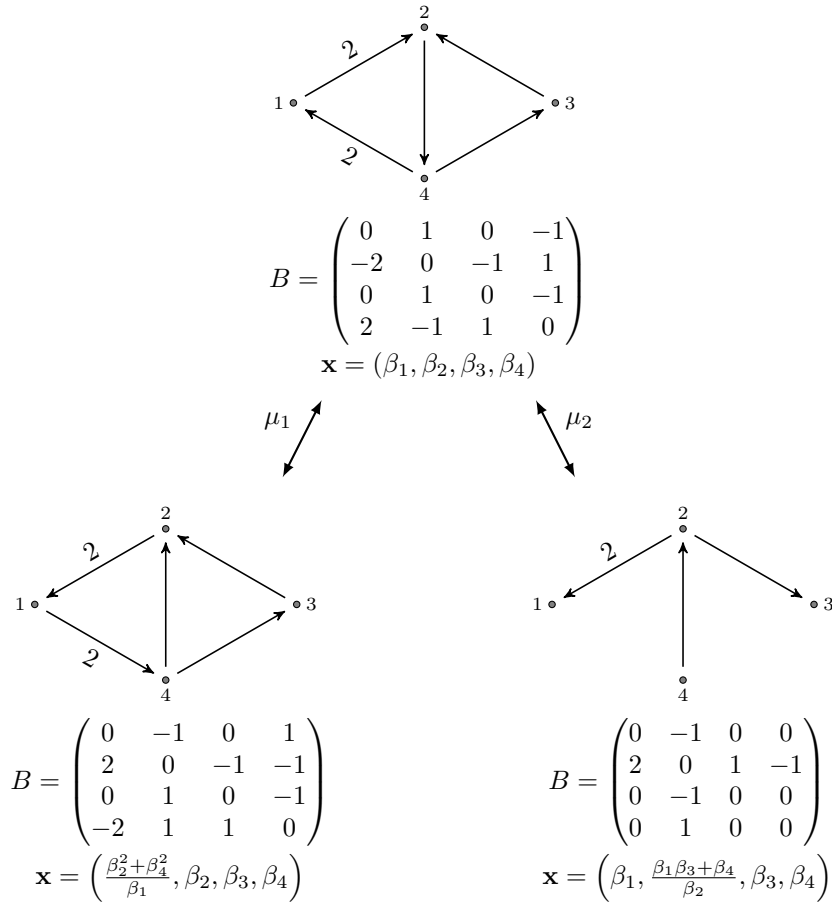

Figure 2.9: An example of mutating one seed in two different directions, following Definition 2.2.3.

$\mathbf{x}' = (\beta'_1, \dots, \beta'_n)$  is given by

$$\beta'_i = \begin{cases} \beta_i & \text{if } i \neq k, \\ \frac{\prod_{b_{j,i} > 0} \beta_j^{b_{j,i}} + \prod_{b_{j,i} < 0} \beta_j^{-b_{j,i}}}{\beta_i} & \text{if } i = k, \end{cases}$$

and  $B'$  is given by the  $k$ -th mutation of  $B$  as defined above. An example of such a mutation on a seed is shown in Figure 2.9.

In a labelled seed the cluster and matrix have a natural order which can be permuted to give other labelled seed. As such, a permutation  $\sigma \in \text{Sym}(n)$  acts on a labelled seed in a natural way permuting the rows and columns of  $B$  and taking the  $i$ -th cluster variable to the  $\sigma(i)$ -th cluster variable. In this way  $(\mathbf{x}, B)$  is permuted by  $\sigma$  to  $(\mathbf{x}^\sigma, B^\sigma)$  where  $\mathbf{x}^\sigma = (\beta_{\sigma^{-1}(1)}, \dots, \beta_{\sigma^{-1}(n)})$  and  $B^\sigma = (b_{i,j}^\sigma)$ ,  $b_{i,j}^\sigma = b_{\sigma^{-1}(i), \sigma^{-1}(j)}$ .

Using these mutations and permutations, the global mutation group, which acts

on quivers as discussed earlier, can also act on labelled seeds.

**Definition 2.2.4.** An (unlabelled) **seed** (respectively **cluster**) is the orbit of a labelled seed (resp. cluster) under the symmetric group  $\text{Sym}(n)$ .

The global mutations  $\mu_k$  on a labelled seed are given in terms of the vertex label  $k$ , however in the unlabelled case the vertices no longer have such a label and so these mutations need to be denoted in another way. Each variable in the seed's cluster can be thought of as being attached to a vertex of the quiver, as such this variable can be used to distinguish the different **local mutations** of an unlabelled seed. In this way the mutation of a seed  $(\mathbf{x}, B)$  at the vertex corresponding to variable  $\beta_k \in \mathbf{x}$  is denoted  $\mu_{\beta_k, \mathbf{x}}$ .

**Definition 2.2.5.** The **labelled mutation class**,  $\mathcal{S}^0(\mathbf{x}, B)$ , of a given labelled seed  $(\mathbf{x}, B)$  is its orbit under the action of the global mutation group. The corresponding (unlabelled) **mutation class**  $\mathcal{S}(\mathbf{x}, B)$  is the quotient by the symmetric group action.

**Definition 2.2.6.** The **cluster algebra**  $\mathcal{A}(\mathcal{S}^0(\mathbf{x}, B))$  with initial seed  $(\mathbf{x}, B)$  is the subalgebra of  $\mathcal{F}$  generated by all cluster variables appearing in labelled seeds in  $\mathcal{S}^0(\mathbf{x}, B)$ .

As the cluster variables in  $\mathcal{S}(\mathbf{x}, B)$  are the same as those in  $\mathcal{S}^0(\mathbf{x}, B)$ , the algebra generated by the mutation class is the same as the one generated by the labelled mutation class.

One of the nice properties that cluster algebras have is the Laurent phenomenon.

**Theorem 2.2.7** (Laurent Phenomenon [FZ02, Thm. 3.1]). *Every cluster variable in a cluster algebra  $\mathcal{A}$  generated from an initial cluster  $\mathbf{x} = (\beta_1 \cdots, \beta_n)$  is a Laurent polynomial in these initial cluster variables.*

This phenomenon is surprising as the mutation exchange relations often involve division by polynomials in the variables, however it turns out that such a division will always factor out and leave a monomial as the denominator in the initial cluster variables.

The proof of the Laurent phenomenon follows the so called Caterpillar Lemma, which can actually be applied in a more general setting than cluster algebras. The algebras which satisfy the constraints of the Caterpillar Lemma are called Laurent phenomenon algebras, as introduced by Lam and Pylyavskyy in [LP16].

**Theorem 2.2.8** (Positivity conjecture). *The coefficients in each of the Laurent polynomials are non-negative.*

This conjecture of Fomin and Zelevinsky was proved separately for a number of classes of cluster algebras, for example it has been proved for acyclic cluster algebras [KQ14], surface [MSW11] and orbifold [FST12a] cluster algebras, before being proved more generally for skew-symmetric [LS15] and skew-symmetrizable [GHKK14] cluster algebras.

**Definition 2.2.9.** If the mutation class of a seed  $(\mathbf{x}, B)$  contains infinitely many cluster variables then the seed and its cluster algebra are of **infinite type**, otherwise they are of **finite type**.

The finite type cluster algebras were classified by Fomin and Zelevinsky in [FZ03], and this classification will be outlined in Section 2.4.

## 2.3 Exchange graphs

Exchange graphs were introduced by Fomin and Zelevinsky in [FZ02], and the graphs were used in the classification of all finite-type cluster algebras in [FZ03]. These algebras are the only ones where the corresponding exchange graph is finite. Exchange graphs are studied further in Section 5.3 which includes examples and figures.

**Definition 2.3.1.** The **exchange graph**  $\mathcal{E}(\mathcal{S})$  of a mutation class  $\mathcal{S}$  is a graph with a vertex for each seed and an edge between two seeds if and only if there is a single local mutation  $\mu$  such that  $\mu(u) = v$ .

An initial seed can be used to construct its entire mutation class, and so it also gives its entire exchange graph as well as its cluster algebra. It is therefore convenient to denote the exchange graph as  $\mathcal{E}(\mathbf{x}, B)$  instead of  $\mathcal{E}(\mathcal{S}(\mathbf{x}, B))$ .

In Section 2.1 we considered the properties of quiver mutation classes, without any clusters, variables or seeds. The idea of an exchange graph can be applied in this case as well, and in fact this quiver exchange graph can be useful to study alongside the seed exchange graph.

**Definition 2.3.2.** The **quiver exchange graph** of an unlabelled quiver  $Q$  (or equivalently of its mutation class) is a graph with a vertex for each unlabelled quiver mutation-equivalent to  $Q$ , and an edge between quivers  $P$  and  $P'$  if there is a local mutation  $\mu$  such that  $\mu(P) = P'$ .

These graphs encode the combinatorial information inherent in the cluster structure of the mutation class, and so provide a combinatorial approach to study this structure without explicitly using the algebra or any additional data used to create the algebra. We will see later that this idea can be used for example to combinatorially construct mapping classes for surfaces without relying on any additional information about the surface.

## 2.4 Reflections and Dynkin diagrams

Reflections can be studied in any vector space with an inner product, and in the following we give various results in terms of a general real vector space. However it is usual to consider them as reflections of some geometric space, such as Euclidean space or hyperbolic space. A good introductory text, on which the following is based, is Humphrey's book [Hum90].

Reflections are linear maps which fix a hyperplane in the vector space, and interchanges the two half spaces either side of the hyperplane. Such a reflection is uniquely determined by this hyperplane, which in turn is uniquely determined by a vector normal to it.

We consider a vector space  $V$  with an inner product  $\langle \cdot, \cdot \rangle$ . Given some non-zero vector  $\alpha \in V$ , with  $\langle \alpha, \alpha \rangle \neq 0$ , there is an associated hyperplane  $H_\alpha = \{v \in V \mid \langle v, \alpha \rangle = 0\}$  orthogonal to  $\alpha$  and this defines a unique reflection  $s_\alpha$  fixing  $H_\alpha$  given by

$$s_\alpha(u) = u - 2 \frac{\langle u, \alpha \rangle}{\langle \alpha, \alpha \rangle} \alpha.$$

Note that if  $u \in H_\alpha$  then  $\langle u, \alpha \rangle = 0$  so  $u$  is fixed, and that if  $u = \alpha$  then  $s_\alpha(\alpha) = \alpha - 2\alpha = -\alpha$  as expected. Also it is evident that a reflection is an involution, with  $s_\alpha^2 = 1$ .

If  $\alpha$  and  $\beta$  are two non-zero vectors in  $V$  with associated hyperplanes  $H_\alpha, H_\beta$  and reflections  $s_\alpha$  and  $s_\beta$ , then the relation between the reflections can be given in terms of the dihedral angle between the hyperplanes.

**Proposition 2.4.1.** *If the dihedral angle between  $H_\alpha$  and  $H_\beta$  in  $V$  is  $\frac{\pi}{k}$  then the reflections  $s_\alpha$  and  $s_\beta$  satisfy the relation  $(s_\alpha s_\beta)^k = 1$ .*

The dihedral angle between the hyperplanes is determined by  $\alpha$  and  $\beta$  themselves, so the value  $k$  is usually denoted  $m(\alpha, \beta)$ . Any group generated by reflections  $s_{\alpha_1}, s_{\alpha_2}, \dots$  will therefore have relations  $s_{\alpha_i}^2 = 1$  for all  $i$  and  $(s_{\alpha_i} s_{\alpha_j})^{m(\alpha_i, \alpha_j)} = 1$  for all  $i \neq j$ .

A generalisation of reflection groups are Coxeter groups which have the following presentation:

**Definition 2.4.2.** A group with presentation

$$\langle r_1, r_2, \dots \mid (r_i r_j)^{k_{i,j}} \rangle$$

where  $k_{i,i} = 1$  and  $k_{i,j} \geq 2$  for  $i \neq j$  is a **Coxeter group**. An infinite value for  $k_{i,j}$  signifies no relation between  $r_i$  and  $r_j$ .

The finite Coxeter groups were classified in [Cox34] using Coxeter diagrams, which are graphs encoding the generators and relations in the group. Each such group with relations given by  $k_{i,j} \in \{1, 2, 3, 4, 6\}$  is generated by a crystallographic root system, which contains roots of at most two lengths. A graph similar to a

Coxeter diagram can be used to represent this root system, where directed edges are used to encode the lengths of the roots. These graphs are called Dynkin diagrams and a list of all such Dynkin diagrams is given in Figure 2.10. These root systems also arise from simple Lie algebras, and so the Dynkin diagrams classify these simple Lie algebras, as shown by Dynkin [Dyn46].

### 2.4.1 Finite type cluster algebra classification

Fomin and Zelevinsky classified all finite type cluster algebras, those generated by a finite number of cluster variables, using these Dynkin diagrams and their associated Cartan matrices.

**Theorem 2.4.3** ([FZ03, Thm. 1.5]). *A cluster algebra  $\mathcal{A}$  is of finite type if and only if it can be generated by a skew-symmetrizable matrix given by an orientation of one of the Dynkin diagrams.*

The skew-symmetric cluster algebras of finite type are therefore the ones generated by orientations of the simply-laced Dynkin diagrams of type  $A_n$ ,  $D_n$  and  $E_n$ . As each of these diagrams is acyclic, all orientations are mutation-equivalent as shown by Caldero and Keller [CK06, Cor. 4], and so there is a single cluster algebra for each Dynkin diagram. The non-simply-laced Dynkin diagrams correspond to skew-symmetrizable cluster algebras.

**Theorem 2.4.4** ([FZ03, Thm. 1.9]). *Let  $A$  be a Cartan matrix of finite type,  $\mathcal{A}$  be a cluster algebra related to  $A$ , and  $\Psi_{\geq -1}$  the almost positive roots in the root system associated with  $A$ . Then there is a bijection between  $\Psi_{\geq -1}$  and the cluster variables in  $\mathcal{A}$ .*

This bijection can be used to give an example of the Laurent Phenomenon (Theorem 2.2.7) and was used by Fomin and Zelevinsky to prove the positivity conjecture for the finite type cluster algebras (see [FZ03, Thm. 1.10]).

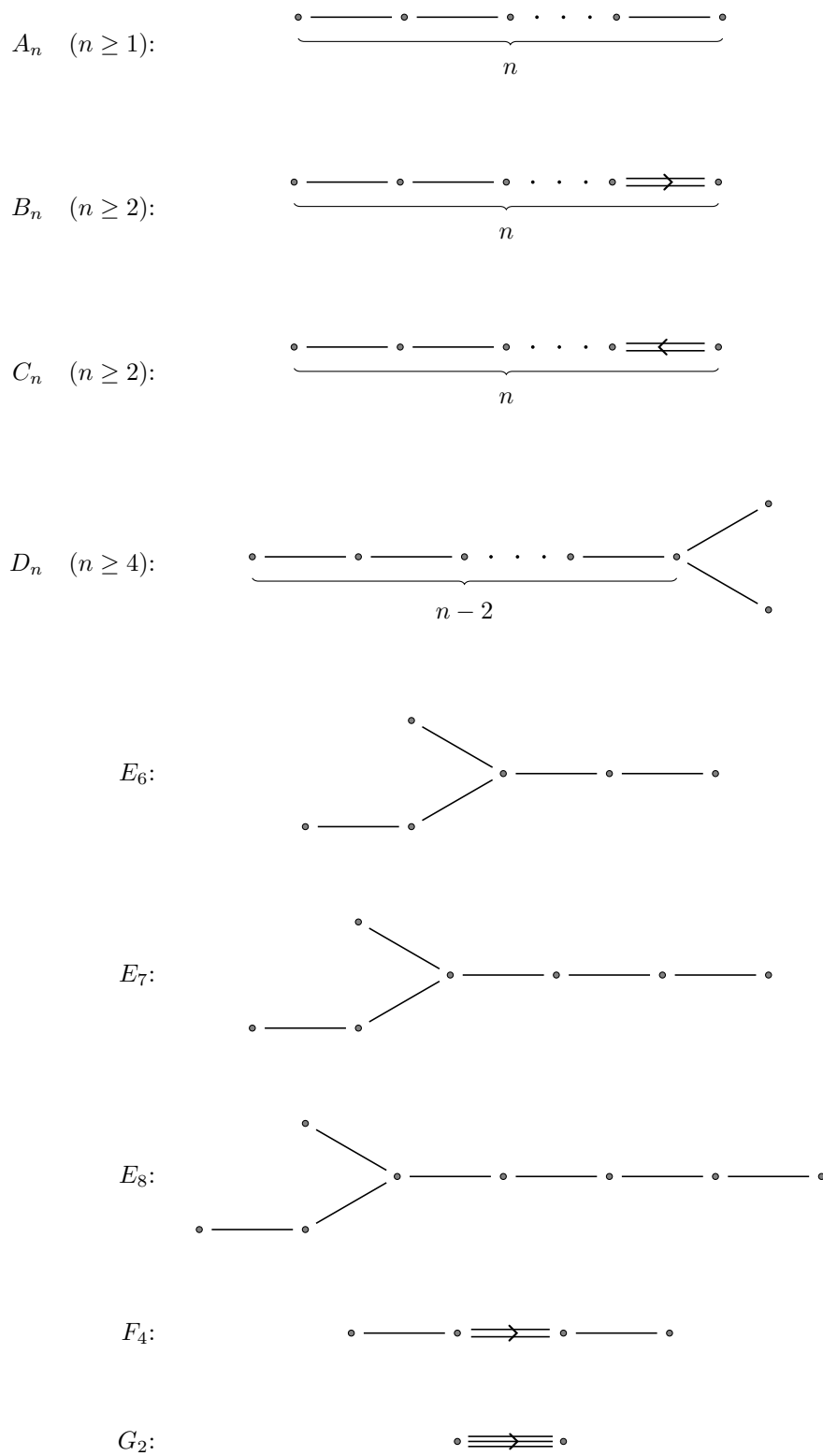

Figure 2.10: A list of all Dynkin diagrams.

## 2.5 Surface cluster algebras

The finite type cluster algebras were classified in terms of the Dynkin diagrams linked to crystallographic root systems. Another class of cluster algebras which have a concrete realisation contains the cluster algebras arising from triangulations of surfaces.

Fomin, Shapiro and Thurston introduced this approach to study the geometry and triangulations of surfaces using cluster algebras in [FST08] and more recent work by Felikson, Shapiro and Tumarkin [FST12a] extends these ideas to include 2 dimensional orbifolds. This section closely follows the notation and ideas from these papers.

A **surface with marked points** is a pair  $(\mathbf{S}, \mathbf{M})$  where  $\mathbf{S}$  is a connected orientable 2-dimensional Riemann surface with (possibly empty) boundary  $\partial\mathbf{S}$  and  $\mathbf{M}$  is a finite set of distinct marked points in the closure of  $\mathbf{S}$ , such that for each boundary component  $C$  of  $\mathbf{S}$  there is at least one marked point lying on  $C$ , i.e.  $\mathbf{M} \cap C \neq \emptyset$ . Any marked points in the interior of  $\mathbf{S}$  are called **punctures**.

**Definition 2.5.1.** An **arc** in a surface with marked points  $(\mathbf{S}, \mathbf{M})$  is an isotopy class of curves  $\gamma$  in the surface  $\mathbf{S}$  such that:

- The endpoints of  $\gamma$  lie in  $\mathbf{M}$ ;
- The curve  $\gamma$  has no self-intersections except possibly at its endpoints;
- The curve  $\gamma$  only intersects  $\mathbf{M}$  and  $\partial\mathbf{S}$  at its endpoints;
- The curve is not contractible into  $\mathbf{M}$  or onto the boundary  $\partial\mathbf{S}$ .

Two arcs are **compatible** if there exist curves in their isotopy classes which do not intersect except possibly at their endpoints.

**Definition 2.5.2.** An **ideal triangulation** of  $(\mathbf{S}, \mathbf{M})$  is a maximal collection of pairwise compatible arcs in  $(\mathbf{S}, \mathbf{M})$ .

In order to ensure that the surface admits a hyperbolic structure, and so have triangulations where arcs cut the surface into ideal triangles, we will exclude:

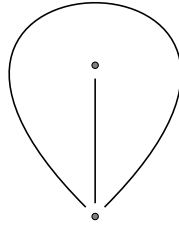

Figure 2.11: A self-folded triangle.

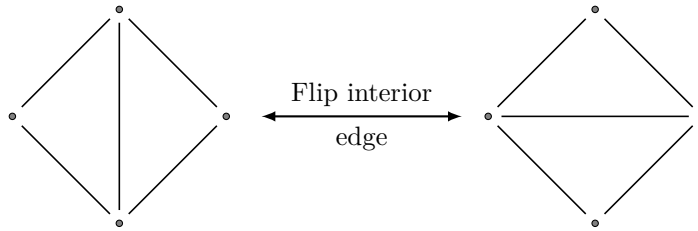

Figure 2.12: Flipping the interior arc of a triangulation.

- A sphere with one or two punctures.
- An unpunctured or once-punctured monogon.
- An unpunctured digon.
- An unpunctured triangle.

This definition of a triangulation allows **self-folded** ideal triangles where two of the edges are identified, such as that in Figure 2.11.

### 2.5.1 Cluster structures from triangulations

The number of edges in any triangulation of the same surface with marked points is a constant, and can be explicitly given in terms of the genus, number of boundary components, punctures and marked points (see e.g. [FST08, Prop. 2.10]).

**Definition 2.5.3.** A **flip** in a triangulation removes a single arc from the triangulation and replaces it with the unique different arc compatible with all other arcs in the triangulation.

All arcs except for the folded edges in self-folded triangles can be flipped in this way, and stylistically these flips look like the one shown in Figure 2.12.

Each ideal triangulation  $T$  of a given surface  $(\mathbf{S}, \mathbf{M})$  can be associated to a skew-symmetric matrix  $B = B(T)$ , its **adjacency matrix**. The construction of

this matrix is given in [FST08, Sec. 4] and extends the standard construction of a triangulation's adjacency matrix given in [FG07] and [GSV05].

**Proposition 2.5.4.** *Given an ideal triangulation  $T$ , with associated adjacency matrix  $B(T)$ , then if  $T'$  is the triangulation obtained by flipping the arc corresponding to vertex  $k$  in  $B(T)$ , then  $B(T') = \mu_k(B(T))$ .*

It is a well known result that any ideal triangulation of a surface  $(\mathbf{S}, \mathbf{M})$  can be obtained from any other by a sequence of triangle flips, proved by Hatcher in [Hat91]. In this way, we can consider the ideal triangulations of a surface  $(\mathbf{S}, \mathbf{M})$  to have a cluster structure. Each triangulation corresponds to a matrix which can be mutated to give new triangulations, and the mutation class of the triangulation (or equivalently its matrix) depends only on  $(\mathbf{S}, \mathbf{M})$  and not on the choice of the initial triangulation.

## 2.5.2 Adding taggings

For a triangulation without any self-folded triangles, these triangle flips give a cluster structure where the flips correspond to mutations. However in cluster algebras, a quiver can be mutated at any vertex therefore these folded edges which cannot be flipped pose a problem when translating the theory of surface triangulations to that of cluster algebras. Fomin, Shapiro and Thurston introduce a tagging to the triangulations in [FST08, Sec. 7] which removes these self-folded triangles and ensures that all arcs can be flipped.

**Definition 2.5.5.** A **tagged arc** of  $(\mathbf{S}, \mathbf{M})$  is an arc where each endpoint is tagged as either 'plain' or 'notched' ( $\bowtie$ ) such that:

- The arc does not cut out a once-punctured monogon;
- Any endpoint on  $\partial\mathbf{S}$  is marked plain;
- Both ends of a loop are tagged the same way.

**Definition 2.5.6.** Two distinct tagged arcs  $\alpha$  and  $\beta$  are then **compatible** if the following are true:

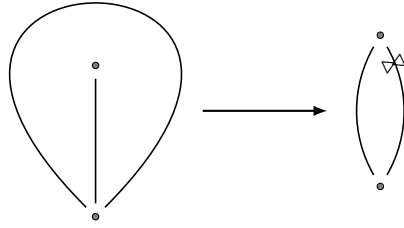

Figure 2.13: Converting a self-folded triangle to tagged arcs.

- The untagged arcs of  $\alpha$  and  $\beta$  are compatible;
- If the untagged arcs are not the same and  $\alpha$  and  $\beta$  share an endpoint, then the marking at that endpoint must be the same;
- If the untagged arcs are the same, then the marking at only one of the endpoints must be the same for  $\alpha$  and  $\beta$ .

**Definition 2.5.7.** As before, a **tagged triangulation** of  $(\mathbf{S}, \mathbf{M})$  is a maximal collection of pairwise compatible tagged arcs.

Any untagged triangulation of  $(\mathbf{S}, \mathbf{M})$  can be converted to a tagged triangulation by replacing any outside arc of a self-folded triangle with a tagged arc as shown in Figure 2.13. These tagged triangulations allow every arc to be flipped which, together with the following well known result, shows that the set of all tagged triangulations of a surface with marked points has a cluster structure.

**Theorem 2.5.8** ([FST08, Prop. 7.10]). *Any two tagged triangulations of a given surface with marked points (except for once-punctured closed surfaces) can be obtained from each other through a sequence of flips.*

*In the case of a once-punctured closed surface all arc ends are either notched or plain, and flips will not change these taggings.*

Not only do these tagged triangulations have a cluster structure, we can explicitly construct a cluster algebra where mutations correspond to triangle flips. The quiver associated to a given triangulation is constructed with a vertex for each tagged arc, and arrows inside each triangle following the orientation of the surface, as shown in Figure 2.14.

As a quiver corresponds to a skew-symmetric matrix, its triangulation is associated to this matrix, which is called its **adjacency matrix**.

**Proposition 2.5.9.** *Given a tagged triangulation  $T$  of  $(\mathbf{S}, \mathbf{M})$  with associated quiver  $Q$ , and  $T'$  another triangulation obtained from  $T$  by flipping the  $k$ -th edge. Then the associated quiver to  $T'$  is the same as the  $k$ -th mutation of  $Q$ .*

### 2.5.3 Extending to orbifolds

We can extend the above ideas of triangulations of surfaces to include certain examples of orbifolds, as studied by Felikson, Shapiro and Tumarkin in [FST12a].

**Definition 2.5.10.** An **orbifold**  $\mathcal{O} = (\mathbf{S}, \mathbf{M}, \mathbf{Q})$  is a surface with marked points and an additional collection of **orbifold points**  $\mathbf{Q}$ , with  $\mathbf{M} \cap \mathbf{Q} = \emptyset$ . All orbifold points are in the interior of  $\mathbf{S}$ , whereas the marked points can lie on the boundary and in the interior of  $\mathbf{S}$  as before.

In addition to the arcs on the surface, a triangulation of an orbifold can contain arcs with an endpoint at one of the orbifold points.

**Definition 2.5.11.** A **pending arc** is an arc (considered up to isotopy) with one endpoint in  $\mathbf{Q}$  and the other in  $\mathbf{M}$ .

Two pending arcs  $\gamma$  and  $\gamma'$  are compatible if their orbifold endpoints are distinct, and the arcs do not intersect.

As for surfaces, triangulations of an orbifold are maximal collections of compatible arcs, which are defined in the same way with the exception that if an arc cuts out a monogon, then the monogon must contain at least 2 orbifold points, or one marked point and that the triangulation could contain a digon with one orbifold point.

A triangulation of an orbifold will not give a quiver, but can be associated to a diagram in a similar way. Arrows between pending and non-pending arcs get a weight of 2, while arrows between two pending arcs get a weight of 4. Given such a triangulation, the arcs can be flipped in exactly the same way as for surfaces by

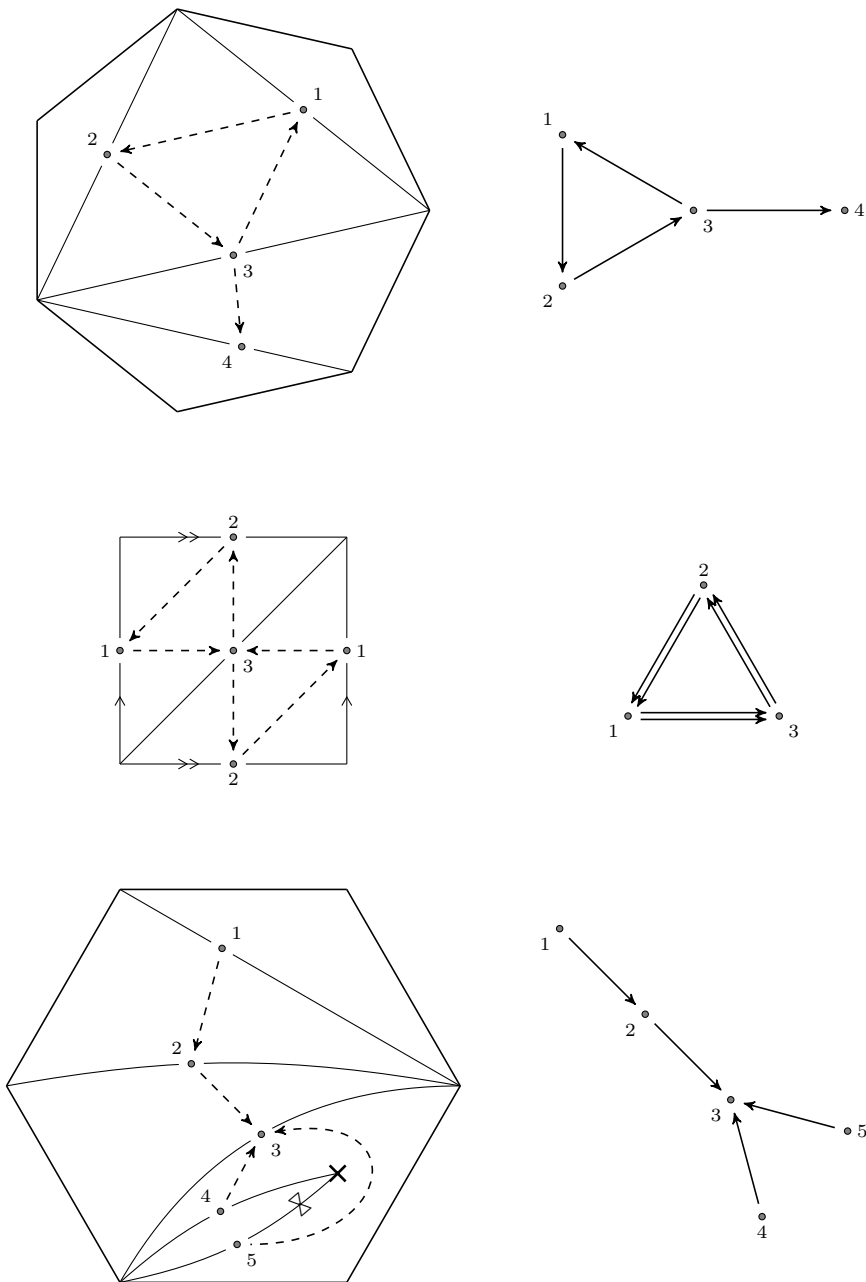

Figure 2.14: Constructing quivers from triangulations of a heptagon, torus and punctured hexagon. Note that the boundary arcs in the hexagon and heptagon do not correspond to vertices in the quiver, while the identification of opposite edges in the torus leads to double arrows in its quiver. The puncture in the bottom figure is depicted as a cross.

replacing a given arc (pending or not) with the unique other arc compatible with the rest of the triangulation. These flips will coincide with mutations of the associated diagrams.

A diagram could be associated to a number of different matrices, while we would like to associate a single matrix to any given orbifold and to do this we add weights to the orbifold points.

**Definition 2.5.12.** A **weighted orbifold**  $\mathcal{O}^w$  is an orbifold where each orbifold point is assigned a weight of either 2 or  $1/2$ .

A skew-symmetrizable matrix can then be associated to each triangulation of a weighted orbifold by glueing the matrix blocks shown in Table 3.4 in [FST12a], where an orbifold point of weight 2 is shown as a circle, and an orbifold point of weight  $1/2$  is shown as a cross.

Alternatively a vertex weighted valued quiver can be constructed from the triangulation of a weighted orbifold. The underlying (unweighted) quiver is the same as for a surface triangulation, and the weights on the vertices are computed from the weights of the orbifold points.

All vertices corresponding to non-pending arcs have the same weight  $w$ , which depends on the weights of the orbifold points; if all orbifold points have a weight of 2, then  $w = 1$ , otherwise  $w = 2$ . Then the weight  $c = dw$  of a vertex in the diagram corresponding to a pending arc is the weight  $d$  of the orbifold point adjacent to the pending arc multiplied by the common weight  $w$ .

The weights of orbifold points are either  $1/2$  or 2, so the only possible vertex weights are 1, 2 and 4, furthermore vertex weights of 4 are only present if the orbifold point weights are not all 2. Such a valued quiver defines a skew-symmetrizable matrix, and the vertex weights correspond to the corresponding entries in its symmetrizing matrix.

There are two choices of weight for each orbifold point in a given orbifold, however Felikson, Shapiro and Tumarkin [FST12a, Rem. 4.18] show that the matrices obtained from two different weightings of the same orbifold are mutation-equivalent

if both have the same number of orbifold points weighted 2 (or equivalently the same number weighted  $1/2$ ).

### 2.5.4 Mutation-finite classification

Any orbifold or surface with marked points has only a finite number of triangulations, and so the mutation class of any matrix arising from these triangulations must contain only a finite number of matrices. This was the initial step towards the classification of all mutation finite matrices and the natural question was whether there were any other mutation finite matrices which do not arise from triangulations.

This question was answered in the skew-symmetric case by Felikson, Shapiro and Tumarkin in [FST12c] who showed that there are other classes of mutation finite quivers, however there are not many:

**Theorem 2.5.13** ([FST12c, Thm. 6.1]). *Any mutation-finite skew-symmetric matrix is either the adjacency matrix of a surface triangulation or mutation equivalent to one of the 11 exceptional types:  $E_6$ ,  $E_7$ ,  $E_8$ ,  $\tilde{E}_6$ ,  $\tilde{E}_7$ ,  $\tilde{E}_8$ ,  $E_6^{(1,1)}$ ,  $E_7^{(1,1)}$ ,  $E_8^{(1,1)}$ ,  $X_6$  or  $X_7$ , shown in Figure 2.15.*

Clearly all quivers giving finite type cluster algebras must be mutation-finite. These were shown to correspond to orientations of the simply-laced Dynkin diagrams, and so these must fit into the classification above. The type  $A_n$  quivers correspond to triangulations of polygons, while  $D_n$  quivers arise from triangulations of once punctured polygons. The affine Dynkin diagrams also play a role in the mutation-finite classification, as  $\tilde{A}_n$  quivers come from triangulations of annuli and  $\tilde{D}_n$  from twice punctured polygons. The  $X_6$  and  $X_7$  quivers were first shown to be mutation-finite by Derksen and Owen in [DO08], while the extended Dynkin quivers were more widely known.

Once the result was known for skew-symmetric matrices a natural extension is to look at skew-symmetrizable matrices, for which a similar result holds.

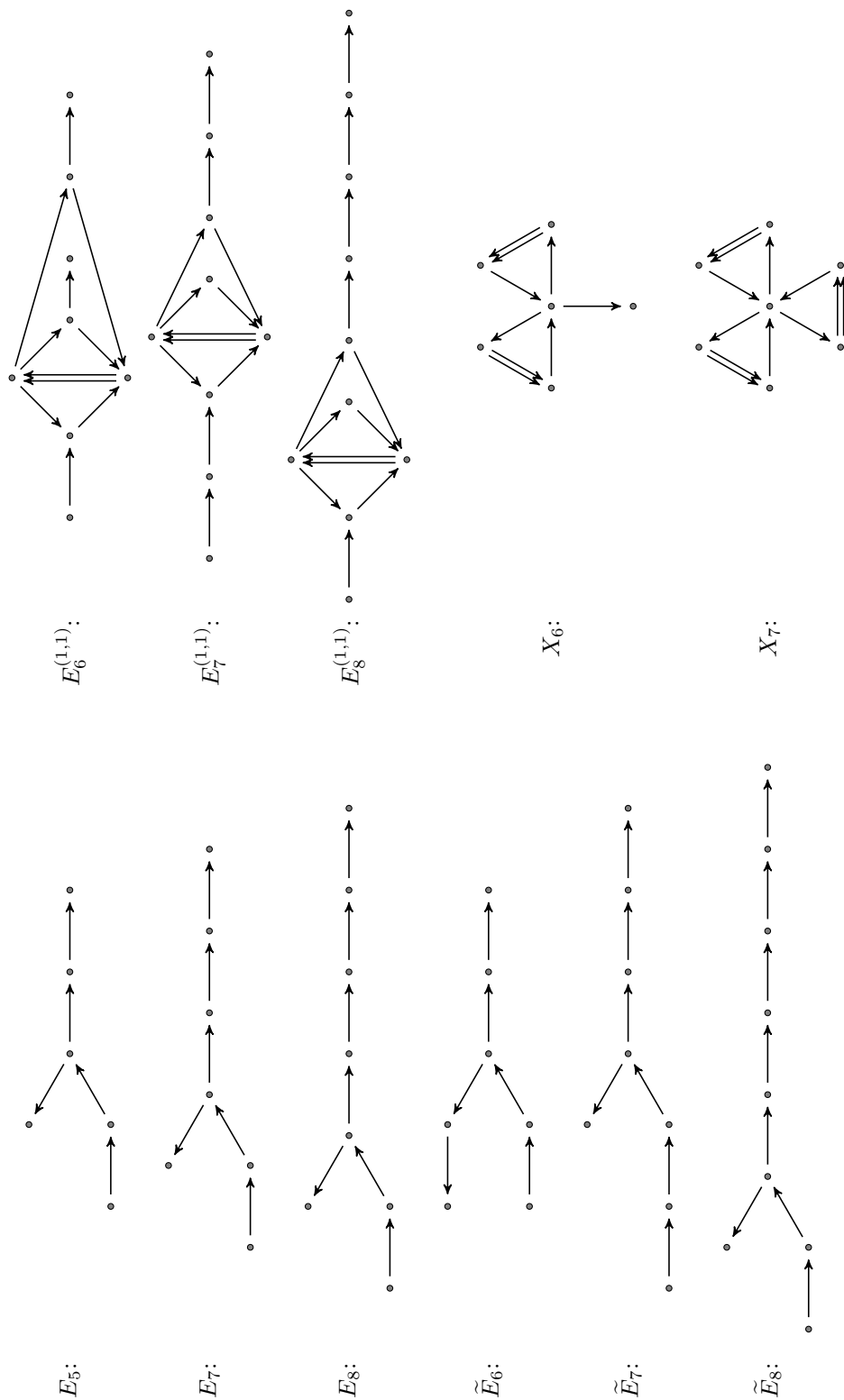

Figure 2.15: The exceptional types of mutation-finite quivers.

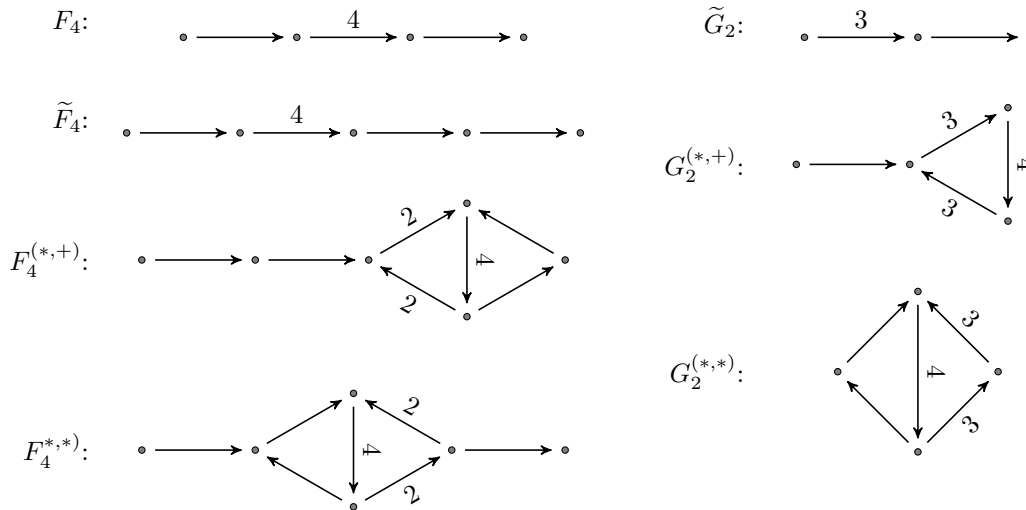

Figure 2.16: The exceptional types of mutation-finite diagrams.

**Theorem 2.5.14** ([FST12b, Thm. 5.13]). *Any mutation-finite skew-symmetrizable matrix, which is not skew-symmetric, is either the adjacency matrix of an orbifold triangulation or mutation equivalent to one of the 7 exceptional types:  $\tilde{G}_2$ ,  $F_4$ ,  $\tilde{F}_4$ ,  $G_2^{(*,+)}$ ,  $G_2^{(*,*)}$ ,  $F_4^{(*,+)}$  or  $F_4^{(*,*)}$ , shown in Figure 2.16.*

Both these results use the idea of decomposing quivers and diagrams into small building blocks which can be glued together, mirroring the idea of glueing triangulations together to construct a surface. Each block encodes a feature of the surface or orbifold, such as a triangle in the triangulation, a puncture or an orbifold point.

# Chapter 3

## Minimal mutation-infinite quivers

The work in this chapter has been published in [Law17].

### 3.1 Introduction

In [Sev07] Seven classified all minimal 2-infinite diagrams, the majority of which are mutation-equivalent to extended Dynkin diagrams or one of a small number of exceptional cases. The work by Seven on minimal 2-infinite diagrams inspired the study of minimal mutation-infinite quivers and this chapter builds on work done by Felikson, Shapiro and Tumarkin in [FST12c, Sec. 7] proving a number of useful results about minimal mutation-infinite quivers.

Minimal mutation-infinite quivers are those which belong to an infinite mutation class, but any subquiver belongs to a finite mutation class. Simply-laced diagrams from hyperbolic Coxeter simplices of finite volume have the property that any subdiagram is a Dynkin or affine Dynkin diagram and so any mutation-infinite orientation of such a diagram is minimal mutation-infinite. The motivating question behind this study is whether the family of minimal mutation-infinite quivers from orientations of hyperbolic Coxeter simplex diagrams contains all minimal mutation-infinite quivers.

In this chapter we classify all minimal mutation-infinite quivers, with classes represented by orientations of hyperbolic Coxeter simplex diagrams as well as some exceptional representatives. The classification is defined in terms of moves, which are

specific sequences of mutations. In general, mutation does not preserve the property of a quiver being minimal mutation-infinite, however the moves are constructed in such a way that they do.

**Theorem 3.5.1.** *Any minimal mutation-infinite quiver with at most 9 vertices can be transformed through sink-source mutations and at most 5 moves to either an orientation of a hyperbolic Coxeter diagram, a double arrow quiver or an exceptional quiver.*

**Theorem 3.5.2.** *Any minimal mutation-infinite quiver can be transformed through sink-source mutations and at most 10 moves to one of an orientation of a hyperbolic Coxeter diagram, a double arrow quiver or an exceptional quiver.*

The results of this chapter give a procedure to check whether any given quiver is mutation-infinite without having to compute any part of its mutation class. This procedure follows from the fact that any mutation-infinite quiver must contain a minimal mutation-infinite induced subquiver.

In Section 3.2 we recall the properties arising from mutation-equivalence of quivers, introduce minimal mutation-infinite quivers and highlight the interest behind their study. In Section 3.3 we recall the relations between quivers, diagrams and Coxeter simplices, as well as constructing quivers from orientations of certain Coxeter diagrams given by these simplices. Some examples of these quivers give minimal mutation-infinite quivers.

Section 3.5 introduces a classification of all minimal mutation-infinite quivers given by a number of elementary moves defined in Section 3.4 and listed in Appendix A.2. These moves allow minimal mutation-infinite quivers to be transformed to other minimal mutation-infinite quivers and so admit a classification of such quivers.

This classification involved a large computational effort to find all minimal mutation-infinite quivers. Appendix A.1 details the procedures used in this computation. Details about implementations of these procedures and the complete



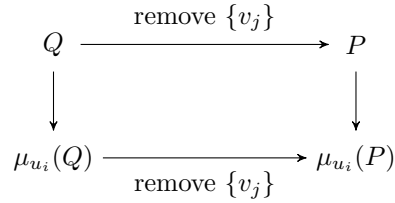

Figure 3.2: Commutative diagram showing mutations and vertex removal.

For brevity it is convenient to omit the word induced and write subquiver to mean induced subquiver. Denote the vertices of  $Q$  as  $u_1, \dots, u_m, v_1, \dots, v_n$  and let  $P$  be the subquiver of  $Q$  obtained by removing vertices  $v_1, \dots, v_n$ . Then any mutation at  $u_i$  commutes with removing these vertices  $\{v_j\}$  shown in Figure 3.2, giving the following proposition.

**Proposition 3.2.2.** *A quiver which contains some mutation-infinite quiver as a subquiver is necessarily mutation-infinite. Equivalently any subquiver of a mutation-finite quiver is mutation-finite.*

Proposition 3.2.2 shows that there are minimal mutation-infinite quivers with respect to the above partial ordering. Equivalently these minimal mutation-infinite quivers could be defined as follows:

**Definition 3.2.3.** A **minimal mutation-infinite quiver** is a mutation-infinite quiver for which every subquiver is mutation-finite.

### 3.2.2 Properties of minimal mutation-infinite quivers

In their paper on the classification of mutation-finite quivers Felikson, Shapiro and Tumarkin prove a useful fact about minimal mutation-infinite quivers.

**Theorem 3.2.4** ([FST12c, Lem. 7.3]). *Any minimal mutation-infinite quiver contains at most 10 vertices. Equivalently, any mutation-infinite quiver of size greater than 10 must contain a mutation-infinite subquiver.*

An important restriction of the minimal mutation-infinite property of quivers is that it is not preserved by mutation. An example of a mutation which does not

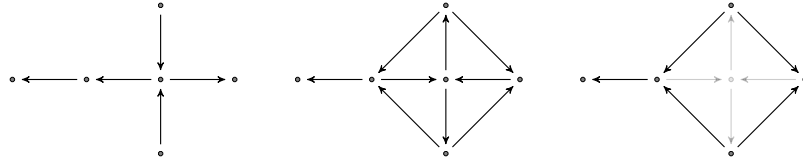

Figure 3.3: The left quiver is minimal mutation-infinite. Mutation at the central vertex yields the central quiver however this is not minimal mutation-infinite. Removing the central vertex gives the right quiver, which is also minimal mutation-infinite.

preserve the minimal mutation-infinite property of a quiver is given in Figure 3.3. However there are some specific mutations which do preserve this property, of which sink-source mutations are an example.

Recall a **sink** is a vertex in a quiver such that all adjacent arrows are directed into that vertex, whereas a **source** is a vertex such that all adjacent arrows are directed away from the vertex. **Sink-source mutation** is mutation at either a sink or a source.

**Proposition 3.2.5.** *Sink-source mutations of a quiver preserve whether it is minimal mutation-infinite or not.*

*Proof.* A mutation at a sink (resp. source) reverses the direction of all arrows adjacent to it, so the vertex becomes a source (sink).

Let  $P$  be a minimal mutation-infinite quiver, and  $Q$  a quiver obtained from  $P$  by a sink-source mutation at a vertex  $v$ . The quiver  $Q$  is mutation-equivalent to  $P$ , so is mutation-infinite. The subquiver of  $Q$  obtained by removing the mutated vertex  $v$  is precisely the same as the subquiver of  $P$  constructed by removing  $v$ . Any other subquiver of  $Q$  is a single sink-source mutation away from the corresponding subquiver of  $P$ . Every subquiver of  $P$  is mutation-finite, so every subquiver of  $Q$  is also mutation-finite, hence  $Q$  is minimal mutation-infinite.  $\square$

**Remark 3.2.6.** Any two orientations of an unoriented graph without cycles are mutation equivalent through a series of sink-source mutations by a result of [CK06], therefore if one orientation is minimal mutation-infinite then all other orientations are too. However an unoriented graph with cycles could have different orientations

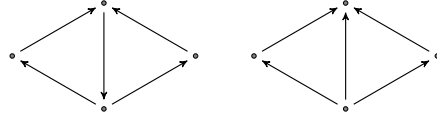

Figure 3.4: An example of different orientations of the same graph, the left quiver is mutation-finite, while the right quiver is minimal mutation-infinite.

such that one is minimal mutation-infinite and another is not. Moreover different orientations of the same graph may differ in whether they are mutation-finite, see Figure 3.4 for an example.

The following well known fact limits the possible quivers which could be minimal mutation-infinite.

**Proposition 3.2.7.** *If  $Q$  is a mutation-finite quiver with at least 3 vertices then the number of arrows between any two vertices of  $Q$  is at most 2.*

A comprehensive proof of this fact can be found in Derksen and Owen’s paper introducing previously unknown mutation-finite quivers [DO08, Sec. 3]. This is equivalent to stating that any quiver with 3 or more arrows between any two vertices is necessarily mutation-infinite.

Every subquiver of a minimal mutation-infinite quiver is mutation-finite and so each subquiver has at most 2 arrows between any two vertices. Therefore the minimal mutation-infinite quiver itself has at most 2 arrows between any two vertices.

**Proposition 3.2.8.** *Any mutation-infinite quiver with exactly 3 vertices is minimal mutation-infinite.*

*Proof.* All quivers with only 2 vertices are mutation-finite, as mutation at either vertex just reverses the direction of the arrows. Hence the mutation-class contains just these two quivers.  $\square$

### 3.3 Coxeter simplices

It is known that hyperbolic Coxeter simplices of finite volume exist up to dimension 9 and so admit diagrams with up to 10 vertices. In the following section we explore

the links between these diagrams and the minimal mutation-infinite quivers which also exist with up to 10 vertices, as stated in Theorem 3.2.4.

An  $n$ -dimensional Coxeter simplex is considered in one of three spaces: spherical, Euclidean and hyperbolic. As a simplex they are the convex hull of  $n + 1$  points and so have  $n + 1$  facets.

**Definition 3.3.1.** A simplex is a **Coxeter simplex** if the hyperplanes which make up the faces have dihedral angles all submultiples of  $\pi$ . In the case of hyperbolic Coxeter simplices we allow the case where the planes meet at the boundary and so have dihedral angle 0.

Given a Coxeter simplex we denote the hyperplanes by  $H_i$  and the angle between hyperplanes  $H_i$  and  $H_j$  by  $\frac{\pi}{k_{ij}}$ .

**Definition 3.3.2.** The **Coxeter diagram** associated to a Coxeter simplex is an unoriented graph with a vertex  $i$  for each hyperplane  $H_i$  and a weighted edge between vertices  $i$  and  $j$  when  $k_{ij} > 3$  with weight  $k_{ij}$ . We add an unweighted edge between  $i$  and  $j$  when  $k_{ij} = 3$ , and if the angle between two hyperplanes  $H_i$  and  $H_j$  is  $\frac{\pi}{2}$  then no edge is put between  $i$  and  $j$ .

In the hyperbolic case, where two hyperplanes meet at the boundary, then the edge is given weight  $\infty$ .

The Coxeter group associated to a given Coxeter diagram is constructed from the following representation, where each generator  $s_i$  represents reflection in the hyperplane  $H_i$ ,

$$\langle s_i \mid s_i^2 = 1 = (s_i s_j)^{k_{ij}} \rangle.$$

### 3.3.1 Simply-laced Coxeter simplex diagrams in different spaces

**Definition 3.3.3.** **Simply-laced** Coxeter diagrams are those where  $k_{ij} \in \{2, 3\}$  for all  $i$  and  $j$ .

This is equivalent to only allowing angles of  $\frac{\pi}{2}$  and  $\frac{\pi}{3}$  in the Coxeter simplex. Simply-laced Coxeter diagrams only contain edges with no weights, and so a quiver can be constructed from the diagram by choosing an orientation for each edge.

Coxeter simplices can be considered over spherical, Euclidean or hyperbolic space. In each case the quivers obtained by choosing an orientation for the simply-laced Coxeter diagrams have different properties. The following are well known results about the spherical and Euclidean cases.

**Remark 3.3.4.** In [Cox34], Coxeter classified simply-laced spherical Coxeter simplex diagrams as Dynkin diagrams of type  $A$ ,  $D$  and  $E$ . Orientations of these diagrams are mutation-finite quivers and give finite-type cluster algebras, as shown in Fomin and Zelevinsky's classification of finite-type cluster algebras [FZ03].

Similarly, simply-laced Euclidean Coxeter simplex diagrams are affine Dynkin diagrams of type  $\tilde{A}$ ,  $\tilde{D}$  and  $\tilde{E}$ , and orientations of these diagrams are mutation-finite but give infinite-type cluster algebras.

It is known that the hyperbolic Coxeter simplex diagrams satisfy the following property.

**Remark 3.3.5.** Any subdiagram of a simply-laced hyperbolic Coxeter simplex diagram is either a Dynkin or an affine Dynkin diagram.

This follows from e.g. Theorems 3.1 and 3.2 of Vinberg's paper [Vin85] concerning the reflection groups generated by the reflections in  $n$  hyperplanes of an  $n$  dimensional hyperbolic Coxeter simplex.

### 3.3.2 A family of minimal mutation-infinite quivers

Given a simply-laced hyperbolic Coxeter simplex diagram, as shown e.g. in [Vin93, Tables 3 and 4], construct a quiver by choosing an orientation on each edge. From Remark 3.3.5, any subquiver of this quiver will be an orientation of either a Dynkin diagram or an affine Dynkin diagram and so Remark 3.3.4 shows that any subquiver is mutation-finite.

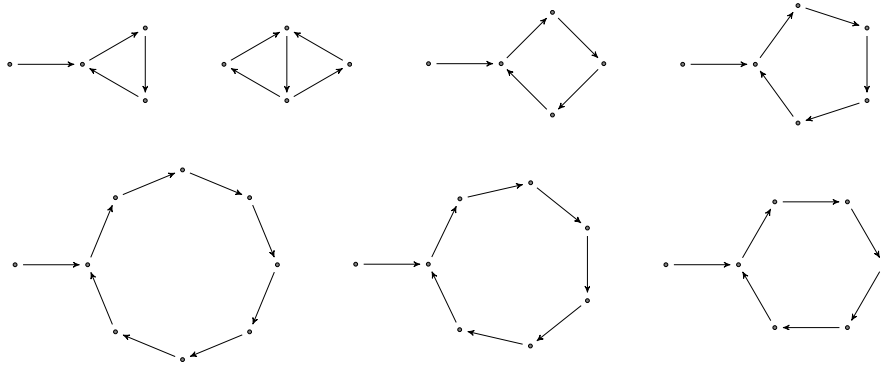

Figure 3.5: Mutation-finite orientations of hyperbolic Coxeter simplex diagrams.

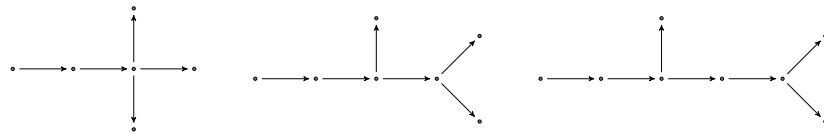

Figure 3.6: Orientations of tree-like hyperbolic Coxeter simplex diagrams of size 6, 7 and 8.

Using the classification of mutation-finite quivers given in [FST12c], it can be seen that almost all orientations of hyperbolic Coxeter simplex diagrams are mutation-infinite. The quivers shown in Figure 3.5 are mutation-finite orientations of hyperbolic Coxeter simplex diagrams, and these together with their opposite quivers are the only mutation-finite orientations.

It follows from Remarks 3.3.4 and 3.3.5 that all mutation-infinite orientations of hyperbolic Coxeter simplex diagrams are in fact minimal mutation-infinite quivers. This then raises the question of whether all minimal mutation-infinite quivers can be given in this form or not.

**Proposition 3.3.6.** *There exist minimal mutation-infinite quivers which are not orientations of a hyperbolic Coxeter simplex diagram for all sizes of quiver from 5 to 10.*

*Proof.* To prove this it suffices to give an example of such a quiver for each size. The construction of this quiver for size  $6 \leq k \leq 10$  is as follows:

Take the tree-like hyperbolic Coxeter simplex diagram of size  $k$  and orient it in such a way that all arrows point the same way as illustrated in Figure 3.6. This

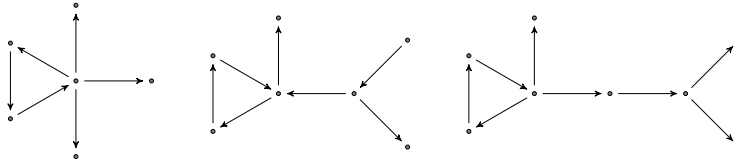

Figure 3.7: Minimal mutation-infinite quivers not orientations of hyperbolic Coxeter simplex diagrams.

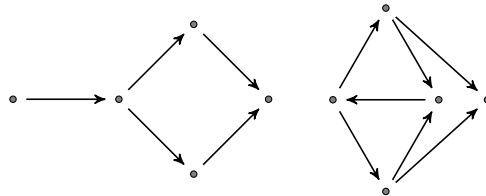

Figure 3.8: The quiver on the left is an orientation of a hyperbolic Coxeter simplex diagram. Mutation at the trivalent vertex yields the quiver on the right which is also minimal mutation-infinite.

quiver  $Q$  is minimal mutation-infinite as shown above, and contains as a subquiver the orientation of the  $A_3$  Dynkin diagram on the far left of each quiver as shown in the figure. Mutating at the centre vertex of this  $A_3$  creates an oriented triangle in the resulting quiver  $P$ , giving the quivers in Figure 3.7 which are not orientations of hyperbolic Coxeter simplex diagrams.

The resulting quiver is mutation-equivalent to the orientation of a hyperbolic Coxeter simplex, so is mutation-infinite. Each subquiver obtained by removing vertex  $n$  from  $P$  is either the same as the subquiver obtained by removing  $n$  from  $Q$ , or a single mutation away from it. Hence as  $Q$  is minimal mutation-infinite, all such subquivers are mutation-finite and so  $P$  is also minimal mutation-infinite.

The only minimal mutation-infinite quivers with 5 vertices are of the form shown in Figure 3.8. Mutation of an orientation of a hyperbolic Coxeter simplex diagram gives such a quiver, and all subquivers are mutation-equivalent to subquivers of the initial quiver so the resulting quiver is again minimal mutation-infinite.  $\square$

## 3.4 Minimal mutation-infinite quiver moves

The orientations of hyperbolic Coxeter simplex diagrams give a family of minimal mutation-infinite quivers, however Proposition 3.3.6 shows the existence of other minimal mutation-infinite quivers. This section discusses the approach taken to classify all such quivers.

Many examples of minimal mutation-infinite quivers are only a small number of mutations away from an orientation of a hyperbolic Coxeter diagram. As discussed in Subsection 3.2.2 mutations do not in general preserve the minimal mutation-infinite property of a quiver, however it can be proved that specific mutations, where a vertex is surrounded by a particular subquiver, do indeed preserve this property. An example of such a mutation was used in the proof of Proposition 3.3.6. These particular mutations which preserve the minimal mutation-infinite property can be considered as **moves** among all minimal mutation-infinite quivers.

As mutation acts by changing the quiver locally around the mutated vertex, while leaving arrows further from the vertex fixed, these moves can be defined in terms of the subquivers which change under the mutations. In this way applying the move is equivalent to replacing some subquiver with a different subquiver.

The minimal mutation-infinite preserving mutations often depend on some restriction of how the vertices in the subquivers are connected in the whole quiver outside the subquiver. This data then needs to be encoded in the moves along with the subquivers.

**Definition 3.4.1.** When referred to in a move, a **line** is a line of vertices such that one end point is connected to the move subquiver. A line of length zero consisting of just a single vertex is also considered valid.

### 3.4.1 A move example

Figure 3.9 gives an example of one such move. The move is applied to a quiver by mutating at the central vertex. The circles labelled  $X$  and  $Y$  denote connected

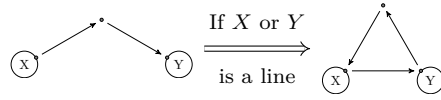

Figure 3.9: An example of a minimal mutation-infinite move.

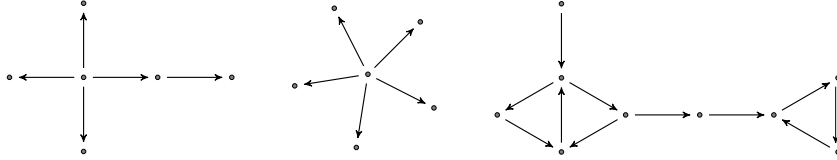

Figure 3.10: The move in Figure 3.9 applies to the first quiver, but does not apply to the others. The second quiver does not contain either subquiver, while the third does, but neither component is a line with an endpoint in the subquiver.

components of the quiver fixed by the move. The vertex on the boundary of  $X$  is considered to be contained in  $X$ . In this case the move requires that one of the components be a line (or just the single vertex) for the move to apply. Figure 3.10 shows some examples of quivers for which this move is applicable or not and Figure 3.11 shows how it acts on the first quiver in Figure 3.10.

**Proposition 3.4.2.** *The image of a minimal mutation-infinite quiver under the move in Figure 3.9 is minimal mutation-infinite.*

*Proof.* Let  $P$  be the initial quiver and  $Q$  its image under the move. Denote the vertex at which mutation occurs during the move as  $w$ .

The move is equivalent to mutation at  $w$  hence  $Q$  is in the same mutation class as  $P$ .  $P$  is mutation-infinite so  $Q$  is also mutation-infinite.

Any subquiver  $Q'$  of  $Q$ , obtained by removing a vertex  $v$  in either  $X$  or  $Y$ , will contain  $w$ . Mutating at  $w$  will yield a quiver  $\mu(Q')$  that is equal to one obtained

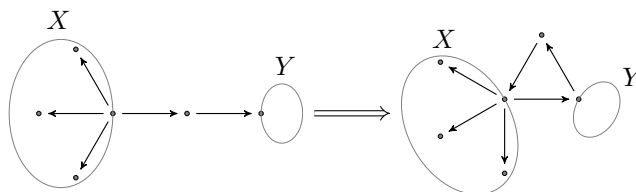

Figure 3.11: An example of how the move in Figure 3.9 changes a quiver. Note that  $Y$  consists of a single vertex, and so can be thought of as a line of length zero.

by removing the corresponding vertex  $v$  from  $P$ . As  $P$  is minimal mutation-infinite, such a subquiver of  $P$  is necessarily mutation-finite, hence  $\mu(Q')$  is mutation-finite and so  $Q'$  is also mutation-finite.

Removing  $w$  gives a subquiver  $Q'$  of  $Q$  which is not mutation-equivalent to a subquiver of  $P$ . Instead the extra condition that either  $X$  or  $Y$  is a line ensures that this quiver is a subquiver of  $P$  by removing the vertex at the end of that line, and so is mutation-finite. For example consider the quivers in Figure 3.11, removing  $w$  from  $Q$  gives a quiver which is the same as one obtained by removing the vertex in  $Y$  from  $P$ .

Hence  $Q$  is minimal mutation-infinite.  $\square$

The proofs for all moves are similar to this. The moves are always constructed from sequences of mutations, so the image is mutation-infinite and the quivers obtained by removing vertices outside those vertices which are mutated by the move can always be mutated back to a subquiver of the initial quiver. The challenge is determining whether a quiver obtained by removing a vertex at which one of the mutations took place is mutation-equivalent to a subquiver of the initial quiver.

**Proposition 3.4.3.** *The move given by reversing the move in Figure 3.9 is a valid move.*

*Proof.* As discussed above, it suffices to show that removing the vertex at which the mutation occurs yields a mutation-finite quiver. Denote the initial quiver as  $P$ , the image  $Q$  and the mutated vertex  $w$ .

Removing  $w$  from  $Q$  gives a quiver  $R$  which is the disjoint union of  $X$  and  $Y$ , therefore  $R$  is mutation-finite if and only if both  $X$  and  $Y$  are.

Both  $X$  and  $Y$  are contained in  $P$ , so are subquivers of  $P$  and hence are mutation-finite. Therefore  $R$  is also mutation-finite, so  $Q$  is minimal mutation-infinite.  $\square$

Appendix A.2 contains a list of all moves necessary to classify minimal mutation-infinite quivers. The moves required to classify all minimal mutation-infinite quivers up to size 9 only have requirements that certain components are lines or are connected

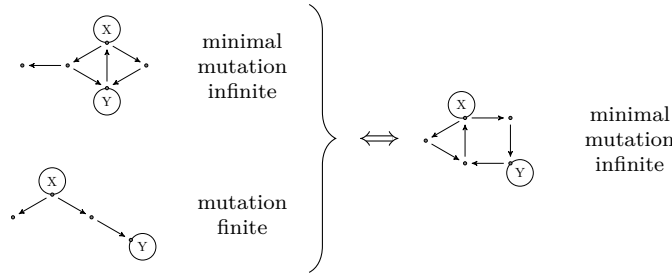

Figure 3.12: Example of a size 10 move with added constraints

to other components by lines. For the size 10 quivers, stricter conditions are required as some moves require that a certain quiver constructed from the components is mutation-finite. These moves are of the form

$$\left\{ \begin{array}{l} A \text{ is minimal mutation-infinite} \\ \text{and} \\ B \text{ is mutation-finite} \end{array} \right\} \iff \left\{ \begin{array}{l} C \text{ is minimal mutation-infinite} \\ \text{and} \\ D \text{ is mutation-finite} \end{array} \right\},$$

where  $A$  and  $C$  are rank 10 quivers,  $B$  is a subquiver of  $C$  and  $D$  is a subquiver of  $A$ . If  $A$  is minimal mutation-infinite then as a subquiver  $D$  is mutation-finite, however this is not sufficient to show that  $C$  is minimal mutation-infinite, as there is no way to determine from  $A$  whether  $B$ , a subquiver of  $C$ , is mutation-finite. If  $B$  is given to be mutation-finite then the move applies and so  $C$  is minimal mutation-infinite. On the other hand if  $C$  is minimal mutation-infinite then as a subquiver  $B$  is mutation-finite, but  $D$  cannot be shown to be mutation-finite just by considering  $C$ . The  $B$  and  $D$  quivers constructed in such a way are always of a smaller size and so the results for smaller size quivers can be applied. These moves are still involutions as, after applying the move once, the conditions are automatically satisfied to apply the same move in reverse.

Figure 3.12 gives an example of one such move for size 10 quivers. In one direction the move applies without any additional constraints, but in the other direction the move requires that a certain quiver constructed from quiver components is mutation-finite.

Rank 4:

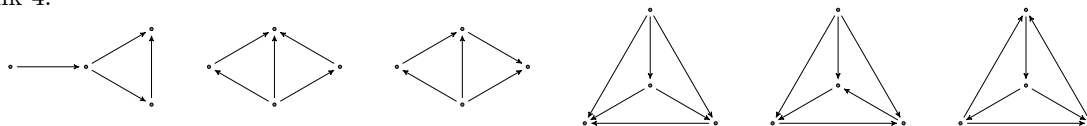

Rank 5:

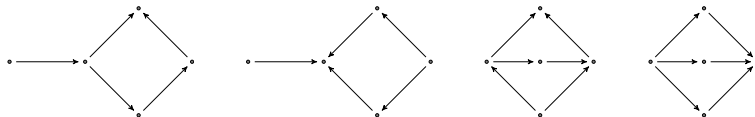

Rank 6:

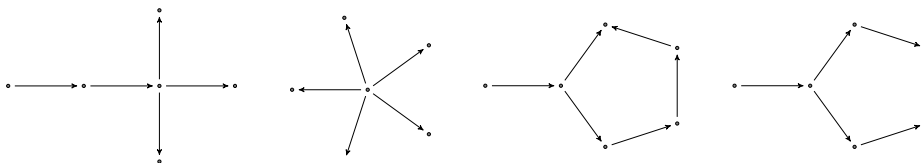

Rank 7:

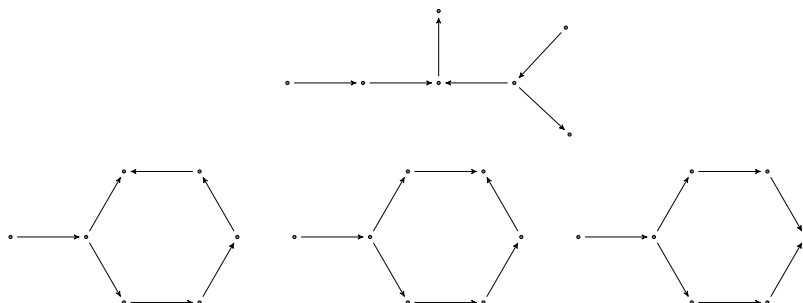

Rank 8:

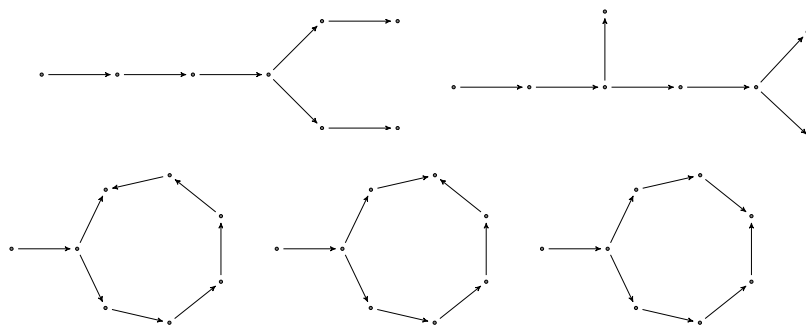

Rank 9:

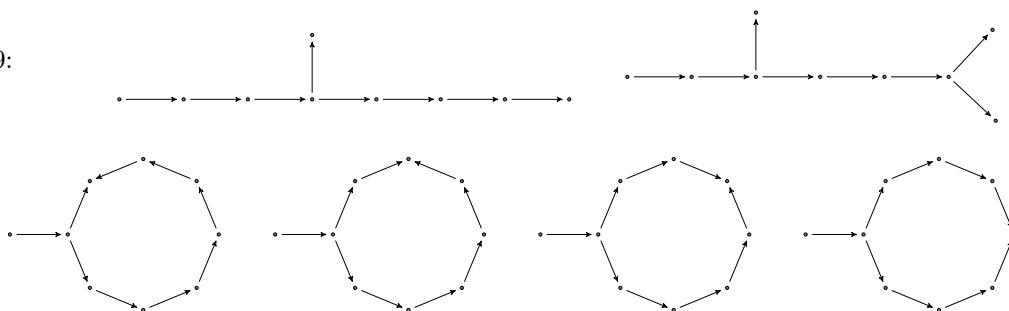

Rank 10:



Table 3.1: Representatives: Orientations of hyperbolic Coxeter simplex diagrams

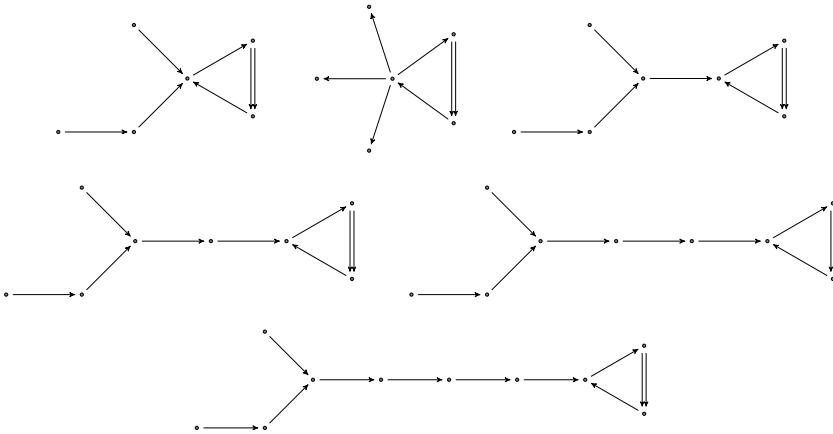

Table 3.2: Representatives: Double arrow quivers

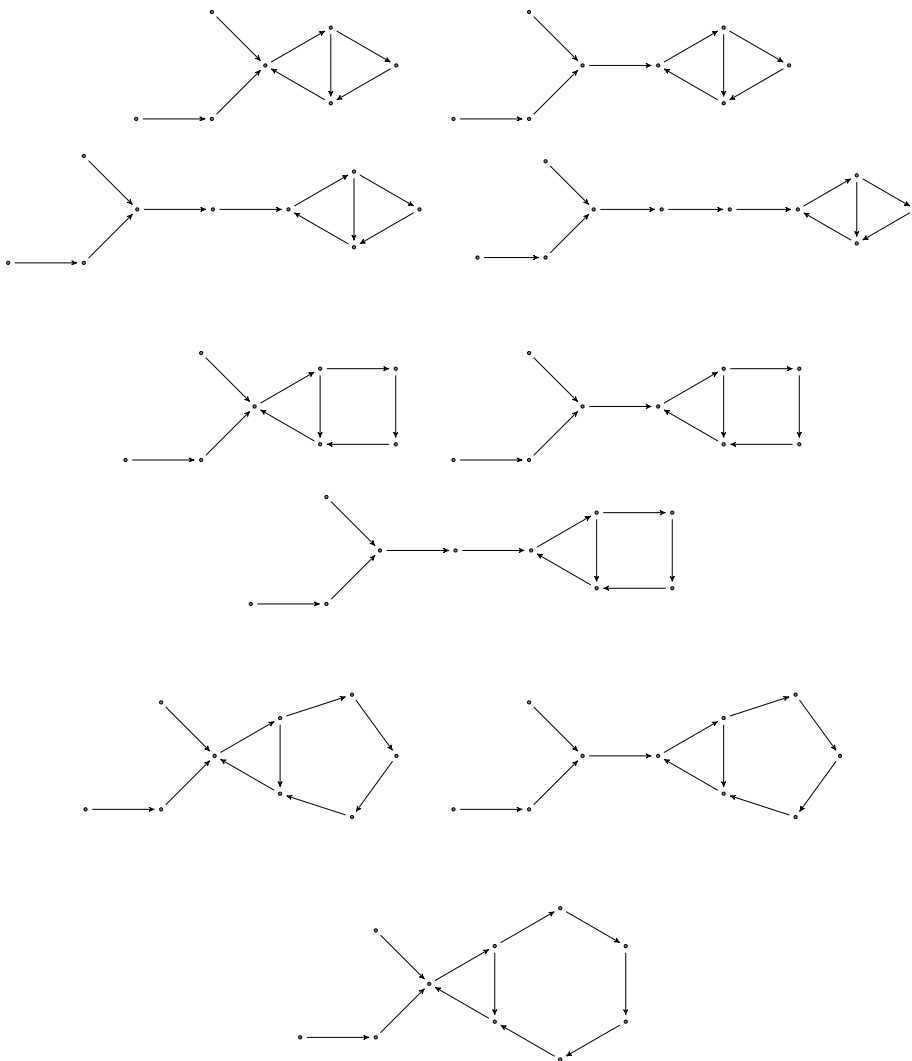

Table 3.3: Representatives: Exceptional quivers

## 3.5 Classifying minimal mutation-infinite quivers

Define an equivalence relation where two quivers are equivalent if one quiver can be obtained from the other through a sequence of moves. Then these moves together with the list of representatives (see Tables 3.1, 3.2 and 3.3) classify minimal mutation-infinite quivers.

Hyperbolic Coxeter simplex diagrams give a family of minimal mutation-infinite quivers, and so orientations of these diagrams are some of the representatives of the classes. Caldero and Keller proved that any two acyclic orientations of a diagram, belonging to the same mutation class, are mutation-equivalent through a sequence of sink-source mutations in [CK06, Cor. 4]. This means that if two acyclic orientations of a given hyperbolic Coxeter simplex diagram cannot be obtained from one another through sink-source mutations then these quivers will belong to distinct move-classes.

Many minimal mutation-infinite quivers can be transformed into one of the hyperbolic Coxeter diagrams, however there are some which can not. Therefore the classification contains hyperbolic Coxeter classes and some exceptional classes. A particular case of these exceptional cases arises from those minimal mutation-infinite quivers which contain a double arrow between two vertices. There are two such classes for quivers of size 6 and one class for each size between 7 and 10.

The result places a bound on the number of moves required to transform any minimal mutation-infinite quiver to one of the class representatives. Diagrams of the representatives can be found in Tables 3.1, 3.2 and 3.3. This statement can then be reversed to give a construction of all possible minimal mutation-infinite quivers from these representatives. The procedure to do this would be progressively applying the moves to the set of all quivers computed so far. As the number of moves is bounded this procedure will stop and at that point all minimal mutation-infinite quivers will have been computed.

**Theorem 3.5.1.** *Any minimal mutation-infinite quiver with at most 9 vertices can be transformed through sink-source mutations and at most 5 moves to one of an*

orientation of a hyperbolic Coxeter diagram, a double arrow quiver or an exceptional quiver (see Tables 3.1–3.3).

As discussed in Section 3.4 above the moves required for quivers of size 10 have more constraints and are more complicated than those for smaller quivers. As such this result needs to be restated when considering these larger quivers.

**Theorem 3.5.2.** *Any minimal mutation-infinite quiver can be transformed through sink-source mutations and at most 10 moves to one of an orientation of a hyperbolic Coxeter diagram, a double arrow quiver or an exceptional quiver (see Tables 3.1–3.3).*

Appendix A.1 discusses the computations used to verify this result and find all minimal mutation-infinite quivers. There are in total 18,799 such quivers (excluding those with 3 vertices) which are orientations of 574 different graphs. Pictures of all minimal mutation-infinite quivers organised into their move-classes can be found on the author’s website: <https://www.jwlawson.co.uk/maths/mmi/quivers>.

### 3.5.1 A deterministic mutation-infinite check using minimal mutation-infinite quivers

Any mutation-infinite quiver must contain some minimal mutation-infinite quiver as a subquiver. Hence given a list of all the minimal mutation-infinite quivers there is an algorithm to check whether a given quiver is mutation-infinite without having to compute any part of its mutation class.

Let  $Q$  be a possibly mutation-infinite quiver and  $\{P_i\}_{i \in I}$  be all minimal mutation-infinite quivers indexed by  $I$ . For each  $i \in I$  if  $P_i$  is a subquiver of  $Q$  then  $Q$  is mutation-infinite, otherwise continue to the next  $i$ . If no minimal mutation-infinite quiver is in fact a subquiver of  $Q$  then  $Q$  is mutation-finite.

# Chapter 4

## Properties of minimal mutation-infinite quivers

In the previous chapter we showed a classification of all minimal mutation-infinite quivers — those with mutation-finite subquivers but which are mutation-infinite themselves. In this chapter we consider a number of properties of these quivers and the cluster algebras generated by them.

We will show that these minimal mutation-infinite quivers admit a maximal green sequence and that the cluster algebra generated from such a quiver is equal to its upper cluster algebra. We also consider the mutation classes of these quivers, and whether the quivers in these mutation classes which have maximal green sequences form a connected component in the exchange graph.

The research in this chapter was done in collaboration with Matthew Mills, University of Nebraska-Lincoln and is contained in [LM16]. The majority of the chapter is based on joint work unless otherwise noted. The computations in Section 4.5 were completed by the author, building on results and ideas proposed by Mills. The computations in the proof of Theorem 4.6.2, that these quivers are Louise, were the work of Mills but included here for completeness.

## 4.1 Introduction

All mutation-infinite quivers of rank 3 are minimal mutation-infinite, and have been studied extensively [ABBS08; BBH11; LLM15; Mul15; Sev14] so here we primarily focus on minimal mutation-infinite quivers of rank at least 4.

Maximal green sequences are also an aspect of cluster algebras which have been widely studied, with links to scattering diagrams [BHIT15] as well as to BPS states of some quantum field theories [ACC+13]. Mills determined which mutation-finite quivers admit a maximal green sequence in [Mil16]. In this chapter we will show that every minimal mutation-infinite quiver has a maximal green sequence.

**Theorem 4.5.5.** *Suppose  $Q$  is a minimal mutation-infinite quiver of rank at least 4. Then  $Q$  has a maximal green sequence.*

Each cluster algebra has an associated upper cluster algebra, introduced by Berenstein, Fomin and Zelevinsky [BFZ05], which naturally contains its cluster algebra, but in general it is not known when the upper cluster algebra is equal to the cluster algebra. One result of [BFZ05] was to show that if a quiver was acyclic and coprime then these two algebras are equal. Muller later showed that the coprime assumption was not necessary and that the result held more generally if a quiver is locally acyclic [Mul14]. Muller and Speyer went on to identify a stronger property of quivers, called the Louise property, that implies local acyclicity as well as many other very nice properties about the cluster algebra [MS16]. We show that minimal mutation-infinite quivers also have this property.

**Theorem 4.6.2.** *If  $Q$  is a minimal mutation-infinite quiver of rank at least 4, then the quiver is Louise and its cluster algebra is locally-acyclic.*

By showing that all minimal mutation-infinite quivers are Louise it follows that the cluster algebra generated by any such quiver is equal to its upper cluster algebra.

**Corollary 4.6.3.** *If  $Q$  is a minimal mutation-infinite quiver of rank at least 4, then the cluster algebra  $\mathcal{A}(Q)$  is equal to its upper cluster algebra.*

Such a result would not be especially interesting if the minimal mutation-infinite quivers of the same rank generate the same cluster algebra, so we determine which mutation classes these quivers belong to. The different move-classes given by the classification of minimal mutation-infinite quivers in Chapter 3 groups together certain mutation-equivalent quivers and we show that most of these groups belong to different mutation classes.

**Theorems 4.4.5 and 4.4.16.** *With one exception, the move-classes of minimal mutation-infinite quivers with hyperbolic Coxeter simplex representatives or with double arrow representatives all belong to distinct mutation classes.*

As each move-class belongs to a unique mutation class, and each quiver in the move-class has a maximal green sequence, we explore which other quivers in the mutation class admit a maximal green sequence. In the rank 3 case we show that the number of such quivers is bounded.

**Theorem 4.7.2.** *For any rank 3 quiver there are at most 6 quivers (up to relabelling of the vertices) in its mutation class that admit a maximal green sequence.*

One way to visualise the mutation class is by considering the quiver exchange graph, and we use this construction to prove that in the rank 4 case those quivers which have maximal green sequences, and are obtained from mutating a minimal mutation-infinite quiver a small number of times, form a connected subgraph in the exchange graph.

**Theorem 4.7.10.** *Let  $Q$  be a minimal mutation-infinite quiver of rank 4. Then the subgraph  $\Psi$  of the quiver exchange graph  $\mathcal{E}$  containing all quivers with maximal green sequences is a proper subgraph of  $\mathcal{E}$  and the connected component  $\hat{\Psi}$  of  $\Psi$  that contains  $Q$  is finite and contains the entire move-class of  $Q$ .*

This raises a number of questions related to the arrangement of quivers with maximal green sequences in infinite quiver exchange graphs. In general it is not currently known whether the subgraph of quivers with maximal green sequences is

connected, nor whether there are a finite number of quivers with maximal green sequences in a given mutation class.

In Sections 4.3 and 4.2 we remind the reader of the basic definitions of maximal green sequences, cluster algebras and upper cluster algebras, along with a number of known results on these topics which are used throughout the chapter. Section 4.4 contains some results on the mutation classes of these quivers. In Section 4.5 we show the existence of a maximal green sequence for all minimal mutation-infinite quivers and in Section 4.6 show that their cluster algebra is equal to its upper cluster algebra. In Section 4.7 we discuss which quivers in the mutation class of rank 3 and rank 4 minimal mutation-infinite quivers have maximal green sequences, and finally in Section 4.8 we present a number of conjectures and questions which build on this work.

## 4.2 Cluster Algebras and Upper Cluster Algebras

In Chapter 2 we defined a cluster algebra for a quiver where every vertex can be mutated. We now introduce additional vertices which are frozen and cannot be mutated, variables are assigned to these vertices in the same way as to the non-frozen vertices and these frozen variables contribute to the exchange relations in mutation.

**Definition 4.2.1.** An **ice quiver**  $(Q, F)$  is a quiver  $Q$  with a subset of the vertices  $F \subset Q_0$  which are frozen, and so cannot be mutated. Typically an ice quiver will not contain any arrows between frozen vertices.

Mutation at a mutable (non-frozen) vertex is given in just the same way as before, though any arrows introduced between frozen vertices are removed.

If a quiver has  $m$  vertices, of which  $n$  are unfrozen, then the ambient field containing the cluster variables is  $\mathcal{F} = \mathbb{Q}(x_1, \dots, x_n, x_{n+1}, \dots, x_m)$

A **seed**  $\Sigma = (\tilde{\mathbf{x}}, \tilde{Q})$  is a pair where  $\tilde{\mathbf{x}} = \{\beta_1, \dots, \beta_n, \beta_{n+1}, \dots, \beta_m\}$  is an  $m$ -tuple of elements of  $\mathcal{F}$  that form a free generating set with  $\beta_k = x_k$  for  $n + 1 \leq k \leq m$ , and  $\tilde{Q}$  is an ice quiver with  $n$  mutable vertices and  $m - n$  frozen vertices.

For a seed  $(\tilde{\mathbf{x}}, \tilde{Q})$  and a specified index  $1 \leq k \leq n$ , define the **seed mutation** of  $(\tilde{\mathbf{x}}, \tilde{Q})$  at  $k$ , denoted  $\mu_k(\tilde{\mathbf{x}}, \tilde{Q})$ , to be a new seed  $(\tilde{\mathbf{x}}', \tilde{Q}')$  where  $\tilde{Q}'$  is the quiver  $\mu_k(\tilde{Q})$  defined in Definition 2.1.2 and  $\tilde{\mathbf{x}}' = \{\beta'_1, \dots, \beta'_m\}$  with

$$\beta'_j = \begin{cases} \beta_k^{-1} \left( \prod_{i \leftarrow k \in \tilde{Q}'} \beta_i + \prod_{i \rightarrow k \in \tilde{Q}'} \beta_i \right) & \text{if } j = k; \\ \beta_j & \text{otherwise.} \end{cases}$$

Note that seed mutation is an involution, so mutating  $(\tilde{\mathbf{x}}', \tilde{Q}')$  at  $k$  will return to our original seed  $(\tilde{\mathbf{x}}, \tilde{Q})$ .

Two seeds  $\Sigma_1$  and  $\Sigma_2$  are said to be **mutation-equivalent** or in the same **mutation class** if  $\Sigma_2$  can be obtained by a sequence of mutations from  $\Sigma_1$ . This is obviously an equivalence relation.

In a given seed  $(\tilde{\mathbf{x}}, \tilde{Q})$ , we call the subset  $\mathbf{x} = \{\beta_1, \dots, \beta_n\}$  the **cluster** of the seed and each element of a cluster the **cluster variables**. This emphasizes the different roles played by  $\beta_i$  ( $i \leq n$ ) and  $\beta_i$  ( $i > n$ ), where those  $\beta_i$  with  $i > n$  are linked to coefficients of the cluster algebra and are not changed by mutation. We denote

$$\mathbb{ZP} = \mathbb{Z}[x_{n+1}^{\pm 1}, \dots, x_m^{\pm 1}].$$

In the following, we shall only study cluster algebras of geometric type:

**Definition 4.2.2.** Given a seed  $(\tilde{\mathbf{x}}, \tilde{Q})$ , the **cluster algebra**  $\mathcal{A}(\tilde{\mathbf{x}}, \tilde{Q})$  of **geometric type** is the subring of  $\mathcal{F}$  generated over  $\mathbb{ZP}$  by all cluster variables appearing in all seeds that are mutation-equivalent to  $(\tilde{\mathbf{x}}, \tilde{Q})$ . The seed  $(\tilde{\mathbf{x}}, \tilde{Q})$  is called the **initial seed** of  $\mathcal{A}(\tilde{\mathbf{x}}, \tilde{Q})$ .

It follows from the definition that any seed in the same mutation class will generate the same cluster algebra up to isomorphism.

**Definition 4.2.3.** Given a cluster algebra  $\mathcal{A}$ , the **upper cluster algebra**  $\mathcal{U}$  is defined as

$$\mathcal{U} = \bigcap_{\mathbf{x}=\{\beta_1, \dots, \beta_n\}} \mathbb{Z}\mathbb{P}[\beta_1^{\pm 1}, \dots, \beta_n^{\pm 1}]$$

where  $\mathbf{x}$  runs over all clusters of  $\mathcal{A}$ .

By the Laurent Phenomenon [FZ02, Thm. 3.1] there is a natural containment  $\mathcal{A} \subseteq \mathcal{U}$ .

If a quiver  $Q$  is mutation-equivalent to an acyclic quiver we say that  $Q$  is **mutation-acyclic**. We say that the cluster algebra  $\mathcal{A}(\tilde{\mathbf{x}}, \tilde{Q})$  is **acyclic** if  $Q$  is mutation-acyclic; otherwise we say that the cluster algebra is **non-acyclic**.

**Theorem 4.2.4** ([BFZ05; Mul14]). *If  $\mathcal{A}$  is an acyclic cluster algebra, then  $\mathcal{A} = \mathcal{U}$ .*

### 4.2.1 Locally acyclic cluster algebras and the Louise property

Muller expanded this result to **locally acyclic** cluster algebras, which are those that can be covered by finitely many acyclic cluster localizations. We refer the reader to the paper [Mul13] for a full definition, but instead we recall a sufficient property, called the Louise property, which implies local acyclicity of the cluster algebra as well as many other nice properties.

**Definition 4.2.5** ([Mul13, Sec. 5.1]). If  $Q$  is an ice quiver, a **bi-infinite path** is a sequence of mutable vertices  $(i_k)_{k \in \mathbb{Z}}$  such that there is at least one arrow  $i_k \rightarrow i_{k+1}$  in the quiver for all  $k$ .

**Definition 4.2.6.** Let  $(Q, F)$  be an ice quiver. We define  $i \rightarrow j \in Q_1$  to be a **separating edge** of  $Q$  if  $i$  and  $j$  are mutable and there is no bi-infinite path through the edge  $i \rightarrow j$ .

**Definition 4.2.7** ([MS16, Def. 2.3]). Let  $V \subset Q_0$  and let  $Q[V]$  denote the induced subquiver of  $Q$  with vertex set  $V$ . The **Louise property** is then defined recursively. We say that a quiver satisfies the Louise property, or is Louise, if either

1.  $Q$  has no edges,
2. or there exists  $Q' \in \mathcal{S}(Q)$  that has a separating edge  $i \rightarrow j$ , such that the quivers  $Q'[Q'_0 \setminus \{i\}]$ ,  $Q'[Q'_0 \setminus \{j\}]$ , and  $Q'[Q'_0 \setminus \{i, j\}]$  are Louise.

A cluster algebra is Louise if it is generated by a Louise quiver.

In particular any acyclic quiver has the Louise property.

**Theorem 4.2.8** ([MS16, Prop. 2.6]). *If a cluster algebra is Louise, then it is locally acyclic.*

**Theorem 4.2.9** ([Mul14, Thm. 2]). *If  $\mathcal{A}$  is locally acyclic, then  $\mathcal{A} = \mathcal{U}$ .*

### 4.3 Maximal green sequences

Maximal green sequences were first studied by Keller in [Kel11b]. These are sequences of mutations which satisfy certain combinatorial constraints and have applications in polylogarithm identities and other topics. In the following we use the conventions established by Brüstle, Dupont and Pérotin in [BDP14].

**Definition 4.3.1** ([BDP14, Def. 2.4]). The **framed quiver** associated with a quiver  $Q$  is the ice quiver  $(\hat{Q}, Q'_0)$  such that:

$$Q'_0 = \{i' \mid i \in Q_0\}, \quad \hat{Q}_0 = Q_0 \sqcup Q'_0,$$

$$\hat{Q}_1 = Q_1 \sqcup \{i \rightarrow i' \mid i \in Q_0\}.$$

Since the frozen vertices  $Q'_0$  of the framed quiver  $(\hat{Q}, Q'_0)$  are so natural we will simplify the notation and just write  $\hat{Q}$ . Now we discuss what is meant by red and green vertices.

**Definition 4.3.2** ([BDP14, Def. 2.5]). Let  $R \in \mathcal{S}(\hat{Q})$  be a quiver in the mutation class of  $\hat{Q}$ . A mutable vertex  $i \in R_0$  is called **green** if

$$\{j' \in Q'_0 \mid \exists j' \rightarrow i \in R_1\} = \emptyset.$$

It is called **red** if

$$\{j' \in Q'_0 \mid \exists j' \leftarrow i \in R_1\} = \emptyset.$$

While it is not clear from the definition that every mutable vertex in  $R_0$  must be either red or green, this was shown to be true for quivers in [DWZ10] and was also shown to be true in a more general setting in [GHKK14].

**Theorem 4.3.3** ([DWZ10; GHKK14]). *Let  $R \in \mathcal{S}(\hat{Q})$ . Then every mutable vertex in  $R_0$  is either red or green.*

**Definition 4.3.4** ([BDP14, Def. 2.8], [Kel11b, Sec. 5.14]). A **green sequence** for  $Q$  is a sequence of vertices  $\mathbf{i} = (i_1, \dots, i_l)$  of  $Q$  such that  $i_1$  is green in  $\hat{Q}$  and for any  $2 \leq k \leq l$ , the vertex  $i_k$  is green in  $\mu_{i_{k-1}} \circ \dots \circ \mu_{i_1}(\hat{Q})$ . A green sequence  $\mathbf{i}$  is **maximal** if every mutable vertex in  $\mu_{i_l} \circ \dots \circ \mu_{i_1}(\hat{Q})$  is red.

In [BDP14], Brüstle, Dupont and Pérotin showed that a maximal green sequence preserves the quiver:

**Lemma 4.3.5** ([BDP14, Prop. 2.10]). *If  $\mathbf{i}$  is a maximal green sequence for a quiver  $Q$  then  $\mu_{\mathbf{i}}(Q)$  is isomorphic to  $Q$ .*

Therefore there is some permutation  $\sigma$  on the vertices of the quiver which maps  $\mu_{\mathbf{i}}(Q)$  to  $Q$ . This permutation is referred to as the permutation induced by  $\mathbf{i}$ .

### 4.3.1 Existence of maximal green sequences

A number of results have been proved determining when quivers can admit a maximal green sequence.

**Lemma 4.3.6** ([BDP14, Prop. 2.5]). *A quiver  $Q$  has a maximal green sequence if and only if its opposite quiver  $Q^{op}$  has a maximal green sequence.*

We call a quiver  $Q$  **acyclic** if there are no oriented cycles in  $Q$ . Any such quiver contains at least one source vertex, which is not the target of any arrows.

**Theorem 4.3.7** ([BDP14, Lem. 2.20]). *If a quiver is acyclic, then it has a maximal green sequence. In particular, a maximal green sequence can always be found by repeatedly mutating at sources.*

In [Mul15], Muller uses the relationship between maximal green sequences and paths in scattering diagrams to study green sequences of induced subquivers.

**Theorem 4.3.8** ([Mul15, Thm. 1.4.1]). *If  $Q$  admits a maximal green sequence, then any induced subquiver has a maximal green sequence.*

Using this one can prove a quiver does not admit a maximal green sequence by finding an induced subquiver which does not admit a maximal green sequence. However there are examples of quivers which do not have a maximal green sequence whereas every induced subquiver does.

At the same time, Muller shows that the existence of maximal green sequences is not an invariant under mutation [Mul15, Sec. 2], so one quiver in a mutation class could admit a maximal green sequence while another might not. Mills shows in [Mil16] that in the case of mutation-finite quivers this does not occur, and in fact only very specific mutation classes of quivers do not admit maximal green sequences.

**Theorem 4.3.9** ([Mil16, Thm. 3]). *Let  $Q$  be a mutation-finite quiver, then  $Q$  has no maximal green sequence if and only if  $Q$  arises from a triangulation of a once-punctured closed surface or is one of the two quivers in the mutation class of  $\mathbb{X}_7$ .*

In [BHIT15], Brüstle, Hermes, Igusa and Todorov build a series of results showing how c-vectors and c-matrices change as mutations are applied along a maximal green sequence. These results allow the authors to construct a maximal green sequence for any quiver which appears as an intermediary of the initial maximal green sequence.

**Theorem 4.3.10** (Rotation Lemma [BHIT15, Thm. 3]). *If  $\mathbf{i} = (i_1, i_2, \dots, i_\ell)$  is a maximal green sequence of a quiver  $Q$  with induced permutation  $\sigma$ , then the sequence  $(i_2, \dots, i_\ell, \sigma^{-1}(i_1))$  is a maximal green sequence for the quiver  $\mu_{i_1}(Q)$  with the same induced permutation  $\sigma$ .*

A maximal green sequence is a cycle in the quiver exchange graph, and the rotation lemma shows that this cycle always gives a maximal green sequence for any quiver appearing in that cycle. The statement above rotates in only one direction, however this direction can be reversed:

**Theorem 4.3.11** (Reverse Rotation Lemma). *If  $\mathbf{i} = (i_1, i_2, \dots, i_{\ell-1}, i_\ell)$  is a maximal green sequence of a quiver  $Q$  with induced permutation  $\sigma$ , then the sequence  $(\sigma(i_\ell), i_1, i_2, \dots, i_{\ell-1})$  is a maximal green sequence for the quiver  $\mu_{\sigma(i_\ell)}(Q)$  with the same induced permutation  $\sigma$ .*

*Proof.* Applying the rotation lemma  $\ell - 1$  times gives that  $(i_\ell, \sigma^{-1}(i_1), \dots, \sigma^{-1}(i_{\ell-1}))$  is a maximal green sequence for  $\mu_{i_{\ell-1}} \cdots \mu_{i_2} \mu_{i_1}(Q)$ . As  $\sigma$  is the induced permutation for  $\mathbf{i}$ , we have  $\sigma(\mu_{\mathbf{i}}(Q)) = Q$ , so  $\mu_{\mathbf{i}}(Q) = \mu_{i_\ell} \mu_{i_{\ell-1}} \cdots \mu_{i_1}(Q) = \sigma^{-1}(Q)$  and therefore

$$\mu_{i_{\ell-1}} \cdots \mu_{i_1}(Q) = \mu_{i_\ell}(\sigma^{-1}(Q)) = \sigma^{-1}(\mu_{\sigma(i_\ell)}(Q)).$$

Hence  $(i_\ell, \sigma^{-1}(i_1), \dots, \sigma^{-1}(i_{\ell-1}))$  is a maximal green sequence for  $\sigma^{-1}(\mu_{\sigma(i_\ell)}(Q))$  and by applying  $\sigma$  to both the sequence of vertices and to the quiver, we get that  $(\sigma(i_\ell), i_1, i_2, \dots, i_{\ell-1})$  is a maximal green sequence for  $\mu_{\sigma(i_\ell)}(Q)$ .  $\square$

### 4.3.2 Direct sums of quivers

Garver and Musiker showed in [GM14] that if a quiver  $Q$  can be written as a direct sum of quivers, where each summand has a maximal green sequence, then  $Q$  has a maximal green sequence itself. Throughout this subsection we assume that  $(Q, F)$  and  $(Q', F')$  are finite ice quivers with vertices labelled  $Q_0 \setminus F = \{1, \dots, N_1\}$  and  $Q'_0 \setminus F' = \{N_1 + 1, \dots, N_1 + N_2\}$ .

**Definition 4.3.12** ([GM14, Def. 3.1]). Let  $(a_1, \dots, a_k)$  denote a  $k$ -tuple of elements from  $Q_0 \setminus F$  and  $(b_1, \dots, b_k)$  denote a  $k$ -tuple of elements from  $Q'_0 \setminus F'$ . Then for any ice quivers  $(R, F) \in \mathcal{S}((Q, F))$  and  $(R', F') \in \mathcal{S}((Q', F'))$  we define the **direct sum** of  $(R, F)$  and  $(R', F')$ , denoted  $(R, F) \oplus_{(a_1, \dots, a_k) \atop (b_1, \dots, b_k)} (R', F')$ , to be the ice quiver

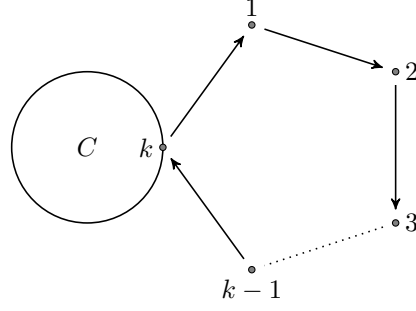

Figure 4.1: The decomposition of a quiver  $Q$  into a  $k$ -cycle, with vertices  $1, \dots, k$ , and an induced subquiver  $C$ , as described in Theorem 4.3.14.

with vertices

$$\left( (R, F) \oplus_{(a_1, \dots, a_k)}^{(b_1, \dots, b_k)} (R', F') \right)_0 = R_0 \sqcup R'_0$$

and edges

$$\left( (R, F) \oplus_{(a_1, \dots, a_k)}^{(b_1, \dots, b_k)} (R', F') \right)_1 = (R, F)_1 \sqcup (R', F')_1 \sqcup \{a_i \rightarrow b_i \mid i = 1, \dots, k\}.$$

We say that  $(R, F) \oplus_{(a_1, \dots, a_k)}^{(b_1, \dots, b_k)} (R', F')$  is a  $t$ -**colored direct sum** if  $t = \#\{\text{distinct elements of } \{a_1, \dots, a_k\}\}$  and there does not exist  $i$  and  $j$  such that

$$\#\{a_i \rightarrow b_j\} \geq 2.$$

**Theorem 4.3.13** ([GM14, Thm. 3.12]). *Let  $Q = Q' \oplus_{(a_1, \dots, a_k)}^{(b_1, \dots, b_k)} Q''$  be a  $t$ -colored direct sum of quivers. If  $(i_1, \dots, i_r)$  is a maximal green sequences for  $Q'$  and  $(j_1, \dots, j_s)$  is a maximal green sequence for  $Q''$ , then  $(i_1, \dots, i_r, j_1, \dots, j_s)$  is a maximal green sequence for  $Q$ .*

### 4.3.3 Quivers ending with $k$ -cycles

Direct sums give a method to construct maximal green sequences by decomposing a quiver into disjoint induced subquivers. Another approach involves considering oriented  $k$ -cycles appearing in the quiver.

**Theorem 4.3.14.** *Let  $Q$  be a quiver containing an oriented  $k$ -cycle with vertices labelled  $1, \dots, k$ , where each vertex  $1, \dots, k-1$  is only adjacent to two arrows, one from the vertex preceding it in the cycle and one to the next vertex in the cycle,*

as shown in Figure 4.1. Let  $C = Q[Q_0 \setminus \{1, \dots, k-1\}]$  be the induced subquiver obtained by removing the vertices in the  $k$ -cycle, excluding vertex  $k$ . Then  $Q$  has a maximal green sequence if and only if  $C$  has a maximal green sequence.

In particular, if  $Q$  contains a 3-cycle in this form, such that if  $\mathbf{i}_C$  is a maximal green sequence for  $C$ , then  $(2, \mathbf{i}_C, 1, 2)$  is a maximal green sequence for  $Q$ .

*Proof.* Clearly if the subquiver  $C$  does not admit a maximal green sequence then by Theorem 4.3.8 the full quiver  $Q$  cannot either, so assume that  $C$  does admit a maximal green sequence.

The mutated quiver  $Q' = \mu_2 \circ \mu_3 \circ \dots \circ \mu_{k-1}(Q)$  can be decomposed into the direct sum of  $C$  and a quiver of type  $A_{k-1}$ :

$$Q' = C \oplus_k^2 (1 \leftarrow 2 \rightarrow 3 \rightarrow \dots \rightarrow k-1).$$

The sequence  $(1, \dots, k-1, 1, k-1, k-2, \dots, 3)$  is a maximal green sequence for this type  $A_{k-1}$  quiver with induced permutation  $\sigma_A = ((k-1) (k-2) \dots 2 1)$  which shifts the index of each vertex down one, modulo  $k-1$ . By assumption  $C$  has maximal green sequence  $\mathbf{i}_C$  with induced permutation  $\sigma_C$ , so Theorem 4.3.13 shows that  $(\mathbf{i}_C, 1, \dots, k-1, 1, k-1, \dots, 3)$  is a maximal green sequence for  $Q'$  with induced permutation  $\sigma = \sigma_C \circ \sigma_A$ . As  $1, \dots, k-1$  are not in the vertex set of  $C$ , its restriction  $\sigma|_{1, \dots, k-1} = \sigma_A$  so by the reverse rotation lemma, Theorem 4.3.11,

$$(k-1, \dots, 2, \mathbf{i}_C, 1, 2, \dots, k-1)$$

is a maximal green sequence for  $\mu_{k-1} \dots \mu_2(\mu_2 \dots \mu_{k-1}(Q)) = Q$ .

In the case when  $k = 3$  then the maximal green sequence is  $(2, \mathbf{i}_C, 1, 2)$  as claimed.  $\square$

To allow us to easily refer to quivers of the form required in Theorem 4.3.14 and illustrated in Figure 4.1 we say such quivers **end in a  $k$ -cycle**.

## 4.4 On the mutation class of minimal mutation-infinite quivers

Minimal mutation-infinite quivers were first studied by Felikson, Shapiro and Tumar-kin in [FST12c, Sec. 7], where such quivers were shown to exist only up to rank 10. All such quivers were later classified in [Law17] into a number of move-classes, each of which has a distinguished representative as either an orientation of a hyperbolic Coxeter simplex diagram, a double arrow quiver or one of the exceptional quivers.

**Definition 4.4.1** ([Law17, Sec. 4]). A **minimal mutation-infinite move** is a sequence of mutations of a minimal mutation-infinite quiver which preserves the property of being minimal mutation-infinite. As such the image of any minimal mutation-infinite quiver under a move is another minimal mutation-infinite quiver.

These moves then classify all minimal mutation-infinite quivers under the equivalence relation where two minimal mutation-infinite quivers are move-equivalent if there is a sequence of moves taking one quiver to the other.

**Definition 4.4.2.** A **move-class** of a minimal mutation-infinite quiver is the equivalence class under this relation containing that quiver.

All minimal mutation-infinite quivers belong to one of 47 move-classes, which have representatives given in Figures 3.1, 3.2 and 3.3 as described in Section 3.5 and [Law17, Sec. 5].

In this section we show which move-classes are mutation-acyclic and which are not mutation-acyclic. We also use this information together with another mutation invariant to show that many of the move-classes generate distinct mutation classes.

### 4.4.1 Hyperbolic Coxeter simplex representatives

We now determine if distinct move-classes of minimal mutation-infinite quivers with hyperbolic Coxeter representatives belong to the same mutation class.

Recall that for a rank  $n$  quiver  $Q$  we associate an  $n \times n$  matrix  $B_Q = (b_{ij})$ , where  $b_{ij} = 0$  if  $i = j$  and otherwise  $b_{ij}$  is the number of edges  $i \rightarrow j \in Q_1$ . Note that if  $i \rightarrow j \in Q_1$  then  $b_{ji} < 0$ .

It was shown in [BFZ05, Lem. 3.2] that for a quiver  $Q$  the rank of the matrix  $B_Q$  is preserved by mutation and hence is an invariant of the mutation class of  $Q$ . We use the rank of the matrix  $B_Q$  and the number of acyclic quivers in the mutation class to distinguish the mutation classes of minimal mutation-infinite quivers.

**Theorem 4.4.3** ([CK06, Cor. 4]). *The set of acyclic quivers form a connected subgraph of the exchange graph. Furthermore, if  $Q$  is an acyclic quiver, then every acyclic quiver in  $\mathcal{S}(Q)$  can be obtained from  $Q$  by a sequence of sink/source mutations.*

**Corollary 4.4.4.** *There are finitely many acyclic quivers in any mutation class.*

*Proof.* Clearly a sink/source mutation preserves the underlying graph of a quiver and there are only finitely many orientations of this graph. Therefore the number of these orientations that are acyclic is also finite.  $\square$

**Theorem 4.4.5.** *Mutating the sixth rank 4 quiver in Table 3.1 at the top vertex yields the first rank 4 quiver, so both of their move-classes are in the same mutation class. For the rest of the move-classes of minimal mutation-infinite quivers that are represented by an orientation of a hyperbolic Coxeter simplex diagram, each move-class determines a distinct mutation class.*

*Proof.* The result follows from comparing the  $B$ -matrix rank, quiver rank, and number of acyclic seeds in the mutation class. The values of these statistics are given in Table B.1 and Table B.2 in Appendix B.1. The fourth rank 4 quiver is shown to be not mutation-acyclic in Theorem 4.4.11.  $\square$

#### 4.4.2 Admissible quasi-Cartan companion matrices

While all but one of the Coxeter simplex move-classes are mutation-acyclic, the double arrow move-classes are not, and therefore these move-classes cannot belong

to the same mutation classes as those of the Coxeter simplex representatives. The proof that a quiver is not mutation-acyclic relies heavily on the idea of admissible quasi-Cartan companions introduced by Seven in [Sev11] building on work by Barot, Geiss and Zelevinsky [BGZ06].

**Definition 4.4.6** ([BGZ06, Sec. 1]). Let  $B = (b_{i,j})$  be a skew-symmetric matrix representing a quiver  $Q$  of rank  $n$ . A **quasi-Cartan companion** of  $Q$  is a symmetric matrix  $A = (a_{i,j})$  such that  $a_{i,i} = 2$  for  $i = 1, \dots, n$  and  $|a_{i,j}| = |b_{i,j}|$  for  $i \neq j$ .

**Definition 4.4.7** ([Sev15, Sec. 1]). A **cycle**  $Z$  in a quiver  $Q$  is an induced subquiver of  $Q$  whose vertices can be labelled by elements of  $\mathbb{Z}/k\mathbb{Z}$  so that the only edges appearing in  $Z$  are  $\{i, i + 1\}$  for  $i \in \mathbb{Z}/k\mathbb{Z}$ .

**Definition 4.4.8** ([Sev11, Def. 2.10]). A quasi-Cartan companion  $A = (a_{i,j})$  of a quiver  $Q$  is **admissible** if for any cycle  $Z$  in  $Q$ , if  $Z$  is an oriented (respectively, non-oriented) cycle then there are an odd (resp., even) number of edges  $\{i, j\}$  in  $Z$  such that  $a_{i,j} > 0$ .

A quasi-Cartan companion of a quiver can be thought of as assigning signs (either  $+$  or  $-$ ) to the edges of a quiver, determined by whether  $a_{i,j} > 0$  or  $< 0$ . This labelling of the edges is admissible if the number of  $+$ 's in an oriented (resp., non-oriented) cycle is odd (even).

**Lemma 4.4.9** ([Sev11, Thm. 2.11]). *If  $A$  and  $A'$  are two admissible quasi-Cartan companions of a quiver  $Q$ , then they can be obtained from one another by a sequence of simultaneous sign changes in rows and columns.*

As a row and column in the matrix corresponds to a vertex in the quiver, this simultaneous sign change at row and column  $k$  is equivalent to flipping the signs on all edges in the quiver adjacent to vertex  $k$ .

**Theorem 4.4.10** ([Sev15, Thm. 1.2]). *If  $Q$  is a mutation-acyclic quiver, then  $Q$  has an admissible quasi-Cartan companion.*

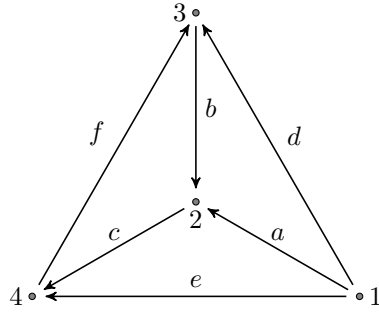

Figure 4.2: Minimal mutation-infinite representative not mutation-equivalent to any acyclic quiver.

We are now ready to show that the fourth rank 4 minimal mutation-infinite quiver, shown in Figure 4.2, is not mutation-acyclic.

**Theorem 4.4.11.** *The minimal-mutation infinite quiver  $Q$  depicted in Figure 4.2 does not have any admissible quasi-Cartan companion, and is hence not mutation-acyclic.*

**Remark 4.4.12.** This quiver was known to not have any admissible quasi-Cartan companion by Seven, and used as an example of such a quiver in [Sev15], however he does not provide a proof of this, so we include one here.

*Proof.* Assume the edges and vertices of  $Q$  are labelled as in Figure 4.2, and that the quiver has an admissible quasi-Cartan companion. We now use Lemma 4.4.9 to canonically label the edges of  $Q$ , up to flipping the signs at vertices.

The triangle  $(2, 3, 4)$  in  $Q$  is oriented, so must have an odd number of edges labelled  $+$ , in particular it must have at least one  $+$ . By flipping vertices 3 and 4 we can ensure that the label of  $f$  is  $+$ . Then, either  $b$  and  $c$  are both  $+$  or are both  $-$ , and by flipping 2 we can choose them to be  $+$ . So far we have  $a, b$  and  $c$  are all  $+$  and we have fixed or flipped vertices 1, 2 and 5.

Now the two non-oriented triangles  $(1, 2, 4)$  and  $(1, 2, 3)$  require an even number of  $+$ 's, while they each already have at least one. Hence either  $d$  and  $e$  are both  $+$  and  $a$  is  $-$  or  $d$  and  $e$  are both  $-$  and  $a$  is  $+$ . By flipping 1 we can choose the former. We have now fixed or flipped all vertices and have assigned the only possible labels to all the edges, up to flipping the signs at vertices.

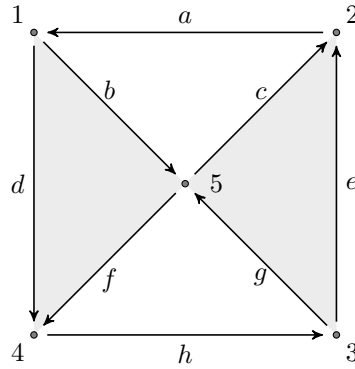

Figure 4.3: Quiver which does not have an admissible quasi-Cartan companion. The vertices are labelled  $1, \dots, 5$  and the edges  $a, \dots, h$ . Non-oriented cycles are shaded gray.

However we now have a non-oriented cycle  $(1, 3, 4)$  which contains three  $+$ 's, which gives a contradiction as a non-oriented cycle must have an even number of positive edges in an admissible companion. Hence  $Q$  cannot admit an admissible quasi-Cartan companion and so by Theorem 4.4.10 cannot be mutation-acyclic.  $\square$

#### 4.4.3 Double arrow minimal mutation-infinite quivers

We use a similar approach to show that the move-classes with double arrow representatives are not mutation-acyclic. It then follows that the mutation classes of double arrow representatives are distinct from the mutation classes of the minimal mutation-infinite quivers with hyperbolic Coxeter representatives.

**Lemma 4.4.13** ([BMR08, Cor. 5.3]). *If  $Q$  is mutation-acyclic, then any induced subquiver of  $Q$  is also mutation-acyclic.*

**Lemma 4.4.14.** *The quiver  $Q$  depicted in Figure 4.3 does not have any admissible quasi-Cartan companion, and is hence not mutation-acyclic.*

*Proof.* This proof proceeds as for Theorem 4.4.11. As before, assume the edges and vertices of  $Q$  are labelled as in Figure 4.3, and that the quiver has an admissible quasi-Cartan companion.

The triangle  $(1, 5, 2)$  in  $Q$  is oriented, so must have an odd number of edges labelled  $+$ , in particular it must have at least one  $+$ . By flipping vertices 1 and 2,

as in Lemma 4.4.9, we can ensure that the label of  $a$  is  $+$ . Then, either  $b$  and  $c$  are both  $+$  or are both  $-$ , and by flipping 5 we can choose them to be  $+$ .

Now the two non-oriented triangles  $(1, 4, 5)$  and  $(2, 3, 5)$  require an even number of  $+$ 's, while they each already have at least one. Hence one of  $d$  or  $f$  is  $+$  and the other is  $-$ , and the same for  $e$  and  $g$ . By flipping 4 and 3 we can choose that  $f$  and  $g$  are  $+$  while  $d$  and  $e$  are  $-$ . This leaves the oriented triangle  $(3, 5, 4)$  with two  $+$ 's, but it requires an odd number of positives, so  $h$  must also be  $+$ . We have now fixed or flipped all vertices and have assigned the only possible labels to all the edges, up to flipping the signs at vertices.

However the oriented cycle  $(1, 2, 3, 4)$  now contains two  $+$ 's and two  $-$ 's, which gives a contradiction as any oriented cycle must have an odd number of positive edges in an admissible companion. Hence  $Q$  cannot admit an admissible quasi-Cartan companion and so by Theorem 4.4.10 cannot be mutation-acyclic.  $\square$

**Lemma 4.4.15.** *Each double arrow representative is mutation-equivalent to a quiver containing the quiver depicted in Figure 4.3 as an induced subquiver. Hence each double arrow move-class is not mutation-acyclic.*

*Proof.* Figure 4.4 shows a mutation sequence for each of the double arrow representatives which results in a quiver containing the quiver shown in Figure 4.3 as an induced subquiver. Lemma 4.4.14 shows that this subquiver is not mutation-acyclic, so by Lemma 4.4.13 each full quiver cannot be mutation-acyclic. Hence each double arrow representative is mutation-equivalent to a quiver which is not mutation-acyclic, so are themselves not mutation-acyclic.  $\square$

**Theorem 4.4.16.** *With the single exception given in Theorem 4.4.5 the move-classes of minimal mutation-infinite quivers with hyperbolic Coxeter simplex diagram representatives or double arrow representatives all belong to distinct mutation classes.*

*Proof.* Theorem 4.4.5 shows that all Coxeter simplex move-classes of rank greater than 4 belong to distinct mutation classes, and these mutation classes contain acyclic

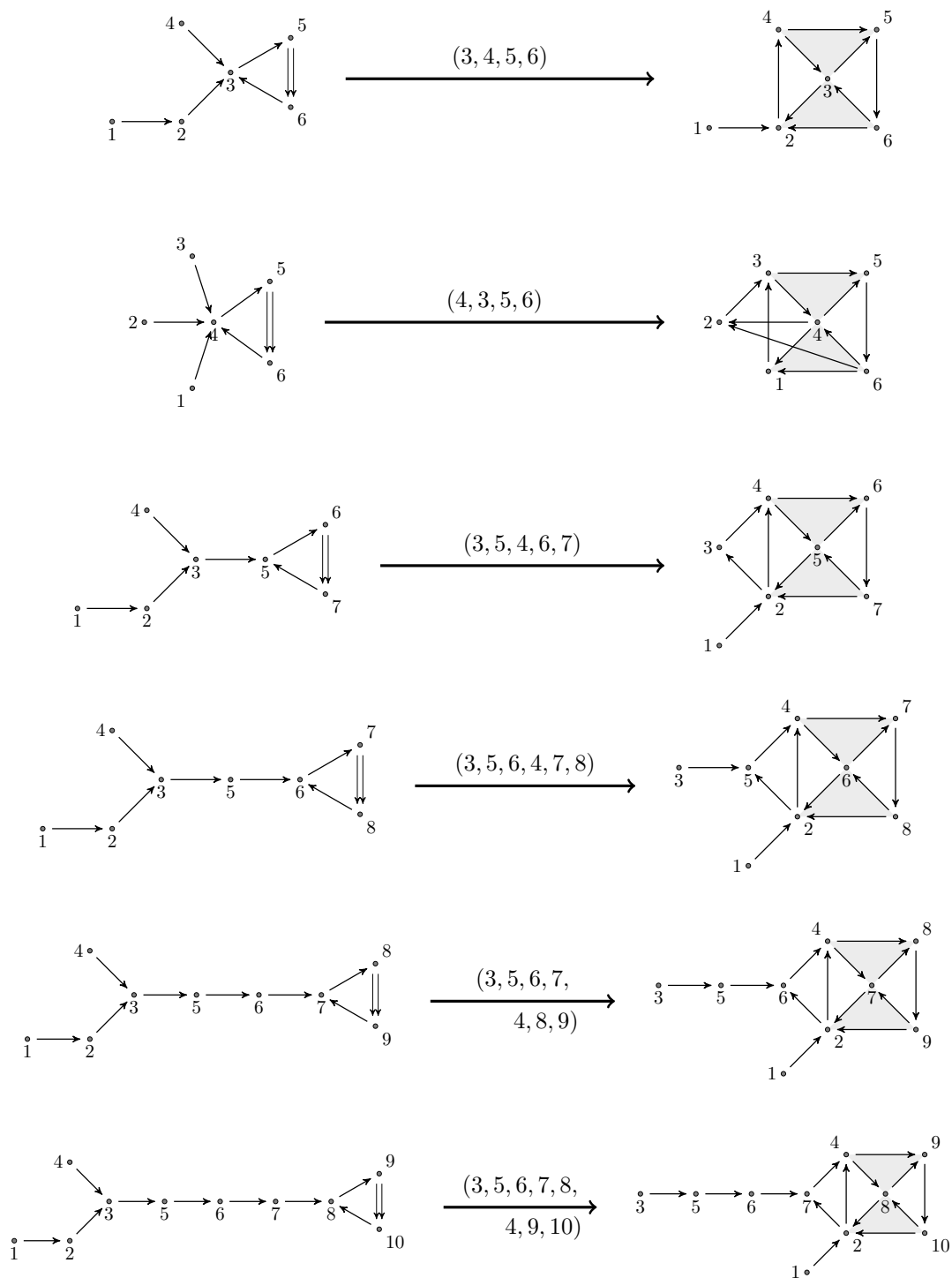

Figure 4.4: Mutation sequences for each double arrow representative shown in Table 3.2. The resulting quiver contains the quiver shown in Figure 4.3 which is not mutation-acyclic, so each double arrow representative is itself not mutation-acyclic.

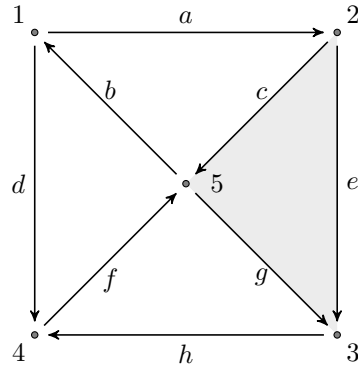

Figure 4.5: Quiver which does not have an admissible quasi-Cartan companion. The vertices are labelled  $1, \dots, 5$  and the edges  $a, \dots, h$ . The non-oriented cycle is shaded gray.

quivers. The double arrow representatives all have rank  $> 4$  and Lemma 4.4.15 shows that all the double arrow move-classes are not mutation-acyclic, and therefore belong to different mutation classes to any of the Coxeter simplex classes. Furthermore, all of the double arrow move-classes have a different number of vertices except for the two move-classes of rank 6. However, as shown in Table B.3 in Appendix B.1 these move-classes have different  $B$ -matrix rank so they cannot be mutation equivalent.  $\square$

#### 4.4.4 Exceptional minimal mutation-infinite quivers

We now repeat the argument used for double arrow move-classes to show that the mutation classes of the minimal mutation-infinite quivers are not mutation-acyclic. This allows us to distinguish the exceptional type classes from the classes whose representative is an orientation of a hyperbolic Coxeter diagram, but it does nothing to distinguish them from the double arrow representatives. We were unable to find an invariant that differentiates the mutation-classes of the double arrow representatives and the exceptional representatives. We were also unable to distinguish some of the exceptional move-classes from other exceptional move-classes of the same rank.

**Lemma 4.4.17.** *The quiver  $Q$  depicted in Figure 4.5 does not have any admissible quasi-Cartan companion, and is hence not mutation-acyclic.*

*Proof.* The proof proceeds in the same way as Theorem 4.4.11. Again, assume the edges and vertices of  $Q$  are labelled as in Figure 4.5, and that the quiver has an

admissible quasi-Cartan companion.

The triangle  $(2, 3, 5)$  in  $Q$  is non-oriented, so must have an even number of edges labelled  $+$ , in particular it must have either one  $+$  or three  $+$ 's. By flipping or fixing vertices 2, 3, and 5, as in Lemma 4.4.9, we can ensure that all of the labels  $c, e$ , and  $g$  are  $-$ .

The oriented triangles  $(1, 2, 5)$  and  $(3, 4, 5)$  each require an odd number of  $+$ 's, while they each already have one  $-$ . Hence one of  $a$  or  $b$  is  $+$  and the other is  $-$ , and the same for  $h$  and  $f$ . By flipping 1 and 4 we can choose that  $a$  and  $h$  are  $+$  while  $b$  and  $f$  are  $-$ . This leaves the oriented triangle  $(1, 4, 5)$  with  $d$  labelled by a  $+$  since it requires an odd number of positives. In this way we have assigned the only possible labels to all the edges, up to flipping the signs at vertices.

However we now have a non-oriented cycle  $(1, 2, 3, 4)$  which contains three  $+$ 's and one  $-$ , which gives a contradiction as a non-oriented cycle must have an odd number of positive edges in an admissible companion. Hence  $Q$  cannot admit an admissible quasi-Cartan companion and so by Theorem 4.4.10 cannot be mutation-acyclic.  $\square$

**Lemma 4.4.18.** *Each exceptional representative is mutation-equivalent to a quiver containing the quiver depicted in Figure 4.5 as an induced subquiver. Hence each exceptional move-class is not mutation-acyclic.*

*Proof.* The proof is identical to that of Lemma 4.4.15 with Lemma 4.4.17 in place of Lemma 4.4.14 and Figures 4.6 and 4.7 in place of Figure 4.4.  $\square$

## 4.5 Maximal green sequences for minimal mutation-infinite quivers

Building on [Mil16] we consider when minimal mutation-infinite quivers have maximal green sequences.

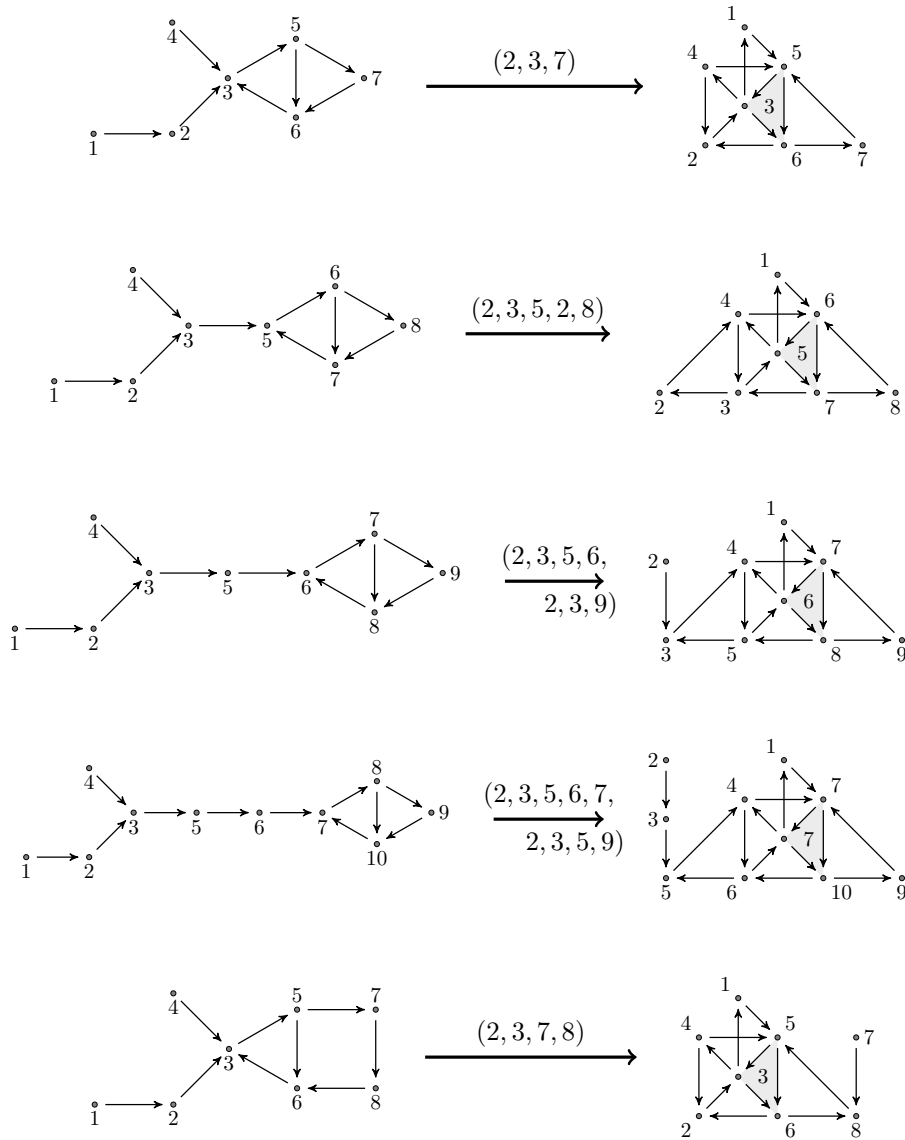

Figure 4.6: Mutation sequences for the first 5 exceptional representatives shown in Table 3.3. The other 5 are shown in Figure 4.7. The resulting quiver contains the quiver shown in Figure 4.5 which is not mutation-acyclic, so each exceptional representative is itself not mutation-acyclic.

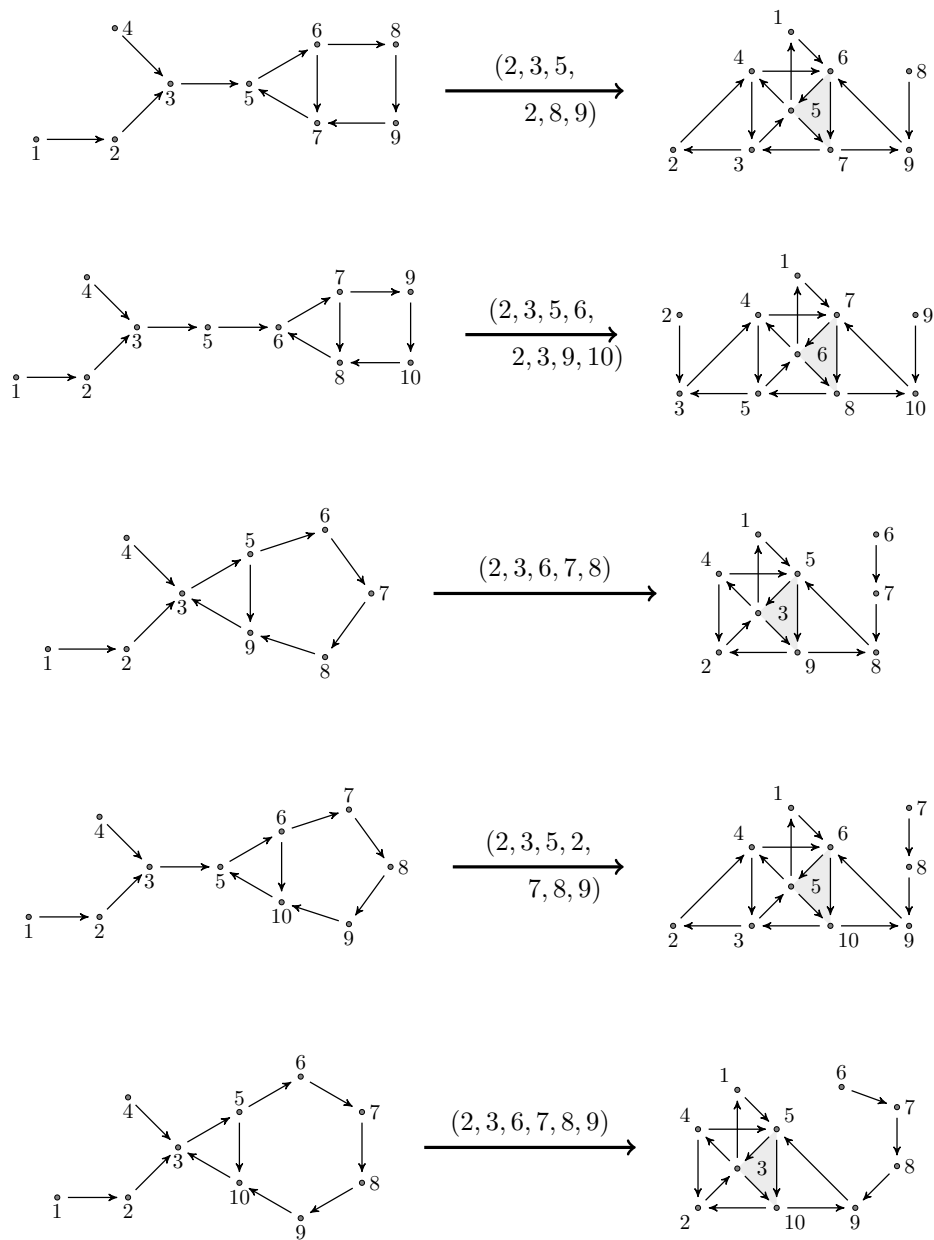

Figure 4.7: The remaining 5 exceptional representatives not shown in Figure 4.6.

### 4.5.1 Rank 3 quivers

If  $Q$  is an acyclic rank 3 quiver then it has a maximal green sequence by Theorem 4.3.7 so we only consider those quivers which are oriented 3-cycles. Let  $Q_{a,b,c}$  denote such a quiver with vertices 1, 2, and 3 and  $a$  edges  $1 \rightarrow 2$ ,  $b$  edges  $2 \rightarrow 3$  and  $c$  edges  $3 \rightarrow 1$ .

**Theorem 4.5.1** ([Mul15; Sev14]). *If  $a, b$  and  $c \geq 2$ , then the quiver  $Q_{a,b,c}$  does not admit a maximal green sequence.*

**Theorem 4.5.2.** *If any of  $a, b$  or  $c$  are equal to 1, then  $Q_{a,b,c}$  has a maximal green sequence.*

*Proof.* Without loss of generality assume that  $a = 1$ . If  $b > c$  then  $(2, 1, 3, 2)$  is a maximal green sequence for  $Q_{1,b,c}$ . If  $c > b$  then  $(2, 3, 1, 2)$  is a maximal green sequence for  $Q_{1,b,c}$ . If  $c = b$  then either mutation sequence is a maximal green sequence for  $Q_{1,b,c}$ .  $\square$

All mutation-infinite quivers of rank 3 are minimal mutation-infinite, so by the above not all such quivers admit a maximal green sequence. In Section 4.7 we show that all of the quivers in the mutation class of a mutation-infinite quiver of rank 3 that admit a maximal green sequence form a finite connected subgraph of the quiver exchange graph.

### 4.5.2 Higher rank quivers

There are an infinite number of rank 3 minimal mutation-infinite quivers, some of which have maximal green sequences and some do not. In contrast, only a finite number of higher rank minimal mutation-infinite quivers exist and we will show that all such quivers do in fact admit a maximal green sequence.

**Lemma 4.5.3.** *Let  $Q$  be a minimal mutation-infinite quiver. Then  $Q$  does not contain a subquiver that arises from a triangulation of a once-punctured closed surface, or one that is in the mutation class of  $\mathbb{X}_7$ .*

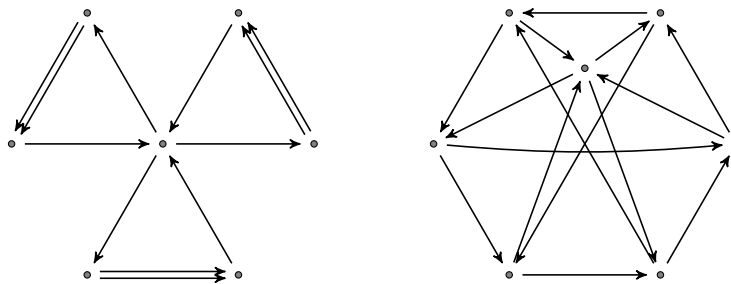

Figure 4.8: The quiver  $\mathbb{X}_7$  is on the left and the other quiver in its mutation class is on the right.

*Proof.* The mutation class of the  $\mathbb{X}_7$  quiver consists of two quivers, one contains three double arrows while the other contains six vertices which are each the source of two arrows and the target of two arrows. See Figure 4.8.

Ladkani shows in [Lad11, Prop. 3.6.] that for any quiver arising from a triangulation of a once-punctured surface without boundary each vertex is the source of two arrows and the target of two arrows. In the genus 1 surface case we get the Markov quiver with 3 vertices. In the case of the genus 2 surface each quiver has 9 such vertices.

The only minimal mutation-infinite quivers containing any double edges are the double arrow representatives, which each contain a single double edge. It can also be seen through an exhaustive search that no minimal mutation-infinite quiver contains more than 5 vertices which are each adjacent to 4 or more arrows. Hence no minimal mutation-infinite quivers contain subquivers from once-punctured surfaces or from  $\mathbb{X}_7$ .  $\square$

**Corollary 4.5.4.** *Let  $Q$  be a minimal mutation-infinite quiver. Every induced subquiver of  $Q$  has a maximal green sequence.*

*Proof.* Follows from Theorem 4.3.9 and Lemma 4.5.3.  $\square$

**Theorem 4.5.5.** *Suppose  $Q$  is a minimal mutation-infinite quiver of rank at least 4. Then  $Q$  has a maximal green sequence.*

*Proof.* Let  $Q$  be a minimal mutation-infinite quiver which is the  $t$ -colored direct sum of two induced subquivers of  $Q$ . Then by Theorem 4.3.13 and Corollary 4.5.4 the quiver  $Q$  has a maximal green sequence.

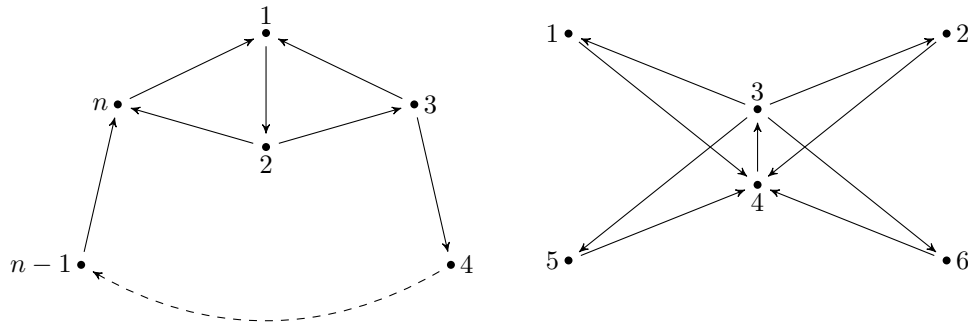

Figure 4.9: Minimal mutation-infinite quivers that cannot be written as a  $t$ -colored direct sum and do not end in a 3-cycle.

In particular, if a minimal mutation-infinite quiver contains either a sink or a source then it has a maximal green sequence. Similarly if it can be decomposed into two disjoint induced subquivers joined by a single arrow then it has a maximal green sequence.

There are only 42 minimal mutation-infinite quivers which cannot be written as a  $t$ -colored direct sum<sup>1</sup>. Of these, 35 end in a 3-cycle and so admit a maximal green sequence by Theorem 4.3.14 and Corollary 4.5.4.

This leaves 7 minimal mutation infinite quivers which cannot be written as a direct sum or end in a 3-cycle. Six of these 7 quivers have a similar structure and we will call these quivers  $\Theta_n$  for  $n = 4, 5, 6, 7, 8, 9$ . A picture of this family of quivers is given on the left of Figure 4.9. For a suitable  $n$ , the quiver  $\Theta_n$  has a maximal green sequence  $(2, 3, \dots, n, 1, 2)$ . The final quiver, appearing on the right of Figure 4.9, has a maximal green sequence  $(3, 1, 2, 5, 6, 4, 3)$ .  $\square$

## 4.6 $\mathbf{A=U}$ for minimal mutation-infinite quivers

For completeness we recall the result about the rank 3 quivers.

**Theorem 4.6.1.** [LLM15, Thm. 1.3] *Let  $\mathcal{A}$  be a rank 3 cluster algebra. The cluster algebra  $\mathcal{A}$  is equal to its upper cluster algebra if and only if it is acyclic.*

<sup>1</sup>Images of which can be found at <https://www.jwlawson.co.uk/maths/mmi/quivers/non-direct-sum/>

In the case of higher rank minimal mutation-infinite quivers we show that they are all Louise and it follows that the cluster algebra that they generate is equal to its upper cluster algebra.

**Theorem 4.6.2.** *If  $Q$  is a minimal mutation-infinite quiver of rank at least 4, then  $Q$  is Louise.*

*Proof.* All minimal mutation-infinite quiver representatives arising as an orientation of a hyperbolic Coxeter simplex diagram are acyclic apart from two orientations of the fully connected rank 4 quiver, shown as the fifth and sixth quivers in Table 3.1. The sixth quiver is mutation-equivalent to an acyclic quiver by mutating at the top vertex.

All quivers belonging to a given move-class are mutation-equivalent and hence every minimal mutation-infinite quiver in a Coxeter diagram move-class (excluding the single class considered below) is mutation-equivalent to an acyclic quiver. Therefore the cluster algebra is acyclic and hence Louise.

The remaining case for the hyperbolic Coxeter representatives is the move-class of the fifth rank 4 quiver in Table 3.1. We will show that it is locally acyclic so the claim follows from Theorem 4.2.9. Consider the representative quiver  $R$  given in Figure 4.2. Two vertices of the quiver labelled  $i$  and  $j$ . The edge  $1 \rightarrow 2$  is a separating edge. The quivers  $R[R_0 \setminus \{2\}]$  and  $R[R_0 \setminus \{1, 2\}]$  are acyclic and hence Louise. Mutating the quiver  $R[R_0 \setminus \{1\}]$  at  $j$  produces an acyclic quiver, which again shows that it is Louise. Therefore the quiver  $R$  is Louise.

The proof for minimal mutation-infinite quivers with move-class either of double arrow type or exceptional type is identical to the argument given above with the following choice of vertices for 1 and 2. In the case of the double arrow representatives we take 2 to be the vertex opposite the double arrow and 1 to be an adjacent vertex that is not incident to the double arrow. Similarly, for the exceptional representatives we take 2 to be the leftmost vertex of the 3-cycle and 1 to be an adjacent vertex that is not a part of the 3-cycle.  $\square$

**Corollary 4.6.3.** *If  $Q$  is a minimal mutation-infinite quiver of rank at least 4, then the cluster algebra  $\mathcal{A}(Q)$  is equal to its upper cluster algebra.*

*Proof.* Follows from Theorem 4.2.9 and Theorem 4.6.2.  $\square$

## 4.7 Quivers in the mutation class with maximal green sequences

Muller showed in [Mul15] that in general the existence of a maximal green sequence is not mutation-invariant. This motivates the question of which quivers in a mutation class have a maximal green sequence.

Recall that the (unlabelled) quiver exchange graph  $\mathcal{E}(Q)$  of a quiver  $Q$  is the graph constructed with a vertex for each quiver in the mutation class of  $Q$  and an edge between two vertices if there is a single mutation between the two corresponding quivers. Let  $\Psi(Q)$  denote the (possibly empty) subgraph of the quiver exchange graph  $\mathcal{E}(Q)$  consisting of the quivers that have a maximal green sequence. Rephrasing Theorem 4.3.9 we have the following result.

**Theorem 4.7.1.** *Let  $Q$  be a mutation-finite quiver. Either the graph  $\Psi(Q) = \mathcal{E}(Q)$  or  $\Psi(Q)$  is empty.*

Although there are infinitely many rank 3 quivers they only produce finitely many different exchange graphs.

**Theorem 4.7.2.** *Let  $Q$  be a rank 3 quiver. If  $Q$  is mutation-acyclic, then  $\Psi(Q)$  is one of the 7 graphs in Figures 4.11 and 4.12, otherwise,  $\Psi(Q)$  is empty. It then follows that the number of quivers in the mutation class of  $Q$  is bounded and in particular  $|\Psi(Q)| \leq 6$ .*

*Proof.* If  $Q$  is not mutation-acyclic then by [BBH11, Thm. 1.2] its entire mutation class consists of quivers of the form  $Q_{a,b,c}$  with  $a, b, c \geq 2$ . Therefore by Theorem 4.5.1 no quiver in the mutation class has a maximal green sequence and we may conclude that  $\Psi(Q)$  is empty.



Figure 4.10: The two types of (connected) acyclic rank 3 quivers which give different exchange graphs, for  $a, b, c \in \mathbb{Z}_{>0}$ .

If  $Q$  is mutation-acyclic then its mutation class must contain an acyclic quiver  $R$  in Figure 4.10 for some  $a, b, c \in \mathbb{Z}_{>0}$ . Clearly  $\Psi(Q) = \Psi(R)$  so we may proceed by showing that  $\Psi(R)$  is one of the exchange graphs in Figures 4.11 and 4.12. Every vertex of  $\mathcal{E}(R)$  that is not displayed in one of these figures corresponds to a quiver  $Q_{i,j,k}$  for some  $i, j, k \geq 2$ . Indeed, it is easy to check that for any one step mutation that does not appear in these graphs the resulting quiver is of the claimed form. To see the claim for a longer mutation sequence, suppose that we mutate a quiver in  $\Psi(R)$  at vertex  $v$  to obtain the quiver  $Q_{i,j,k} \notin \Psi(R)$ . Then according to Lemma 2.4 in [ABBS08] if we mutate at  $\ell \in (Q_{i,j,k})_0 \setminus \{v\}$  we have

$$\mu_\ell(Q_{i,j,k}) = Q_{i',j',k'}$$

with  $i' \geq i, j' \geq j$ , and  $k' \geq k$ . Therefore any mutation sequence of length two yields a quiver without a maximal green sequence. Iterating this argument we see for any mutation sequence that moves along  $\mathcal{E}(R)$  outside of the region  $\Psi(R)$  we will always obtain a quiver that is a 3-cycle which does not have a maximal green sequence since the number of edges will all be greater than or equal to 2.

Suppose  $R$  is of the linear type in Figure 4.10a, then there are four possibilities for  $\Psi(R)$ , which are determined by the values of  $a$  and  $b$ . The four cases are:

1.  $b > a = 1$ ;
2.  $b = a = 1$ ;
3.  $b > a > 1$ ;
4.  $b = a > 1$ ,

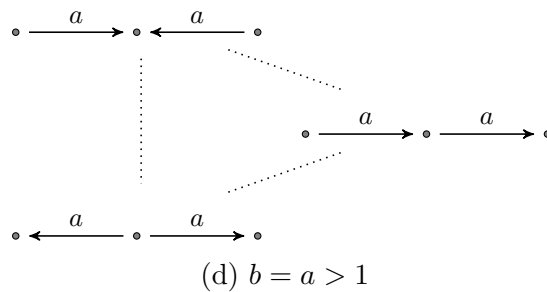
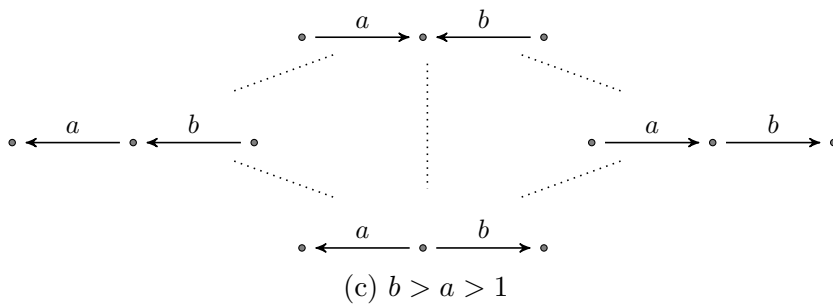
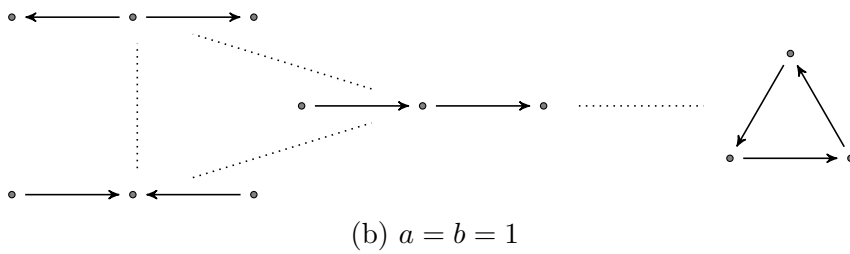
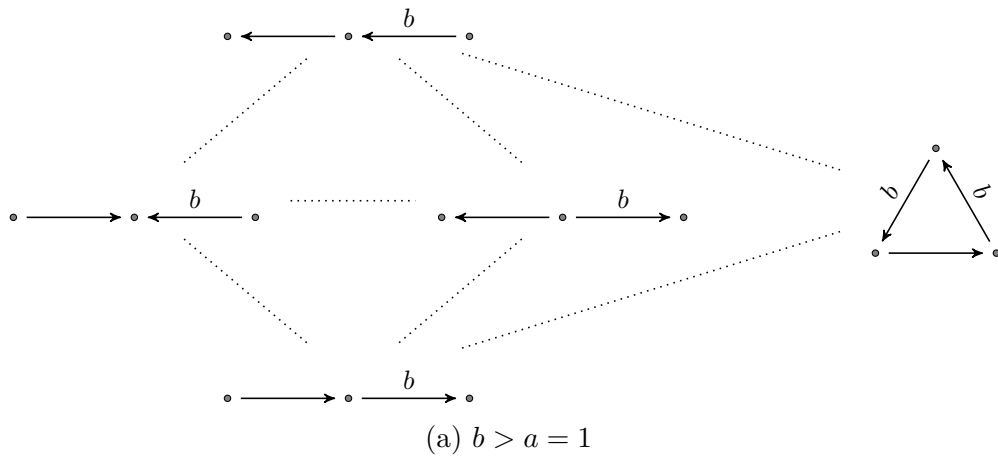

Figure 4.11: Subgraphs of the quiver exchange graphs showing only those quivers with maximal green sequences for the quiver appearing in Figure 4.10a.

with corresponding graphs  $\Psi(R)$  shown in Figure 4.11.

If  $R$  is of the triangular type in Figure 4.10b we again have four cases to consider:

1.  $b = a = 1, c > 1$ ;
2.  $b, c > 1, a = 1$ ;
3.  $c = b = a = 1$ ;
4.  $a, b, c > 1$ ,

with corresponding graphs shown in Figure 4.12. Note that Figure 4.11d and Figure 4.12d give isomorphic graphs for  $\Psi(R)$ . Hence, there are 7 possibilities for a mutation-acyclic rank 3 quiver. The largest such graph has 6 vertices.  $\square$

We now prove a result similar to Theorem 4.7.1 for rank 4 minimal mutation-infinite quivers. When constructing  $\Psi$  from  $\mathcal{E}$  we can use Theorem 4.3.8 and Theorem 4.5.1 to remove several vertices from  $\mathcal{E}$ . However, this approach is not sufficient to eliminate all quivers that do not admit a maximal green sequence. To handle this we introduce the notion of a good mutation sequence, which is a slight generalization of a maximal green sequence, to show that other quivers appearing in the mutation class  $\mathcal{S}(Q)$  do not have a maximal green sequence.

**Definition 4.7.3.** A vertex  $k$  of a quiver  $Q$  is called a **good vertex** if both:

1. The vertex  $k$  is not the head of a multiple edge;
2. The quiver  $\mu_k(Q)$  does not contain an induced subquiver that does not admit a maximal green sequence.

A mutation sequence is called a **good sequence** if at every step of the mutation sequence we mutate at a good vertex.

As mentioned above, all maximal green sequences are good sequences.

**Lemma 4.7.4.** *Let  $Q$  be a quiver. If  $R \in \mathcal{S}(Q)$  does not have a maximal green sequence then there is no maximal green sequence for  $Q$  that passes through  $R$ .*

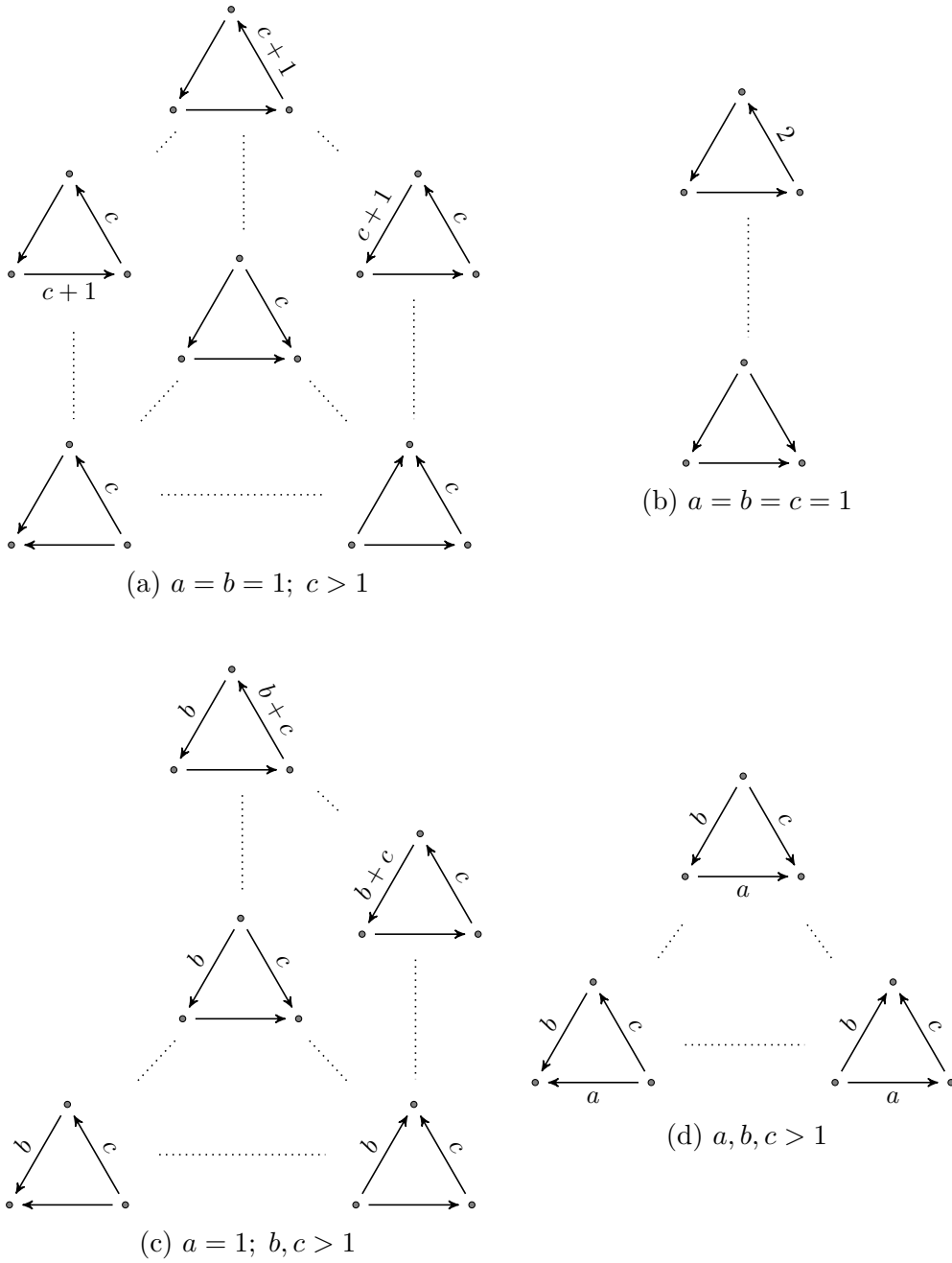

Figure 4.12: Subgraphs of the quiver exchange graphs showing only those quivers with maximal green sequences for the quiver appearing in Figure 4.10b.

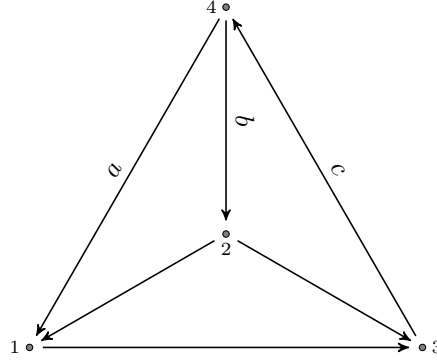

Figure 4.13: The rank 4 quiver  $R_{a,b,c}$  for  $b, c \geq 2$  and  $a \leq c - 2$ . This quiver has only one good vertex, labelled 3.

*Proof.* If there was such a maximal green sequence then by Theorem 4.3.10  $R$  would have a maximal green sequence which contradicts our assumption.  $\square$

**Lemma 4.7.5** ([BHIT15, Thm. 4]). *A maximal green sequence never mutates at the head of a multiple edge.*

**Corollary 4.7.6.** *A maximal green sequence is a good sequence.*

*Proof.* This is a direct result of Theorem 4.3.8, Lemma 4.7.4, and Lemma 4.7.5.  $\square$

To obtain our result for rank 4 minimal mutation-infinite quivers it is sufficient to show that a particular family of quivers do not have a maximal green sequence.

Let  $Q$  be a quiver. The opposite quiver  $Q^{\text{op}}$  is the quiver obtained from  $Q$  by reversing all of the edges of  $Q$ .

**Lemma 4.7.7.** *Let  $R_{a,b,c}$  denote the rank 4 quiver given in Figure 4.13 with  $b, c \geq 2$  and  $a \leq c - 2$ . The only good vertex of  $R_{a,b,c}$  is vertex 3 and the only good vertex of  $(R_{a,b,c})^{\text{op}}$  is vertex 2. That is the only good vertex is the sink in the induced subquiver consisting of the vertices 1, 2, and 3.*

*Proof.* If we mutate at vertex 1, then  $\mu_1(R_{a,b,c})[\{2, 3, 4\}] \simeq Q_{2,c-a,b}$  which does not have a maximal green sequence by Theorem 4.5.1 so vertex 1 is not a good vertex. The vertices 2 and 4 are not good vertices since they are heads of multiple arrows as  $b, c \geq 2$ .  $\square$

**Corollary 4.7.8.** *Assume  $c - a \geq 2$  and  $|c - b - a| > 0$ .*

1. *If  $c > b \geq 2$  and  $\mathbf{i}$  is a good sequence for  $R_{a,b,c}$  of length  $k$  we have*

$$\mu_{\mathbf{i}}(R_{a,b,c}) = \begin{cases} R_{a,b+n(c-b-a),c+n(c-b-a)} & \text{if } k = 2n, \\ (R_{c-b,c+n(c-b-a),b+(n+1)(c-b-a)})^{op} & \text{if } k = 2n + 1. \end{cases}$$

2. *If  $b > c \geq 2$  and  $\mathbf{i}$  is a good sequence for  $(R_{a,b,c})^{op}$  of length  $k$  we have*

$$\mu_{\mathbf{i}}((R_{a,b,c})^{op}) = \begin{cases} (R_{a,b+n(b+a-c),c+n(b+a-c)})^{op} & \text{if } k = 2n, \\ (R_{b-c,c+(n+1)(b+a-c),b+n(b+a-c)})^{op} & \text{if } k = 2n + 1. \end{cases}$$

*Proof.* We only prove the case when  $c > b \geq 2$  as the other case is analogous.

Assume  $c > b \geq 2$ . By Lemma 4.7.7 a good sequence must begin by mutating at 3. Now since  $c > b$  we have  $\mu_3(R_{a,b,c}) \simeq (R_{c-b,c-a,c})^{op}$ . By assumption  $c - a \geq 2$  so by Lemma 4.7.7 a good sequence must mutate at the sink in  $\mu_3(R_{a,b,c})[\{1, 2, 3\}]$ , which is vertex 1. Continuing our good sequence by mutating at vertex 1 we see that

$$\mu_1\mu_3(R_{a,b,c}) \simeq R_{a,c-a,2c-b-a}.$$

Note that  $2c - b - a > c - a \geq 2$ , and  $c - b - a > 0$  so  $2c - b - a > c$  and  $2c - b - 2a > c - a \geq 2$ . That is, if we set  $a^* = a, b^* = c - a = b + (c - b - a)$  and  $c^* = 2c - b - a = c + (c - b - a)$  we see that  $c^* - a^* \geq 2, c^* - b^* - a^* > 0$ , and  $c^* > b^* \geq 2$ , so all of our hypotheses from the statement of the corollary are again satisfied.

Repeating the argument above we know at each mutation step we have exactly one choice of vertex to mutate at for our mutation sequence to be a good sequence. Continuing this process we see that if  $\mathbf{i}$  is a good sequence of length  $k$ , then we obtain the formula given in the statement of the result.  $\square$

**Lemma 4.7.9.** *The quivers  $R_{a,b,c}$  and  $(R_{a,b,c})^{op}$  have no maximal green sequence when*

$$(a, b, c) \in \{(0, 2, 3), (1, 4, 3), (0, 3, 5), (2, 5, 4), (1, 2, 4)\}.$$

*Proof.* For all three triples with  $c > b \geq 2$ , namely  $\{(0, 2, 3), (0, 3, 5), (1, 2, 4)\}$  we have  $c - a > 2$  and  $c - b - a > 0$  so Corollary 4.7.8(1) applies. If  $\mathbf{i}$  is a maximal green sequence for  $R_{a,b,c}$  it is also a good sequence. However, if  $\mathbf{i}$  is a maximal green sequence then by Lemma 4.3.5 we have  $\mu_{\mathbf{i}}(R_{a,b,c}) = R_{a,b,c}$ , which contradicts Corollary 4.7.8. Therefore  $R_{a,b,c}$  has no maximal green sequence. By Lemma 4.3.6 the opposite quivers  $(R_{a,b,c})^{\text{op}}$  do not have a maximal green sequence.

We may apply an identical argument using Corollary 4.7.8(2) and Corollary 4.7.6 to the quivers  $(R_{a,b,c})^{\text{op}}$  for  $\{(1, 4, 3), (2, 5, 4)\}$  to show that they don't have a maximal green sequence. Then again we may apply Lemma 4.3.6 to see that the quivers  $R_{a,b,c}$  do not have a maximal green sequence.  $\square$

**Theorem 4.7.10.** *Let  $Q$  be a minimal mutation-infinite quiver of rank 4. Then  $\Psi$  is a proper subgraph of  $\mathcal{E}$  and the connected component  $\widehat{\Psi}$  of  $\Psi$  that contains  $Q$  is finite and contains the entire move-class of  $Q$ .*

*Proof.* For any minimal mutation-finite quiver  $Q$  it is easy to see that there exists a quiver  $R$  in its mutation class that contains a rank 3 subquiver without a maximal green sequence. Therefore by Theorem 4.3.8  $R$  does not have a maximal green sequence so  $\Psi \neq \mathcal{E}$ .

The rest of the claim is verified via direct calculation. For each move-class representative of a rank 4 minimal-mutation infinite quiver given in Table 3.1 we compute its unlabelled exchange graph. For each new vertex added to the graph we test if the associated quiver has a maximal green sequence. In each case we obtain a component of  $\mathcal{E}$  that has two types of quivers on its boundary:

1. Those containing a rank 3 subquiver of the form  $Q_{a,b,c}$  with  $a, b, c \geq 2$ ;
2. The quivers  $R_{a,b,c}$  and  $(R_{a,b,c})^{\text{op}}$  for one of the triples  $(a, b, c)$  considered in Lemma 4.7.9.

In the first case these quivers do not have a maximal green sequence by Theorem 4.3.8 and Theorem 4.5.1. The other two quivers do not have a maximal green sequence by Lemma 4.7.9.

Upon inspection we see that the entire move class of the representative is contained in this component.  $\square$

**Example 4.7.11.** Let  $Q$  be the 4th rank 4 quiver given in Table 3.1. In Figure 4.14 we give  $\widehat{\Psi}(Q)$  together with the vertices of  $\mathcal{E}(Q)$  that are adjacent to vertices of  $\widehat{\Psi}(Q)$  to illustrate the boundedness of  $\widehat{\Psi}(Q)$ . The graph  $\widehat{\Psi}(Q)$  consists of the solid black quivers, while the light gray quivers do not have maximal green sequences and are not a part of  $\widehat{\Psi}(Q)$ .

## 4.8 Other questions and conjectures

It is likely that an identical phenomenon occurs for higher rank minimal mutation-infinite quivers and that it can be shown using techniques similar to the ones presented here. It is straightforward to compute a candidate component for  $\widehat{\Psi}$ . The issue is that there are many more quivers that bound this region and it is a long process to show that they do not have maximal green sequences. Already in the case of the first rank 7 mutation class with a hyperbolic Coxeter representative, there are at least 1200 quivers to check that do not possess a rank 3 subquiver without a maximal green sequence.

**Conjecture 4.8.1.** *The results of Theorem 4.7.10 hold for all minimal mutation-infinite quivers.*

We also believe that in these cases  $\widehat{\Psi} = \Psi$ . However we are unable to prove this. This would immediately follow from an affirmative answer to the following question.

**Question 4.8.2.** *Is the graph  $\Psi$  a connected subgraph of  $\mathcal{E}$ ?*

In light of Theorem 4.3.13 we also think that it would be interesting to explore the relationship between  $\Psi(Q)$  and  $\Psi(Q')$  for two quivers  $Q$  and  $Q'$  and that of the graph  $\Psi(Q \oplus Q')$ .

**Conjecture 4.8.3.** *Suppose that  $Q$  and  $Q'$  are two quivers such that  $\Psi(Q)$  and  $\Psi(Q')$  are finite and non-empty, then  $\Psi(Q \oplus Q')$  is finite and non-empty.*

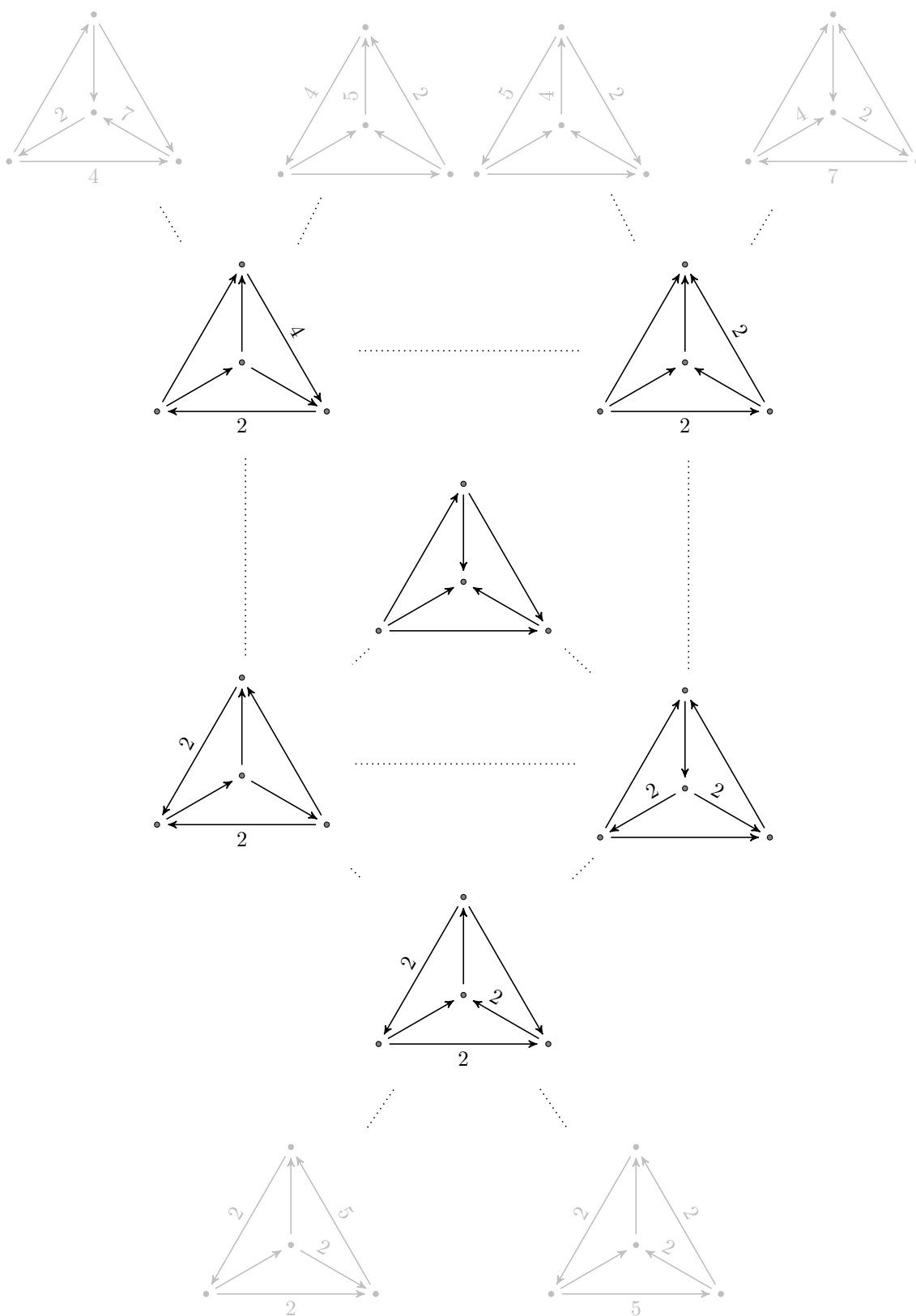

Figure 4.14: A subgraph of the exchange graph of the 4th quiver  $Q$  in Table 3.1 containing  $\widehat{\Psi}(Q)$ , as described in Example 4.7.11.

One goal of this approach would be to answer the following question.

**Question 4.8.4.** *For any quiver  $Q$ , are there finitely many quivers in  $\mathcal{S}(Q)$  that have a maximal green sequence?*

# Chapter 5

## Cluster automorphisms and the marked exchange graph of skew-symmetrizable cluster algebras

The previous chapter looked at the exchange graphs of quivers, and considered how quivers with maximal green sequences appear within these graphs. More generally a cluster algebra has an associated exchange graph and in this chapter we study the combinatorics of these exchange graphs and show how they encode information about the underlying quivers, cluster algebra and automorphisms preserving the cluster structure.

The work in this chapter was published in [Law16].

### 5.1 Introduction

Cluster automorphisms were introduced by Assem, Schiffler and Shramchenko in their paper [ASS12] for cluster algebras generated from quivers, as automorphisms of the cluster algebra taking clusters to clusters and acting as either the identity or the

opposite function on quivers. These ideas were extended to cluster algebras generated from certain skew-symmetrizable matrices by Chang and Zhu in [CZ16a]. The group of cluster automorphisms of a cluster algebra arising from the triangulation of a surface was shown to be isomorphic to the mapping class group of this surface by Brüstle and Qiu in [BQ15].

In their paper on labelled seeds and global mutations [KP16], King and Pressland showed that cluster automorphisms arise naturally when mutation classes are considered as orbits of labelled seeds under the action of a global mutation group  $M_n$ . The group of cluster automorphisms is a subgroup of the automorphisms of these mutation classes,  $\text{Aut}_{M_n}$ , which commute with this group action, and in fact for mutation-finite quivers these groups are isomorphic. We use the links between automorphisms of the exchange graph and the labelled exchange graph to prove that this group  $\text{Aut}_{M_n}$  is isomorphic to the group of exchange graph automorphisms:

**Theorem 5.3.11.** *For any labelled mutation class  $\mathcal{S}^0$  with corresponding mutation class  $\mathcal{S} = \mathcal{S}^0/\text{Sym}(n)$  and exchange graph  $\mathcal{E}(\mathcal{S})$*

$$\text{Aut}_{M_n}(\mathcal{S}^0) \cong \text{Aut } \mathcal{E}(\mathcal{S}).$$

Therefore for mutation-finite quivers, such as those from triangulations of a surface, exchange graph automorphisms are cluster automorphisms.

**Corollary 5.1.1.** *For a cluster algebra  $\mathcal{A}$  constructed from a mutation-finite quiver with exchange graph  $\mathcal{E}_{\mathcal{A}}$*

$$\text{Aut } \mathcal{E}_{\mathcal{A}} \cong \text{Aut } \mathcal{A}.$$

This result was proved in a different way by Chang and Zhu in [CZ15] who also proved an extension of this to skew-symmetrizable matrices of type  $B_n$  and  $C_n$  for  $n \geq 3$ . However for other skew-symmetrizable matrices it is not true that exchange graph automorphisms are cluster automorphisms. It can be shown that the group of cluster automorphisms is isomorphic to a subgroup of the group of exchange graph automorphisms but in general there exist graph automorphisms which do not correspond to cluster automorphisms.

In order to generalise these results we introduce a marking on the exchange graph in such a way that any automorphism which fixes these markings does in fact correspond to a cluster automorphism.

**Theorem 5.5.19.** *If  $\mathcal{A}$  is a cluster algebra with initial seed  $(\mathbf{x}, B)$ , where  $B$  is a mutation-finite skew-symmetrizable matrix, and  $\widehat{\mathcal{E}}_{\mathcal{A}}$  is its marked exchange graph then*

$$\text{Aut } \mathcal{A} = \text{Aut } \widehat{\mathcal{E}}_{\mathcal{A}}.$$

Therefore the cluster automorphisms of a cluster algebra generated by mutation-finite skew-symmetrizable matrices can be studied using just the combinatorial properties of its marked exchange graph.

A skew-symmetrizable matrix associated to a good orbifold with order 2 orbifold points can be unfolded to a skew-symmetric matrix associated to a surface which covers the orbifold. In this case we show that automorphisms of the marked exchange graph induce automorphisms of the unfolded exchange graph.

**Theorem 5.6.4.** *Given a skew-symmetrizable matrix  $B$  which unfolds to a matrix  $Q$ , with corresponding marked exchange graphs  $\widehat{\mathcal{E}}(B)$  and  $\mathcal{E}(Q) = \widehat{\mathcal{E}}(Q)$ ,*

$$\text{Aut } \widehat{\mathcal{E}}(B) \leftrightarrow \text{Aut } \mathcal{E}(Q).$$

We finish the chapter with a conjecture generalising a result of Brüstle and Qiu linking the tagged mapping class group of a surface with the cluster automorphisms of the corresponding surface cluster algebra.

**Conjecture 5.1.1.** *For a cluster algebra  $\mathcal{A}$  arising from the triangulation of an orbifold  $\mathcal{O}$*

$$\text{MCG}_{\bowtie}(\mathcal{O}) \cong \text{Aut}^+ \mathcal{A}.$$

The structure of the chapter is as follows: Section 5.2 gives basic definitions of cluster algebras and mutations while Section 5.3 looks at the exchange graph of a cluster algebra and includes proofs linking graph automorphisms and mutation

class automorphisms. Section 5.4 recalls the definition of cluster automorphisms and various known results linking these to mutation class automorphisms and exchange graph automorphisms. The section ends by explaining how a maximal green sequence of an acyclic quiver can be used to construct a cluster automorphism.

In Section 5.5 we introduce the marked exchange graph which enables us to extend these results to cluster algebras from skew-symmetrizable matrices. We show that graph automorphisms fixing the marking are in one-to-one correspondence with cluster automorphisms.

In Section 5.6 we consider unfoldings of skew-symmetrizable matrices and show how the cluster automorphisms of a skew-symmetrizable cluster algebra induce cluster automorphisms of its unfolded cluster algebra. Section 5.7 looks at these ideas when the skew-symmetrizable cluster algebra is constructed from an orbifold and its unfolding gives a surface cluster algebra.

## 5.2 Mutations

Throughout this chapter we assume that all quivers and diagrams are connected. The results can be easily extended to disconnected diagrams, however care must be taken as different connected components could have their arrows reversed while other components do not, so the idea of an opposite diagram is less clear.

Let  $\mathcal{F} = \mathbb{C}(x_1, \dots, x_n)$ . Recall the basic definitions set out in Chapter 2: A **cluster** is a set of algebraically independent elements of  $\mathcal{F}$ , while a **labelled cluster** is a cluster with some ordering of its elements. The individual elements in a cluster are called **cluster variables**.

A **labelled seed** is a pair  $(\mathbf{x}, B)$  where  $B$  is a skew-symmetrizable matrix and  $\mathbf{x}$  is a labelled cluster. Each cluster variable in the cluster can be thought of as being attached to one of the matrix rows, or equivalently attached to one of the vertices of the corresponding quiver or diagram. A **seed** is a class of labelled seeds which differ only by permutations.

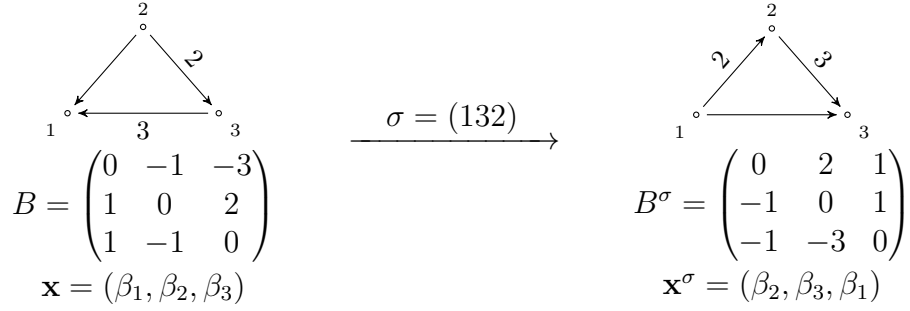

Figure 5.1: Example of a permutation  $\sigma = (132)$  acting on a seed  $(\mathbf{x}, B)$  to give  $(\mathbf{x}, B) \cdot \sigma = (\mathbf{x}^\sigma, B^\sigma)$ .

Throughout this chapter we assume that the matrix in a seed is uniquely determined by its cluster. This has been proved for all cluster algebras of geometric type or generated from a non-degenerate matrix by Gekhtman, Shapiro and Vainshtein in [GSV08]. In this case denote the matrix for a given cluster  $\mathbf{x}$  by  $B(\mathbf{x})$ .

It is sometimes convenient to consider the local mutation  $\mu_{\beta, \mathbf{x}}$  of a seed  $(\mathbf{x}, B)$  corresponding to the mutation at the vertex associated to the cluster variable  $\beta \in \mathbf{x}$ . These local mutations act as functions on seeds, whereas global mutations act on labelled seeds.

Permutations act on a labelled seed  $(\mathbf{x}, B)$ ,  $\mathbf{x} = (\beta_1, \dots, \beta_n)$ ,  $B = (b_{i,j})$  in the expected way taking the  $i$ -th vertex to the  $\sigma(i)$ -th vertex and the  $i$ -th cluster variable to the  $\sigma(i)$ -th cluster variable. Therefore  $(\mathbf{x}, B) \cdot \sigma = (\mathbf{x}^\sigma, B^\sigma)$  where  $\mathbf{x}^\sigma = (\beta_{\sigma^{-1}(1)}, \dots, \beta_{\sigma^{-1}(n)})$  and  $B^\sigma = (b_{i,j}^\sigma)$ ,  $b_{i,j}^\sigma = b_{\sigma^{-1}(i), \sigma^{-1}(j)}$ .

**Example 5.2.1.** Given a 3 vertex seed  $(\mathbf{x}, B)$  as in Figure 5.1 and permutation  $\sigma = (132)$  then  $\sigma$  maps the first vertex and cluster variable to the third, second to first and third to second. Therefore  $\beta_1^\sigma = \beta_2 = \beta_{\sigma^{-1}(1)}$ ,  $\beta_2^\sigma = \beta_3$  and  $\beta_3^\sigma = \beta_1$ . Similarly  $B_{1,2}^\sigma = 2 = B_{2,3} = B_{\sigma^{-1}(1), \sigma^{-1}(2)}$  and  $B_{3,2}^\sigma = -3 = B_{1,3}$ .

**Definition 5.2.2** ([KP16, Sec. 1]). The **global mutation group** for seeds of rank  $n$  is given by

$$M_n = \langle \mu_1, \dots, \mu_n \mid \mu_i^2 = 1 \rangle \rtimes \text{Sym}(n)$$

where the  $\mu_i$  are mutations and  $\mu_i \sigma = \sigma \mu_{\sigma(i)}$  for  $\sigma \in \text{Sym}(n)$ .

The **labelled mutation class**  $\mathcal{S}^0$  of a labelled seed  $(\mathbf{x}, B)$  is the orbit of  $(\mathbf{x}, B)$  under the action of  $M_n$ . The quotient by the symmetric group action gives the **mutation class**

$$\mathcal{S} = \mathcal{S}^0 / \text{Sym}(n).$$

Two seeds in the same mutation class are said to be **mutation-equivalent**.

**Definition 5.2.3.** The **cluster algebra**  $\mathcal{A}(\mathcal{S})$  is the subalgebra of  $\mathcal{F}$  generated by all cluster variables occurring in the seeds in  $\mathcal{S}$ .

A cluster algebra is said to be of **finite type** if there are a finite number of generating cluster variables in the mutation class, otherwise it is of **infinite type**. If there are a finite number of distinct matrices in the seeds of  $\mathcal{S}$ , then the cluster algebra and all the matrices are said to be **mutation-finite** or of **finite mutation type**, otherwise it is **mutation-infinite** or of **infinite mutation type**.

**Definition 5.2.4** ([KP16, Sec. 2]). The automorphism group  $\text{Aut}_{M_n}(\mathcal{S}^0)$  of the mutation class is the group of bijections  $\phi : \mathcal{S}^0 \rightarrow \mathcal{S}^0$  which commute with the action of  $M_n$ , so for all  $s \in \mathcal{S}^0$ ,  $g \in M_n$  and  $\phi \in \text{Aut}_{M_n}(\mathcal{S}^0)$

$$\phi(s \cdot g) = \phi(s) \cdot g.$$

### 5.3 Exchange graphs

Fomin and Zelevinsky in [FZ02] developed the idea of the exchange graph of a cluster algebra to better visualise the relations in a mutation class. These were also an important tool in their classification of finite type cluster algebras in [FZ03].

**Definition 5.3.1.** The **exchange graph**  $\mathcal{E}(\mathcal{S})$  of a mutation class  $\mathcal{S}$  is constructed with vertices for each seed in  $\mathcal{S}$  and an edge between two seeds  $u$  and  $v$  if and only if there is a single local mutation  $\mu$  such that  $\mu(u) = v$ .

The **labelled exchange graph**  $\Delta(\mathcal{S}^0)$  of a labelled mutation class  $\mathcal{S}^0$  is constructed with a vertex for each labelled seed in  $\mathcal{S}^0$  and an edge labelled  $i$  between two labelled seeds  $u$  and  $v$  if and only if  $u \cdot \mu_i = v$  (and conversely  $v \cdot \mu_i = u$ ).

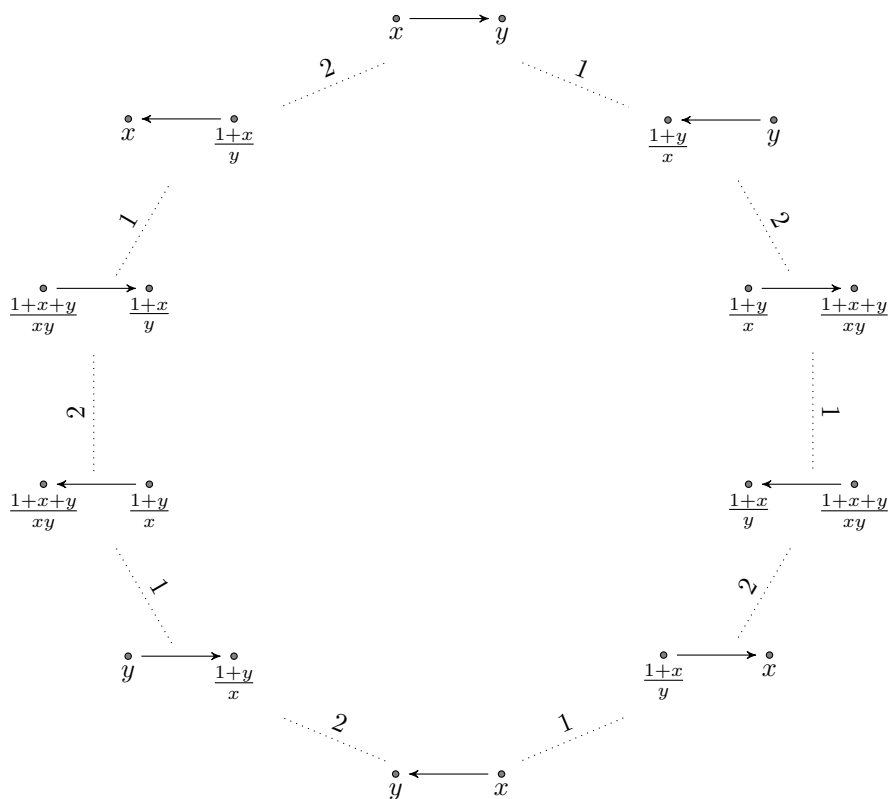

Figure 5.2: Labelled exchange graph for the mutation class of type  $A_2$ .

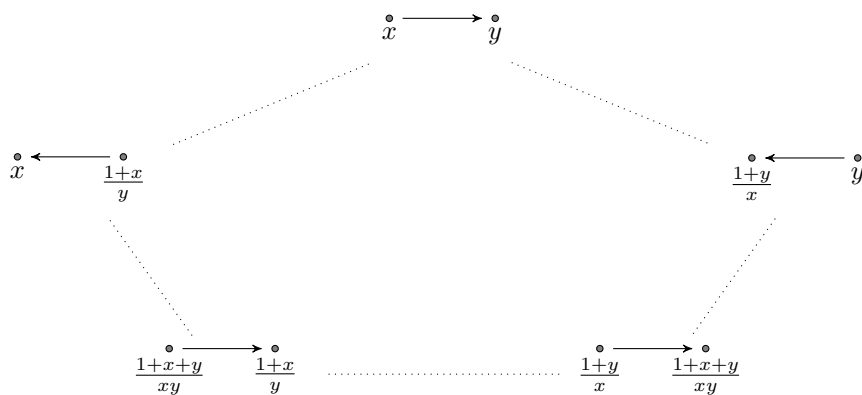

Figure 5.3: Exchange graph for the mutation class of type  $A_2$ .

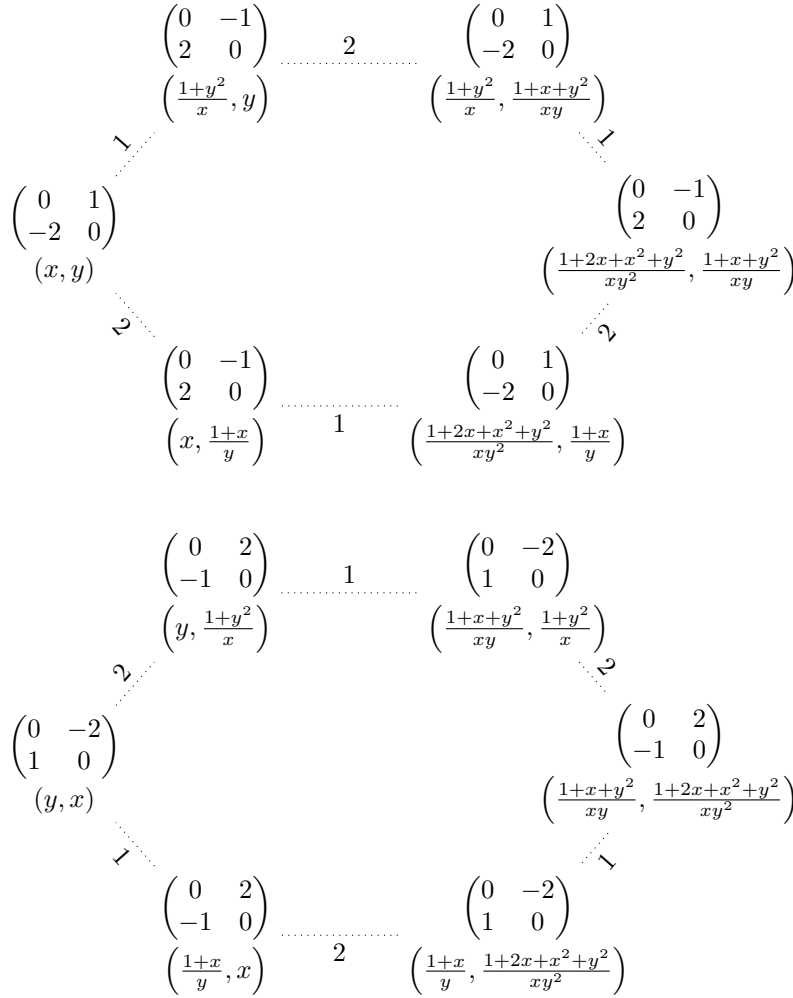

Figure 5.4: Labelled exchange graph for the mutation class of type  $B_2$ .

**Example 5.3.2** ( $A_2$ ). The exchange graph for the cluster algebra of type  $A_2$  is the well known pentagon, as seen in Figure 5.3. The labelled exchange graph is a decagon shown in Figure 5.2, with the permutation acting by taking a seed to its antipodal seed.

**Example 5.3.3** ( $B_2$ ). The exchange graph for a cluster algebra of type  $B_2$  is a hexagon, as shown in Figure 5.5. The labelled exchange graph however is the disjoint union of two hexagons as shown in Figure 5.4. The permutation interchanging the cluster variables in a labelled seed gives another labelled seed which cannot be obtained from the first though just mutations, so any labelled seed has a permuted counterpart in the other connected component.

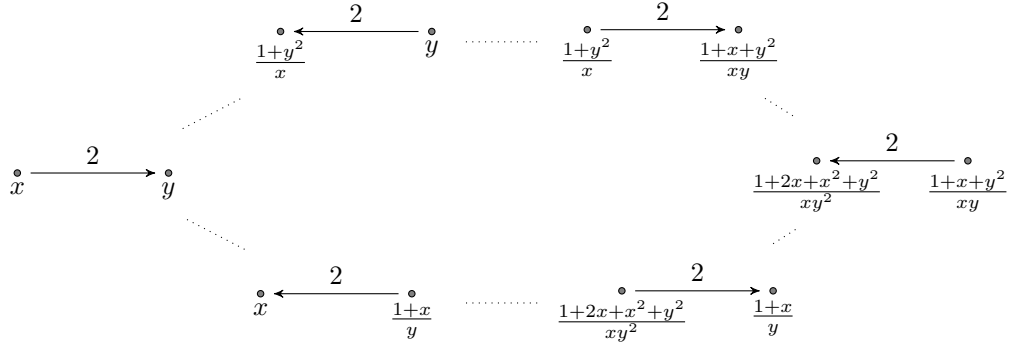

Figure 5.5: Exchange graph for the mutation class of type  $B_2$ .

**Definition 5.3.4.** The **exchange graph automorphism group**  $\text{Aut } \mathcal{E}(\mathcal{S})$  is the group of permutations  $\sigma$  of the vertex set of the exchange graph such that there is an edge between two vertices  $u$  and  $v$  if and only if there is an edge between  $\sigma(u)$  and  $\sigma(v)$ .

The **labelled exchange graph automorphisms** in  $\text{Aut } \Delta(\mathcal{S}^0)$  must also preserve the labelling of the edges.

**Theorem 5.3.5.** For a labelled mutation class  $\mathcal{S}^0$  with quotient  $\mathcal{S}$  and corresponding exchange graphs  $\Delta(\mathcal{S}^0)$  and  $\mathcal{E}(\mathcal{S})$ , then

$$\text{Aut } \mathcal{E}(\mathcal{S}) \leftrightarrow \text{Aut } \Delta(\mathcal{S}^0).$$

*Proof.* To show this we construct a unique  $\phi^\Delta \in \text{Aut } \Delta(\mathcal{S}^0)$  for each  $\phi \in \text{Aut } \mathcal{E}(\mathcal{S})$ . Let  $\mathbf{x}(v)$  denote the cluster of a seed  $v$ .

Choose a seed  $u$  in  $\Delta(\mathcal{S}^0)$ , then for each  $i \in \{1, \dots, n\}$  there is a vertex  $v^i = u \cdot \mu_i$  with a corresponding edge  $u - v^i$  labelled  $i$  in the labelled exchange graph. The cluster  $\mathbf{x}(u) = (\beta_1, \dots, \beta_i, \dots, \beta_n)$  then differs from the cluster  $\mathbf{x}(v^i) = (\beta_1, \dots, \beta'_i, \dots, \beta_n)$  in just the  $i$ -th cluster variable.

Under the quotient by the symmetric group action the labelled seed  $u$  gets mapped to a seed  $[u]$  and in the exchange graph  $\mathcal{E}(\mathcal{S})$  there are edges  $[u] - [v^i]$  for each  $i \in \{1, \dots, n\}$ . Each unordered cluster  $\mathbf{x}[v^i]$  differs from the unordered cluster  $\mathbf{x}[u]$  in a single variable, just as the corresponding labelled clusters do.

The exchange graph automorphism  $\phi$  maps  $[u]$  to some seed  $\phi[u]$  and preserves all edges in the graph, so  $\phi[u]$  is connected to  $\phi[v^i]$  for each  $i$ . Therefore each  $\phi[v^i]$  is a

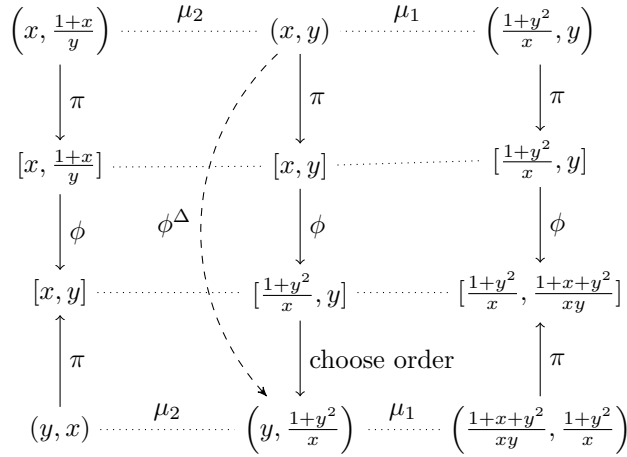

Figure 5.6: Commutative diagram of the various maps involved in Example 5.3.6.

single mutation from  $\phi[u]$ , and so the unordered cluster  $\mathbf{x}(\phi[u]) = [\gamma_1, \dots, \gamma_{k_i}, \dots, \gamma_n]$  differs from  $\mathbf{x}(\phi[v^i]) = [\gamma_1, \dots, \gamma'_{k_i}, \dots, \gamma_n]$  in a single cluster variable.

Set the image  $\phi^\Delta(u)$  to be the seed defined by the labelled cluster  $\mathbf{x}(\phi^\Delta(u)) = (\gamma_{k_1}, \gamma_{k_2}, \dots, \gamma_{k_n})$ , obtained by choosing an order of the cluster  $\mathbf{x}(\phi[u])$  such that the  $i$ -th variable of  $\mathbf{x}(\phi^\Delta(v^i))$  is the corresponding  $\gamma'_{k_i}$ , while all other variables are the same as for  $\phi^\Delta(u)$ . This ensures that the edge between  $\phi^\Delta(u)$  and  $\phi^\Delta(v^i)$  is labelled  $i$ . Repeat this procedure with initial seed  $v^i$  to get the ordering of the seeds connected to  $\phi^\Delta(v^i)$ .

Continuing this construction for all seeds in  $\Delta(\mathcal{S}^0)$  constructs images under  $\phi^\Delta$  for all seeds in the labelled exchange graph. For any two seeds  $s, t$  connected by an edge labelled  $k$  in  $\Delta(\mathcal{S}^0)$  this construction ensures that the images  $\phi^\Delta(s)$  and  $\phi^\Delta(t)$  are also connected by an edge labelled  $k$ , and so  $\phi^\Delta$  is indeed an automorphism of the labelled exchange graph.  $\square$

**Example 5.3.6.** Consider the automorphism  $\phi$  of the  $B_2$  exchange graph  $\mathcal{E}$  shown in Figure 5.5 given by a clockwise rotation by angle  $\frac{\pi}{3}$ . This automorphism pulls back to an automorphism  $\phi^\Delta$  of the labelled exchange graph  $\Delta$  shown in Figure 5.4.

To determine the automorphism  $\phi^\Delta$ , choose an initial labelled seed  $u = (\mathbf{x}, B)$  where  $\mathbf{x} = (x, y)$ . The automorphism  $\phi$  maps the corresponding cluster  $[x, y]$  to  $[\frac{1+y^2}{x}, y]$  and the mutation  $\mu_1$  takes  $(x, y)$  to  $(x, y) \cdot \mu_1 = (\frac{1+y^2}{x}, y)$ , whose correspond-

ing cluster  $[\frac{1+y^2}{x}, y]$  is mapped to  $[\frac{1+y^2}{x}, \frac{1+x+y^2}{xy}]$  by  $\phi$ , as shown in Figure 5.6.

Denote by  $\phi^\Delta \in \text{Aut } \Delta$  the automorphism which corresponds to  $\phi \in \text{Aut } \mathcal{E}$  and denote the quotient by the symmetric group action as  $\pi : \mathcal{S}^0 \rightarrow \mathcal{S}$ . Then  $\phi^\Delta(u)$  is a labelled seed in  $\mathcal{S}^0$  such that  $\pi(\phi^\Delta(u) \cdot \mu_1) = \phi(\pi(u \cdot \mu_1))$ . Hence the cluster variable which differs between  $[\frac{1+y^2}{x}, y]$  and  $[\frac{1+y^2}{x}, \frac{1+x+y^2}{xy}]$  needs to appear in the first position of the labelled cluster of  $\phi^\Delta(u)$  and so

$$\phi^\Delta(\mathbf{x}) = \left( y, \frac{1+y^2}{x} \right).$$

This shows that the rotation of  $\mathcal{E}$  actually corresponds to an automorphism of  $\Delta$  which interchanges the two components of the graph (see Figure 5.4) as well as rotating each component.

Note that this automorphism takes the diagram  $D = \circ \xrightarrow{2} \circ$  to its opposite  $D^{\text{op}}$ , however the matrix  $B = \begin{pmatrix} 0 & 1 \\ -2 & 0 \end{pmatrix}$  is not taken to  $-B$ , but rather to  $-B^T$ .

**Example 5.3.7.** Consider the exchange graph  $\mathcal{E}$  of the mutation class of type  $A_2$  shown in Figure 5.3, with the labelled exchange graph  $\Delta$  in Figure 5.2. An order 5 clockwise  $\frac{2\pi}{5}$  rotation  $\phi$  of  $\mathcal{E}$  is an exchange graph automorphism and so induces an automorphism  $\phi^\Delta$  of  $\Delta$ .

The cluster  $\mathbf{x} = [x, y]$  maps to  $\phi(\mathbf{x}) = [\frac{1+y}{x}, y]$ , so the labelled cluster  $\hat{\mathbf{x}} = (x, y)$  would be mapped to either  $(\frac{1+y}{x}, y)$  or  $(y, \frac{1+y}{x})$ . To determine which, consider the labelled clusters adjacent to  $(x, y)$ :

$$(x, y) \cdot \mu_1 = \left( \frac{1+y}{x}, y \right);$$

$$(x, y) \cdot \mu_2 = \left( x, \frac{1+x}{y} \right).$$

The cluster  $[\frac{1+y}{x}, y]$  is mapped to  $[\frac{1+y}{x}, \frac{1+x+y}{xy}]$  so we need to choose an ordering for  $\phi^\Delta(\hat{\mathbf{x}})$  such that  $\phi^\Delta(\hat{\mathbf{x}}) \cdot \mu_1$  corresponds to the same ordering of  $[\frac{1+y}{x}, \frac{1+x+y}{xy}]$ . These two clusters  $\phi(\mathbf{x}) = [\frac{1+y}{x}, y]$  and  $[\frac{1+y}{x}, \frac{1+x+y}{xy}]$  differ by replacing  $y$  with  $\frac{1+x+y}{xy}$ , while  $\mu_1$  changes the cluster variable in the first position, therefore the required ordering

is

$$\phi^\Delta(\hat{\mathbf{x}}) = \left(y, \frac{1+y}{x}\right) \quad \text{and} \quad \phi^\Delta(\hat{\mathbf{x}}) \cdot \mu_1 = \left(\frac{1+x+y}{xy}, \frac{1+y}{x}\right).$$

This shows that  $\phi$  induces the automorphism of  $\Delta$  given by clockwise  $\frac{6\pi}{5}$  rotation, which again has order 5.

**Remark 5.3.8.** It is not true in general that  $\text{Aut } \Delta(\mathcal{S}^0) \cong \text{Aut } \mathcal{E}(\mathcal{S})$ , as  $\Delta(\mathcal{S}^0)$  can have a number of connected components which are identified under the quotient by the symmetric group action. Any automorphism which changes a single connected component while fixing all others would therefore not project down to an automorphism of  $\mathcal{E}(\mathcal{S})$ . For example, in the case of the cluster algebra of type  $B_2$ , the labelled exchange graph automorphism given by rotating the top hexagon in Figure 5.4 while fixing the bottom hexagon would not give any valid exchange graph automorphism.

Given  $\phi \in \text{Aut } \mathcal{E}(\mathcal{S})$  then  $\phi^\Delta \in \text{Aut } \Delta(\mathcal{S}^0)$  is constructed in such a way that for  $\pi : \mathcal{S}^0 \rightarrow \mathcal{S}$  the quotient by the symmetric group action,  $u \in \mathcal{S}^0$  a labelled seed and  $\mu_k$  a single global mutation,

$$\phi(\pi(u)) = \pi(\phi^\Delta(u)),$$

$$\phi(\pi(u \cdot \mu_k)) = \pi(\phi^\Delta(u) \cdot \mu_k).$$

**Proposition 5.3.9.** *The inclusion  $\text{Aut } \mathcal{E}(\mathcal{S}) \hookrightarrow \text{Aut } \Delta(\mathcal{S}^0)$  is a homomorphism, that is  $(\psi\phi)^\Delta = \psi^\Delta\phi^\Delta$  for any exchange graph automorphisms  $\psi, \phi \in \text{Aut } \mathcal{E}(\mathcal{S})$ .*

*Proof.* Choose a labelled seed  $u \in \mathcal{S}^0$  then

$$\pi((\psi\phi)^\Delta(u)) = (\psi\phi)(\pi(u)) = \psi(\phi(\pi(u))) = \psi(\pi(\phi^\Delta(u))) = \pi(\psi^\Delta(\phi^\Delta(u))).$$

This shows that the labelled seeds  $(\psi\phi)^\Delta(u)$  and  $\psi^\Delta\phi^\Delta(u)$  are the same up to permutation, however for any  $k \in \{1, \dots, n\}$

$$\begin{aligned} \pi((\psi\phi)^\Delta(u) \cdot \mu_k) &= (\psi\phi)(\pi(u \cdot \mu_k)) = \psi(\phi(\pi(u \cdot \mu_k))) = \psi(\pi(\phi^\Delta(u) \cdot \mu_k)) \\ &= \pi(\psi^\Delta(\phi^\Delta(u) \cdot \mu_k)) \end{aligned}$$

so after mutation in the  $k$ -th vertex  $(\psi\phi)^\Delta(u)$  and  $\psi^\Delta\phi^\Delta(u)$  are the still same up to permutation. The only way that the  $k$ -th mutation affects two labelled seeds in the same way is if the labelled seeds are in fact equal and not permutations of one another, so

$$(\psi\phi)^\Delta(u) = \psi^\Delta\phi^\Delta(u) \quad \text{for any } u \in \mathcal{S}^0$$

and therefore  $(\psi\phi)^\Delta = \psi^\Delta\phi^\Delta$ .  $\square$

**Proposition 5.3.10.** *Let  $\phi \in \text{Aut } \mathcal{E}(\mathcal{S})$  with pullback  $\phi^\Delta \in \text{Aut } \Delta(\mathcal{S}^0)$ , then for any labelled seed  $u$  and any permutation  $\sigma$*

$$\phi^\Delta(u \cdot \sigma) = \phi^\Delta(u) \cdot \sigma.$$

Therefore although it looks like the construction of  $\phi^\Delta$  from  $\phi$  depends on the initial choice of ordering of  $u$ , any other ordering just gives a permutation of  $\phi^\Delta$ .

*Proof.* In  $\Delta(\mathcal{S}^0)$  there are edges  $u - v^i$  for each mutation  $\mu_i$ , applying  $\sigma$  gives edges  $u \cdot \sigma - v^i \cdot \sigma$  for each  $\mu_{\sigma(i)}$ . When projected  $\mathbf{x}(\phi[u]) = \mathbf{x}(\phi[u \cdot \sigma])$  and  $\mathbf{x}(\phi[v^i]) = \mathbf{x}(\phi[v^i \cdot \sigma])$  for each  $i$ .

The clusters  $\mathbf{x}(\phi[u]) = [a, \dots, k_i, \dots]$  and  $\mathbf{x}(\phi[v^i]) = [a, \dots, k'_i, \dots]$  differ in a single cluster variable  $k_i$  to  $k'_i$ . In the construction of  $\phi^\Delta(u)$  we specified an ordering  $\rho_u$  on  $\mathbf{x}(\phi[u])$  such that the  $i$ -th variable  $\rho_u(\mathbf{x}(\phi[u]))_i = k_i$  for each  $i$ . To construct  $\phi^\Delta(u \cdot \sigma)$  we need an ordering  $\rho_{u \cdot \sigma}$  such that the  $\sigma(i)$ -th variable  $\rho_{u \cdot \sigma}(\mathbf{x}(\phi[u]))_{\sigma(i)} = k_i$  so that the position of the variable which changes matches the label on the edge in  $\Delta$ . Therefore  $\mathbf{x}(\phi^\Delta(u \cdot \sigma)) = \rho_{u \cdot \sigma}(\mathbf{x}(\phi[u])) = \sigma(\rho_u(\mathbf{x}(\phi[u]))) = \sigma(\mathbf{x}(\phi^\Delta(u))) = \mathbf{x}(\phi^\Delta(u) \cdot \sigma)$ .  $\square$

So far in this section we have proved a number of properties of automorphisms of the exchange graph of a cluster algebra. In the remainder of this chapter we use these results to compare these exchange graph automorphisms to other automorphisms related to the cluster algebra.

**Theorem 5.3.11.** *For a labelled mutation class  $\mathcal{S}^0$  with corresponding mutation class  $\mathcal{S} = \mathcal{S}^0/\text{Sym}(n)$  and exchange graph  $\mathcal{E}(\mathcal{S})$*

$$\text{Aut}_{M_n}(\mathcal{S}^0) \cong \text{Aut } \mathcal{E}(\mathcal{S}).$$

*Proof.* Let  $\phi \in \text{Aut}_{M_n}(\mathcal{S}^0)$  and let  $\psi$  be the transformation of  $\mathcal{E}(\mathcal{S})$  given by  $\psi([u]) = [\phi(u)]$ . The automorphism  $\phi$  commutes with permutations so the choice of order of  $u$  does not matter, because for any other choice of order  $u'$  there is some permutation  $\sigma$  such that  $u' = u \cdot \sigma$  and then  $[\phi(u')] = [\phi(u \cdot \sigma)] = [\phi(u) \cdot \sigma] = [\phi(u)]$ .

For any two seeds  $u$  and  $v = u \cdot \mu$  related by a single mutation  $\mu$  there is an edge  $[u] - [v]$  in  $\mathcal{E}(\mathcal{S})$ . Then  $\psi([v]) = \psi([u \cdot \mu]) = [\phi(u \cdot \mu)] = [\phi(u) \cdot \mu] = \tilde{\mu}[\phi(u)] = \tilde{\mu}\psi([u])$  where  $\tilde{\mu}$  is the single local mutation on  $[u]$  corresponding to the global mutation  $\mu$  on  $u$ . Hence there is an edge  $\psi[u] - \psi[v]$  in  $\mathcal{E}(\mathcal{S})$ , so  $\psi \in \text{Aut } \mathcal{E}(\mathcal{S})$  and  $\text{Aut}_{M_n}(\mathcal{S}^0) \subset \text{Aut } \mathcal{E}(\mathcal{S})$ .

To show the converse, let  $\psi \in \text{Aut } \mathcal{E}(\mathcal{S})$  which pulls back to  $\psi^\Delta \in \text{Aut } \Delta(\mathcal{S}^0)$  by Theorem 5.3.5. Let  $\phi : \mathcal{S}^0 \rightarrow \mathcal{S}^0$  be the map given by  $u \mapsto \psi^\Delta(u)$ . Any element of  $M_n$  can be written as a product of mutations and permutations, so to prove  $\phi \in \text{Aut}_{M_n}(\mathcal{S}^0)$  it suffices to show that  $\phi$  commutes with any permutation and any mutation.

Let  $\sigma$  be a permutation, then by Proposition 5.3.10

$$\phi(\sigma u) = \psi^\Delta(\sigma u) = \sigma \psi^\Delta(u) = \sigma \phi(u).$$

Let  $u$  and  $v = u \cdot \mu$  be two labelled seeds related by a single mutation, then  $\psi^\Delta$  is an automorphism of  $\Delta(\mathcal{S}^0)$ , so

$$\phi(u \cdot \mu) = \psi^\Delta(u \cdot \mu) = \psi^\Delta(u) \cdot \mu = \phi(u) \cdot \mu. \quad \square$$

## 5.4 Cluster automorphisms

Cluster automorphisms were first introduced by Assem, Schiffler and Shramchenko in [ASS12]. In their paper the authors computed some particular examples of

automorphism groups and drew links between automorphisms of the cluster algebra of a surface and the mapping class group of that surface. This correspondence was later proved by Brüstle and Qiu in [BQ15] for all surfaces except a select few, as discussed in Section 5.7.

**Definition 5.4.1** ([ASS12]). A  $\mathbb{K}$ -automorphism  $f$  is a **cluster automorphism** of  $\mathcal{A}(\mathcal{S})$  if there exists a seed  $(\mathbf{x}, B)$  in  $\mathcal{S}$  such that

1.  $f(\mathbf{x})$  is a cluster.
2. for every  $x \in \mathbf{x}$  we have  $f(\mu_{x,\mathbf{x}}(\mathbf{x})) = \mu_{f(x),f(\mathbf{x})}(f(\mathbf{x}))$ .

Cluster automorphisms were originally only defined for skew-symmetric matrices and hence quivers, but the same definitions and some results can be applied to skew-symmetrizable matrices as well. The cluster automorphism groups in this setting were first studied by Chang and Zhu in [CZ15] and [CZ16a]. Recall that throughout this chapter we assume that the cluster  $\mathbf{x}$  of a seed uniquely determines the seed's matrix, and in this case the matrix is denoted  $B(\mathbf{x})$ .

**Lemma 5.4.2** ([ASS12, Lem. 2.3],[CZ15, Lem. 2.9]). *If  $f$  is an  $\mathcal{F}$ -automorphism, then  $f$  is a cluster automorphism if and only if there exists a seed  $(\mathbf{x}, B)$  such that  $f(\mathbf{x})$  is a cluster and  $B(f(\mathbf{x})) = B$  or  $-B$ .*

The definition of a cluster automorphism only requires that there exists a single seed such that the image is a seed and the automorphism is compatible with mutations of that seed, however the compatibility with mutations allows these properties to be extended to all seeds in the cluster algebra.

**Proposition 5.4.3** ([ASS12, Prop. 2.4]). *Let  $f$  be a cluster automorphism of a cluster algebra  $\mathcal{A}$ , then  $f$  satisfies the conditions in Definition 5.4.1 and Lemma 5.4.2 for every seed in  $\mathcal{A}$ .*

This therefore gives two ways of thinking of cluster automorphisms as either automorphisms taking clusters to clusters which are compatible with mutations or as automorphisms which fix exchange matrices (up to multiplication by -1).

**Definition 5.4.4.** A cluster automorphism which fixes exchange matrices is called a **direct** cluster automorphism, whereas those which send an exchange matrix  $B$  to  $-B$  are called **inverse** cluster automorphisms.

Cluster automorphisms form a group, so let  $\text{Aut } \mathcal{A}$  denote the group of all cluster automorphisms of  $\mathcal{A}$ , and  $\text{Aut}^+ \mathcal{A}$  be the subgroup of direct cluster automorphisms.

**Proposition 5.4.5** ([ASS12, Lem. 2.9, Thm. 2.11]). *Let  $\mathcal{A}$  be a cluster algebra generated by an exchange matrix  $B$ . If  $B$  is mutation-equivalent to  $-B$  then  $\text{Aut}^+ \mathcal{A}$  is a normal subgroup of  $\text{Aut } \mathcal{A}$  with index 2, otherwise  $\text{Aut}^+ \mathcal{A} = \text{Aut } \mathcal{A}$ .*

Cluster automorphisms arise naturally in the labelled seed and global mutation setting introduced by King and Pressland, with the following correspondence:

**Theorem 5.4.6** ([KP16, Cor. 6.3]). *If  $\mathcal{S}$  is the mutation class of a seed  $(\mathbf{x}, Q)$  where  $Q$  is a skew-symmetric mutation-finite matrix then*

$$\text{Aut}_{M_n}(\mathcal{S}^0) \cong \text{Aut } \mathcal{A}(\mathcal{S}).$$

Combining Theorem 5.4.6 with Theorem 5.3.11 gives the following:

**Corollary 5.4.7.** *For a cluster algebra  $\mathcal{A}$  constructed from a mutation-finite quiver with exchange graph  $\mathcal{E}_{\mathcal{A}}$*

$$\text{Aut } \mathcal{E}_{\mathcal{A}} \cong \text{Aut } \mathcal{A}.$$

Chang and Zhu provide an alternative proof of this in [CZ15] and extend the result to certain finite type skew-symmetrizable matrices:

**Theorem 5.4.8** ([CZ15, Thm. 3.7]). *If  $\mathcal{S}$  is the mutation class of a seed  $(\mathbf{x}, B)$  where  $B$  is a skew-symmetrizable matrix of Dynkin type  $B_n$  or  $C_n$  for  $n \geq 3$  then*

$$\text{Aut } \mathcal{A}(\mathcal{S}) = \text{Aut } \mathcal{E}_{\mathcal{A}}(\mathcal{S}).$$

**Remark 5.4.9.** Maximal green sequences, discussed in Section 4.3, are sequences of mutations which fix a quiver and as such they induce a cluster automorphism.

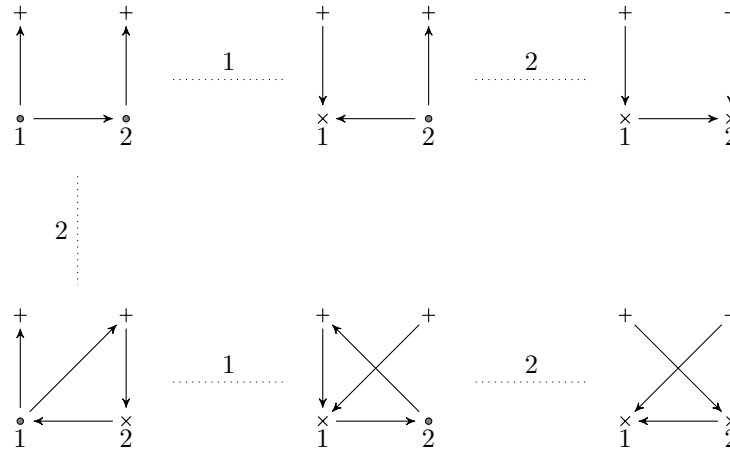

Figure 5.7: The two maximal green sequences of the quiver of type  $A_2$  starting with its framed quiver. The top green sequence is  $\mu_1 \cdot \mu_2$  and the bottom is  $\mu_2 \cdot \mu_1 \cdot \mu_2$ . The two resulting quivers are both isomorphic to the coframed quiver of the quiver of type  $A_2$ . Green vertices are shown as circles, red vertices as crosses and frozen vertices as plusses.

**Example 5.4.10.** The quiver of type  $A_2$  has two maximal green sequences given by  $\mu_1 \cdot \mu_2$  and  $\mu_2 \cdot \mu_1 \cdot \mu_2$  as illustrated in Figure 5.7.

If the initial labelled seed is  $(Q, \mathbf{x})$  with cluster  $\mathbf{x} = (x, y)$ , then the resulting cluster after these green sequences induces a cluster automorphism as shown below. The sequence  $\mu_2 \cdot \mu_1 \cdot \mu_2$  does not give the same quiver, but after the permutation (12) it does:

$$(Q, (x, y)) \cdot \mu_1 \cdot \mu_2 = \left( Q, \left( \frac{1+y}{x}, \frac{1+x+y}{xy} \right) \right) = (Q, (x, y)) \cdot \mu_2 \cdot \mu_1 \cdot \mu_2 \cdot (12).$$

These both give the same cluster automorphism  $x \mapsto \frac{1+y}{x}$  and  $y \mapsto \frac{1+x+y}{xy}$ .

## 5.5 Generalising automorphisms to the skew-symmetrizable case

Theorems 5.4.6 and 5.4.8 show that cluster automorphisms are linked to the automorphisms of the exchange graph for mutation-finite skew-symmetric matrices as well as a specific family of skew-symmetrizable matrices. However, in general the

exchange graph automorphism group for any mutation-finite skew-symmetrizable matrix is larger than the cluster automorphism group.

An example of this would be the exchange graph automorphism of the mutation class of  $B_2$  considered in Example 5.3.6. This graph automorphism does not correspond to a cluster automorphism as the initial matrix  $B$  is sent to  $-B^T \neq \pm B$ .

In this section we aim to generalise the results of the previous section to the skew-symmetrizable case. To do this we introduce additional structure on the exchange graph, which defines a marked exchange graph. This extra structure ensures that any graph automorphism fixing this structure corresponds to a cluster automorphism. In this way the study of cluster automorphisms can be reduced to the combinatorial study of graph automorphisms.

### 5.5.1 Marked exchange graph

Let  $B$  be a skew-symmetrizable matrix, with symmetrizing matrix  $D$ . If  $\mu_i$  is any mutation, then  $D$  is also the symmetrizing matrix for  $B \cdot \mu_i$ . Similarly for any permutation  $\sigma$  the permuted matrix  $D \cdot \sigma = \text{diag}(d_i^\sigma) = \text{diag}(d_{\sigma^{-1}(i)})$  is the symmetrizing matrix for  $B \cdot \sigma = B^\sigma$ .

**Definition 5.5.1.** The **marked labelled exchange graph** of a mutation class generated by  $u = (\mathbf{x}, B)$  where  $B$  is a skew-symmetrizable matrix with symmetrizing matrix  $D = \text{diag}(d_i)$  is the labelled exchange graph with an additional marking on each edge. Each edge corresponds to a global mutation  $\mu_i$  for some  $i$ , so mark that edge with the symmetrizing entry  $d_i$ .

If a permutation  $\sigma$  acts on  $u$  to give a labelled seed in a different component of  $\Delta(\mathcal{S}^0)$ , then mark the  $i$ -th edges with  $d_i^\sigma$ , where  $D \cdot \sigma = \text{diag}(d_i^\sigma)$ .

In the exchange graph  $\mathcal{E}$  each edge no longer corresponds to a global mutation  $\mu_i$ , but rather to a local mutation  $\mu_{\beta, \mathbf{x}}$  at a specific cluster variable  $\beta$  in a cluster  $\mathbf{x}$ .

For a permutation  $\sigma$  and permuted seed  $(\mathbf{x}, B) \cdot \sigma = (\mathbf{x}^\sigma, B^\sigma)$ , then the edge  $\mu_{\sigma(i)}$  adjacent to this seed corresponds to the local mutation  $\mu_{\beta_{\sigma(i)}, [\mathbf{x}^\sigma]} = \mu_{\beta_i, [\mathbf{x}]}$  as  $\beta_{\sigma(i)}^\sigma =$

$\beta_{\sigma^{-1}(\sigma(i))} = \beta_i$  and  $[\mathbf{x}^\sigma] = [\mathbf{x}]$ . This edge  $\mu_{\sigma(i)}$  is marked with  $d_{\sigma(i)}^\sigma = d_{\sigma^{-1}(\sigma(i))} = d_i$  and hence in the quotient the edge  $\mu_{\beta_i, \mathbf{x}}$  has a consistent marking, so the following is well-defined.

**Definition 5.5.2.** Let  $\widehat{\mathcal{E}}(\mathcal{S})$  be the **marked exchange graph** of a mutation class  $\mathcal{S}$  given by taking the quotient of the marked labelled exchange graph with respect to the symmetric group action.

Alternatively let  $B$  be a skew-symmetrizable matrix, with symmetrizing matrix  $D$  and let  $R$  be the diagram corresponding to  $B$  so each row in  $B$  represents a vertex in  $R$ . Each diagonal entry in  $D$  can be thought of as being attached to that row's vertex of  $R$ , and the edge in  $\widehat{\mathcal{E}}$  representing mutation in that vertex should be marked with this diagonal entry.

**Example 5.5.3** ( $B_3$ ). The marked exchange graph of the cluster algebra of type  $B_3$  is shown in Figure 5.8. The cluster variables are not written out in full, rather only the denominators are shown with a bar above except for the initial cluster variables  $x_1, x_2$  and  $x_3$  which are shown with a bar underneath. Each vertex is adjacent to two dotted edges and one dashed edge.

Choosing a matrix in the mutation class, the symmetrizing matrix is  $\text{diag}(2, 1, 1)$ :

$$\begin{pmatrix} 0 & 2 & 0 \\ -1 & 0 & 1 \\ 0 & -1 & 0 \end{pmatrix} \begin{pmatrix} 2 & 0 & 0 \\ 0 & 1 & 0 \\ 0 & 0 & 1 \end{pmatrix} = \begin{pmatrix} 0 & 2 & 0 \\ -2 & 0 & 1 \\ 0 & -1 & 0 \end{pmatrix}.$$

The dotted edges correspond to mutations in the vertices with symmetrizing entry 1, while the dashed edge corresponds to the mutation in the vertex with symmetrizing entry 2.

In this case, any automorphism of the unmarked exchange graph sends dashed edges to dashed edges, so automatically preserves the markings and hence  $\text{Aut } \mathcal{E} = \text{Aut } \widehat{\mathcal{E}}$ .

**Example 5.5.4** ( $B_2$ ). The marked exchange graph of the cluster algebra of type  $B_2$  is shown in Figure 5.9, where dotted edges correspond to mutations in vertices with

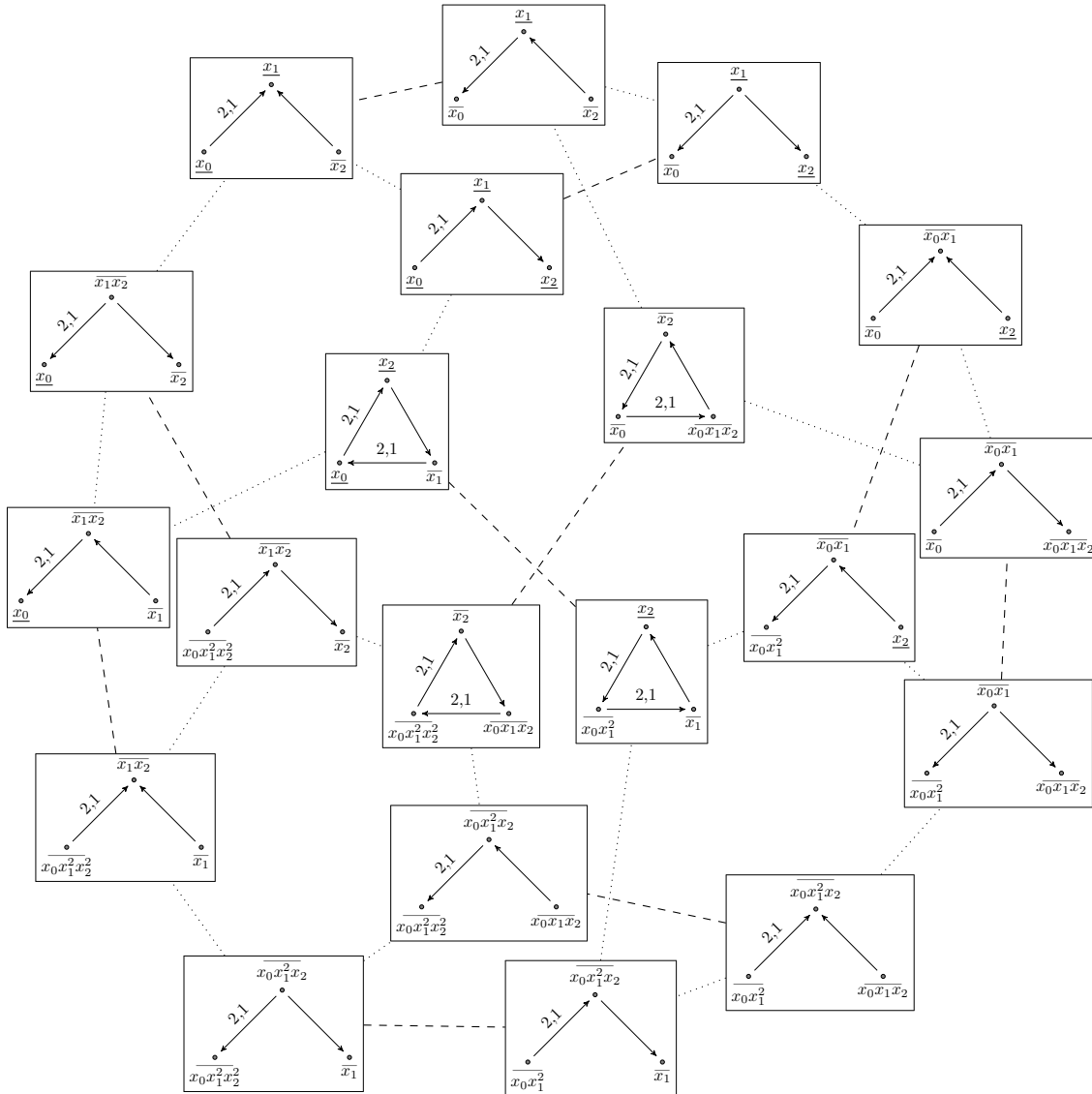

Figure 5.8: Marked exchange graph of type  $B_3$ . Dotted edges correspond to a symmetrizing entry of 1, while dashed edges correspond to 2. Only denominators are shown in the cluster variables with a bar above each, unless the cluster variable is one of  $x_1, x_2$  or  $x_3$  where the variable is shown with a bar underneath.

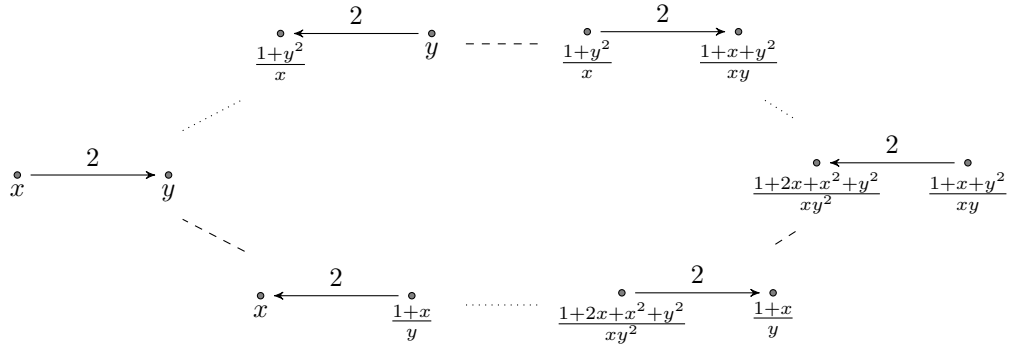

Figure 5.9: Marked exchange graph for cluster algebra of type  $B_2$ . Dotted edges correspond to mutations in a vertex with symmetrizer 1 while dashed edges correspond to symmetrizer 2.

symmetrizer 1 and dashed edges correspond to symmetrizer 2. The initial matrix for the cluster  $[x, y]$  was chosen to be  $\begin{pmatrix} 0 & 1 \\ -2 & 0 \end{pmatrix}$  with symmetrizing matrix  $\text{diag}(1, 2)$ .

The automorphism considered in Example 5.3.6, given by a rotation of angle  $\frac{\pi}{3}$ , does not fix the markings in the graph, so is not an automorphism of the marked graph.

**Remark 5.5.5.** For any skew-symmetric matrix the symmetrizing matrix is the identity, so all markings would be the same and  $\mathcal{E}_{\mathcal{A}} = \widehat{\mathcal{E}}_{\mathcal{A}}$ .

**Remark 5.5.6.** For a cluster algebra of Dynkin type  $B_n$  or  $C_n$ , for  $n \geq 3$ , the marking on the exchange graph does not limit the number of automorphisms, so  $\text{Aut } \mathcal{E}_{\mathcal{A}} = \text{Aut } \widehat{\mathcal{E}}_{\mathcal{A}}$ . This follows from Theorem 3.7 in Chang and Zhu’s paper [CZ15] linking exchange graph automorphisms and cluster automorphisms.

### 5.5.2 Geodesic loops

**Definition 5.5.7** ([CZ16b, Def. 2.25]). Let  $\mathcal{E}$  be an exchange graph of a seed  $u = (x, B)$  with vertices labelled  $(v_i)_{i \in \{1, \dots, n\}}$ . For a subset of vertices  $\{v_k\}$  the **frozenisation** of  $u$  with respect to  $\{v_k\}$  is the mutation class constructed by freezing all vertices in  $\{v_k\}$ .

It is often more convenient to consider the **cofrozenisation** of  $u$  with respect to  $\{v_k\}$ , denoted  $u \setminus \{v_k\}$ , which is constructed by freezing all vertices in  $u$  except those

in  $\{v_k\}$ . This is then a frozenisation of  $u$  with respect to  $\{v_i\} - \{v_k\}$ .

**Definition 5.5.8** ([FZ03, Sec. 2]). A **geodesic loop**  $\mathcal{L} = \mathcal{L}_u^{a,b}$  is the exchange graph of a cofrozenisation  $u \setminus \{a, b\}$  which leaves only two vertices  $a$  and  $b$  unfrozen. A loop is then either a polygon with 4, 5, 6 or 8 sides or an infinite line, which embeds into the exchange graph of the mutation class of  $u$ .

The **distance** between a geodesic loop  $\mathcal{L}$  and any vertex  $v$  in  $\mathcal{E}$  is the (possibly zero) minimum number of edges in  $\mathcal{E}$  between  $v$  and any vertex in  $\mathcal{L}$ .

The **length** of a geodesic loop  $\text{Len}(\mathcal{L}) \in \{4, 5, 6, 8, \infty\}$  is the number of edges in the loop.

Geodesic loops as subgraphs of a larger exchange graph give rise to the following sets, which encode the information about a given seed represented by a vertex of the exchange graph. The following construction is a slight notational variation of the one given by Chang and Zhu in Definition 3.1 of [CZ15].

**Definition 5.5.9.** Let  $u$  be a seed of rank  $n$  in an exchange graph, then define  $N^0(u)$  to be the set of  $\binom{n}{2}$  numbers given by the length of all geodesic loops distance 0 from  $u$ . Similarly define  $N^1(u)$  to be the set of  $n \binom{n-1}{2}$  numbers given by the lengths of all geodesic loops distance 1 from  $u$ .

**Remark 5.5.10.** An exchange graph automorphism  $\phi \in \text{Aut } \mathcal{E}$  induces an automorphism  $\phi^\Delta \in \text{Aut } \Delta$  and in this way  $\phi$  induces a map  $\phi_v$  which takes cluster variables in a seed  $u$  to variables in  $\phi(u)$ .

A geodesic loop  $\mathcal{L}_u^{a,b}$  in an exchange graph  $\mathcal{E}$  must get mapped to another geodesic loop of the same length by any exchange graph automorphism, however it is not clear that the image of  $\mathcal{L}_u^{a,b}$  will be generated by the cofrozenisation  $\phi(u) \setminus \{\phi_v(a), \phi_v(b)\}$  rather than another cofrozenisation with two different unfrozen vertices in  $u$ . The following Lemma explains that this must always be the case.

**Lemma 5.5.11.** *Let  $u$  be a seed in a cluster algebra  $\mathcal{A}$  and  $\phi \in \text{Aut } \mathcal{E}_{\mathcal{A}}$ . For any two vertices  $a$  and  $b$  the geodesic loop  $\mathcal{L}_u^{a,b}$  is isomorphic to its image  $\mathcal{L}_{\phi(u)}^{\phi_v(a), \phi_v(b)}$ .*

*Proof.* Choose some ordering on  $u$  so that the vertices  $a = v_i$  and  $b = v_j$  are indexed by  $i$  and  $j$  respectively, then the length of the geodesic loop specifies a relation  $u = u \cdot \mu_i \mu_j \mu_i \cdots$ .

For example if the loop has length 6, then  $u = u \cdot (\mu_i \mu_j)^3$ , whereas if the length is 5 then  $u = u \cdot \mu_i \mu_j \mu_i \mu_j \mu_i$ .

The exchange graph automorphism  $\phi$  corresponds to some  $\phi_{M_n} \in \text{Aut}_{M_n}$  which commutes with the action of  $M_n$ . Hence

$$\phi_{M_n}(u) = \phi_{M_n}(u \cdot \mu_i \mu_j \cdots) = \phi_{M_n}(u) \cdot \mu_i \mu_j \cdots$$

so the geodesic loop  $\mathcal{L}_{\phi(u)}^{\phi_v(a), \phi_v(b)}$  has the same length as the geodesic loop  $\mathcal{L}_u^{a,b}$ , and hence the two loops are isomorphic.  $\square$

Exchange graph automorphisms preserve the combinatorial structure around a seed. As these automorphisms are compatible with mutations the above result could be extended to the exchange graphs of cofrozenisations with any number of unfrozen vertices.

**Lemma 5.5.12.** *If  $\phi \in \text{Aut } \mathcal{E}$  is an exchange graph automorphism, with  $u$  a seed and  $v = \phi(u)$  its image, then  $N^0(u) = N^0(v)$  and  $N^1(u) = N^1(v)$ .*

**Lemma 5.5.13.** *Given a mutation-finite diagram with at least 3 vertices, the exchange graph of a frozenisation leaving just two vertices unfrozen determines the weight on the arrow between the two unfrozen vertices.*

*Proof.* The exchange graph of the frozenisation leaving just two vertices  $a$  and  $b$  unfrozen is a geodesic loop  $\mathcal{L}^{a,b}$  with length  $\text{Len}(\mathcal{L}) \in \{4, 5, 6, 8, \infty\}$ .

If  $\text{Len}(\mathcal{L}) = 4$  then the vertices have no arrow between them, while if  $\text{Len}(\mathcal{L}) = 5$  there is a single unweighted arrow. If  $\text{Len}(\mathcal{L}) = 6$  then there is an arrow weighted 2 and  $\text{Len}(\mathcal{L}) = 8$  shows there is an arrow weighted 3.

The highest edge weight in a mutation-finite diagram (with more than 2 vertices) is 4, so  $\text{Len}(\mathcal{L}) = \infty$  implies that there is an arrow weighted 4.  $\square$

**Remark 5.5.14.** For any 2-vertex diagram  $B$ , an edge weight of 4 or more will always give  $\text{Len}(\mathcal{L}) = \infty$ , so the exchange graph cannot determine this weight. However the only diagrams mutation-equivalent to  $B$  are  $B$  and  $B^{\text{op}}$ , so all diagrams in the same mutation class have the same edge weight.

### 5.5.3 Exchange graph automorphism effects on diagrams and matrices

**Lemma 5.5.15.** *An exchange graph automorphism  $\phi \in \text{Aut } \mathcal{E}$  takes a seed  $u = (x, B)$  to another seed  $v = \phi(u) = (x', B')$  where the unoriented diagram of  $B'$  is the same as the unoriented diagram of  $B$ .*

*Proof.* Fix any two vertices  $u_0$  and  $u_1$  in  $u$ . Under  $\phi_v$  these vertices are mapped to corresponding vertices  $\phi_v(u_0) = v_0$  and  $\phi_v(u_1) = v_1$  in  $v$ .

The weight on (or absence of) the arrow between  $u_0$  and  $u_1$  determines the exchange graph  $\mathcal{E}_u$  of the cofrozenisation  $u \setminus \{u_0, u_1\}$ . By Lemma 5.5.11,  $\mathcal{E}_u$  is isomorphic to the exchange graph  $\mathcal{E}_v$  of the cofrozenisation  $v \setminus \{v_0, v_1\}$ . Hence this exchange graph determines the arrow between  $v_0$  and  $v_1$  by Lemmas 5.5.12 and 5.5.13, which necessarily must be the same as that between  $u_0$  and  $u_1$ .  $\square$

This shows that the unoriented diagrams of two seeds related by an exchange graph automorphism must be the same. To see how exchange graphs automorphisms affect the orientations of the arrows we need to consider frozenisations with three unfrozen vertices.

**Lemma 5.5.16.** *For any seed  $u = (x, B)$  with 3 vertices in an exchange graph of a mutation-finite skew-symmetrizable diagram, the diagram of  $B$  is determined by the sets  $N^0(u)$  and  $N^1(u)$ , up to reversing all arrows.*

*Proof.* The unoriented diagram of  $B$  is determined by  $N^0(u) = \{n_i\}$ , where each  $n_i \in \{4, 5, 6, 8, \infty\}$  determines a weighted arrow, or absence of arrow, between two vertices.

The orientation of  $B$  (up to reversing all arrows) is given by  $N^1(u)$  as shown in Tables 5.1, 5.2 and 5.3, where all mutation-finite 3-vertex diagrams are illustrated along with their defining sets  $N^0$  and  $N^1$ . Hence the pair  $(N^0, N^1)$  defines a unique diagram, up to reversing all arrows.  $\square$

In the case  $N^0(u) = \{4, 4, \infty\}$  the diagram is of the form:

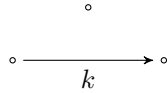

where the weight satisfies  $k \geq 4$  and so the diagram is not uniquely determined. However if  $k > 4$  then the resulting diagram will never appear as a subdiagram of any larger mutation-finite diagram. This is precisely the setup used in the proofs below and so  $N^0(u) = \{4, 4, \infty\}$  is always assumed to correspond to a diagram of the form:

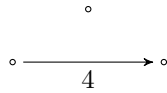

**Proposition 5.5.17.** *Let  $\phi \in \text{Aut } \mathcal{E}$  be an exchange graph automorphism and  $u = (\mathbf{x}, B)$  a seed where  $B$  is a mutation-finite skew-symmetrizable matrix with corresponding connected diagram  $R$ . In the image  $\phi(u) = (\mathbf{x}', B')$ , the diagram  $R'$  corresponding to the matrix  $B'$  is either  $R$  or  $R^{\text{op}}$ .*

*Proof.* Choose any 3 vertices  $a, b, c$  in  $u$ , then by Lemma 5.5.11 there is an isomorphism  $\mathcal{E}(u \setminus \{a, b, c\}) \cong \mathcal{E}(\phi(u) \setminus \{\phi(a), \phi(b), \phi(c)\})$  and  $N^0(u) = N^0(\phi(u))$ ,  $N^1(u) = N^1(\phi(u))$ . Therefore by Lemma 5.5.16 the subdiagram  $S$  of  $R$  consisting just of the arrows between  $a, b$  and  $c$  is the same as the subdiagram  $S'$  of  $R'$  consisting of the arrows between  $\phi(a), \phi(b)$  and  $\phi(c)$ , up to reversing all arrows.

Choose a fourth vertex  $d$  and consider the 3-vertex subdiagram  $S_a$  on the vertex set  $\{b, c, d\}$ . By the same reasoning as above the image  $S'_a = \phi(S_a)$  must be the same, but possibly with all arrows reversed. However both  $S'$  and  $S'_a$  share the edge between vertices  $\phi(b)$  and  $\phi(c)$ , so if  $S' = S^{\text{op}}$  then  $S'_a = S_a^{\text{op}}$  whereas if  $S' = S$  then  $S'_a = S_a$ .

Diagram	$N^0$	$N^1$
	$\{4, 4, 5\}$	$\{4, 4, 5\}$
	$\{4, 4, 6\}$	$\{4, 4, 6\}$
	$\{4, 4, 8\}$	$\{4, 4, 8\}$
	$\{4, 4, \infty\}$	$\{4, 4, \infty\}$
	$\{4, 4, 4\}$	$\{4, 4, 4\}$

Table 5.1: Disconnected 3-vertex diagrams determined by values of  $N^0$ .

Diagram	$N^0$	$N^1$
	$\{4, 5, 5\}$	$\{5, 5, 5\}$
	$\{4, 5, 5\}$	$\{4, 5, 5\}$
	$\{5, 5, 5\}$	$\{4, 4, 4\}$
	$\{5, 5, 5\}$	$\{5, 5, \infty\}$
	$\{5, 5, \infty\}$	$\{5, 5, 5\}$

Table 5.2: Connected skew-symmetric 3-vertex diagrams determined by values of  $N^0$  and  $N^1$ .

Diagram	$N^0$	$N^1$
	$\{4, 5, 8\}$	$\{5, 8, 8\}$
	$\{4, 5, 8\}$	$\{4, 5, 8\}$
	$\{5, 8, 8\}$	$\{4, 4, \infty\}$
	$\{8, 8, \infty\}$	$\{5, 8, 8\}$
	$\{4, 5, 6\}$	$\{5, 6, 6\}$
	$\{4, 5, 6\}$	$\{4, 5, 6\}$
	$\{5, 6, 6\}$	$\{4, 4, 5\}$
	$\{4, 6, 6\}$	$\{4, 6, \infty\}$
	$\{4, 6, 6\}$	$\{4, 6, 6\}$
	$\{6, 6, \infty\}$	$\{4, 6, 6\}$

Table 5.3: Connected skew-symmetrizable 3-vertex diagrams determined by values of  $N^0$  and  $N^1$ .

As  $R$  is connected, by successively choosing different vertices, the whole diagram  $R'$  must either be the same as  $R$  or  $R^{\text{op}}$ .  $\square$

This shows that any exchange graph automorphism takes clusters to clusters and a diagram to itself or its opposite. However this is not enough to show that these automorphisms are cluster automorphisms, as this requires the matrix  $B$  of the diagram to be sent to  $\pm B$ . For this we require the markings on the exchange graph.

**Proposition 5.5.18.** *Given a marked exchange graph automorphism  $\phi \in \text{Aut } \widehat{\mathcal{E}}$  and a seed  $u = (x, B)$  with image  $\phi(u) = (x', B')$ , then the matrix  $B' = B$  or  $-B$ .*

*Proof.* Let  $R$  be the diagram associated to  $B$ , and let  $R'$  be the diagram associated to  $B'$ . Let  $D_B$  be the symmetrizing matrix for  $B$ , each vertex  $v_k$  in  $u$  has a symmetrizing multiplier, which marked exchange graph automorphisms preserve, so each vertex  $\phi_v(v_k)$  in  $\phi(u)$  has the same symmetrizing multiplier as  $v_k$  and  $D_B = D_{B'}$ .

By Proposition 5.5.17,  $R'$  is the same as  $R$  or  $R^{\text{op}}$  with symmetrizing matrix  $D_{B'} = D_B$  which defines the skew-symmetrizable matrix  $B' = B$  or  $-B$ .  $\square$

These results ensure that a marked exchange graph automorphism fixes matrices in seeds and so correspond to cluster automorphisms. In this way we generalise Corollary 5.4.7 to all mutation-finite skew-symmetrizable matrices.

**Theorem 5.5.19.** *If  $\mathcal{S}$  is a mutation class generated by an initial seed  $(\mathbf{x}, B)$ , where  $B$  is a mutation-finite skew-symmetrizable matrix, with cluster algebra  $\mathcal{A} = \mathcal{A}(\mathcal{S})$  and marked exchange graph  $\widehat{\mathcal{E}}_{\mathcal{A}}$  then*

$$\text{Aut } \mathcal{A} = \text{Aut } \widehat{\mathcal{E}}_{\mathcal{A}}.$$

*Proof.* A cluster automorphism  $f \in \text{Aut } \mathcal{A}$  satisfies the following properties:

- $f(\mathbf{x})$  is a cluster
- $f$  is compatible with mutations
- $B(f(\mathbf{x})) \cong B$  or  $-B$

for all seeds  $(x, B)$  in the mutation class  $\mathcal{S}$ . Such an automorphism induces an automorphism of the exchange graph, and as  $f$  sends a matrix  $B$  to  $\pm B$  it also fixes the symmetrizing matrix so fixes the marking on the exchange graph. Therefore  $f \in \text{Aut } \widehat{\mathcal{E}}_{\mathcal{A}}$  and  $\text{Aut } \mathcal{A} \subset \text{Aut } \widehat{\mathcal{E}}_{\mathcal{A}}$ .

To show that  $\text{Aut } \widehat{\mathcal{E}}_{\mathcal{A}} \subset \text{Aut } \mathcal{A}$  let  $(\mathbf{x}, B)$  be a labelled seed, with mutation class  $\mathcal{S}^0$  and quotient  $\mathcal{S}$ . If  $\phi \in \text{Aut } \widehat{\mathcal{E}}(\mathcal{S}) \subset \text{Aut } \mathcal{E}(\mathcal{S})$ , then by Theorem 5.3.5 this pulls back to an automorphism  $\phi^\Delta \in \text{Aut } \Delta(\mathcal{S}^0)$ . Then the image  $\phi^\Delta(\mathbf{x}) = (y_1, \dots, y_n)$  where  $\mathbf{x} = (x_1, \dots, x_n)$  gives an automorphism  $f : \mathbb{C}(x_1, \dots, x_n) \rightarrow \mathbb{C}(x_1, \dots, x_n)$  defined by  $f(x_i) = y_i$ .

This  $f$  then corresponds to  $\phi$ , so  $f(\mathbf{x})$  is a cluster and it remains to show that  $B(f(\mathbf{x})) = \pm B = \pm B(\mathbf{x})$ , however this follows from Proposition 5.5.18 so  $f \in \text{Aut } \mathcal{A}$ .  $\square$

## 5.6 Unfoldings

Many skew-symmetrizable matrices  $B$  have unfoldings to skew-symmetric matrices  $C$ , which extend to seeds, where a given seed in  $\mathcal{S}(B)$  unfolds to a seed in  $\mathcal{S}(C)$ . The corresponding exchange graphs are related, with the marked exchange graph  $\widehat{\mathcal{E}}(B)$  embedding into the exchange graph  $\mathcal{E}(C)$  provided edges marked in certain ways split into multiple edges.

**Definition 5.6.1** ([FST12b, Sec. 4]). Given a skew-symmetrizable  $n \times n$  matrix  $B = (b_{i,j})$  with symmetrizing matrix  $D = \text{diag}(d_i)$ , let  $m = \sum_{j=1}^n d_j$  and partition the set  $\{1, \dots, m\}$  into  $n$  disjoint consecutive index sets  $E_i$  such that  $|E_j| = d_j$  for all  $j$ .

Construct a skew-symmetric  $m \times m$  matrix  $C$  where:

1. The sum of entries in each column of each  $E_i \times E_j$  block equals  $b_{i,j}$ ;
2. If  $b_{i,j} > 0$  then all entries in the  $E_i \times E_j$  block are non-negative;
3. All entries in each  $E_i \times E_i$  block are zero.

Given  $i \in \{1, \dots, n\}$  and any  $j, k \in E_i$  the corresponding mutations  $\mu_j$  and  $\mu_k$  commute. The  $i$ -th **composite mutation**  $\tilde{\mu}_i$  of  $C$  is given by

$$\tilde{\mu}_i = \prod_{j \in E_i} \mu_j.$$

The matrix  $C$  is the **unfolding** of  $B$  if the matrix  $C' = C \cdot (\tilde{\mu}_{k_1} \tilde{\mu}_{k_2} \cdots \tilde{\mu}_{k_r})$  satisfies the conditions 1 and 2 above with respect to the matrix  $B' = B \cdot (\mu_{k_1} \mu_{k_2} \cdots \mu_{k_r})$  for any sequence of mutations  $\mu_{k_i}$  with corresponding composite mutations  $\tilde{\mu}_{k_i}$ .

A labelled seed  $([\beta_i], B)$ , with skew-symmetrizable matrix  $B$ , unfolds in the same way to  $([\gamma_i], C)$  where  $C$  is the unfolding of  $B$ . The  $j$ -th row in  $B$  corresponds to the cluster variable  $\beta_j$  and this row unfolds to  $d_j$  rows in  $C$ , hence  $\beta_j$  unfolds to  $d_j$  cluster variables  $\{\gamma_{j_1}, \dots, \gamma_{j_{d_j}}\}$ .

**Remark 5.6.2.** A diagram has a finite number of distinct matrix representations, each of which may give different unfoldings, or may not admit any unfolding. Almost all mutation-finite matrices have an unfolding.

**Definition 5.6.3.** Given a permutation  $\sigma \in \text{Sym}(n)$  of the initial seed, construct the **composite permutation**  $\tilde{\sigma} \in \text{Sym}(m)$  to be the permutation given by:

$$\begin{array}{ccc} \{1, \dots, m\} & \xlongequal{\hspace{2cm}} & E_1, E_2, \dots, E_n \\ \tilde{\sigma} \uparrow & & \downarrow \\ \{\tilde{\sigma}^{-1}(1), \dots, \tilde{\sigma}^{-1}(m)\} & \xlongequal{\hspace{2cm}} & E_{\sigma^{-1}(1)}, E_{\sigma^{-1}(2)}, \dots, E_{\sigma^{-1}(n)} \end{array}$$

**Theorem 5.6.4.** Given a skew-symmetrizable matrix  $B$  which unfolds to a matrix  $C$ , with corresponding marked exchange graphs  $\hat{\mathcal{E}}(B)$  and  $\mathcal{E}(C) = \hat{\mathcal{E}}(C)$ , then

$$\text{Aut } \hat{\mathcal{E}}(B) \hookrightarrow \text{Aut } \mathcal{E}(C).$$

*Proof.* Choose an initial  $n \times n$  labelled seed  $u = ([\beta_i], B)$  which unfolds to the  $m \times m$  labelled seed  $([\gamma_i], C)$  with index sets  $E_k$  for  $k = 1, \dots, n$  and  $\beta_i \rightsquigarrow \{\gamma_j\}_{j \in E_i}$ .

Let  $\phi \in \text{Aut } \hat{\mathcal{E}}(B)$  be an exchange graph automorphism, then  $\phi$  corresponds to both a cluster automorphism  $f \in \text{Aut } \mathcal{A}_B$  of the cluster algebra  $\mathcal{A}_B$ , constructed from the initial seed  $u$ , and to a mutation class automorphism  $\phi_M \in \text{Aut}_{M_n} \mathcal{S}^0(B)$ .

This mutation class automorphism in turn corresponds to an element of  $M_n$ , so there is a sequence of  $r$  mutations  $\mu_{k_i}$  and a permutation  $\sigma$  such that

$$\phi_M(u) = u \cdot (\mu_{k_1} \mu_{k_2} \cdots \mu_{k_r} \sigma).$$

All such automorphisms are constructed to have the same action on the initial seed  $u$ , so

$$\phi(u) = \left( [\bar{\beta}_i], \pm B \right) = ([f(\beta_i)], \pm B) = \phi_M(u) = u \cdot (\mu_{k_1} \mu_{k_2} \cdots \mu_{k_r} \sigma).$$

In the unfolding, each mutation  $\mu_{k_i}$  corresponds to the composite mutation  $\tilde{\mu}_{k_i}$  and the permutation  $\sigma$  corresponds to the composite permutation  $\tilde{\sigma}$ , so the following commutes:

$$\begin{array}{ccc} ([\beta_i], B) & \xrightarrow{\phi} & ([\beta_i], B) \cdot (\mu_{k_1} \cdots \mu_{k_r} \sigma) = ([\bar{\beta}_i], \pm B) \\ \text{unfold} \downarrow & & \downarrow \text{unfold} \\ ([\gamma_i], C) & \xrightarrow{\quad} & ([\gamma_i], C) \cdot (\tilde{\mu}_{k_1} \cdots \tilde{\mu}_{k_r} \tilde{\sigma}) = ([\bar{\gamma}_i], \pm C) \end{array}$$

The automorphism  $\phi$  corresponds to a cluster automorphism, so the matrix of the image of  $u$  is  $\pm B$ . The seed  $\phi(u) = \left( [\bar{\beta}_i], \pm B \right)$  unfolds to  $([\bar{\gamma}_i], \pm C)$  and hence  $(\tilde{\mu}_{k_1} \cdots \tilde{\mu}_{k_r} \tilde{\sigma}) \in M_m$  acts on  $([\gamma_i], C)$  to give a seed with the same matrix up to sign, so corresponds to a cluster automorphism of the cluster algebra constructed with  $([\gamma_i], C)$  as the initial seed, and hence to an automorphism of the exchange graph  $\mathcal{E}(C)$ . □

**Corollary 5.6.5.** *By Theorem 5.5.19 the marked exchange graph automorphisms correspond to cluster automorphisms, so for a skew-symmetrizable matrix  $B$  which unfolds to  $C$  and with corresponding cluster algebras  $\mathcal{A}_B$  and  $\mathcal{A}_C$ , Theorem 5.6.4 implies*

$$\text{Aut } \mathcal{A}_B \leftrightarrow \text{Aut } \mathcal{A}_C.$$

**Example 5.6.6.** The matrix  $B$  representing the Dynkin diagram of type  $B_2$

$$B = \begin{pmatrix} 0 & 1 \\ -2 & 0 \end{pmatrix} \text{ unfolds to } C = \begin{pmatrix} 0 & 1 & 1 \\ -1 & 0 & 0 \\ -1 & 0 & 0 \end{pmatrix},$$

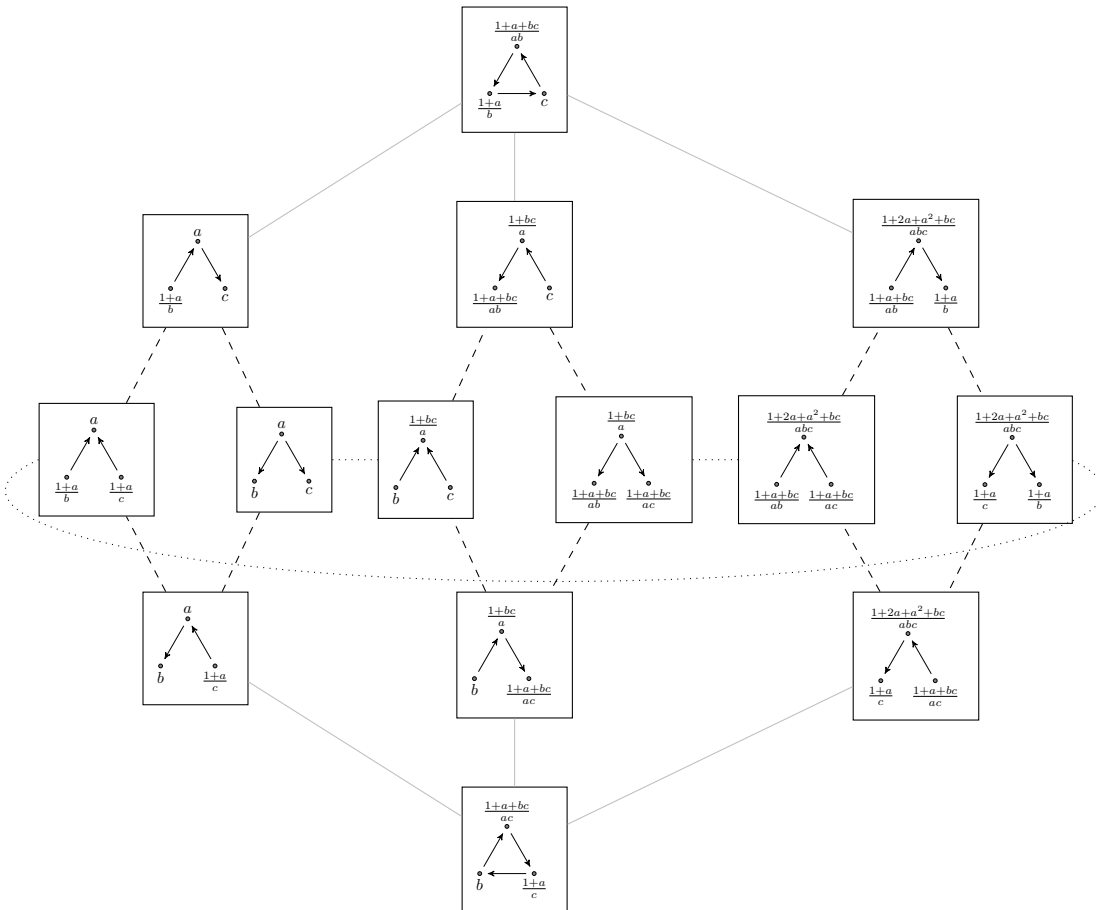

Figure 5.10: Exchange graph of the mutation class of type  $A_3$ . The dotted and dashed edges show how the marked exchange graph of type  $B_2$  shown in Figure 5.9 unfolds. A dashed edge in Figure 5.9 corresponds to the composite mutation denoted by a consecutive pair of dashed edges in this figure.

the matrix representing a quiver of Dynkin type  $A_3$ . The symmetrizing matrix of  $B$  is given by  $D = \text{diag}(1, 2)$  so the  $B_2$  marked exchange graph shown in Figure 5.9 embeds into the exchange graph of type  $A_3$  shown in Figure 5.10. The dashed edges in Figure 5.9 correspond to the pairs of dashed edges representing composite mutations in Figure 5.10. Dotted edges in Figure 5.9 correspond to single dotted edges in Figure 5.10.

The seed  $([x, y], B)$  unfolds to the seed  $([a, b, c], C)$  and the cluster variables of these two seeds are related with

$$x \rightsquigarrow a, \quad y \rightsquigarrow \{b, c\}$$

as the symmetrizing matrix  $\text{diag}(1, 2)$  ensures that  $y$  unfolds to two cluster variables.

The automorphism  $\phi \in \text{Aut } \widehat{\mathcal{E}}(B_2)$  given by rotation by  $\frac{2\pi}{3}$  takes the seed  $[x, y]$  to  $\left[\frac{1+y^2}{x}, \frac{1+x+y^2}{xy}\right]$  and corresponds to the cluster automorphism  $f \in \text{Aut } \mathcal{A}(B_2)$  given by

$$f(x) = \frac{1+y^2}{x}, \quad f(y) = \frac{1+x+y^2}{xy}.$$

This automorphism induces an automorphism of the exchange graph of  $A_3$  given by a rotation along the embedded  $\widehat{\mathcal{E}}(B_2)$  fixing the seeds with cyclic quivers and takes  $[a, b, c]$  to  $\left[\frac{1+bc}{a}, \frac{1+a+bc}{ab}, \frac{1+a+bc}{ac}\right]$  which corresponds to the cluster automorphism  $g \in \text{Aut } \mathcal{A}(A_3)$  given by

$$g(a) = \frac{1+bc}{a}, \quad g(b) = \frac{1+a+bc}{ab}, \quad g(c) = \frac{1+a+bc}{ac}.$$

However the automorphism could also correspond to the cluster automorphism  $\tilde{g} \in \text{Aut } \mathcal{A}(A_3)$  where

$$\tilde{g}(a) = g(a), \quad \tilde{g}(b) = \frac{1+a+bc}{ac}, \quad \tilde{g}(c) = \frac{1+a+bc}{ab}.$$

There is a single non-identity  $\mathcal{E}(A_3)$  exchange graph automorphism which fixes the embedded  $\widehat{\mathcal{E}}(B_2)$ , given by a reflection in the circle of the embedded subgraph and interchanging the two seeds with cyclic quivers. This then corresponds to the

cluster automorphism  $h \in \text{Aut } \mathcal{A}(A_3)$  given by

$$h(a) = a, \quad h(b) = c, \quad h(c) = b$$

such that  $\tilde{g} = g \circ h = h \circ g$ .

Theorem 5.6.4 shows that cluster automorphisms of  $\mathcal{A}_B$  commute with unfolding the seeds, so a direct cluster automorphism  $\phi \in \text{Aut } \mathcal{A}_B$  preserves the exchange matrix  $B$ , which when unfolded to  $\psi \in \text{Aut } \mathcal{A}_C$  must also preserve the exchange matrix  $C$  and so is also a direct cluster automorphism.

**Corollary 5.6.7.**  $\text{Aut}^+ \mathcal{A}_B \leftrightarrow \text{Aut}^+ \mathcal{A}_C$ .

## 5.7 Mapping class groups

In their paper introducing cluster automorphisms [ASS12] Assem, Schiffler and Shramchenko introduced the tagged mapping class group for surfaces with punctures. This group has been shown to coincide with the group of direct cluster automorphisms of the surface's corresponding cluster algebra.

**Definition 5.7.1.** Given a surface with marked points  $(S, M)$  the **mapping class group** of the surface is given by

$$\text{MCG}(S, M) = \text{Homeo}^+(S, M) / \text{Homeo}^0(S, M).$$

Here  $\text{Homeo}^+(S, M)$  is the group of orientation-preserving homeomorphisms from  $S$  to itself which sends the set  $M$  to itself, but does not necessarily fix  $M$  nor the boundary of  $S$  pointwise, and  $\text{Homeo}^0(S, M)$  is the subgroup of homeomorphisms which are isotopic to the identity such that the isotopy fixes  $M$  pointwise.

The cluster structure given by triangulations of a surface with marked points was first studied by Fomin, Shapiro and Thurston in [FST08], where they show that flips of arcs in a triangulation coincide with mutations. However such a triangulation could contain self-folded triangles, and therefore arcs that cannot be flipped; to get

around this problem, the authors introduced taggings on the arcs. A **tagged arc** is an arc which does not cut out a once-punctured monogon, where the endpoints are tagged either **plain** or **notched**, such that any endpoints on  $\partial S$  are tagged plain and if the endpoints of an arc coincide then they must be tagged the same.

Two tagged arcs are **compatible** if either their underlying arcs are the same and then at least one endpoint must be tagged in the same way, or the underlying arcs are not equal but are compatible. In this case, if they share an endpoint, the arcs must be tagged in the same way at that endpoint. A tagged triangulation is a maximal collection of compatible tagged arcs and a tagged flip is then defined in the same way as for triangulations, where a tagged arc is replaced with the unique other compatible tagged arc and these flips again correspond to mutations. See Section 2.5, [FST08, Sec. 7] or [ASS12, Sec. 4] for more details.

**Definition 5.7.2.** The **tagged mapping class group** of a surface  $(S, M)$  with  $p$  punctures is the semidirect product of the standard mapping class group of the surface with  $\mathbb{Z}_2^p$ ,

$$\mathrm{MCG}_{\triangleright\triangleleft}(S, M) = \mathbb{Z}_2^p \rtimes \mathrm{MCG}(S, M),$$

where the elements of  $\mathrm{MCG}(S, M)$  act as diffeomorphisms on the surface and elements of  $\mathbb{Z}_2^p$  switch or preserve the tags on the tagged triangulation at each puncture.

**Theorem 5.7.3** ([ASS12, Thm. 4.11]). *Let  $(S, M)$  be a surface with  $p$  punctures, with corresponding cluster algebra  $\mathcal{A}$ , then*

1.  $\mathrm{MCG}(S)$  is isomorphic to a subgroup of  $\mathrm{Aut}^+ \mathcal{A}$ .
2. If  $p \geq 2$  or  $\partial S \neq \emptyset$  then  $\mathrm{MCG}_{\triangleright\triangleleft}(S)$  is isomorphic to a subgroup of  $\mathrm{Aut}^+ \mathcal{A}$ .

They showed that for discs and annuli without punctures as well as for certain discs with 1 or 2 punctures then the tagged mapping class group is isomorphic to the group of direct cluster automorphisms of the corresponding cluster algebra. The authors conjectured that this would be the case for almost all surfaces with marked points. Brüstle and Qiu proved that this conjecture is true in [BQ15]:

**Theorem 5.7.4** ([BQ15, Thm. 4.7]). *Let  $(S, M)$  be a surface with marked points which is not*

1. *a once-punctured disc with 2 or 4 marked points on the boundary*
2. *a twice-punctured disc with 2 marked points on the boundary*

*then*

$$\mathrm{MCG}_{\bowtie}(S, M) = \mathrm{Aut}^+ \mathcal{A}.$$

Theorem 5.7.3 shows that  $\mathrm{MCG}_{\bowtie}(S, M) \hookrightarrow \mathrm{Aut}^+ \mathcal{A}$ , so the proof of Theorem 5.7.4 needs to show that this injection is surjective. This follows from the result below proved by Bridgeland and Smith:

**Proposition 5.7.5** ([BS15, Prop. 8.5]). *Suppose  $(S, M)$  is a surface which is not one of:*

1. *a sphere with  $\leq 5$  marked points;*
2. *an unpunctured disc with  $\leq 3$  marked points on the boundary;*
3. *a disc with a single puncture and one marked point on the boundary;*
4. *a once-punctured disc with 2 or 4 marked points on the boundary;*
5. *a twice-punctured disc with 2 marked points on the boundary,*

*then two tagged triangulations of  $(S, M)$  differ by an element of  $\mathrm{MCG}_{\bowtie}(S, M)$  if and only if the associated quivers are isomorphic.*

### 5.7.1 Unfoldings and covering maps

Diagrams correspond to triangulations of orbifolds in the same way that quivers correspond to triangulations of surfaces, as discussed in Subsection 2.5.3. A covering of the orbifold by a surface corresponds to an unfolding of the diagram to a quiver, in such a way that composite mutations of the quiver correspond to triangle flips in the triangulation of the surface, as discussed in [FST12a].

In their paper on the growth rate of cluster algebras, Felikson, Shapiro, Thomas and Tumarkin [FSTT14] defined the mapping class group of a cluster algebra

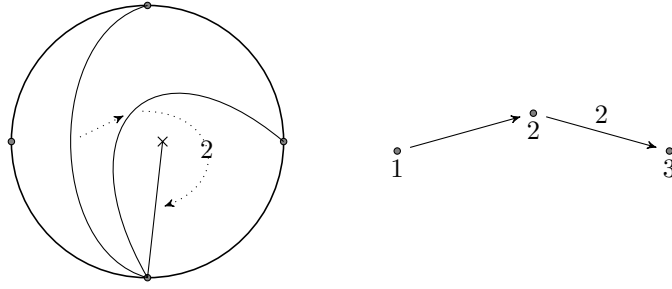

Figure 5.11: Triangulation of an orbifold (left) with associated diagram (right). The interior orbifold point is shown as a cross. The associated diagram is also shown with dotted arrows inside the triangulation.

$\text{MCG}(\mathcal{A})$  to be the elements of  $M_n$  which fix the initial exchange matrix up to a quotient by those elements of  $M_n$  which fix the initial seed. Elements of this group would then fix the initial exchange matrix and map the initial cluster to some other cluster in the mutation class, and hence would induce a direct cluster automorphism.

Fix a marked orbifold  $\mathcal{O}$  with  $m$  punctures. In [FSTT14, Remark 4.15] the cluster mapping class group is argued to either contain the orbifold's mapping class group as a proper normal subgroup with quotient  $\text{MCG}(\mathcal{A})/\text{MCG}(\mathcal{O}) \cong \mathbb{Z}_2^m$  (when  $m > 1$ , or when  $m = 1$  and the boundary non-empty) or be isomorphic to the orbifold mapping class group (when  $m = 0$ , or when  $m = 1$  and the boundary is empty).

The additional  $\mathbb{Z}_2$  for each interior marked point corresponds to the additional taggings in the definition of  $\text{MCG}_{\times}(\mathcal{O})$  and so suggests that the following would be true:

**Conjecture 5.7.6.** *For a cluster algebra  $\mathcal{A}$  arising from the triangulation of an orbifold  $\mathcal{O}$*

$$\text{MCG}_{\times}(\mathcal{O}) \cong \text{Aut}^+ \mathcal{A}.$$

**Example 5.7.7.** Consider the orbifold  $\mathcal{O}$  constructed from the disc with four marked points on the boundary and a single orbifold point in the interior, as shown in Figure 5.11.

This orbifold has no punctures, so the tagged mapping class group is equal to the mapping class group. Any element of the mapping class group must fix the orbifold

point and permute the four boundary marked points. The only such permutations are rotations around the boundary, as any reflection would not preserve the orientation, hence the mapping class group is isomorphic to  $\mathbb{Z}_4$  generated by a rotation by angle  $\frac{\pi}{2}$ .

This orbifold corresponds to the cluster algebra of Dynkin type  $B_3$ , which can be generated by the diagram in Figure 5.11. The cluster automorphism group of  $\mathcal{A}_{B_3}$  is the dihedral group with 8 elements:

$$\text{Aut } \mathcal{A}_{B_3} \cong D_4 = \mathbb{Z}_4 \rtimes \mathbb{Z}_2,$$

where  $\mathbb{Z}_4$  is generated by the automorphism given by the action of  $\mu_1\mu_2\mu_3$  on the initial cluster and  $\mathbb{Z}_2$  by  $\mu_1\mu_3$ . This can be seen as the automorphisms of the marked exchange graph shown in Figure 5.8 where the 4 squares are permuted while fixing the markings.

The direct cluster automorphisms are those in the subgroup  $\mathbb{Z}_4$  of the cluster automorphism group, and so

$$\text{Aut}^+ \mathcal{A}_{B_3} \cong \mathbb{Z}_4 \cong \text{MCG}(\mathcal{O}) = \text{MCG}_{\rtimes}(\mathcal{O}).$$

# Appendix A

## Minimal mutation-infinite quiver supplementary material

### A.1 Computing minimal mutation-infinite quivers

The quiver classification involved a large computational effort to find all minimal mutation-infinite quivers. This section details the procedures used in this computation. Details about implementations of these procedures can be found on the author's website: <https://www.jwlawson.co.uk/maths/mmi/>.

#### A.1.1 Finding the size of a mutation-class

An important computation in all the following algorithms is determining whether a given quiver is mutation-finite or mutation-infinite. There is a fast approximation which can prove a quiver is mutation-infinite and a slower procedure which proves a quiver is mutation-finite.

#### **Fast approximation to check whether a quiver is mutation-infinite**

Proposition 3.2.7 states that any mutation-finite quiver has at most 2 arrows between any two vertices. This gives a procedure that can prove that a quiver is mutation-

**Input:**  $Q$  Quiver to check  
**Data:**  $M$  Number of mutations to perform  
**Data:**  $k$  Counter initially 0  
**Result:** Whether  $Q$  is mutation-infinite, or probably mutation-finite  
**while**  $k < M$  **do**  
    **if**  $Q$  contains 3 or more arrows between 2 vertices **then**  
        **return**  $Q$  is mutation-infinite  
    Choose a random vertex  
    Mutate  $Q$  at this vertex  
    Increment  $k$   
**return**  $Q$  is probably mutation-finite

**Algorithm A.1.1:** Fast approximation whether a quiver is mutation-infinite

infinite, but which cannot prove that a quiver is mutation-finite. This procedure was used in computations by Felikson, Shapiro and Tumarkin in their classification of skew-symmetric mutation-finite quivers [FST12c] and Shapiro's comments on the procedure can be found on his website: <https://www.math.msu.edu/~mshapiro/FiniteMutation.html>.

The procedure, given in Algorithm A.1.1, checks whether the quiver contains 3 or more arrows between any two vertices, if it does then the quiver is mutation-infinite. Otherwise, pick a vertex at random and mutate the quiver at this vertex and repeat with this new quiver.

For mutation-finite quivers this process would never terminate without the bound on the number of mutations, and it is possible that for mutation-infinite quivers the randomly chosen mutations never generate an edge with more than 2 arrows. Therefore this is only an approximation and a maximum number of mutations should be attempted before stopping. If no quiver was found with more than 2 arrows between two vertices then, provided the number of mutations was high, the quiver is probably mutation-finite.

### Computing a full finite mutation-class

While the above procedure can show a quiver is probably mutation-finite, we require a procedure that can definitively prove it. To do this we compute the whole mutation-

**Input:**  $Q$  Quiver  
**Data:**  $L$  Queue of quivers to mutate  
**Data:**  $A$  List of all quivers found in the mutation class so far  
**Data:**  $M_P$  For each quiver  $P$ , a map taking a vertex in  $P$  to the quiver obtained by mutating  $P$  at that vertex (if the mutation has been computed)  
**Result:**  $A$  List of all quivers in the mutation class

```

Add  $Q$  to  $L$ 
while  $L$  is not empty do
  Remove quiver  $P$  from the top of queue  $L$ 
  for  $i = 1$  to (Number of vertices) do
    if  $M_P$  has a quiver at vertex  $i$  then
      Continue to next vertex
    else
      Let  $P'$  be the mutation of  $P$  at  $i$ 
      if  $P' \in A$  then
        Update  $M_{P'}$  so vertex  $i$  points to  $P$ 
      else
        Create  $M_{P'}$  with vertex  $i$  pointing to  $P$ 
        Add  $P'$  to  $A$ 
        Add  $P'$  to  $L$ 
      Update  $M_P$  so vertex  $i$  points to  $P'$ 
  return  $A$ 
  
```

**Algorithm A.1.2:** Compute mutation-class of a mutation-finite quiver

class of the quiver, and in doing so either obtain a finite number of quivers in the class, or find a quiver which proves the class is mutation-infinite.

The algorithm to find the mutation-class of a mutation-finite quiver calculates the whole exchange graph from the initial quiver. First compute all mutations of this quiver, then for each of these quivers compute all of their mutations and continue until no further quivers are computed. By keeping track of which mutations link two quivers, only those mutations which are not known need to be computed. A simplified implementation is given in Algorithm A.1.2 with the assumption that the initial quiver is mutation-finite, if not then this algorithm would not terminate.

**Input:**  $Q$  Quiver  
**Data:**  $L$  Queue of quivers to mutate  
**Data:**  $A$  List of all quivers found in the mutation class so far  
**Data:**  $M_P$  For each quiver  $P$ , a map taking a vertex in  $P$  to the quiver obtained by mutating  $P$  at that vertex (if the mutation has been computed)  
**Result:** Whether  $Q$  is mutation-infinite or not

Add  $Q$  to  $L$

```

while  $L$  is not empty do
  Remove quiver  $P$  from the top of queue  $L$ 
  for  $i = 1$  to (Number of vertices) do
    if  $M_P$  has a quiver at vertex  $i$  then
      Continue to next vertex
    else
      Let  $P'$  be the mutation of  $P$  at  $i$ 
      if  $P' \in A$  then
        Update  $M_{P'}$  so vertex  $i$  points to  $P$ 
      else
        if  $P'$  has more than 3 arrows between 2 vertices then
          return  $Q$  is mutation-infinite
        Create  $M_{P'}$  with vertex  $i$  pointing to  $P$ 
        Add  $P'$  to  $A$ 
        Add  $P'$  to  $L$ 
      Update  $M_P$  so vertex  $i$  points to  $P'$ 
  return  $Q$  is mutation-finite

```

**Algorithm A.1.3:** Determine whether a quiver is mutation-infinite or not

### Slower mutation-finite check

The above algorithm will only terminate if the initial quiver is mutation-finite. In the case of a mutation-infinite quiver, the mutation-class is infinite, so the computation will continue indefinitely. The algorithm can be adapted to terminate for mutation-infinite quivers using the result in Proposition 3.2.7.

Once a new quiver is computed which has not yet been found, check whether it contains three or more arrows between any two vertices. If it does then the mutation-class is known to be infinite, so the procedure can be terminated. See Algorithm A.1.3.

There are only a finite number of ways to draw a graphs with a fixed number of vertices and up to 2 arrows between any two vertices. Hence in an infinite mutation-

class there will eventually be a quiver with 3 or more arrows between two vertices and therefore the procedure will always terminate.

The two procedures to compute whether a quiver is mutation-finite can be combined to provide a faster run time in the majority of cases. By first using the fast approximation, most mutation-infinite quivers will be identified as mutation-infinite and any quivers which are not then get passed to the slower check to confirm whether they are mutation-finite.

### A.1.2 Computing quivers

The above algorithms give procedures to tell whether a given quiver is mutation-finite or mutation-infinite. By iterating through a range of quivers these checks can be used to find all quivers which satisfy certain properties.

#### Computing all mutation-finite quivers

Proposition 3.2.2 states that all subquivers of a mutation-finite quiver are again mutation-finite. This fact is used to build up mutation-finite quivers of a certain size  $n$  by adding vertices to the mutation-finite quivers with  $n - 1$  vertices. All 2 vertex quivers are mutation-finite, so with these as a starting point we can recursively compute all mutation-finite quivers of size  $n$ , using the procedure in Algorithm A.1.4.

By Proposition 3.2.7 any mutation-finite quiver contains at most 2 arrows between any two vertices, so when adding a vertex to the quivers of size  $n - 1$  it suffices to only add either 0, 1 or 2 between the new vertex and any others. Adding more arrows would immediately yield a mutation-infinite quiver.

#### Computing all minimal mutation-infinite quivers

Any subquiver of a minimal mutation-infinite quiver is a mutation-finite quiver. Therefore to construct these quivers of a certain size  $n$  start with all mutation-finite quivers of size  $n - 1$  and extend the quiver by adding another vertex in all possible ways with either 0, 1 or 2 arrows between the new vertex and any other vertices.

**Input:**  $n$  Size of quiver to output  
**Data:**  $A$  List of mutation-finite quivers  
**Result:** A list of all mutation-finite quivers of size  $n$

```

Function Finite(size  $n$ )
┌   if  $n = 2$  then
│   ┌   Let  $A = \{\cdot \rightarrow \cdot, \cdot \rightrightarrows \cdot\}$ 
│   └   return  $A$ 
│   foreach Quiver  $Q$  in Finite( $n - 1$ ) do
│   ┌   foreach Extension of  $Q$  to possibly mutation-finite quiver  $Q'$  do
│   │   ┌   if  $Q'$  is mutation-finite then
│   │   │   └   Add  $Q'$  to  $A$ 
│   └   return  $A$ 

```

**Algorithm A.1.4:** Compute all mutation-finite quivers of size  $n$

The quivers obtained in this way could then be minimal mutation-infinite and so this needs to be verified.

For a given quiver to be minimal mutation-infinite it must satisfy two conditions, namely that it is mutation-infinite and that every subquiver is mutation-finite. Both of these conditions can be checked using the above procedures.

### A.1.3 Checking number of moves

Theorem 3.5.2 states the maximum number of moves required to transform any minimal mutation-infinite quiver to one of the class representatives. To compute this number each minimal mutation-infinite quiver is checked in turn to find the minimal number of moves needed to transform that quiver to its class representative.

This minimal number of moves can be found by applying all applicable moves to the initial quiver and storing the number of moves taken to reach each quiver obtained in this way. We can ensure that the number of moves used to obtain a class representative is minimal by always choosing the next quiver used in the process to be the one obtained through the fewest number of moves.

## A.2 List of moves

This section lists all moves required to transform any minimal mutation-infinite quiver to one of the representatives. Any listed move should also be considered along with the move where all arrows are reversed.

Where a move has the requirement that one of the components is a line this requires that the component is a line with one of its endpoints adjacent to the move subquiver.

### A.2.1 Moves for quivers of size 5

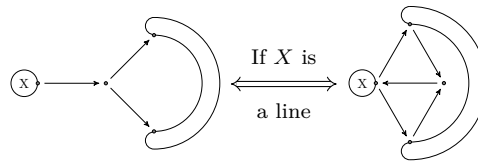

### A.2.2 Additional moves for quivers of size 6

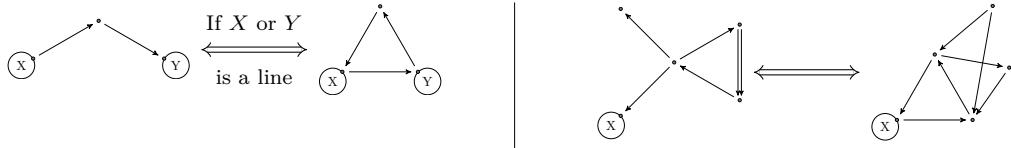

### A.2.3 Additional moves for quivers of size 7

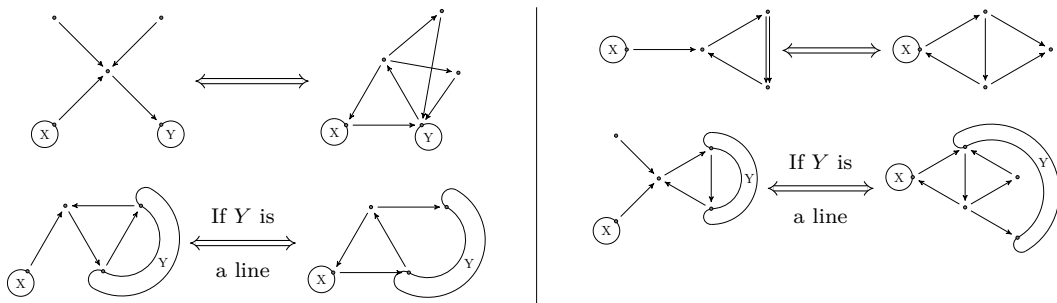

### A.2.4 Additional moves for quivers of size 8

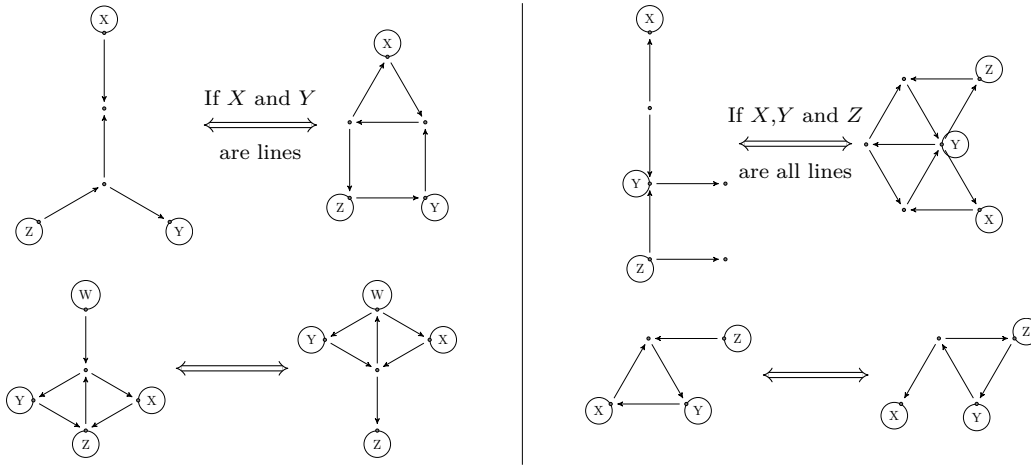

### A.2.5 Additional moves for quivers of size 9

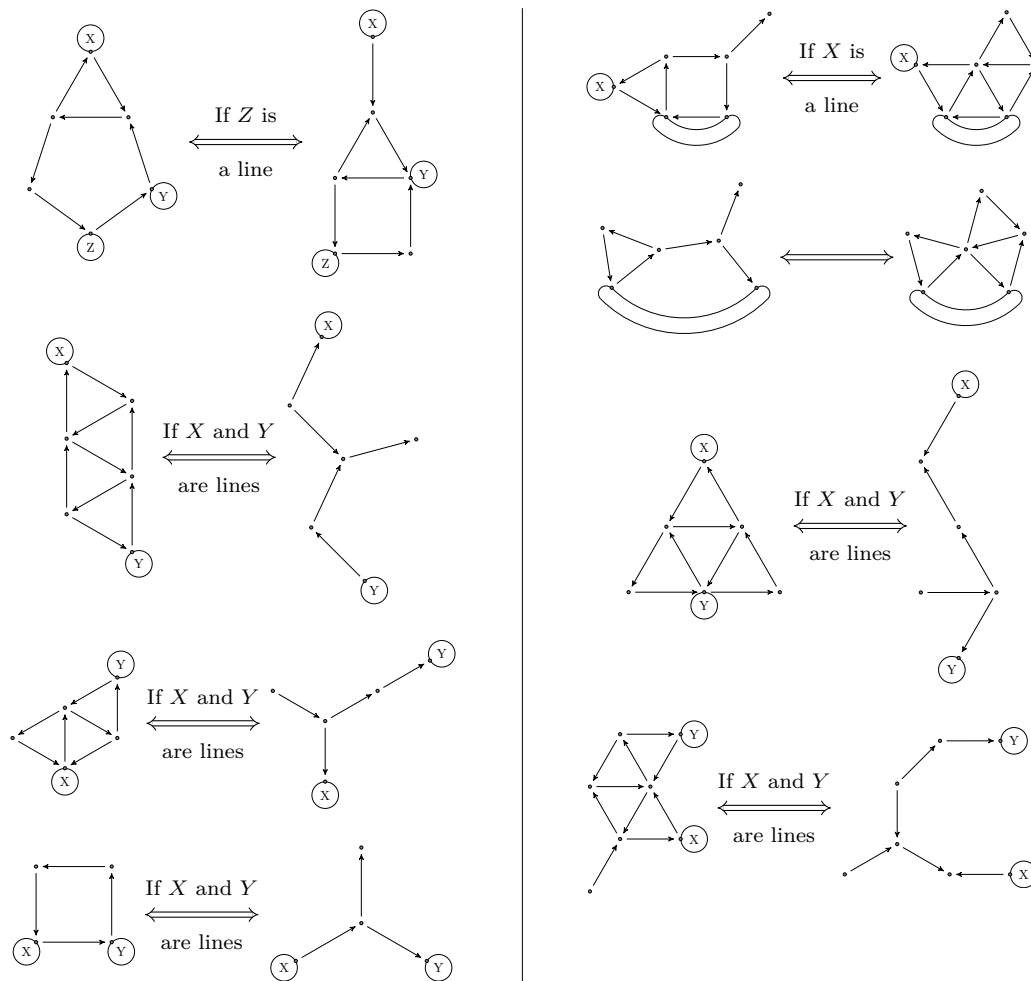

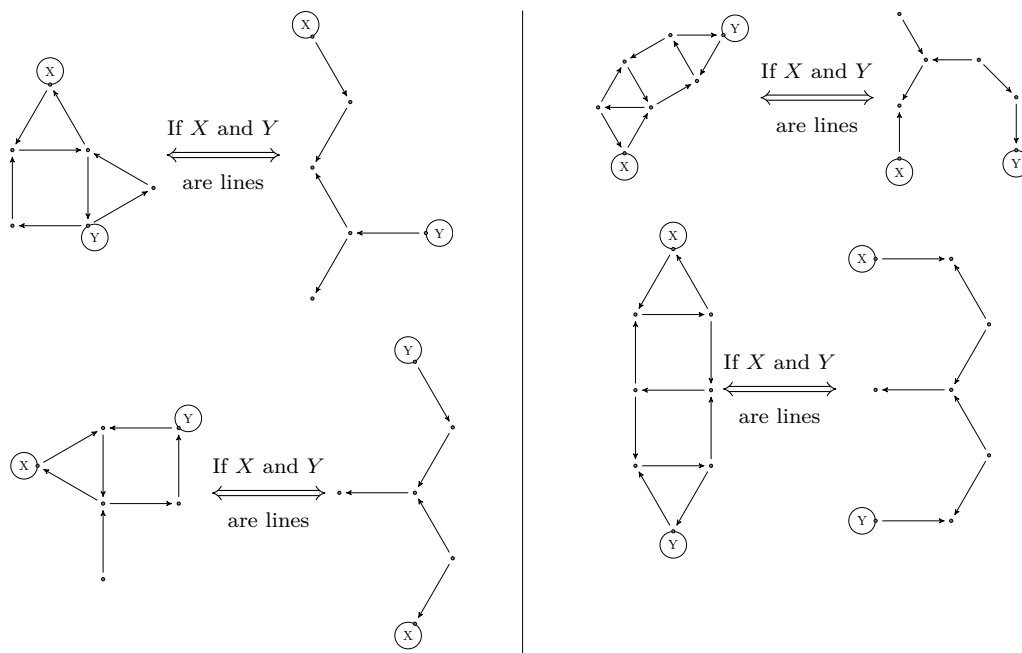

A.2.6 Additional moves for quivers of size 10

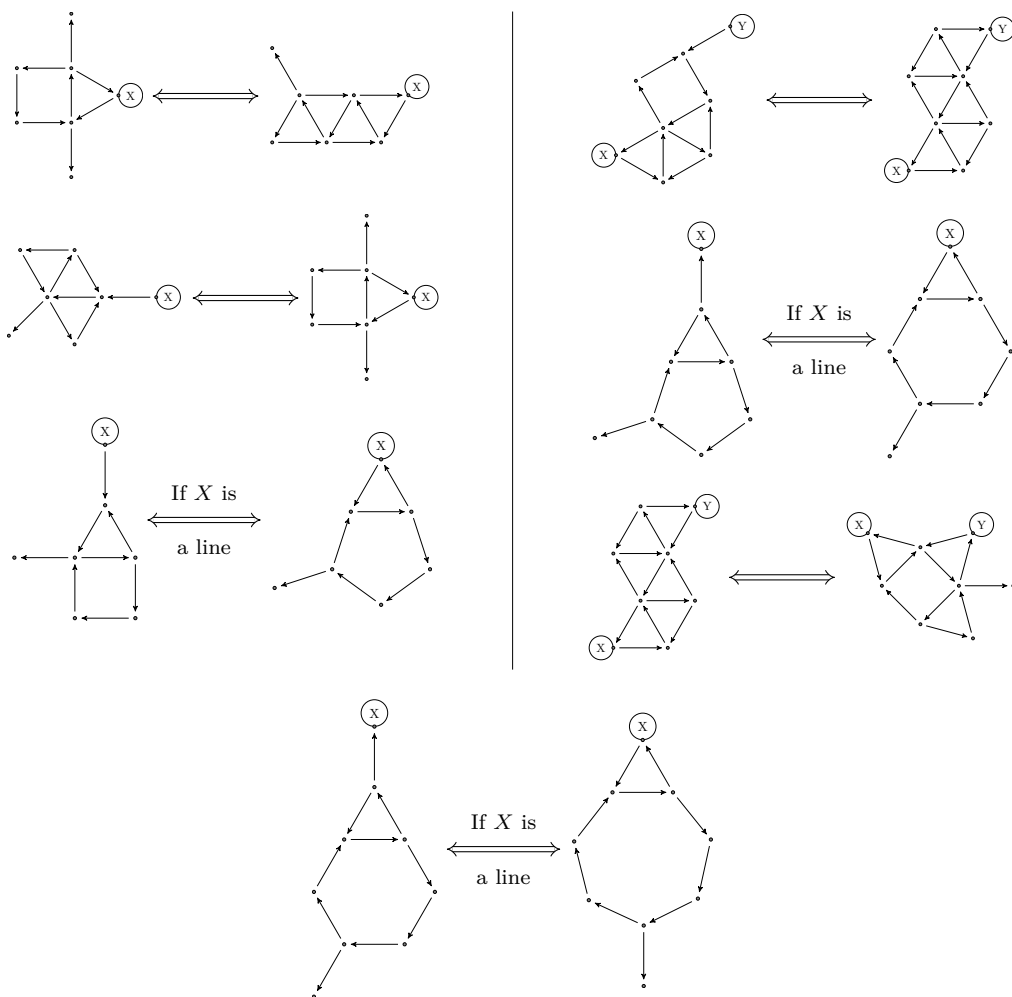

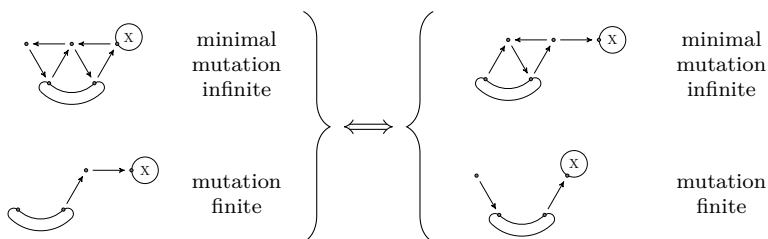
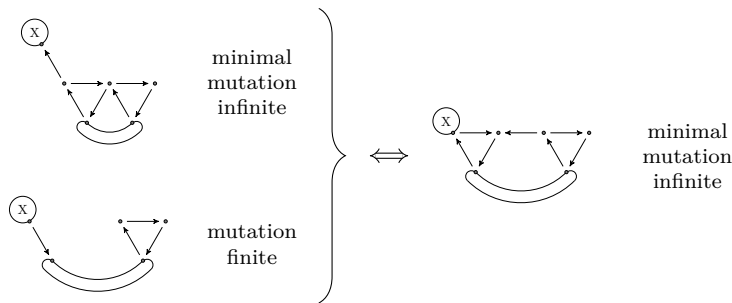
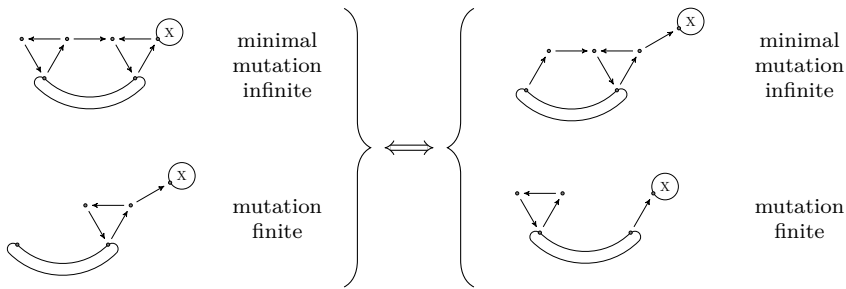
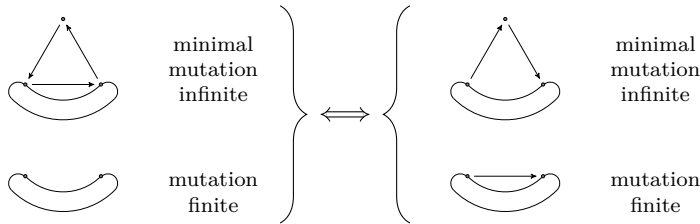
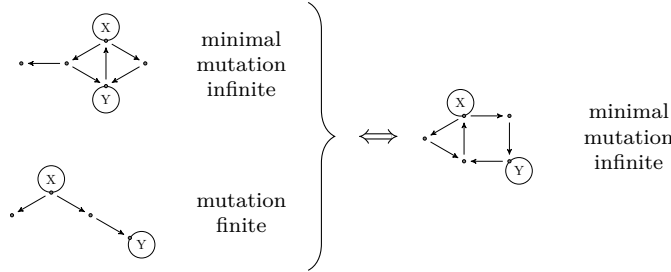
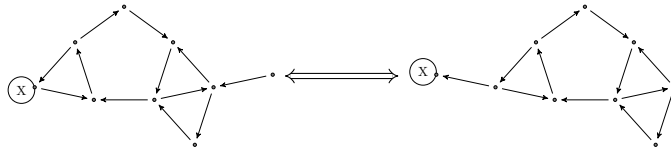

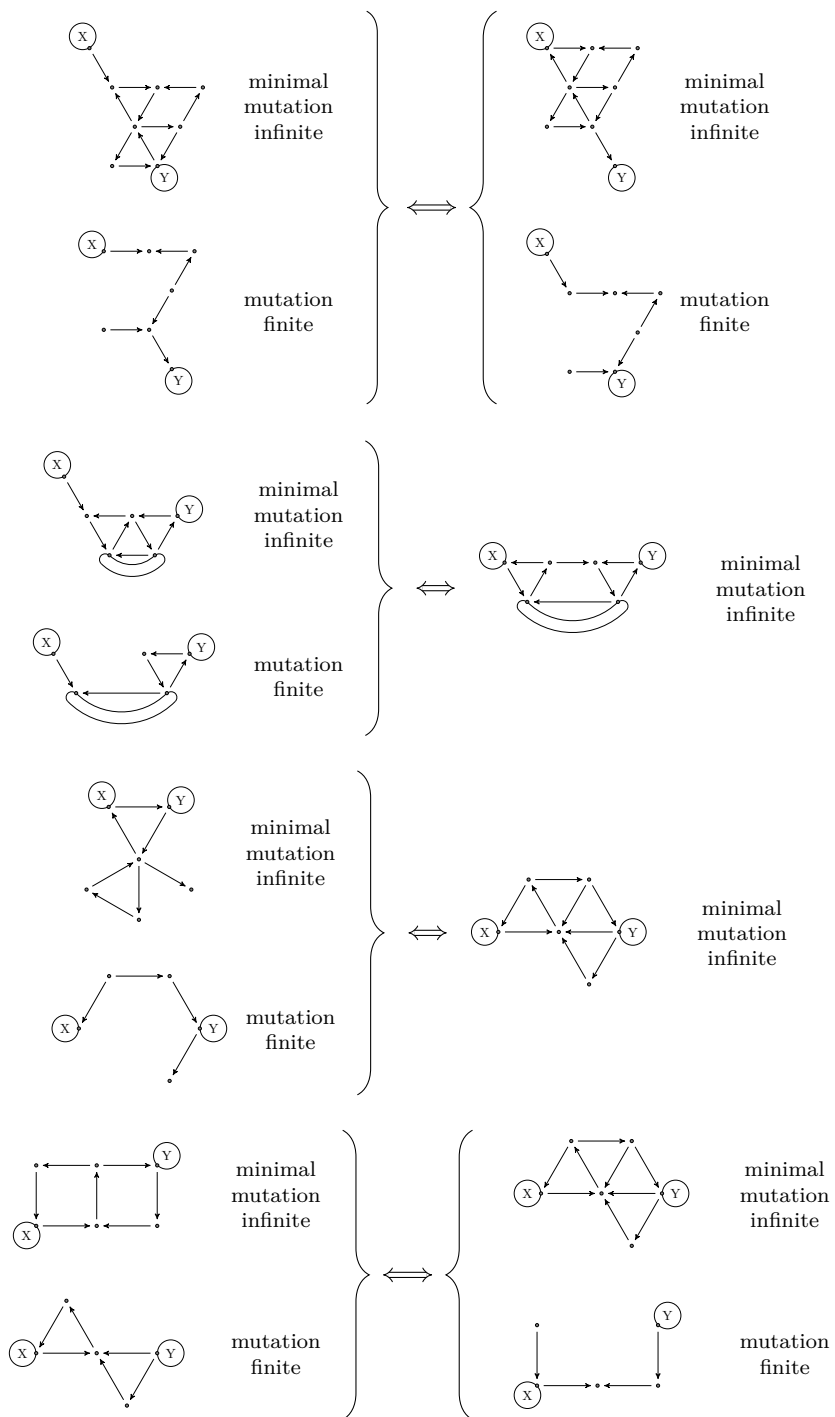



# Appendix B

## Properties of minimal mutation-infinite quivers supplementary material

### B.1 Tables of move-class invariants

We provide tables of mutation invariants for the different move-classes of the minimal mutation infinite-quivers. We label the move-classes first by the rank of the quivers and then with a subscript referring to the order in which their representative appears in Table 3.1, Table 3.2, and Table 3.3. The starred values are conjectural. It is a well-known fact that the determinant of the matrix  $B_Q$  is also invariant under mutation, but this invariant does not give us any new information about the mutation-classes so it is omitted.

Move-class	$\text{rank}(B_Q)$	Acyclic quivers	Non-acyclic in $\widehat{\Psi}(Q)$
$4_1$	4	6	14
$4_2$	2	4	12
$4_3$	4	2	13
$4_4$	4	1	5
$4_5$	4	0	17
$4_6$	4	6	14
$5_1$	4	8	80*
$5_2$	4	10	55*
$5_3$	4	5	101*
$5_4$	2	5	25*

Table B.1: Rank 4 and 5 hyperbolic Coxeter simplex move-classes.

Move-class	$\text{rank}(B_Q)$	Acyclic quivers
$6_1$	4	16
$6_2$	2	6
$6_3$	6	10
$6_4$	6	20
$7_1$	6	48
$7_2$	6	12
$7_3$	6	30
$7_4$	6	28
$8_1$	8	80
$8_2$	6	96
$8_3$	8	14
$8_4$	8	42
$8_5$	8	70
$9_1$	8	219
$9_2$	8	151
$9_3$	8	16
$9_4$	8	55
$9_5$	8	95
$9_6$	8	76
$10_1$	10	225
$10_2$	8	138

Table B.2: Higher rank hyperbolic Coxeter simplex move-classes.

Move-class	$\text{rank}(B_Q)$
$6_5$	6
$6_6$	4
$7_5$	6
$8_6$	8
$9_7$	8
$10_3$	10

Table B.3: Double arrow move-classes.

Move-class	$\text{rank}(B_Q)$
$7_6$	6
$8_7$	6
$8_8$	8
$9_8$	8
$9_9$	8
$9_{10}$	8
$10_4$	10
$10_5$	10
$10_6$	8
$10_7$	10

Table B.4: Exceptional move-classes.



# Bibliography

- [ACC+13] Murad Alim, Sergio Cecotti, Clay Córdova, Sam Espahbodi, Ashwin Rastogi and Cumrun Vafa. ‘BPS quivers and spectra of complete  $\mathcal{N} = 2$  quantum field theories’. In: *Comm. Math. Phys.* 323.3 (2013), pp. 1185–1227.  
doi:10.1007/s00220-013-1789-8.  
arXiv:1109.4941.
- [ABBS08] Ibrahim Assem, Martin Blais, Thomas Brüstle and Audrey Samson. ‘Mutation classes of skew-symmetric  $3 \times 3$ -matrices’. In: *Comm. Algebra* 36.4 (2008), pp. 1209–1220.  
doi:10.1080/00927870701861243.  
arXiv:math/0610627.
- [ASS12] Ibrahim Assem, Ralf Schiffler and Vasilisa Shramchenko. ‘Cluster automorphisms’. In: *Proc. Lond. Math. Soc. (3)* 104.6 (2012), pp. 1271–1302.  
doi:10.1112/plms/pdr049.  
arXiv:1009.0742.
- [BGZ06] Michael Barot, Christof Geiss and Andrei Zelevinsky. ‘Cluster algebras of finite type and positive symmetrizable matrices’. In: *J. London Math. Soc. (2)* 73.3 (2006), pp. 545–564.  
doi:10.1112/S0024610706022769.  
arXiv:math/0411341.

- [BBH11] Andre Beineke, Thomas Brüstle and Lutz Hille. ‘Cluster-cyclic quivers with three vertices and the Markov equation’. In: *Algebr. Represent. Theory* 14.1 (2011). With an appendix by Otto Kerner, pp. 97–112.  
doi:10.1007/s10468-009-9179-9.  
arXiv:math/0612213.
- [BFZ05] Arkady Berenstein, Sergey Fomin and Andrei Zelevinsky. ‘Cluster algebras. III. Upper bounds and double Bruhat cells’. In: *Duke Math. J.* 126.1 (2005), pp. 1–52.  
doi:10.1215/S0012-7094-04-12611-9.  
arXiv:math/0305434.
- [BS15] Tom Bridgeland and Ivan Smith. ‘Quadratic differentials as stability conditions’. In: *Publ. Math. Inst. Hautes Études Sci.* 121 (2015), pp. 155–278.  
doi:10.1007/s10240-014-0066-5.  
arXiv:1302.7030.
- [BDP14] Thomas Brüstle, Grégoire Dupont and Matthieu Pérotin. ‘On maximal green sequences’. In: *Int. Math. Res. Not. IMRN* 16 (2014), pp. 4547–4586.  
doi:10.1093/imrn/rnt075.  
arXiv:1205.2050.
- [BHIT15] Thomas Brüstle, Stephen Hermes, Kiyoshi Igusa and Gordana Todorov. ‘Semi-invariant pictures and two conjectures on maximal green sequences’. 2015.  
arXiv:1503.07945.
- [BQ15] Thomas Brüstle and Yu Qiu. ‘Tagged mapping class groups: Auslander-Reiten translation’. In: *Math. Z.* 279.3-4 (2015), pp. 1103–1120.

- doi:10.1007/s00209-015-1405-z.  
arXiv:1212.0007.
- [BMR08] Aslak Bakke Buan, Robert J. Marsh and Idun Reiten. ‘Cluster mutation via quiver representations’. In: *Comment. Math. Helv.* 83.1 (2008), pp. 143–177.  
doi:10.4171/CMH/121.  
arXiv:math/0412077.
- [CK06] Philippe Caldero and Bernhard Keller. ‘From triangulated categories to cluster algebras. II’. In: *Ann. Sci. École Norm. Sup. (4)* 39.6 (2006), pp. 983–1009.  
doi:10.1016/j.ansens.2006.09.003.  
arXiv:math/0510251.
- [CCV11] Sergio Cecotti, Clay Cordova and Cumrun Vafa. ‘Braids, Walls, and Mirrors’. 2011.  
arXiv:1110.2115 [hep-th].
- [CZ15] Wen Chang and Bin Zhu. ‘Cluster automorphism groups and automorphism groups of exchange graphs’. 2015.  
arXiv:1506.02029.
- [CZ16a] Wen Chang and Bin Zhu. ‘Cluster automorphism groups of cluster algebras of finite type’. In: *J. Algebra* 447 (2016), pp. 490–515.  
doi:10.1016/j.jalgebra.2015.09.045.  
arXiv:1506.10950.
- [CZ16b] Wen Chang and Bin Zhu. ‘On rooted cluster morphisms and cluster structures in 2-Calabi-Yau triangulated categories’. In: *J. Algebra* 458 (2016), pp. 387–421.  
doi:10.1016/j.jalgebra.2016.03.042.  
arXiv:1410.5702.

- [CDR+16] E. Cormier, P. Dillery, J. Resh, K. Serhiyenko and J. Whelan. ‘Minimal length maximal green sequences and triangulations of polygons’. In: *J. Algebraic Combin.* 44.4 (2016), pp. 905–930.  
doi:10.1007/s10801-016-0694-6.  
arXiv:1508.02954.
- [Cox34] H. S. M. Coxeter. ‘Discrete groups generated by reflections’. In: *Ann. of Math. (2)* 35.3 (1934), pp. 588–621.  
doi:10.2307/1968753.
- [DO08] Harm Derksen and Theodore Owen. ‘New graphs of finite mutation type’. In: *Electron. J. Combin.* 15.1 (2008), Research Paper #R139.  
[www.combinatorics.org/ojs/index.php/eljc/article/view/v15i1r139](http://www.combinatorics.org/ojs/index.php/eljc/article/view/v15i1r139).  
arXiv:0804.0787.
- [DWZ10] Harm Derksen, Jerzy Weyman and Andrei Zelevinsky. ‘Quivers with potentials and their representations II: applications to cluster algebras’. In: *J. Amer. Math. Soc.* 23.3 (2010), pp. 749–790.  
doi:10.1090/S0894-0347-10-00662-4.  
arXiv:0904.0676.
- [Dyn46] E. Dynkin. ‘Classification of the simple Lie groups’. In: *Rec. Math. [Mat. Sbornik] N. S.* 18(60) (1946), pp. 347–352.
- [FSTT14] Anna Felikson, Michael Shapiro, Hugh Thomas and Pavel Tumarkin. ‘Growth rate of cluster algebras’. In: *Proc. Lond. Math. Soc. (3)* 109.3 (2014), pp. 653–675.  
doi:10.1112/plms/pdu010.  
arXiv:1203.5558.
- [FST12a] Anna Felikson, Michael Shapiro and Pavel Tumarkin. ‘Cluster algebras and triangulated orbifolds’. In: *Adv. Math.* 231.5 (2012), pp. 2953–3002.

- doi:10.1016/j.aim.2012.07.032.  
arXiv:1111.3449.
- [FST12b] Anna Felikson, Michael Shapiro and Pavel Tumarkin. ‘Cluster algebras of finite mutation type via unfoldings’. In: *Int. Math. Res. Not. IMRN* 8 (2012), pp. 1768–1804.  
doi:10.1093/imrn/rnr072.  
arXiv:1006.4276.
- [FST12c] Anna Felikson, Michael Shapiro and Pavel Tumarkin.  
‘Skew-symmetric cluster algebras of finite mutation type’. In: *J. Eur. Math. Soc. (JEMS)* 14.4 (2012), pp. 1135–1180.  
doi:10.4171/JEMS/329.  
arXiv:0811.1703.
- [FG07] Vladimir V. Fock and Alexander B. Goncharov. ‘Dual Teichmüller and lamination spaces’. In: *Handbook of Teichmüller theory. Vol. I*. Vol. 11. IRMA Lect. Math. Theor. Phys. Eur. Math. Soc., Zürich, 2007, pp. 647–684.  
doi:10.4171/029-1/16.  
arXiv:math/0510312.
- [FG09] Vladimir V. Fock and Alexander B. Goncharov. ‘Cluster ensembles, quantization and the dilogarithm’. In: *Ann. Sci. Éc. Norm. Supér. (4)* 42.6 (2009), pp. 865–930.  
doi:10.1007/978-0-8176-4745-2\_15.  
arXiv:math/0311245.
- [FST08] Sergey Fomin, Michael Shapiro and Dylan Thurston. ‘Cluster algebras and triangulated surfaces. I. Cluster complexes’. In: *Acta Math.* 201.1 (2008), pp. 83–146.  
doi:10.1007/s11511-008-0030-7.  
arXiv:math/0608367.

- [FZ02] Sergey Fomin and Andrei Zelevinsky. ‘Cluster algebras. I. Foundations’. In: *J. Amer. Math. Soc.* 15.2 (2002), 497–529 (electronic).  
doi:10.1090/S0894-0347-01-00385-X.  
arXiv:math/0104151.
- [FZ03] Sergey Fomin and Andrei Zelevinsky. ‘Cluster algebras. II. Finite type classification’. In: *Invent. Math.* 154.1 (2003), pp. 63–121.  
doi:10.1007/s00222-003-0302-y.  
arXiv:math/0208229.
- [Fra15] Chris Frazer. ‘Quasi-homomorphisms of cluster algebras’. 2015.  
arXiv:1509.05285.
- [GM14] Alexander Garver and Gregg Musiker. ‘On maximal green sequences for type A quivers’. 2014.  
arXiv:1402.6149.
- [GSV05] Michael Gekhtman, Michael Shapiro and Alek Vainshtein. ‘Cluster algebras and Weil-Petersson forms’. In: *Duke Math. J.* 127.2 (2005), pp. 291–311.  
doi:10.1215/S0012-7094-04-12723-X.  
arXiv:math/0309138.
- [GSV08] Michael Gekhtman, Michael Shapiro and Alek Vainshtein. ‘On the properties of the exchange graph of a cluster algebra’. In: *Math. Res. Lett.* 15.2 (2008), pp. 321–330.  
doi:10.4310/MRL.2008.v15.n2.a10.  
arXiv:math/0703151.
- [GHKK14] Mark Gross, Paul Hacking, Sean Keel and Maxim Kontsevich. ‘Canonical bases for cluster algebras’. 2014.  
arXiv:1411.1394.

- [Hat91] Allen Hatcher. ‘On triangulations of surfaces’. In: *Topology Appl.* 40.2 (1991), pp. 189–194.  
doi:10.1016/0166-8641(91)90050-V.
- [Hum90] James E. Humphreys. *Reflection groups and Coxeter groups*. Vol. 29. Cambridge Studies in Advanced Mathematics. Cambridge University Press, Cambridge, 1990, pp. xii+204.  
doi:10.1017/CB09780511623646.
- [JRKT99] N. W. Johnson, J. G. Ratcliffe, R. Kellerhals and S. T. Tschantz. ‘The size of a hyperbolic Coxeter simplex’. In: *Transform. Groups* 4.4 (1999), pp. 329–353.  
doi:10.1007/BF01238563.
- [Kel11a] Bernhard Keller. ‘Categorification of acyclic cluster algebras: an introduction’. In: *Higher structures in geometry and physics*. Vol. 287. Progr. Math. Birkhäuser/Springer, New York, 2011, pp. 227–241.  
doi:10.1007/978-0-8176-4735-3\_11.  
arXiv:0801.3103.
- [Kel11b] Bernhard Keller. ‘On cluster theory and quantum dilogarithm identities’. In: *Representations of algebras and related topics*. EMS Ser. Congr. Rep. Eur. Math. Soc., Zürich, 2011, pp. 85–116.  
doi:10.4171/101-1/3.  
arXiv:1102.4148.
- [KQ14] Yoshiyuki Kimura and Fan Qin. ‘Graded quiver varieties, quantum cluster algebras and dual canonical basis’. In: *Adv. Math.* 262 (2014), pp. 261–312.  
doi:10.1016/j.aim.2014.05.014.  
arXiv:1205.2066.
- [KP16] Alastair King and Matthew Pressland. ‘Labelled seeds and the mutation group’. In: *Math. Proc. Camb. Phil. Soc.* (2016).

Electronically published, to appear in print.

doi:10.1017/S0305004116000918.

arXiv:1309.6579.

- [LFZ16] Daniel Labardini-Fragoso and Andrei Zelevinsky. ‘Strongly primitive species with potentials I: mutations’. In: *Bol. Soc. Mat. Mex. (3)* 22.1 (2016), pp. 47–115.  
doi:10.1007/s40590-015-0063-9.  
arXiv:1306.3495.
- [Lad11] Sefi Ladkani. ‘Which mutation classes of quivers have constant number of arrows?’ 2011.  
arXiv:1104.0436.
- [LP16] Thomas Lam and Pavlo Pylyavskyy. ‘Laurent phenomenon algebras’. In: *Camb. J. Math.* 4.1 (2016), pp. 121–162.  
doi:10.4310/CJM.2016.v4.n1.a2.  
arXiv:1206.2611.
- [Law16] John W. Lawson. ‘Cluster automorphisms and the marked exchange graphs of skew-symmetrizable cluster algebras’. In: *Electron. J. Comb.* 23.4 (2016), #P4.41.  
[www.combinatorics.org/ojs/index.php/eljc/article/view/v23i4p41](http://www.combinatorics.org/ojs/index.php/eljc/article/view/v23i4p41).  
arXiv:1602.05494.
- [Law17] John W. Lawson. ‘Minimal mutation-infinite quivers’. In: *Exp. Math.* 26.3 (2017), pp. 308–323.  
doi:10.1080/10586458.2016.1166353.  
arXiv:1505.01735.
- [LM16] John W. Lawson and Matthew R. Mills. ‘Properties of minimal mutation-infinite quivers’. 2016.  
arXiv:1610.08333.

- [LLM15] Kyungyong Lee, Li Li and Matthew R. Mills. ‘A combinatorial formula for certain elements of upper cluster algebras’. In: *SIGMA Symmetry Integrability Geom. Methods Appl.* 11 (2015), Paper 049, 24. doi:10.3842/SIGMA.2015.049. arXiv:1409.8177.
- [LS15] Kyungyong Lee and Ralf Schiffler. ‘Positivity for cluster algebras’. In: *Ann. of Math. (2)* 182.1 (2015), pp. 73–125. doi:10.4007/annals.2015.182.1.2. arXiv:1306.2415.
- [Mil16] Matthew R. Mills. ‘Maximal green sequences for mutation finite quivers’. 2016. arXiv:1606.03799.
- [Mul13] Greg Muller. ‘Locally acyclic cluster algebras’. In: *Adv. Math.* 233 (2013), pp. 207–247. doi:10.1016/j.aim.2012.10.002. arXiv:1111.4468.
- [Mul14] Greg Muller. ‘ $\mathcal{A} = \mathcal{U}$  for locally acyclic cluster algebras’. In: *SIGMA Symmetry Integrability Geom. Methods Appl.* 10 (2014), Paper 094, 8. doi:10.3842/SIGMA.2014.094. arXiv:1111.4468.
- [Mul15] Greg Muller. ‘The existence of maximal green sequences is not invariant under mutation’. 2015. arXiv:1503.04675.
- [MS16] Greg Muller and David E. Speyer. ‘Cluster algebras of Grassmannians are locally acyclic’. In: *Proc. Amer. Math. Soc.* 144.8 (2016), pp. 3267–3281. doi:10.1090/proc/13023. arXiv:1401.5137.

- [MSW11] Gregg Musiker, Ralf Schiffler and Lauren Williams. ‘Positivity for cluster algebras from surfaces’. In: *Adv. Math.* 227.6 (2011), pp. 2241–2308.  
doi:10.1016/j.aim.2011.04.018.  
arXiv:0906.0748.
- [Sev07] Ahmet I. Seven. ‘Recognizing cluster algebras of finite type’. In: *Electron. J. Combin.* 14.1 (2007), Research Paper 3, 35 pp. (electronic).  
www.combinatorics.org/ojs/index.php/eljc/article/view/v14i1r3.  
arXiv:math/0406545.
- [Sev11] Ahmet I. Seven. ‘Cluster algebras and semipositive symmetrizable matrices’. In: *Trans. Amer. Math. Soc.* 363.5 (2011), pp. 2733–2762.  
doi:10.1090/S0002-9947-2010-05255-9.  
arXiv:0804.1456.
- [Sev14] Ahmet I. Seven. ‘Maximal green sequences of skew-symmetrizable  $3 \times 3$  matrices’. In: *Linear Algebra Appl.* 440 (2014), pp. 125–130.  
doi:10.1016/j.laa.2013.10.018.  
arXiv:1207.6265.
- [Sev15] Ahmet I. Seven. ‘Cluster algebras and symmetric matrices’. In: *Proc. Amer. Math. Soc.* 143.2 (2015), pp. 469–478.  
doi:10.1090/S0002-9939-2014-12252-0.  
arXiv:1201.4270.
- [Vin85] È. B. Vinberg. ‘Hyperbolic groups of reflections (Russian)’. In: *Uspekhi Mat. Nauk* 40.1 (1985). English translation in: *Russ. Math. Surv.*, 40(1):31–75, 1985, pp. 29–66.  
doi:10.1070/RM1985v040n01ABEH003527.
- [Vin93] È. B. Vinberg. *Geometry II: Spaces of constant curvature*. Vol. 29. Encyclopaedia of Mathematical Sciences. A translation of Geometriya

II, Akad. Nauk SSSR, Vsesoyuz. Inst. Nauchn. i Tekhn. Inform., Moscow, 1988. Translation by V. V. Minakhin. Translation edited by È. B. Vinberg. Springer-Verlag, Berlin, 1993, pp. viii+254.

doi:10.1007/978-3-662-02901-5.

[Wil14] Lauren K. Williams. ‘Cluster algebras: an introduction’. In: *Bull. Amer. Math. Soc. (N.S.)* 51.1 (2014), pp. 1–26.

doi:10.1090/S0273-0979-2013-01417-4.

arXiv:1212.6263.